

RF Test Report

Applicant : Phorus Inc.
Product Type : Phorus Play-Fi Module
Trade Name : phorus
Model Number : CAPRICA2XL
Applicable Standard : FCC 47 CFR PART 15 SUBPART C
ANSI C63.10:2013
Receive Date : Jun. 08, 2017
Test Period : Jul. 04 ~ Jul. 27, 2017
Issue Date : Aug. 18, 2017

Issue by

A Test Lab Techno Corp.
No. 140-1, Changan Street, Bade District,
Taoyuan City 33465, Taiwan (R.O.C)
Tel : +886-3-2710188 / Fax : +886-3-2710190



Taiwan Accreditation Foundation accreditation number: 1330

Test Firm MRA designation number: TW0010

Note: This report shall not be reproduced except in full, without the written approval of A Test Lab Techno Corp. This document may be altered or revised by A Test Lab Techno Corp. personnel only, and shall be noted in the revision section of the document. The client should not use it to claim product endorsement by TAF, or any government agencies. The test results in the report only apply to the tested sample.



Revision History

Rev.	Issue Date	Revisions	Revised By
00	Aug. 07, 2017	Initial Issue	Janet Chao
01	Aug. 18, 2017	Revised report information.	Nina Lin

Verification of Compliance

Issued Date: Aug. 18, 2017

Applicant : Phorus Inc.
Product Type : Phorus Play-Fi Module
Trade Name : phorus
Model Number : CAPRICA2XL
FCC ID : 2AAWQ-CAPRICA2XL
EUT Rated Voltage : DC 5V / DC 3.3V / DC 1.8V / DC 1.1V
Test Voltage : DC 5V
Applicable Standard : FCC 47 CFR PART 15 SUBPART C
ANSI C63.10:2013

Test Result : Complied

Performing Lab. : A Test Lab Techno Corp.

No. 140-1, Changan Street, Bade District,
Taoyuan City 33465, Taiwan (R.O.C)
Tel : +886-3-2710188 / Fax : +886-3-2710190



Taiwan Accreditation Foundation accreditation number: 1330

<http://www.atl-lab.com.tw/e-index.htm>

A Test Lab Techno Corp. tested the above equipment in accordance with the requirements set forth in the above standards. All indications of Pass/Fail in this report are opinions expressed by A Test Lab Techno Corp. based on interpretations and/or observations of test results. Measurement Uncertainties were not taken into account and are published for informational purposes only. The test results show that the equipment tested is capable of demonstrating compliance with the requirements as documented in this report.

Approved By : Fly Lu Reviewed By : Eric Ou Yang
(Manager) (Fly Lu) (Testing Engineer) (Eric Ou Yang)



TABLE OF CONTENTS

1	General Information	6
2	EUT Description	7
3	Test Methodology	8
3.1.	Mode of Operation	8
3.2.	EUT Exercise Software	12
3.3.	Configuration of Test System Details	13
3.4.	Test Site Environment	13
4	Radiated Emission Measurement	14
4.1.	Limit	14
4.2.	Test Instruments	14
4.3.	Setup	15
4.4.	Test Procedure	17
4.5.	Test Result	19
5	Maximum Conducted Output Power Measurement	121
5.1.	Limit	121
5.2.	Test Setup	121
5.3.	Test Instruments	121
5.4.	Test Procedure	121
5.5.	Test Result	122
6	6dB RF Bandwidth Measurement	124
6.1.	Limit	124
6.2.	Test Setup	124
6.3.	Test Instruments	124
6.4.	Test Procedure	124
6.5.	Test Result	125
6.6.	Test Graphs	126
7	Maximum Power Density Measurement	130
7.1.	Limit	130
7.2.	Test Setup	130
7.3.	Test Instruments	130
7.4.	Test Procedure	130
7.5.	Test Result	131
7.6.	Test Graphs	132



8	Out of Band Conducted Emissions Measurement.....	136
8.1.	Limit	136
8.2.	Test Setup	136
8.3.	Test Instruments	136
8.4.	Test Procedure	136
8.5.	Test Graphs	137
9	Antenna Measurement.....	149
9.1.	Limit	149
9.2.	Antenna Description	149



1 General Information

1.1 Summary of Test Result

Standard	Item	Result	Remark
15.247			
15.207	AC Power Conducted Emission	N/A	Not applicable, This device use DC power source.
Standard	Item	Result	Remark
15.247			
15.247(d)	Transmitter Radiated Emissions	PASS	-----
15.247(b)(3)	Max. Output Power	PASS	-----
15.247(a)(2)	6dB RF Bandwidth	PASS	-----
15.247(e)	Power Spectral Density	PASS	-----
15.247(d)	Out of Band Conducted Spurious Emission	PASS	-----
15.203	Antenna Requirement	PASS	-----

The test results of this report relate only to the tested sample(s) identified in this report. Manufacturer or whom it may concern should recognize the pass or fail of the test result.

1.2 Measurement Uncertainty

Test Item	Frequency Range	Uncertainty (dB)
Conducted Emission	9kHz ~ 150KHz	2.7
	150kHz ~ 30MHz	2.7
Radiated Emission	9kHz ~ 30MHz	1.7
	30MHz ~ 1000MHz	5.7
	1000MHz ~ 18000MHz	5.5
	18000MHz ~ 26500MHz	4.8
	26500MHz ~ 40000MHz	4.8
Conducted Output Power	+0.27 dB / -0.28 dB	
RF Bandwidth	4.96%	
Power Spectral Density	+0.71 dB / -0.77 dB	



2 EUT Description

Applicant	Phorus Inc. 16255 Ventura Boulevard, Encino, California, 91436, United States			
Manufacturer	Phorus, Inc. 16255 Ventura Boulevard, Suite 310, Encino, United States, 91436			
Product Type	Phorus Play-Fi Module			
Trade Name	phorus			
Model Number	CAPRICA2XL			
FCC ID	2AAWQ-CAPRICA2XL			
Operate Freq. Band	Frequency Range (MHz)	Modulation	Channel Bandwidth	Data Rate 400 GI (ns)
IEEE 802.11b	2412 ~ 2462	DSSS	20MHz	Up to 11Mbps
IEEE 802.11g	2412 ~ 2462	OFDM	20MHz	Up to 54Mbps
IEEE 802.11n 2.4GHz 20MHz	2412 ~ 2462	OFDM	20MHz	Up to 72.2Mbps
IEEE 802.11n 2.4GHz 40MHz	2422 ~ 2452	OFDM	40MHz	Up to 150Mbps
Antenna information	Antenna	Model	Type	Max. Gain (dBi)
	ANT-0	MSA-3310-25GC4-A25	PIFA Antenna	4.80
	ANT-1	MSA-3310-25GC4-A26	PIFA Antenna	4.80
	ANT-0/ANT-1	EDA-1713-25GC1-A14	Dipole Antenna	5.17
Antenna Delivery	See section 3.1			

Frequency Band	Max. RF Output Power (W)
IEEE 802.11b	0.037
IEEE 802.11g	0.030
IEEE 802.11n 2.4GHz 20MHz	0.024
IEEE 802.11n 2.4GHz 40MHz	0.017

Keypart list :

Description	Manufacturer	Part Number	Remarks
Flash memory(1)	TOSHIBA	TC58NVG1S3 ETA00	Flash, 256MB, 2Gb
Flash memory(2)	WINBOND	W29N02GVSIAA	Flash, 256MB, 2Gb
Flash memory(3)	ESMT	F59L2G81LA	Flash, 256MB, 2Gb

A

3 Test Methodology

3.1. Mode of Operation

Decision of Test ATL has verified the construction and function in typical operation. All the test modes were carried out with the EUT in normal operation, which was shown in this test report and defined as:

Test Mode
Mode 1: Transmit mode
Mode 2: IEEE 802.11b Continuous TX mode
Mode 3: IEEE 802.11g Continuous TX mode
Mode 4: IEEE 802.11n 2.4GHz 20MHz Continuous TX mode
Mode 5: IEEE 802.11n 2.4GHz 40MHz Continuous TX mode

Software used to control the EUT for staying in continuous transmitting mode was programmed.

After verification, all tests were carried out with the worst case test modes as shown below except radiated spurious emission below 1GHz and power line conducted emissions below 30MHz, which worst case was in TX mode only.

By preliminary testing and verifying three axis (X, Y and Z) position of EUT transmitted status, it was found that "X axis" position was the worst, then the final test was executed the worst condition and test data were recorded in this report.

Note: Ant 0 power is greater than Ant 1 power, so the conducted test item evaluates only Ant 0.

Test Mode	Antenna Delivery	Data Rate	Test Channel
Mode 2	1TX / 1RX (Diversity)	1M	1, 6, 11
Mode 3	1TX / 1RX (Diversity)	6M	1, 6, 11
Mode 4	1TX / 1RX (Diversity)	6.5M	1, 6, 11
Mode 5	1TX / 1RX (Diversity)	13.5M	3, 6, 9

Test Mode	ANT-0	ANT-1
Mode 2	V	V
Mode 3	V	V
Mode 4	V	V
Mode 5	V	V

Duty cycle

Test Mode	Frequency (MHz)	on time (ms)	on+off time (ms)	Duty cycle	Duty Factor (dB)	1/T Minimum VBW (kHz)
Mode 2	2412	8.660	8.680	0.998	0.010	0.010
Mode 3	2412	1.450	1.490	0.973	0.118	0.690
Mode 4	2412	1.355	1.400	0.968	0.142	0.738
Mode 5	2422	0.672	0.723	0.929	0.318	1.488



Duty Cycle Graphs

Mode 2: IEEE 802.11b Continuous TX mode

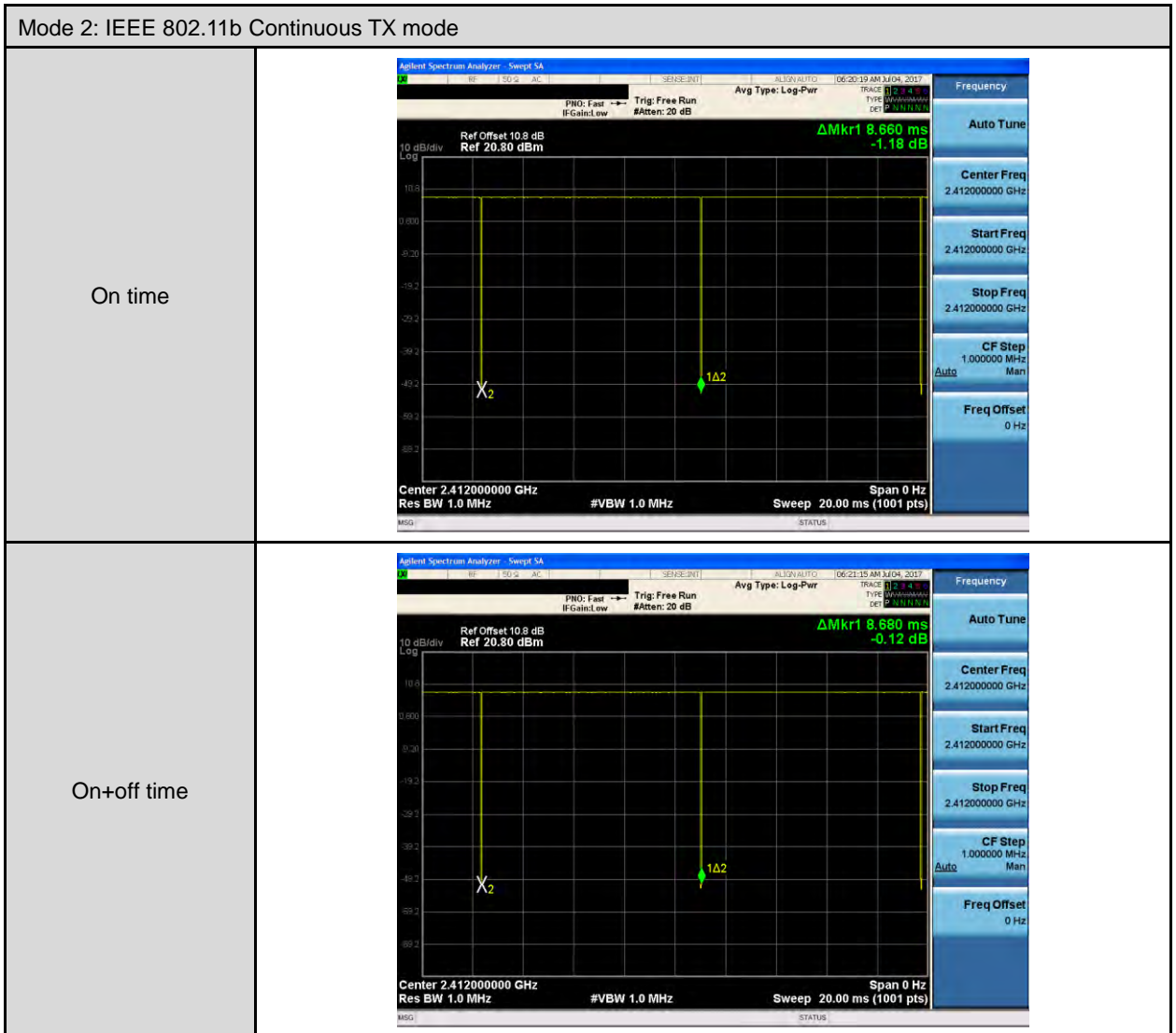



Mode 3: IEEE 802.11g Mode

On time

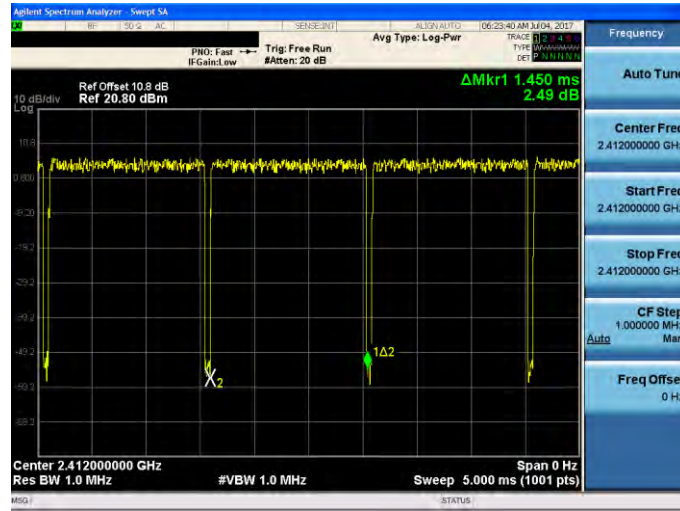

On+off time

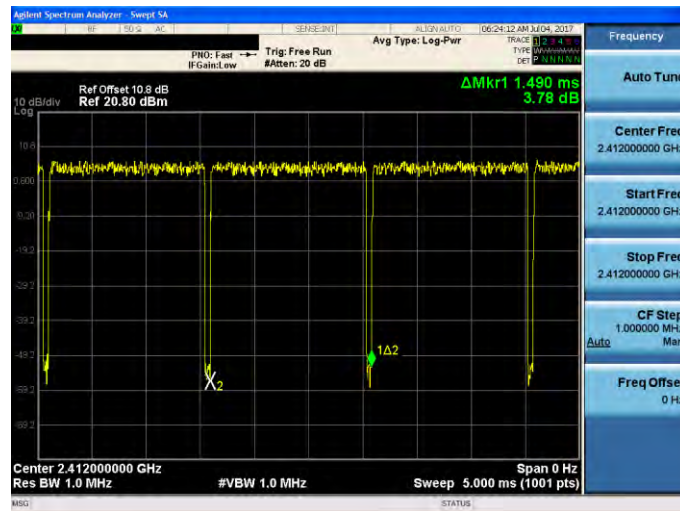



Mode 4: IEEE 802.11n 2.4GHz 20MHz Mode

On time

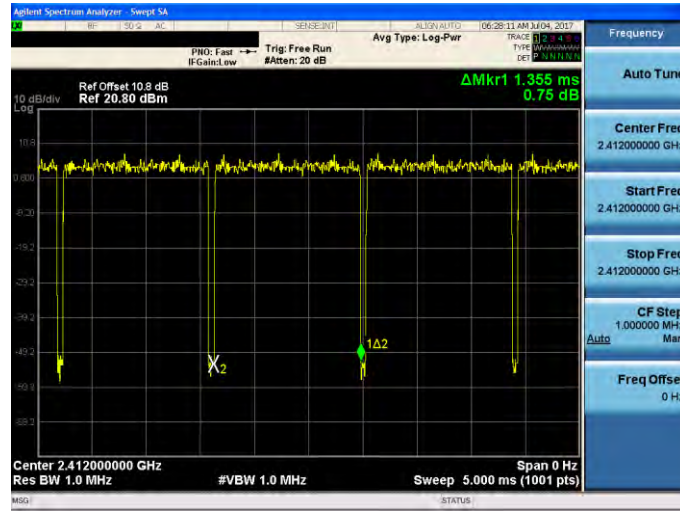

On+off time

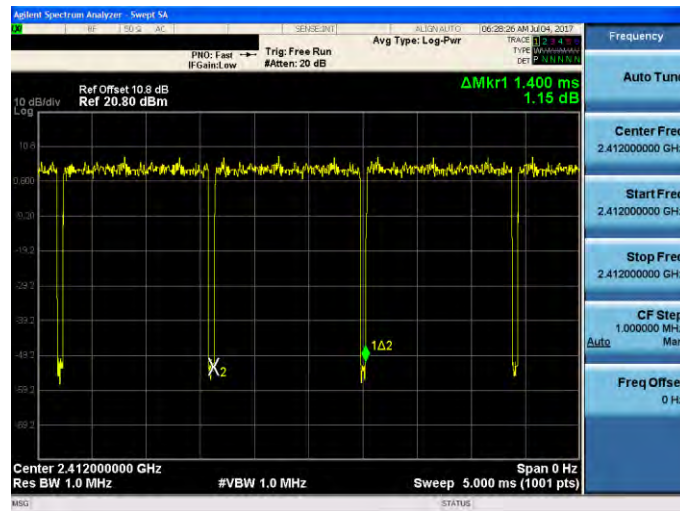

Mode 5: IEEE 802.11n 2.4GHz 40MHz Mode	
On time	
On+off time	

3.2. EUT Exercise Software

1.	Setup the EUT shown on 3.3.
2.	Turn on the power of all equipment.
3.	Turn Wi-Fi function link to AP
4.	EUT run test program.

Measurement Software	
1	EZ-EMC Ver. ATL-03A1-1
2	EZ-EMC Ver ATL-ITC-3A1-1

3.3. Configuration of Test System Details

Radiated Emission

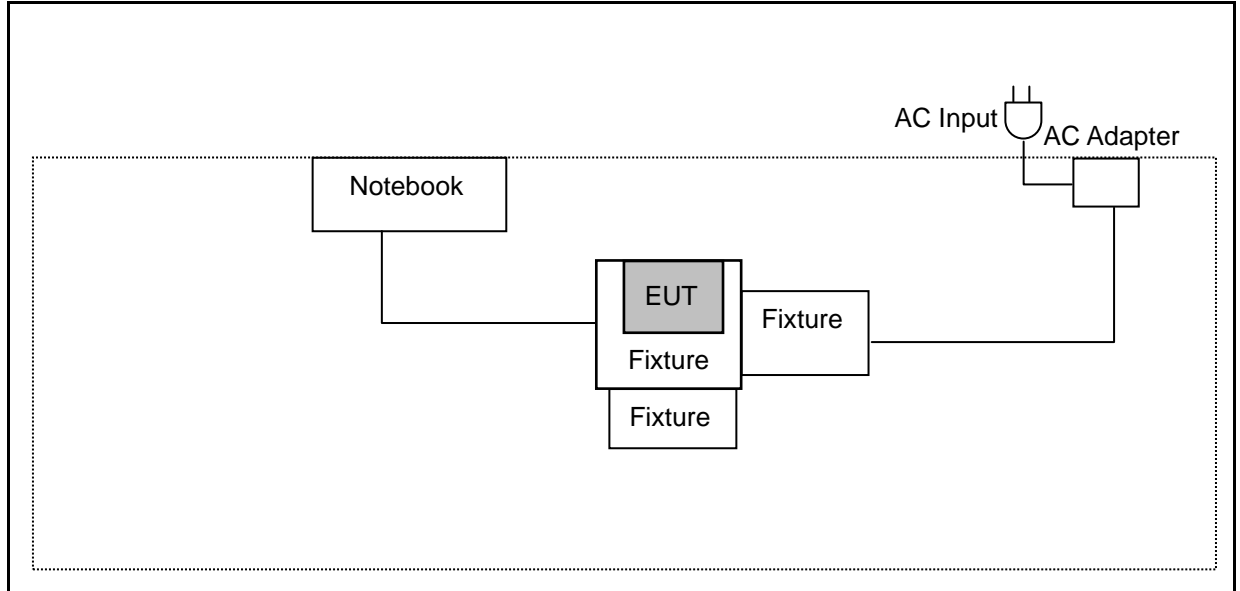

3.4. Test Site Environment

Items	Required (IEC 60068-1)	Actual
Temperature (°C)	15-35	26
Humidity (%RH)	25-75	60
Barometric pressure (mbar)	860-1060	950



4 Radiated Emission Measurement

4.1. Limit

According to §15.209(a), except as provided elsewhere in this subpart, the emissions from an intentional radiator shall not exceed the field strength levels specified in the following table:

Frequency (MHz)	Field Strength (μV/m at meter)	Measurement Distance (meters)
0.009 – 0.490	2400 / F (kHz)	300
0.490 – 1.705	24000 / F (kHz)	30
1.705 – 30.0	30	30
30 - 88	100**	3
88-216	150**	3
216-960	200**	3
Above 960	500	3

** Except as provided in paragraph (g), fundamental emissions from intentional radiators operating under this Section shall not be located in the frequency bands 54-72 MHz, 76-88 MHz, 174-216 MHz or 470-806 MHz. However, operation within these frequency bands is permitted under other sections of this Part, e.g., Sections 15.231 and 15.241.

4.2. Test Instruments

3 Meter Chamber					
Equipment	Manufacturer	Model Number	Serial Number	Cal. Date	Cal. Period
RF Pre-selector	Agilent	N9039A	MY46520256	04/24/2017	1 year
Spectrum Analyzer	Agilent	E4446A	MY46180578	04/24/2017	1 year
Pre Amplifier	Agilent	8449B	3008A02237	10/11/2016	1 year
Pre Amplifier	Agilent	8447D	2944A11119	01/12/2017	1 year
Broadband Antenna	Schwarzbeck	VULB9168	416	10/13/2016	1 year
Horn Antenna (1~18GHz)	SCHWARZBECK MESS-ELEKTRONIK	BBHA9120D	9120D-550	06/20/2017	1 year
Horn Antenna (18~40GHz)	ETS	3116	86467	09/05/2016	1 year
Loop Antenna	COM-POWER CORPORATION	AL-130	121014	01/26/2017	1 year
Microwave Cable	EMCI	EMC102-KM-KM-14000	151001	02/20/2017	1 year
Microwave Cable	EMCI	EMC-104-SM-SM-14000	140202	02/20/2017	1 year
Microwave Cable	EMCI	EMC104-SM-SM-600	140301	02/20/2017	1 year
Test Site	ATL	TE01	888001	08/29/2016	1 year

Note: N.C.R. = No Calibration Request.

4.3. Setup

9kHz ~ 30MHz

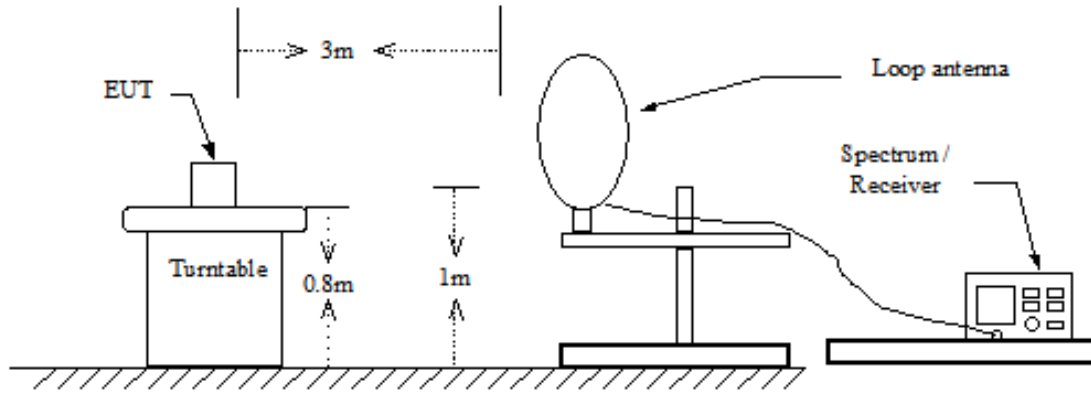

Below 1GHz

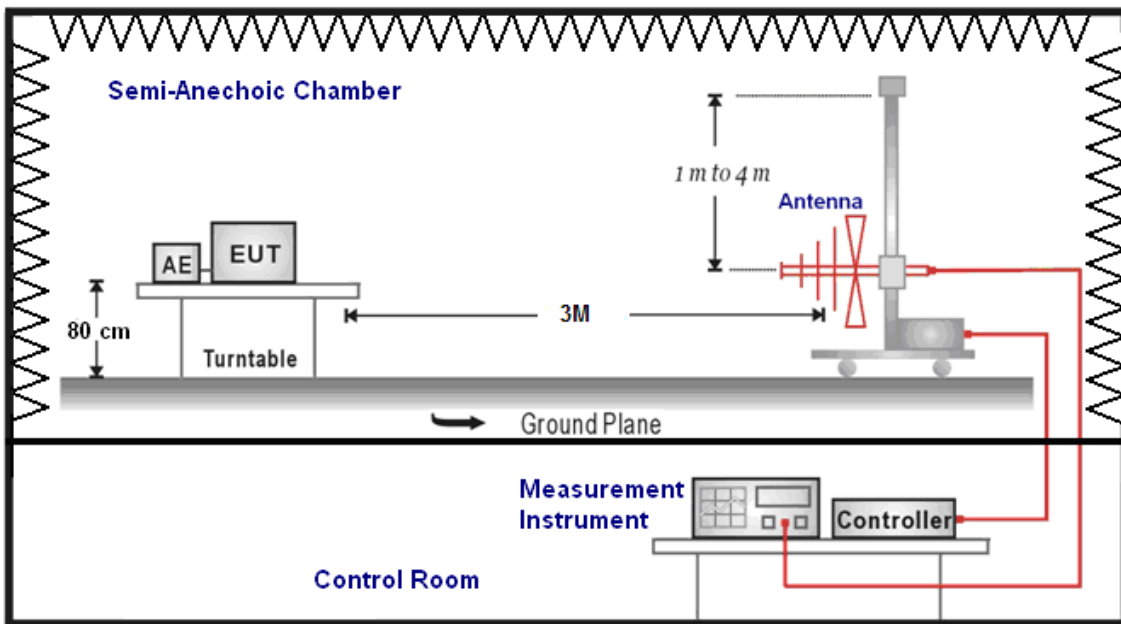

Above 1GHz

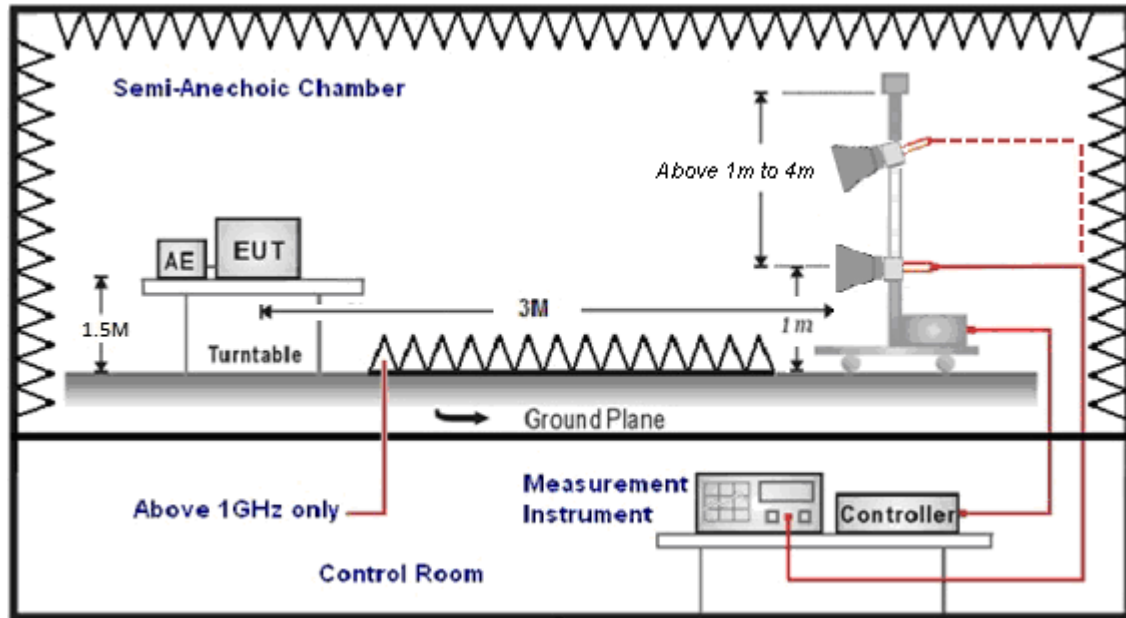



4.4. Test Procedure

Final radiation measurements were made on a three-meter, Semi Anechoic Chamber. The EUT system was placed on a nonconductive turntable which is 0.8 or 1.5 meters height (below 1GHz use 0.8m turntable / above 1GHz use 1.5m turntable), top surface 1.0 x 1.5 meter. The spectrum was examined from 250 MHz to 2.5 GHz in order to cover the whole spectrum below 10th harmonic which could generate from the EUT. During the test, EUT was set to transmit continuously & Measurements spectrum range from 9 kHz to 26.5 GHz is investigated.

For measurements below 1 GHz the resolution bandwidth is set to 100 kHz for peak detection measurements or 120 kHz for quasi-peak detection measurements. Peak detection is used unless otherwise noted as quasi-peak.

For measurements above 1 GHz the resolution bandwidth is set to 1 MHz, and then the video bandwidth is set to 1 MHz for peak measurements and 10 Hz for average measurements when Duty cycle >0.98 / $1/T$ for average measurements when Duty cycle <0.98 . A nonconductive material surrounded the EUT to supporting the EUT for standing on three orthogonal planes. At each condition, the EUT was rotated 360 degrees, and the antenna was raised and lowered from one to four meters to find the maximum emission levels. Measurements were taken using both horizontal and vertical antenna polarization.

SCHWARZBECK MESS-ELEKTRONIK Biconilog Antenna at 3 Meter and the SCHWARZBECK Double Ridged Guide Antenna was used in frequencies 1 –26.5 GHz at a distance of 3 meter. The antenna at an angle toward the source of the emission. All test results were extrapolated to equivalent signal at 3 meters utilizing an inverse linear distance extrapolation Factor (20dB/decade).

For testing above 1GHz, the emission level of the EUT in peak mode was 20dB lower than average limit (that means the emission level in peak mode also complies with the limit in average mode), then testing will be stopped and peak values of EUT will be reported, otherwise, the emissions will be measured in average mode again and reported.

Appropriate preamplifiers were used for improving sensitivity and precautions were taken to avoid overloading or desensitizing the spectrum analyzer. No post – detector video filters were used in the test.

The spectrum analyzer's 6 dB bandwidth was set to 1 MHz, and the analyzer was operated in the peak detection mode, for frequencies both below and up 1 GHz. The average levels were obtained by subtracting the duty cycle correction factor from the peak readings.

The following procedures were used to convert the emission levels measured in decibels referenced to 1 microvolt (dBuV) into field intensity in micro volts pre meter (uV/m).

The actual field intensity in decibels referenced to 1 microvolt in to field intensity in micro volts per meter (dBuV/m).



The actual field intensity in referenced to 1 microvolt per meter (dBuV/m) is determined by algebraically adding the measured reading in dBuV, the antenna factor (dB), and cable loss (dB) and Subtracting the gain of preamplifier (dB) is auto calculate in spectrum analyzer.

(1) $\text{Amplitude (dBuV/m)} = \text{FI (dBuV)} + \text{AF (dBuV)} + \text{CL (dBuV)} - \text{Gain (dB)}$

FI= Reading of the field intensity.

AF= Antenna factor.

CL= Cable loss.

P.S Amplitude is auto calculate in spectrum analyzer.

(2) $\text{Actual Amplitude (dBuV/m)} = \text{Amplitude (dBuV)} - \text{Dis(dB)}$

The FCC specified emission limits were calculated according the EUT operating frequency and by following linear interpolation equations:

(a) For fundamental frequency : Transmitter Output < +30dBm

(b) For spurious frequency : Spurious emission limits = fundamental emission limit /10

Data of measurement within this frequency range without mark in the table above means the reading of emissions are attenuated more than 20dB below the permissible limits or the field strength is too small to be measured.



4.5. Test Result

Below 1GHz

Standard:	FCC Part 15.247	Test Distance:	3m				
Test item:	Harmonic	Power:	DC 5V				
Test Mode:	Mode 1	Temp.(°C)/Hum.(%RH):	26(°C)/60%RH				
		Date:	07/17/2017				
Description:	Antenna Model : MSA-3310-25GC4-A25 /MSA-3310-25GC4-A26						
Frequency (MHz)	Reading (dBuV)	Correct Factor (dB/m)	Result (dBuV/m)	Limit (dBuV/m)	Margin (dB)	Remark	Ant.Polar. H / V
319.0600	36.20	-2.39	33.81	46.00	-12.19	QP	H
466.5000	41.12	0.53	41.65	46.00	-4.35	QP	H
687.6600	34.76	4.79	39.55	46.00	-6.45	QP	H
712.8800	34.76	5.33	40.09	46.00	-5.91	QP	H
761.3800	35.87	6.38	42.25	46.00	-3.75	QP	H
786.6000	33.44	6.75	40.19	46.00	-5.81	QP	H
288.0200	45.29	-3.04	42.25	46.00	-3.75	QP	V
335.5500	44.02	-2.10	41.92	46.00	-4.08	QP	V
431.5800	39.36	-0.16	39.20	46.00	-6.80	QP	V
466.5000	39.16	0.53	39.69	46.00	-6.31	QP	V
663.4100	32.86	4.32	37.18	46.00	-8.82	QP	V
884.5700	29.07	8.70	37.77	46.00	-8.23	QP	V

- Note: 1. Result (dBuV/m) = Correct Factor (dB/m) + Reading(dBuV).
 2. Correction factor (dB/m) = Antenna Factor (dB/m) + Cable loss (dB) – Pre-Amplifier gain (dB).
 3. When the peak results are less than average limit, so not need to evaluate the average.



Standard:	FCC Part 15.247	Test Distance:	3m				
Test item:	Harmonic	Power:	DC 5V				
Test Mode:	Mode 1	Temp.(°C)/Hum.(%RH):	26(°C)/60%RH				
		Date:	07/17/2017				
Description:	Antenna Model : EDA-1713-25GC1-A14						
Frequency (MHz)	Reading (dBuV)	Correct Factor (dB/m)	Result (dBuV/m)	Limit (dBuV/m)	Margin (dB)	Remark	Ant.Polar. H / V
191.9900	46.68	-6.69	39.99	43.50	-3.51	QP	H
215.2700	47.36	-6.24	41.12	43.50	-2.38	QP	H
466.5000	41.83	0.53	42.36	46.00	-3.64	QP	H
737.1300	35.90	5.92	41.82	46.00	-4.18	QP	H
761.3800	37.83	6.38	44.21	46.00	-1.79	QP	H
786.6000	34.45	6.75	41.20	46.00	-4.80	QP	H
335.5500	41.25	-2.10	39.15	46.00	-6.85	QP	V
384.0500	41.94	-1.12	40.82	46.00	-5.18	QP	V
431.5800	41.88	-0.16	41.72	46.00	-4.28	QP	V
466.5000	38.88	0.53	39.41	46.00	-6.59	QP	V
687.6600	31.33	4.79	36.12	46.00	-9.88	QP	V
884.5700	29.82	8.70	38.52	46.00	-7.48	QP	V

- Note: 1. Result (dBuV/m) = Correct Factor (dB/m) + Reading(dBuV).
 2. Correction factor (dB/m) = Antenna Factor (dB/m) + Cable loss (dB) – Pre-Amplifier gain (dB).
 3. When the peak results are less than average limit, so not need to evaluate the average.



Above 1GHz

Standard:	FCC Part 15.247	Test Distance:	3m
Test item:	Harmonic	Power:	DC 5V
Frequency:	2412MHz	Temp.(°C)/Hum.(%RH):	26(°C)/60%RH
Mode:	Mode 2	Date:	07/19/2017
Ant.Polar.:	Horizontal		
Description:	Antenna Model : MSA-3310-25GC4-A25 / MSA-3310-25GC4-A26		

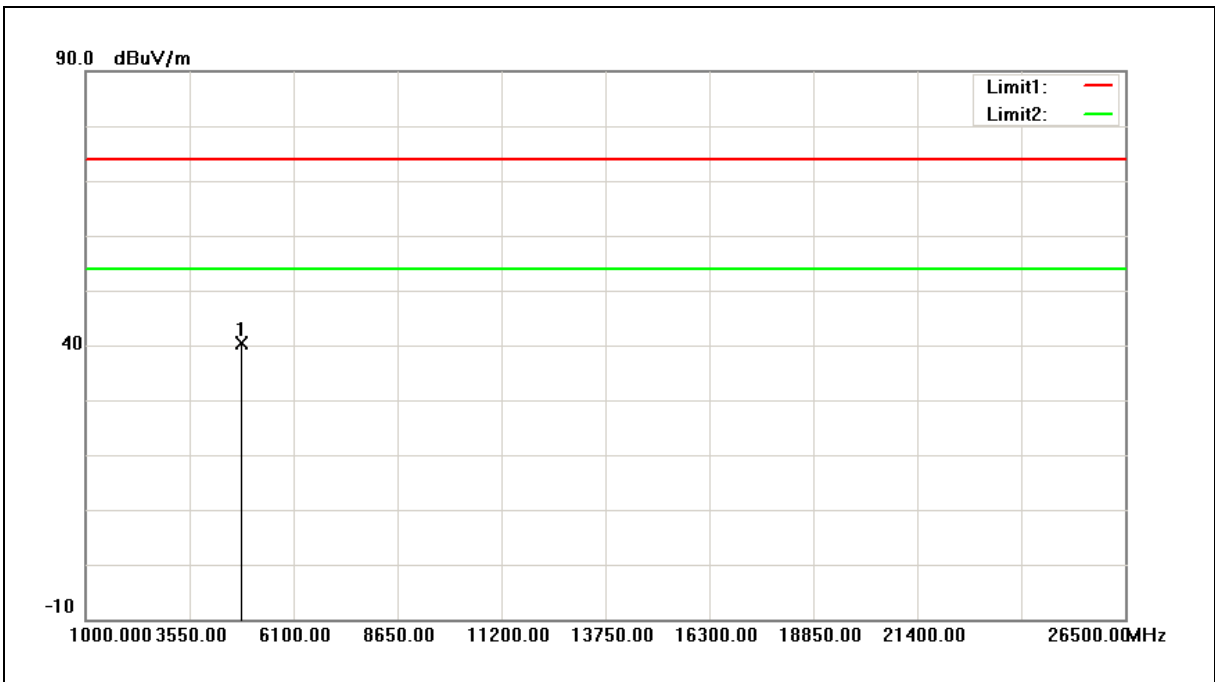

No.	Frequency (MHz)	Reading (dBuV)	Correct Factor (dB/m)	Result (dBuV/m)	Limit (dBuV/m)	Margin (dB)	Remark
1	4824.000	46.76	-6.44	40.32	74.00	-33.68	peak

- Note:1.Result (dBuV/m) = Correct Factor (dB/m) + Reading(dBuV).
 2.Correction factor (dB/m) = Antenna Factor (dB/m) + Cable loss (dB) – Pre-Amplifier gain (dB).
 3. When the peak results are less than average limit, so not need to evaluate the average.



Standard:	FCC Part 15.247	Test Distance:	3m
Test item:	Harmonic	Power:	DC 5V
Frequency:	2412MHz	Temp.(°C)/Hum.(%RH):	26(°C)/60%RH
Mode:	Mode 2	Date:	07/19/2017
Ant.Polar.:	Vertical		
Description:	Antenna Model : MSA-3310-25GC4-A25 / MSA-3310-25GC4-A26		

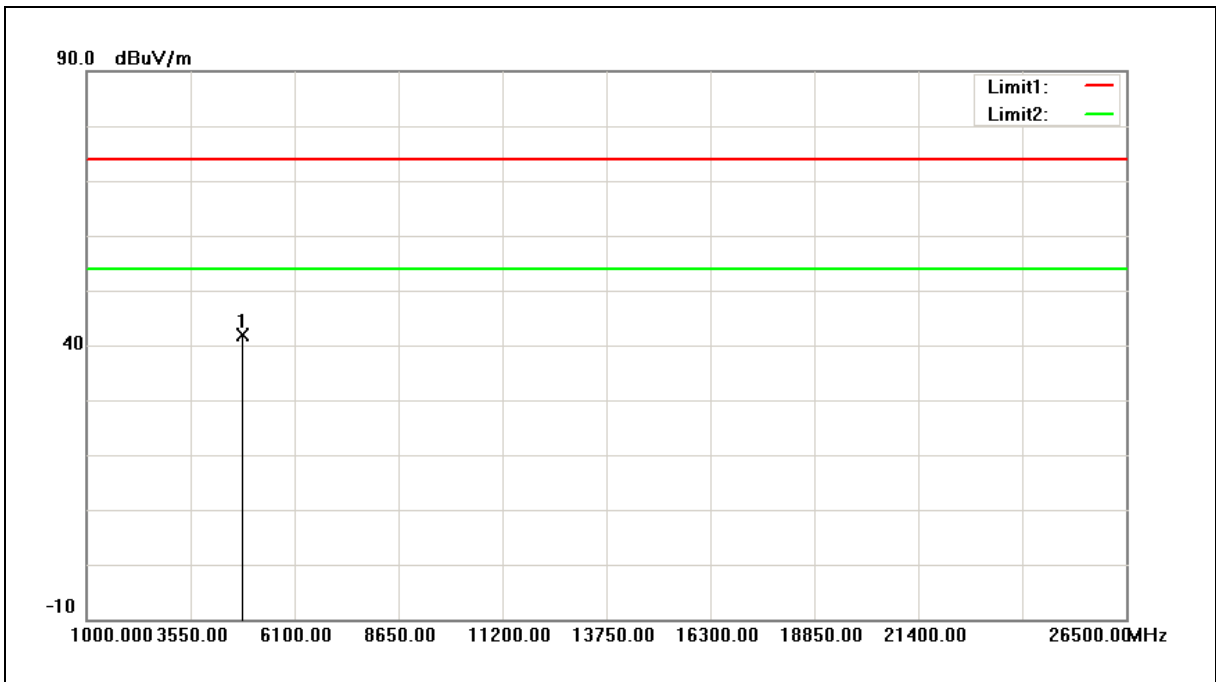

No.	Frequency (MHz)	Reading (dBuV)	Correct Factor (dB/m)	Result (dBuV/m)	Limit (dBuV/m)	Margin (dB)	Remark
1	4824.000	48.44	-6.44	42.00	74.00	-32.00	peak

Note:1.Result (dBuV/m) = Correct Factor (dB/m) + Reading(dBuV).

2.Correction factor (dB/m) = Antenna Factor (dB/m) + Cable loss (dB) – Pre-Amplifier gain (dB).

3. When the peak results are less than average limit, so not need to evaluate the average.



Standard:	FCC Part 15.247	Test Distance:	3m
Test item:	Harmonic	Power:	DC 5V
Frequency:	2437MHz	Temp.(°C)/Hum.(%RH):	26(°C)/60%RH
Mode:	Mode 2	Date:	07/19/2017
Ant.Polar.:	Horizontal		
Description:	Antenna Model : MSA-3310-25GC4-A25 / MSA-3310-25GC4-A26		

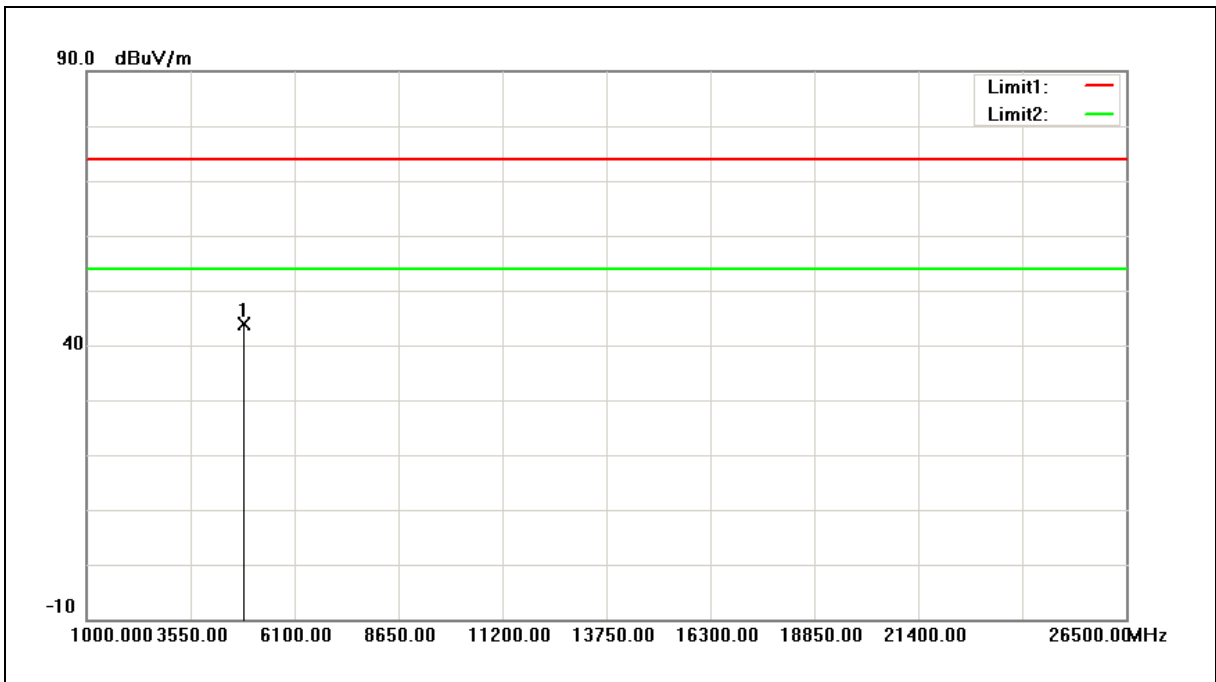

No.	Frequency (MHz)	Reading (dBuV)	Correct Factor (dB/m)	Result (dBuV/m)	Limit (dBuV/m)	Margin (dB)	Remark
1	4874.000	50.13	-6.26	43.87	74.00	-30.13	peak

Note:1.Result (dBuV/m) = Correct Factor (dB/m) + Reading(dBuV).

2.Correction factor (dB/m) = Antenna Factor (dB/m) + Cable loss (dB) – Pre-Amplifier gain (dB).

3. When the peak results are less than average limit, so not need to evaluate the average.



Standard:	FCC Part 15.247	Test Distance:	3m
Test item:	Harmonic	Power:	DC 5V
Frequency:	2437MHz	Temp.(°C)/Hum.(%RH):	26(°C)/60%RH
Mode:	Mode 2	Date:	07/19/2017
Ant.Polar.:	Vertical		
Description:	Antenna Model : MSA-3310-25GC4-A25 / MSA-3310-25GC4-A26		

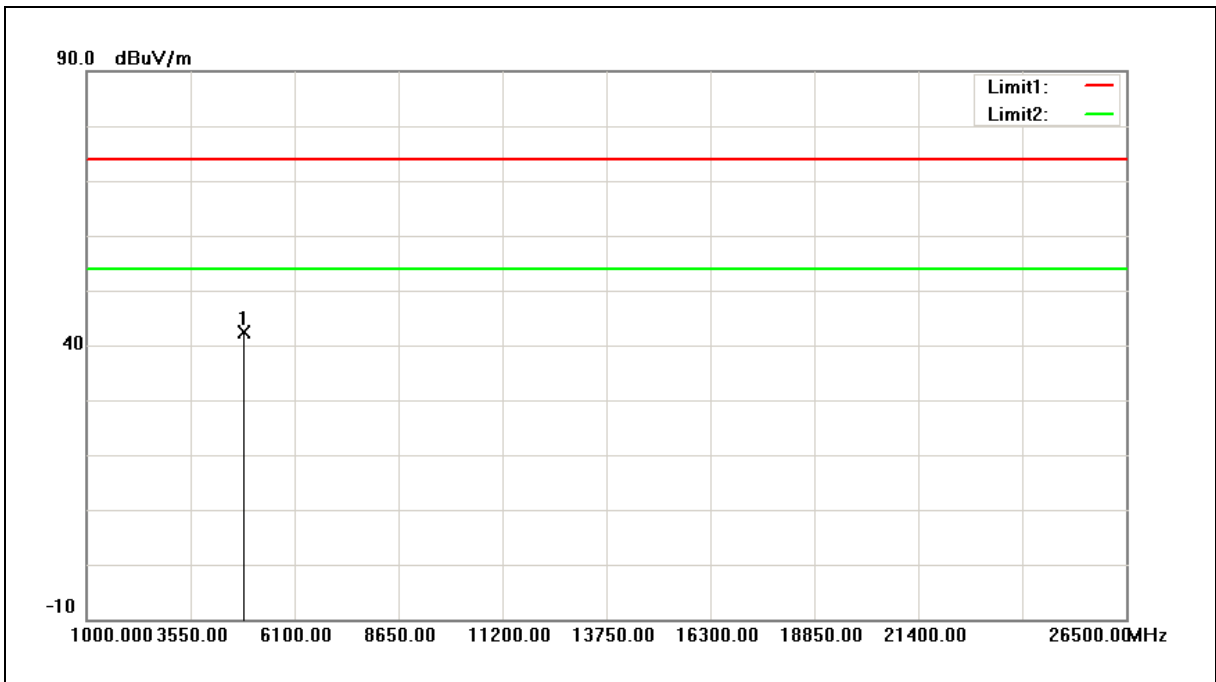

No.	Frequency (MHz)	Reading (dBuV)	Correct Factor (dB/m)	Result (dBuV/m)	Limit (dBuV/m)	Margin (dB)	Remark
1	4874.000	48.64	-6.26	42.38	74.00	-31.62	peak

Note:1.Result (dBuV/m) = Correct Factor (dB/m) + Reading(dBuV).

2.Correction factor (dB/m) = Antenna Factor (dB/m) + Cable loss (dB) – Pre-Amplifier gain (dB).

3. When the peak results are less than average limit, so not need to evaluate the average.



Standard:	FCC Part 15.247	Test Distance:	3m
Test item:	Harmonic	Power:	DC 5V
Frequency:	2462MHz	Temp.(°C)/Hum.(%RH):	26(°C)/60%RH
Mode:	Mode 2	Date:	07/19/2017
Ant.Polar.:	Horizontal		
Description:	Antenna Model : MSA-3310-25GC4-A25 / MSA-3310-25GC4-A26		

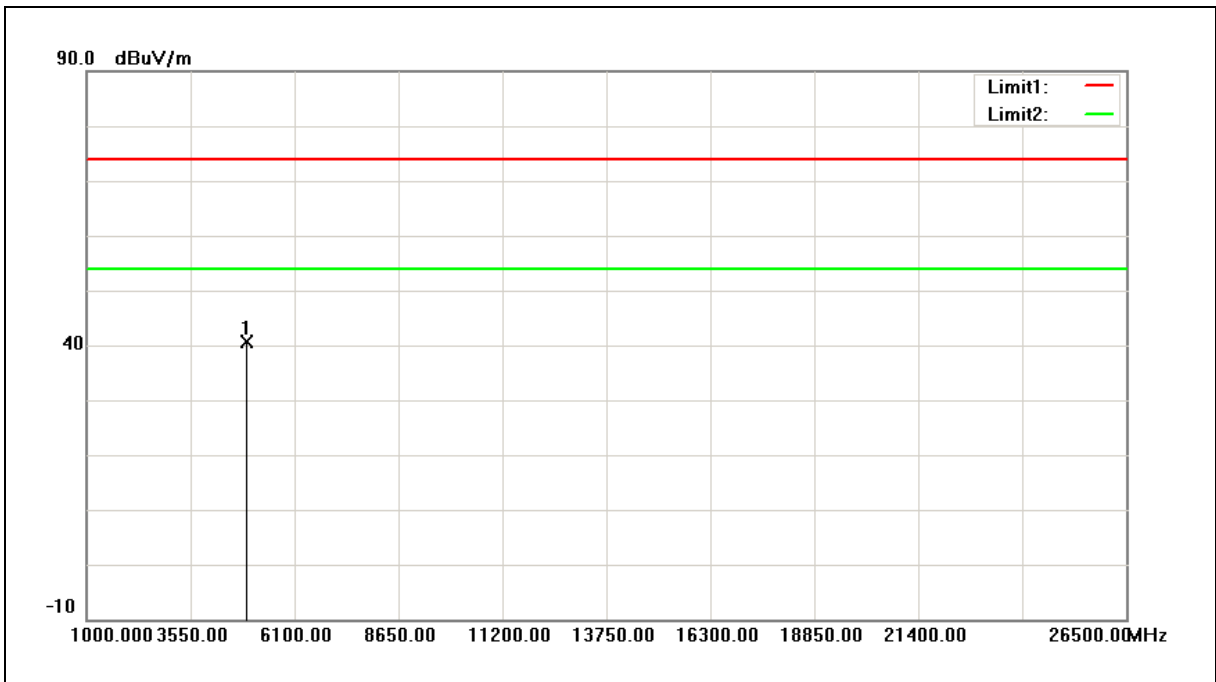

No.	Frequency (MHz)	Reading (dBuV)	Correct Factor (dB/m)	Result (dBuV/m)	Limit (dBuV/m)	Margin (dB)	Remark
1	4924.000	46.81	-6.08	40.73	74.00	-33.27	peak

Note:1.Result (dBuV/m) = Correct Factor (dB/m) + Reading(dBuV).

2.Correction factor (dB/m) = Antenna Factor (dB/m) + Cable loss (dB) – Pre-Amplifier gain (dB).

3. When the peak results are less than average limit, so not need to evaluate the average.



Standard:	FCC Part 15.247	Test Distance:	3m
Test item:	Harmonic	Power:	DC 5V
Frequency:	2462MHz	Temp.(°C)/Hum.(%RH):	26(°C)/60%RH
Mode:	Mode 2	Date:	07/19/2017
Ant.Polar.:	Vertical		
Description:	Antenna Model : MSA-3310-25GC4-A25 / MSA-3310-25GC4-A26		

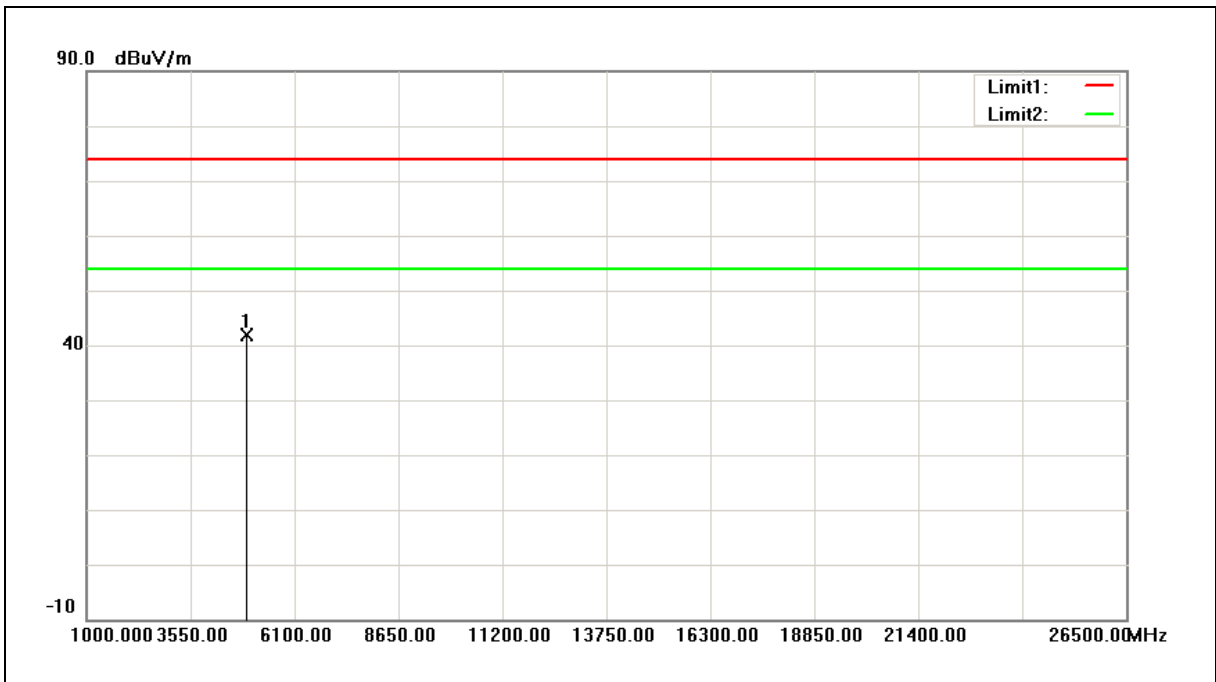

No.	Frequency (MHz)	Reading (dBuV)	Correct Factor (dB/m)	Result (dBuV/m)	Limit (dBuV/m)	Margin (dB)	Remark
1	4924.000	48.01	-6.08	41.93	74.00	-32.07	peak

Note:1.Result (dBuV/m) = Correct Factor (dB/m) + Reading(dBuV).

2.Correction factor (dB/m) = Antenna Factor (dB/m) + Cable loss (dB) – Pre-Amplifier gain (dB).

3. When the peak results are less than average limit, so not need to evaluate the average.



Standard:	FCC Part 15.247	Test Distance:	3m
Test item:	Harmonic	Power:	DC 5V
Frequency:	2412MHz	Temp.(°C)/Hum.(%RH):	26(°C)/60%RH
Mode:	Mode 3	Date:	07/19/2017
Ant.Polar.:	Horizontal		
Description:	Antenna Model : MSA-3310-25GC4-A25 / MSA-3310-25GC4-A26		

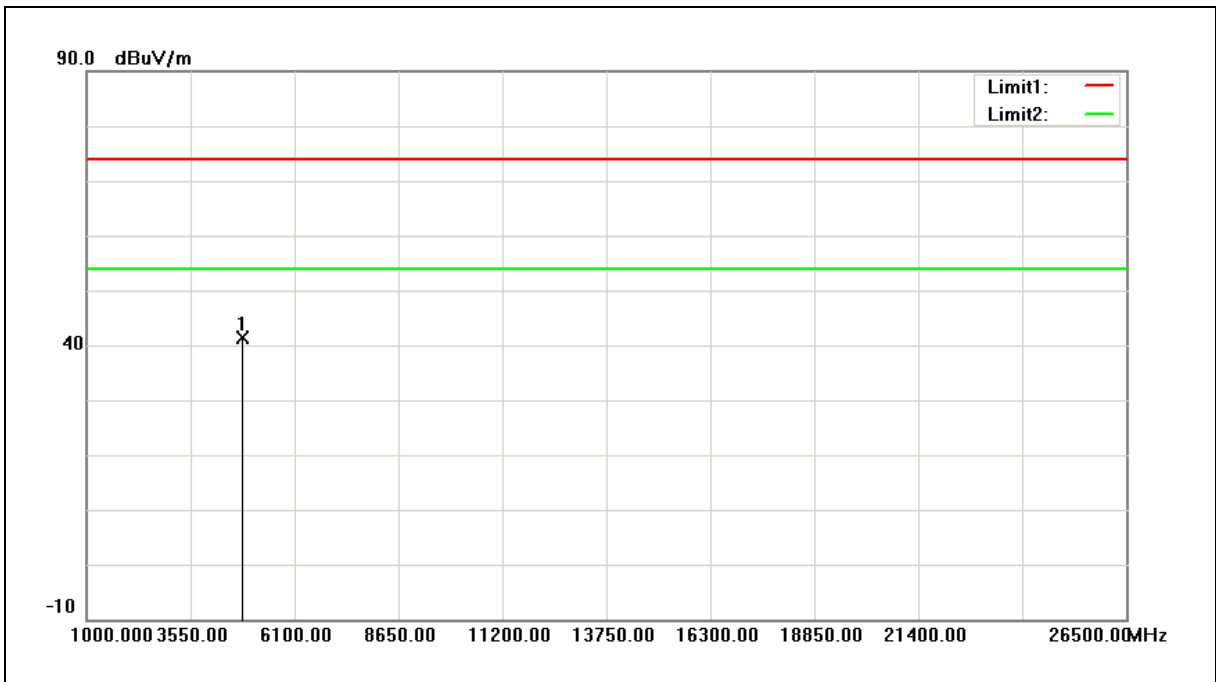

No.	Frequency (MHz)	Reading (dBuV)	Correct Factor (dB/m)	Result (dBuV/m)	Limit (dBuV/m)	Margin (dB)	Remark
1	4824.000	47.79	-6.44	41.35	74.00	-32.65	peak

Note:1.Result (dBuV/m) = Correct Factor (dB/m) + Reading(dBuV).

2.Correction factor (dB/m) = Antenna Factor (dB/m) + Cable loss (dB) – Pre-Amplifier gain (dB).

3. When the peak results are less than average limit, so not need to evaluate the average.



Standard:	FCC Part 15.247	Test Distance:	3m
Test item:	Harmonic	Power:	DC 5V
Frequency:	2412MHz	Temp.(°C)/Hum.(%RH):	26(°C)/60%RH
Mode:	Mode 3	Date:	07/19/2017
Ant.Polar.:	Vertical		
Description:	Antenna Model : MSA-3310-25GC4-A25 / MSA-3310-25GC4-A26		

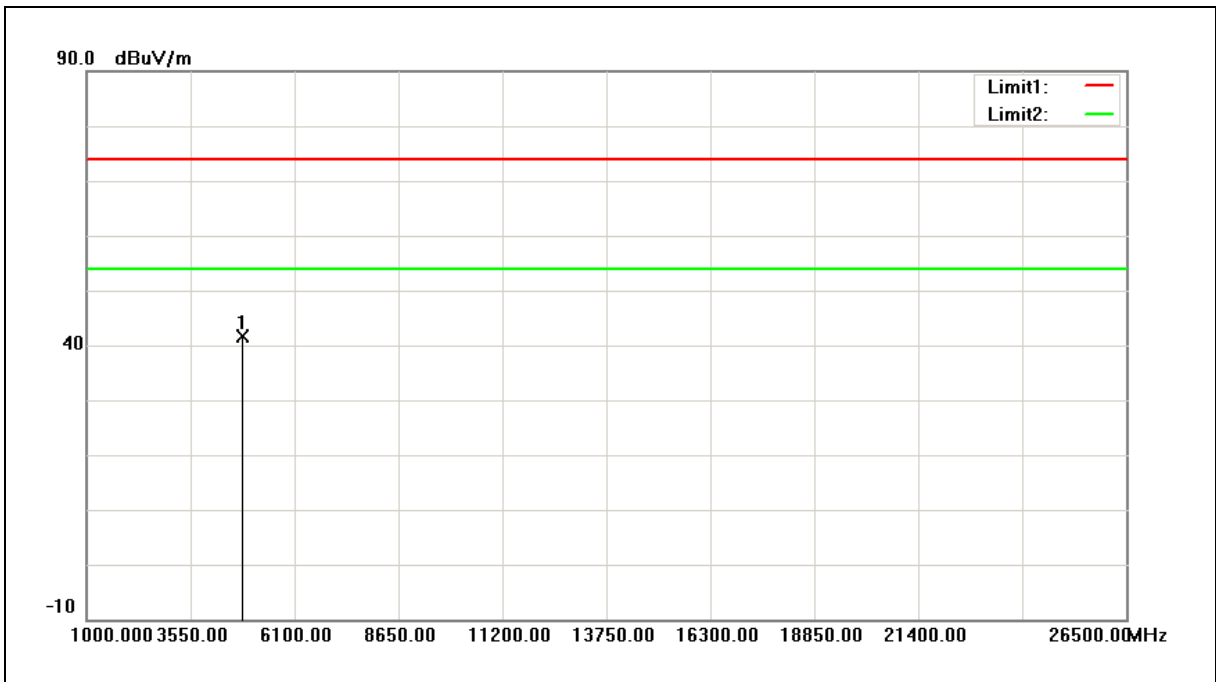

No.	Frequency (MHz)	Reading (dBuV)	Correct Factor (dB/m)	Result (dBuV/m)	Limit (dBuV/m)	Margin (dB)	Remark
1	4824.000	47.96	-6.44	41.52	74.00	-32.48	peak

- Note:1.Result (dBuV/m) = Correct Factor (dB/m) + Reading(dBuV).
 2.Correction factor (dB/m) = Antenna Factor (dB/m) + Cable loss (dB) – Pre-Amplifier gain (dB).
 3. When the peak results are less than average limit, so not need to evaluate the average.



Standard:	FCC Part 15.247	Test Distance:	3m
Test item:	Harmonic	Power:	DC 5V
Frequency:	2437MHz	Temp.(°C)/Hum.(%RH):	26(°C)/60%RH
Mode:	Mode 3	Date:	07/19/2017
Ant.Polar.:	Horizontal		
Description:	Antenna Model : MSA-3310-25GC4-A25 / MSA-3310-25GC4-A26		

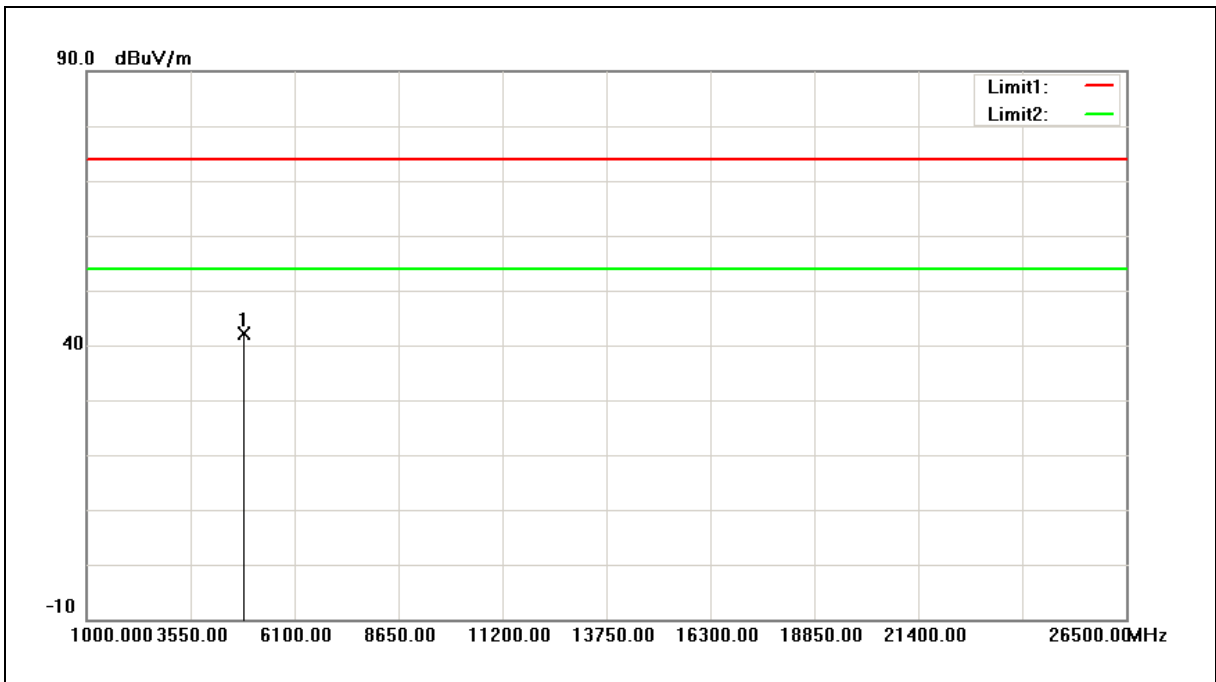

No.	Frequency (MHz)	Reading (dBuV)	Correct Factor (dB/m)	Result (dBuV/m)	Limit (dBuV/m)	Margin (dB)	Remark
1	4874.000	48.29	-6.26	42.03	74.00	-31.97	peak

- Note:1.Result (dBuV/m) = Correct Factor (dB/m) + Reading(dBuV).
- 2.Correction factor (dB/m) = Antenna Factor (dB/m) + Cable loss (dB) – Pre-Amplifier gain (dB).
3. When the peak results are less than average limit, so not need to evaluate the average.



Standard:	FCC Part 15.247	Test Distance:	3m
Test item:	Harmonic	Power:	DC 5V
Frequency:	2437MHz	Temp.(°C)/Hum.(%RH):	26(°C)/60%RH
Mode:	Mode 3	Date:	07/19/2017
Ant.Polar.:	Vertical		
Description:	Antenna Model : MSA-3310-25GC4-A25 / MSA-3310-25GC4-A26		

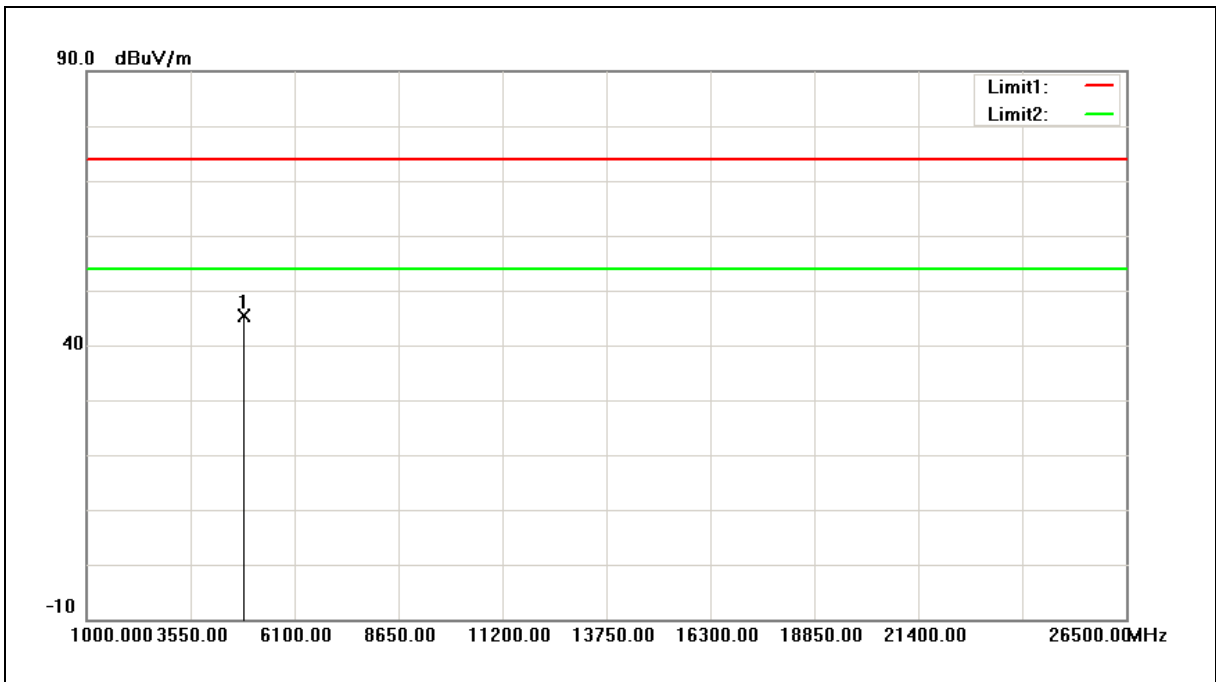

No.	Frequency (MHz)	Reading (dBuV)	Correct Factor (dB/m)	Result (dBuV/m)	Limit (dBuV/m)	Margin (dB)	Remark
1	4874.000	51.57	-6.26	45.31	74.00	-28.69	peak

- Note: 1. Result (dBuV/m) = Correct Factor (dB/m) + Reading(dBuV).
2. Correction factor (dB/m) = Antenna Factor (dB/m) + Cable loss (dB) – Pre-Amplifier gain (dB).
3. When the peak results are less than average limit, so not need to evaluate the average.



Standard:	FCC Part 15.247	Test Distance:	3m
Test item:	Harmonic	Power:	DC 5V
Frequency:	2462MHz	Temp.(°C)/Hum.(%RH):	26(°C)/60%RH
Mode:	Mode 3	Date:	07/19/2017
Ant.Polar.:	Horizontal		
Description:	Antenna Model : MSA-3310-25GC4-A25 / MSA-3310-25GC4-A26		

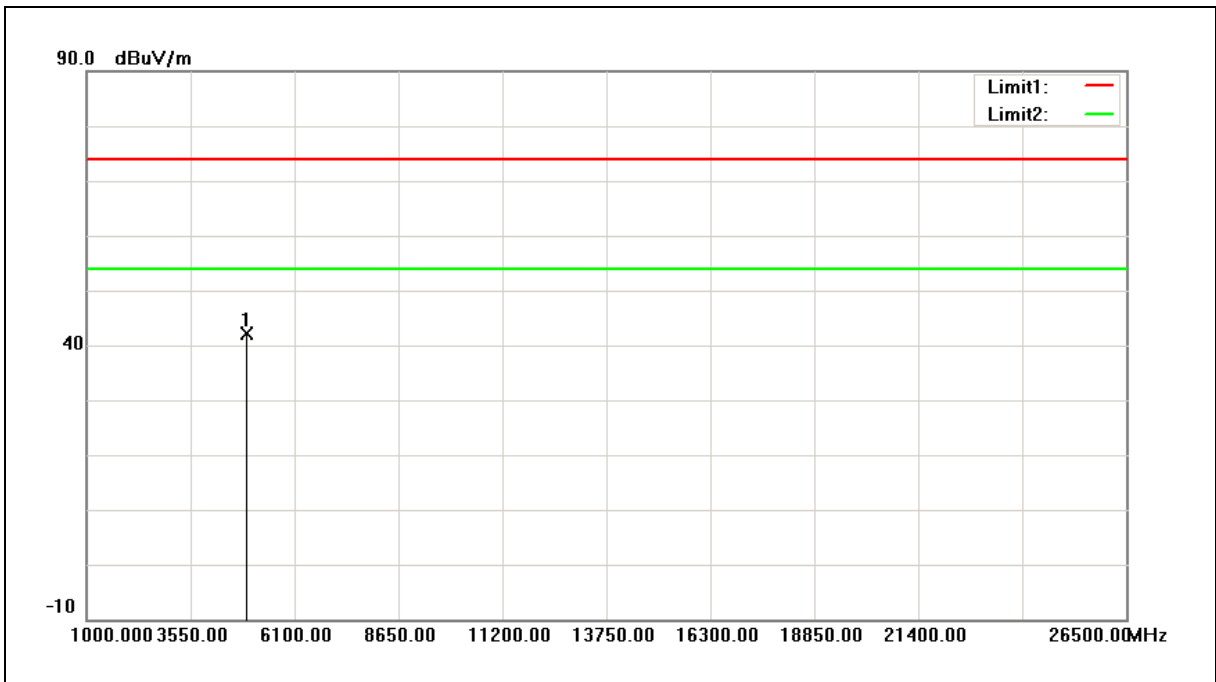

No.	Frequency (MHz)	Reading (dBuV)	Correct Factor (dB/m)	Result (dBuV/m)	Limit (dBuV/m)	Margin (dB)	Remark
1	4924.000	48.18	-6.08	42.10	74.00	-31.90	peak

- Note:1.Result (dBuV/m) = Correct Factor (dB/m) + Reading(dBuV).
 2.Correction factor (dB/m) = Antenna Factor (dB/m) + Cable loss (dB) – Pre-Amplifier gain (dB).
 3. When the peak results are less than average limit, so not need to evaluate the average.



Standard:	FCC Part 15.247	Test Distance:	3m
Test item:	Harmonic	Power:	DC 5V
Frequency:	2462MHz	Temp.(°C)/Hum.(%RH):	26(°C)/60%RH
Mode:	Mode 3	Date:	07/19/2017
Ant.Polar.:	Vertical		
Description:	Antenna Model : MSA-3310-25GC4-A25 / MSA-3310-25GC4-A26		

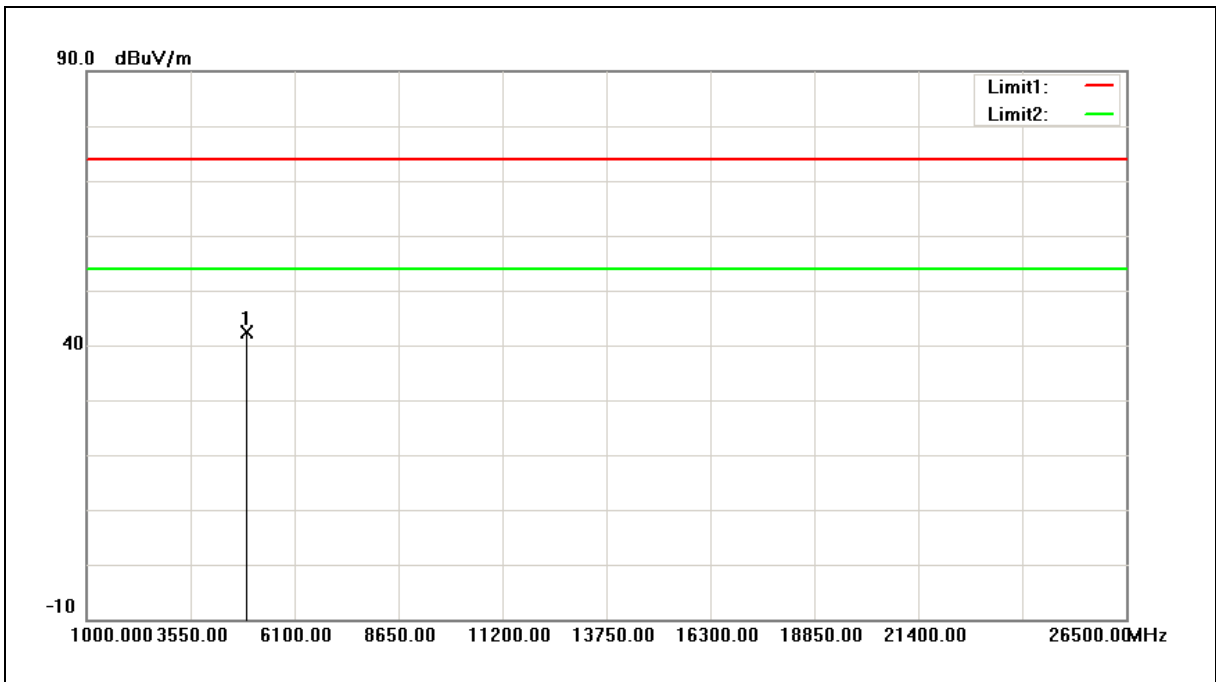

No.	Frequency (MHz)	Reading (dBuV)	Correct Factor (dB/m)	Result (dBuV/m)	Limit (dBuV/m)	Margin (dB)	Remark
1	4924.000	48.44	-6.08	42.36	74.00	-31.64	peak

Note:1.Result (dBuV/m) = Correct Factor (dB/m) + Reading(dBuV).

2.Correction factor (dB/m) = Antenna Factor (dB/m) + Cable loss (dB) – Pre-Amplifier gain (dB).

3. When the peak results are less than average limit, so not need to evaluate the average.



Standard:	FCC Part 15.247	Test Distance:	3m
Test item:	Harmonic	Power:	DC 5V
Frequency:	2412MHz	Temp.(°C)/Hum.(%RH):	26(°C)/60%RH
Mode:	Mode 4	Date:	07/19/2017
Ant.Polar.:	Horizontal		
Description:	Antenna Model : MSA-3310-25GC4-A25 / MSA-3310-25GC4-A26		

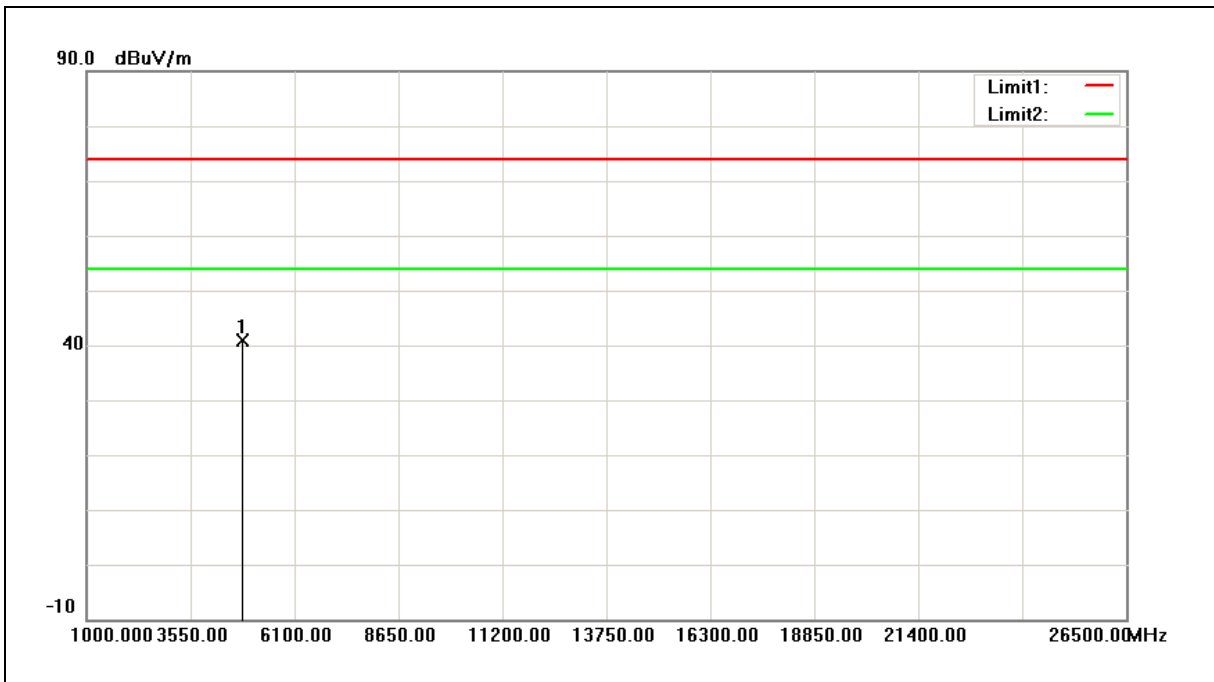

No.	Frequency (MHz)	Reading (dBuV)	Correct Factor (dB/m)	Result (dBuV/m)	Limit (dBuV/m)	Margin (dB)	Remark
1	4824.000	47.22	-6.44	40.78	74.00	-33.22	peak

Note:1.Result (dBuV/m) = Correct Factor (dB/m) + Reading(dBuV).

2.Correction factor (dB/m) = Antenna Factor (dB/m) + Cable loss (dB) – Pre-Amplifier gain (dB).

3. When the peak results are less than average limit, so not need to evaluate the average.



Standard:	FCC Part 15.247	Test Distance:	3m
Test item:	Harmonic	Power:	DC 5V
Frequency:	2412MHz	Temp.(°C)/Hum.(%RH):	26(°C)/60%RH
Mode:	Mode 4	Date:	07/19/2017
Ant.Polar.:	Vertical		
Description:	Antenna Model : MSA-3310-25GC4-A25 / MSA-3310-25GC4-A26		

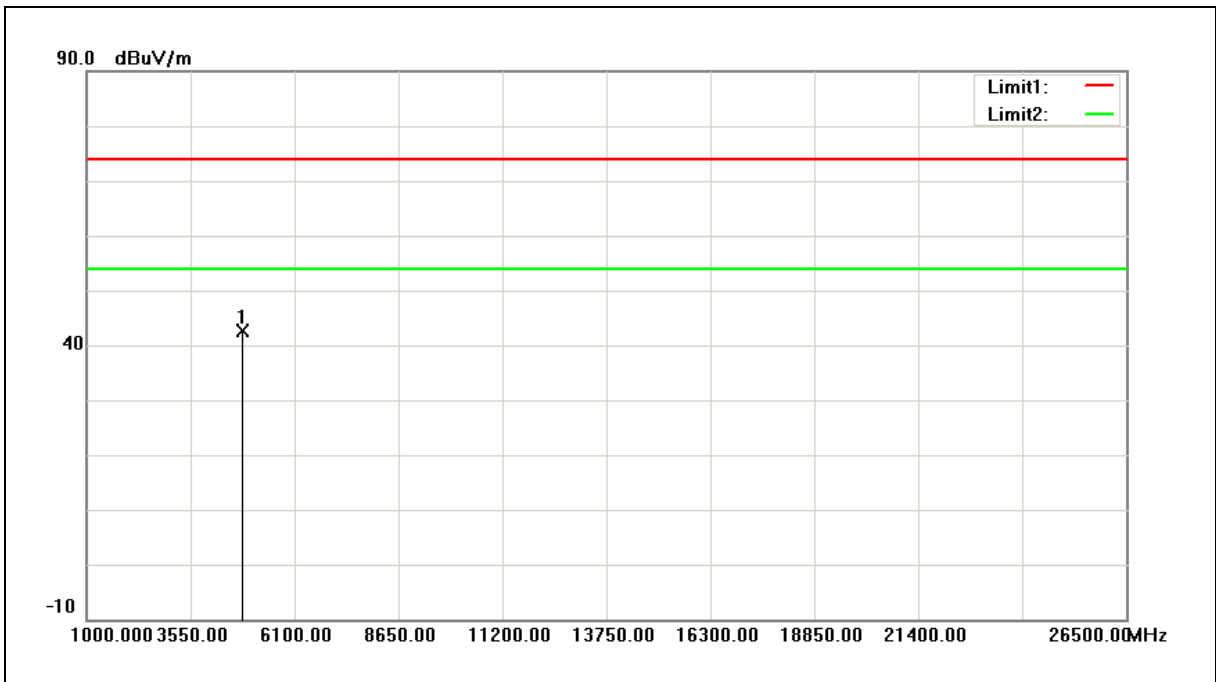

No.	Frequency (MHz)	Reading (dBuV)	Correct Factor (dB/m)	Result (dBuV/m)	Limit (dBuV/m)	Margin (dB)	Remark
1	4824.000	49.12	-6.44	42.68	74.00	-31.32	peak

Note:1.Result (dBuV/m) = Correct Factor (dB/m) + Reading(dBuV).

2.Correction factor (dB/m) = Antenna Factor (dB/m) + Cable loss (dB) – Pre-Amplifier gain (dB).

3. When the peak results are less than average limit, so not need to evaluate the average.



Standard:	FCC Part 15.247	Test Distance:	3m
Test item:	Harmonic	Power:	DC 5V
Frequency:	2437MHz	Temp.(°C)/Hum.(%RH):	26(°C)/60%RH
Mode:	Mode 4	Date:	07/19/2017
Ant.Polar.:	Horizontal		
Description:	Antenna Model : MSA-3310-25GC4-A25 / MSA-3310-25GC4-A26		

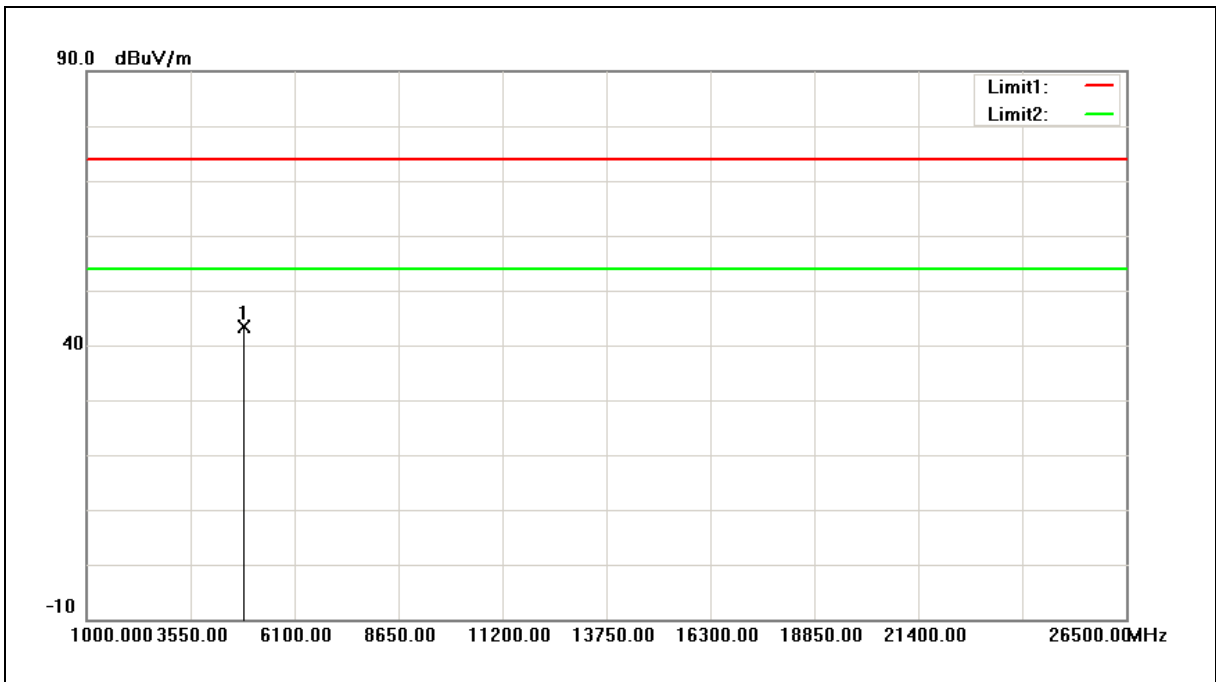

No.	Frequency (MHz)	Reading (dBuV)	Correct Factor (dB/m)	Result (dBuV/m)	Limit (dBuV/m)	Margin (dB)	Remark
1	4874.000	49.72	-6.26	43.46	74.00	-30.54	peak

Note:1.Result (dBuV/m) = Correct Factor (dB/m) + Reading(dBuV).

2.Correction factor (dB/m) = Antenna Factor (dB/m) + Cable loss (dB) – Pre-Amplifier gain (dB).

3. When the peak results are less than average limit, so not need to evaluate the average.



Standard:	FCC Part 15.247	Test Distance:	3m
Test item:	Harmonic	Power:	DC 5V
Frequency:	2437MHz	Temp.(°C)/Hum.(%RH):	26(°C)/60%RH
Mode:	Mode 4	Date:	07/19/2017
Ant.Polar.:	Vertical		
Description:	Antenna Model : MSA-3310-25GC4-A25 / MSA-3310-25GC4-A26		

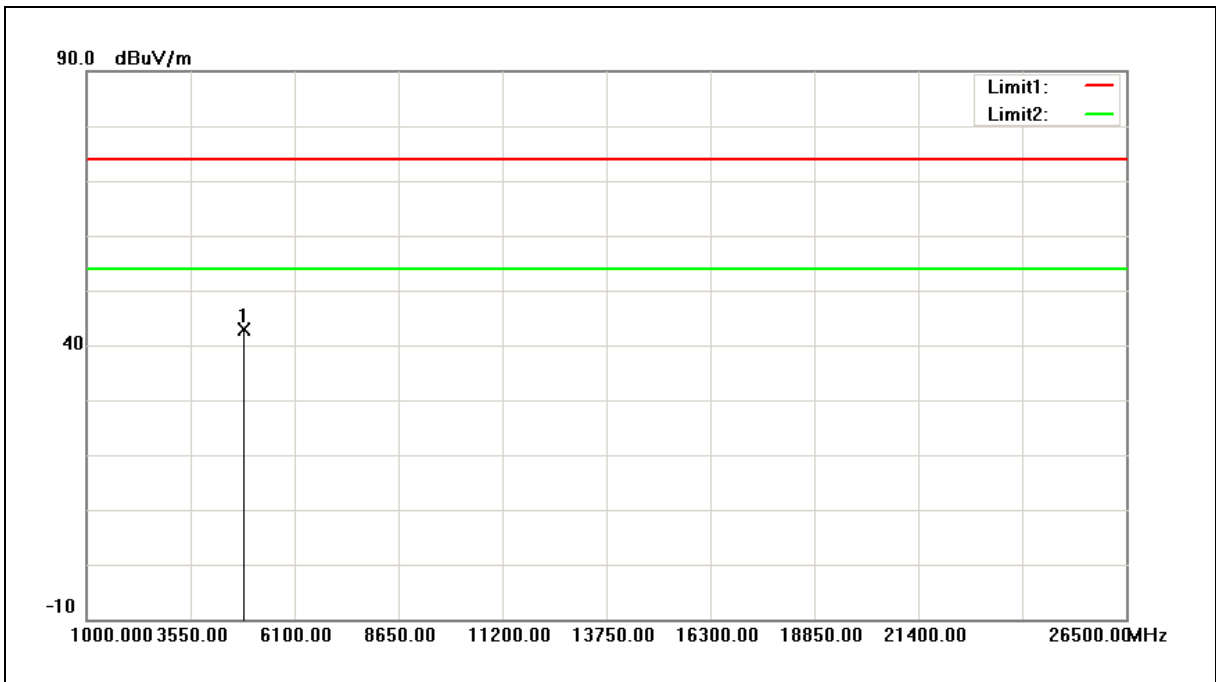

No.	Frequency (MHz)	Reading (dBuV)	Correct Factor (dB/m)	Result (dBuV/m)	Limit (dBuV/m)	Margin (dB)	Remark
1	4874.000	49.15	-6.26	42.89	74.00	-31.11	peak

Note:1.Result (dBuV/m) = Correct Factor (dB/m) + Reading(dBuV).

2.Correction factor (dB/m) = Antenna Factor (dB/m) + Cable loss (dB) – Pre-Amplifier gain (dB).

3. When the peak results are less than average limit, so not need to evaluate the average.



Standard:	FCC Part 15.247	Test Distance:	3m
Test item:	Harmonic	Power:	DC 5V
Frequency:	2462MHz	Temp.(°C)/Hum.(%RH):	26(°C)/60%RH
Mode:	Mode 4	Date:	07/19/2017
Ant.Polar.:	Horizontal		
Description:	Antenna Model : MSA-3310-25GC4-A25 / MSA-3310-25GC4-A26		

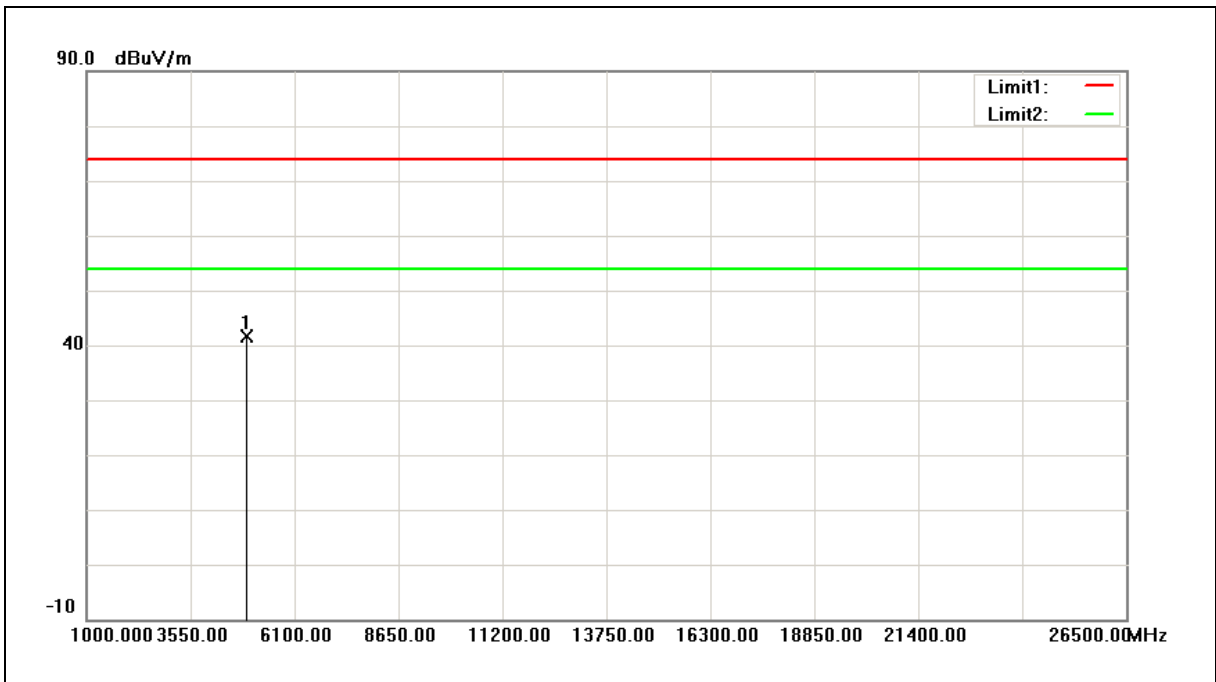

No.	Frequency (MHz)	Reading (dBuV)	Correct Factor (dB/m)	Result (dBuV/m)	Limit (dBuV/m)	Margin (dB)	Remark
1	4924.000	47.79	-6.08	41.71	74.00	-32.29	peak

Note:1.Result (dBuV/m) = Correct Factor (dB/m) + Reading(dBuV).

2.Correction factor (dB/m) = Antenna Factor (dB/m) + Cable loss (dB) – Pre-Amplifier gain (dB).

3. When the peak results are less than average limit, so not need to evaluate the average.



Standard:	FCC Part 15.247	Test Distance:	3m
Test item:	Harmonic	Power:	DC 5V
Frequency:	2462MHz	Temp.(°C)/Hum.(%RH):	26(°C)/60%RH
Mode:	Mode 4	Date:	07/19/2017
Ant.Polar.:	Vertical		
Description:	Antenna Model : MSA-3310-25GC4-A25 / MSA-3310-25GC4-A26		

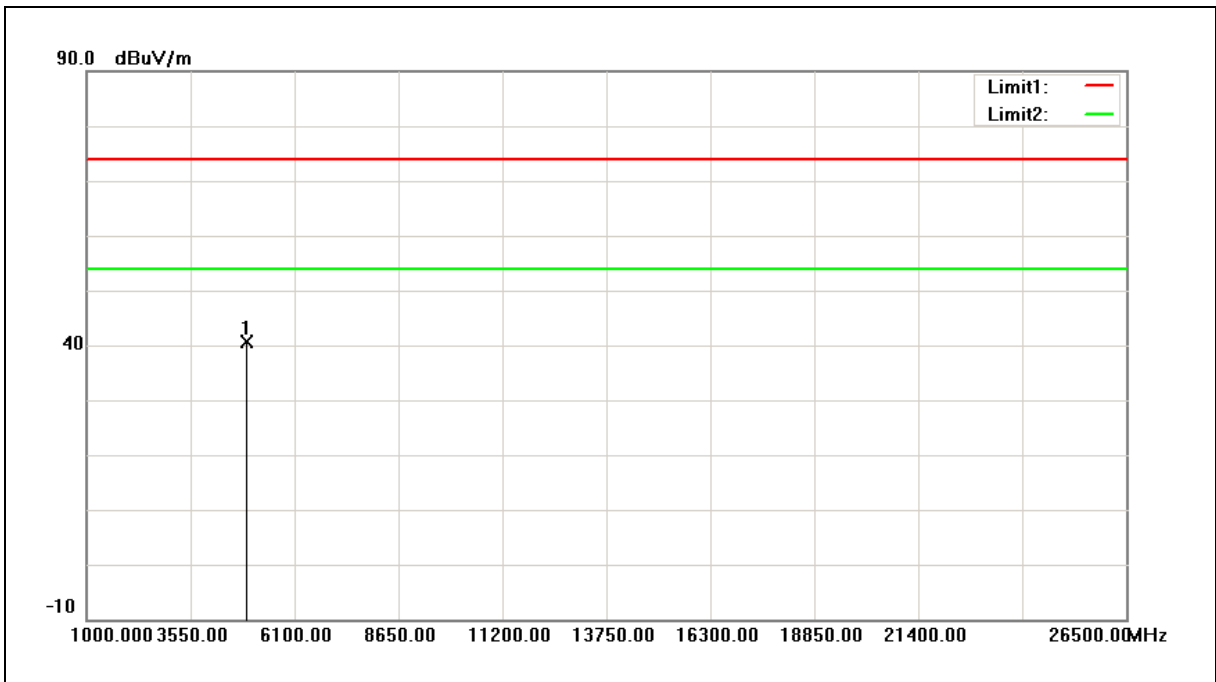

No.	Frequency (MHz)	Reading (dBuV)	Correct Factor (dB/m)	Result (dBuV/m)	Limit (dBuV/m)	Margin (dB)	Remark
1	4924.000	46.77	-6.08	40.69	74.00	-33.31	peak

Note:1.Result (dBuV/m) = Correct Factor (dB/m) + Reading(dBuV).

2.Correction factor (dB/m) = Antenna Factor (dB/m) + Cable loss (dB) – Pre-Amplifier gain (dB).

3. When the peak results are less than average limit, so not need to evaluate the average.



Standard:	FCC Part 15.247	Test Distance:	3m
Test item:	Harmonic	Power:	DC 5V
Frequency:	2422MHz	Temp.(°C)/Hum.(%RH):	26(°C)/60%RH
Mode:	Mode 5	Date:	07/19/2017
Ant.Polar.:	Horizontal		
Description:	Antenna Model : MSA-3310-25GC4-A25 / MSA-3310-25GC4-A26		

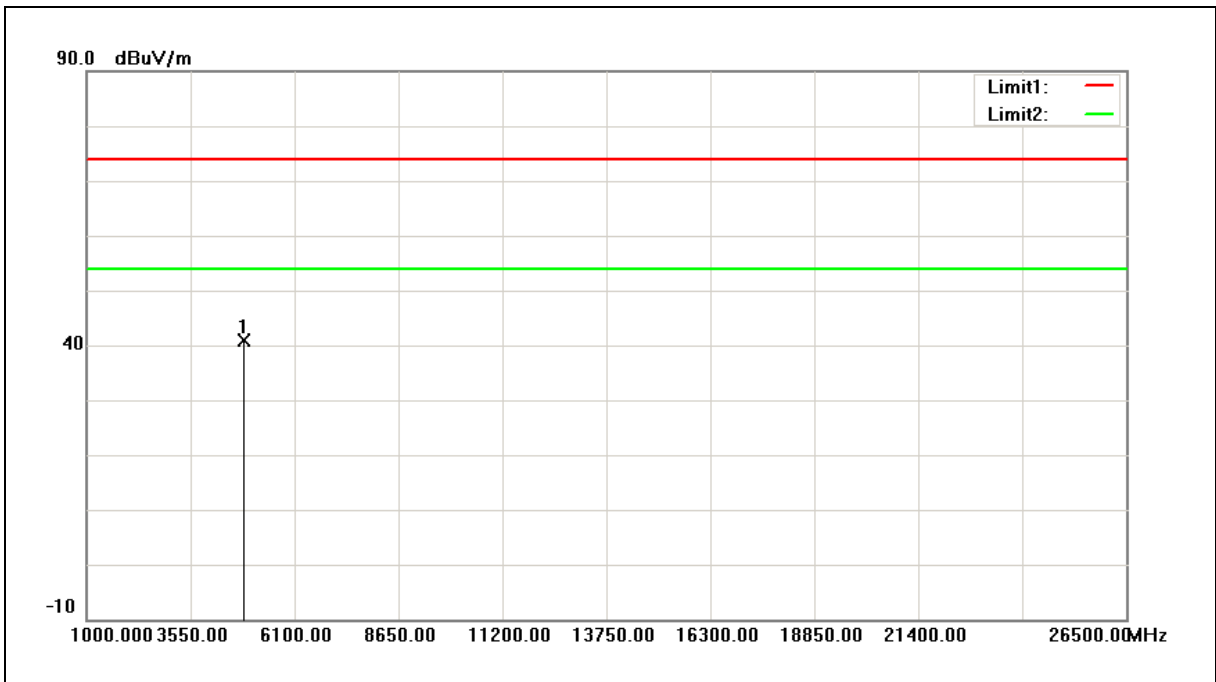

No.	Frequency (MHz)	Reading (dBuV)	Correct Factor (dB/m)	Result (dBuV/m)	Limit (dBuV/m)	Margin (dB)	Remark
1	4844.000	47.21	-6.36	40.85	74.00	-33.15	peak

Note:1.Result (dBuV/m) = Correct Factor (dB/m) + Reading(dBuV).

2.Correction factor (dB/m) = Antenna Factor (dB/m) + Cable loss (dB) – Pre-Amplifier gain (dB).

3. When the peak results are less than average limit, so not need to evaluate the average.



Standard:	FCC Part 15.247	Test Distance:	3m
Test item:	Harmonic	Power:	DC 5V
Frequency:	2422MHz	Temp.(°C)/Hum. (%RH):	26(°C)/60%RH
Mode:	Mode 5	Date:	07/19/2017
Ant.Polar.:	Vertical		
Description:	Antenna Model : MSA-3310-25GC4-A25 / MSA-3310-25GC4-A26		

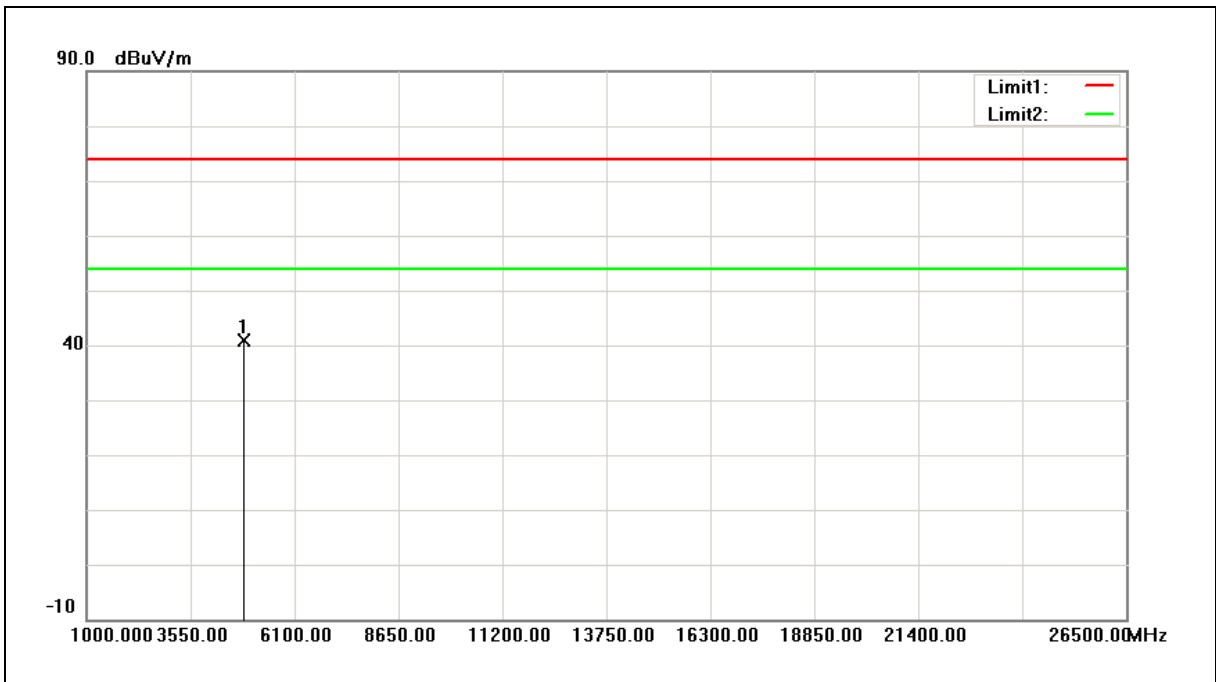

No.	Frequency (MHz)	Reading (dBuV)	Correct Factor (dB/m)	Result (dBuV/m)	Limit (dBuV/m)	Margin (dB)	Remark
1	4844.000	47.25	-6.36	40.89	74.00	-33.11	peak

Note:1.Result (dBuV/m) = Correct Factor (dB/m) + Reading(dBuV).

2.Correction factor (dB/m) = Antenna Factor (dB/m) + Cable loss (dB) – Pre-Amplifier gain (dB).

3. When the peak results are less than average limit, so not need to evaluate the average.



Standard:	FCC Part 15.247	Test Distance:	3m
Test item:	Harmonic	Power:	DC 5V
Frequency:	2437MHz	Temp.(°C)/Hum.(%RH):	26(°C)/60%RH
Mode:	Mode 5	Date:	07/19/2017
Ant.Polar.:	Horizontal		
Description:	Antenna Model : MSA-3310-25GC4-A25 / MSA-3310-25GC4-A26		

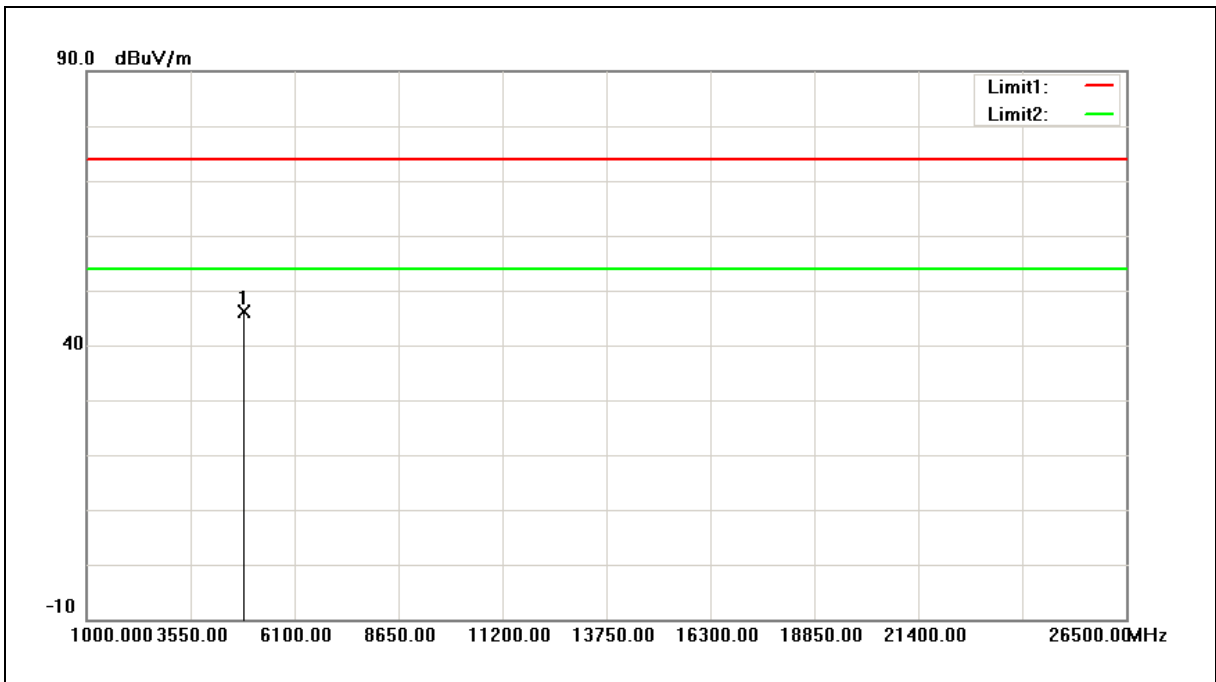

No.	Frequency (MHz)	Reading (dBuV)	Correct Factor (dB/m)	Result (dBuV/m)	Limit (dBuV/m)	Margin (dB)	Remark
1	4874.000	52.51	-6.26	46.25	74.00	-27.75	peak

- Note:1.Result (dBuV/m) = Correct Factor (dB/m) + Reading(dBuV).
 2.Correction factor (dB/m) = Antenna Factor (dB/m) + Cable loss (dB) – Pre-Amplifier gain (dB).
 3. When the peak results are less than average limit, so not need to evaluate the average.



Standard:	FCC Part 15.247	Test Distance:	3m
Test item:	Harmonic	Power:	DC 5V
Frequency:	2437MHz	Temp.(°C)/Hum.(%RH):	26(°C)/60%RH
Mode:	Mode 5	Date:	07/19/2017
Ant.Polar.:	Vertical		
Description:	Antenna Model : MSA-3310-25GC4-A25 / MSA-3310-25GC4-A26		

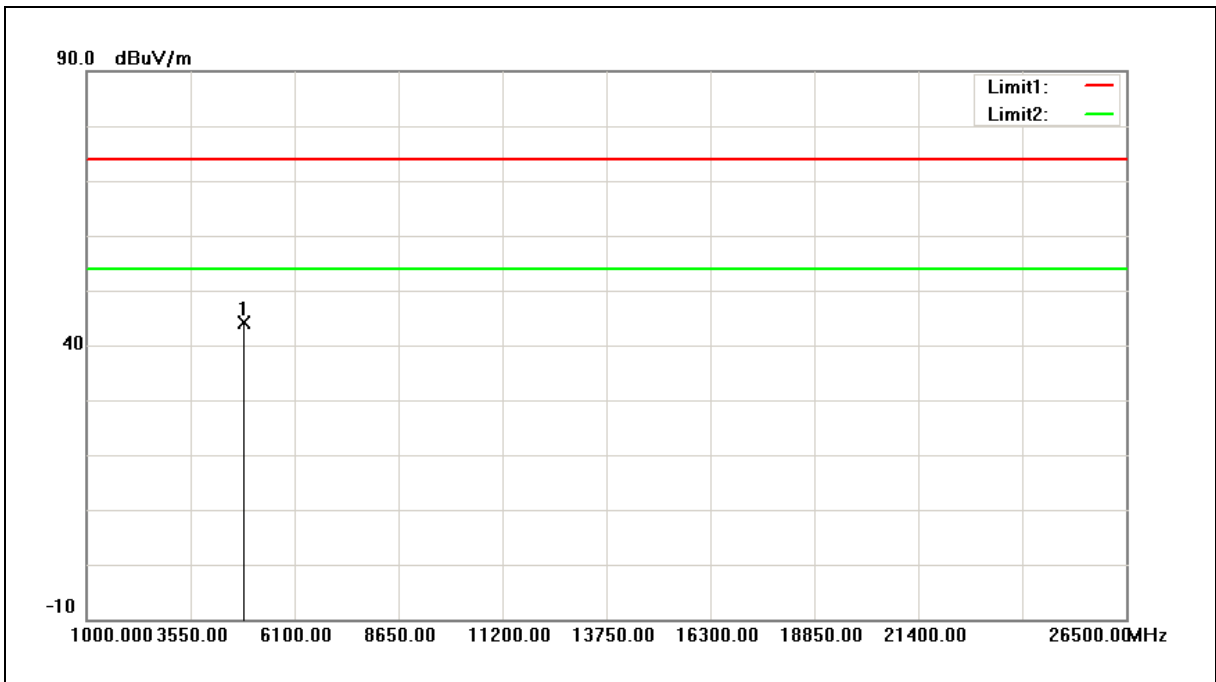

No.	Frequency (MHz)	Reading (dBuV)	Correct Factor (dB/m)	Result (dBuV/m)	Limit (dBuV/m)	Margin (dB)	Remark
1	4874.000	50.46	-6.26	44.20	74.00	-29.80	peak

Note:1.Result (dBuV/m) = Correct Factor (dB/m) + Reading(dBuV).

2.Correction factor (dB/m) = Antenna Factor (dB/m) + Cable loss (dB) – Pre-Amplifier gain (dB).

3. When the peak results are less than average limit, so not need to evaluate the average.



Standard:	FCC Part 15.247	Test Distance:	3m
Test item:	Harmonic	Power:	DC 5V
Frequency:	2452MHz	Temp.(°C)/Hum.(%RH):	26(°C)/60%RH
Mode:	Mode 5	Date:	07/19/2017
Ant.Polar.:	Horizontal		
Description:	Antenna Model : MSA-3310-25GC4-A25 / MSA-3310-25GC4-A26		

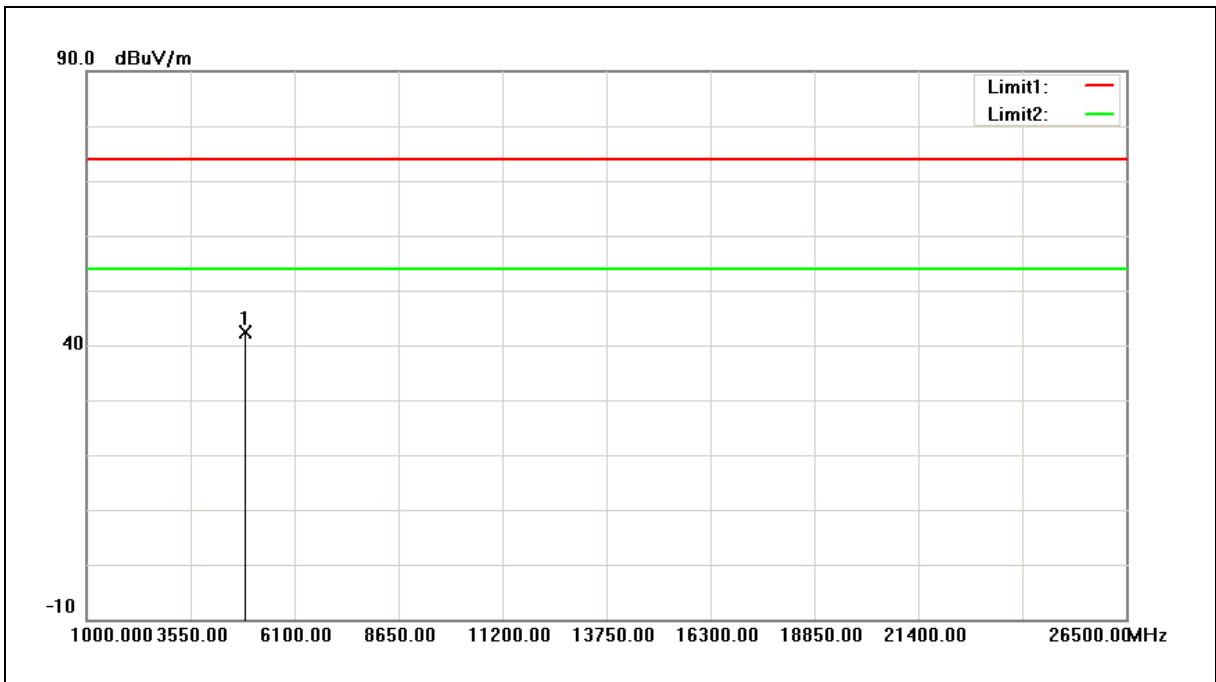

No.	Frequency (MHz)	Reading (dBuV)	Correct Factor (dB/m)	Result (dBuV/m)	Limit (dBuV/m)	Margin (dB)	Remark
1	4904.000	48.42	-6.15	42.27	74.00	-31.73	peak

Note:1.Result (dBuV/m) = Correct Factor (dB/m) + Reading(dBuV).

2.Correction factor (dB/m) = Antenna Factor (dB/m) + Cable loss (dB) – Pre-Amplifier gain (dB).

3. When the peak results are less than average limit, so not need to evaluate the average.



Standard:	FCC Part 15.247	Test Distance:	3m
Test item:	Harmonic	Power:	DC 5V
Frequency:	2452MHz	Temp.(°C)/Hum.(%RH):	26(°C)/60%RH
Mode:	Mode 5	Date:	07/19/2017
Ant.Polar.:	Vertical		
Description:	Antenna Model : MSA-3310-25GC4-A25 / MSA-3310-25GC4-A26		

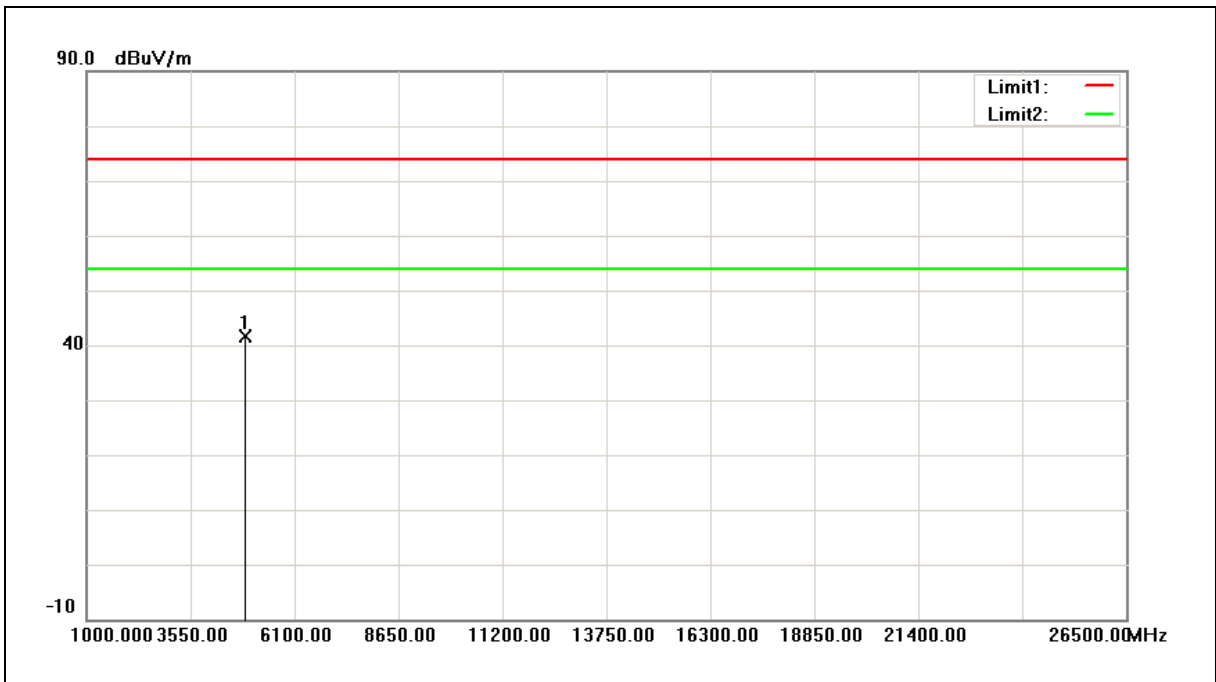

No.	Frequency (MHz)	Reading (dBuV)	Correct Factor (dB/m)	Result (dBuV/m)	Limit (dBuV/m)	Margin (dB)	Remark
1	4904.000	47.68	-6.15	41.53	74.00	-32.47	peak

Note:1.Result (dBuV/m) = Correct Factor (dB/m) + Reading(dBuV).

2.Correction factor (dB/m) = Antenna Factor (dB/m) + Cable loss (dB) – Pre-Amplifier gain (dB).

3. When the peak results are less than average limit, so not need to evaluate the average.



Standard:	FCC Part 15.407	Test Distance:	3m
Test item:	Transmitter Unwanted Emissions	Power:	DC 5V
Test Mode:	Simultaneous Transmitting (DTS+NII)	Temp.(°C)/Hum.(%RH):	26(°C)/60%RH
Ant.Polar.:	Horizontal	Date:	07/21/2017
Description:	Antenna Model : MSA-3310-25GC4-A25 / MSA-3310-25GC4-A26		

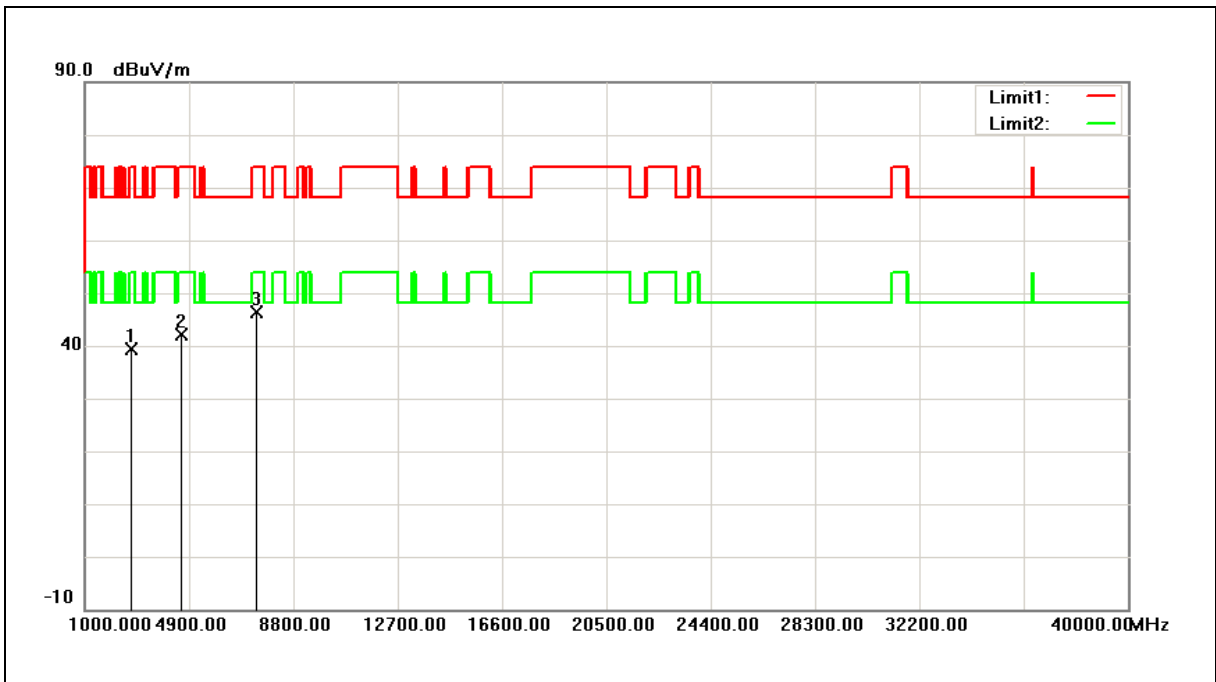

No.	Frequency (MHz)	Reading (dBuV)	Correct Factor (dB/m)	Result (dBuV/m)	Limit (dBuV/m)	Margin (dB)	Remark
1	2734.000	51.80	-12.50	39.30	74.00	-34.70	peak
2	4621.000	49.36	-7.15	42.21	74.00	-31.79	peak
3	7409.000	45.25	1.01	46.26	74.00	-27.74	peak

Note:1.Result (dBuV/m) = Correct Factor (dB/m) + Reading(dBuV).

2.Correction factor (dB/m) = Antenna Factor (dB/m) + Cable loss (dB) – Pre-Amplifier gain (dB).

3. When the peak results are less than average limit, so not need to evaluate the average.



Standard:	FCC Part 15.407	Test Distance:	3m
Test item:	Transmitter Unwanted Emissions	Power:	DC 5V
Test Mode:	Simultaneous Transmitting (DTS+NII)	Temp.(°C)/Hum.(%RH):	26(°C)/60%RH
Ant.Polar.:	Vertical	Date:	07/21/2017
Description:	Antenna Model : MSA-3310-25GC4-A25 / MSA-3310-25GC4-A26		

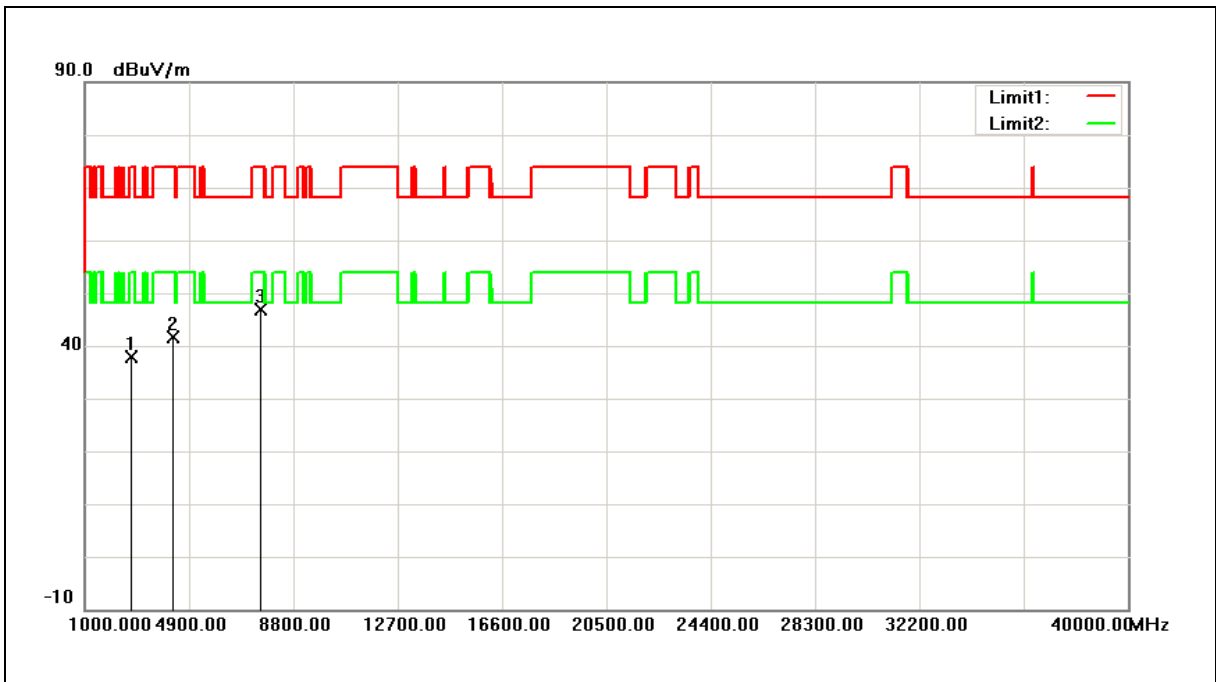

No.	Frequency (MHz)	Reading (dBuV)	Correct Factor (dB/m)	Result (dBuV/m)	Limit (dBuV/m)	Margin (dB)	Remark
1	2751.000	50.23	-12.45	37.78	74.00	-36.22	peak
2	4298.000	49.60	-8.02	41.58	74.00	-32.42	peak
3	7562.000	45.47	1.52	46.99	74.00	-27.01	peak

Note:1.Result (dBuV/m) = Correct Factor (dB/m) + Reading(dBuV).

2.Correction factor (dB/m) = Antenna Factor (dB/m) + Cable loss (dB) – Pre-Amplifier gain (dB).

3. When the peak results are less than average limit, so not need to evaluate the average.



Standard:	FCC Part 15.247	Test Distance:	3m
Test item:	Harmonic	Power:	DC 5V
Frequency:	2412MHz	Temp.(°C)/Hum.(%RH):	26(°C)/60%RH
Mode:	Mode 2	Date:	07/12/2017
Ant.Polar.:	Horizontal		
Description:	Antenna Model : EDA-1713-25GC1-A14		

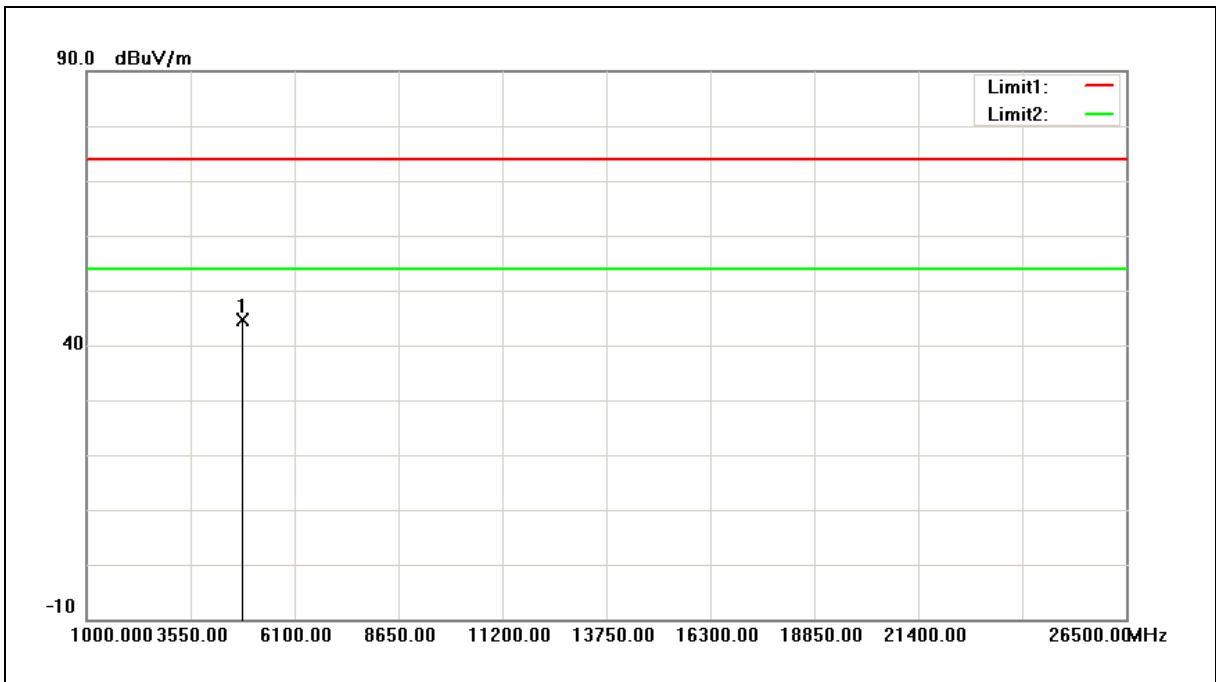

No.	Frequency (MHz)	Reading (dBuV)	Correct Factor (dB/m)	Result (dBuV/m)	Limit (dBuV/m)	Margin (dB)	Remark
1	4824.000	51.12	-6.44	44.68	74.00	-29.32	peak

Note:1.Result (dBuV/m) = Correct Factor (dB/m) + Reading(dBuV).

2.Correction factor (dB/m) = Antenna Factor (dB/m) + Cable loss (dB) – Pre-Amplifier gain (dB).

3. When the peak results are less than average limit, so not need to evaluate the average.



Standard:	FCC Part 15.247	Test Distance:	3m
Test item:	Harmonic	Power:	DC 5V
Frequency:	2412MHz	Temp.(°C)/Hum.(%RH):	26(°C)/60%RH
Mode:	Mode 2	Date:	07/12/2017
Ant.Polar.:	Vertical		
Description:	Antenna Model : EDA-1713-25GC1-A14		

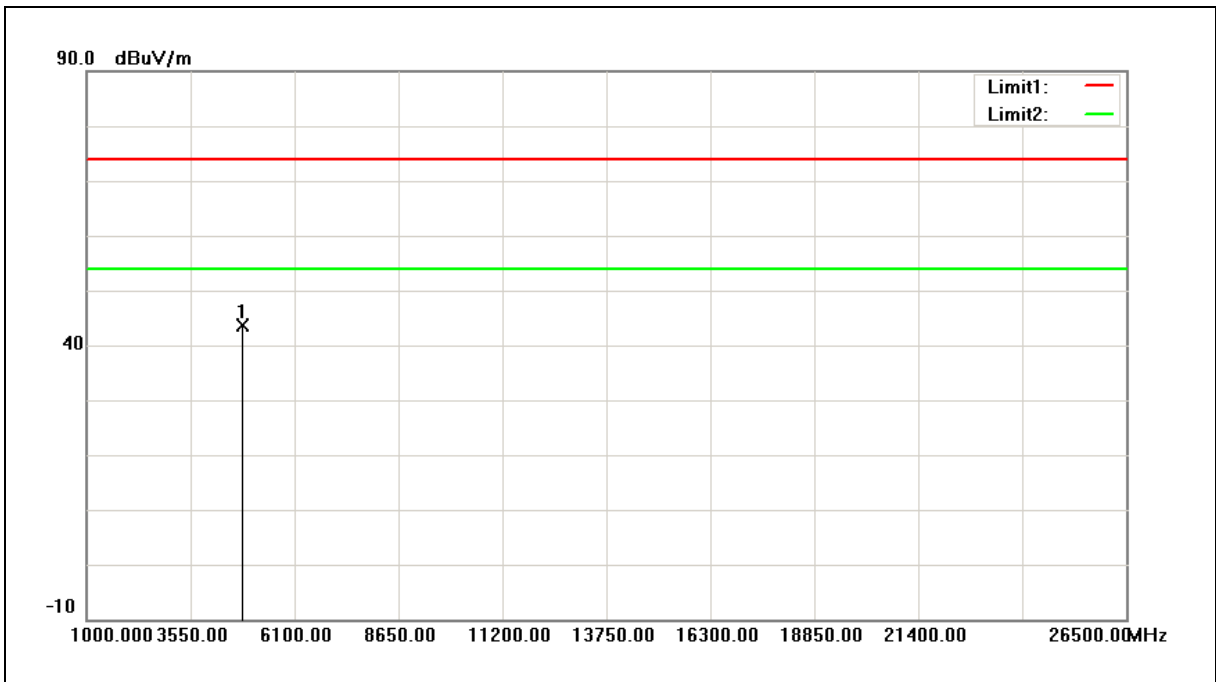

No.	Frequency (MHz)	Reading (dBuV)	Correct Factor (dB/m)	Result (dBuV/m)	Limit (dBuV/m)	Margin (dB)	Remark
1	4824.000	50.09	-6.44	43.65	74.00	-30.35	peak

- Note:1.Result (dBuV/m) = Correct Factor (dB/m) + Reading(dBuV).
 2.Correction factor (dB/m) = Antenna Factor (dB/m) + Cable loss (dB) – Pre-Amplifier gain (dB).
 3. When the peak results are less than average limit, so not need to evaluate the average.



Standard:	FCC Part 15.247	Test Distance:	3m
Test item:	Harmonic	Power:	DC 5V
Frequency:	2437MHz	Temp.(°C)/Hum.(%RH):	26(°C)/60%RH
Mode:	Mode 2	Date:	07/12/2017
Ant.Polar.:	Horizontal		
Description:	Antenna Model : EDA-1713-25GC1-A14		

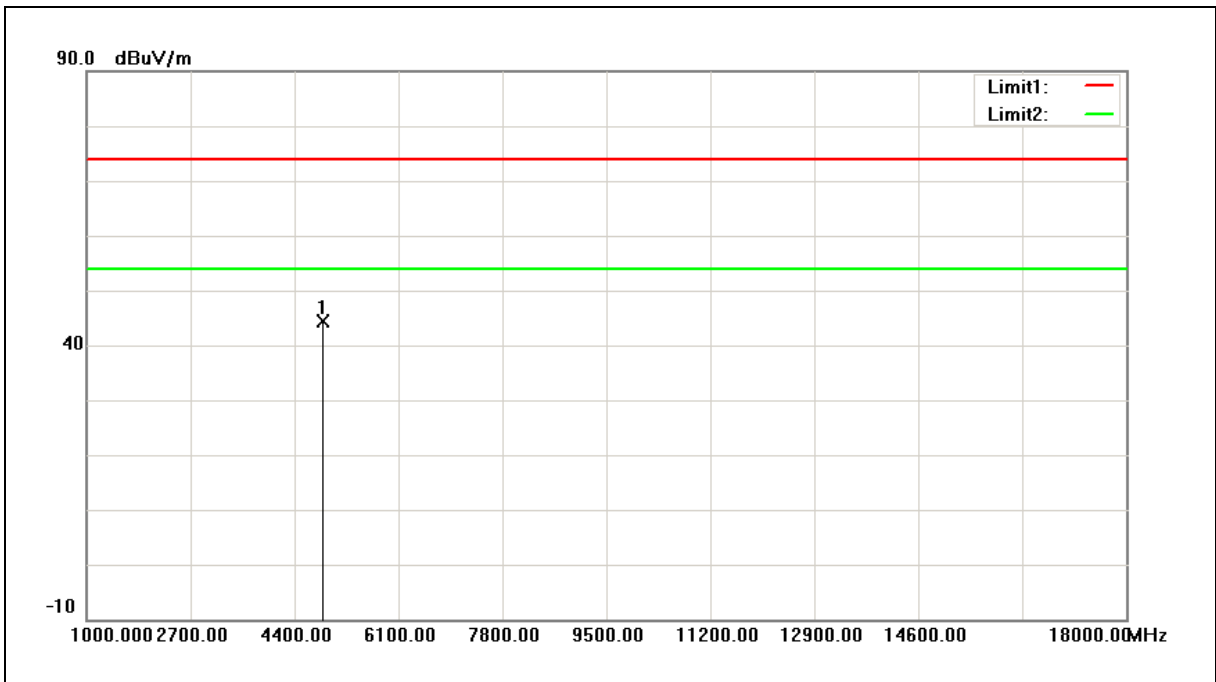

No.	Frequency (MHz)	Reading (dBuV)	Correct Factor (dB/m)	Result (dBuV/m)	Limit (dBuV/m)	Margin (dB)	Remark
1	4874.000	50.73	-6.26	44.47	74.00	-29.53	peak

Note:1.Result (dBuV/m) = Correct Factor (dB/m) + Reading(dBuV).

2.Correction factor (dB/m) = Antenna Factor (dB/m) + Cable loss (dB) – Pre-Amplifier gain (dB).

3. When the peak results are less than average limit, so not need to evaluate the average.



Standard:	FCC Part 15.247	Test Distance:	3m
Test item:	Harmonic	Power:	DC 5V
Frequency:	2437MHz	Temp.(°C)/Hum.(%RH):	26(°C)/60%RH
Mode:	Mode 2	Date:	07/12/2017
Ant.Polar.:	Vertical		
Description:	Antenna Model : EDA-1713-25GC1-A14		

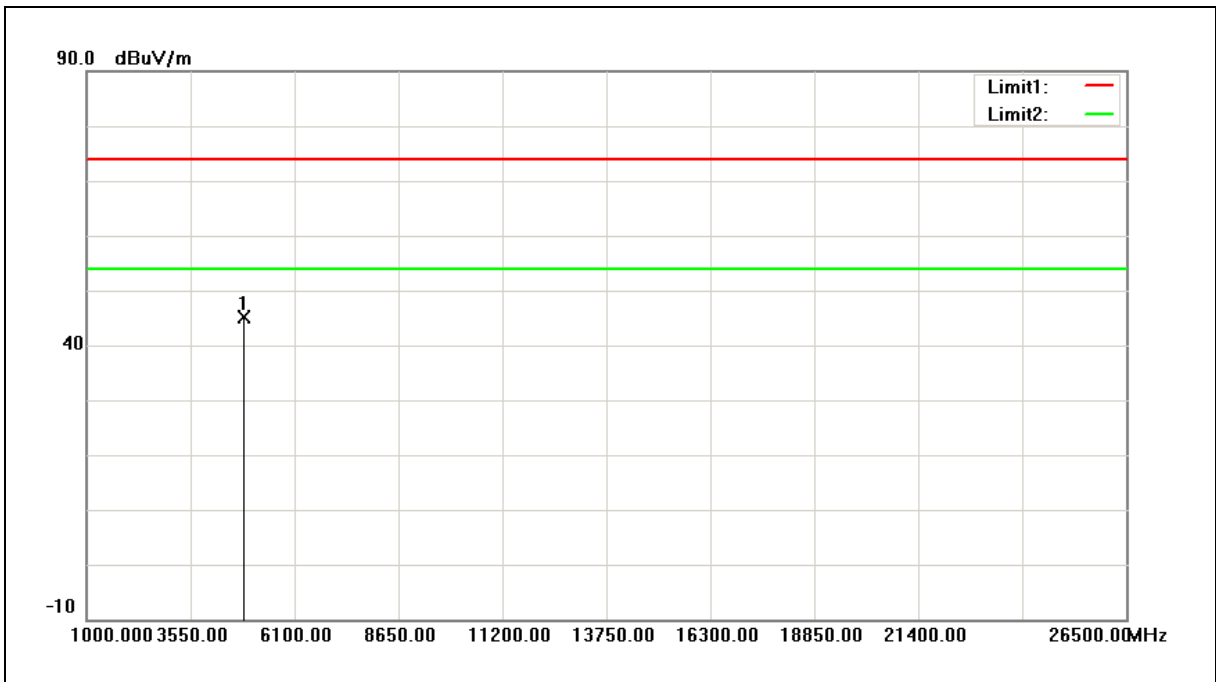

No.	Frequency (MHz)	Reading (dBuV)	Correct Factor (dB/m)	Result (dBuV/m)	Limit (dBuV/m)	Margin (dB)	Remark
1	4874.000	51.27	-6.26	45.01	74.00	-28.99	peak

Note:1.Result (dBuV/m) = Correct Factor (dB/m) + Reading(dBuV).

2.Correction factor (dB/m) = Antenna Factor (dB/m) + Cable loss (dB) – Pre-Amplifier gain (dB).

3. When the peak results are less than average limit, so not need to evaluate the average.



Standard:	FCC Part 15.247	Test Distance:	3m
Test item:	Harmonic	Power:	DC 5V
Frequency:	2462MHz	Temp.(°C)/Hum.(%RH):	26(°C)/60%RH
Mode:	Mode 2	Date:	07/12/2017
Ant.Polar.:	Horizontal		
Description:	Antenna Model : EDA-1713-25GC1-A14		

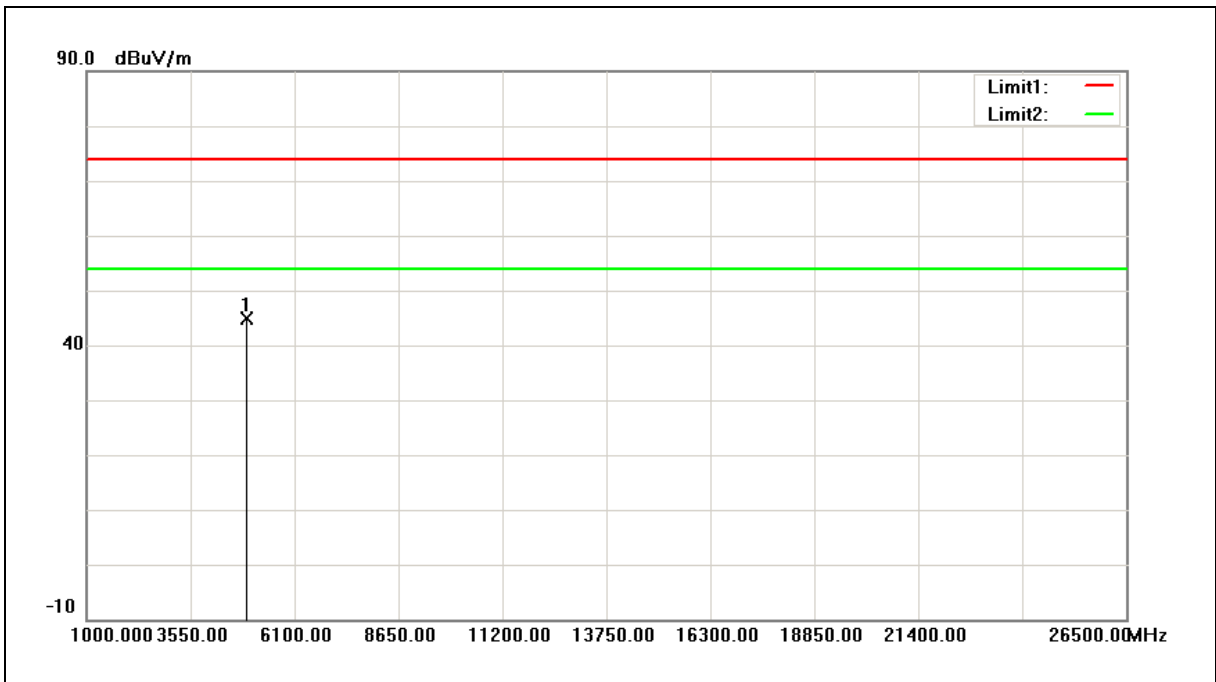

No.	Frequency (MHz)	Reading (dBuV)	Correct Factor (dB/m)	Result (dBuV/m)	Limit (dBuV/m)	Margin (dB)	Remark
1	4924.000	50.92	-6.08	44.84	74.00	-29.16	peak

Note:1.Result (dBuV/m) = Correct Factor (dB/m) + Reading(dBuV).

2.Correction factor (dB/m) = Antenna Factor (dB/m) + Cable loss (dB) – Pre-Amplifier gain (dB).

3. When the peak results are less than average limit, so not need to evaluate the average.



Standard:	FCC Part 15.247	Test Distance:	3m
Test item:	Harmonic	Power:	DC 5V
Frequency:	2462MHz	Temp.(°C)/Hum.(%RH):	26(°C)/60%RH
Mode:	Mode 2	Date:	07/12/2017
Ant.Polar.:	Vertical		
Description:	Antenna Model : EDA-1713-25GC1-A14		

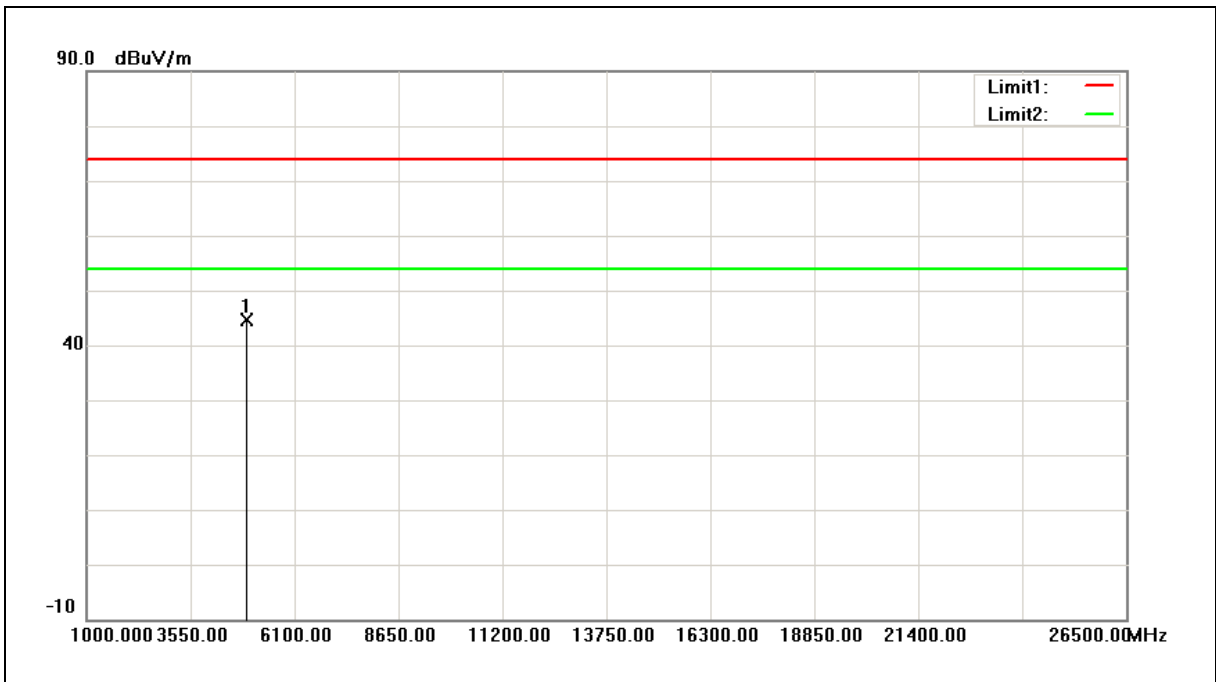

No.	Frequency (MHz)	Reading (dBuV)	Correct Factor (dB/m)	Result (dBuV/m)	Limit (dBuV/m)	Margin (dB)	Remark
1	4924.000	50.62	-6.08	44.54	74.00	-29.46	peak

- Note:1.Result (dBuV/m) = Correct Factor (dB/m) + Reading(dBuV).
 2.Correction factor (dB/m) = Antenna Factor (dB/m) + Cable loss (dB) – Pre-Amplifier gain (dB).
 3. When the peak results are less than average limit, so not need to evaluate the average.



Standard:	FCC Part 15.247	Test Distance:	3m
Test item:	Harmonic	Power:	DC 5V
Frequency:	2412MHz	Temp.(°C)/Hum.(%RH):	26(°C)/60%RH
Mode:	Mode 3	Date:	07/12/2017
Ant.Polar.:	Horizontal		
Description:	Antenna Model : EDA-1713-25GC1-A14		

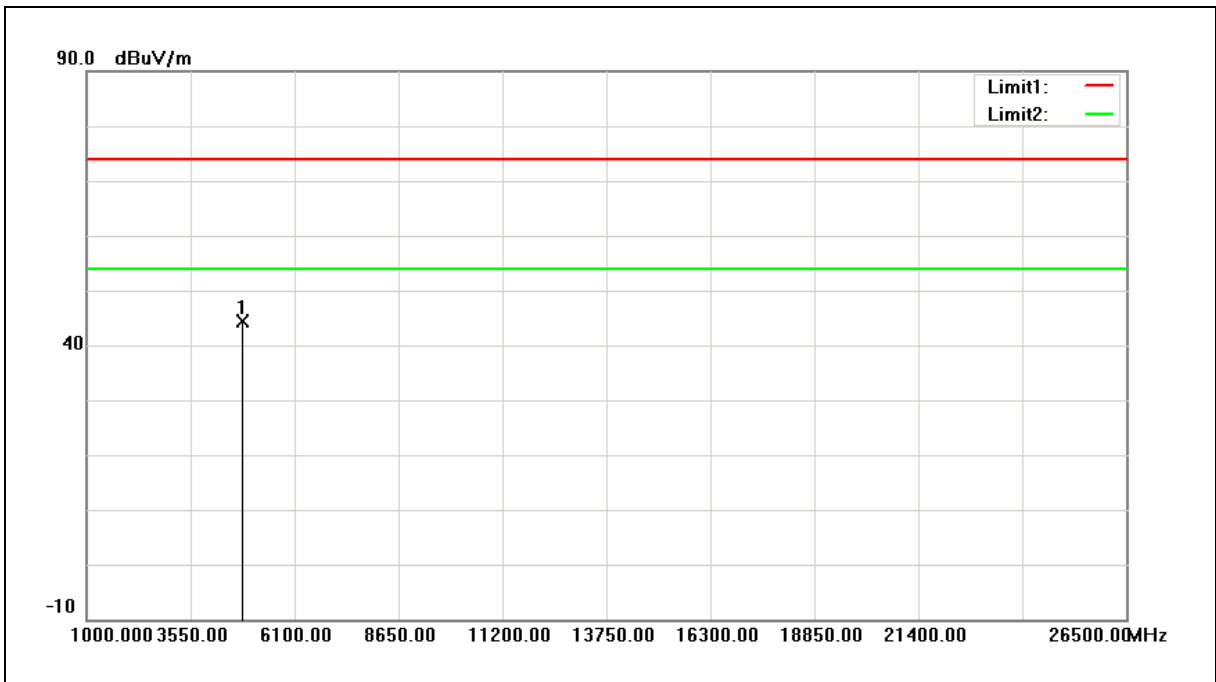

No.	Frequency (MHz)	Reading (dBuV)	Correct Factor (dB/m)	Result (dBuV/m)	Limit (dBuV/m)	Margin (dB)	Remark
1	4824.000	50.84	-6.44	44.40	74.00	-29.60	peak

Note:1.Result (dBuV/m) = Correct Factor (dB/m) + Reading(dBuV).

2.Correction factor (dB/m) = Antenna Factor (dB/m) + Cable loss (dB) – Pre-Amplifier gain (dB).

3. When the peak results are less than average limit, so not need to evaluate the average.



Standard:	FCC Part 15.247	Test Distance:	3m
Test item:	Harmonic	Power:	DC 5V
Frequency:	2412MHz	Temp.(°C)/Hum.(%RH):	26(°C)/60%RH
Mode:	Mode 3	Date:	07/12/2017
Ant.Polar.:	Vertical		
Description:	Antenna Model : EDA-1713-25GC1-A14		

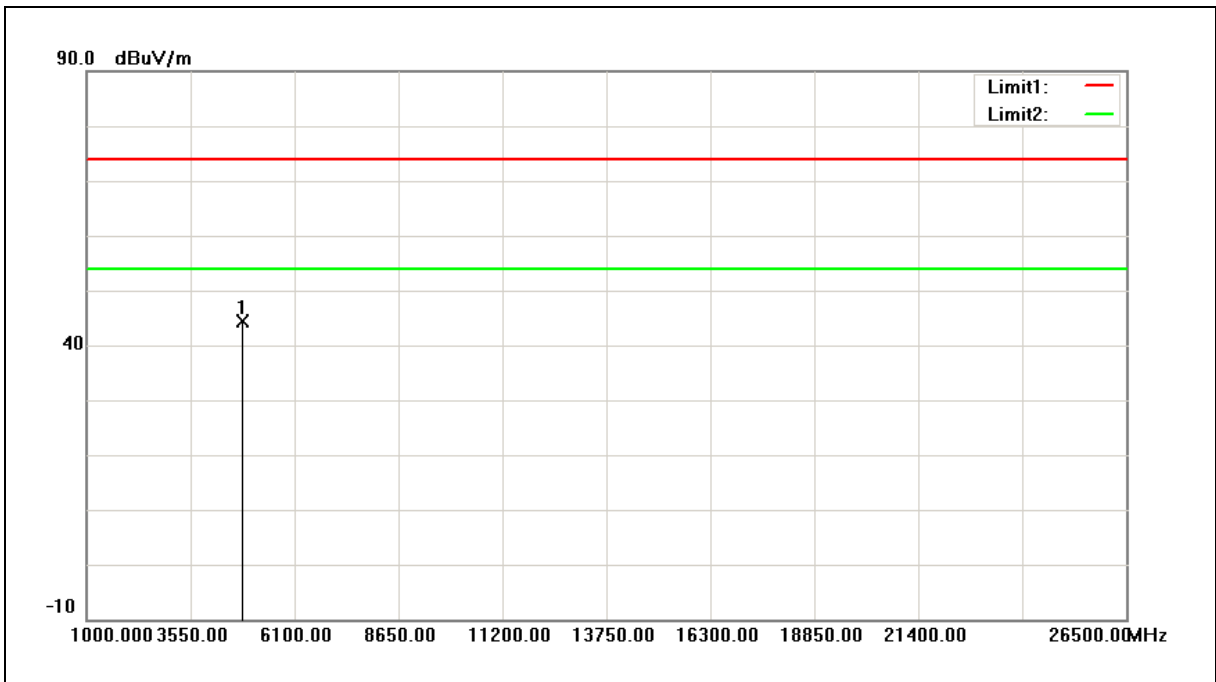

No.	Frequency (MHz)	Reading (dBuV)	Correct Factor (dB/m)	Result (dBuV/m)	Limit (dBuV/m)	Margin (dB)	Remark
1	4824.000	50.77	-6.44	44.33	74.00	-29.67	peak

Note:1.Result (dBuV/m) = Correct Factor (dB/m) + Reading(dBuV).

2.Correction factor (dB/m) = Antenna Factor (dB/m) + Cable loss (dB) – Pre-Amplifier gain (dB).

3. When the peak results are less than average limit, so not need to evaluate the average.



Standard:	FCC Part 15.247	Test Distance:	3m
Test item:	Harmonic	Power:	DC 5V
Frequency:	2437MHz	Temp.(°C)/Hum.(%RH):	26(°C)/60%RH
Mode:	Mode 3	Date:	07/12/2017
Ant.Polar.:	Horizontal		
Description:	Antenna Model : EDA-1713-25GC1-A14		

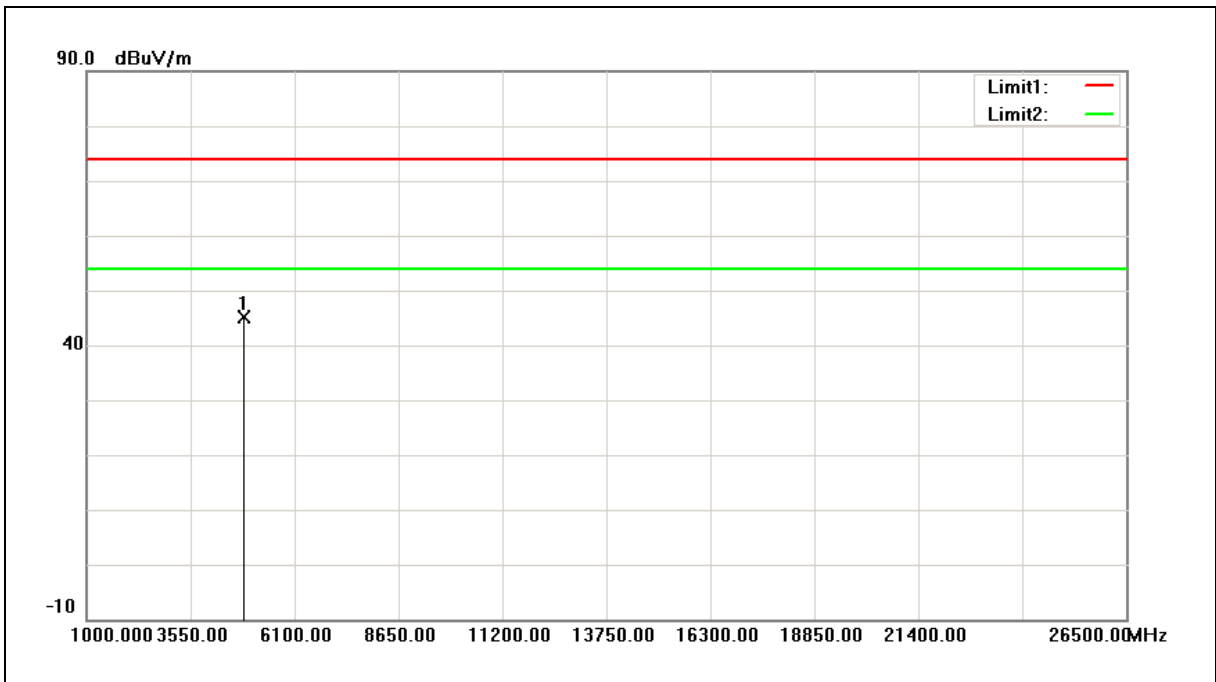

No.	Frequency (MHz)	Reading (dBuV)	Correct Factor (dB/m)	Result (dBuV/m)	Limit (dBuV/m)	Margin (dB)	Remark
1	4874.000	51.50	-6.26	45.24	74.00	-28.76	peak

Note:1.Result (dBuV/m) = Correct Factor (dB/m) + Reading(dBuV).

2.Correction factor (dB/m) = Antenna Factor (dB/m) + Cable loss (dB) – Pre-Amplifier gain (dB).

3. When the peak results are less than average limit, so not need to evaluate the average.



Standard:	FCC Part 15.247	Test Distance:	3m
Test item:	Harmonic	Power:	DC 5V
Frequency:	2437MHz	Temp.(°C)/Hum.(%RH):	26(°C)/60%RH
Mode:	Mode 3	Date:	07/12/2017
Ant.Polar.:	Vertical		
Description:	Antenna Model : EDA-1713-25GC1-A14		

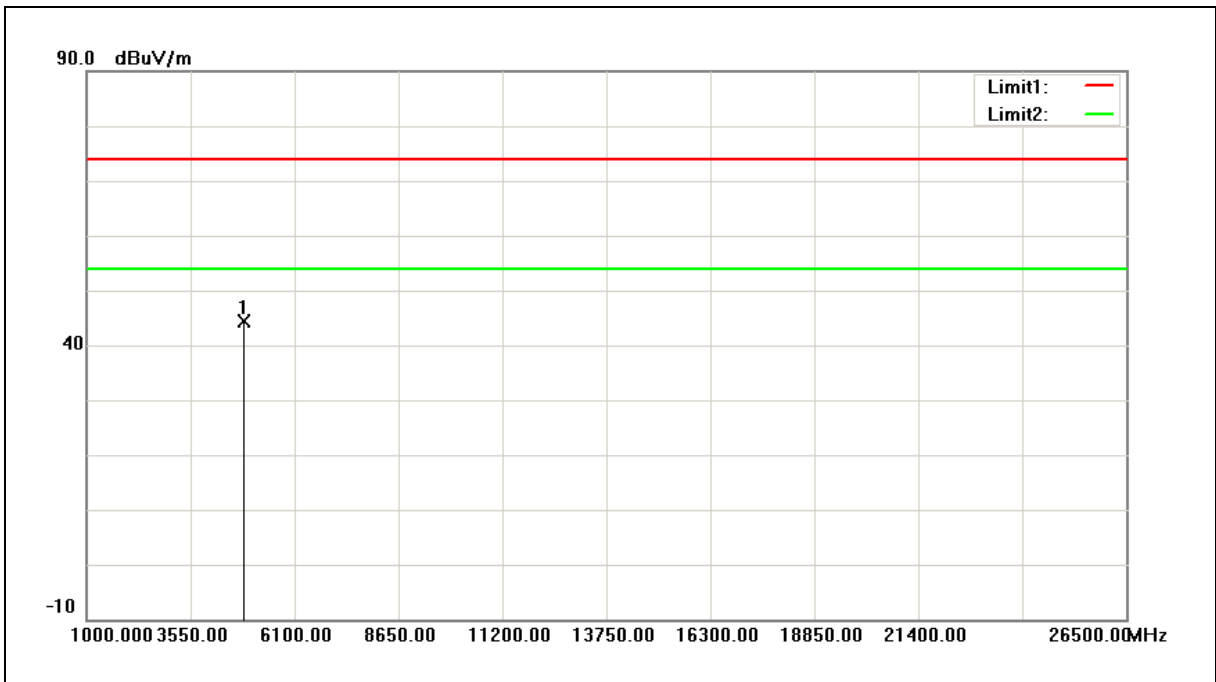

No.	Frequency (MHz)	Reading (dBuV)	Correct Factor (dB/m)	Result (dBuV/m)	Limit (dBuV/m)	Margin (dB)	Remark
1	4874.000	50.66	-6.26	44.40	74.00	-29.60	peak

Note:1.Result (dBuV/m) = Correct Factor (dB/m) + Reading(dBuV).

2.Correction factor (dB/m) = Antenna Factor (dB/m) + Cable loss (dB) – Pre-Amplifier gain (dB).

3. When the peak results are less than average limit, so not need to evaluate the average.



Standard:	FCC Part 15.247	Test Distance:	3m
Test item:	Harmonic	Power:	DC 5V
Frequency:	2462MHz	Temp.(°C)/Hum.(%RH):	26(°C)/60%RH
Mode:	Mode 3	Date:	07/12/2017
Ant.Polar.:	Horizontal		
Description:	Antenna Model : EDA-1713-25GC1-A14		

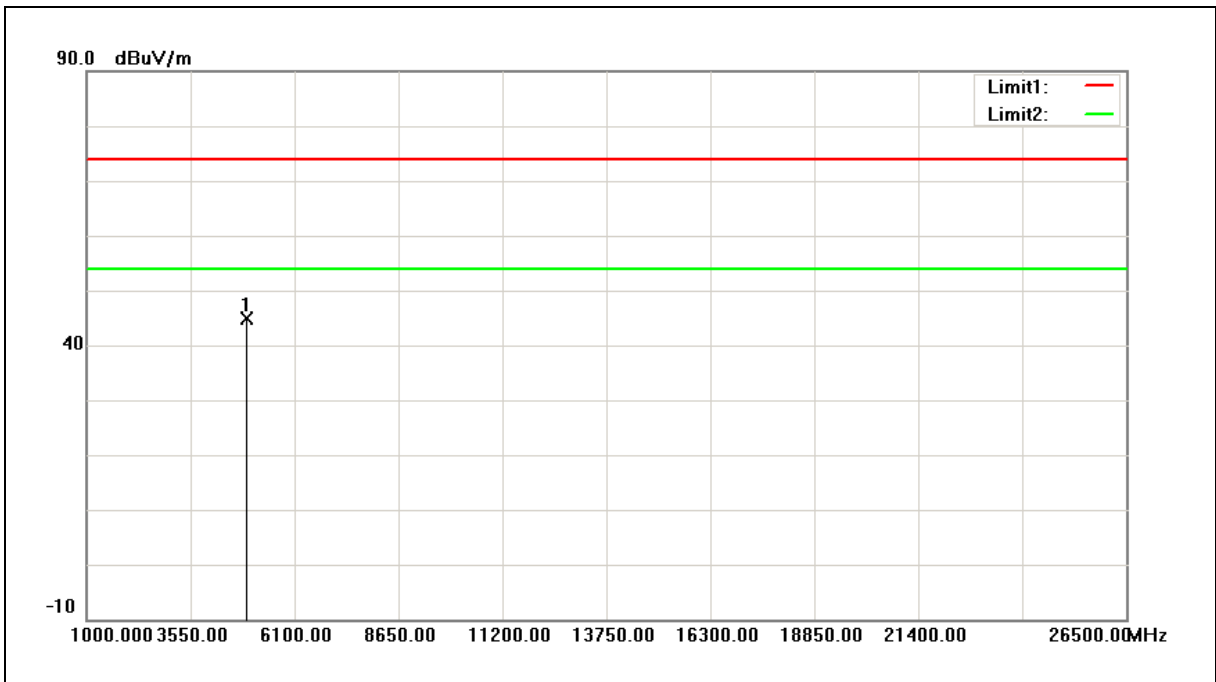

No.	Frequency (MHz)	Reading (dBuV)	Correct Factor (dB/m)	Result (dBuV/m)	Limit (dBuV/m)	Margin (dB)	Remark
1	4924.000	50.94	-6.08	44.86	74.00	-29.14	peak

Note:1.Result (dBuV/m) = Correct Factor (dB/m) + Reading(dBuV).

2.Correction factor (dB/m) = Antenna Factor (dB/m) + Cable loss (dB) – Pre-Amplifier gain (dB).

3. When the peak results are less than average limit, so not need to evaluate the average.



Standard:	FCC Part 15.247	Test Distance:	3m
Test item:	Harmonic	Power:	DC 5V
Frequency:	2462MHz	Temp.(°C)/Hum.(%RH):	26(°C)/60%RH
Mode:	Mode 3	Date:	07/12/2017
Ant.Polar.:	Vertical		
Description:	Antenna Model : EDA-1713-25GC1-A14		

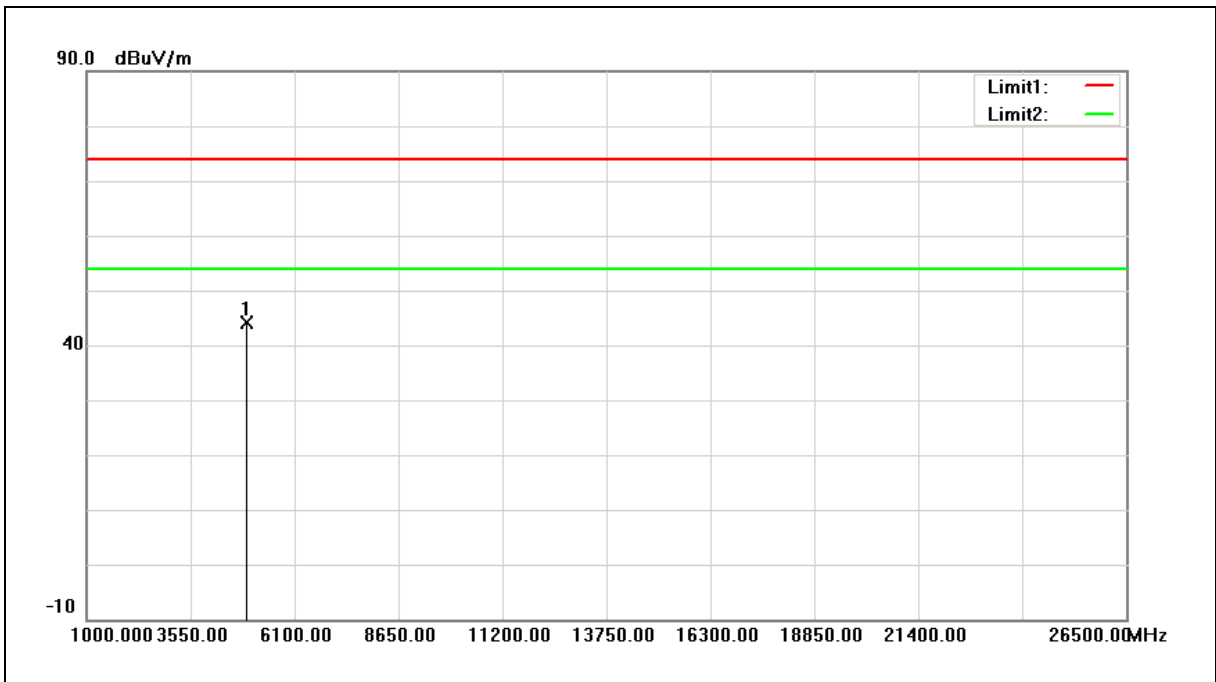

No.	Frequency (MHz)	Reading (dBuV)	Correct Factor (dB/m)	Result (dBuV/m)	Limit (dBuV/m)	Margin (dB)	Remark
1	4924.000	50.25	-6.08	44.17	74.00	-29.83	peak

Note:1.Result (dBuV/m) = Correct Factor (dB/m) + Reading(dBuV).

2.Correction factor (dB/m) = Antenna Factor (dB/m) + Cable loss (dB) – Pre-Amplifier gain (dB).

3. When the peak results are less than average limit, so not need to evaluate the average.



Standard:	FCC Part 15.247	Test Distance:	3m
Test item:	Harmonic	Power:	DC 5V
Frequency:	2412MHz	Temp.(°C)/Hum.(%RH):	26(°C)/60%RH
Mode:	Mode 4	Date:	07/12/2017
Ant.Polar.:	Horizontal		
Description:	Antenna Model : EDA-1713-25GC1-A14		

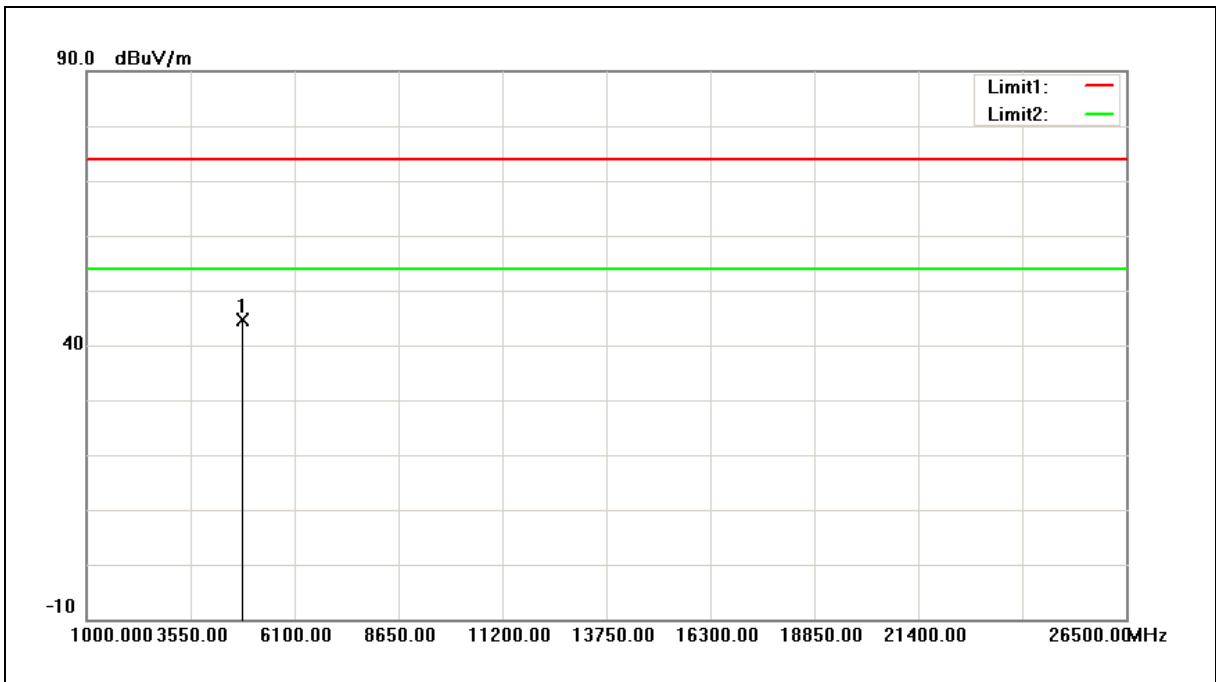

No.	Frequency (MHz)	Reading (dBuV)	Correct Factor (dB/m)	Result (dBuV/m)	Limit (dBuV/m)	Margin (dB)	Remark
1	4824.000	50.98	-6.44	44.54	74.00	-29.46	peak

Note:1.Result (dBuV/m) = Correct Factor (dB/m) + Reading(dBuV).

2.Correction factor (dB/m) = Antenna Factor (dB/m) + Cable loss (dB) – Pre-Amplifier gain (dB).

3. When the peak results are less than average limit, so not need to evaluate the average.



Standard:	FCC Part 15.247	Test Distance:	3m
Test item:	Harmonic	Power:	DC 5V
Frequency:	2412MHz	Temp.(°C)/Hum.(%RH):	26(°C)/60%RH
Mode:	Mode 4	Date:	07/12/2017
Ant.Polar.:	Vertical		
Description:	Antenna Model : EDA-1713-25GC1-A14		

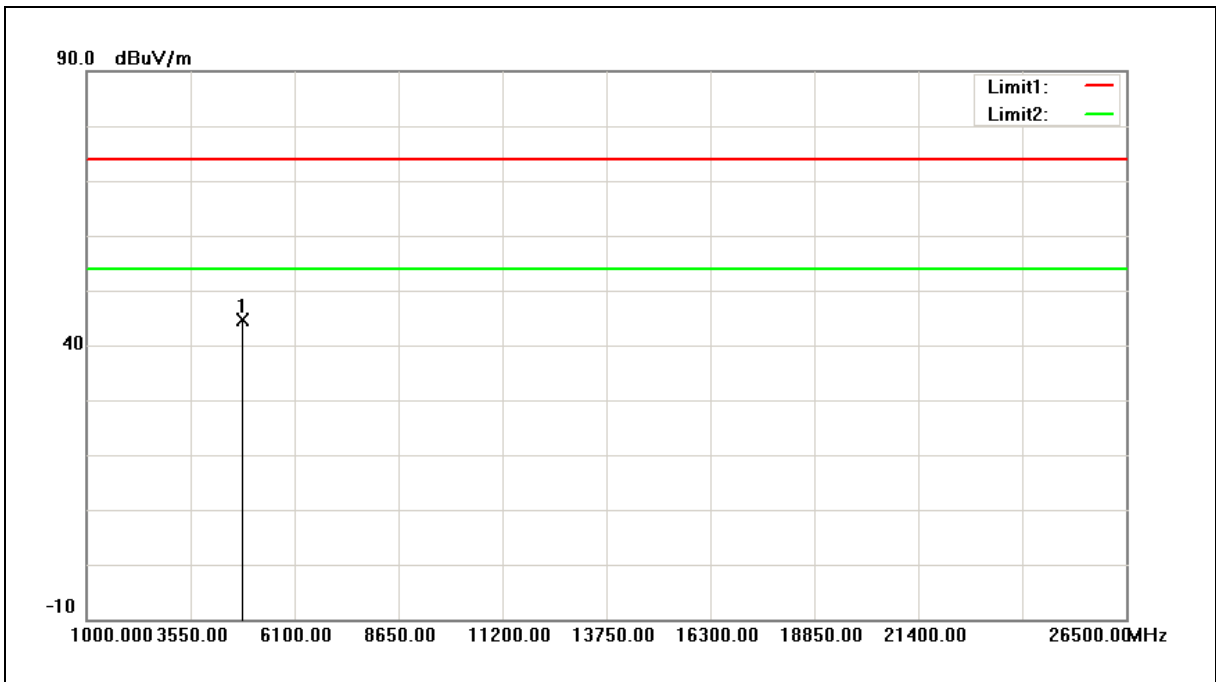

No.	Frequency (MHz)	Reading (dBuV)	Correct Factor (dB/m)	Result (dBuV/m)	Limit (dBuV/m)	Margin (dB)	Remark
1	4824.000	51.18	-6.44	44.74	74.00	-29.26	peak

Note:1.Result (dBuV/m) = Correct Factor (dB/m) + Reading(dBuV).

2.Correction factor (dB/m) = Antenna Factor (dB/m) + Cable loss (dB) – Pre-Amplifier gain (dB).

3. When the peak results are less than average limit, so not need to evaluate the average.



Standard:	FCC Part 15.247	Test Distance:	3m
Test item:	Harmonic	Power:	DC 5V
Frequency:	2437MHz	Temp.(°C)/Hum.(%RH):	26(°C)/60%RH
Mode:	Mode 4	Date:	07/12/2017
Ant.Polar.:	Horizontal		
Description:	Antenna Model : EDA-1713-25GC1-A14		

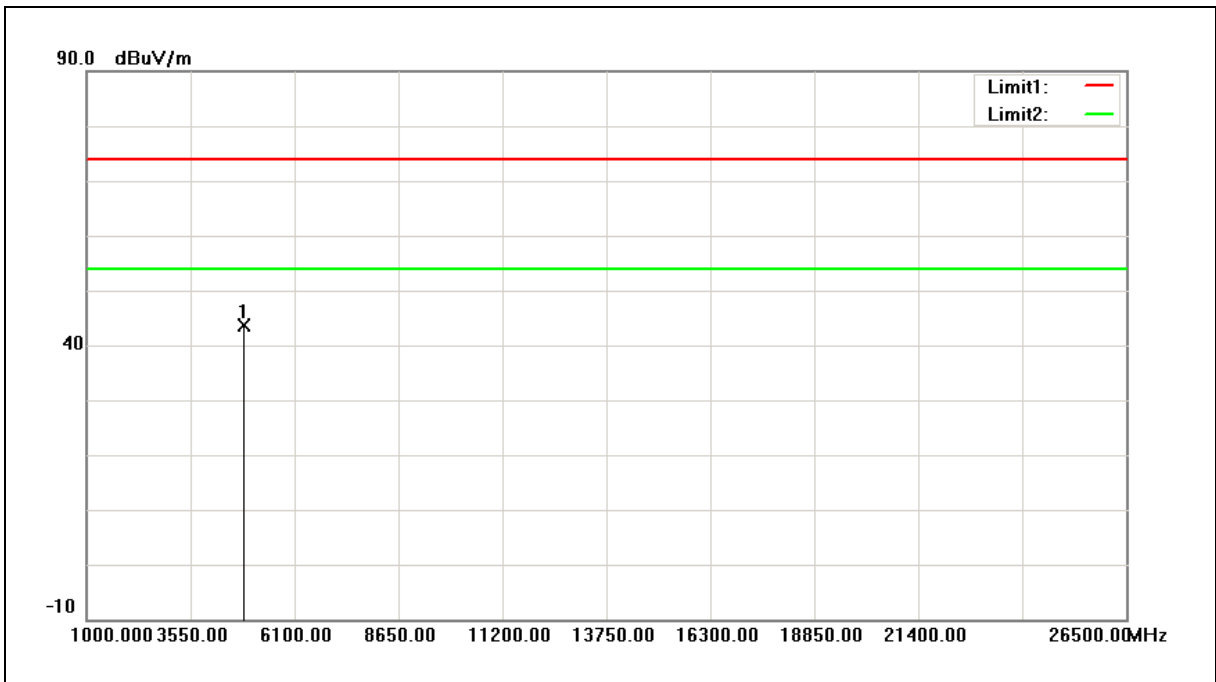

No.	Frequency (MHz)	Reading (dBuV)	Correct Factor (dB/m)	Result (dBuV/m)	Limit (dBuV/m)	Margin (dB)	Remark
1	4874.000	49.99	-6.26	43.73	74.00	-30.27	peak

Note:1.Result (dBuV/m) = Correct Factor (dB/m) + Reading(dBuV).

2.Correction factor (dB/m) = Antenna Factor (dB/m) + Cable loss (dB) – Pre-Amplifier gain (dB).

3. When the peak results are less than average limit, so not need to evaluate the average.



Standard:	FCC Part 15.247	Test Distance:	3m
Test item:	Harmonic	Power:	DC 5V
Frequency:	2437MHz	Temp.(°C)/Hum.(%RH):	26(°C)/60%RH
Mode:	Mode 4	Date:	07/12/2017
Ant.Polar.:	Vertical		
Description:	Antenna Model : EDA-1713-25GC1-A14		

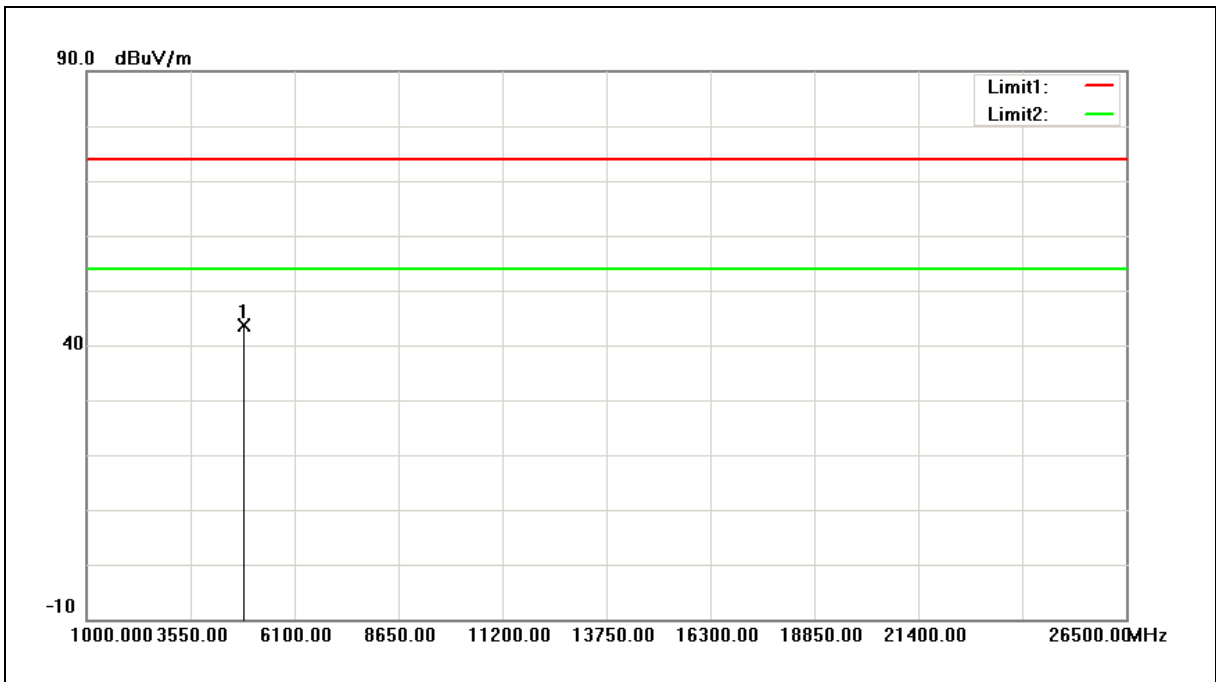

No.	Frequency (MHz)	Reading (dBuV)	Correct Factor (dB/m)	Result (dBuV/m)	Limit (dBuV/m)	Margin (dB)	Remark
1	4874.000	49.95	-6.26	43.69	74.00	-30.31	peak

Note:1.Result (dBuV/m) = Correct Factor (dB/m) + Reading(dBuV).

2.Correction factor (dB/m) = Antenna Factor (dB/m) + Cable loss (dB) – Pre-Amplifier gain (dB).

3. When the peak results are less than average limit, so not need to evaluate the average.



Standard:	FCC Part 15.247	Test Distance:	3m
Test item:	Harmonic	Power:	DC 5V
Frequency:	2462MHz	Temp.(°C)/Hum.(%RH):	26(°C)/60%RH
Mode:	Mode 4	Date:	07/12/2017
Ant.Polar.:	Horizontal		
Description:	Antenna Model : EDA-1713-25GC1-A14		

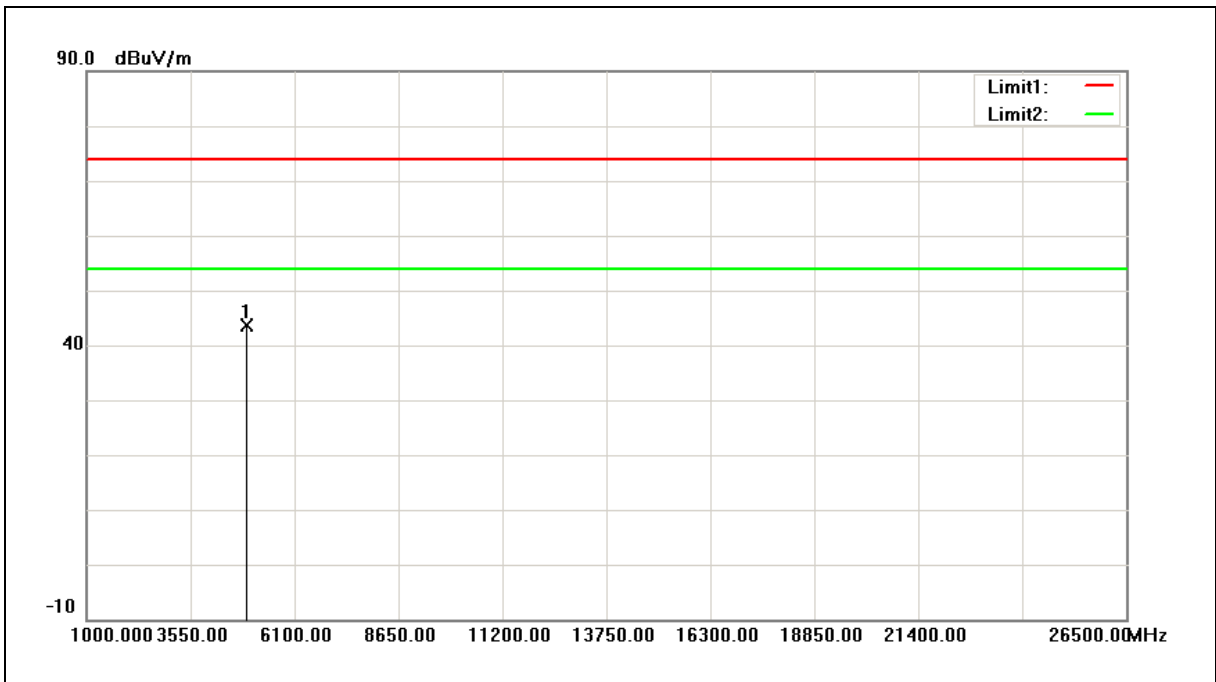

No.	Frequency (MHz)	Reading (dBuV)	Correct Factor (dB/m)	Result (dBuV/m)	Limit (dBuV/m)	Margin (dB)	Remark
1	4924.000	49.61	-6.08	43.53	74.00	-30.47	peak

- Note:1.Result (dBuV/m) = Correct Factor (dB/m) + Reading(dBuV).
- 2.Correction factor (dB/m) = Antenna Factor (dB/m) + Cable loss (dB) – Pre-Amplifier gain (dB).
3. When the peak results are less than average limit, so not need to evaluate the average.



Standard:	FCC Part 15.247	Test Distance:	3m
Test item:	Harmonic	Power:	DC 5V
Frequency:	2462MHz	Temp.(°C)/Hum.(%RH):	26(°C)/60%RH
Mode:	Mode 4	Date:	07/12/2017
Ant.Polar.:	Vertical		
Description:	Antenna Model : EDA-1713-25GC1-A14		

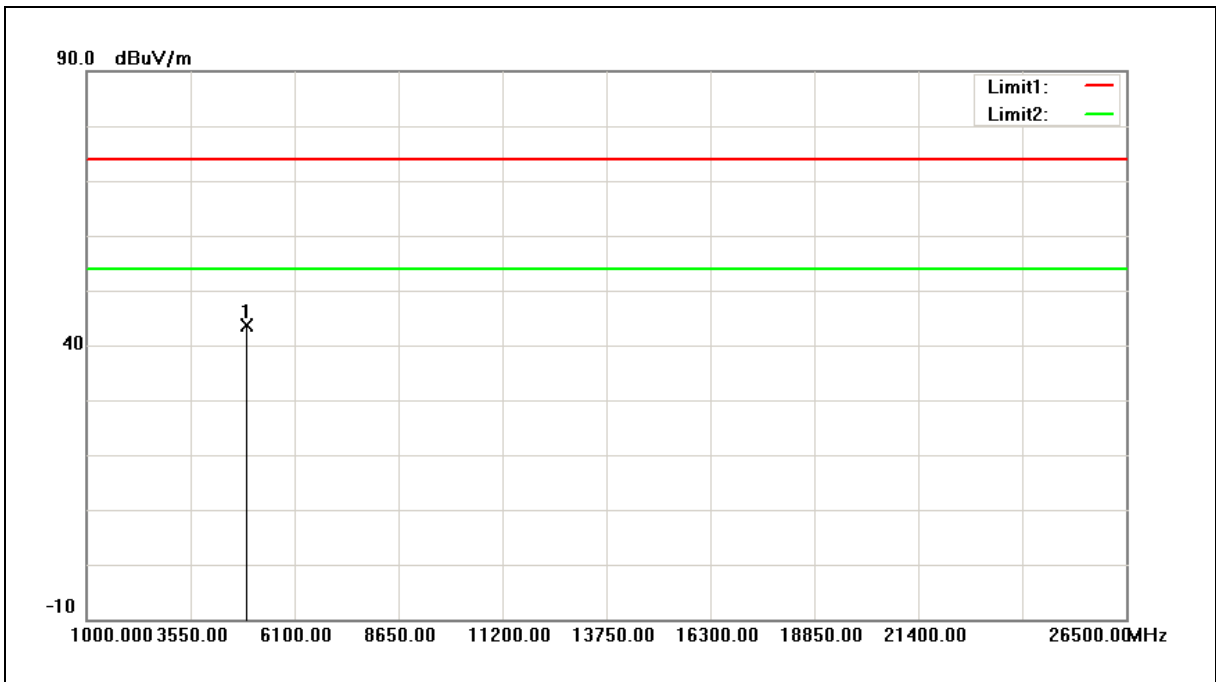

No.	Frequency (MHz)	Reading (dBuV)	Correct Factor (dB/m)	Result (dBuV/m)	Limit (dBuV/m)	Margin (dB)	Remark
1	4924.000	49.65	-6.08	43.57	74.00	-30.43	peak

- Note:1.Result (dBuV/m) = Correct Factor (dB/m) + Reading(dBuV).
 2.Correction factor (dB/m) = Antenna Factor (dB/m) + Cable loss (dB) – Pre-Amplifier gain (dB).
 3. When the peak results are less than average limit, so not need to evaluate the average.



Standard:	FCC Part 15.247	Test Distance:	3m
Test item:	Harmonic	Power:	DC 5V
Frequency:	2422MHz	Temp.(°C)/Hum.(%RH):	26(°C)/60%RH
Mode:	Mode 5	Date:	07/12/2017
Ant.Polar.:	Horizontal		
Description:	Antenna Model : EDA-1713-25GC1-A14		

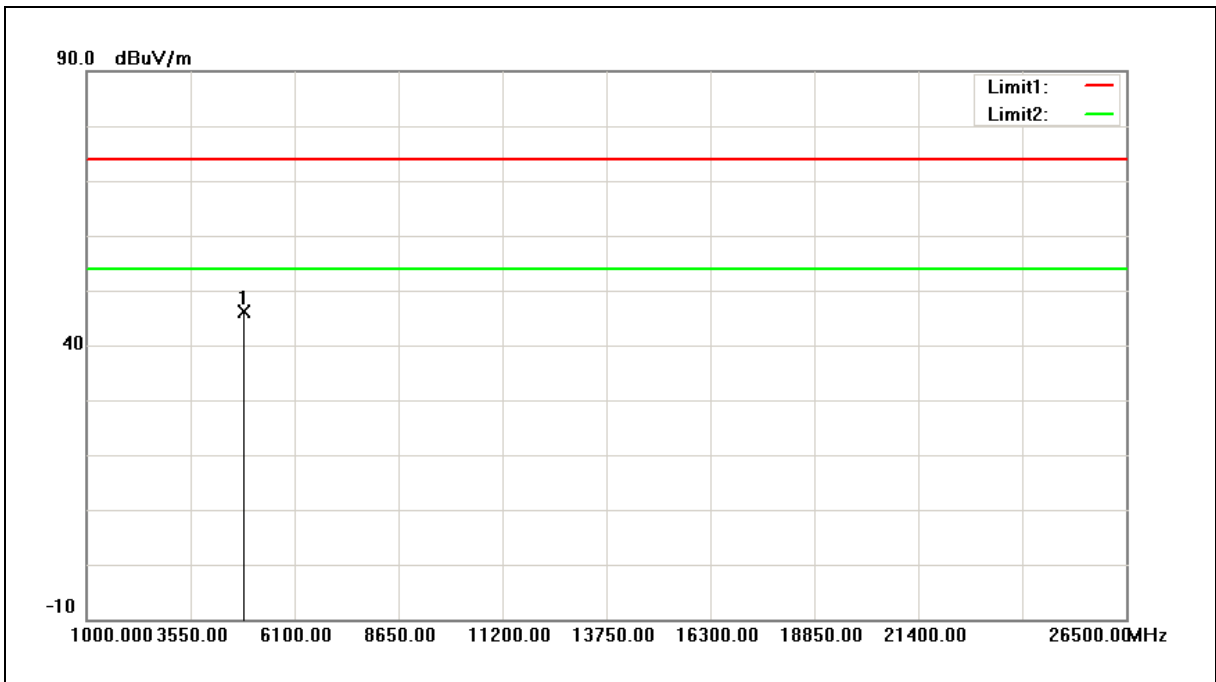

No.	Frequency (MHz)	Reading (dBuV)	Correct Factor (dB/m)	Result (dBuV/m)	Limit (dBuV/m)	Margin (dB)	Remark
1	4844.000	52.44	-6.36	46.08	74.00	-27.92	peak

Note:1.Result (dBuV/m) = Correct Factor (dB/m) + Reading(dBuV).

2.Correction factor (dB/m) = Antenna Factor (dB/m) + Cable loss (dB) – Pre-Amplifier gain (dB).

3. When the peak results are less than average limit, so not need to evaluate the average.



Standard:	FCC Part 15.247	Test Distance:	3m
Test item:	Harmonic	Power:	DC 5V
Frequency:	2422MHz	Temp.(°C)/Hum.(%RH):	26(°C)/60%RH
Mode:	Mode 5	Date:	07/12/2017
Ant.Polar.:	Vertical		
Description:	Antenna Model : EDA-1713-25GC1-A14		

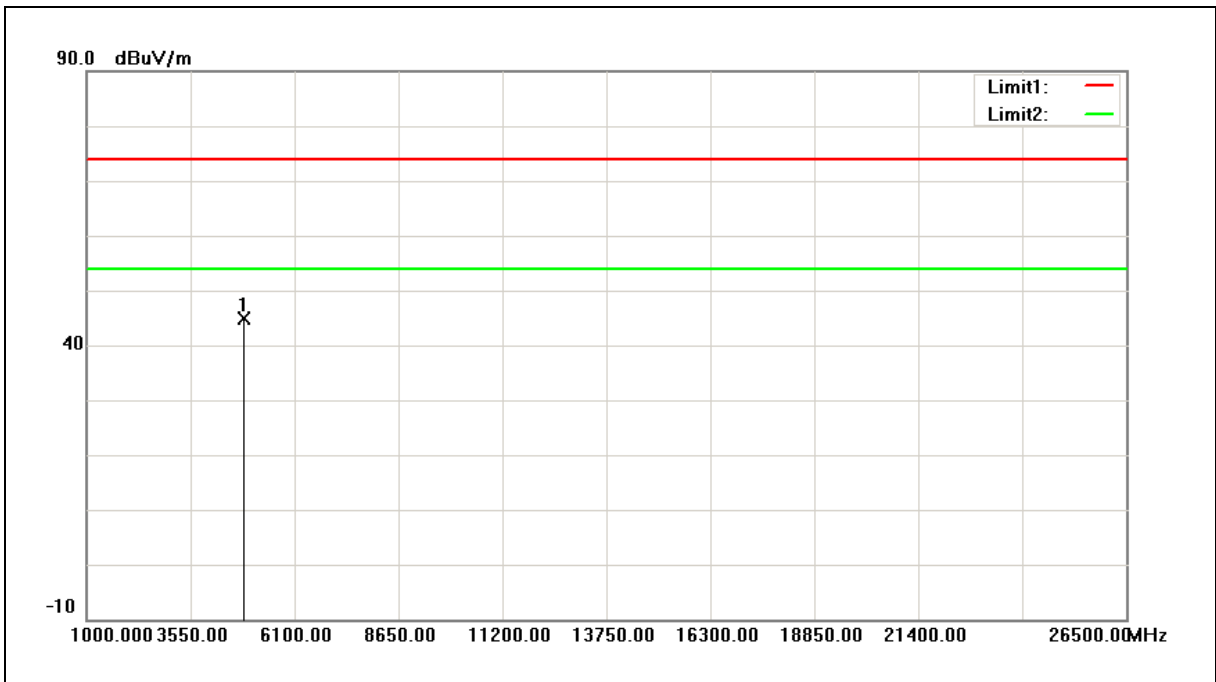

No.	Frequency (MHz)	Reading (dBuV)	Correct Factor (dB/m)	Result (dBuV/m)	Limit (dBuV/m)	Margin (dB)	Remark
1	4844.000	51.25	-6.36	44.89	74.00	-29.11	peak

Note:1.Result (dBuV/m) = Correct Factor (dB/m) + Reading(dBuV).

2.Correction factor (dB/m) = Antenna Factor (dB/m) + Cable loss (dB) – Pre-Amplifier gain (dB).

3. When the peak results are less than average limit, so not need to evaluate the average.



Standard:	FCC Part 15.247	Test Distance:	3m
Test item:	Harmonic	Power:	DC 5V
Frequency:	2437MHz	Temp.(°C)/Hum.(%RH):	26(°C)/60%RH
Mode:	Mode 5	Date:	07/12/2017
Ant.Polar.:	Horizontal		
Description:	Antenna Model : EDA-1713-25GC1-A14		

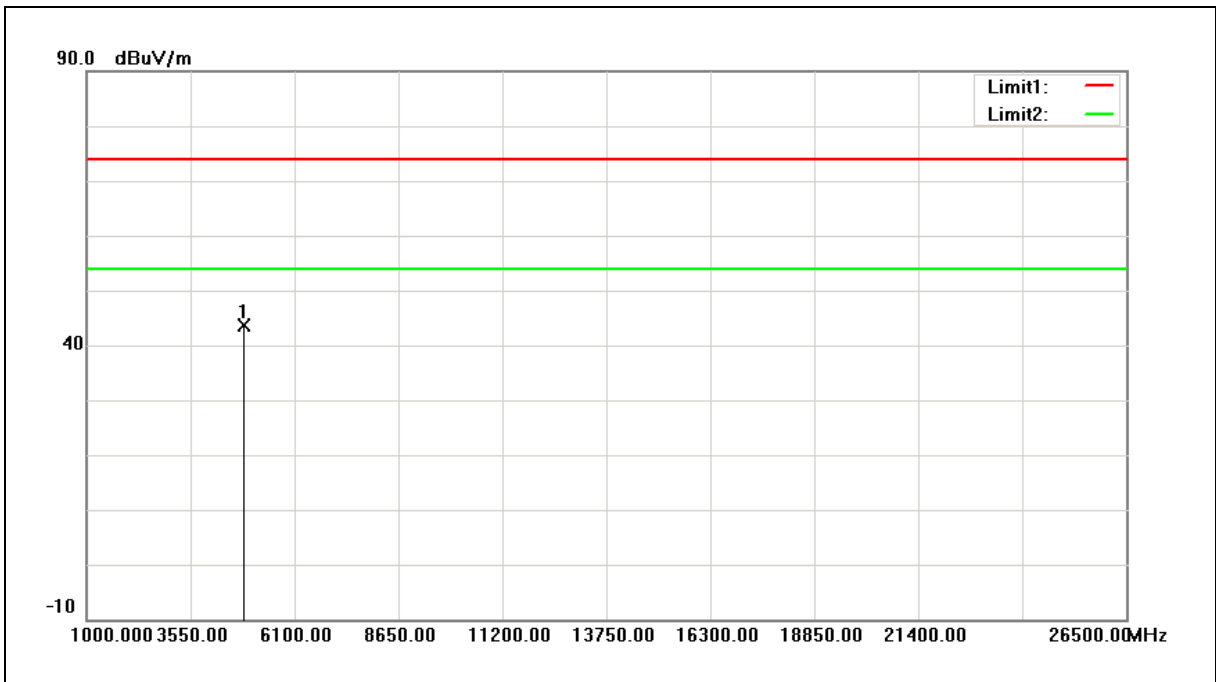

No.	Frequency (MHz)	Reading (dBuV)	Correct Factor (dB/m)	Result (dBuV/m)	Limit (dBuV/m)	Margin (dB)	Remark
1	4874.000	49.89	-6.26	43.63	74.00	-30.37	peak

Note:1.Result (dBuV/m) = Correct Factor (dB/m) + Reading(dBuV).

2.Correction factor (dB/m) = Antenna Factor (dB/m) + Cable loss (dB) – Pre-Amplifier gain (dB).

3. When the peak results are less than average limit, so not need to evaluate the average.



Standard:	FCC Part 15.247	Test Distance:	3m
Test item:	Harmonic	Power:	DC 5V
Frequency:	2437MHz	Temp.(°C)/Hum.(%RH):	26(°C)/60%RH
Mode:	Mode 5	Date:	07/12/2017
Ant.Polar.:	Vertical		
Description:	Antenna Model : EDA-1713-25GC1-A14		

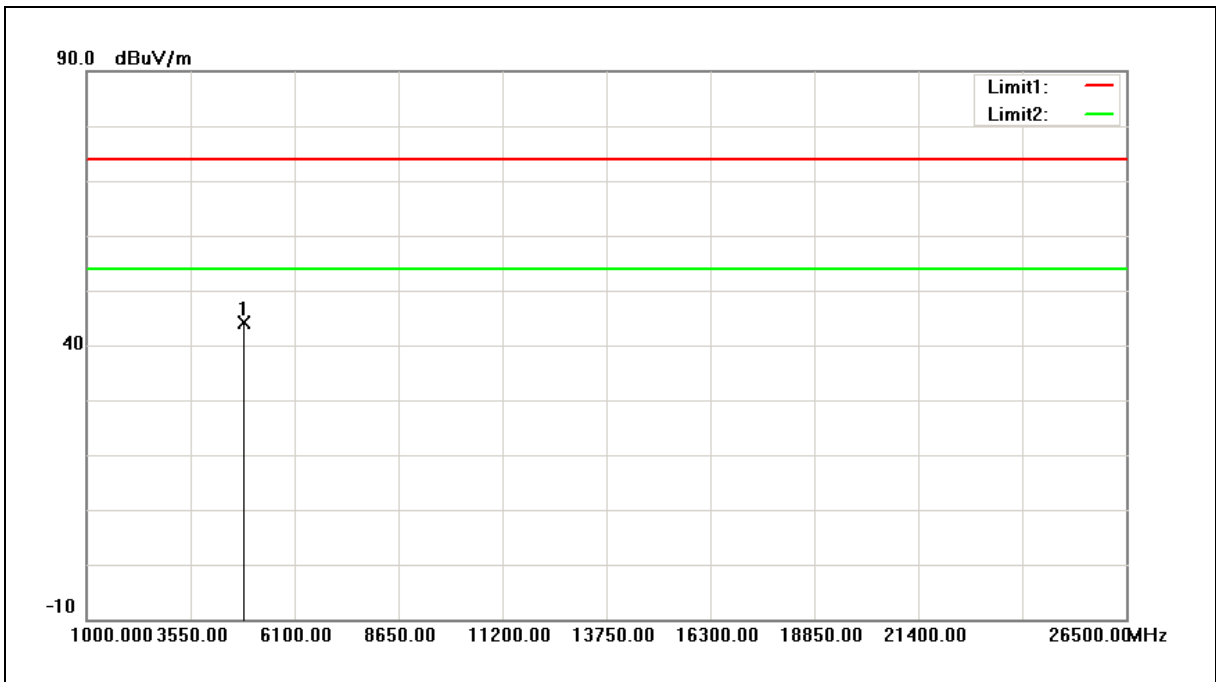

No.	Frequency (MHz)	Reading (dBuV)	Correct Factor (dB/m)	Result (dBuV/m)	Limit (dBuV/m)	Margin (dB)	Remark
1	4874.000	50.40	-6.26	44.14	74.00	-29.86	peak

Note:1.Result (dBuV/m) = Correct Factor (dB/m) + Reading(dBuV).

2.Correction factor (dB/m) = Antenna Factor (dB/m) + Cable loss (dB) – Pre-Amplifier gain (dB).

3. When the peak results are less than average limit, so not need to evaluate the average.



Standard:	FCC Part 15.247	Test Distance:	3m
Test item:	Harmonic	Power:	DC 5V
Frequency:	2452MHz	Temp.(°C)/Hum.(%RH):	26(°C)/60%RH
Mode:	Mode 5	Date:	07/12/2017
Ant.Polar.:	Horizontal		
Description:	Antenna Model : EDA-1713-25GC1-A14		

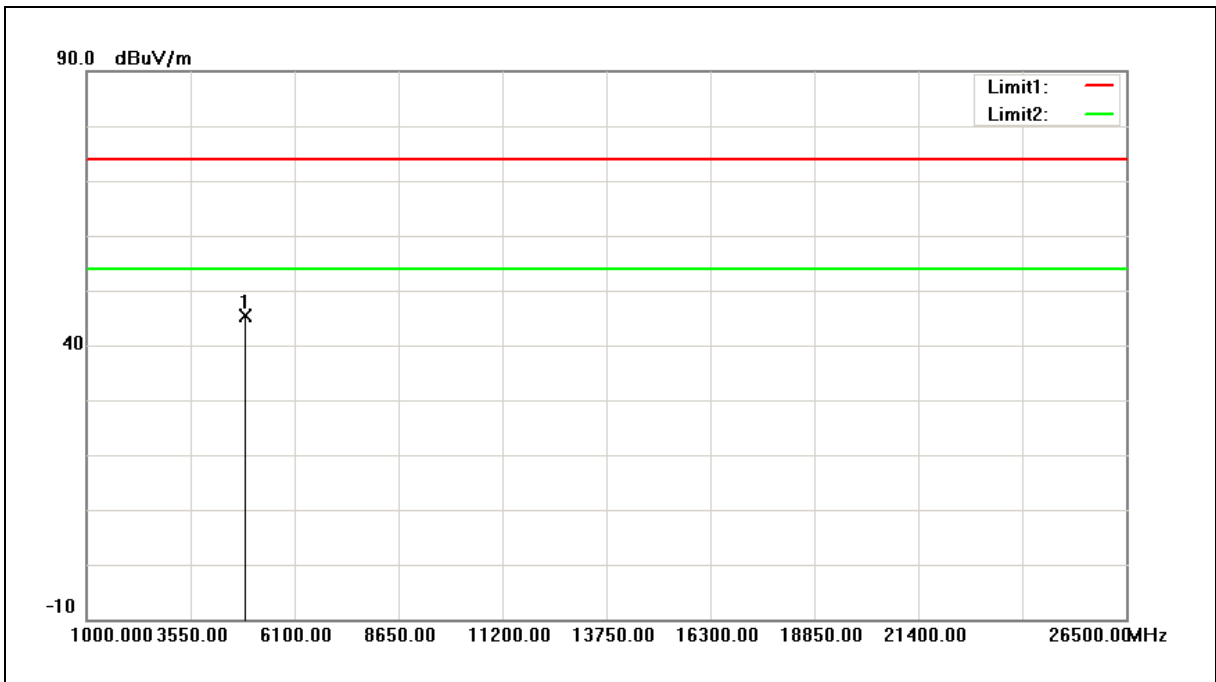

No.	Frequency (MHz)	Reading (dBuV)	Correct Factor (dB/m)	Result (dBuV/m)	Limit (dBuV/m)	Margin (dB)	Remark
1	4904.000	51.48	-6.15	45.33	74.00	-28.67	peak

Note:1.Result (dBuV/m) = Correct Factor (dB/m) + Reading(dBuV).

2.Correction factor (dB/m) = Antenna Factor (dB/m) + Cable loss (dB) – Pre-Amplifier gain (dB).

3. When the peak results are less than average limit, so not need to evaluate the average.



Standard:	FCC Part 15.247	Test Distance:	3m
Test item:	Harmonic	Power:	DC 5V
Frequency:	2452MHz	Temp.(°C)/Hum.(%RH):	26(°C)/60%RH
Mode:	Mode 5	Date:	07/12/2017
Ant.Polar.:	Vertical		
Description:	Antenna Model : EDA-1713-25GC1-A14		

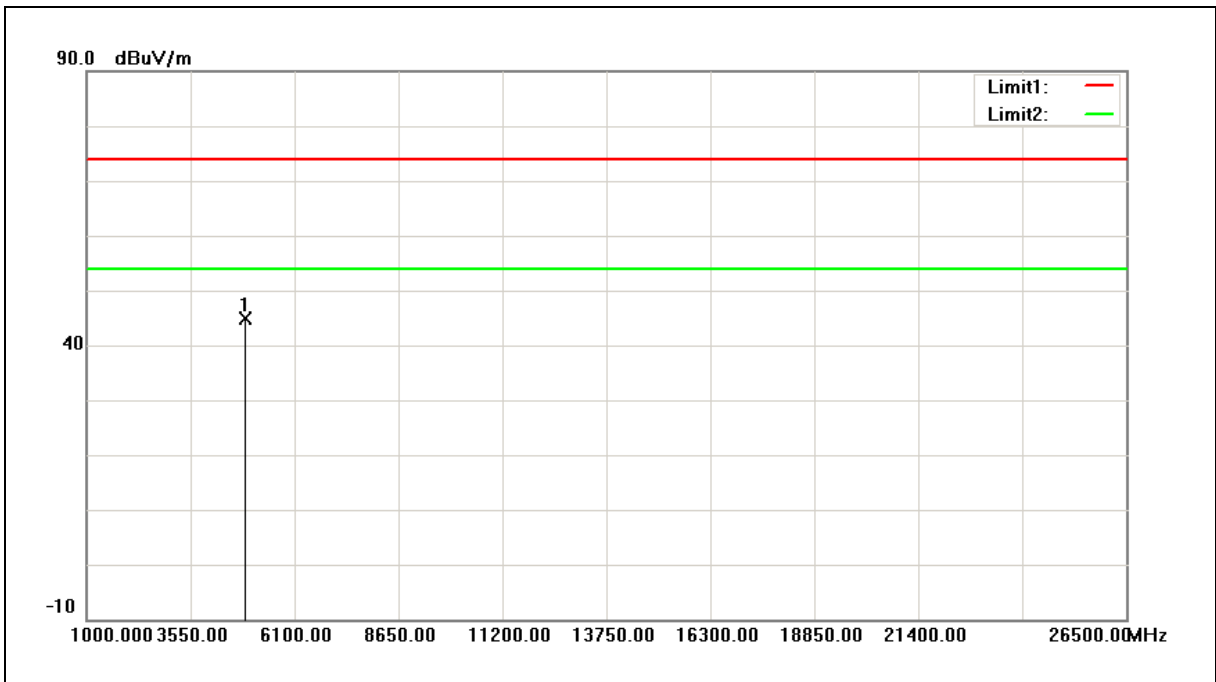

No.	Frequency (MHz)	Reading (dBuV)	Correct Factor (dB/m)	Result (dBuV/m)	Limit (dBuV/m)	Margin (dB)	Remark
1	4904.000	51.12	-6.15	44.97	74.00	-29.03	peak

Note:1.Result (dBuV/m) = Correct Factor (dB/m) + Reading(dBuV).

2.Correction factor (dB/m) = Antenna Factor (dB/m) + Cable loss (dB) – Pre-Amplifier gain (dB).

3. When the peak results are less than average limit, so not need to evaluate the average.



Standard:	FCC Part 15.407	Test Distance:	3m
Test item:	Transmitter Unwanted Emissions	Power:	DC 5V
Test Mode:	Simultaneous Transmitting (DTS+NII)	Temp.(°C)/Hum.(%RH):	26(°C)/60%RH
Ant.Polar.:	Horizontal	Date:	07/18/2017
Description:	Antenna Model : EDA-1713-25GC1-A14		

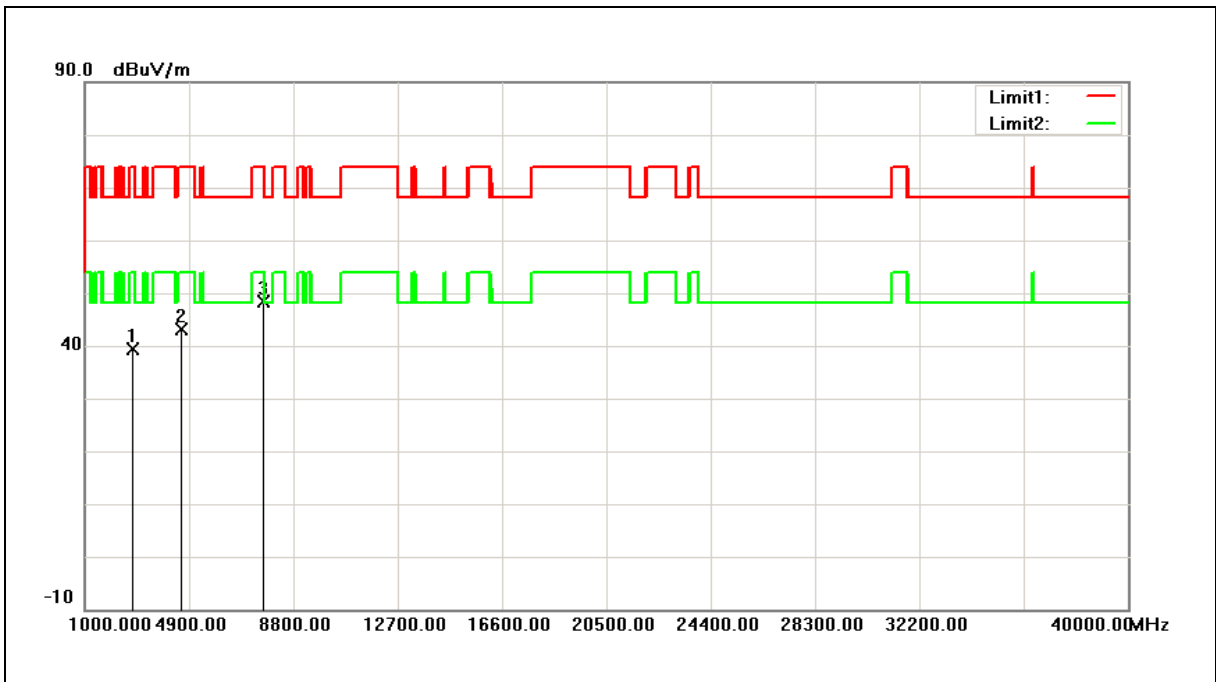

No.	Frequency (MHz)	Reading (dBuV)	Correct Factor (dB/m)	Result (dBuV/m)	Limit (dBuV/m)	Margin (dB)	Remark
1	2785.000	51.71	-12.37	39.34	74.00	-34.66	peak
2	4638.000	50.12	-7.09	43.03	74.00	-30.97	peak
3	7647.000	46.54	1.76	48.30	74.00	-25.70	peak

Note:1.Result (dBuV/m) = Correct Factor (dB/m) + Reading(dBuV).

2.Correction factor (dB/m) = Antenna Factor (dB/m) + Cable loss (dB) – Pre-Amplifier gain (dB).

3. When the peak results are less than average limit, so not need to evaluate the average.



Standard:	FCC Part 15.407	Test Distance:	3m
Test item:	Transmitter Unwanted Emissions	Power:	DC 5V
Test Mode:	Simultaneous Transmitting (DTS+NII)	Temp.(°C)/Hum.(%RH):	26(°C)/60%RH
Ant.Polar.:	Vertical	Date:	07/18/2017
Description:	Antenna Model : EDA-1713-25GC1-A14		

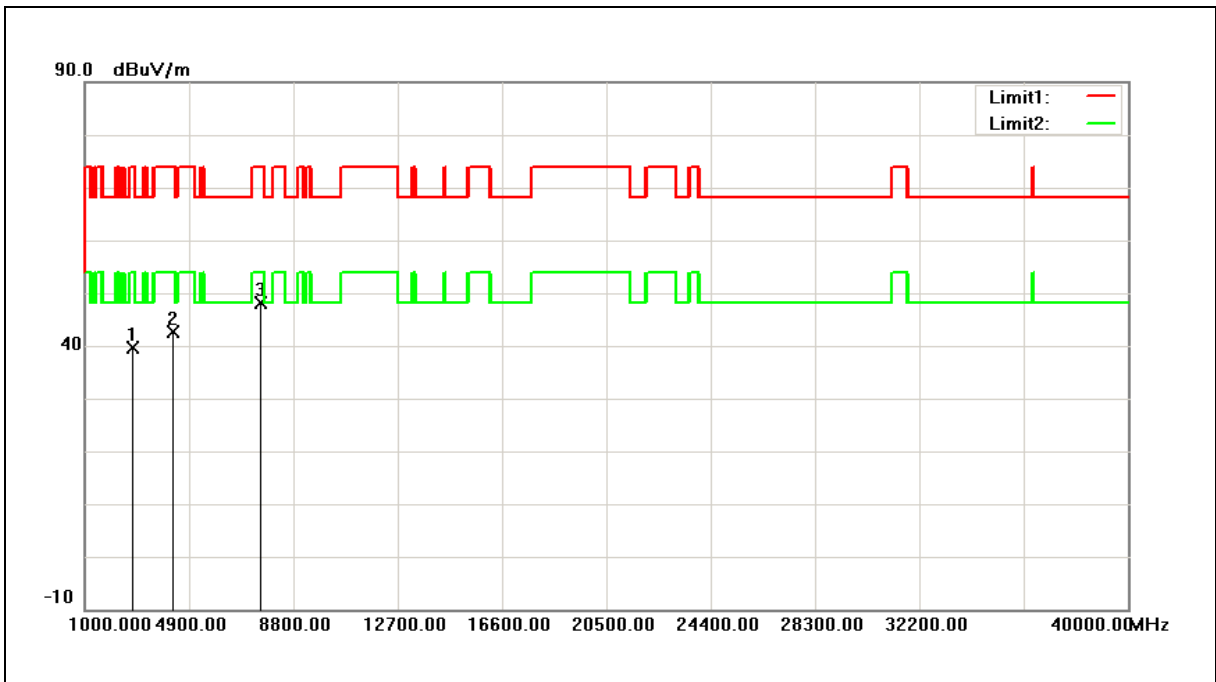

No.	Frequency (MHz)	Reading (dBuV)	Correct Factor (dB/m)	Result (dBuV/m)	Limit (dBuV/m)	Margin (dB)	Remark
1	2785.000	51.91	-12.37	39.54	74.00	-34.46	peak
2	4247.000	50.84	-8.14	42.70	74.00	-31.30	peak
3	7562.000	46.67	1.52	48.19	74.00	-25.81	peak

Note:1.Result (dBuV/m) = Correct Factor (dB/m) + Reading(dBuV).

2.Correction factor (dB/m) = Antenna Factor (dB/m) + Cable loss (dB) – Pre-Amplifier gain (dB).

3. When the peak results are less than average limit, so not need to evaluate the average.



Band Edge

Standard:	FCC Part 15.247	Test Distance:	3m
Test item:	Band edge	Power:	DC 5V
Frequency:	2412MHz	Temp.(°C)/Hum.(%RH):	26(°C)/60%RH
Mode:	Mode 2	Date:	07/19/2017
Ant.Polar.:	Horizontal		
Description:	Antenna Model : MSA-3310-25GC4-A25 / MSA-3310-25GC4-A26		

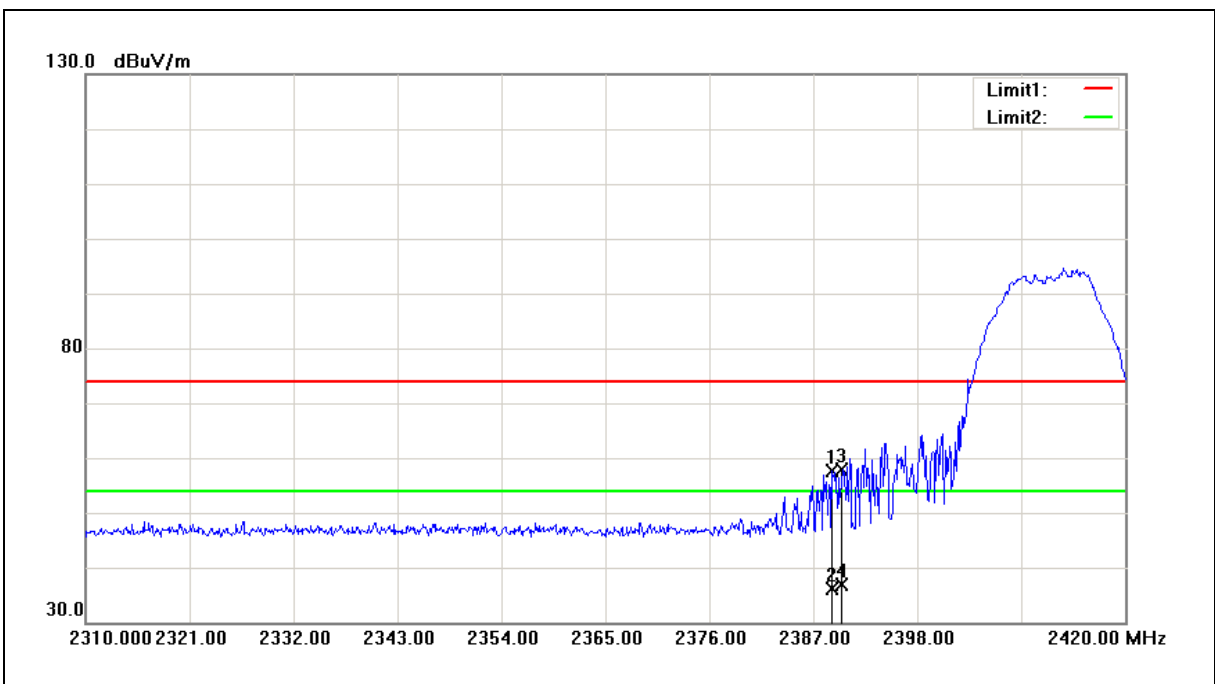

No.	Frequency (MHz)	Reading (dBuV)	Correct Factor (dB/m)	Result (dBuV/m)	Limit (dBuV/m)	Margin (dB)	Remark
1	2388.980	57.41	0.15	57.56	74.00	-16.44	peak
2	2388.980	36.08	0.15	36.23	54.00	-17.77	AVG
3	2390.000	57.84	0.15	57.99	74.00	-16.01	peak
4	2390.000	36.63	0.15	36.78	54.00	-17.22	AVG

Note:1.Result (dBuV/m) = Correct Factor (dB/m) + Reading(dBuV).

2.Correction factor (dB/m) = Antenna Factor (dB/m) + Cable loss (dB) – Pre-Amplifier gain (dB).

3. When the peak results are less than average limit, so not need to evaluate the average.



Standard:	FCC Part 15.247	Test Distance:	3m
Test item:	Band edge	Power:	DC 5V
Frequency:	2412MHz	Temp.(°C)/Hum.(%RH):	26(°C)/60%RH
Mode:	Mode 2	Date:	07/19/2017
Ant.Polar.:	Vertical		
Description:	Antenna Model : MSA-3310-25GC4-A25 / MSA-3310-25GC4-A26		

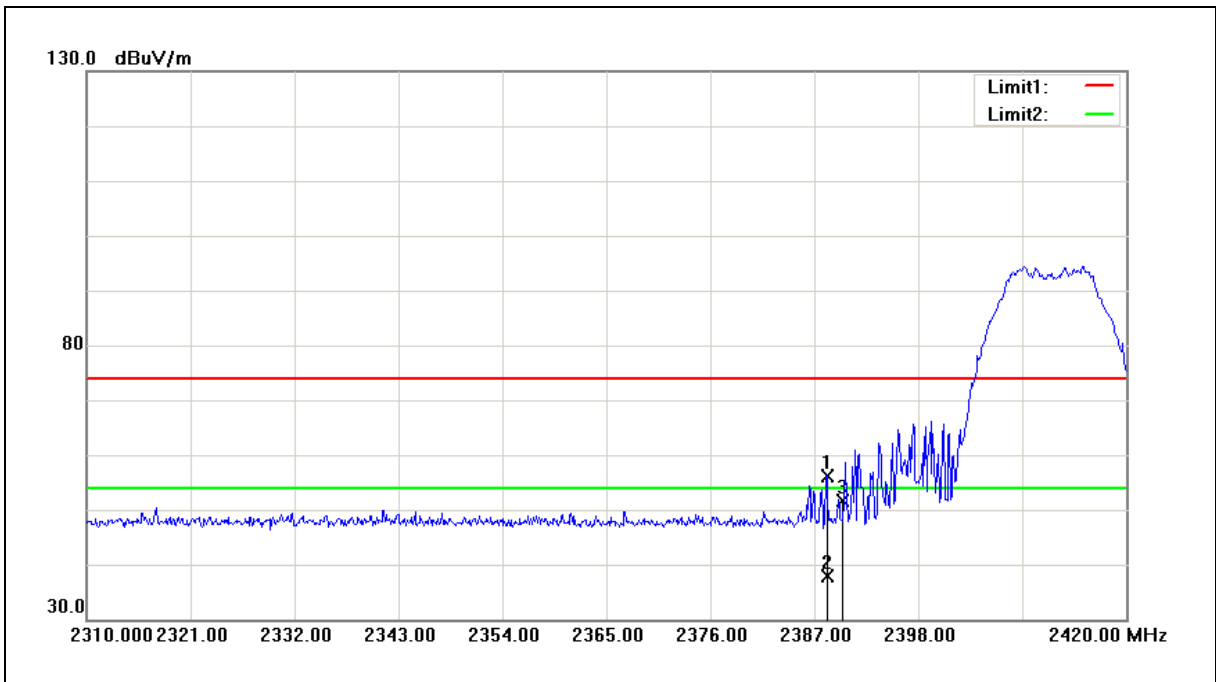

No.	Frequency (MHz)	Reading (dBuV)	Correct Factor (dB/m)	Result (dBuV/m)	Limit (dBuV/m)	Margin (dB)	Remark
1	2388.320	56.02	0.15	56.17	74.00	-17.83	peak
2	2388.320	37.68	0.15	37.83	54.00	-16.17	AVG
3	2390.000	51.47	0.15	51.62	74.00	-22.38	peak

- Note:1.Result (dBuV/m) = Correct Factor (dB/m) + Reading(dBuV).
- 2.Correction factor (dB/m) = Antenna Factor (dB/m) + Cable loss (dB) – Pre-Amplifier gain (dB).
3. When the peak results are less than average limit, so not need to evaluate the average.



Standard:	FCC Part 15.247	Test Distance:	3m
Test item:	Band edge	Power:	DC 5V
Frequency:	2437MHz	Temp.(°C)/Hum.(%RH):	26(°C)/60%RH
Mode:	Mode 2	Date:	07/19/2017
Ant.Polar.:	Horizontal		
Description:	Antenna Model : MSA-3310-25GC4-A25 / MSA-3310-25GC4-A26		

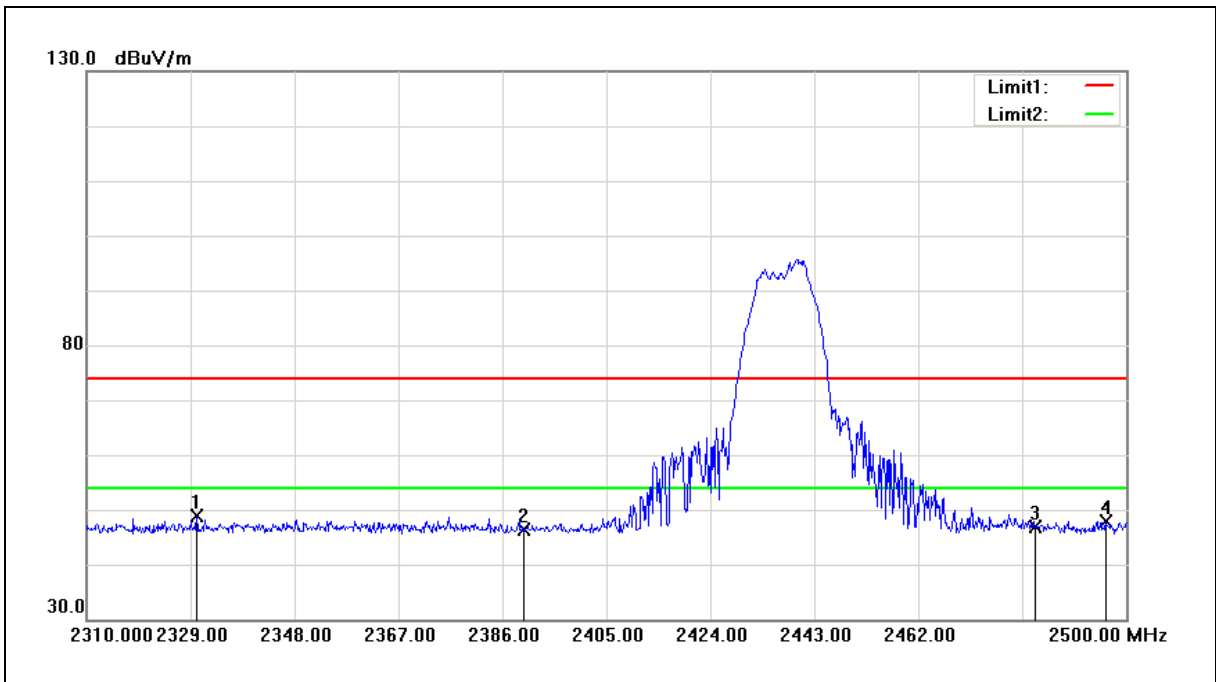

No.	Frequency (MHz)	Reading (dBuV)	Correct Factor (dB/m)	Result (dBuV/m)	Limit (dBuV/m)	Margin (dB)	Remark
1	2330.140	48.93	-0.10	48.83	74.00	-25.17	peak
2	2390.000	46.30	0.15	46.45	74.00	-27.55	peak
3	2483.500	46.42	0.55	46.97	74.00	-27.03	peak
4	2496.200	47.37	0.60	47.97	74.00	-26.03	peak

Note:1.Result (dBuV/m) = Correct Factor (dB/m) + Reading(dBuV).

2.Correction factor (dB/m) = Antenna Factor (dB/m) + Cable loss (dB) – Pre-Amplifier gain (dB).

3. When the peak results are less than average limit, so not need to evaluate the average.



Standard:	FCC Part 15.247	Test Distance:	3m
Test item:	Band edge	Power:	DC 5V
Frequency:	2437MHz	Temp.(°C)/Hum.(%RH):	26(°C)/60%RH
Mode:	Mode 2	Date:	07/19/2017
Ant.Polar.:	Vertical		
Description:	Antenna Model : MSA-3310-25GC4-A25 / MSA-3310-25GC4-A26		

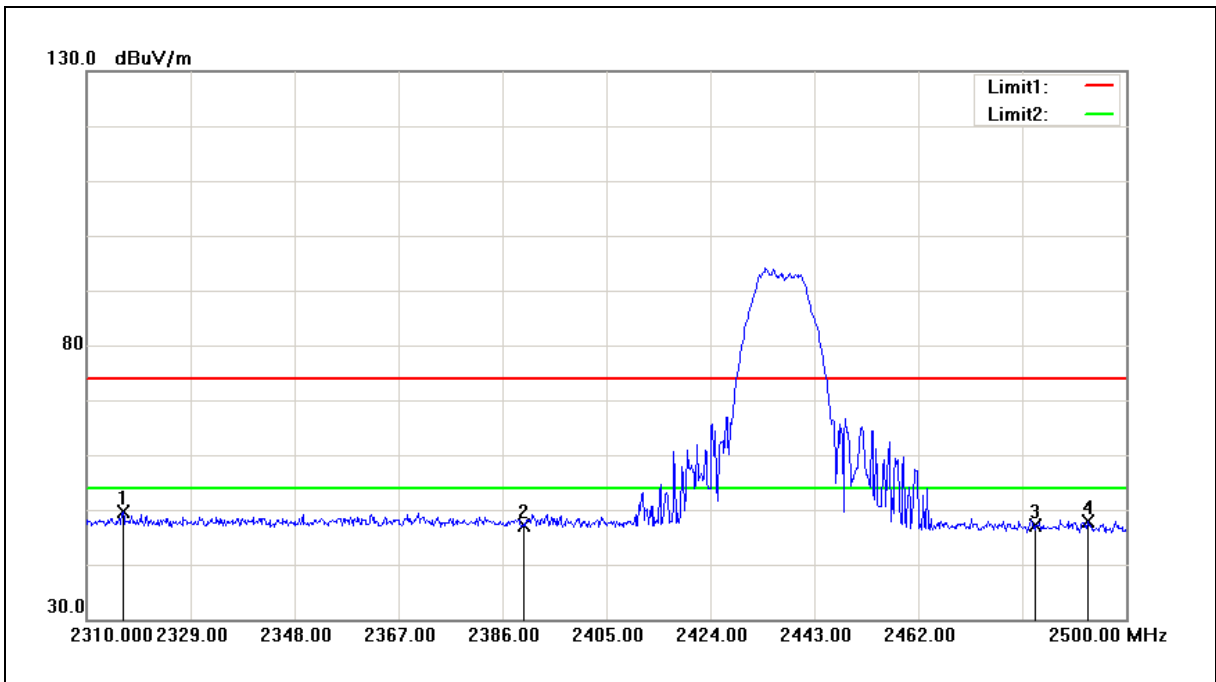

No.	Frequency (MHz)	Reading (dBuV)	Correct Factor (dB/m)	Result (dBuV/m)	Limit (dBuV/m)	Margin (dB)	Remark
1	2316.650	49.72	-0.15	49.57	74.00	-24.43	peak
2	2390.000	46.94	0.15	47.09	74.00	-26.91	peak
3	2483.500	46.62	0.55	47.17	74.00	-26.83	peak
4	2492.970	47.36	0.59	47.95	74.00	-26.05	peak

Note:1.Result (dBuV/m) = Correct Factor (dB/m) + Reading(dBuV).

2.Correction factor (dB/m) = Antenna Factor (dB/m) + Cable loss (dB) – Pre-Amplifier gain (dB).

3. When the peak results are less than average limit, so not need to evaluate the average.



Standard:	FCC Part 15.247	Test Distance:	3m
Test item:	Band edge	Power:	DC 5V
Frequency:	2462MHz	Temp.(°C)/Hum.(%RH):	26(°C)/60%RH
Mode:	Mode 2	Date:	07/19/2017
Ant.Polar.:	Horizontal		
Description:	Antenna Model : MSA-3310-25GC4-A25 / MSA-3310-25GC4-A26		

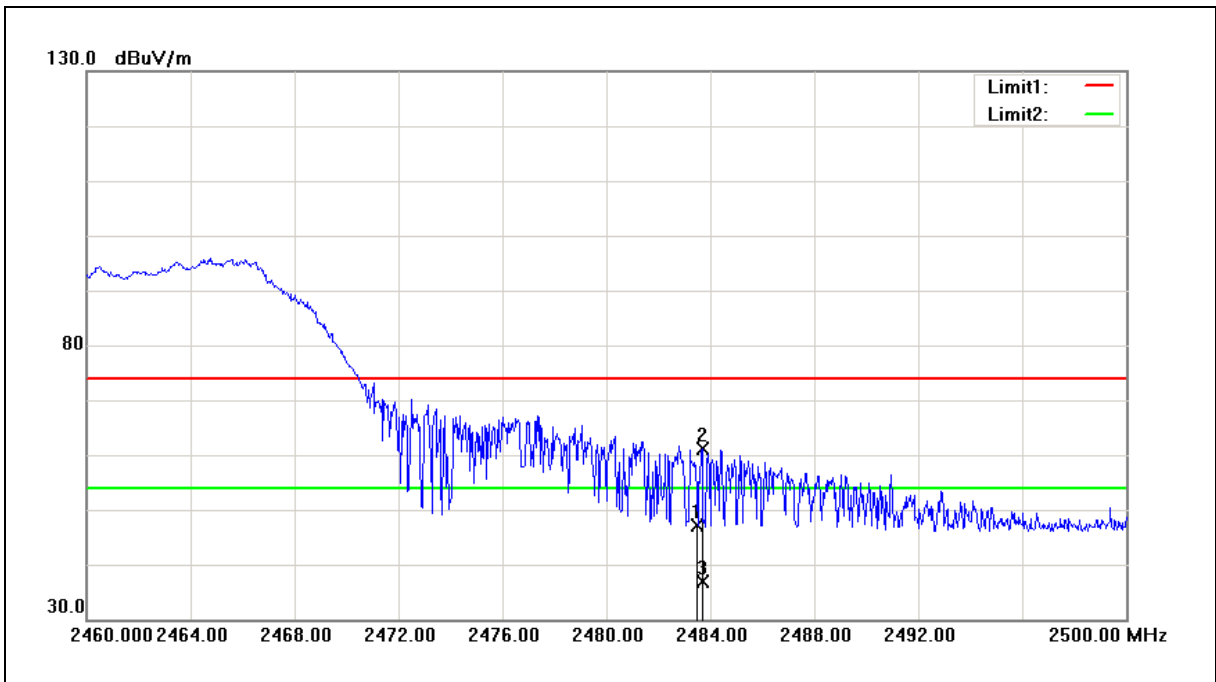

No.	Frequency (MHz)	Reading (dBuV)	Correct Factor (dB/m)	Result (dBuV/m)	Limit (dBuV/m)	Margin (dB)	Remark
1	2483.500	46.57	0.55	47.12	74.00	-26.88	peak
2	2483.680	60.50	0.55	61.05	74.00	-12.95	peak
3	2483.680	36.31	0.55	36.86	54.00	-17.14	AVG

Note:1.Result (dBuV/m) = Correct Factor (dB/m) + Reading(dBuV).

2.Correction factor (dB/m) = Antenna Factor (dB/m) + Cable loss (dB) – Pre-Amplifier gain (dB).

3. When the peak results are less than average limit, so not need to evaluate the average.



Standard:	FCC Part 15.247	Test Distance:	3m
Test item:	Band edge	Power:	DC 5V
Frequency:	2462MHz	Temp.(°C)/Hum.(%RH):	26(°C)/60%RH
Mode:	Mode 2	Date:	07/19/2017
Ant.Polar.:	Vertical		
Description:	Antenna Model : MSA-3310-25GC4-A25 / MSA-3310-25GC4-A26		

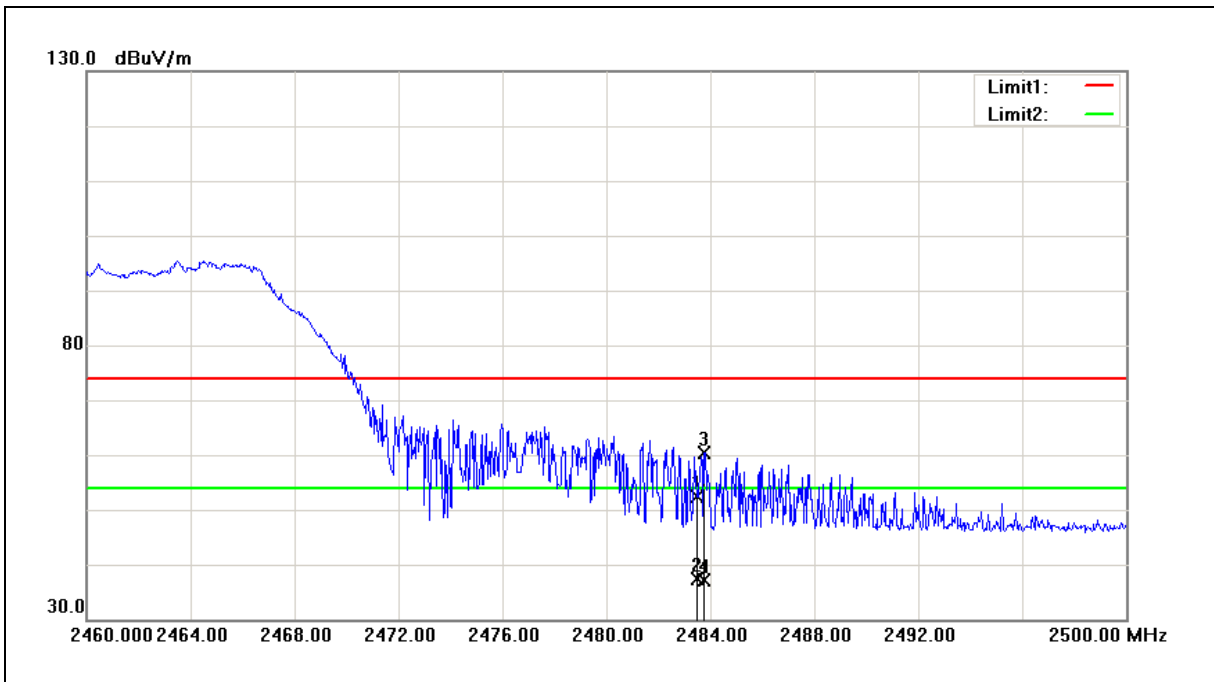

No.	Frequency (MHz)	Reading (dBuV)	Correct Factor (dB/m)	Result (dBuV/m)	Limit (dBuV/m)	Margin (dB)	Remark
1	2483.500	51.78	0.55	52.33	74.00	-21.67	peak
2	2483.500	36.74	0.55	37.29	54.00	-16.71	AVG
3	2483.760	59.91	0.55	60.46	74.00	-13.54	peak
4	2483.760	36.63	0.55	37.18	54.00	-16.82	AVG

Note:1.Result (dBuV/m) = Correct Factor (dB/m) + Reading(dBuV).

2.Correction factor (dB/m) = Antenna Factor (dB/m) + Cable loss (dB) – Pre-Amplifier gain (dB).

3. When the peak results are less than average limit, so not need to evaluate the average.



Standard:	FCC Part 15.247	Test Distance:	3m
Test item:	Band edge	Power:	DC 5V
Frequency:	2412MHz	Temp.(°C)/Hum.(%RH):	26(°C)/60%RH
Mode:	Mode 3	Date:	07/19/2017
Ant.Polar.:	Horizontal		
Description:	Antenna Model : MSA-3310-25GC4-A25 / MSA-3310-25GC4-A26		

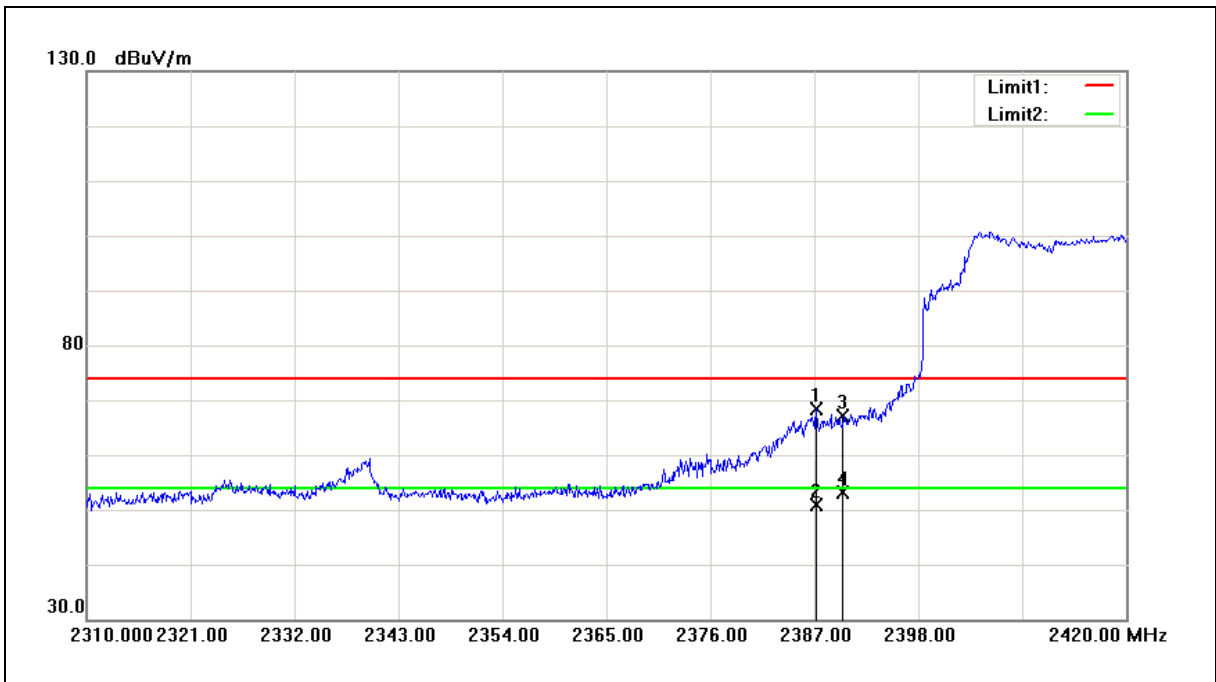

No.	Frequency (MHz)	Reading (dBuV)	Correct Factor (dB/m)	Result (dBuV/m)	Limit (dBuV/m)	Margin (dB)	Remark
1	2387.220	68.12	0.14	68.26	74.00	-5.74	peak
2	2387.220	50.73	0.14	50.87	54.00	-3.13	AVG
3	2390.000	67.09	0.15	67.24	74.00	-6.76	peak
4	2390.000	52.93	0.15	53.08	54.00	-0.92	AVG

Note:1.Result (dBuV/m) = Correct Factor (dB/m) + Reading(dBuV).

2.Correction factor (dB/m) = Antenna Factor (dB/m) + Cable loss (dB) – Pre-Amplifier gain (dB).

3. When the peak results are less than average limit, so not need to evaluate the average.



Standard:	FCC Part 15.247	Test Distance:	3m
Test item:	Band edge	Power:	DC 5V
Frequency:	2412MHz	Temp.(°C)/Hum.(%RH):	26(°C)/60%RH
Mode:	Mode 3	Date:	07/19/2017
Ant.Polar.:	Vertical		
Description:	Antenna Model : MSA-3310-25GC4-A25 / MSA-3310-25GC4-A26		

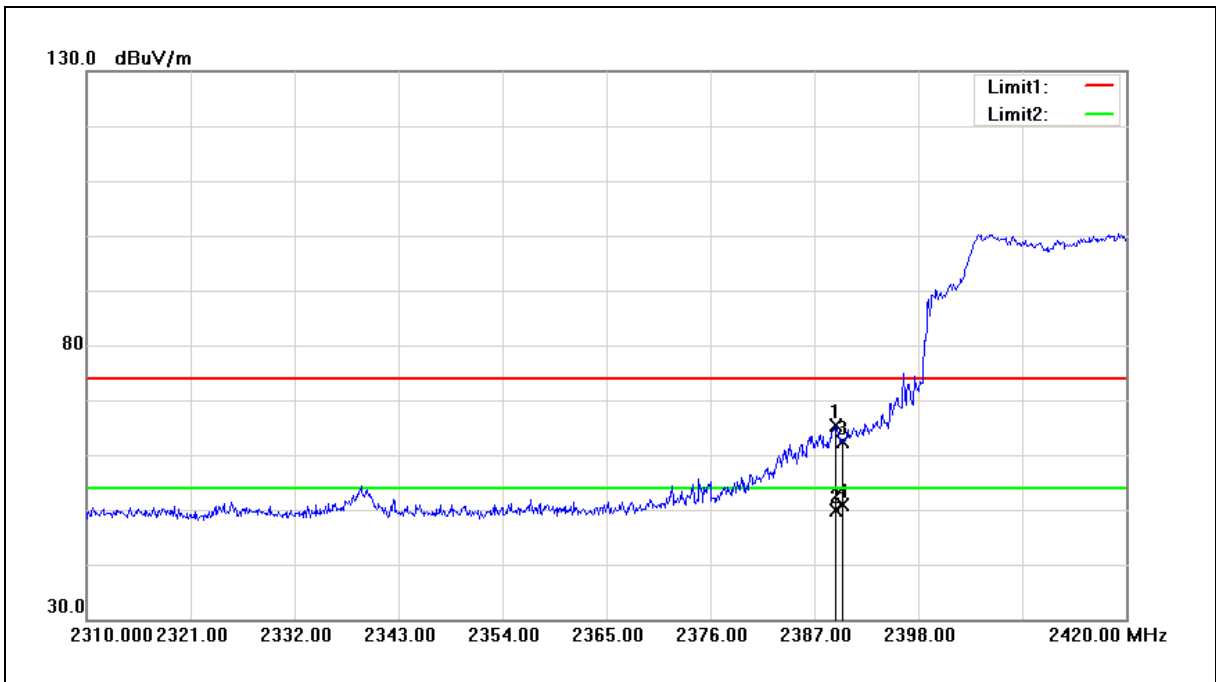

No.	Frequency (MHz)	Reading (dBuV)	Correct Factor (dB/m)	Result (dBuV/m)	Limit (dBuV/m)	Margin (dB)	Remark
1	2389.200	65.24	0.15	65.39	74.00	-8.61	peak
2	2389.200	49.62	0.15	49.77	54.00	-4.23	AVG
3	2390.000	62.20	0.15	62.35	74.00	-11.65	peak
4	2390.000	50.78	0.15	50.93	54.00	-3.07	AVG

Note:1.Result (dBuV/m) = Correct Factor (dB/m) + Reading(dBuV).

2.Correction factor (dB/m) = Antenna Factor (dB/m) + Cable loss (dB) – Pre-Amplifier gain (dB).

3. When the peak results are less than average limit, so not need to evaluate the average.



Standard:	FCC Part 15.247	Test Distance:	3m
Test item:	Band edge	Power:	DC 5V
Frequency:	2437MHz	Temp.(°C)/Hum.(%RH):	26(°C)/60%RH
Mode:	Mode 3	Date:	07/19/2017
Ant.Polar.:	Horizontal		
Description:	Antenna Model : MSA-3310-25GC4-A25 / MSA-3310-25GC4-A26		

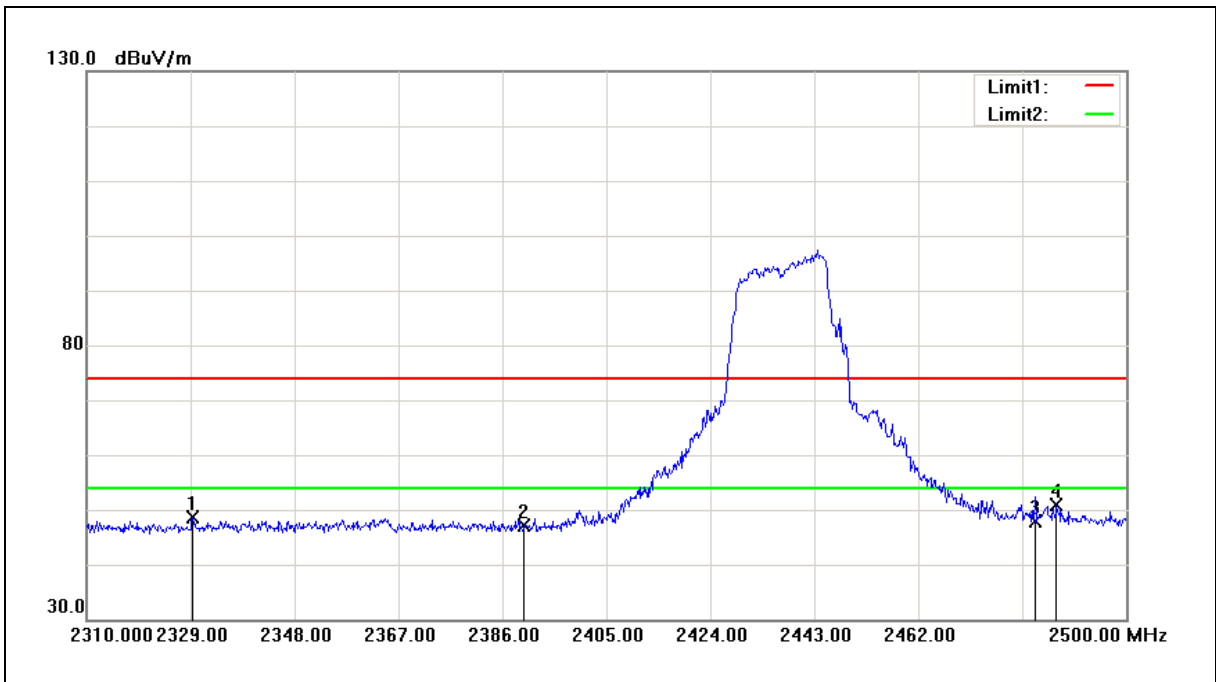

No.	Frequency (MHz)	Reading (dBuV)	Correct Factor (dB/m)	Result (dBuV/m)	Limit (dBuV/m)	Margin (dB)	Remark
1	2329.380	48.73	-0.11	48.62	74.00	-25.38	peak
2	2390.000	46.88	0.15	47.03	74.00	-26.97	peak
3	2483.500	47.21	0.55	47.76	74.00	-26.24	peak
4	2487.270	50.32	0.56	50.88	74.00	-23.12	peak

Note:1.Result (dBuV/m) = Correct Factor (dB/m) + Reading(dBuV).

2.Correction factor (dB/m) = Antenna Factor (dB/m) + Cable loss (dB) – Pre-Amplifier gain (dB).

3. When the peak results are less than average limit, so not need to evaluate the average.



Standard:	FCC Part 15.247	Test Distance:	3m
Test item:	Band edge	Power:	DC 5V
Frequency:	2437MHz	Temp.(°C)/Hum.(%RH):	26(°C)/60%RH
Mode:	Mode 3	Date:	07/19/2017
Ant.Polar.:	Vertical		
Description:	Antenna Model : MSA-3310-25GC4-A25 / MSA-3310-25GC4-A26		

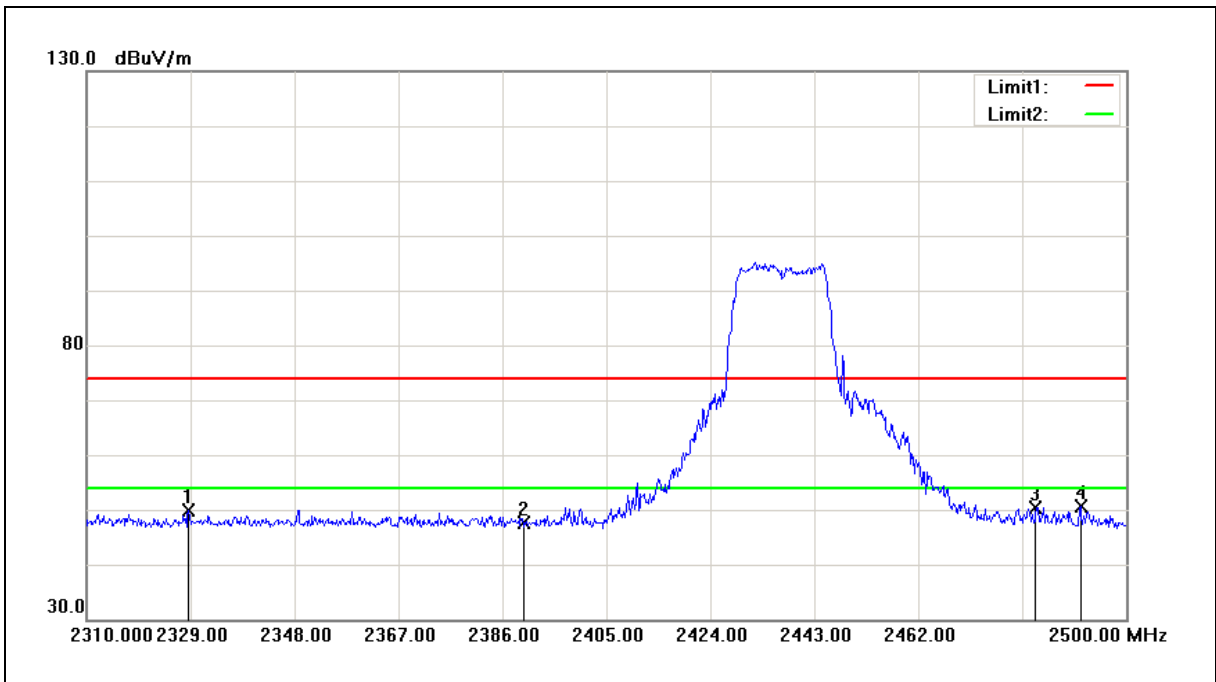

No.	Frequency (MHz)	Reading (dBuV)	Correct Factor (dB/m)	Result (dBuV/m)	Limit (dBuV/m)	Margin (dB)	Remark
1	2328.620	49.98	-0.11	49.87	74.00	-24.13	peak
2	2390.000	47.56	0.15	47.71	74.00	-26.29	peak
3	2483.500	49.71	0.55	50.26	74.00	-23.74	peak
4	2491.640	49.92	0.59	50.51	74.00	-23.49	peak

Note:1.Result (dBuV/m) = Correct Factor (dB/m) + Reading(dBuV).

2.Correction factor (dB/m) = Antenna Factor (dB/m) + Cable loss (dB) – Pre-Amplifier gain (dB).

3. When the peak results are less than average limit, so not need to evaluate the average.



Standard:	FCC Part 15.247	Test Distance:	3m
Test item:	Band edge	Power:	DC 5V
Frequency:	2462MHz	Temp.(°C)/Hum.(%RH):	26(°C)/60%RH
Mode:	Mode 3	Date:	07/19/2017
Ant.Polar.:	Horizontal		
Description:	Antenna Model : MSA-3310-25GC4-A25 / MSA-3310-25GC4-A26		

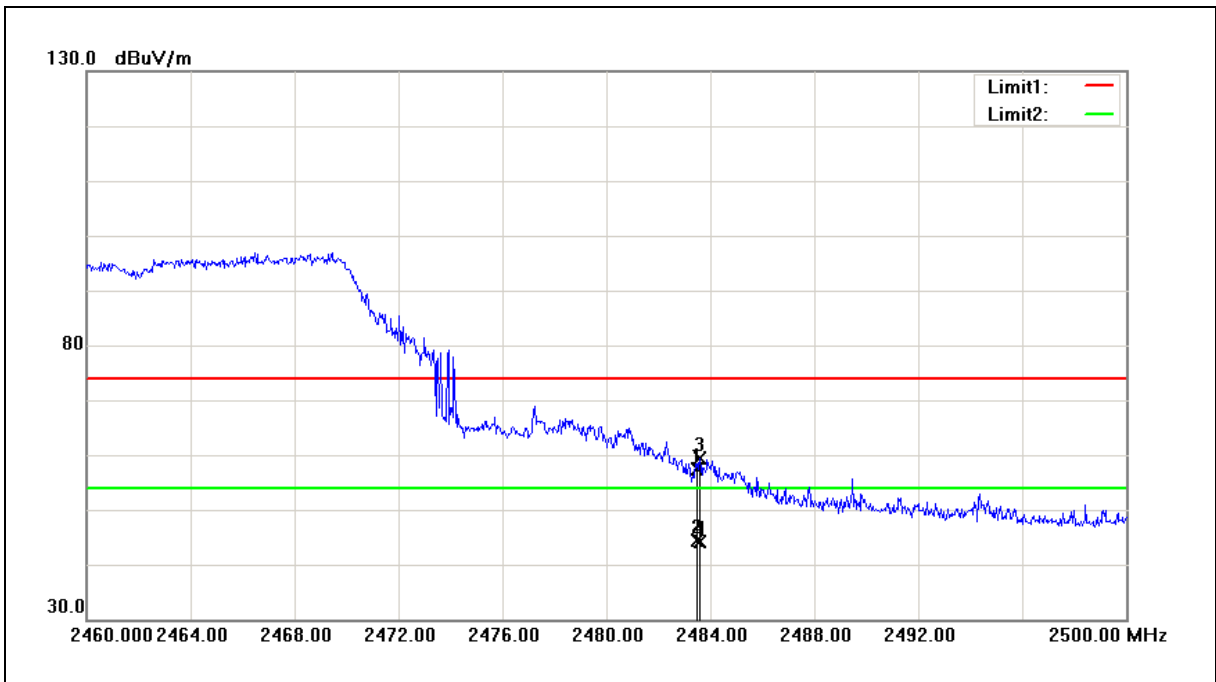

No.	Frequency (MHz)	Reading (dBuV)	Correct Factor (dB/m)	Result (dBuV/m)	Limit (dBuV/m)	Margin (dB)	Remark
1	2483.500	56.82	0.55	57.37	74.00	-16.63	peak
2	2483.500	43.76	0.55	44.31	54.00	-9.69	AVG
3	2483.600	58.82	0.55	59.37	74.00	-14.63	peak
4	2483.600	43.64	0.55	44.19	54.00	-9.81	AVG

Note:1.Result (dBuV/m) = Correct Factor (dB/m) + Reading(dBuV).

2.Correction factor (dB/m) = Antenna Factor (dB/m) + Cable loss (dB) – Pre-Amplifier gain (dB).

3. When the peak results are less than average limit, so not need to evaluate the average.



Standard:	FCC Part 15.247	Test Distance:	3m
Test item:	Band edge	Power:	DC 5V
Frequency:	2462MHz	Temp.(°C)/Hum.(%RH):	26(°C)/60%RH
Mode:	Mode 3	Date:	07/19/2017
Ant.Polar.:	Vertical		
Description:	Antenna Model : MSA-3310-25GC4-A25 / MSA-3310-25GC4-A26		

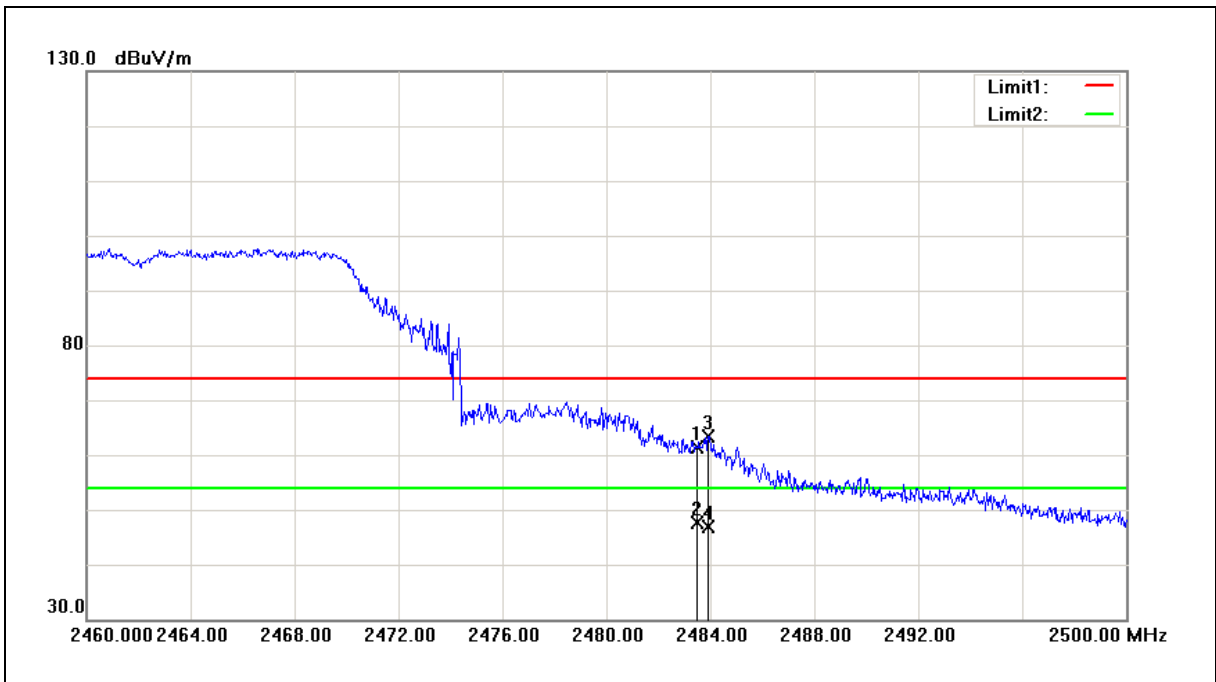

No.	Frequency (MHz)	Reading (dBuV)	Correct Factor (dB/m)	Result (dBuV/m)	Limit (dBuV/m)	Margin (dB)	Remark
1	2483.500	60.80	0.55	61.35	74.00	-12.65	peak
2	2483.500	47.05	0.55	47.60	54.00	-6.40	AVG
3	2483.920	62.94	0.55	63.49	74.00	-10.51	peak
4	2483.920	46.31	0.55	46.86	54.00	-7.14	AVG

Note:1.Result (dBuV/m) = Correct Factor (dB/m) + Reading(dBuV).

2.Correction factor (dB/m) = Antenna Factor (dB/m) + Cable loss (dB) – Pre-Amplifier gain (dB).

3. When the peak results are less than average limit, so not need to evaluate the average.



Standard:	FCC Part 15.247	Test Distance:	3m
Test item:	Band edge	Power:	DC 5V
Frequency:	2412MHz	Temp.(°C)/Hum.(%RH):	26(°C)/60%RH
Mode:	Mode 4	Date:	07/19/2017
Ant.Polar.:	Horizontal		
Description:	Antenna Model : MSA-3310-25GC4-A25 / MSA-3310-25GC4-A26		

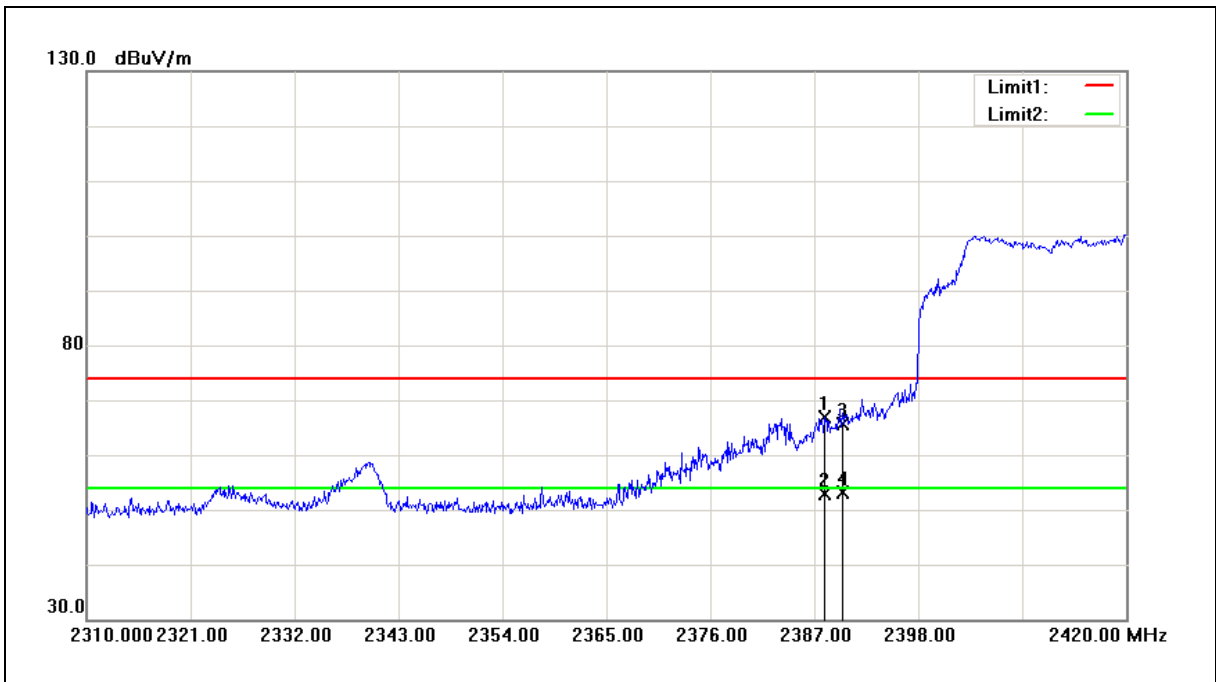

No.	Frequency (MHz)	Reading (dBuV)	Correct Factor (dB/m)	Result (dBuV/m)	Limit (dBuV/m)	Margin (dB)	Remark
1	2388.100	66.63	0.15	66.78	74.00	-7.22	peak
2	2388.100	52.73	0.15	52.88	54.00	-1.12	AVG
3	2390.000	65.57	0.15	65.72	74.00	-8.28	peak
4	2390.000	52.86	0.15	53.01	54.00	-0.99	AVG

Note:1.Result (dBuV/m) = Correct Factor (dB/m) + Reading(dBuV).

2.Correction factor (dB/m) = Antenna Factor (dB/m) + Cable loss (dB) – Pre-Amplifier gain (dB).

3. When the peak results are less than average limit, so not need to evaluate the average.



Standard:	FCC Part 15.247	Test Distance:	3m
Test item:	Band edge	Power:	DC 5V
Frequency:	2412MHz	Temp.(°C)/Hum.(%RH):	26(°C)/60%RH
Mode:	Mode 4	Date:	07/19/2017
Ant.Polar.:	Vertical		
Description:	Antenna Model : MSA-3310-25GC4-A25 / MSA-3310-25GC4-A26		

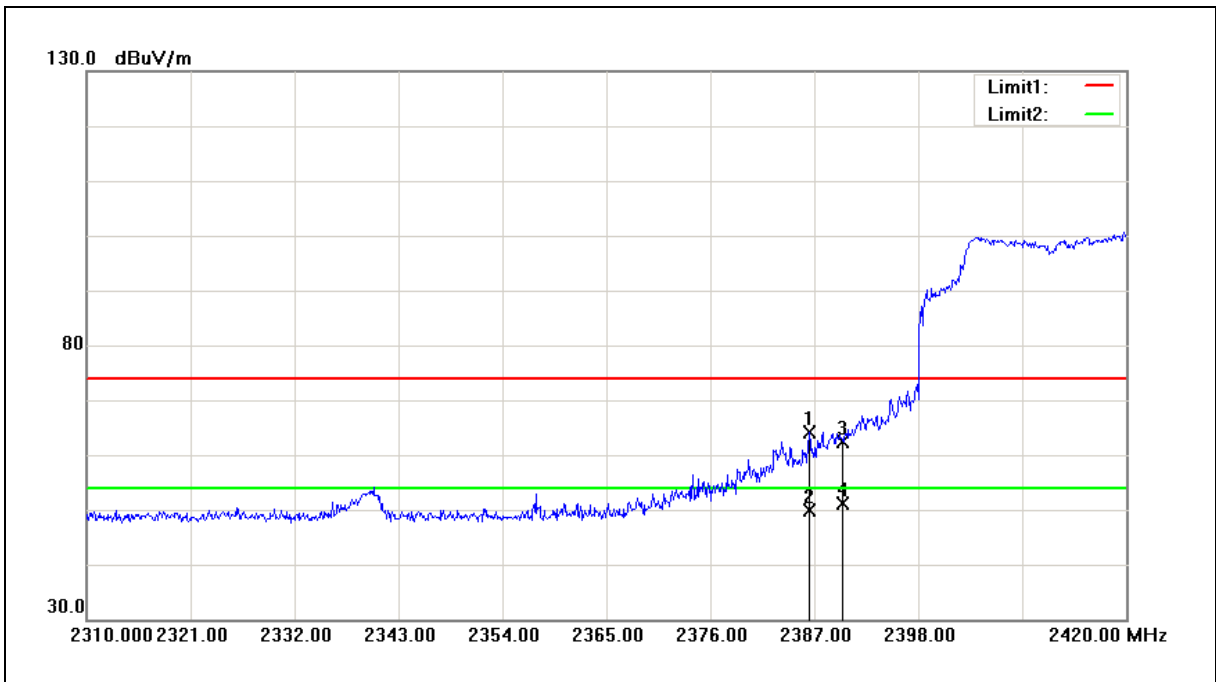

No.	Frequency (MHz)	Reading (dBuV)	Correct Factor (dB/m)	Result (dBuV/m)	Limit (dBuV/m)	Margin (dB)	Remark
1	2386.450	64.11	0.14	64.25	74.00	-9.75	peak
2	2386.450	49.68	0.14	49.82	54.00	-4.18	AVG
3	2390.000	62.32	0.15	62.47	74.00	-11.53	peak
4	2390.000	50.90	0.15	51.05	54.00	-2.95	AVG

Note:1.Result (dBuV/m) = Correct Factor (dB/m) + Reading(dBuV).

2.Correction factor (dB/m) = Antenna Factor (dB/m) + Cable loss (dB) – Pre-Amplifier gain (dB).

3. When the peak results are less than average limit, so not need to evaluate the average.



Standard:	FCC Part 15.247	Test Distance:	3m
Test item:	Band edge	Power:	DC 5V
Frequency:	2437MHz	Temp.(°C)/Hum.(%RH):	26(°C)/60%RH
Mode:	Mode 4	Date:	07/19/2017
Ant.Polar.:	Horizontal		
Description:	Antenna Model : MSA-3310-25GC4-A25 / MSA-3310-25GC4-A26		

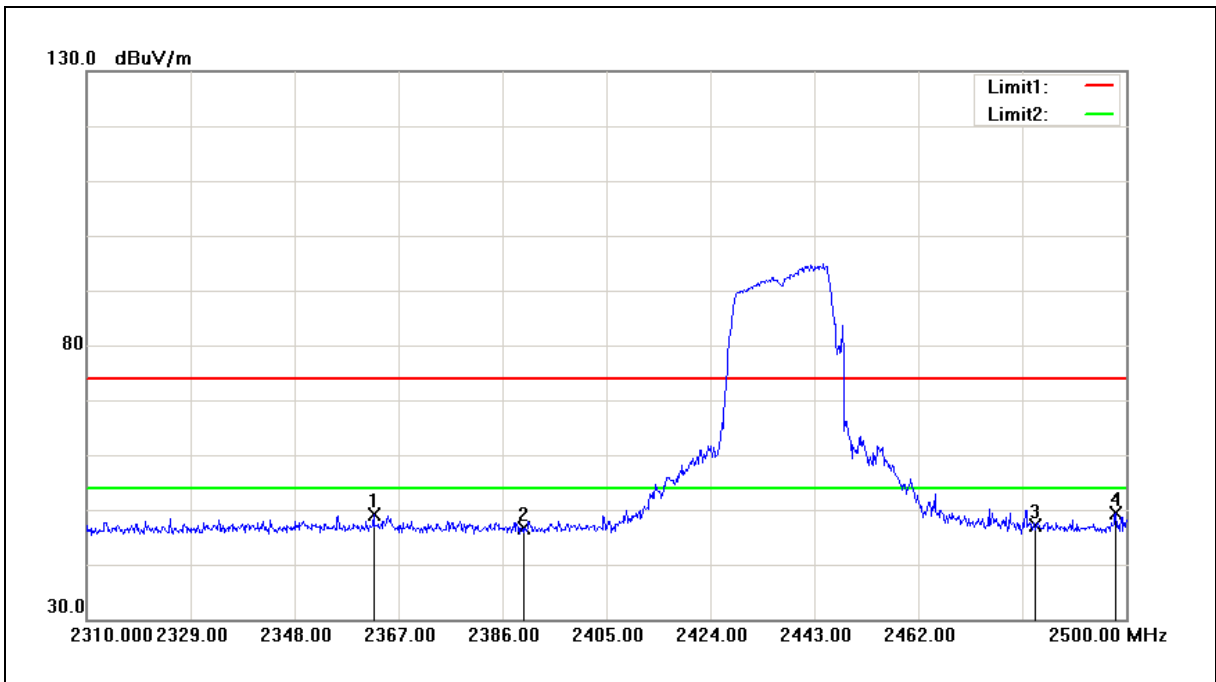

No.	Frequency (MHz)	Reading (dBuV)	Correct Factor (dB/m)	Result (dBuV/m)	Limit (dBuV/m)	Margin (dB)	Remark
1	2362.440	49.11	0.03	49.14	74.00	-24.86	peak
2	2390.000	46.60	0.15	46.75	74.00	-27.25	peak
3	2483.500	46.53	0.55	47.08	74.00	-26.92	peak
4	2498.100	48.83	0.61	49.44	74.00	-24.56	peak

Note:1.Result (dBuV/m) = Correct Factor (dB/m) + Reading(dBuV).

2.Correction factor (dB/m) = Antenna Factor (dB/m) + Cable loss (dB) – Pre-Amplifier gain (dB).

3. When the peak results are less than average limit, so not need to evaluate the average.



Standard:	FCC Part 15.247	Test Distance:	3m
Test item:	Band edge	Power:	DC 5V
Frequency:	2437MHz	Temp.(°C)/Hum.(%RH):	26(°C)/60%RH
Mode:	Mode 4	Date:	07/19/2017
Ant.Polar.:	Vertical		
Description:	Antenna Model : MSA-3310-25GC4-A25 / MSA-3310-25GC4-A26		

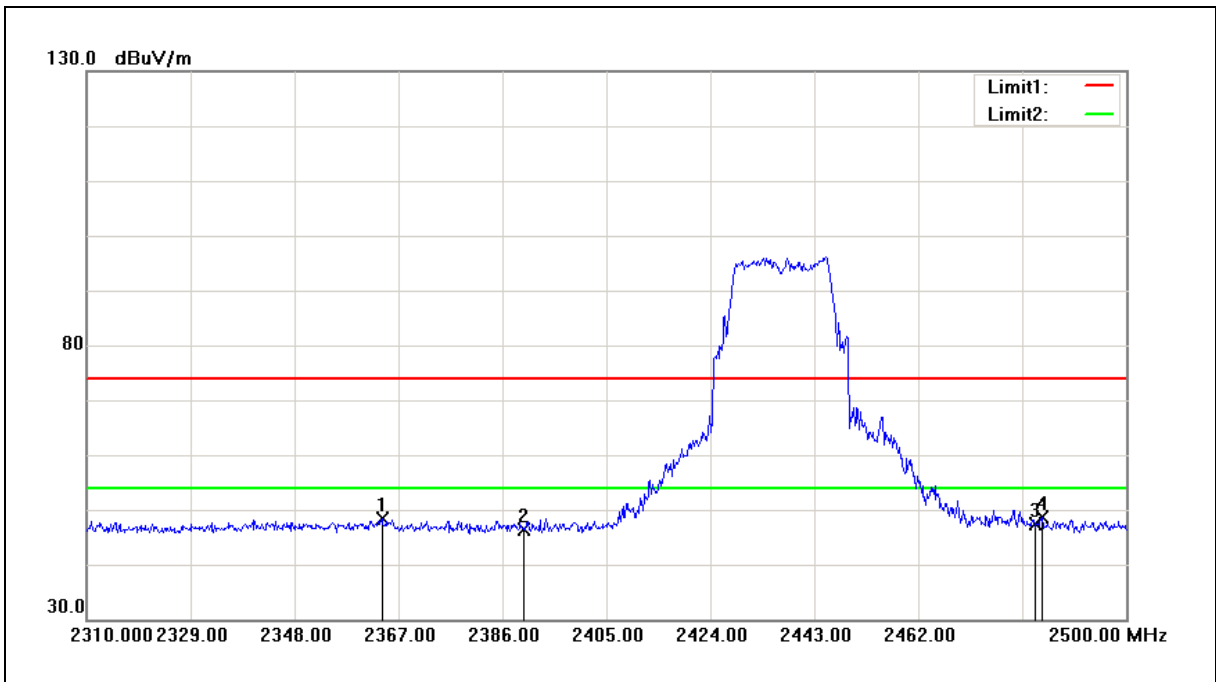

No.	Frequency (MHz)	Reading (dBuV)	Correct Factor (dB/m)	Result (dBuV/m)	Limit (dBuV/m)	Margin (dB)	Remark
1	2363.960	48.27	0.05	48.32	74.00	-25.68	peak
2	2390.000	46.22	0.15	46.37	74.00	-27.63	peak
3	2483.500	46.71	0.55	47.26	74.00	-26.74	peak
4	2484.610	48.04	0.56	48.60	74.00	-25.40	peak

Note:1.Result (dBuV/m) = Correct Factor (dB/m) + Reading(dBuV).

2.Correction factor (dB/m) = Antenna Factor (dB/m) + Cable loss (dB) – Pre-Amplifier gain (dB).

3. When the peak results are less than average limit, so not need to evaluate the average.



Standard:	FCC Part 15.247	Test Distance:	3m
Test item:	Band edge	Power:	DC 5V
Frequency:	2462MHz	Temp.(°C)/Hum.(%RH):	26(°C)/60%RH
Mode:	Mode 4	Date:	07/19/2017
Ant.Polar.:	Horizontal		
Description:	Antenna Model : MSA-3310-25GC4-A25 / MSA-3310-25GC4-A26		

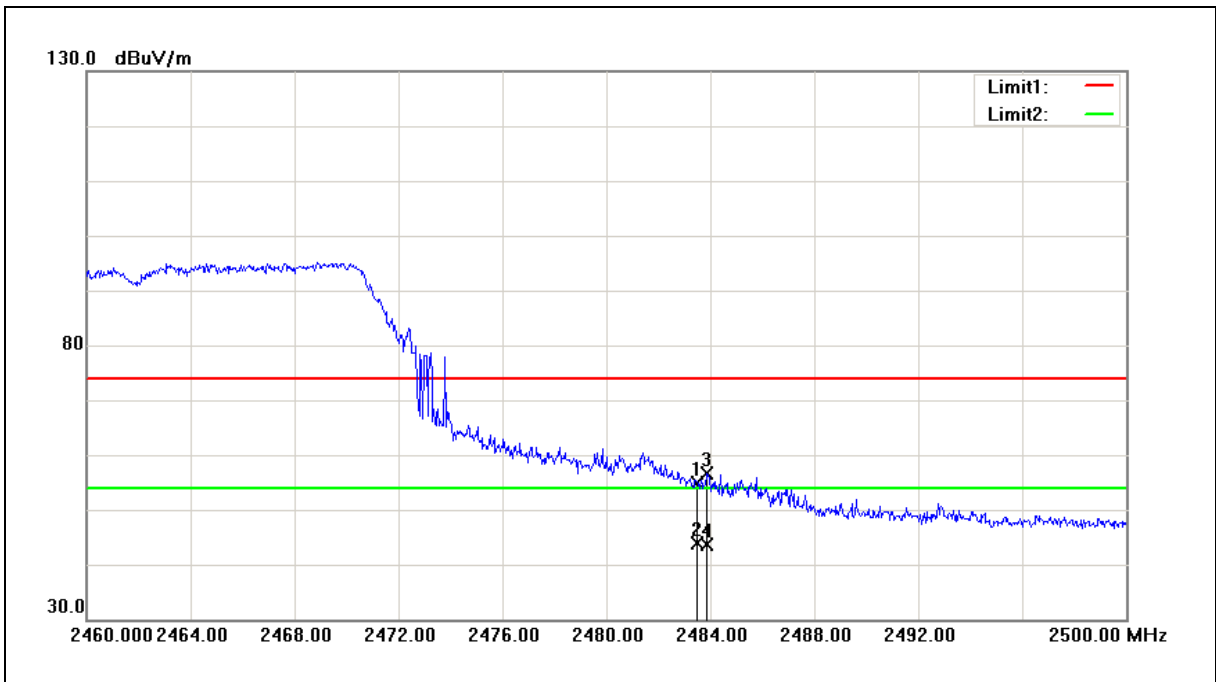

No.	Frequency (MHz)	Reading (dBuV)	Correct Factor (dB/m)	Result (dBuV/m)	Limit (dBuV/m)	Margin (dB)	Remark
1	2483.500	54.34	0.55	54.89	74.00	-19.11	peak
2	2483.500	43.44	0.55	43.99	54.00	-10.01	AVG
3	2483.880	56.07	0.55	56.62	74.00	-17.38	peak
4	2483.880	43.00	0.55	43.55	54.00	-10.45	AVG

Note:1.Result (dBuV/m) = Correct Factor (dB/m) + Reading(dBuV).

2.Correction factor (dB/m) = Antenna Factor (dB/m) + Cable loss (dB) – Pre-Amplifier gain (dB).

3. When the peak results are less than average limit, so not need to evaluate the average.



Standard:	FCC Part 15.247	Test Distance:	3m
Test item:	Band edge	Power:	DC 5V
Frequency:	2462MHz	Temp.(°C)/Hum.(%RH):	26(°C)/60%RH
Mode:	Mode 4	Date:	07/19/2017
Ant.Polar.:	Vertical		
Description:	Antenna Model : MSA-3310-25GC4-A25 / MSA-3310-25GC4-A26		

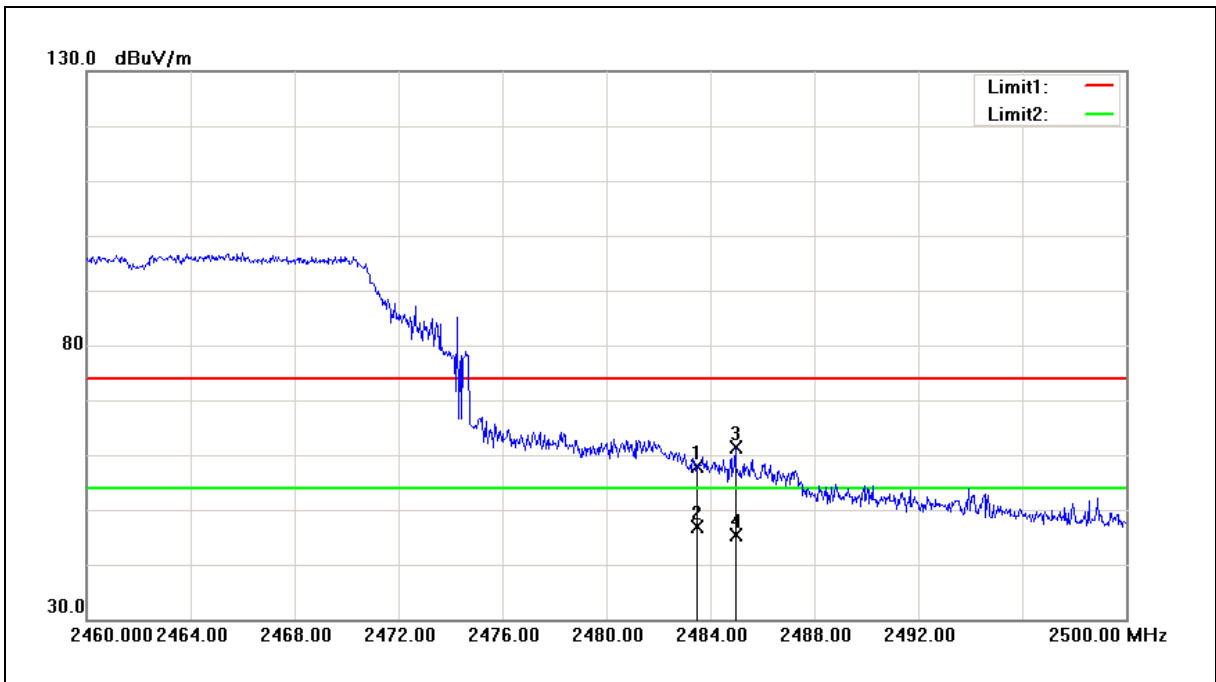

No.	Frequency (MHz)	Reading (dBuV)	Correct Factor (dB/m)	Result (dBuV/m)	Limit (dBuV/m)	Margin (dB)	Remark
1	2483.500	57.38	0.55	57.93	74.00	-16.07	peak
2	2483.500	46.39	0.55	46.94	54.00	-7.06	AVG
3	2484.960	60.72	0.56	61.28	74.00	-12.72	peak
4	2484.960	44.86	0.56	45.42	54.00	-8.58	AVG

Note:1.Result (dBuV/m) = Correct Factor (dB/m) + Reading(dBuV).

2.Correction factor (dB/m) = Antenna Factor (dB/m) + Cable loss (dB) – Pre-Amplifier gain (dB).

3. When the peak results are less than average limit, so not need to evaluate the average.



Standard:	FCC Part 15.247	Test Distance:	3m
Test item:	Band edge	Power:	DC 5V
Frequency:	2422MHz	Temp.(°C)/Hum.(%RH):	26(°C)/60%RH
Mode:	Mode 5	Date:	07/19/2017
Ant.Polar.:	Horizontal		
Description:	Antenna Model : MSA-3310-25GC4-A25 / MSA-3310-25GC4-A26		

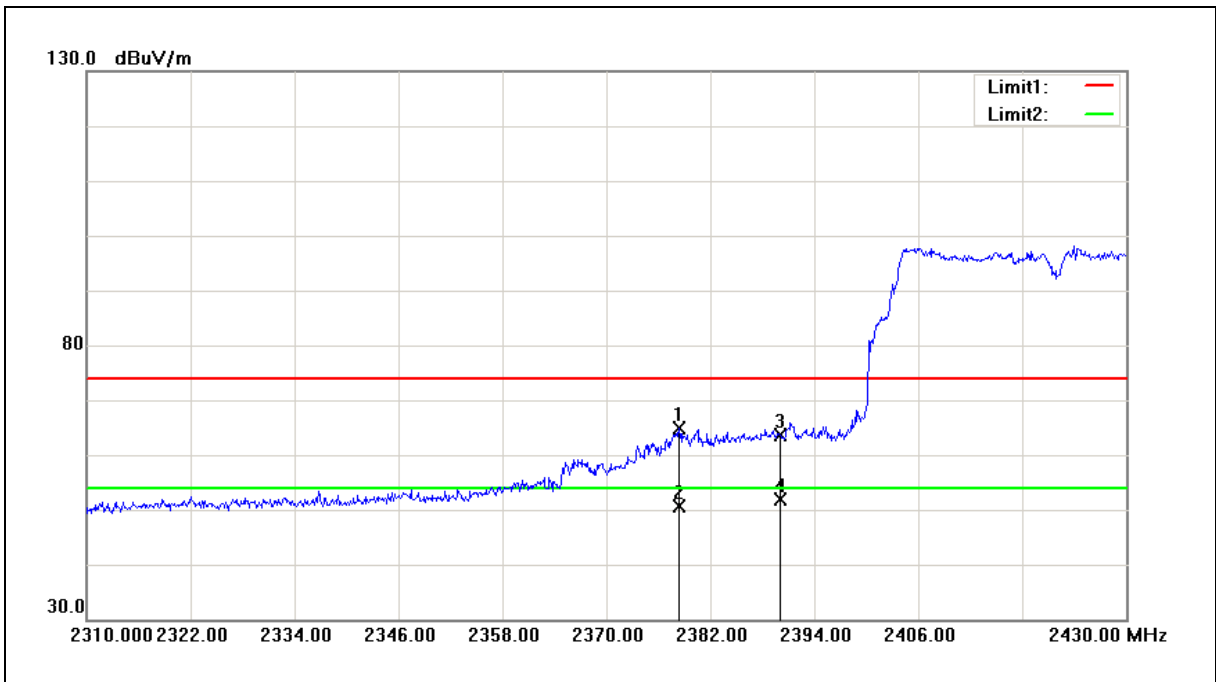

No.	Frequency (MHz)	Reading (dBuV)	Correct Factor (dB/m)	Result (dBuV/m)	Limit (dBuV/m)	Margin (dB)	Remark
1	2378.400	64.84	0.11	64.95	74.00	-9.05	peak
2	2378.400	50.57	0.11	50.68	54.00	-3.32	AVG
3	2390.000	63.52	0.15	63.67	74.00	-10.33	peak
4	2390.000	51.82	0.15	51.97	54.00	-2.03	AVG

Note:1.Result (dBuV/m) = Correct Factor (dB/m) + Reading(dBuV).

2.Correction factor (dB/m) = Antenna Factor (dB/m) + Cable loss (dB) – Pre-Amplifier gain (dB).

3. When the peak results are less than average limit, so not need to evaluate the average.



Standard:	FCC Part 15.247	Test Distance:	3m
Test item:	Band edge	Power:	DC 5V
Frequency:	2422MHz	Temp.(°C)/Hum.(%RH):	26(°C)/60%RH
Mode:	Mode 5	Date:	07/19/2017
Ant.Polar.:	Vertical		
Description:	Antenna Model : MSA-3310-25GC4-A25 / MSA-3310-25GC4-A26		

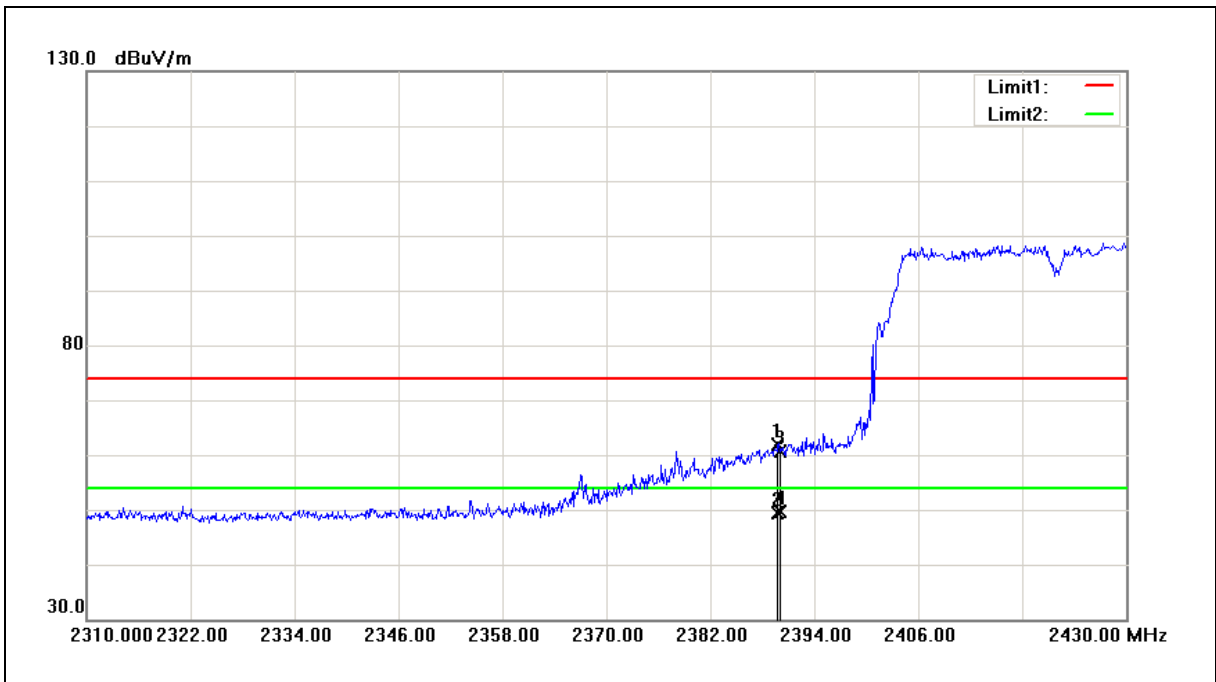

No.	Frequency (MHz)	Reading (dBuV)	Correct Factor (dB/m)	Result (dBuV/m)	Limit (dBuV/m)	Margin (dB)	Remark
1	2389.800	61.69	0.15	61.84	74.00	-12.16	peak
2	2389.800	49.33	0.15	49.48	54.00	-4.52	AVG
3	2390.000	60.55	0.15	60.70	74.00	-13.30	peak
4	2390.000	49.38	0.15	49.53	54.00	-4.47	AVG

Note:1.Result (dBuV/m) = Correct Factor (dB/m) + Reading(dBuV).

2.Correction factor (dB/m) = Antenna Factor (dB/m) + Cable loss (dB) – Pre-Amplifier gain (dB).

3. When the peak results are less than average limit, so not need to evaluate the average.



Standard:	FCC Part 15.247	Test Distance:	3m
Test item:	Band edge	Power:	DC 5V
Frequency:	2437MHz	Temp.(°C)/Hum.(%RH):	26(°C)/60%RH
Mode:	Mode 5	Date:	07/19/2017
Ant.Polar.:	Horizontal		
Description:	Antenna Model : MSA-3310-25GC4-A25 / MSA-3310-25GC4-A26		

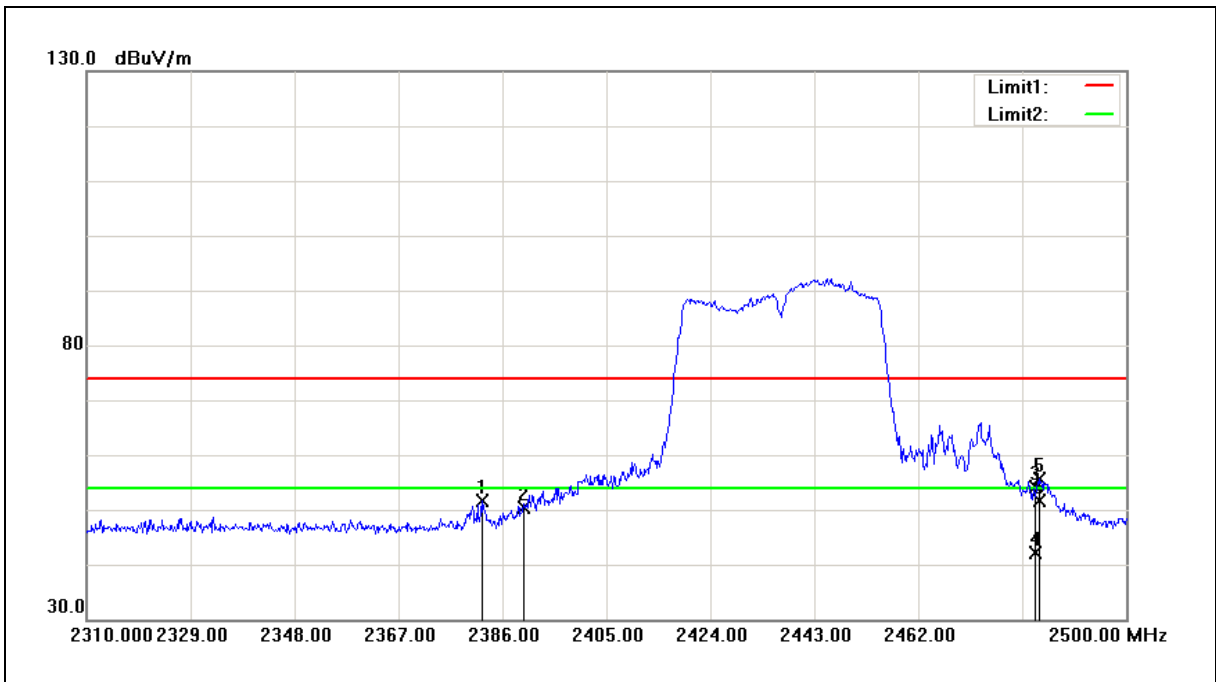

No.	Frequency (MHz)	Reading (dBuV)	Correct Factor (dB/m)	Result (dBuV/m)	Limit (dBuV/m)	Margin (dB)	Remark
1	2382.200	51.54	0.12	51.66	74.00	-22.34	peak
2	2390.000	50.28	0.15	50.43	74.00	-23.57	peak
3	2483.500	53.55	0.55	54.10	74.00	-19.90	peak
4	2483.500	41.51	0.55	42.06	54.00	-11.94	AVG
5	2484.040	54.95	0.56	55.51	74.00	-18.49	peak
6	2484.040	51.02	0.56	51.58	54.00	-2.42	AVG

Note:1.Result (dBuV/m) = Correct Factor (dB/m) + Reading(dBuV).

2.Correction factor (dB/m) = Antenna Factor (dB/m) + Cable loss (dB) – Pre-Amplifier gain (dB).

3. When the peak results are less than average limit, so not need to evaluate the average.



Standard:	FCC Part 15.247	Test Distance:	3m
Test item:	Band edge	Power:	DC 5V
Frequency:	2437MHz	Temp.(°C)/Hum.(%RH):	26(°C)/60%RH
Mode:	Mode 5	Date:	07/19/2017
Ant.Polar.:	Vertical		
Description:	Antenna Model : MSA-3310-25GC4-A25 / MSA-3310-25GC4-A26		

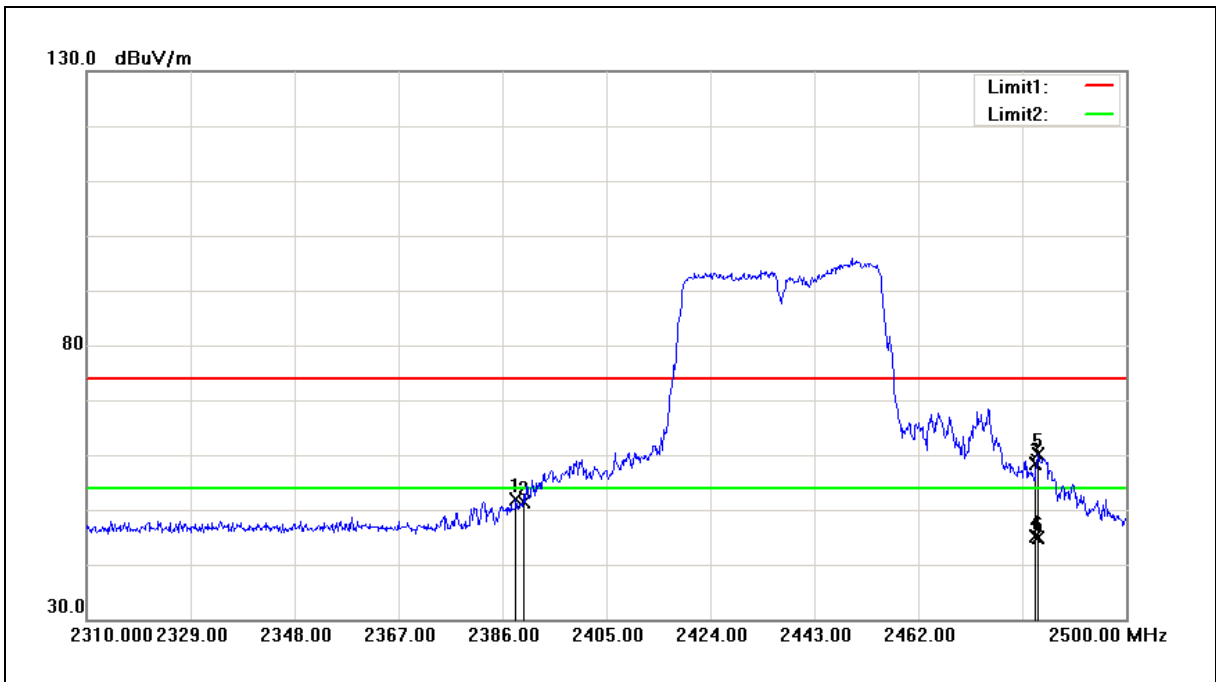

No.	Frequency (MHz)	Reading (dBuV)	Correct Factor (dB/m)	Result (dBuV/m)	Limit (dBuV/m)	Margin (dB)	Remark
1	2388.470	51.69	0.15	51.84	74.00	-22.16	peak
2	2390.000	51.13	0.15	51.28	74.00	-22.72	peak
3	2483.500	57.90	0.55	58.45	74.00	-15.55	peak
4	2483.500	44.65	0.55	45.20	54.00	-8.80	AVG
5	2483.850	59.52	0.55	60.07	74.00	-13.93	peak
6	2483.850	44.27	0.55	44.82	54.00	-9.18	AVG

Note:1.Result (dBuV/m) = Correct Factor (dB/m) + Reading(dBuV).

2.Correction factor (dB/m) = Antenna Factor (dB/m) + Cable loss (dB) – Pre-Amplifier gain (dB).

3. When the peak results are less than average limit, so not need to evaluate the average.



Standard:	FCC Part 15.247	Test Distance:	3m
Test item:	Band edge	Power:	DC 5V
Frequency:	2452MHz	Temp.(°C)/Hum.(%RH):	26(°C)/60%RH
Mode:	Mode 5	Date:	07/19/2017
Ant.Polar.:	Horizontal		
Description:	Antenna Model : MSA-3310-25GC4-A25 / MSA-3310-25GC4-A26		

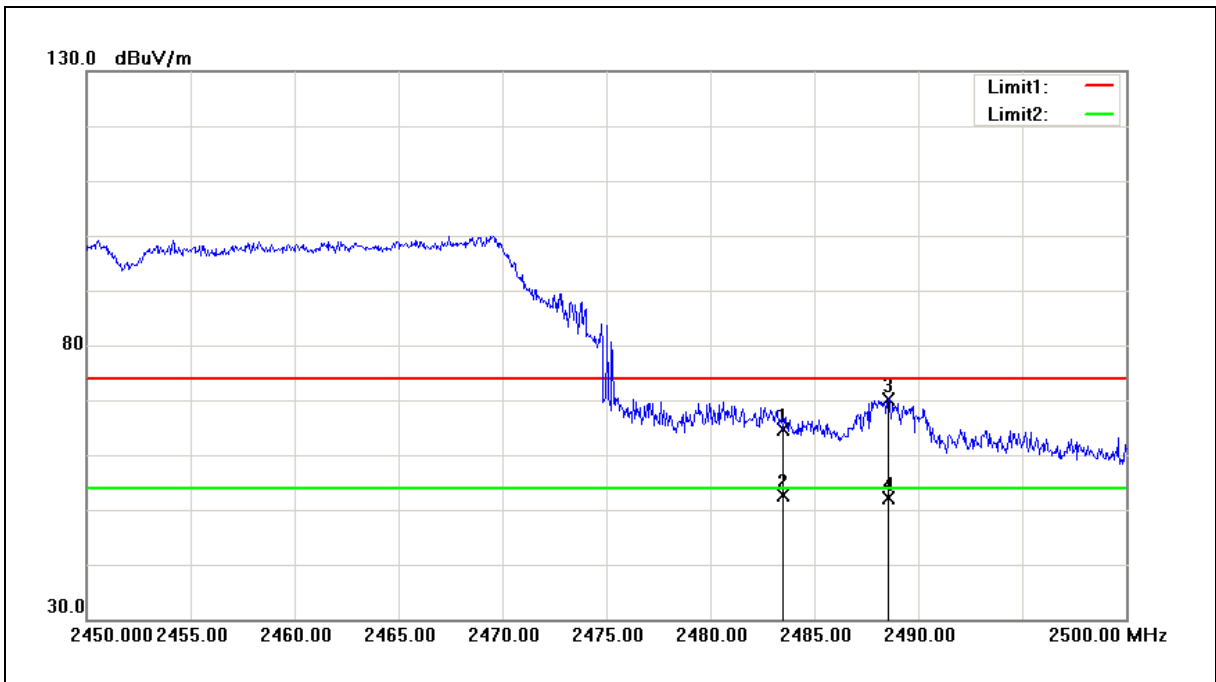

No.	Frequency (MHz)	Reading (dBuV)	Correct Factor (dB/m)	Result (dBuV/m)	Limit (dBuV/m)	Margin (dB)	Remark
1	2483.500	64.10	0.55	64.65	74.00	-9.35	peak
2	2483.500	52.20	0.55	52.75	54.00	-1.25	AVG
3	2488.550	69.68	0.57	70.25	74.00	-3.75	peak
4	2488.550	51.60	0.57	52.17	54.00	-1.83	AVG

Note:1.Result (dBuV/m) = Correct Factor (dB/m) + Reading(dBuV).

2.Correction factor (dB/m) = Antenna Factor (dB/m) + Cable loss (dB) – Pre-Amplifier gain (dB).

3. When the peak results are less than average limit, so not need to evaluate the average.



Standard:	FCC Part 15.247	Test Distance:	3m
Test item:	Band edge	Power:	DC 5V
Frequency:	2452MHz	Temp.(°C)/Hum.(%RH):	26(°C)/60%RH
Mode:	Mode 5	Date:	07/19/2017
Ant.Polar.:	Vertical		
Description:	Antenna Model : MSA-3310-25GC4-A25 / MSA-3310-25GC4-A26		

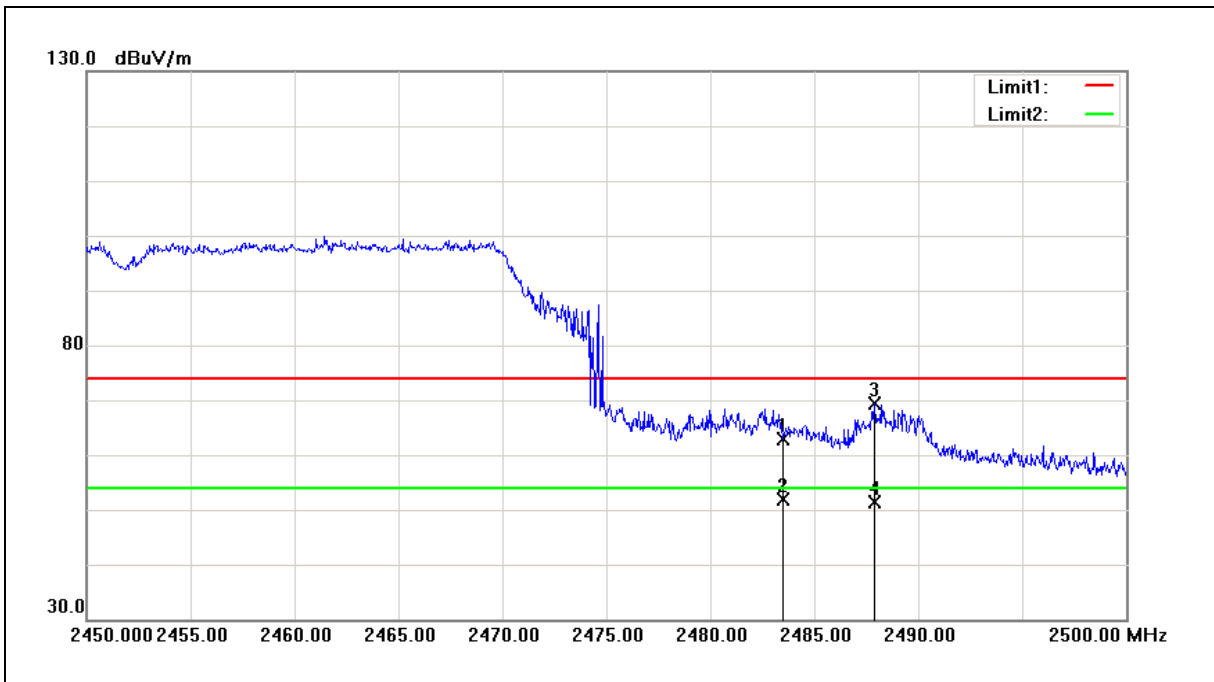

No.	Frequency (MHz)	Reading (dBuV)	Correct Factor (dB/m)	Result (dBuV/m)	Limit (dBuV/m)	Margin (dB)	Remark
1	2483.500	62.36	0.55	62.91	74.00	-11.09	peak
2	2483.500	51.34	0.55	51.89	54.00	-2.11	AVG
3	2487.900	68.77	0.57	69.34	74.00	-4.66	peak
4	2487.900	50.89	0.57	51.46	54.00	-2.54	AVG

Note:1.Result (dBuV/m) = Correct Factor (dB/m) + Reading(dBuV).

2.Correction factor (dB/m) = Antenna Factor (dB/m) + Cable loss (dB) – Pre-Amplifier gain (dB).

3. When the peak results are less than average limit, so not need to evaluate the average.



Standard:	FCC Part 15.247	Test Distance:	3m
Test item:	Band edge	Power:	DC 5V
Frequency:	2412MHz	Temp.(°C)/Hum.(%RH):	26(°C)/60%RH
Mode:	Mode 2	Date:	07/11/2017
Ant.Polar.:	Horizontal		
Description:	Antenna Model : EDA-1713-25GC1-A14		

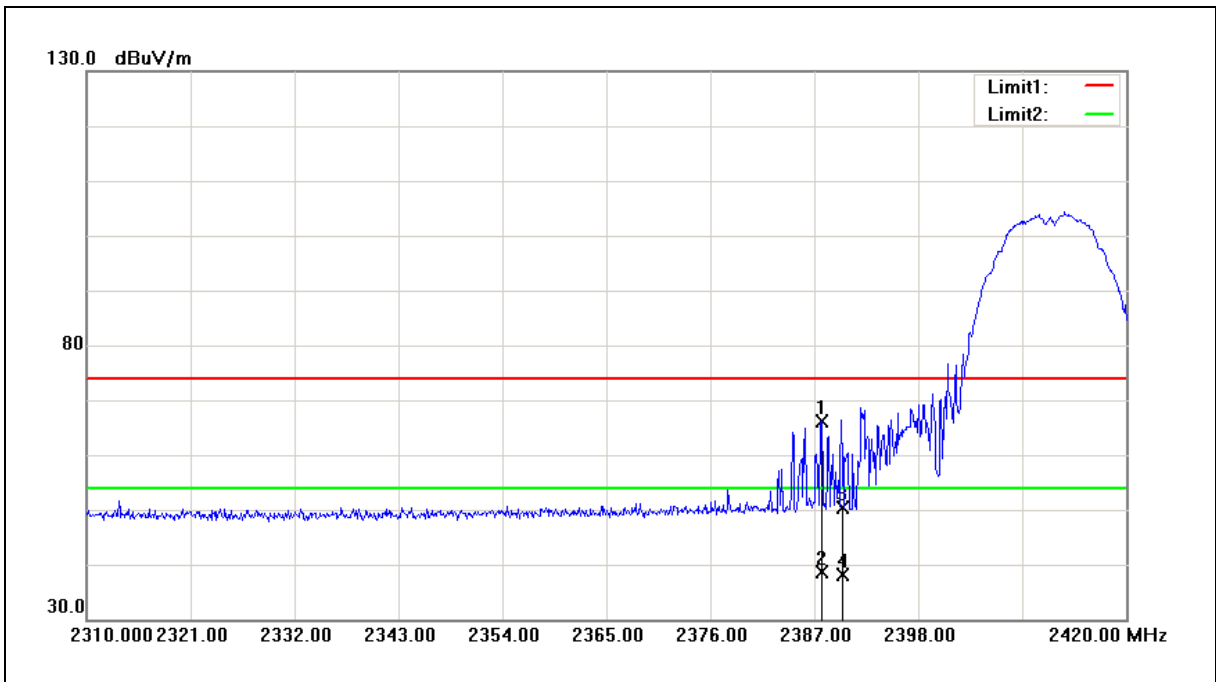

No.	Frequency (MHz)	Reading (dBuV)	Correct Factor (dB/m)	Result (dBuV/m)	Limit (dBuV/m)	Margin (dB)	Remark
1	2387.770	65.86	0.15	66.01	74.00	-7.99	peak
2	2387.770	38.57	0.15	38.72	54.00	-15.28	AVG
3	2390.000	50.15	0.15	50.30	74.00	-23.70	peak
4	2390.000	38.08	0.15	38.23	54.00	-15.77	AVG

Note:1.Result (dBuV/m) = Correct Factor (dB/m) + Reading(dBuV).

2.Correction factor (dB/m) = Antenna Factor (dB/m) + Cable loss (dB) – Pre-Amplifier gain (dB).

3. When the peak results are less than average limit, so not need to evaluate the average.



Standard:	FCC Part 15.247	Test Distance:	3m
Test item:	Band edge	Power:	DC 5V
Frequency:	2412MHz	Temp.(°C)/Hum.(%RH):	26(°C)/60%RH
Mode:	Mode 2	Date:	07/11/2017
Ant.Polar.:	Vertical		
Description:	Antenna Model : EDA-1713-25GC1-A14		

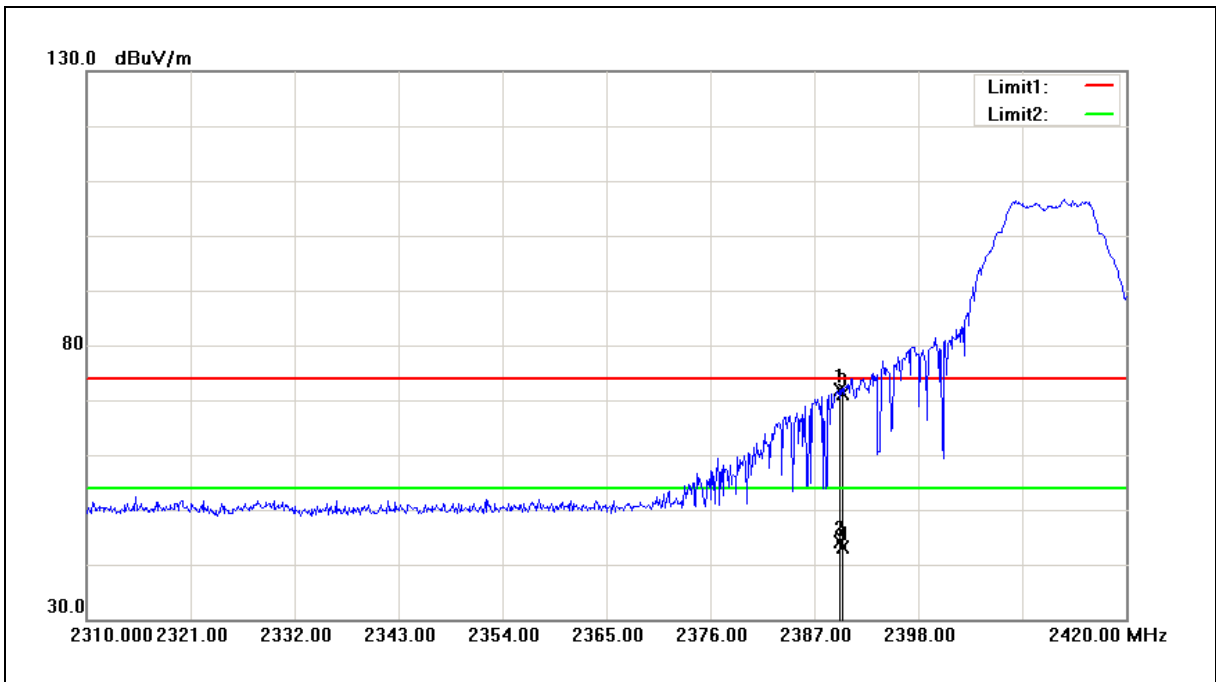

No.	Frequency (MHz)	Reading (dBuV)	Correct Factor (dB/m)	Result (dBuV/m)	Limit (dBuV/m)	Margin (dB)	Remark
1	2389.640	71.83	0.15	71.98	74.00	-2.02	peak
2	2389.640	43.88	0.15	44.03	54.00	-9.97	AVG
3	2390.000	70.91	0.15	71.06	74.00	-2.94	peak
4	2390.000	43.08	0.15	43.23	54.00	-10.77	AVG

Note:1.Result (dBuV/m) = Correct Factor (dB/m) + Reading(dBuV).

2.Correction factor (dB/m) = Antenna Factor (dB/m) + Cable loss (dB) – Pre-Amplifier gain (dB).

3. When the peak results are less than average limit, so not need to evaluate the average.



Standard:	FCC Part 15.247	Test Distance:	3m
Test item:	Band edge	Power:	DC 5V
Frequency:	2437MHz	Temp.(°C)/Hum.(%RH):	26(°C)/60%RH
Mode:	Mode 2	Date:	07/11/2017
Ant.Polar.:	Horizontal		
Description:	Antenna Model : EDA-1713-25GC1-A14		

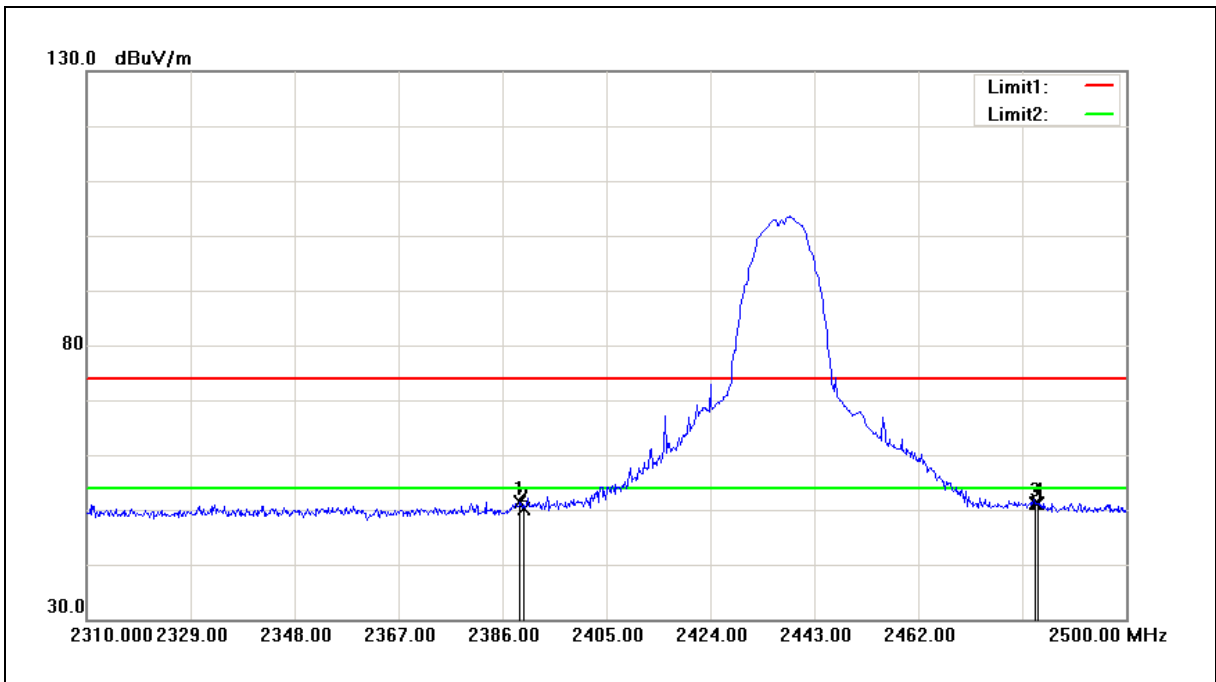

No.	Frequency (MHz)	Reading (dBuV)	Correct Factor (dB/m)	Result (dBuV/m)	Limit (dBuV/m)	Margin (dB)	Remark
1	2389.230	51.29	0.15	51.44	74.00	-22.56	peak
2	2390.000	50.10	0.15	50.25	74.00	-23.75	peak
3	2483.500	50.61	0.55	51.16	74.00	-22.84	peak
4	2483.850	50.67	0.55	51.22	74.00	-22.78	peak

Note:1.Result (dBuV/m) = Correct Factor (dB/m) + Reading(dBuV).

2.Correction factor (dB/m) = Antenna Factor (dB/m) + Cable loss (dB) – Pre-Amplifier gain (dB).

3. When the peak results are less than average limit, so not need to evaluate the average.



Standard:	FCC Part 15.247	Test Distance:	3m
Test item:	Band edge	Power:	DC 5V
Frequency:	2437MHz	Temp.(°C)/Hum.(%RH):	26(°C)/60%RH
Mode:	Mode 2	Date:	07/11/2017
Ant.Polar.:	Vertical		
Description:	Antenna Model : EDA-1713-25GC1-A14		

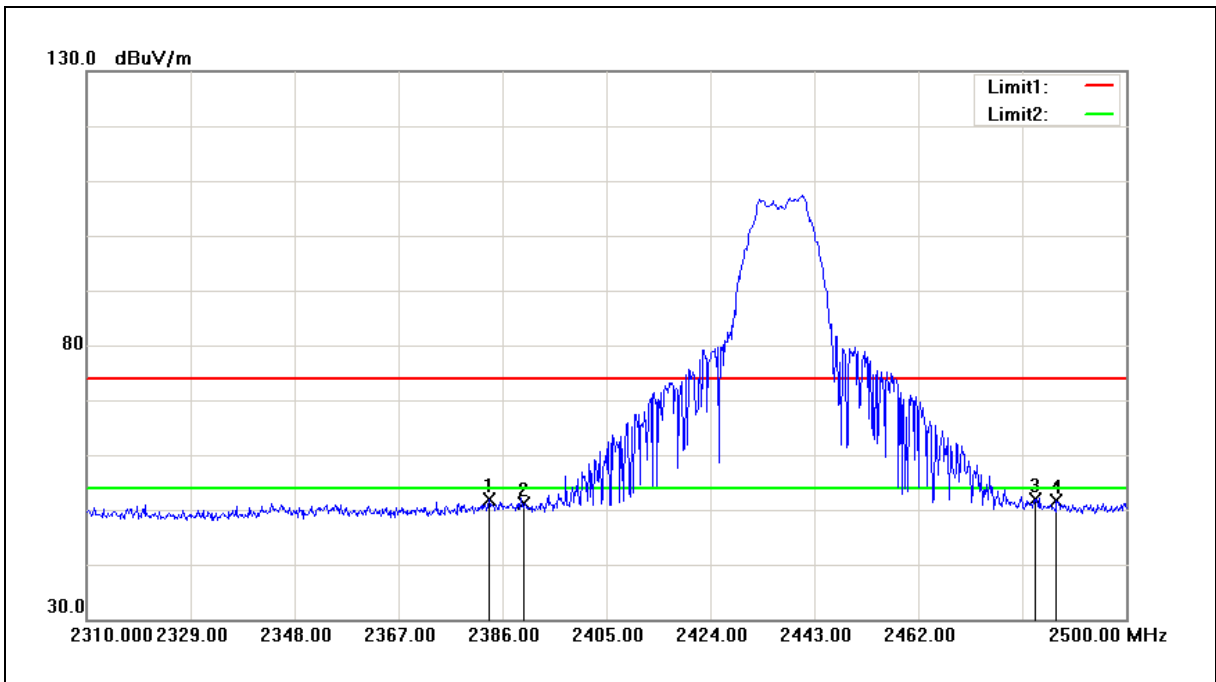

No.	Frequency (MHz)	Reading (dBuV)	Correct Factor (dB/m)	Result (dBuV/m)	Limit (dBuV/m)	Margin (dB)	Remark
1	2383.530	51.70	0.13	51.83	74.00	-22.17	peak
2	2390.000	50.97	0.15	51.12	74.00	-22.88	peak
3	2483.500	51.21	0.55	51.76	74.00	-22.24	peak
4	2487.270	51.05	0.56	51.61	74.00	-22.39	peak

Note:1.Result (dBuV/m) = Correct Factor (dB/m) + Reading(dBuV).

2.Correction factor (dB/m) = Antenna Factor (dB/m) + Cable loss (dB) – Pre-Amplifier gain (dB).

3. When the peak results are less than average limit, so not need to evaluate the average.



Standard:	FCC Part 15.247	Test Distance:	3m
Test item:	Band edge	Power:	DC 5V
Frequency:	2462MHz	Temp.(°C)/Hum.(%RH):	26(°C)/60%RH
Mode:	Mode 2	Date:	07/11/2017
Ant.Polar.:	Horizontal		
Description:	Antenna Model : EDA-1713-25GC1-A14		

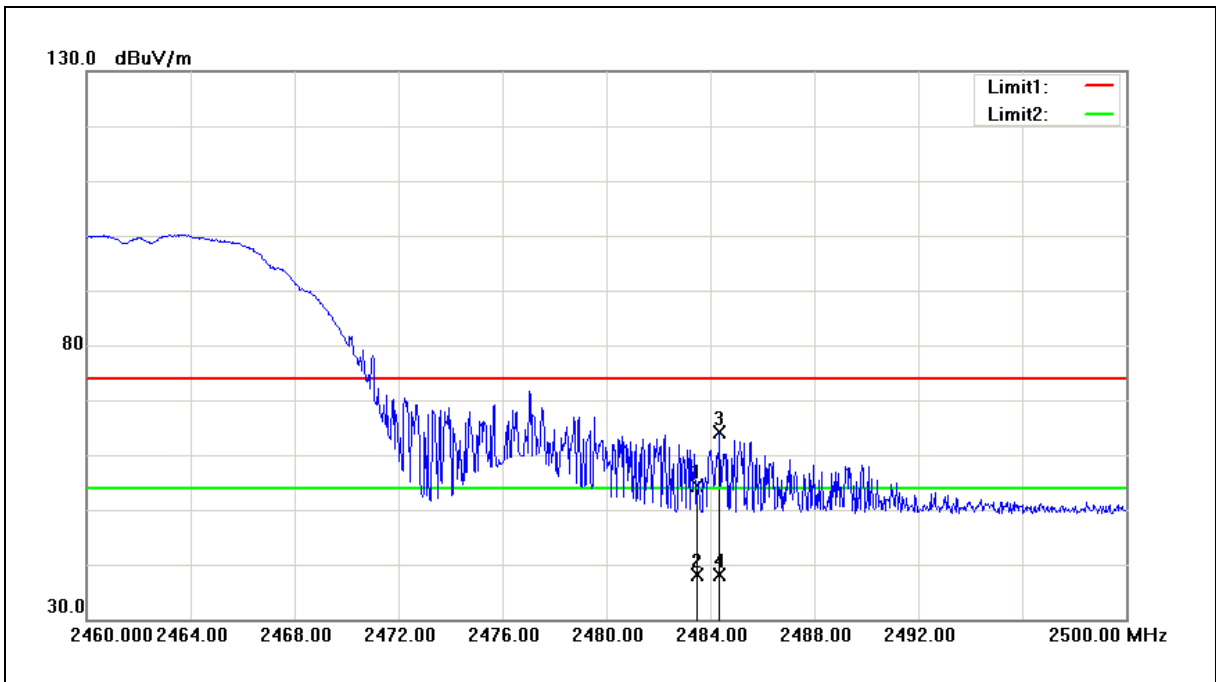

No.	Frequency (MHz)	Reading (dBuV)	Correct Factor (dB/m)	Result (dBuV/m)	Limit (dBuV/m)	Margin (dB)	Remark
1	2483.500	53.75	0.55	54.30	74.00	-19.70	peak
2	2483.500	37.58	0.55	38.13	54.00	-15.87	AVG
3	2484.360	63.65	0.56	64.21	74.00	-9.79	peak
4	2484.360	37.65	0.56	38.21	54.00	-15.79	AVG

Note:1.Result (dBuV/m) = Correct Factor (dB/m) + Reading(dBuV).

2.Correction factor (dB/m) = Antenna Factor (dB/m) + Cable loss (dB) – Pre-Amplifier gain (dB).

3. When the peak results are less than average limit, so not need to evaluate the average.



Standard:	FCC Part 15.247	Test Distance:	3m
Test item:	Band edge	Power:	DC 5V
Frequency:	2462MHz	Temp.(°C)/Hum.(%RH):	26(°C)/60%RH
Mode:	Mode 2	Date:	07/11/2017
Ant.Polar.:	Vertical		
Description:	Antenna Model : EDA-1713-25GC1-A14		

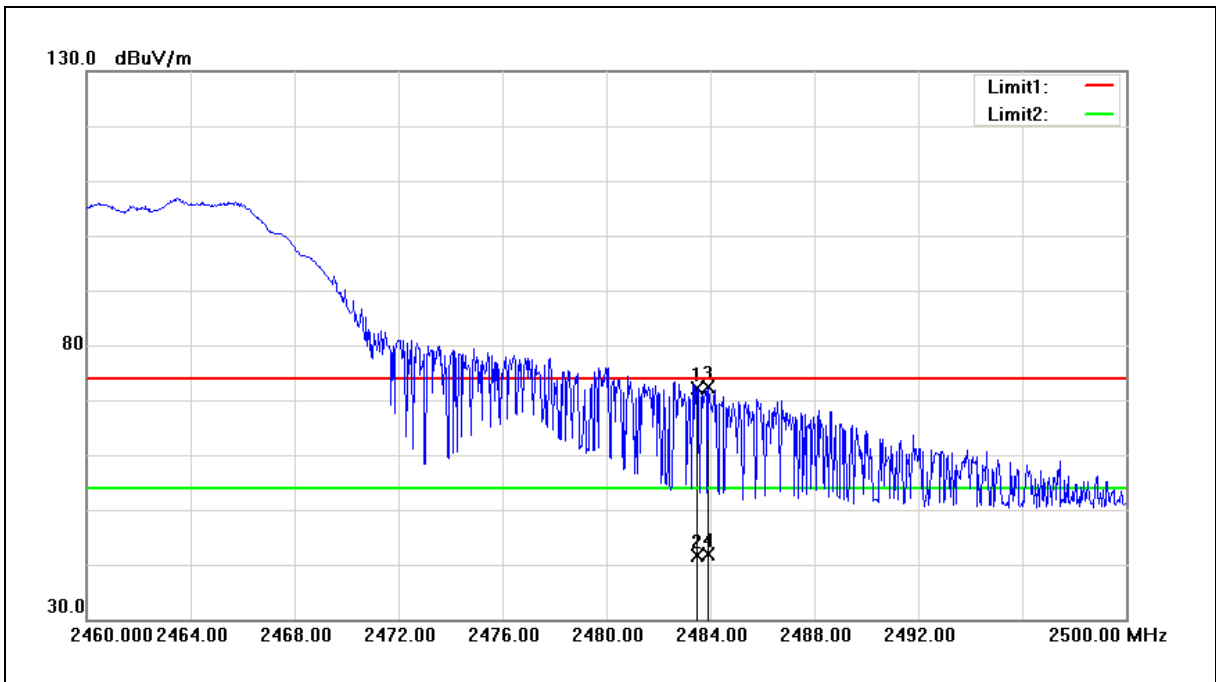

No.	Frequency (MHz)	Reading (dBuV)	Correct Factor (dB/m)	Result (dBuV/m)	Limit (dBuV/m)	Margin (dB)	Remark
1	2483.500	71.65	0.55	72.20	74.00	-1.80	peak
2	2483.500	41.12	0.55	41.67	54.00	-12.33	AVG
3	2483.920	71.81	0.55	72.36	74.00	-1.64	peak
4	2483.920	41.34	0.55	41.89	54.00	-12.11	AVG

Note:1.Result (dBuV/m) = Correct Factor (dB/m) + Reading(dBuV).

2.Correction factor (dB/m) = Antenna Factor (dB/m) + Cable loss (dB) – Pre-Amplifier gain (dB).

3. When the peak results are less than average limit, so not need to evaluate the average.



Standard:	FCC Part 15.247	Test Distance:	3m
Test item:	Band edge	Power:	DC 5V
Frequency:	2412MHz	Temp.(°C)/Hum.(%RH):	26(°C)/60%RH
Mode:	Mode 3	Date:	07/11/2017
Ant.Polar.:	Horizontal		
Description:	Antenna Model : EDA-1713-25GC1-A14		

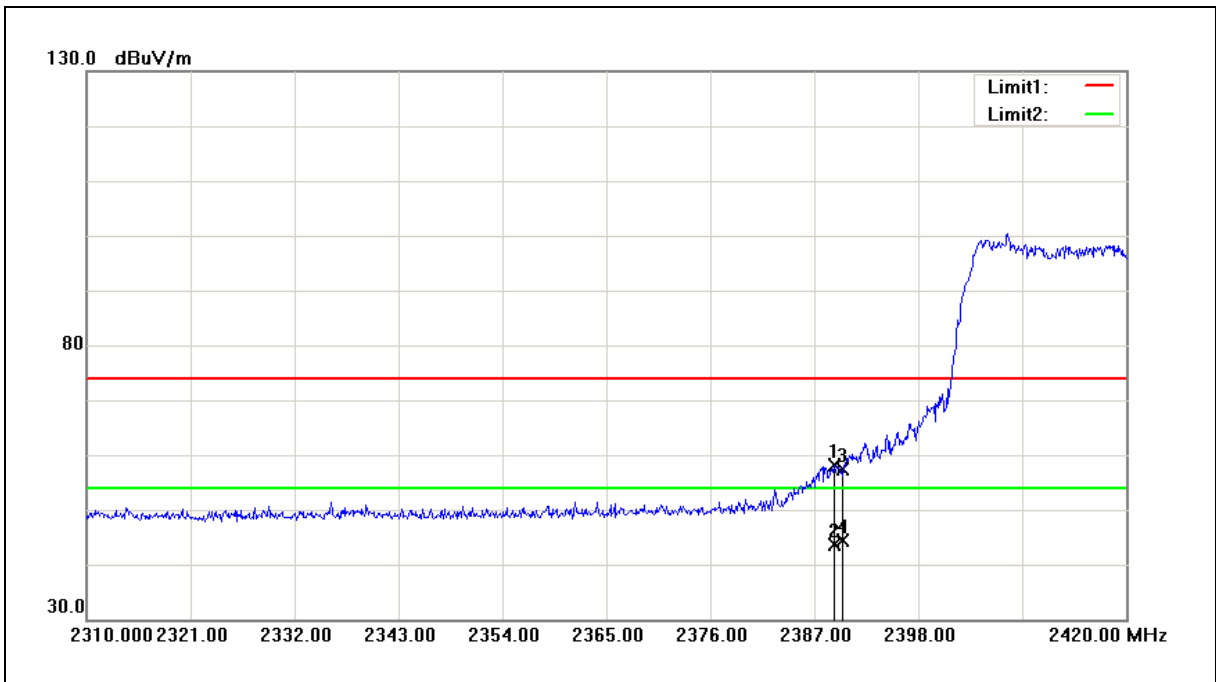

No.	Frequency (MHz)	Reading (dBuV)	Correct Factor (dB/m)	Result (dBuV/m)	Limit (dBuV/m)	Margin (dB)	Remark
1	2389.090	57.97	0.15	58.12	74.00	-15.88	peak
2	2389.090	43.57	0.15	43.72	54.00	-10.28	AVG
3	2390.000	57.19	0.15	57.34	74.00	-16.66	peak
4	2390.000	44.25	0.15	44.40	54.00	-9.60	AVG

Note:1.Result (dBuV/m) = Correct Factor (dB/m) + Reading(dBuV).

2.Correction factor (dB/m) = Antenna Factor (dB/m) + Cable loss (dB) – Pre-Amplifier gain (dB).

3. When the peak results are less than average limit, so not need to evaluate the average.



Standard:	FCC Part 15.247	Test Distance:	3m
Test item:	Band edge	Power:	DC 5V
Frequency:	2412MHz	Temp.(°C)/Hum.(%RH):	26(°C)/60%RH
Mode:	Mode 3	Date:	07/11/2017
Ant.Polar.:	Vertical		
Description:	Antenna Model : EDA-1713-25GC1-A14		

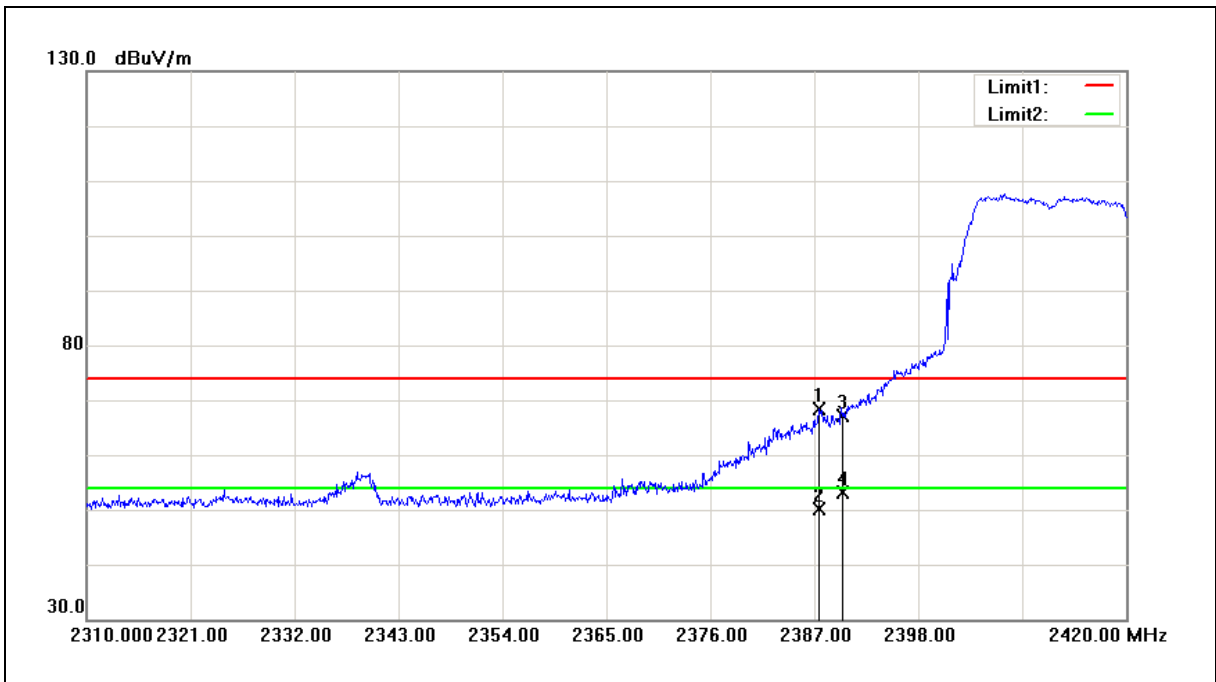

No.	Frequency (MHz)	Reading (dBuV)	Correct Factor (dB/m)	Result (dBuV/m)	Limit (dBuV/m)	Margin (dB)	Remark
1	2387.440	68.34	0.14	68.48	74.00	-5.52	peak
2	2387.440	49.94	0.14	50.08	54.00	-3.92	AVG
3	2390.000	66.90	0.15	67.05	74.00	-6.95	peak
4	2390.000	52.97	0.15	53.12	54.00	-0.88	AVG

Note:1.Result (dBuV/m) = Correct Factor (dB/m) + Reading(dBuV).

2.Correction factor (dB/m) = Antenna Factor (dB/m) + Cable loss (dB) – Pre-Amplifier gain (dB).

3. When the peak results are less than average limit, so not need to evaluate the average.



Standard:	FCC Part 15.247	Test Distance:	3m
Test item:	Band edge	Power:	DC 5V
Frequency:	2437MHz	Temp.(°C)/Hum.(%RH):	26(°C)/60%RH
Mode:	Mode 3	Date:	07/12/2017
Ant.Polar.:	Horizontal		
Description:	Antenna Model : EDA-1713-25GC1-A14		

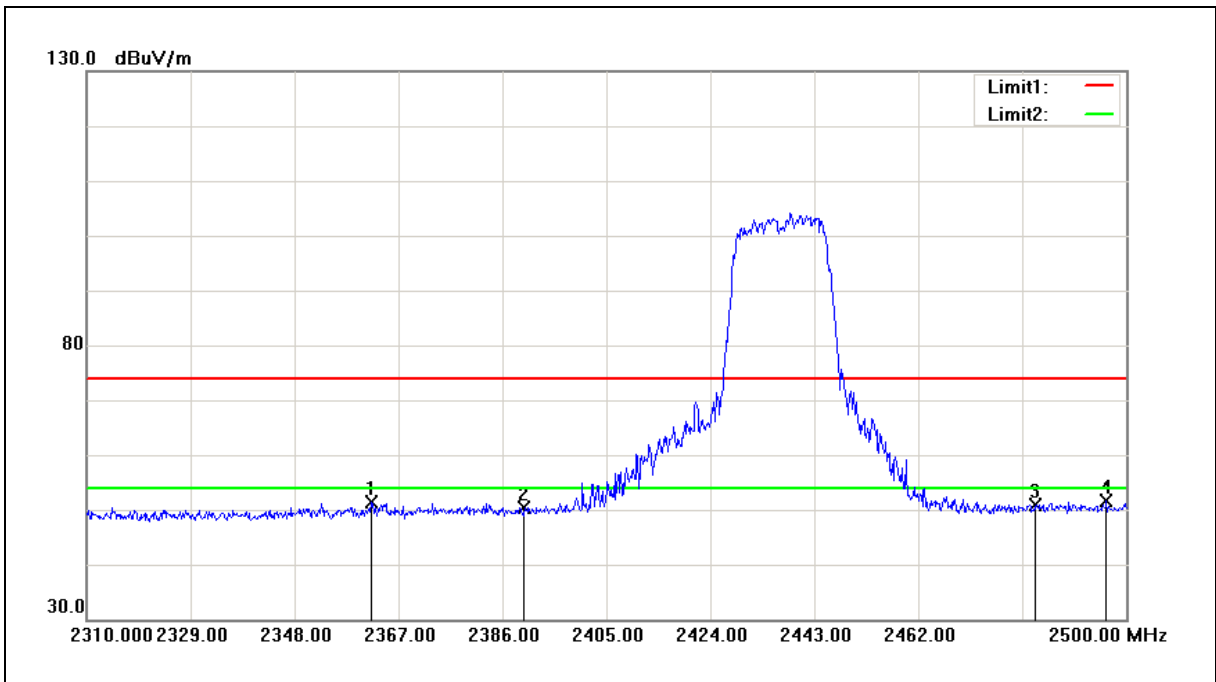

No.	Frequency (MHz)	Reading (dBuV)	Correct Factor (dB/m)	Result (dBuV/m)	Limit (dBuV/m)	Margin (dB)	Remark
1	2362.060	51.28	0.03	51.31	74.00	-22.69	peak
2	2390.000	50.29	0.15	50.44	74.00	-23.56	peak
3	2483.500	50.32	0.55	50.87	74.00	-23.13	peak
4	2496.390	51.03	0.60	51.63	74.00	-22.37	peak

Note:1.Result (dBuV/m) = Correct Factor (dB/m) + Reading(dBuV).

2.Correction factor (dB/m) = Antenna Factor (dB/m) + Cable loss (dB) – Pre-Amplifier gain (dB).

3. When the peak results are less than average limit, so not need to evaluate the average.



Standard:	FCC Part 15.247	Test Distance:	3m
Test item:	Band edge	Power:	DC 5V
Frequency:	2437MHz	Temp.(°C)/Hum.(%RH):	26(°C)/60%RH
Mode:	Mode 3	Date:	07/12/2017
Ant.Polar.:	Vertical		
Description:	Antenna Model : EDA-1713-25GC1-A14		

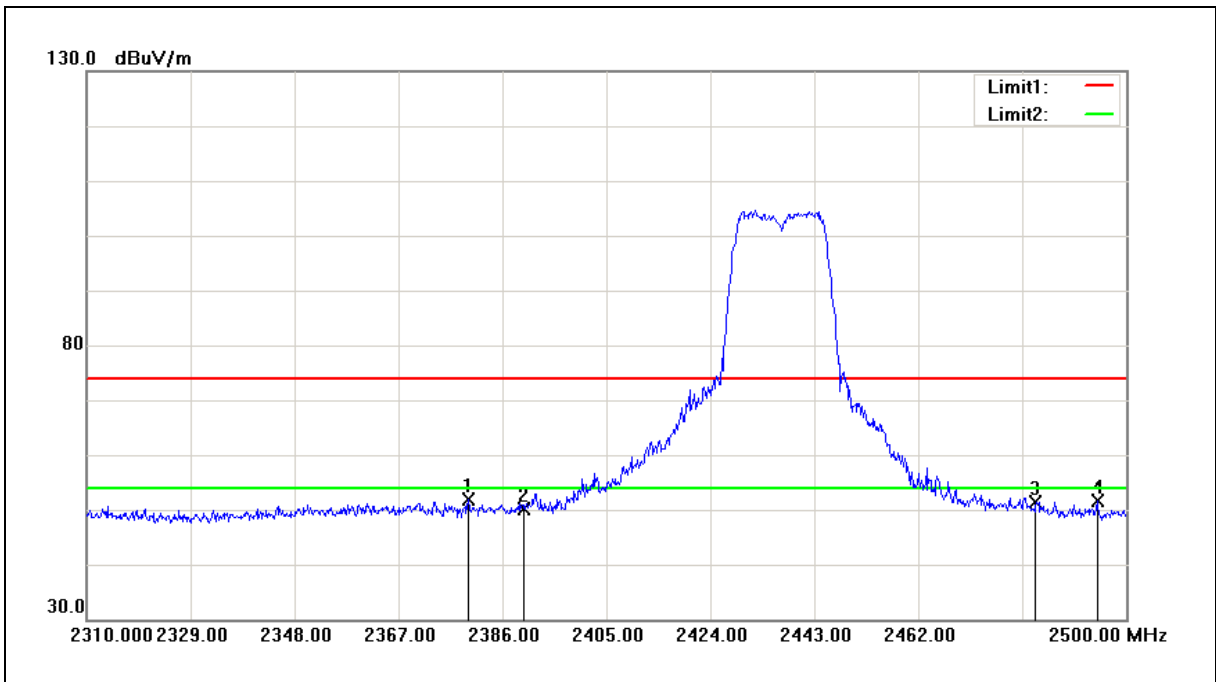

No.	Frequency (MHz)	Reading (dBuV)	Correct Factor (dB/m)	Result (dBuV/m)	Limit (dBuV/m)	Margin (dB)	Remark
1	2379.730	51.74	0.11	51.85	74.00	-22.15	peak
2	2390.000	49.95	0.15	50.10	74.00	-23.90	peak
3	2483.500	50.72	0.55	51.27	74.00	-22.73	peak
4	2494.680	51.03	0.60	51.63	74.00	-22.37	peak

Note:1.Result (dBuV/m) = Correct Factor (dB/m) + Reading(dBuV).

2.Correction factor (dB/m) = Antenna Factor (dB/m) + Cable loss (dB) – Pre-Amplifier gain (dB).

3. When the peak results are less than average limit, so not need to evaluate the average.



Standard:	FCC Part 15.247	Test Distance:	3m
Test item:	Band edge	Power:	DC 5V
Frequency:	2462MHz	Temp.(°C)/Hum.(%RH):	26(°C)/60%RH
Mode:	Mode 3	Date:	07/12/2017
Ant.Polar.:	Horizontal		
Description:	Antenna Model : EDA-1713-25GC1-A14		

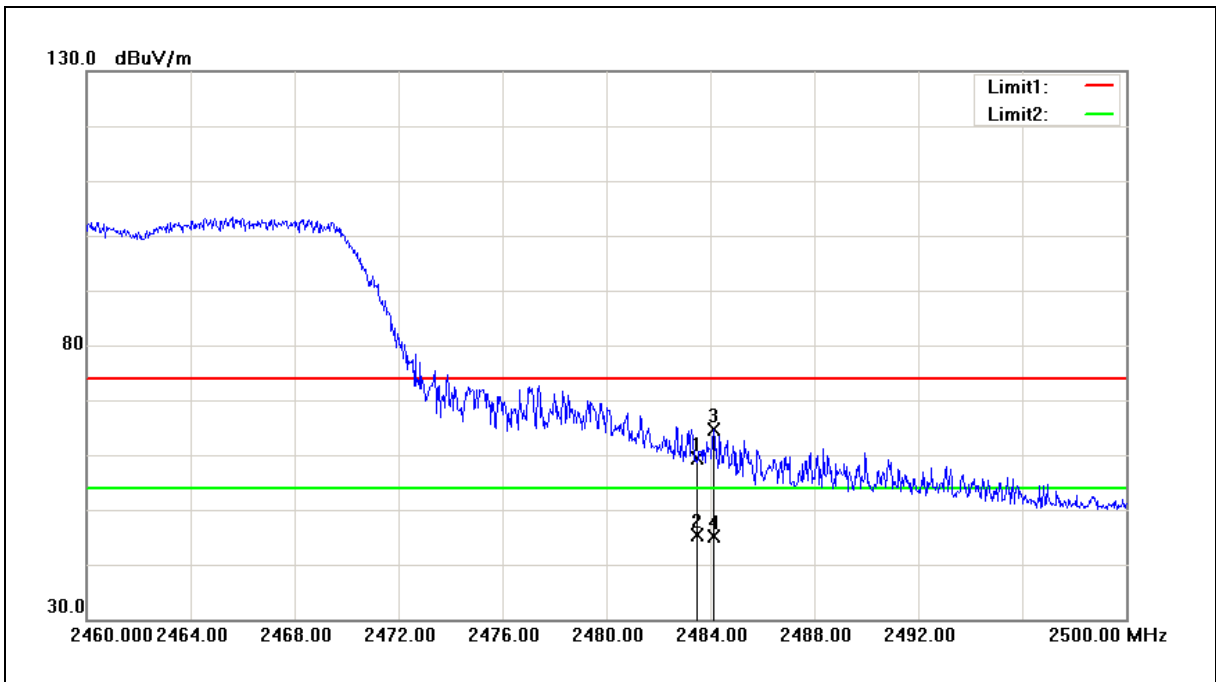

No.	Frequency (MHz)	Reading (dBuV)	Correct Factor (dB/m)	Result (dBuV/m)	Limit (dBuV/m)	Margin (dB)	Remark
1	2483.500	58.91	0.55	59.46	74.00	-14.54	peak
2	2483.500	44.75	0.55	45.30	54.00	-8.70	AVG
3	2484.120	64.13	0.56	64.69	74.00	-9.31	peak
4	2484.120	44.57	0.56	45.13	54.00	-8.87	AVG

Note:1.Result (dBuV/m) = Correct Factor (dB/m) + Reading(dBuV).

2.Correction factor (dB/m) = Antenna Factor (dB/m) + Cable loss (dB) – Pre-Amplifier gain (dB).

3. When the peak results are less than average limit, so not need to evaluate the average.



Standard:	FCC Part 15.247	Test Distance:	3m
Test item:	Band edge	Power:	DC 5V
Frequency:	2462MHz	Temp.(°C)/Hum.(%RH):	26(°C)/60%RH
Mode:	Mode 3	Date:	07/12/2017
Ant.Polar.:	Vertical		
Description:	Antenna Model : EDA-1713-25GC1-A14		

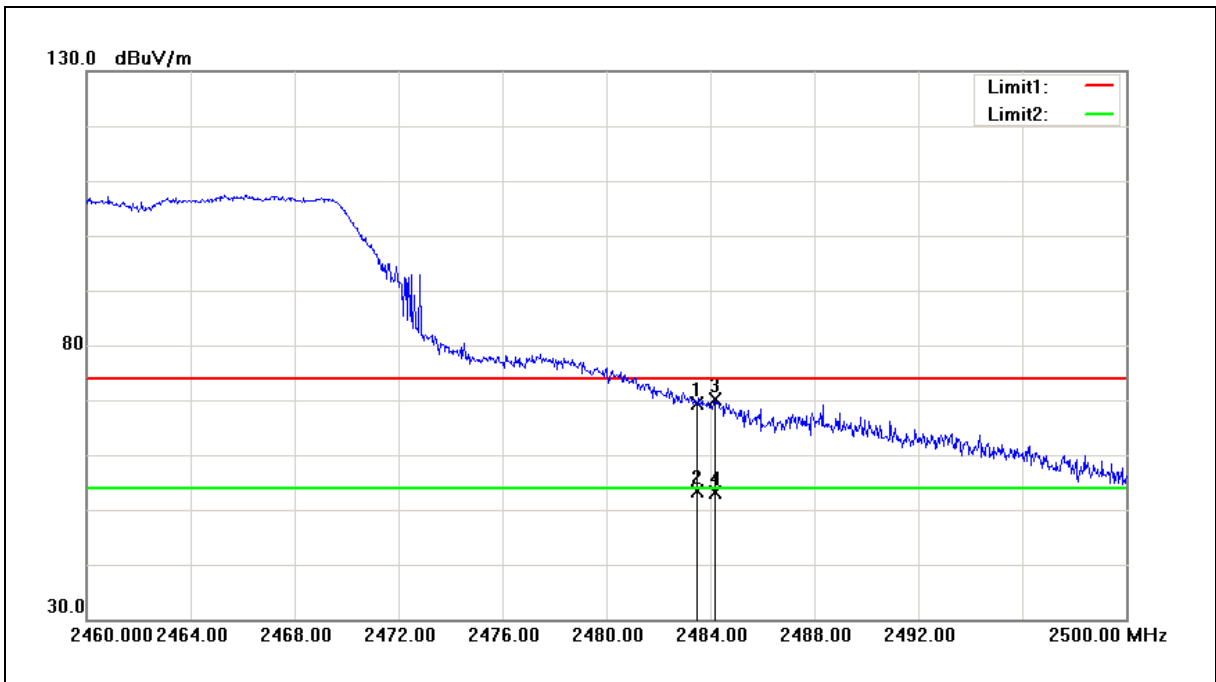

No.	Frequency (MHz)	Reading (dBuV)	Correct Factor (dB/m)	Result (dBuV/m)	Limit (dBuV/m)	Margin (dB)	Remark
1	2483.500	68.80	0.55	69.35	74.00	-4.65	peak
2	2483.500	52.93	0.55	53.48	54.00	-0.52	AVG
3	2484.200	69.64	0.56	70.20	74.00	-3.80	peak
4	2484.200	52.56	0.56	53.12	54.00	-0.88	AVG

Note:1.Result (dBuV/m) = Correct Factor (dB/m) + Reading(dBuV).

2.Correction factor (dB/m) = Antenna Factor (dB/m) + Cable loss (dB) – Pre-Amplifier gain (dB).

3. When the peak results are less than average limit, so not need to evaluate the average.



Standard:	FCC Part 15.247	Test Distance:	3m
Test item:	Band edge	Power:	DC 5V
Frequency:	2412MHz	Temp.(°C)/Hum.(%RH):	26(°C)/60%RH
Mode:	Mode 4	Date:	07/12/2017
Ant.Polar.:	Horizontal		
Description:	Antenna Model : EDA-1713-25GC1-A14		

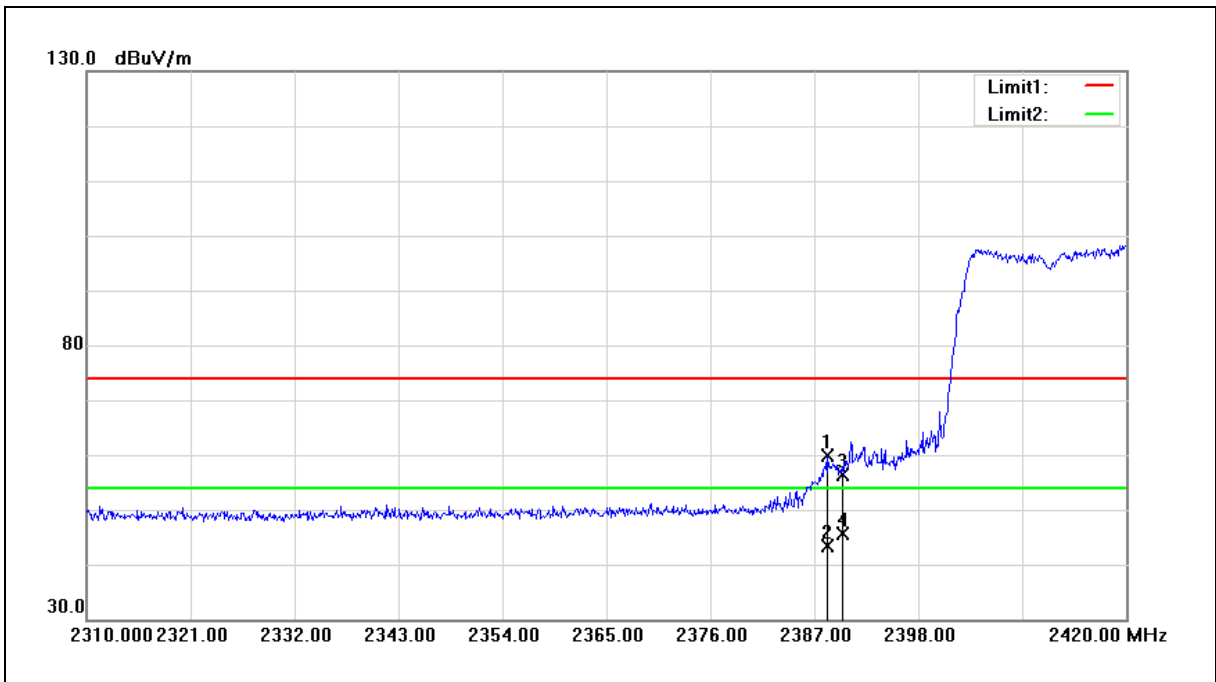

No.	Frequency (MHz)	Reading (dBuV)	Correct Factor (dB/m)	Result (dBuV/m)	Limit (dBuV/m)	Margin (dB)	Remark
1	2388.320	59.74	0.15	59.89	74.00	-14.11	peak
2	2388.320	43.13	0.15	43.28	54.00	-10.72	AVG
3	2390.000	56.25	0.15	56.40	74.00	-17.60	peak
4	2390.000	45.39	0.15	45.54	54.00	-8.46	AVG

Note:1.Result (dBuV/m) = Correct Factor (dB/m) + Reading(dBuV).

2.Correction factor (dB/m) = Antenna Factor (dB/m) + Cable loss (dB) – Pre-Amplifier gain (dB).

3. When the peak results are less than average limit, so not need to evaluate the average.



Standard:	FCC Part 15.247	Test Distance:	3m
Test item:	Band edge	Power:	DC 5V
Frequency:	2412MHz	Temp.(°C)/Hum.(%RH):	26(°C)/60%RH
Mode:	Mode 4	Date:	07/12/2017
Ant.Polar.:	Vertical		
Description:	Antenna Model : EDA-1713-25GC1-A14		

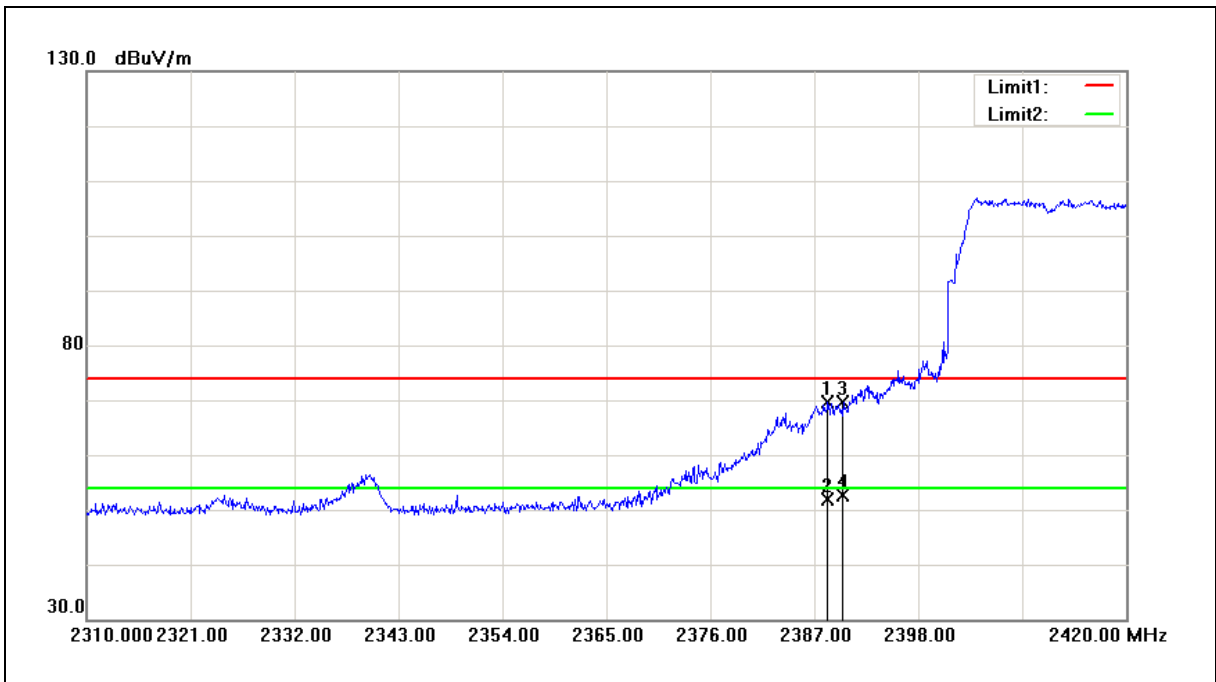

No.	Frequency (MHz)	Reading (dBuV)	Correct Factor (dB/m)	Result (dBuV/m)	Limit (dBuV/m)	Margin (dB)	Remark
1	2388.430	69.47	0.15	69.62	74.00	-4.38	peak
2	2388.430	51.79	0.15	51.94	54.00	-2.06	AVG
3	2390.000	69.36	0.15	69.51	74.00	-4.49	peak
4	2390.000	52.60	0.15	52.75	54.00	-1.25	AVG

Note:1.Result (dBuV/m) = Correct Factor (dB/m) + Reading(dBuV).

2.Correction factor (dB/m) = Antenna Factor (dB/m) + Cable loss (dB) – Pre-Amplifier gain (dB).

3. When the peak results are less than average limit, so not need to evaluate the average.



Standard:	FCC Part 15.247	Test Distance:	3m
Test item:	Band edge	Power:	DC 5V
Frequency:	2437MHz	Temp.(°C)/Hum.(%RH):	26(°C)/60%RH
Mode:	Mode 4	Date:	07/12/2017
Ant.Polar.:	Horizontal		
Description:	Antenna Model : EDA-1713-25GC1-A14		

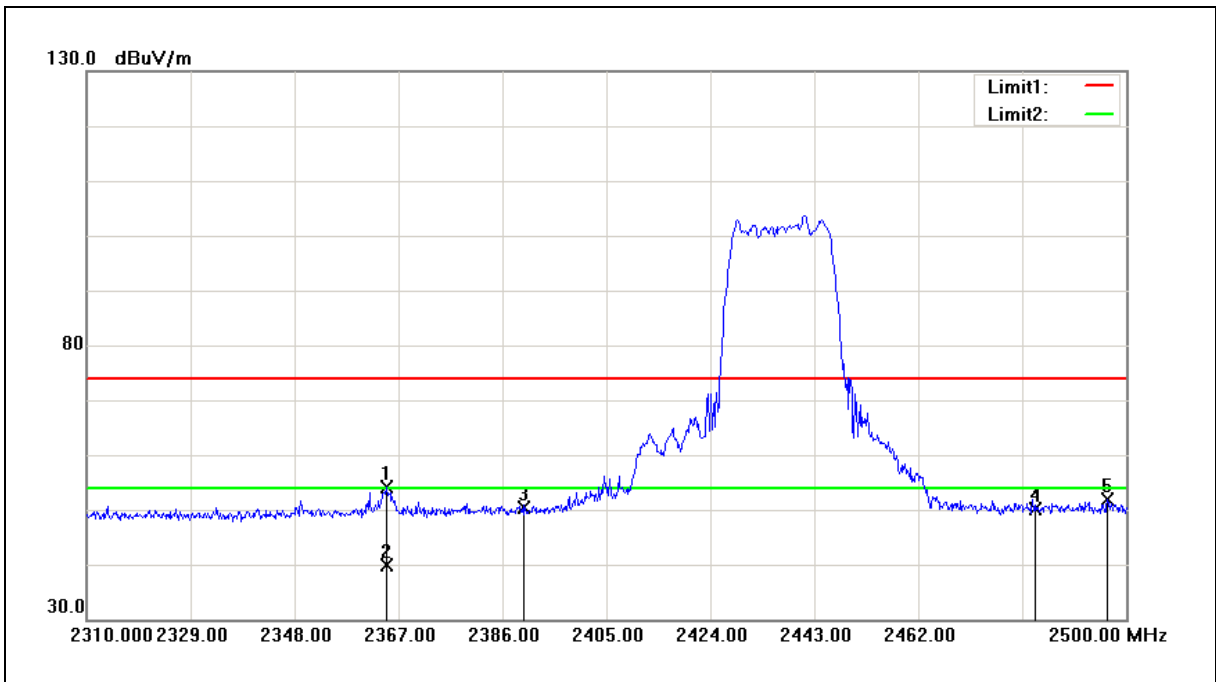

No.	Frequency (MHz)	Reading (dBuV)	Correct Factor (dB/m)	Result (dBuV/m)	Limit (dBuV/m)	Margin (dB)	Remark
1	2364.720	54.11	0.05	54.16	74.00	-19.84	peak
2	2364.720	39.81	0.05	39.86	54.00	-14.14	AVG
3	2390.000	50.14	0.15	50.29	74.00	-23.71	peak
4	2483.500	49.64	0.55	50.19	74.00	-23.81	peak
5	2496.580	51.22	0.60	51.82	74.00	-22.18	peak

Note:1.Result (dBuV/m) = Correct Factor (dB/m) + Reading(dBuV).

2.Correction factor (dB/m) = Antenna Factor (dB/m) + Cable loss (dB) – Pre-Amplifier gain (dB).

3. When the peak results are less than average limit, so not need to evaluate the average.



Standard:	FCC Part 15.247	Test Distance:	3m
Test item:	Band edge	Power:	DC 5V
Frequency:	2437MHz	Temp.(°C)/Hum.(%RH):	26(°C)/60%RH
Mode:	Mode 4	Date:	07/12/2017
Ant.Polar.:	Vertical		
Description:	Antenna Model : EDA-1713-25GC1-A14		

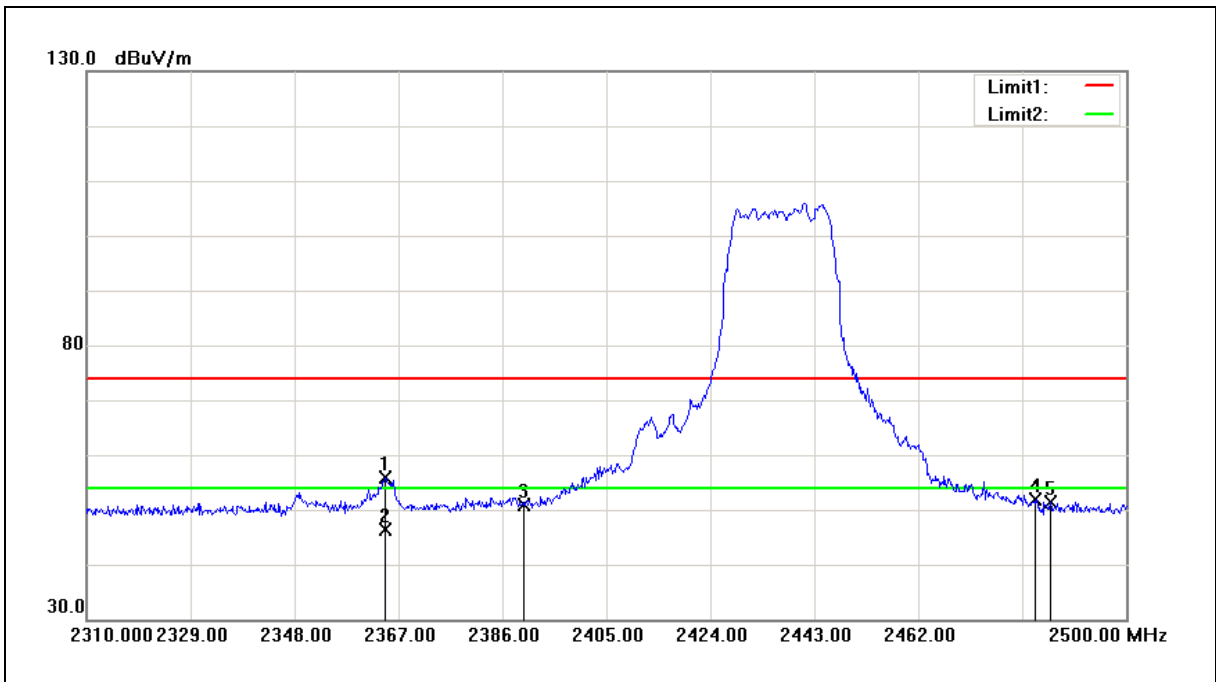

No.	Frequency (MHz)	Reading (dBuV)	Correct Factor (dB/m)	Result (dBuV/m)	Limit (dBuV/m)	Margin (dB)	Remark
1	2364.530	55.80	0.05	55.85	74.00	-18.15	peak
2	2364.530	46.21	0.05	46.26	54.00	-7.74	AVG
3	2390.000	50.74	0.15	50.89	74.00	-23.11	peak
4	2483.500	51.29	0.55	51.84	74.00	-22.16	peak
5	2486.130	50.90	0.56	51.46	74.00	-22.54	peak

Note:1.Result (dBuV/m) = Correct Factor (dB/m) + Reading(dBuV).

2.Correction factor (dB/m) = Antenna Factor (dB/m) + Cable loss (dB) – Pre-Amplifier gain (dB).

3. When the peak results are less than average limit, so not need to evaluate the average.



Standard:	FCC Part 15.247	Test Distance:	3m
Test item:	Band edge	Power:	DC 5V
Frequency:	2462MHz	Temp.(°C)/Hum.(%RH):	26(°C)/60%RH
Mode:	Mode 4	Date:	07/12/2017
Ant.Polar.:	Horizontal		
Description:	Antenna Model : EDA-1713-25GC1-A14		

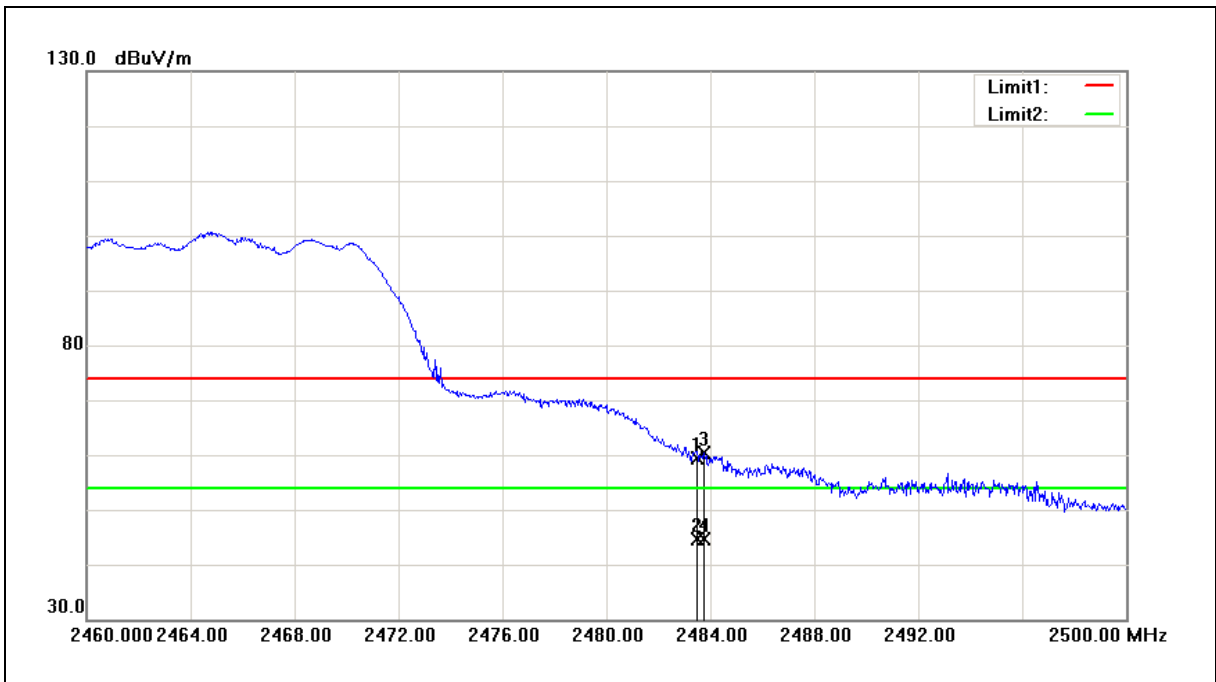

No.	Frequency (MHz)	Reading (dBuV)	Correct Factor (dB/m)	Result (dBuV/m)	Limit (dBuV/m)	Margin (dB)	Remark
1	2483.500	58.89	0.55	59.44	74.00	-14.56	peak
2	2483.500	44.08	0.55	44.63	54.00	-9.37	AVG
3	2483.760	59.85	0.55	60.40	74.00	-13.60	peak
4	2483.760	44.03	0.55	44.58	54.00	-9.42	AVG

Note:1.Result (dBuV/m) = Correct Factor (dB/m) + Reading(dBuV).

2.Correction factor (dB/m) = Antenna Factor (dB/m) + Cable loss (dB) – Pre-Amplifier gain (dB).

3. When the peak results are less than average limit, so not need to evaluate the average.



Standard:	FCC Part 15.247	Test Distance:	3m
Test item:	Band edge	Power:	DC 5V
Frequency:	2462MHz	Temp.(°C)/Hum.(%RH):	26(°C)/60%RH
Mode:	Mode 4	Date:	07/12/2017
Ant.Polar.:	Vertical		
Description:	Antenna Model : EDA-1713-25GC1-A14		

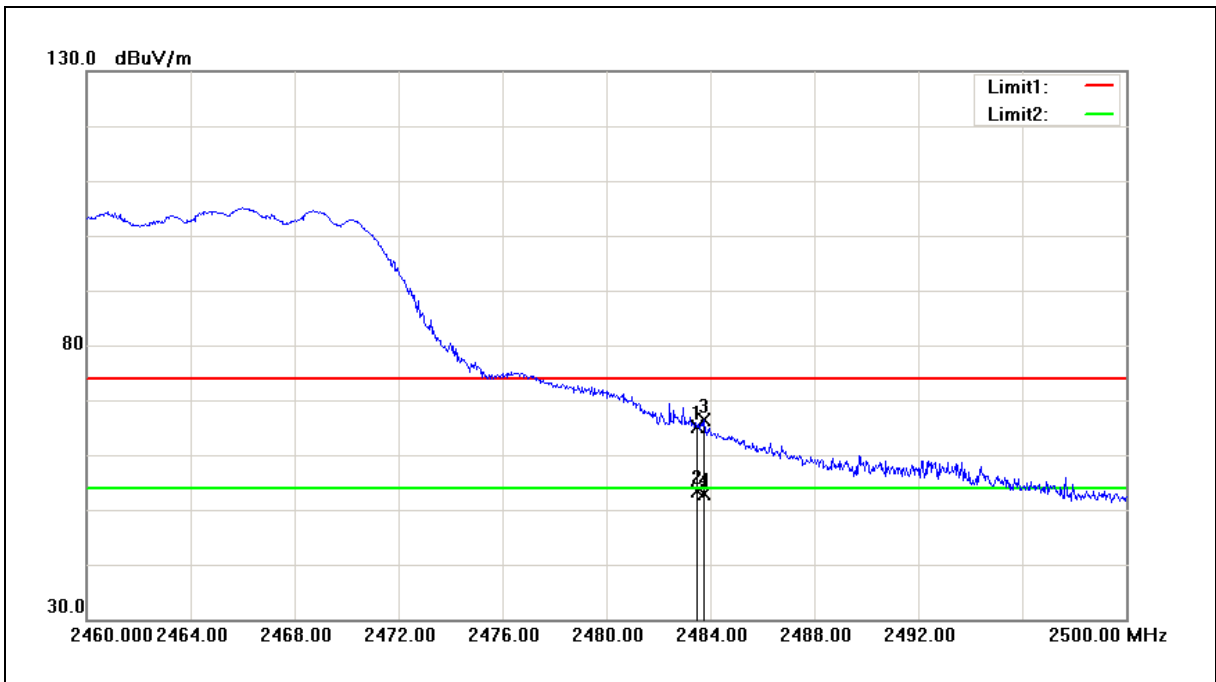

No.	Frequency (MHz)	Reading (dBuV)	Correct Factor (dB/m)	Result (dBuV/m)	Limit (dBuV/m)	Margin (dB)	Remark
1	2483.500	64.48	0.55	65.03	74.00	-8.97	peak
2	2483.500	52.77	0.55	53.32	54.00	-0.68	AVG
3	2483.760	65.81	0.55	66.36	74.00	-7.64	peak
4	2483.760	52.26	0.55	52.81	54.00	-1.19	AVG

Note:1.Result (dBuV/m) = Correct Factor (dB/m) + Reading(dBuV).

2.Correction factor (dB/m) = Antenna Factor (dB/m) + Cable loss (dB) – Pre-Amplifier gain (dB).

3. When the peak results are less than average limit, so not need to evaluate the average.



Standard:	FCC Part 15.247	Test Distance:	3m
Test item:	Band edge	Power:	DC 5V
Frequency:	2422MHz	Temp.(°C)/Hum.(%RH):	26(°C)/60%RH
Mode:	Mode 5	Date:	07/12/2017
Ant.Polar.:	Horizontal		
Description:	Antenna Model : EDA-1713-25GC1-A14		

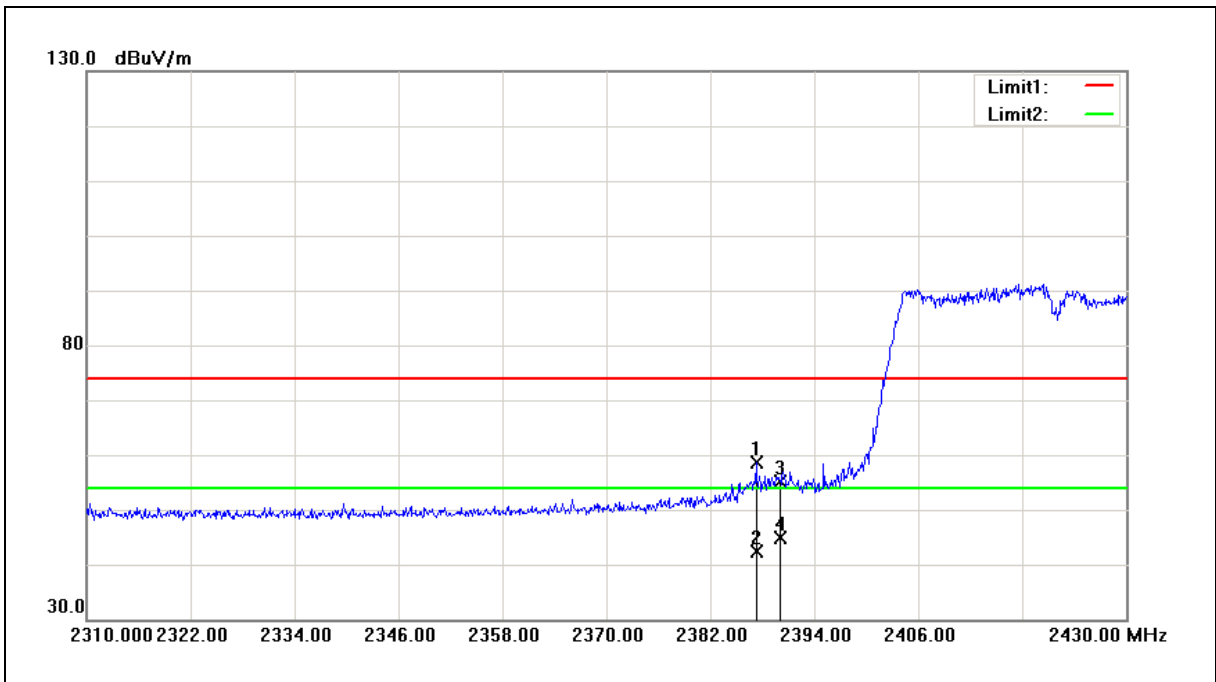

No.	Frequency (MHz)	Reading (dBuV)	Correct Factor (dB/m)	Result (dBuV/m)	Limit (dBuV/m)	Margin (dB)	Remark
1	2387.280	58.58	0.14	58.72	74.00	-15.28	peak
2	2387.280	42.34	0.14	42.48	54.00	-11.52	AVG
3	2390.000	55.10	0.15	55.25	74.00	-18.75	peak
4	2390.000	44.64	0.15	44.79	54.00	-9.21	AVG

Note:1.Result (dBuV/m) = Correct Factor (dB/m) + Reading(dBuV).

2.Correction factor (dB/m) = Antenna Factor (dB/m) + Cable loss (dB) – Pre-Amplifier gain (dB).

3. When the peak results are less than average limit, so not need to evaluate the average.



Standard:	FCC Part 15.247	Test Distance:	3m
Test item:	Band edge	Power:	DC 5V
Frequency:	2422MHz	Temp.(°C)/Hum.(%RH):	26(°C)/60%RH
Mode:	Mode 5	Date:	07/12/2017
Ant.Polar.:	Vertical		
Description:	Antenna Model : EDA-1713-25GC1-A14		

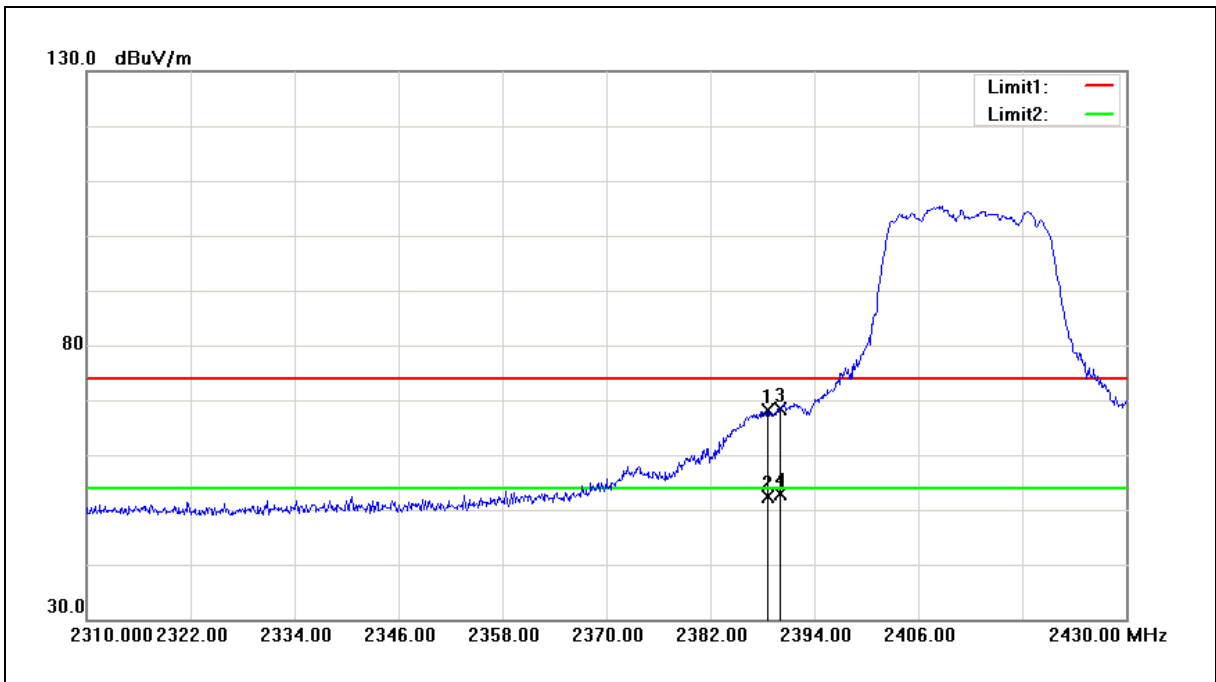

No.	Frequency (MHz)	Reading (dBuV)	Correct Factor (dB/m)	Result (dBuV/m)	Limit (dBuV/m)	Margin (dB)	Remark
1	2388.600	68.06	0.15	68.21	74.00	-5.79	peak
2	2388.600	52.11	0.15	52.26	54.00	-1.74	AVG
3	2390.000	68.21	0.15	68.36	74.00	-5.64	peak
4	2390.000	52.83	0.15	52.98	54.00	-1.02	AVG

Note:1.Result (dBuV/m) = Correct Factor (dB/m) + Reading(dBuV).

2.Correction factor (dB/m) = Antenna Factor (dB/m) + Cable loss (dB) – Pre-Amplifier gain (dB).

3. When the peak results are less than average limit, so not need to evaluate the average.



Standard:	FCC Part 15.247	Test Distance:	3m
Test item:	Band edge	Power:	DC 5V
Frequency:	2437MHz	Temp.(°C)/Hum.(%RH):	26(°C)/60%RH
Mode:	Mode 5	Date:	07/12/2017
Ant.Polar.:	Horizontal		
Description:	Antenna Model : EDA-1713-25GC1-A14		

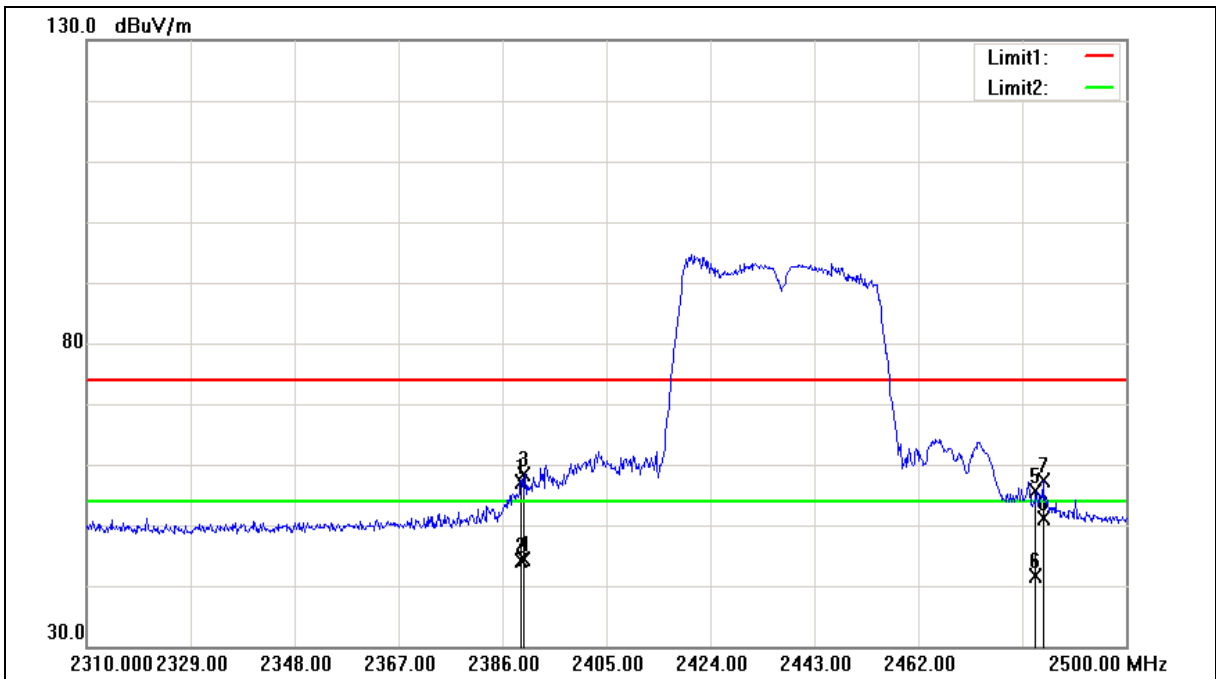

No.	Frequency (MHz)	Reading (dBuV)	Correct Factor (dB/m)	Result (dBuV/m)	Limit (dBuV/m)	Margin (dB)	Remark
1	2389.420	56.93	0.15	57.08	74.00	-16.92	peak
2	2389.420	44.04	0.15	44.19	54.00	-9.81	AVG
3	2390.000	58.15	0.15	58.30	74.00	-15.70	peak
4	2390.000	44.15	0.15	44.30	54.00	-9.70	AVG
5	2483.500	55.03	0.55	55.58	74.00	-18.42	peak
6	2483.500	40.98	0.55	41.53	54.00	-12.47	AVG
7	2484.800	56.72	0.56	57.28	74.00	-16.72	peak
8	2484.800	50.67	0.56	51.23	54.00	-2.77	AVG

Note:1.Result (dBuV/m) = Correct Factor (dB/m) + Reading(dBuV).

2.Correction factor (dB/m) = Antenna Factor (dB/m) + Cable loss (dB) – Pre-Amplifier gain (dB).

3. When the peak results are less than average limit, so not need to evaluate the average.



Standard:	FCC Part 15.247	Test Distance:	3m
Test item:	Band edge	Power:	DC 5V
Frequency:	2437MHz	Temp.(°C)/Hum.(%RH):	26(°C)/60%RH
Mode:	Mode 5	Date:	07/12/2017
Ant.Polar.:	Vertical		
Description:	Antenna Model : EDA-1713-25GC1-A14		

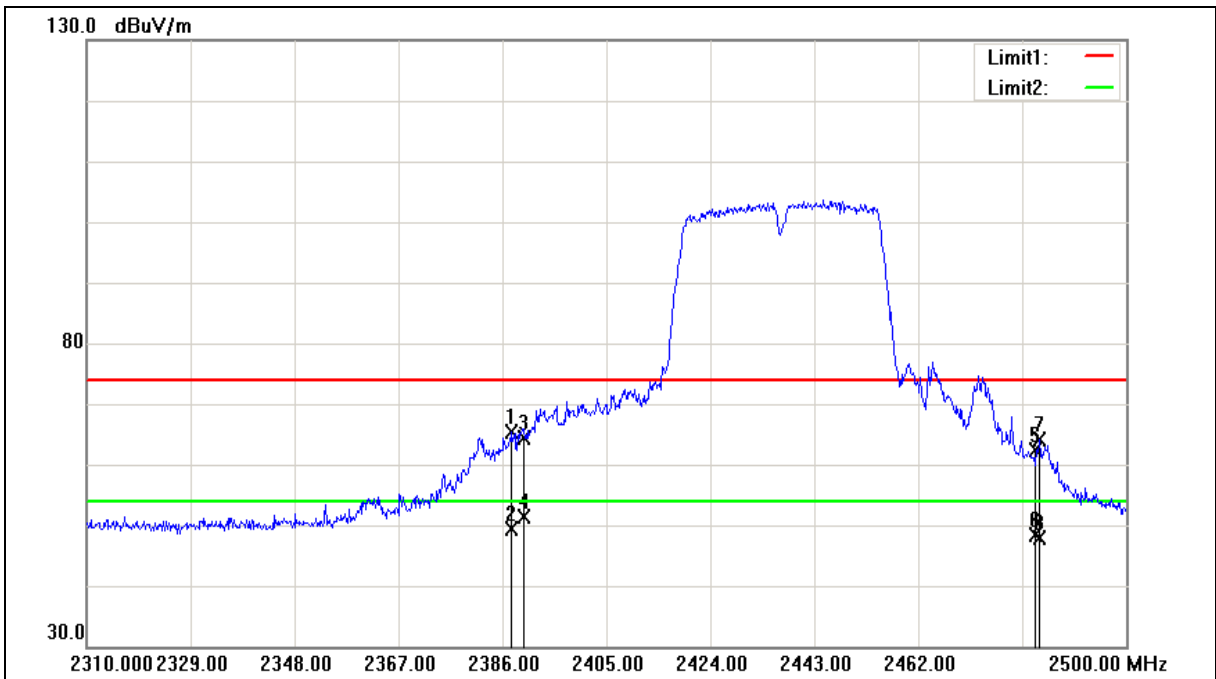

No.	Frequency (MHz)	Reading (dBuV)	Correct Factor (dB/m)	Result (dBuV/m)	Limit (dBuV/m)	Margin (dB)	Remark
1	2387.710	65.20	0.15	65.35	74.00	-8.65	peak
2	2387.710	49.30	0.15	49.45	54.00	-4.55	AVG
3	2390.000	64.31	0.15	64.46	74.00	-9.54	peak
4	2390.000	51.19	0.15	51.34	54.00	-2.66	AVG
5	2483.500	61.86	0.55	62.41	74.00	-11.59	peak
6	2483.500	47.75	0.55	48.30	54.00	-5.70	AVG
7	2484.230	63.67	0.56	64.23	74.00	-9.77	peak
8	2484.230	47.29	0.56	47.85	54.00	-6.15	AVG

Note:1.Result (dBuV/m) = Correct Factor (dB/m) + Reading(dBuV).

2.Correction factor (dB/m) = Antenna Factor (dB/m) + Cable loss (dB) – Pre-Amplifier gain (dB).

3. When the peak results are less than average limit, so not need to evaluate the average.



Standard:	FCC Part 15.247	Test Distance:	3m
Test item:	Band edge	Power:	DC 5V
Frequency:	2452MHz	Temp.(°C)/Hum.(%RH):	26(°C)/60%RH
Mode:	Mode 5	Date:	07/12/2017
Ant.Polar.:	Horizontal		
Description:	Antenna Model : EDA-1713-25GC1-A14		

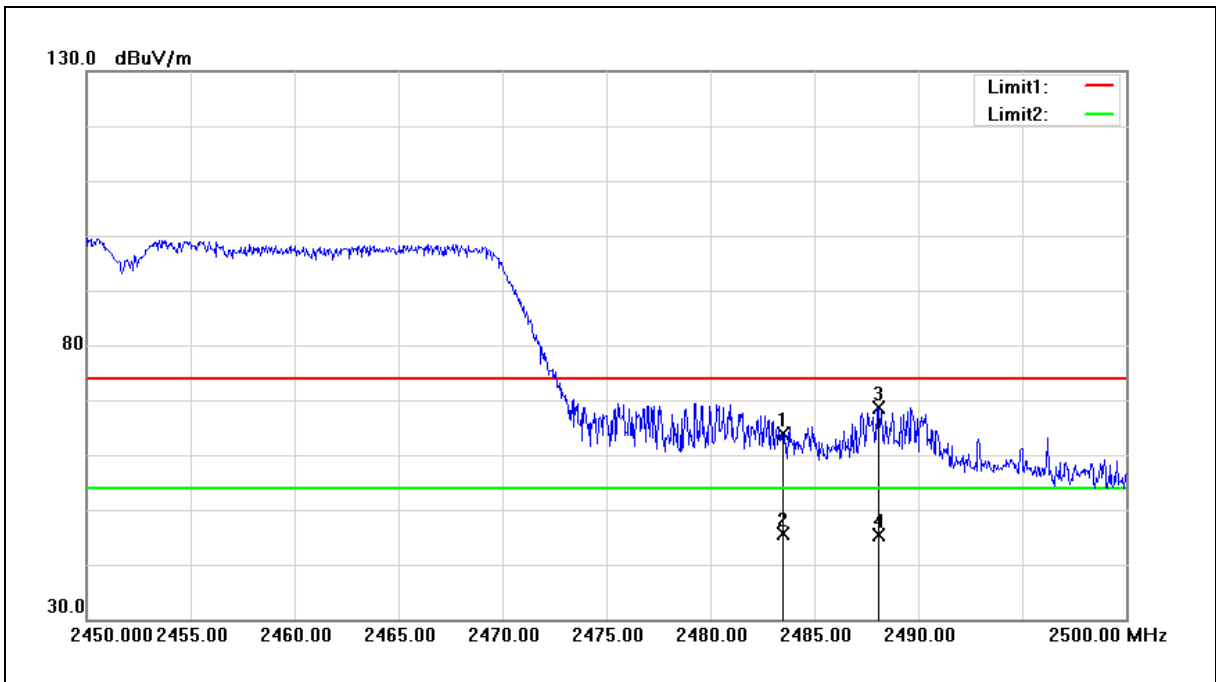

No.	Frequency (MHz)	Reading (dBuV)	Correct Factor (dB/m)	Result (dBuV/m)	Limit (dBuV/m)	Margin (dB)	Remark
1	2483.500	63.44	0.55	63.99	74.00	-10.01	peak
2	2483.500	45.16	0.55	45.71	54.00	-8.29	AVG
3	2488.100	68.18	0.57	68.75	74.00	-5.25	peak
4	2488.100	44.75	0.57	45.32	54.00	-8.68	AVG

Note:1.Result (dBuV/m) = Correct Factor (dB/m) + Reading(dBuV).

2.Correction factor (dB/m) = Antenna Factor (dB/m) + Cable loss (dB) – Pre-Amplifier gain (dB).

3. When the peak results are less than average limit, so not need to evaluate the average.



Standard:	FCC Part 15.247	Test Distance:	3m
Test item:	Band edge	Power:	DC 5V
Frequency:	2452MHz	Temp.(°C)/Hum.(%RH):	26(°C)/60%RH
Mode:	Mode 5	Date:	07/12/2017
Ant.Polar.:	Vertical		
Description:	Antenna Model : EDA-1713-25GC1-A14		

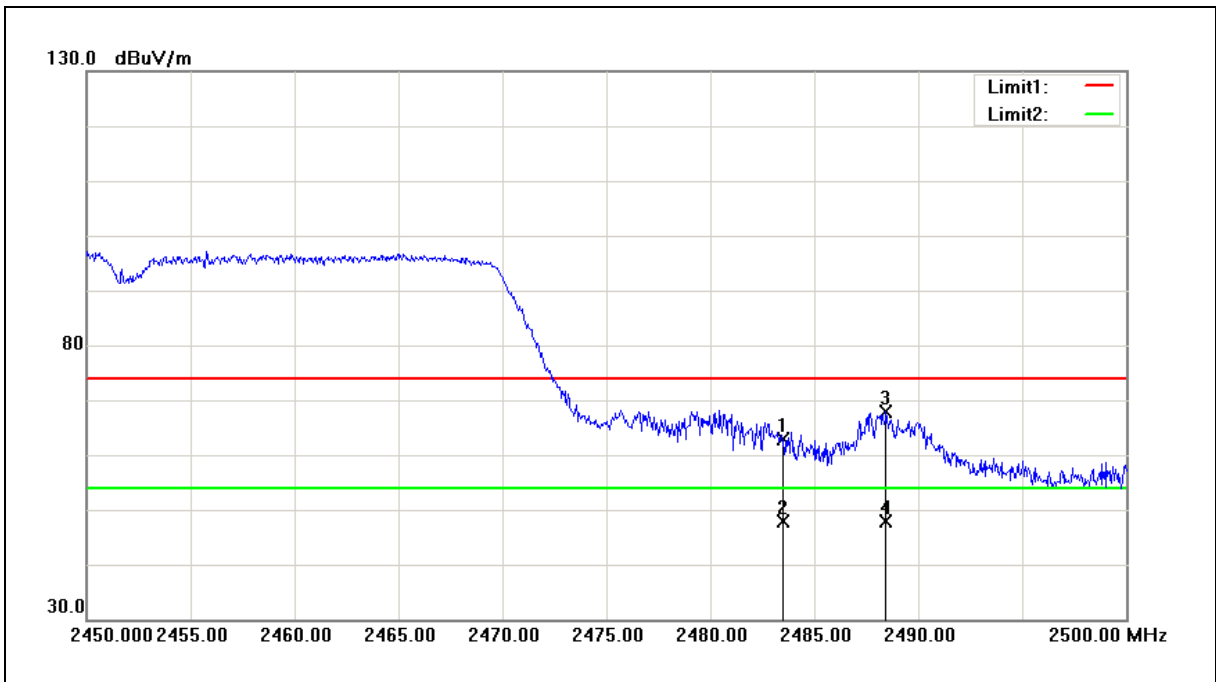

No.	Frequency (MHz)	Reading (dBuV)	Correct Factor (dB/m)	Result (dBuV/m)	Limit (dBuV/m)	Margin (dB)	Remark
1	2483.500	62.32	0.55	62.87	74.00	-11.13	peak
2	2483.500	47.43	0.55	47.98	54.00	-6.02	AVG
3	2488.450	67.28	0.57	67.85	74.00	-6.15	peak
4	2488.450	47.25	0.57	47.82	54.00	-6.18	AVG

Note:1.Result (dBuV/m) = Correct Factor (dB/m) + Reading(dBuV).

2.Correction factor (dB/m) = Antenna Factor (dB/m) + Cable loss (dB) – Pre-Amplifier gain (dB).

3. When the peak results are less than average limit, so not need to evaluate the average.

5 Maximum Conducted Output Power Measurement

5.1. Limit

For systems using digital modulation in the 2400-2483.5MHz, the limit for maximum output power is 30dBm.

And According to 15.247 (b), if transmitting antennas of directional gain greater than 6 dBi are used, the power shall be reduced by the amount in dB that the directional gain of the antenna exceeds 6dBi.

Diversity mode = Max. Gain = 5.17 dBi < 6 dBi.

5.2. Test Setup

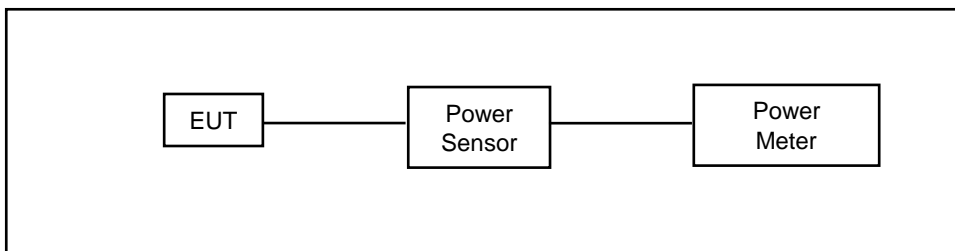

5.3. Test Instruments

Equipment	Manufacturer	Model Number	Serial Number	Cal. Date	Cal. Period
Power Sensor	Anritsu	MA2411B	1126022	08/29/2016	1 year
Power Meter	Anritsu	ML2495A	1135009	08/29/2016	1 year
Microwave Cable	EMCI	EMC104-SM-SM-1500	140303	02/22/2017	1 year
Test Site	ATL	TE05	TE05	N.C.R.	-----

Note: N.C.R. = No Calibration Request.

5.4. Test Procedure

The tests below are run with the EUT's transmitter set at high power in TX mode. The EUT is needed to force selection of output power level and channel number. While testing, EUT was set to transmit continuously. Remove the Subjective device's antenna and connect the RF output port to power sensor.

5.5. Test Result

Test Item	Maximum Conducted Output Power						
Test Mode	Data Rate (Mbps)	Frequency (MHz)	Average Output Power				
			Measurement Results				
			ANT-0		ANT-1		Limit
			dBm	W	dBm	W	dBm
Mode 2	1	2412	15.27	0.034	15.19	0.033	< 30
		2437	15.74	0.037	15.72	0.037	< 30
		2462	15.38	0.035	15.28	0.034	< 30
	2	2437	15.70	0.037	15.65	0.037	< 30
	5.5	2437	15.65	0.037	15.63	0.037	< 30
	11	2437	15.62	0.036	15.58	0.036	< 30
Mode 3	6	2412	14.55	0.029	14.51	0.028	< 30
		2437	14.70	0.030	14.66	0.029	< 30
		2462	13.87	0.024	13.77	0.024	< 30
	9	2437	14.65	0.029	14.61	0.029	< 30
	12	2437	14.62	0.029	14.58	0.029	< 30
	18	2437	14.60	0.029	14.53	0.028	< 30
	24	2437	14.56	0.029	14.52	0.028	< 30
	36	2437	14.54	0.028	14.48	0.028	< 30
	48	2437	14.51	0.028	14.42	0.028	< 30
	54	2437	14.49	0.028	14.41	0.028	< 30

Note: The relevant measured result has the offset with cable loss already.



Test Item	Maximum Conducted Output Power						
Test Mode	Data Rate (Mbps)	Frequency (MHz)	Average Output Power				Limit
			Measurement Results				
			ANT-0		ANT-1		
			dBm	W	dBm	W	
Mode 4	6.5M	2412	13.73	0.024	13.64	0.023	< 30
		2437	13.16	0.021	13.11	0.020	< 30
		2462	12.48	0.018	12.47	0.018	< 30
	14.4M	2437	13.13	0.021	13.08	0.020	< 30
	21.7M	2437	13.10	0.020	13.05	0.020	< 30
	28.9M	2437	13.06	0.020	13.00	0.020	< 30
	43.3M	2437	13.04	0.020	12.97	0.020	< 30
	57.8M	2437	13.01	0.020	12.92	0.020	< 30
	65M	2437	12.97	0.020	12.89	0.019	< 30
72.2M	2437	12.95	0.020	12.87	0.019	< 30	
Mode 5	13.5M	2422	12.30	0.017	12.24	0.017	< 30
		2437	12.43	0.017	12.40	0.017	< 30
		2452	8.69	0.007	8.63	0.007	< 30
	30M	2437	12.40	0.017	12.36	0.017	< 30
	45M	2437	12.37	0.017	12.30	0.017	< 30
	60M	2437	12.35	0.017	12.28	0.017	< 30
	90M	2437	12.31	0.017	12.26	0.017	< 30
	120M	2437	12.27	0.017	12.18	0.017	< 30
	135M	2437	12.23	0.017	12.15	0.016	< 30
150M	2437	12.20	0.017	12.11	0.016	< 30	

Note: The relevant measured result has the offset with cable loss already.

6 6dB RF Bandwidth Measurement

6.1. Limit

6dB RF Bandwidth: Systems using digital modulation techniques may operate in the 2400–2483.5 MHz bands. The minimum 6 dB band-width shall be at least 500 kHz.

6.2. Test Setup

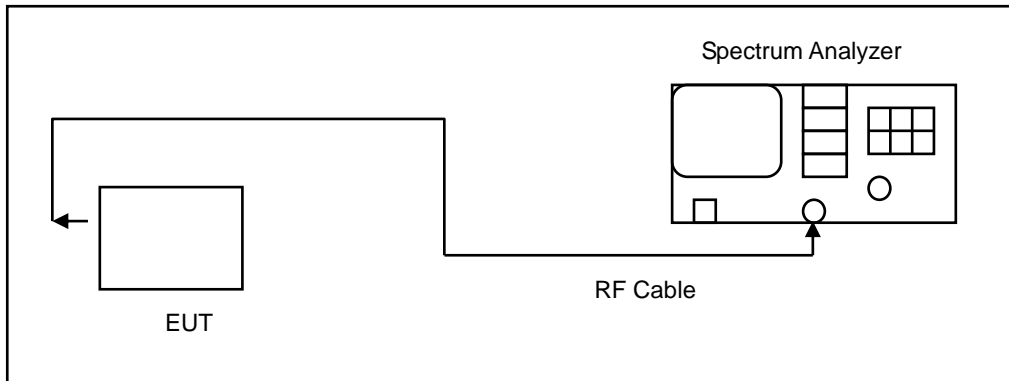

6.3. Test Instruments

Equipment	Manufacturer	Model Number	Serial Number	Cal. Date	Cal. Period
Spectrum Analyzer	Agilent	E4445A	MY45300744	12/19/2016	1 year
Microwave Cable	EMCI	EMC104-SM-SM-1500	140303	02/22/2017	1 year
Test Site	ATL	TE05	TE05	N.C.R.	-----

Note: N.C.R. = No Calibration Request.

6.4. Test Procedure

The EUT tested to DTS test procedure of KDB558074D01 for compliance to FCC 47CFR 15.247 requirements.

6dB RF Bandwidth: The antenna port of the EUT was connected to the input of a spectrum analyzer. Analyzer RBW was set to 100 kHz. For each RF output channel investigated, the spectrum analyzer center frequency was set to the channel carrier. A peak output reading was taken, a DISPLAY line was drawn 6 dB lower than peak level. The 6 dB bandwidth was determined from where the channel output spectrum intersected the display line.

The test was performed at 3 channels (Channel low, middle, high)

**6.5. Test Result**

Test Item	6dB RF Bandwidth		
Test Mode	Frequency (MHz)	Measurement (kHz)	Limit (kHz)
Mode 2	2412	10130	> 500
	2437	10130	> 500
	2462	10130	> 500
Mode 3	2412	16370	> 500
	2437	16390	> 500
	2462	16390	> 500
Mode 4	2412	17610	> 500
	2437	17610	> 500
	2462	17610	> 500
Mode 5	2422	36340	> 500
	2437	36100	> 500
	2452	36350	> 500



6.6. Test Graphs

Mode 2: IEEE 802.11b Continuous TX mode													
2412 MHz	<p>Agilent Spectrum Analyzer - Occupied BW</p> <p>Center Freq: 2.41200000 GHz Trig: Free Run #Atten: 20 dB</p> <p>Radio Std: None Radio Device: BTS</p> <p>10 dB/div Ref 20.80 dBm</p> <p>Center: 2.412 GHz #Res BW 100 kHz</p> <p>#VBW 300 kHz Span 30 MHz Sweep 2.933 ms</p> <table border="1"> <tr> <td>Occupied Bandwidth</td> <td>Total Power</td> <td>22.6 dBm</td> </tr> <tr> <td colspan="3" style="text-align: center;">13.652 MHz</td> </tr> <tr> <td>Transmit Freq Error</td> <td>OBW Power</td> <td>99.00 %</td> </tr> <tr> <td>x dB Bandwidth</td> <td>x dB</td> <td>-6.00 dB</td> </tr> </table> <p>MSG: STATUS:</p>	Occupied Bandwidth	Total Power	22.6 dBm	13.652 MHz			Transmit Freq Error	OBW Power	99.00 %	x dB Bandwidth	x dB	-6.00 dB
Occupied Bandwidth	Total Power	22.6 dBm											
13.652 MHz													
Transmit Freq Error	OBW Power	99.00 %											
x dB Bandwidth	x dB	-6.00 dB											
2437 MHz	<p>Agilent Spectrum Analyzer - Occupied BW</p> <p>Center Freq: 2.43700000 GHz Trig: Free Run #Atten: 20 dB</p> <p>Radio Std: None Radio Device: BTS</p> <p>10 dB/div Ref 20.80 dBm</p> <p>Center: 2.437 GHz #Res BW 100 kHz</p> <p>#VBW 300 kHz Span 30 MHz Sweep 2.933 ms</p> <table border="1"> <tr> <td>Occupied Bandwidth</td> <td>Total Power</td> <td>23.4 dBm</td> </tr> <tr> <td colspan="3" style="text-align: center;">13.663 MHz</td> </tr> <tr> <td>Transmit Freq Error</td> <td>OBW Power</td> <td>99.00 %</td> </tr> <tr> <td>x dB Bandwidth</td> <td>x dB</td> <td>-6.00 dB</td> </tr> </table> <p>MSG: STATUS:</p>	Occupied Bandwidth	Total Power	23.4 dBm	13.663 MHz			Transmit Freq Error	OBW Power	99.00 %	x dB Bandwidth	x dB	-6.00 dB
Occupied Bandwidth	Total Power	23.4 dBm											
13.663 MHz													
Transmit Freq Error	OBW Power	99.00 %											
x dB Bandwidth	x dB	-6.00 dB											
2462 MHz	<p>Agilent Spectrum Analyzer - Occupied BW</p> <p>Center Freq: 2.46200000 GHz Trig: Free Run #Atten: 20 dB</p> <p>Radio Std: None Radio Device: BTS</p> <p>10 dB/div Ref 20.80 dBm</p> <p>Center: 2.462 GHz #Res BW 100 kHz</p> <p>#VBW 300 kHz Span 30 MHz Sweep 2.933 ms</p> <table border="1"> <tr> <td>Occupied Bandwidth</td> <td>Total Power</td> <td>22.3 dBm</td> </tr> <tr> <td colspan="3" style="text-align: center;">13.613 MHz</td> </tr> <tr> <td>Transmit Freq Error</td> <td>OBW Power</td> <td>99.00 %</td> </tr> <tr> <td>x dB Bandwidth</td> <td>x dB</td> <td>-6.00 dB</td> </tr> </table> <p>MSG: STATUS:</p>	Occupied Bandwidth	Total Power	22.3 dBm	13.613 MHz			Transmit Freq Error	OBW Power	99.00 %	x dB Bandwidth	x dB	-6.00 dB
Occupied Bandwidth	Total Power	22.3 dBm											
13.613 MHz													
Transmit Freq Error	OBW Power	99.00 %											
x dB Bandwidth	x dB	-6.00 dB											



Mode 3: IEEE 802.11g Continuous TX mode

2412 MHz

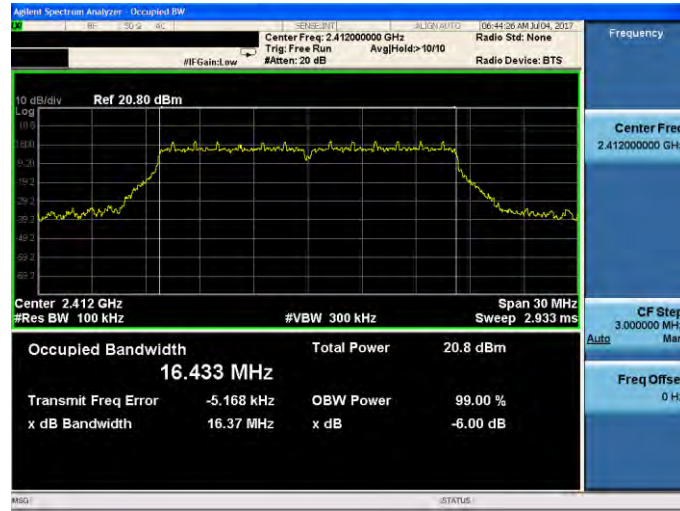

2437 MHz

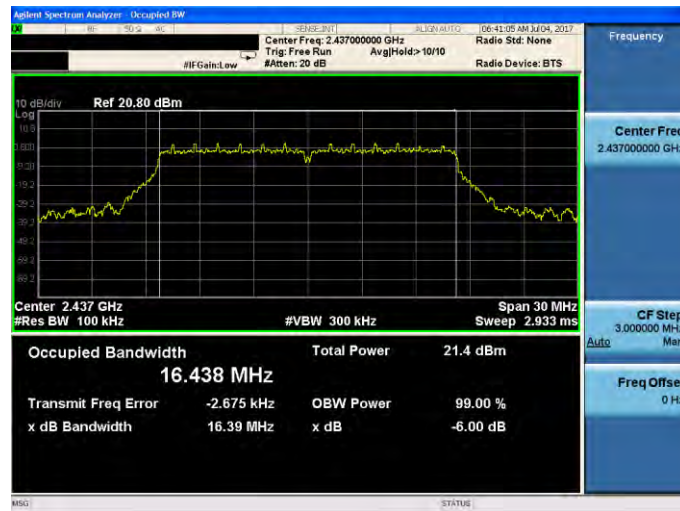

2462 MHz

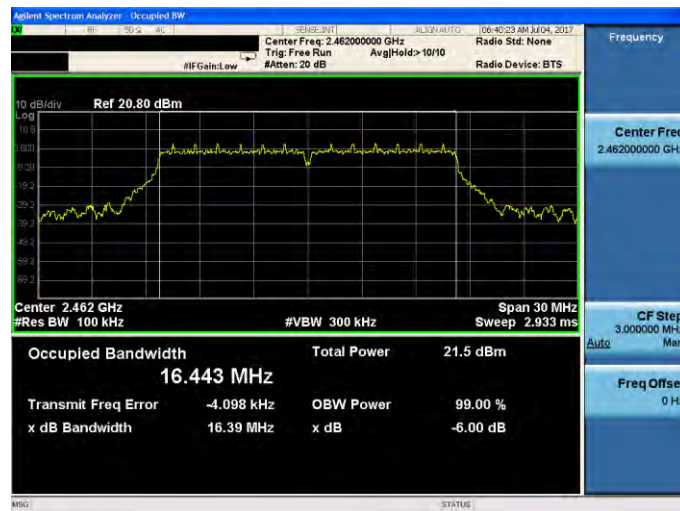



Mode 4: IEEE 802.11n 2.4GHz 20MHz Continuous TX mode

2412 MHz

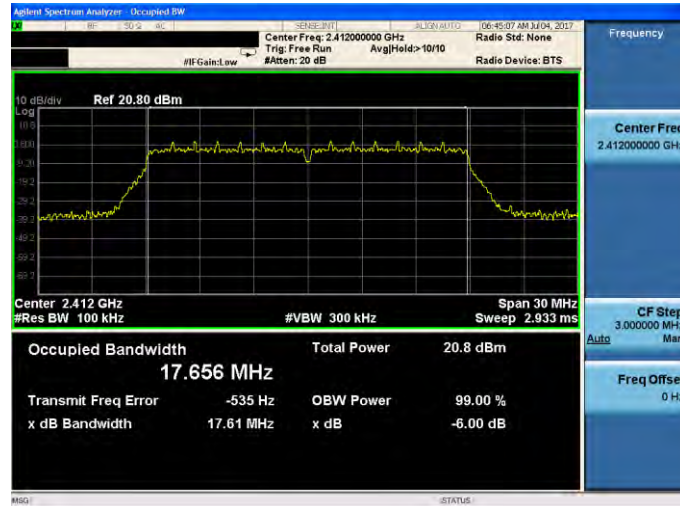

2437 MHz



2462 MHz





Mode 5: IEEE 802.11n 2.4GHz 40MHz Continuous TX mode

2422 MHz

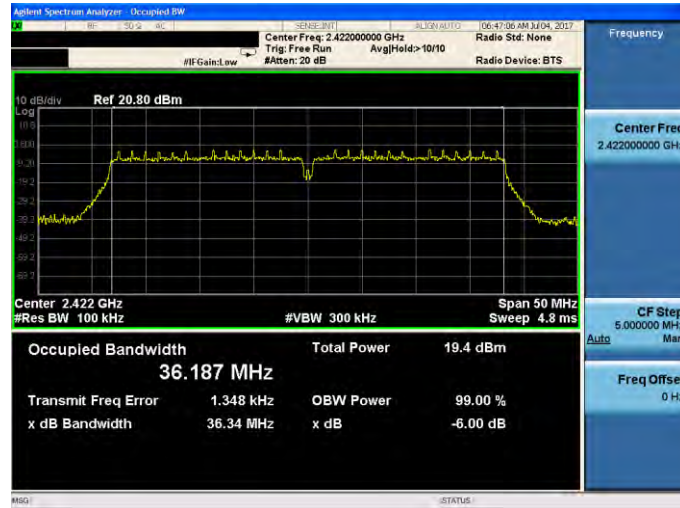

2437 MHz



2452 MHz

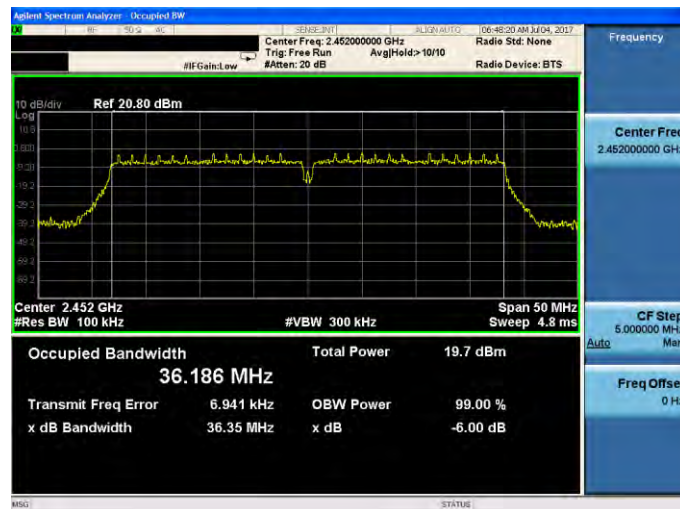

7 Maximum Power Density Measurement

7.1. Limit

For digitally modulated systems, the power spectral density conducted from the intentional radiator to the antenna shall not be greater than 8 dBm in any 3 kHz band during any time interval of continuous transmission.

Diversity mode = Max. Gain = 5.17 dBi < 6 dBi.

7.2. Test Setup

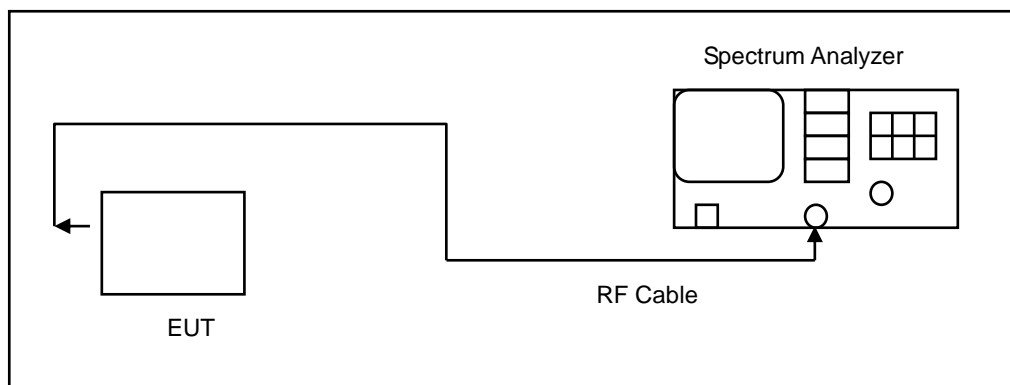

7.3. Test Instruments

Equipment	Manufacturer	Model Number	Serial Number	Cal. Date	Cal. Period
Spectrum Analyzer	Agilent	E4445A	MY45300744	12/19/2016	1 year
Microwave Cable	EMCI	EMC104-SM-SM-1500	140303	02/22/2017	1 year
Test Site	ATL	TE05	TE05	N.C.R.	-----

Note: N.C.R. = No Calibration Request.

7.4. Test Procedure

The EUT tested to DTS test procedure of KDB558074D01 for compliance to FCC 47CFR 15.247 requirements.

1. Set analyzer center frequency to DTS channel center frequency.
2. Set the span to 1.5 times the DTS bandwidth.
3. Set the RBW to: $3 \text{ kHz} \leq \text{RBW} \leq 100 \text{ kHz}$.
4. Set the VBW $\geq 3 \times \text{RBW}$.
5. Detector = peak.
6. Sweep time = auto couple.
7. Trace mode = max hold.
8. Allow trace to fully stabilize.
9. Use the peak marker function to determine the maximum amplitude level within the RBW.
10. If measured value exceeds limit, reduce RBW (no less than 3 kHz) and repeat.





7.5. Test Result

Test Item	Maximum Power Density		
Test Mode	Frequency (MHz)	Measurement (dBm/3KHz)	Limit (dBm/3KHz)
Mode 2	2412	-11.047	< 8
	2437	-10.420	< 8
	2462	-10.993	< 8
Mode 3	2412	-12.431	< 8
	2437	-11.240	< 8
	2462	-11.612	< 8
Mode 4	2412	-12.619	< 8
	2437	-12.972	< 8
	2462	-11.841	< 8
Mode 5	2422	-16.143	< 8
	2437	-17.093	< 8
	2452	-16.375	< 8

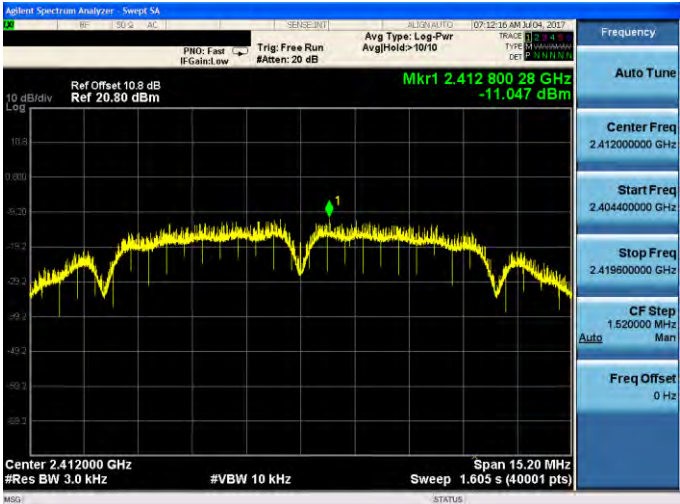
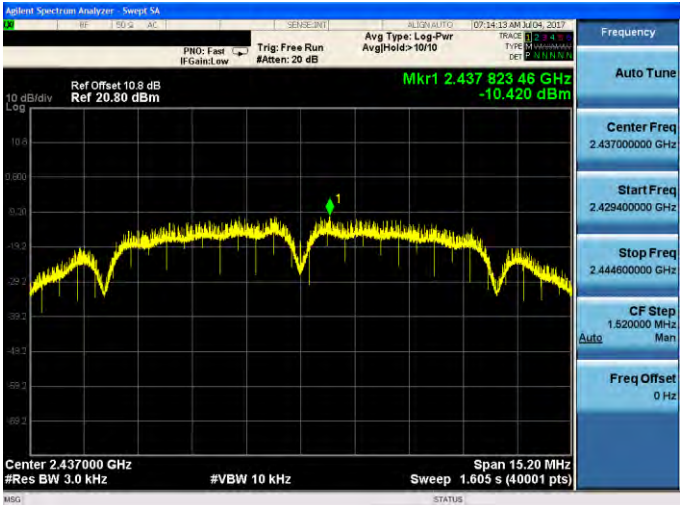

7.6. Test Graphs

Mode 2: IEEE 802.11b Continuous TX mode

2412 MHz	
2437 MHz	
2462 MHz	



Mode 3: IEEE 802.11g Continuous TX mode

2412 MHz

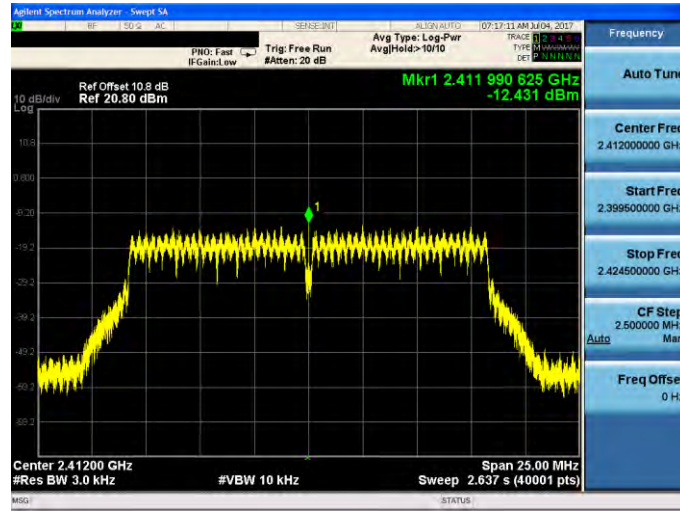

2437 MHz

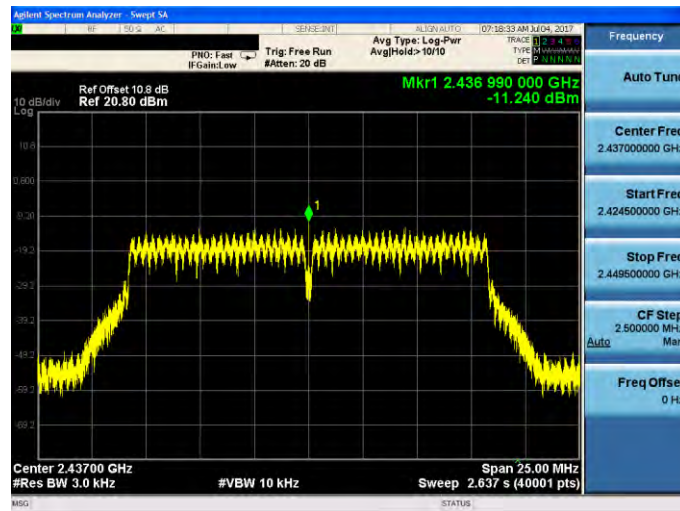

2462 MHz

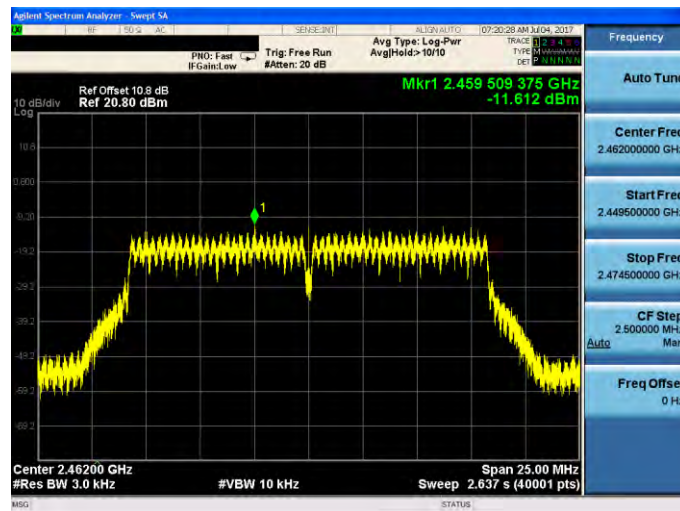



Mode 4: IEEE 802.11n 2.4GHz 20MHz Continuous TX mode

2412 MHz

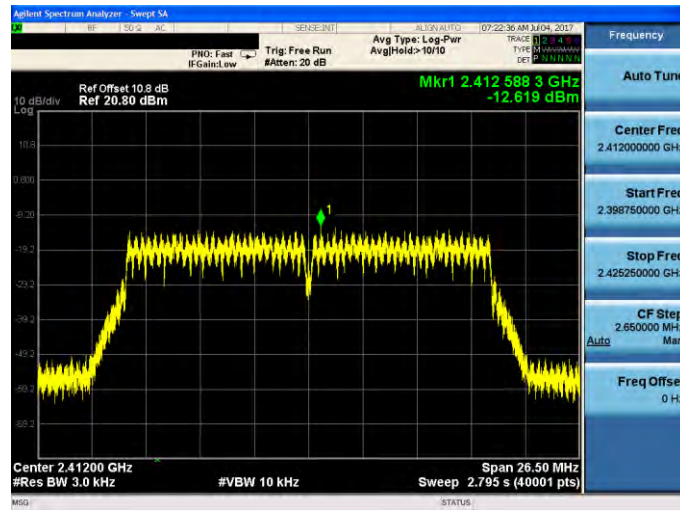

2437 MHz

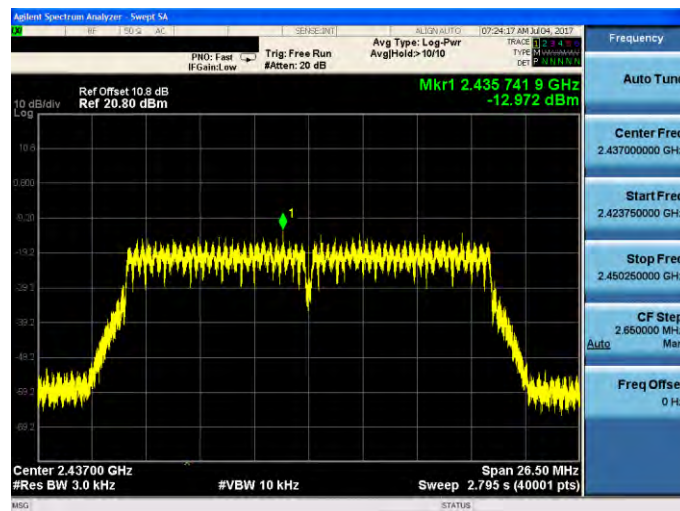

2462 MHz

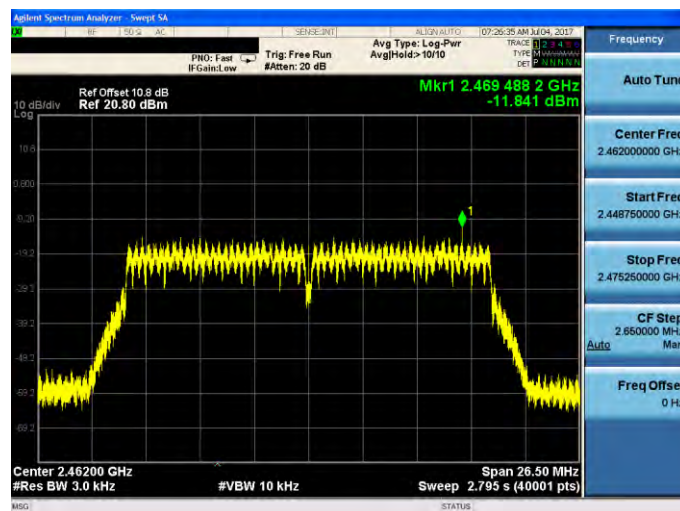



Mode 5: IEEE 802.11n 2.4GHz 40MHz Continuous TX mode

2422 MHz

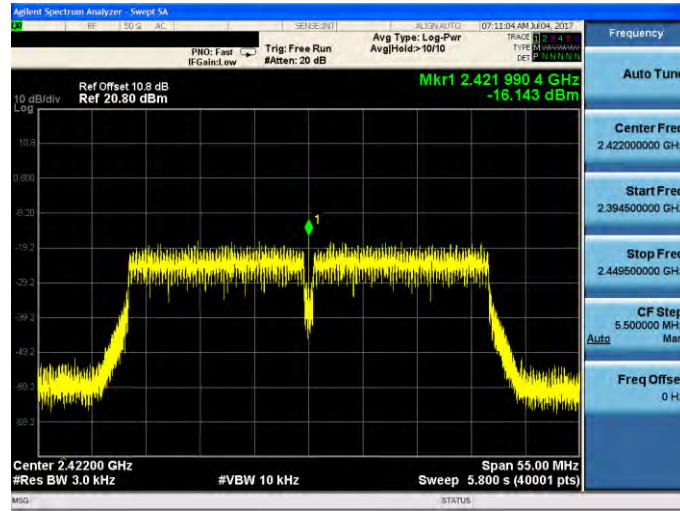

2437 MHz

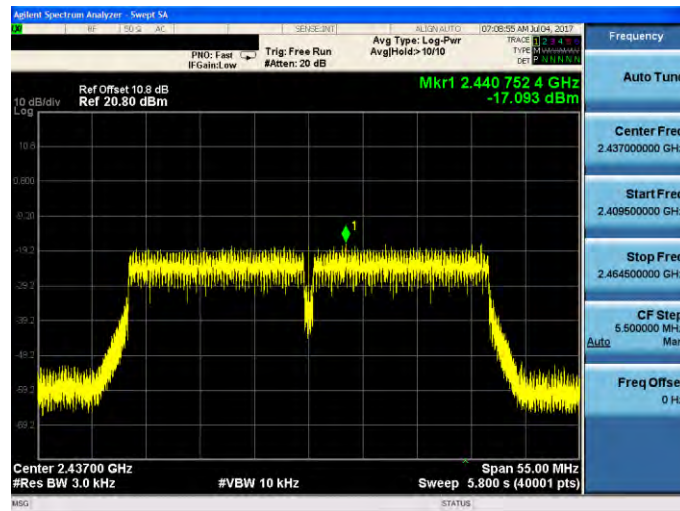

2452 MHz

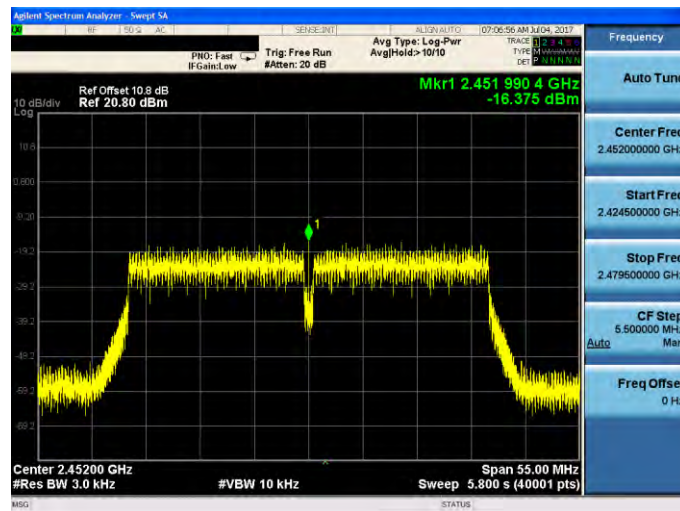

8 Out of Band Conducted Emissions Measurement

8.1. Limit

In any 100 kHz bandwidth outside the frequency band in which the spread spectrum or digitally modulated intentional radiator is operating, the radio frequency power that is produced by the intentional radiator shall be at least 30 dB below that in the 100 kHz bandwidth within the band that contains the highest level of the desired power

8.2. Test Setup

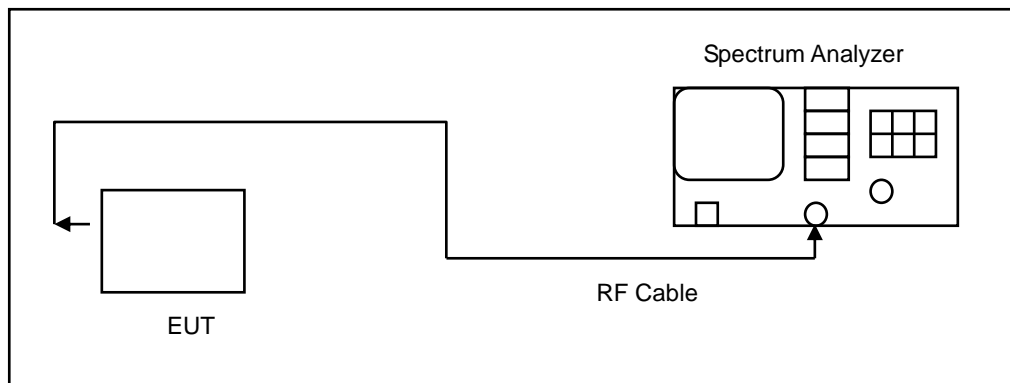

8.3. Test Instruments

Equipment	Manufacturer	Model Number	Serial Number	Cal. Date	Cal. Period
Spectrum Analyzer	Agilent	E4445A	MY45300744	12/19/2016	1 year
Spectrum Analyzer	Agilent	E4408B	MY45107753	08/08/2016	1 year
Microwave Cable	EMCI	EMC104-SM-SM-1500	140303	02/22/2017	1 year
Test Site	ATL	TE05	TE05	N.C.R.	-----

Note: N.C.R. = No Calibration Request.

8.4. Test Procedure

In any 100 kHz bandwidth outside the EUT pass band, the RF power produced by the modulation products of the spreading sequence, the information sequence, and the carrier frequency shall be at least 30 dB below that of the maximum in-band 100 kHz emission, antenna output of the EUT was coupled directly to spectrum analyzer; if an external attenuator and/or cable was used, these losses are compensated for with the analyzer OFFSET function.

All other types of emissions from the EUT shall meet the general limits for radiated frequencies outside the pass band.

The test was performed at 3 channels.



8.5. Test Graphs

Reference level

Mode 2: IEEE 802.11b Continuous TX mode

<p>2412 MHz</p>	
<p>2437 MHz</p>	
<p>2462 MHz</p>	



Mode 3: IEEE 802.11g Continuous TX mode

2412 MHz



2437 MHz



2462 MHz





Mode 4: IEEE 802.11n 2.4GHz 20MHz Continuous TX mode

2412 MHz

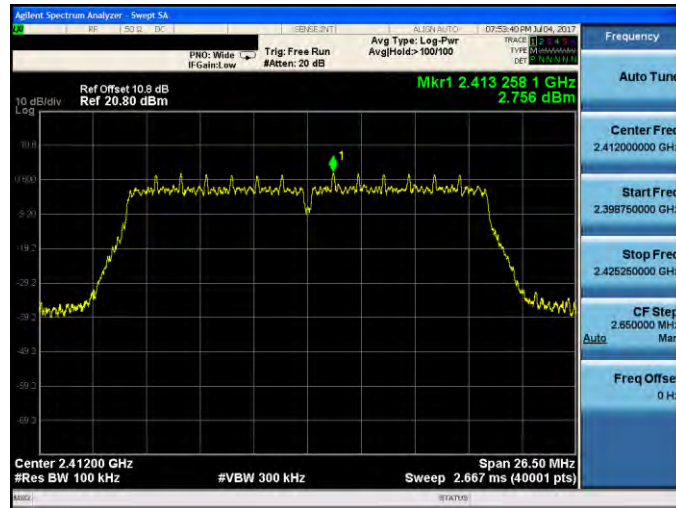

2437 MHz

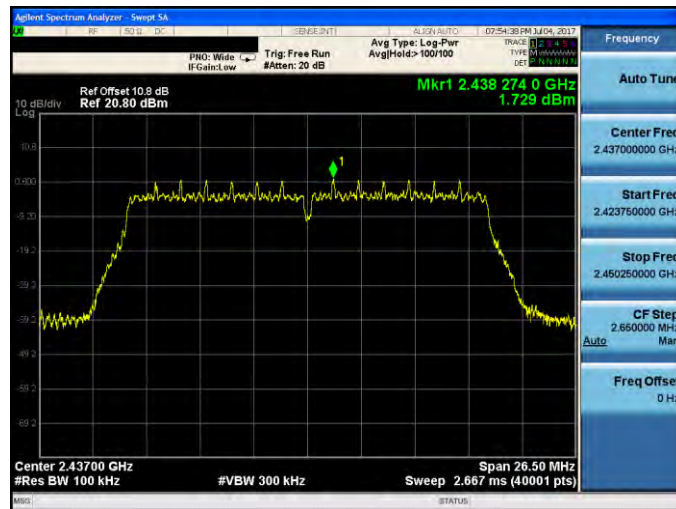

2462 MHz

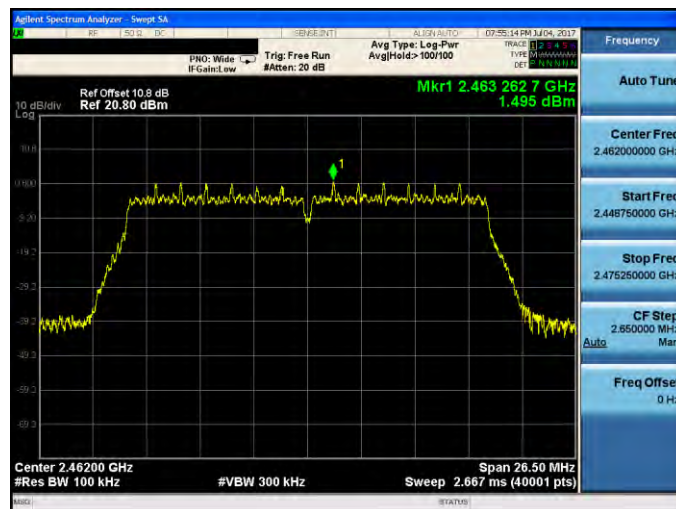

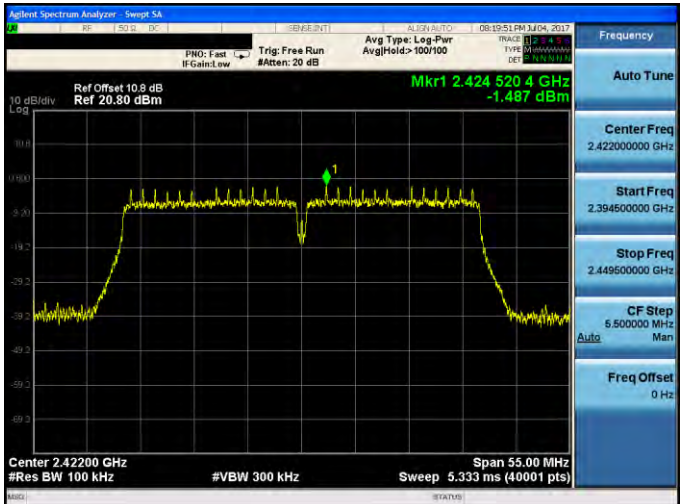
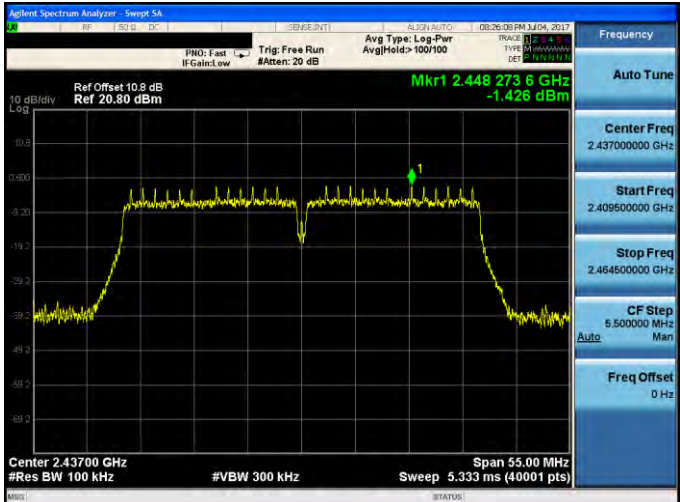
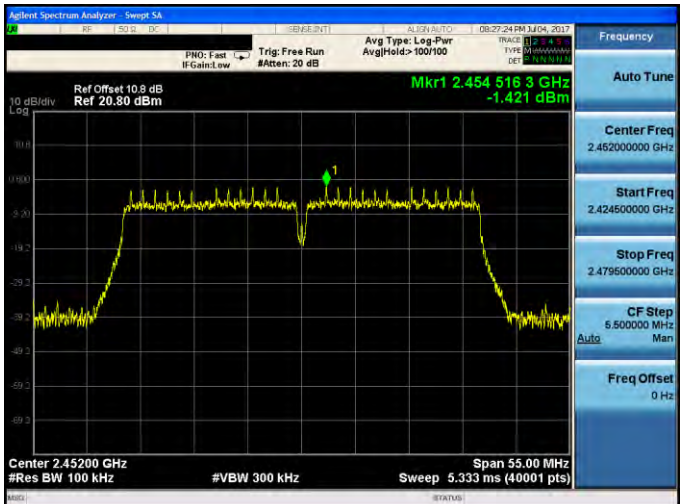

Mode 5: IEEE 802.11n 2.4GHz 40MHz Continuous TX mode

2422 MHz	
2437 MHz	
2452 MHz	



Out of Band Conducted Emissions

Mode 2: IEEE 802.11b Continuous TX mode

<p>2412 MHz</p>	<p>Agilent Spectrum Analyzer - Sweep SA</p> <p>Ref Offset 10.8 dB Ref 20.80 dBm</p> <p>Mkr1 2.412 0 GHz 4.202 dBm</p> <p>Start 30 MHz #Res BW 100 kHz #VBW 300 kHz Stop 26.50 GHz Sweep 2.531 s (40001 pts)</p> <table border="1"> <thead> <tr> <th>MFR MODE</th> <th>TRC</th> <th>SOL</th> <th>X</th> <th>Y</th> <th>FUNCTION</th> <th>FUNCTION WIDTH</th> <th>FUNCTION VALUE</th> </tr> </thead> <tbody> <tr> <td>1</td> <td>N</td> <td>1</td> <td>f</td> <td>2.412 0 GHz</td> <td></td> <td></td> <td>4.202 dBm</td> </tr> </tbody> </table>	MFR MODE	TRC	SOL	X	Y	FUNCTION	FUNCTION WIDTH	FUNCTION VALUE	1	N	1	f	2.412 0 GHz			4.202 dBm
MFR MODE	TRC	SOL	X	Y	FUNCTION	FUNCTION WIDTH	FUNCTION VALUE										
1	N	1	f	2.412 0 GHz			4.202 dBm										
<p>2437 MHz</p>	<p>Agilent Spectrum Analyzer - Sweep SA</p> <p>Ref Offset 10.8 dB Ref 20.80 dBm</p> <p>Mkr1 2.437 0 GHz 5.105 dBm</p> <p>Start 30 MHz #Res BW 100 kHz #VBW 300 kHz Stop 26.50 GHz Sweep 2.531 s (40001 pts)</p> <table border="1"> <thead> <tr> <th>MFR MODE</th> <th>TRC</th> <th>SOL</th> <th>X</th> <th>Y</th> <th>FUNCTION</th> <th>FUNCTION WIDTH</th> <th>FUNCTION VALUE</th> </tr> </thead> <tbody> <tr> <td>1</td> <td>N</td> <td>1</td> <td>f</td> <td>2.437 0 GHz</td> <td></td> <td></td> <td>5.105 dBm</td> </tr> </tbody> </table>	MFR MODE	TRC	SOL	X	Y	FUNCTION	FUNCTION WIDTH	FUNCTION VALUE	1	N	1	f	2.437 0 GHz			5.105 dBm
MFR MODE	TRC	SOL	X	Y	FUNCTION	FUNCTION WIDTH	FUNCTION VALUE										
1	N	1	f	2.437 0 GHz			5.105 dBm										
<p>2462 MHz</p>	<p>Agilent Spectrum Analyzer - Sweep SA</p> <p>Ref Offset 10.8 dB Ref 20.80 dBm</p> <p>Mkr1 2.462 0 GHz 1.192 dBm</p> <p>Start 30 MHz #Res BW 100 kHz #VBW 300 kHz Stop 26.50 GHz Sweep 2.531 s (40001 pts)</p> <table border="1"> <thead> <tr> <th>MFR MODE</th> <th>TRC</th> <th>SOL</th> <th>X</th> <th>Y</th> <th>FUNCTION</th> <th>FUNCTION WIDTH</th> <th>FUNCTION VALUE</th> </tr> </thead> <tbody> <tr> <td>1</td> <td>N</td> <td>1</td> <td>f</td> <td>2.462 0 GHz</td> <td></td> <td></td> <td>1.192 dBm</td> </tr> </tbody> </table>	MFR MODE	TRC	SOL	X	Y	FUNCTION	FUNCTION WIDTH	FUNCTION VALUE	1	N	1	f	2.462 0 GHz			1.192 dBm
MFR MODE	TRC	SOL	X	Y	FUNCTION	FUNCTION WIDTH	FUNCTION VALUE										
1	N	1	f	2.462 0 GHz			1.192 dBm										



Mode 3: IEEE 802.11g Continuous TX mode

2412 MHz

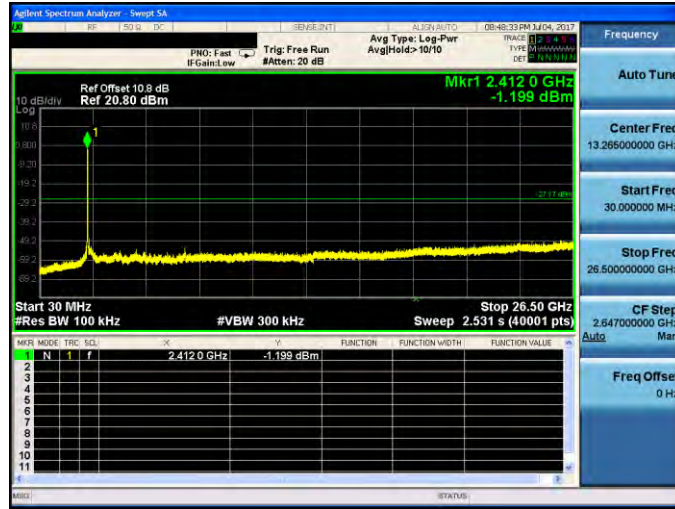

2437 MHz

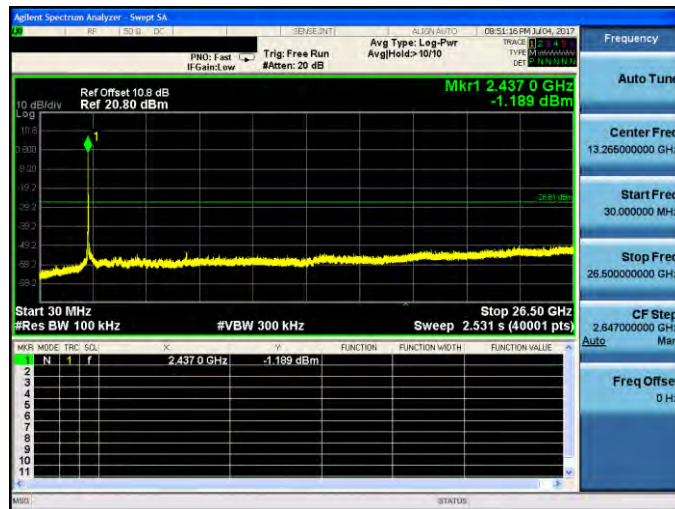

2462 MHz

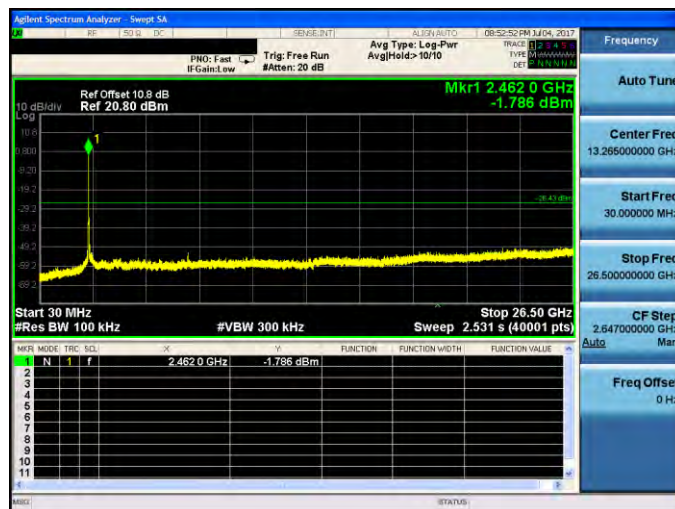



Mode 4: IEEE 802.11n 2.4GHz 20MHz Continuous TX mode

2412 MHz

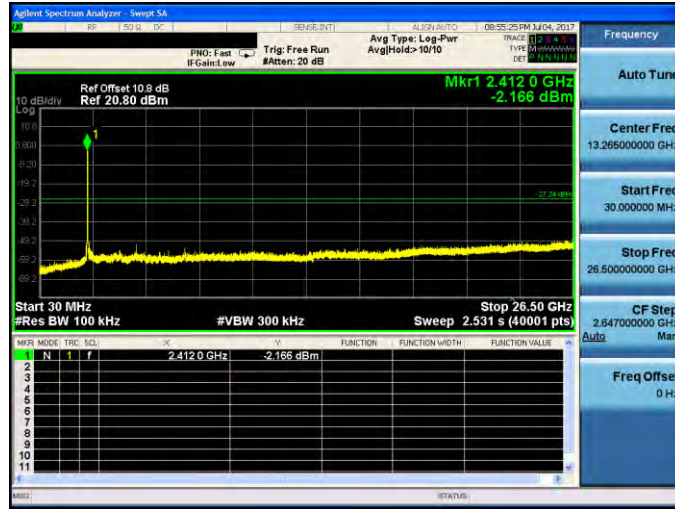

2437 MHz

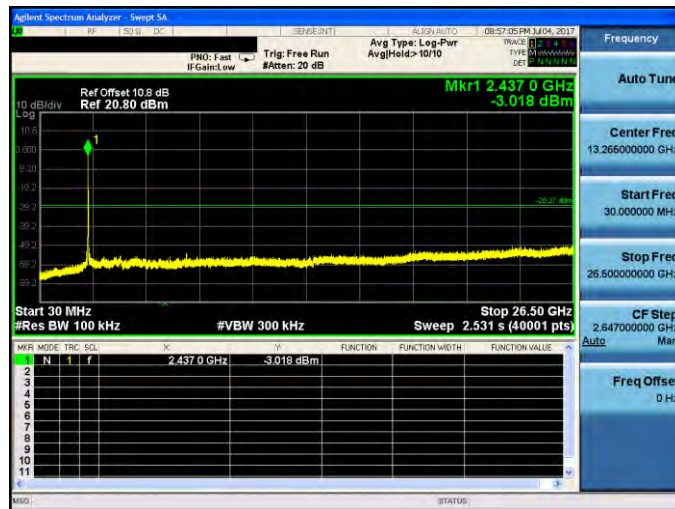

2462 MHz

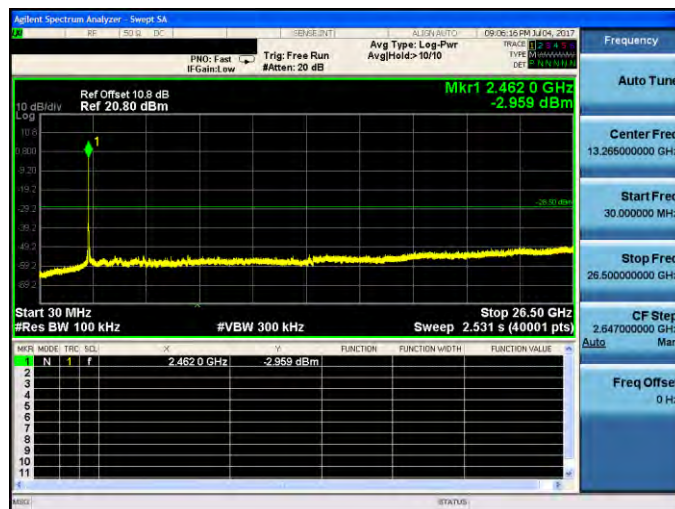



Mode 5: IEEE 802.11n 2.4GHz 40MHz Continuous TX mode

2422 MHz

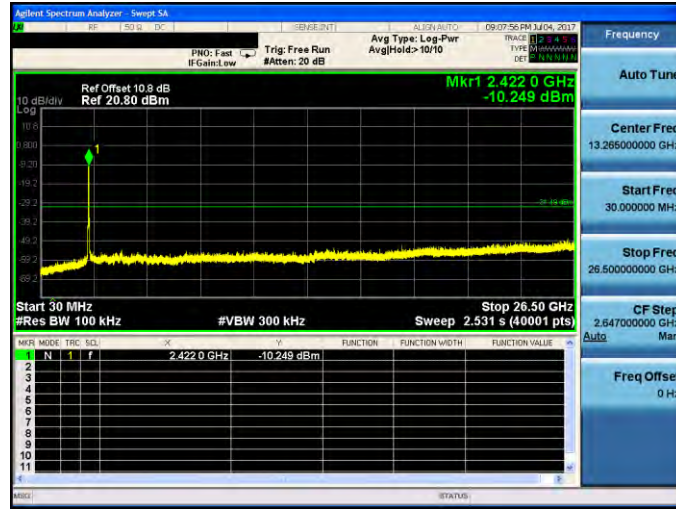

2437 MHz

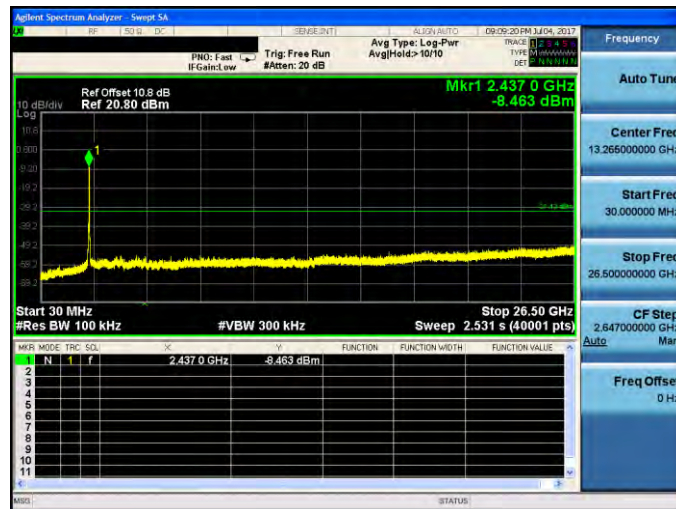

2452 MHz

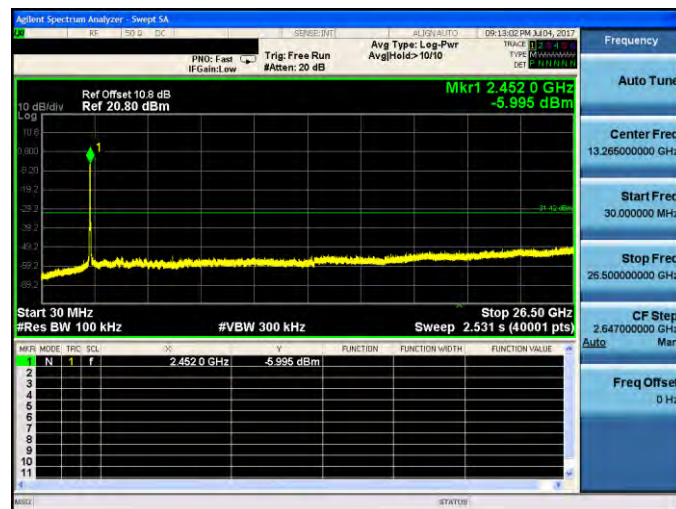



Conducted Band Edge

Mode 2: IEEE 802.11b Continuous TX mode

2412 MHz

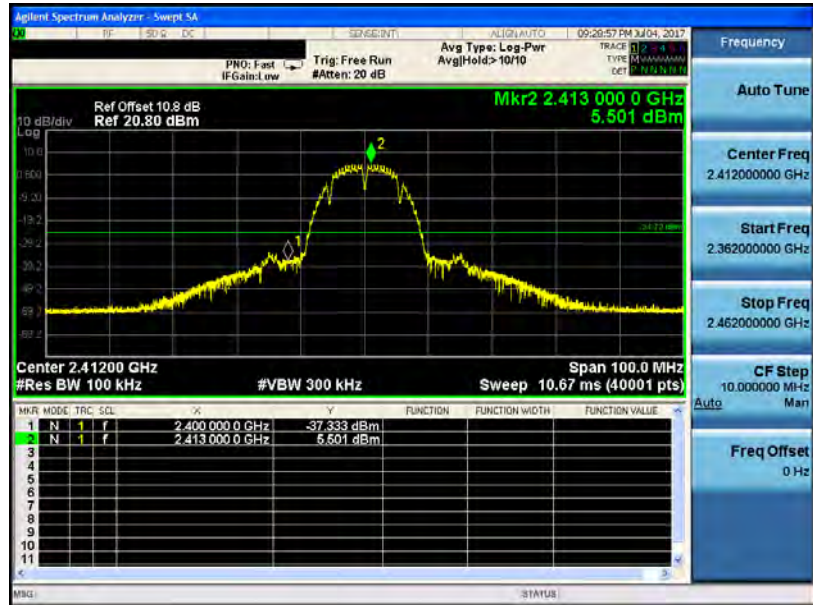

2462 MHz

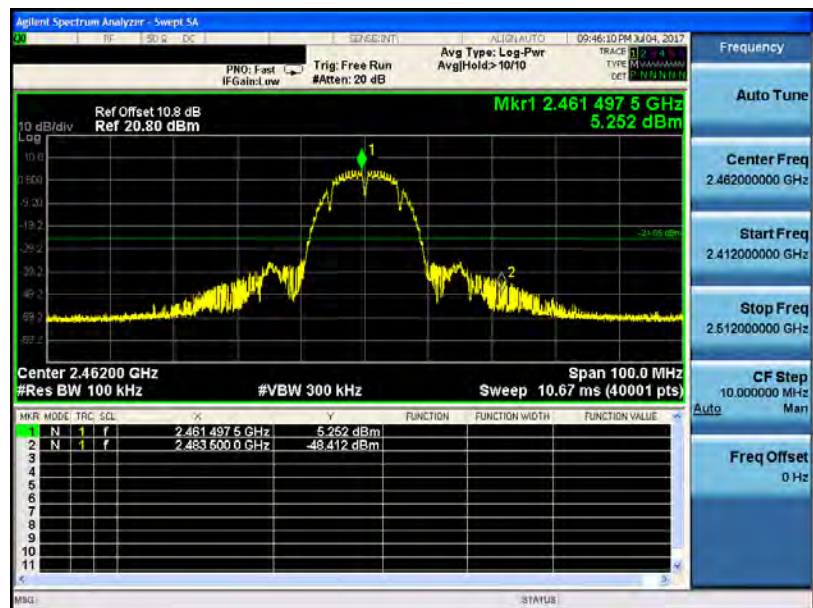



Mode 3: IEEE 802.11g Continuous TX mode

2412 MHz

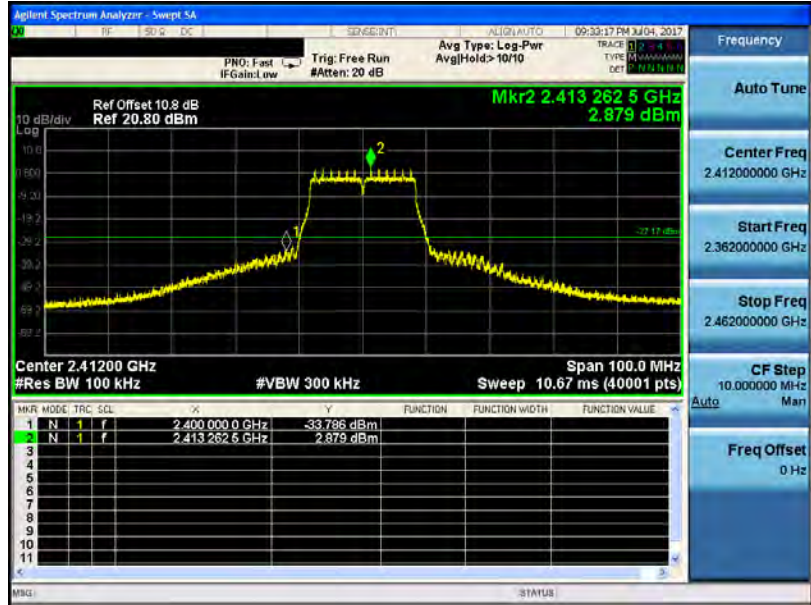

2462 MHz

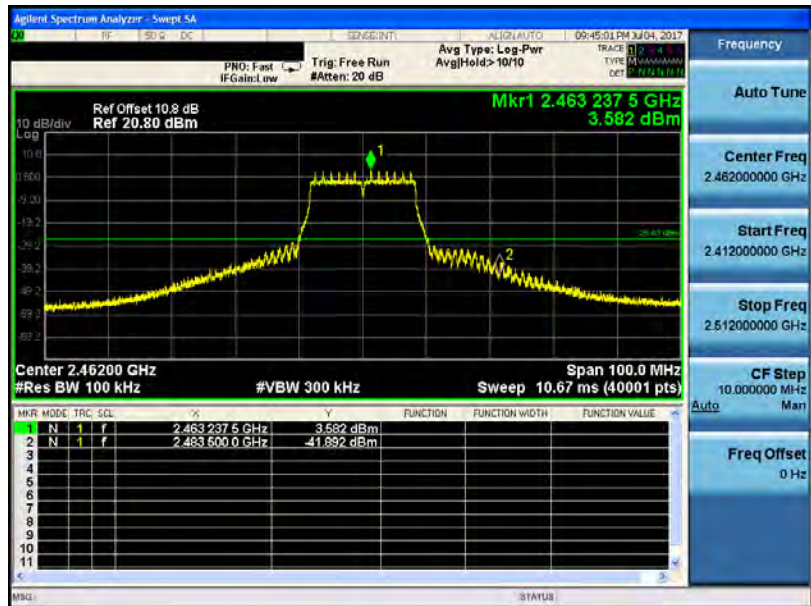



Mode 4: IEEE 802.11n 2.4GHz 20MHz Continuous TX mode

2412 MHz

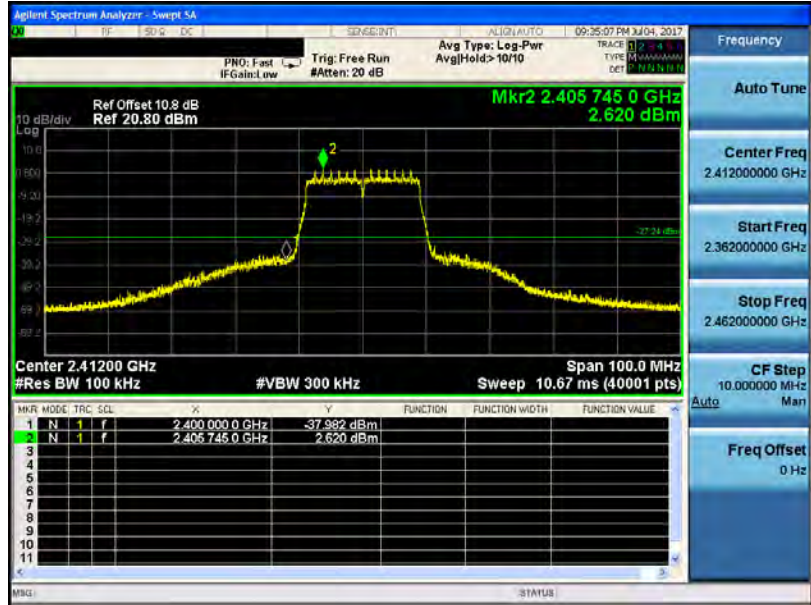

2462 MHz

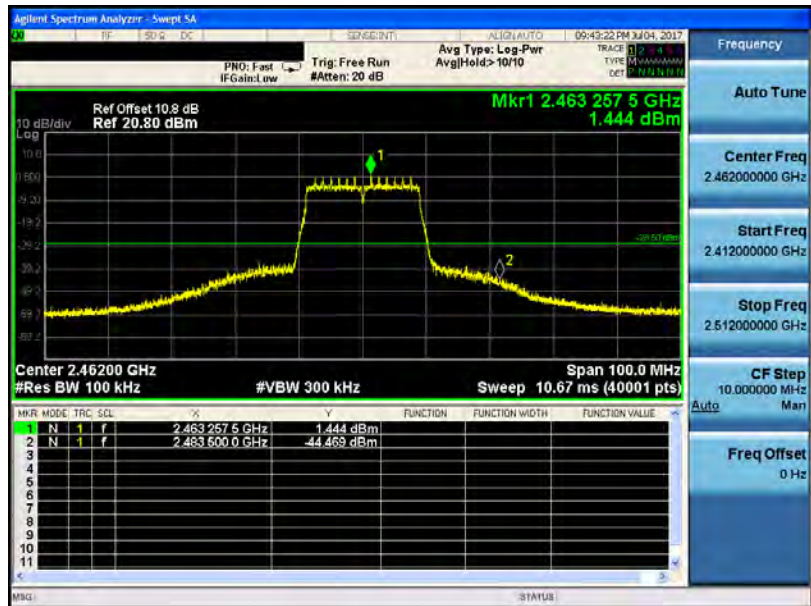



Mode 5: IEEE 802.11n 2.4GHz 40MHz Continuous TX mode

2422 MHz

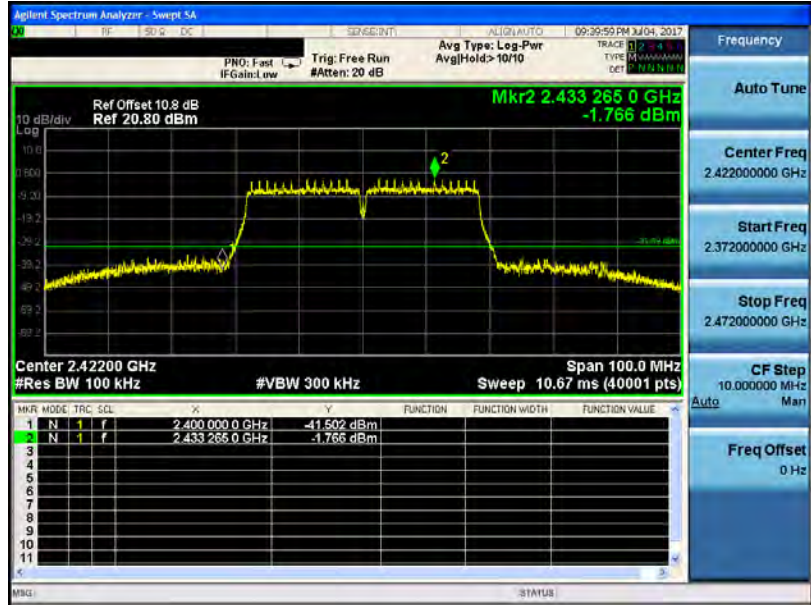

2452 MHz

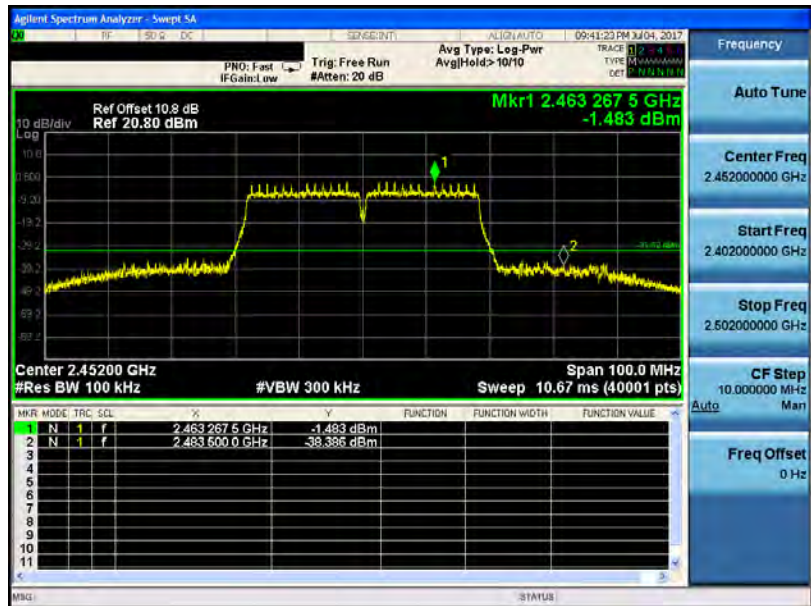



9 Antenna Measurement

9.1. Limit

For intentional device, according to 15.203, an intentional radiator shall be designed to ensure that no antenna other than that furnished by the responsible party shall be used with the device.

And According to 15.247 (b), if transmitting antennas of directional gain greater than 6 dBi are used, the power shall be reduced by the amount in dB that the directional gain of the antenna exceeds 6dBi.

9.2. Antenna Description

See section 2 – antenna information.