



BLUETOOTH SPEAKER

PAGES
5+



LIGHT
SHOW



RECHARGEABLE
BATTERY



IMPORTANT SAFETY PRECAUTIONS

WHEN USING YOUR LIGHT UP BLUETOOTH SPEAKER, BASIC SAFETY PRECAUTIONS SHOULD ALWAYS BE FOLLOWED, INCLUDING THE FOLLOWING:

1. READ ALL INSTRUCTIONS BEFORE USING YOUR SPEAKER.
2. DO NOT USE YOUR SPEAKER NEAR WATER. CLEAN USING A SOFT CLOTH OR PAPER TOWEL.
3. DO NOT PLACE YOUR SPEAKER ON ANY WET SURFACES.
4. DO NOT ALLOW CHILDREN OR THE INFIRM TO PLAY WITH YOUR SPEAKER WITHOUT ADULT SUPERVISION.
5. DO NOT EXPOSE YOUR SPEAKER TO EXCESSIVE HEAT, FLAMES OR FIRE.
6. ALWAYS PRESS ALL BUTTONS OR SWITCHES CAREFULLY. DO NOT MANHANDLE YOUR SPEAKER.
7. DO NOT USE IN EXTREMELY DRY ENVIRONMENTS, AS THIS CAN LEAD TO STATIC DISCHARGE DURING USAGE.
8. DO NOT EXPOSE YOUR SPEAKER TO TEMPERATURES ABOVE 40°C. KEEP OUT OF DIRECT SUNLIGHT.
9. DO NOT ATTEMPT TO REPAIR THIS PRODUCT YOURSELF. CONTACT A QUALIFIED SERVICE CENTER IF YOUR SPEAKER IS IN NEED OF SERVICE.
10. DO NOT DROP, PUNCTURE OR EXPOSE YOUR SPEAKER TO EXCESSIVE TRAUMA.
11. YOUR SPEAKER IS NOT INTENDED FOR COMMERCIAL USE.
12. DO NOT PLACE NEAR OBJECTS THAT GENERATE A STRONG MAGNETIC FIELD.
13. UNPLUG YOUR SPEAKER WHEN NOT IN USE FOR LONG PERIODS OF TIME OR DURING LIGHTNING STORMS.



BATTERY WARNING:

- THE DEVICE IS EQUIPPED WITH AN INTEGRATED LITHIUM ION BATTERY. THE BATTERY CANNOT BE REPLACED. DO NOT ATTEMPT TO REMOVE THE BATTERY FROM THE DEVICE.
- DO NOT DISPOSE OF IN FIRE OR EXPOSE TO EXCESSIVE HEAT.
- DO NOT CRUSH, PUNCTURE, INCINERATE, OR SHORT CIRCUIT EXTERNAL CONTACTS.
- PLEASE RECYCLE OR DISPOSE OF THE BATTERY PROPERLY. CONTACT YOUR LOCAL RECYCLING FACILITIES AND/OR THE MANUFACTURER FOR FURTHER INFORMATION.

INTRODUCTION

THANK YOU FOR PURCHASING THE LOL SURPRISE! LIGHT UP BLUETOOTH SPEAKER, ITEM SP2-14136. YOU CAN USE YOUR SPEAKER WITH MOST SMARTPHONES AND BLUETOOTH DEVICES TO STREAM MUSIC WIRELESSLY. YOUR SPEAKER ALSO EMITS AN EXCITING ARRAY OF FUN DANCING LIGHTS. IN ORDER TO GET THE BEST RESULTS, PLEASE READ THIS MANUAL FIRST BEFORE USING YOUR SPEAKER.

PACKAGE CONTENTS

- LOL SURPRISE! SP2-14136 LIGHT UP BLUETOOTH SPEAKER**
- USB CHARGING CABLE**
- USER'S MANUAL WITH WARRANTY INFORMATION**

SPECIFICATIONS

BLUETOOTH SPECIFICATION: V2.1

BLUETOOTH RANGE: UP TO 33 FEET (10 METERS)

POWER SUPPLY: DC 5V (USB)

BATTERY TYPE: LITHIUM ION BATTERY

CHARGING TIME: APPROXIMATELY 5 HOURS

A QUICK LOOK AT YOUR DEVICE

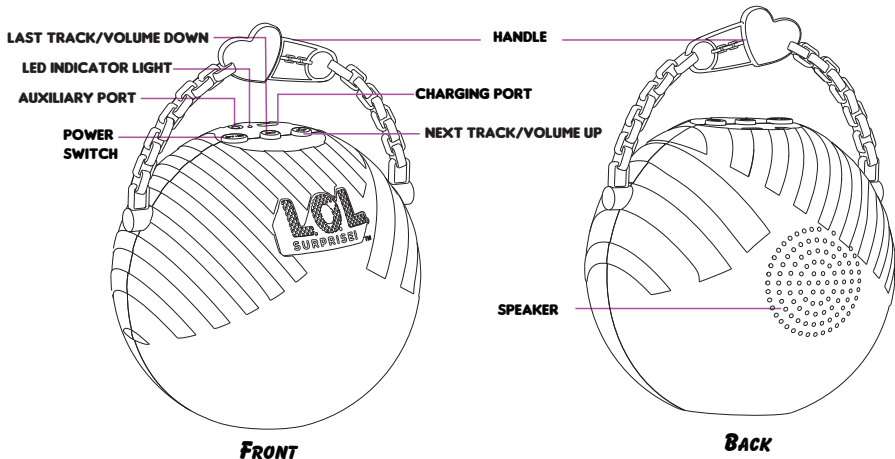

CHARGING YOUR SPEAKER

MICRO USB
PLUG

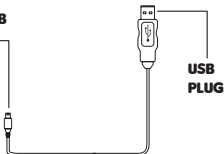

USB
PLUG

1. THE USB CHARGING CABLE HAS A MICRO USB PLUG AND A STANDARD USB PLUG.

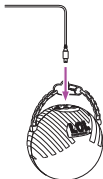

2. INSERT THE USB CHARGING CABLE'S MICRO USB PLUG INTO THE CHARGING PORT ON YOUR SPEAKER.

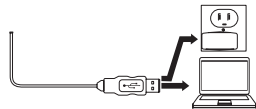

3. INSERT THE USB CHARGING CABLE'S STANDARD USB PLUG INTO THE USB PORT OF A COMPUTER OR SUITABLE USB CHARGING ADAPTER.

- (RED) = CHARGING
- (OFF) = CHARGING COMPLETE

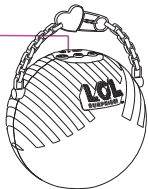

4. THE LED INDICATOR LIGHT TURNS RED WHILE THE SPEAKER IS CHARGING THEN TURNS OFF ONCE CHARGING IS COMPLETE.

NOTES:

--CHARGING CAN TAKE APPROXIMATELY FIVE HOURS TO COMPLETE WHEN THE BATTERY IS FULLY DRAINED.

--REMOVE THE CHARGING CABLE ONCE CHARGING IS COMPLETE.

--OVERCHARGING COULD REDUCE THE LIFE OF THE BATTERY.

--A CHARGED BATTERY WILL LOSE ITS CAPACITY IF IT IS NOT USED ON A REGULAR BASIS.

--ONCE PAIRED, MOST PHONES WILL DISPLAY A BATTERY ICON LETTING YOU KNOW THE CHARGE LEVEL OF THE SPEAKER'S BATTERY.

IMPORTANT: TO AVOID A COMPLETE DISCHARGE OF THE BATTERY, CHARGE YOUR SPEAKER AT LEAST ONCE EVERY SIX MONTHS.

PAIRING YOUR SPEAKER WITH A BLUETOOTH DEVICE

POWER SWITCH 

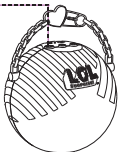

1. SLIDE THE POWER SWITCH TO THE "ON" POSITION TO POWER ON YOUR SPEAKER.

PAIRING MODE
BLUE FLASHING LED

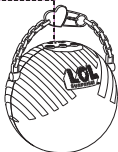

2. THE LED INDICATOR LIGHT WILL TURN BLUE AND FLASH RAPIDLY TO INDICATE THAT YOUR SPEAKER IS IN PAIRING MODE.



3. GO TO THE BLUETOOTH SETTINGS MENU ON YOUR PHONE. MAKE SURE THAT BLUETOOTH IS TURNED ON. CONNECT TO THE DEVICE LISTED AS "SP2-14136."

PAIRED
BLUE

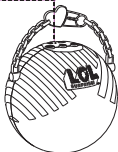

4. THE LED INDICATOR LIGHTS WILL STEADILY SHINE BLUE TO INDICATE THAT YOUR SPEAKER IS PAIRED WITH YOUR PHONE. NOTE THAT THE LIGHT MAY BLINK SLOWLY ANYTIME MUSIC IS PLAYING.

NOTE: IF PAIRING IS NOT COMPLETED AFTER AN EXTENDED PERIOD OF TIME, THE SPEAKER WILL POWER OFF. IF THIS HAPPENS, SLIDE THE POWER SWITCH TO THE "OFF" POSITION, AND THEN REPEAT THE PAIRING STEPS ABOVE.

USING YOUR SPEAKER

POWER SWITCH 



1. SLIDE THE POWER SWITCH TO THE "ON" POSITION TO POWER ON YOUR SPEAKER OR THE "OFF" POSITION TO POWER OFF YOUR SPEAKER.

 **LAST TRACK (TAP)**  **NEXT TRACK (TAP)**

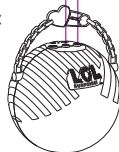

2. TAP THE NEXT TRACK BUTTON TO ADVANCE TO THE NEXT TRACK IN A PLAYLIST. TAP THE LAST TRACK BUTTON TO RETURN TO THE LAST TRACK IN A PLAYLIST.

 **VOLUME DOWN (PRESS AND HOLD)**  **VOLUME UP (PRESS AND HOLD)**

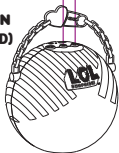

3. PRESS AND HOLD THE VOLUME UP BUTTON TO INCREASE THE VOLUME. PRESS AND HOLD THE VOLUME DOWN BUTTON TO DECREASE THE VOLUME.

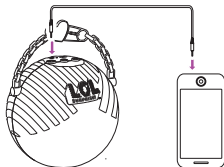

4. YOU CAN ALSO USE A 3.5MM AUXILIARY CABLE TO CONNECT AUDIO DEVICES THROUGH THE AUXILIARY PORT ON YOUR SPEAKER.

MAINTENANCE AND CARE

-BEFORE USING YOUR SPEAKER, INSPECT THE PORTS TO MAKE SURE THAT THEY ARE CLEAR OF DUST AND DEBRIS BEFORE CHARGING OR INSERTING AN AUX CABLE.

-USE A SOFT CLOTH TO CLEAN YOUR SPEAKER. NEVER USE ANY HARSH CHEMICALS OR DETERGENTS. MAKE SURE YOUR SPEAKER IS DRY BEFORE USING.

-WHEN YOUR SPEAKER IS NOT IN USE, IT SHOULD BE STORED IN A COOL, DRY PLACE.

-NEVER TUG ON EITHER USB CHARGING CABLES OR AUX CABLES WHILE THEY ARE CONNECTED TO YOUR SPEAKER. CONNECT AND DISCONNECT THESE CABLES AS CAREFULLY AS POSSIBLE.

-NEVER EXPOSE YOUR SPEAKER TO HIGH TEMPERATURES, EXTREME COLD, HIGH HUMIDITY OR EXCESSIVE MOISTURE OR WATER.

-PLEASE RECYCLE OR DISPOSE OF YOUR SPEAKER PROPERLY BASED ON THE LAWS AND RULES OF YOUR MUNICIPALITY. CONTACT LOCAL RECYCLING FACILITIES AND/OR THE MANUFACTURER OF YOUR SPEAKER FOR FURTHER INFORMATION.



FCC STATEMENT

CHANGES OR MODIFICATIONS NOT EXPRESSLY APPROVED BY THE PARTY RESPONSIBLE FOR COMPLIANCE COULD VOID THE USER'S AUTHORITY TO OPERATE THE EQUIPMENT.

THIS DEVICE COMPLIES WITH PART 15 OF THE FCC RULES. OPERATION IS SUBJECT TO THE FOLLOWING TWO CONDITIONS: (1) THIS DEVICE MAY NOT CAUSE HARMFUL INTERFERENCE, AND (2) THIS DEVICE MUST ACCEPT ANY INTERFERENCE RECEIVED, INCLUDING INTERFERENCE THAT MAY CAUSE UNDESIRE OPERATION.

THIS EQUIPMENT HAS BEEN TESTED AND FOUND TO COMPLY WITH THE LIMITS FOR A CLASS B DIGITAL DEVICE, PURSUANT TO PART 15 OF THE FCC RULES. THESE LIMITS ARE DESIGNED TO PROVIDE REASONABLE PROTECTION AGAINST HARMFUL INTERFERENCE IN A RESIDENTIAL INSTALLATION. THIS EQUIPMENT GENERATES, USES AND CAN RADIATE RADIO FREQUENCY ENERGY AND, IF NOT INSTALLED AND USED IN ACCORDANCE WITH THE INSTRUCTIONS, MAY CAUSE HARMFUL INTERFERENCE TO RADIO COMMUNICATIONS. HOWEVER, THERE IS NO GUARANTEE THAT INTERFERENCE WILL NOT OCCUR IN A PARTICULAR INSTALLATION.

IF THIS EQUIPMENT DOES CAUSE HARMFUL INTERFERENCE TO RADIO OR TELEVISION RECEPTION, WHICH CAN BE DETERMINED BY TURNING THE EQUIPMENT OFF AND ON, THE USER IS ENCOURAGED TO TRY TO CORRECT THE INTERFERENCE BY ONE OR MORE OF THE FOLLOWING MEASURES:

- REORIENT OR RELOCATE THE RECEIVING ANTENNA.**
- INCREASE THE SEPARATION BETWEEN THE EQUIPMENT AND RECEIVER.**
- CONNECT THE EQUIPMENT INTO AN OUTLET ON A CIRCUIT DIFFERENT FROM THAT TO WHICH THE RECEIVER IS CONNECTED.**
- CONSULT THE DEALER OR AN EXPERIENCED RADIO/TV TECHNICIAN FOR HELP.**

THIS EQUIPMENT COMPLIES WITH THE FCC RF RADIATION EXPOSURE LIMITS SET FORTH FOR AN UNCONTROLLED ENVIRONMENT. THIS EQUIPMENT SHOULD BE INSTALLED AND OPERATED WITH A MINIMUM DISTANCE OF 20 CENTIMETERS BETWEEN THE RADIATOR AND YOUR BODY.

SAKAR ONE YEAR WARRANTY

THIS WARRANTY COVERS THE ORIGINAL CONSUMER PURCHASER ONLY AND IS NOT TRANSFERABLE. THIS WARRANTY COVERS PRODUCTS THAT FAIL TO FUNCTION PROPERLY UNDER NORMAL USAGE, DUE TO DEFECTS IN MATERIAL OR WORKMANSHIP. YOUR PRODUCT WILL BE REPAIRED OR REPLACED AT NO CHARGE FOR PARTS OR LABOR FOR A PERIOD OF ONE YEAR.

WHAT IS NOT COVERED BY WARRANTY

DAMAGES OR MALFUNCTIONS NOT RESULTING FROM DEFECTS IN MATERIAL OR WORKMANSHIP AND DAMAGES OR MALFUNCTIONS FROM OTHER THAN NORMAL USE, INCLUDING BUT LIMITED TO, REPAIR BY UNAUTHORIZED PARTIES, TAMPERING, MODIFICATION OR ACCIDENT.

TO OBTAIN WARRANTY SERVICE AND TROUBLESHOOTING INFORMATION:

CALL 1-877-397-8200 OR VISIT OUR WEBSITE AT WWW.SAKAR.COM.

TO RECEIVE WARRANTY SERVICE ALONG WITH THE NAME AND ADDRESS OF AN AUTHORIZED PRODUCT SERVICE CENTER, THE ORIGINAL CONSUMER PURCHASER MUST CONTACT US FOR PROBLEM DETERMINATION AND SERVICE PROCEDURES. PROOF OF PURCHASE IN THE FORM OF A BILL OF SALE OR RECEIPTED INVOICE, EVIDENCING THAT THE PRODUCT IS WITHIN THE APPLICABLE WARRANTY PERIOD(S), MUST BE PRESENTED IN ORDER TO OBTAIN THE REQUESTED SERVICE. IT IS YOUR RESPONSIBILITY TO PROPERLY PACKAGE AND SEND ANY DEFECTIVE PRODUCTS ALONG WITH A DATED COPY OF PROOF OF PURCHASE, A WRITTEN EXPLANATION OF THE PROBLEM, AND A VALID RETURN ADDRESS TO THE AUTHORIZED SERVICE CENTER AT YOUR EXPENSE. DO NOT INCLUDE ANY OTHER ITEMS OR ACCESSORIES WITH THE DEFECTIVE PRODUCT. ANY PRODUCTS RECEIVED BY THE AUTHORIZED SERVICE CENTER THAT ARE NOT COVERED BY WARRANTY WILL BE RETURNED UNREPAIRED.

SAKAR ONE YEAR WARRANTY (CONTINUED)

NO WARRANTIES, WHETHER EXPRESS OR IMPLIED, INCLUDING, BUT NOT LIMITED TO, ANY IMPLIED WARRANTIES OF MERCHANTABILITY OR FITNESS FOR A PARTICULAR PURPOSE, OTHER THAN THOSE EXPRESSLY DESCRIBED ABOVE SHALL APPLY. DISTRIBUTOR FURTHER DISCLAIMS ALL WARRANTIES AFTER THE EXPRESS WARRANTY PERIOD STATED ABOVE. NO OTHER EXPRESS WARRANTY OR GUARANTY GIVEN BY ANY PERSON, FIRM OR ENTITY WITH RESPECT TO THE PRODUCT SHALL BE BINDING ON DISTRIBUTOR. REPAIR, REPLACEMENT, OR REFUND OF THE ORIGINAL PURCHASE PRICE – AT DISTRIBUTOR'S SOLE DISCRETION – ARE THE EXCLUSIVE REMEDIES OF THE CONSUMER. IN NO EVENT WILL DISTRIBUTOR, ITS MANUFACTURERS, OR SAKAR INT. BE LIABLE FOR ANY INCIDENTAL, DIRECT, INDIRECT, SPECIAL, PUNITIVE OR CONSEQUENTIAL DAMAGES (SUCH AS, BUT NOT LIMITED TO, DAMAGES FOR LOSS OF PROFITS, BUSINESS, SAVINGS, DATA OR RECORDS) CAUSED BY THE USE, MISUSE OR INABILITY TO USE THE PRODUCT. EXCEPT AS STATED HEREIN, NO OTHER WARRANTIES SHALL APPLY. NOTWITHSTANDING THE FOREGOING, CONSUMER'S RECOVERY AGAINST DISTRIBUTOR SHALL NOT EXCEED THE PURCHASE PRICE OF THE PRODUCT SOLD BY DISTRIBUTOR. THIS WARRANTY SHALL NOT EXTEND TO ANYONE OTHER THAN THE ORIGINAL CONSUMER WHO PURCHASED THE PRODUCT AND IS NOT TRANSFERABLE.

SOME COUNTRIES, STATES OR PROVINCES DO NOT ALLOW THE EXCLUSION OR LIMITATION OF INCIDENTAL OR CONSEQUENTIAL DAMAGES OR ALLOW LIMITATIONS ON WARRANTIES, SO LIMITATION OR EXCLUSIONS MAY NOT APPLY TO YOU. THIS WARRANTY GIVES YOU SPECIFIC LEGAL RIGHTS, AND YOU MAY HAVE OTHER RIGHTS THAT VARY FROM STATE TO STATE OR PROVINCE TO PROVINCE. CONTACT YOUR AUTHORIZED RETAILER TO DETERMINE IF ANOTHER WARRANTY APPLIES.

