

KM72

ERGONOMIC WIRELESS KEYBOARD AND MOUSE COMBO



User Manual



US/UK

Welcome













Thank you for choosing our wireless product. To ensure optimum performance and safety, please read these instructions carefully before operating this product. It is strongly recommended you keep this manual for future reference.



Shortcut Keys

Key	Function
	Search
	Open My Computer

Fn Key Combinations

Combined keys	Icon	Function
Fn+F1	F1 	Open music player
Fn+F2	F2 	Previous track
Fn+F3	F3 	Next track
Fn+F4	F4 	Pause / play track
Fn+F5	F5 	Volume lower
Fn+F6	F6 	Volume higher
Fn+F7	F7 	Volume mute
Fn+F8	F8 	Sleeping mode
Fn+F9	F9 	Open email
Fn+F10	F10 	Open browser
Fn+F11	F11 	Lock computer
Fn+F12	F12 	Open calculator

Note:

The shortcut keys and Fn key combinations are mainly designed for Windows 8 and Windows 10, for other systems such as the Mac system, some shortcut keys may not work. For F1~F12 multimedia keys, you can achieve those functions by pressing the Fn key and F1~F12 keys together.

Package Contents

1* Wireless keyboard KG9018

1* Wireless mouse G1018E6

1* User manual

Keyboard Product Specifications

Key type	Membrane keys
Battery type	2 AAA batteries
Rating	3V --- 10mA
Sleeping current	≤ 50uA
Key life	8 million keystrokes
Dimension	17.83*8.35*1.06 inches
Weight	1.43 ounces
Keyboard shortcuts	Shortcut multimedia functions
Interface	USB 2.0 interface, plug&play, no driver required
Os support	Compatible with Windows OS (Windows 2000, XP, Vista, Win 7, Win 8, Win 10), Mac

Keyboard Instruction

Battery installation

The wireless keyboard requires two AAA batteries (not included). Turn the keyboard off. Open the battery compartment cover. Put the battery into the battery compartment and make sure the positive ends are pointing in the correct direction. Replace the battery compartment cover. Turn on the keyboard.

Numeric Keypads

Press "Num Lock" button, the LED of " **1** " will turn off and the numeric zone will change to functional zone.

Number "2","4","6","8" are for Down, Left, Right, Up directions

Number "1","3","7","9" are for "End"," Page down"," Home"," Page up"

Number "0" is for "Insert"

Decimal point key "." is for "Delete"

Led Indicator

1. Scroll Lock: Press the "Scroll Lock" key and the first LED light will be red.
2. Caps Lock: Press the "Caps Lock" key and the second LED light will be red.
3. Num indicator: The third LED will be red when the numeric zone is on and the functional zone is off.

Wireless Mouse Product Function

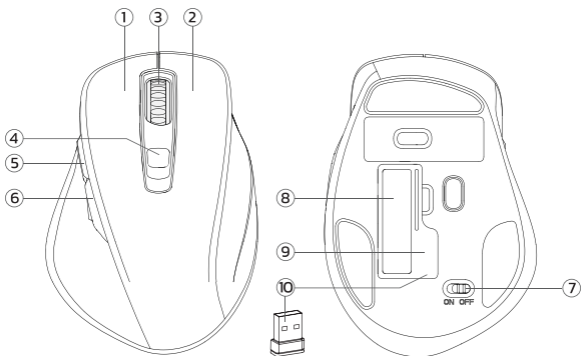

- ① Left Button
- ② Right Button
- ③ Scroll Wheel
- ④ DPI Button
- ⑤ Forward Button

- ⑥ Back Button
- ⑦ On/Off
- ⑧ Battery Compartment
- ⑨ USB Holder
- ⑩ USB Receiver

Wireless Mouse Product Specifications

Working frequency	2.4GHz
Operation voltage	1.5V
Battery type	1 AA battery
Current dissipation	1.5V --- 20mA
Standard current	3.0mA
Sleeping current	≤ 50uA
DPI resolution	800/1200/1600
Working distance	≤ 10m
Key life	3 million
Dimensions	4.72*3.15*1.46 inches
Weight	3.03 ounces

Mouse Instruction

Battery installation

The wireless mouse requires one AA battery(not included). Open the battery compartment cover and install the battery. Then take out the receiver and plug it into the USB port of the computer. Turn on the power switch and the mouse is ready to work.

Willkommen

Vielen Dank, dass Sie sich für unser drahtloses Produkt entschieden haben. Um optimale Leistung und Sicherheit zu gewährleisten, lesen Sie bitte diese Anleitung sorgfältig durch, bevor Sie dieses Produkt in Betrieb nehmen. Es wird dringend empfohlen, dieses Handbuch zum späteren Nachschlagen aufzubewahren.















Tastenkombinationen

Taste	Funktion
	Suche
	Meinen Computer öffnen



Fn-Tastenkombinationen

Kombinierte Tasten	Symbol	Funktion
Fn+F1	F1 	Musikplayer öffnen
Fn+F2	F2 	Vorheriger Titel
Fn+F3	F3 	Nächster Titel
Fn+F4	F4 	Track pausieren / abspielen
Fn+F5	F5 	Lautstärke leiser
Fn+F6	F6 	Lautstärke höher
Fn+F7	F7 	Lautstärke stumm
Fn+F8	F8 	Schlafmodus
Fn+F9	F9 	E-Mail öffnen
Fn+F10	F10 	Browser öffnen
Fn+F11	F11 	Computer sperren
Fn+F12	F12 	Rechner öffnen

Notiz:

Die Tastenkombinationen und Fn-Tastenkombinationen sind hauptsächlich für Windows 8 und Windows 10 konzipiert, für andere Systeme wie das Mac-System funktionieren einige Tastenkombinationen möglicherweise nicht. Für die Multimediatasten F1~F12 können Sie diese Funktionen erreichen, indem Sie die Tasten Fn und F1~F12 gleichzeitig drücken.

Packungsinhalt

1* Kabellose Tastatur KG9018

1* Funkmaus GIO18E6

1* Benutzerhandbuch

Produktspezifikationen der Tastatur

Schlüsseltyp	Folientasten
Batterietyp	2 AAA-Batterien
Bewertung	3V \approx 10mA
Schlafstrom	\leq 50uA
Tastenlebensdauer	8 Millionen Tastenanschläge
Abmessung	17,83 * 8,35 * 1,06 Zoll
WeightGewicht	1,43 Unzen
Tastatürkürzel	Verknüpfung von Multimedia-Funktionen
Schnittstelle	USB 2.0-Schnittstelle, Plug&Play, kein Treiber erforderlich
Betriebssystemunterstützung	Kompatibel mit Windows-Betriebssystem (Windows 2000, XP, Vista, Win 7, Win 8, Win 10), Mac

Tastaturanweisung

Batterieinstallation

Die kabellose Tastatur benötigt zwei AAA-Batterien (nicht im Lieferumfang enthalten). Schalten Sie die Tastatur aus. Öffnen Sie die Batteriefachabdeckung. Legen Sie die Batterie in das Batteriefach und stellen Sie sicher, dass die positiven Enden in die richtige Richtung zeigen. Bringen Sie die Batteriefachabdeckung wieder an. Schalten Sie die Tastatur ein.

Numerische Tastaturen

Drücken Sie die „Num Lock“-Taste, die LED von „ **1** “ erlischt und der numerische Bereich wechselt in den Funktionsbereich.

Die Nummern „2“, „4“, „6“, „8“ stehen für die Richtungen nach unten, links, rechts, oben

Die Nummern „1“, „3“, „7“, „9“ stehen für „Ende“, „Seite runter“, „Startseite“, „Seite auf“

Nummer „0“ steht für „Einfügen“

Dezimalpunktaste „.“ ist für „Löschen“

LED-Anzeige

1. Scroll Lock: Drücken Sie die "Scroll Lock"-Taste und das erste LED-Licht leuchtet rot.
2. Feststelltaste: Drücken Sie die "Feststelltaste" und die zweite LED leuchtet rot.
3. Num-Anzeige: Die dritte LED leuchtet rot, wenn die numerische Zone eingeschaltet und die Funktionszone ausgeschaltet ist.

Produktfunktion der drahtlosen Maus

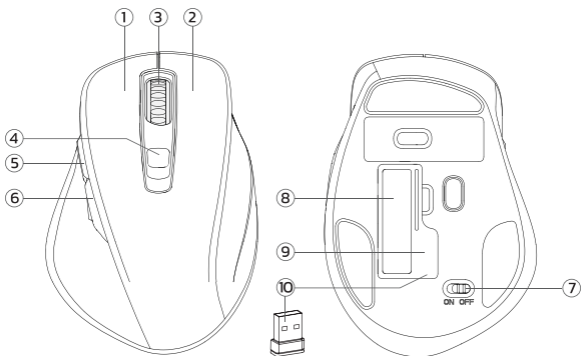

- ① Linker Knopf
- ② Rechter Knopf
- ③ Scrollrad
- ④ DPI-Taste
- ⑤ Weiterleitungstaste

- ⑥ Zurück-Button
- ⑦ An aus
- ⑧ Batteriefach
- ⑨ USB-Halter
- ⑩ USB-Empfänger

Produktspezifikationen für drahtlose Mäuse

Arbeitsfrequenz	2,4 GHz
Betriebsspannung	1,5V
Batterietyp	1 AA-Batterie
Stromableitung	1,5V \approx 20mA
Standardstrom	3,0mA
Schlafstrom	\leq 50uA
DPI-Auflösung	800/1200/1600
Arbeitsabstand	\leq 10m
Schlüssellebensdauer	3 Millionen
Abmessungen	4,72 * 3,15 * 1,46 Zoll
tl. Gewicht	3,03 Unzen

Anleitung zur Maus

Batterieinstallation

Die kabellose Maus benötigt eine AA-Batterie (nicht im Lieferumfang enthalten). Öffnen Sie die Batteriefachabdeckung und legen Sie die Batterie ein. Nehmen Sie dann den Empfänger heraus und stecken Sie ihn in den USB-Port des Computers. Schalten Sie den Netzschalter ein und die Maus ist betriebsbereit.

FCC ID

Any Changes or modifications not expressly approved by the party responsible for compliance could void the user's authority to operate the equipment.

This device complies with part 15 of the FCC Rules. Operation is subject to the following two conditions: (1) This device may not cause harmful interference, and (2) this device must accept any interference received, including interference that may cause undesired operation.

FCC Radiation Exposure Statement

This equipment complies with FCC radiation exposure limits set forth for an uncontrolled environment.

Correct Disposal of This Product



(Waste Electrical & Electronic Equipment)

This Marking shown on the product or its literature, indicate that it should not be disposed with other household wastes at the end of its working life.

To prevent possible harm to the environment or human health from uncontrolled waste disposal, please separate this from other types of wastes and recycle it responsibly to promote the sustainable reuse of material resources. Household user should contact either the retailer where they purchased this product or their local government office, for details of where and how they can take this item for environmentally safe recycling.

Business users should contact their supplier and check the terms and conditions of the purchase contract. This product should not be mixed with other commercial wastes for disposal.



EU	REP
-----------	------------

C&E Connection E-Commerce(DE) GmbH
Zum Linnegraben 20, 65933,
Frankfurt am Main, Germany
Email: info@ce-connection.de
Phone: +49(069) 27246648

UK	REP
-----------	------------

CET PRODUCT SERVICE LTD.
Chase Business Centre, 39-41 Chase Side,
London N14 5BP United Kingdom
Email: info.cetservice@gmail.com
Phone: +447419325266