



CTC Laboratories, Inc.

1-2/F., Building 2, Jiaquan Building, Guanlan High-Tech Park, Shenzhen, Guangdong, China
Tel: +86-755-27521059 Fax: +86-755-27521011 <http://www.sz-ctc.org.cn>

TEST REPORT

Report No.: **CTC20220787E01**

FCC ID.....: **2AAVD-KG9012**

IC.....: **23918-KG9012**

Applicant.....: **Shenzhen Loyal Electronics Co., Ltd.**

Address.....: No.5, First Industry Park, Shanmen Songgang, Baoan, Shenzhen, Guangdong, China

Manufacturer.....: Shenzhen Loyal Electronics Co., Ltd.

Address.....: No.5, First Industry Park, Shanmen Songgang, Baoan, Shenzhen, Guangdong, China

Product Name.....: **Wireless Keyboard**

Trade Mark.....: /

Model/Type reference.....: KG9012

Listed Model(s): /

Standard.....: **FCC CFR Title 47 Part 15 Subpart C Section 15.249
RSS-210 Issue 10**

Date of receipt of test sample...: Apr. 15, 2022

Date of testing.....: Apr. 15, 2022 to Apr. 28, 2022

Date of issue.....: Apr. 29, 2022

Result.....: **PASS**

| | | |
|--------------------------|------------|---------------------------------------------------------------------------------------|
| Compiled by: | | |
| (Printed name+signature) | Jim Jiang |  |
| Supervised by: | | |
| (Printed name+signature) | Miller Ma |  |
| Approved by: | | |
| (Printed name+signature) | Totti Zhao |  |

Testing Laboratory Name.....: **CTC Laboratories, Inc.**

Address.....: 1-2/F., Building 2, Jiaquan Building, Guanlan High-Tech Park, Shenzhen, Guangdong, China

This test report may be duplicated completely for legal use with the approval of the applicant. It should not be reproduced except in full, without the written approval of our laboratory. The client should not use it to claim product endorsement by CTC. The test results in the report only apply to the tested sample. The test report shall be invalid without all the signatures of testing engineers, reviewer and approver. Any objections must be raised to CTC within 15 days since the date when the report is received. It will not be taken into consideration beyond this limit. The test report merely correspond to the test sample.



Table of Contents

Page

1. TEST SUMMARY3

1.1. TEST STANDARDS.....3

1.2. REPORT VERSION3

1.3. TEST DESCRIPTION.....3

1.4. TEST FACILITY4

1.5. MEASUREMENT UNCERTAINTY4

1.6. ENVIRONMENTAL CONDITIONS.....5

2. GENERAL INFORMATION6

2.1. CLIENT INFORMATION6

2.2. GENERAL DESCRIPTION OF EUT6

2.3. ACCESSORY EQUIPMENT INFORMATION7

2.4. OPERATION STATE8

2.5. MEASUREMENT INSTRUMENTS LIST9

3. TEST ITEM AND RESULTS11

3.1. CONDUCTED EMISSION.....11

3.2. 20 DB OCCUPIED BANDWIDTH13

3.3. RADIATED FIELD STRENGTH OF THE FUNDAMENTAL SIGNAL.....16

3.4. RADIATED SPURIOUS EMISSIONS AND BANDEDGE EMISSION23

3.5. BAND EDGE EMISSIONS (RADIATED)31

3.6. ANTENNA REQUIREMENT.....36



1. TEST SUMMARY

1.1. Test Standards

The tests were performed according to following standards:

[FCC Rules Part 15.249](#): Operation within the bands 902-928 MHz, 2400-2483.5 MHz, 5725-5875 MHz, and 24.0-24.25 GHz.

[RSS-210](#): Licence-Exempt Radio Apparatus: Category I Equipment

[ANSI C63.10-2013](#): American National Standard for Testing Unlicensed Wireless Devices.

1.2. Report Version

| Revised No. | Date of issue | Description |
|-------------|---------------|-------------|
| 01 | Apr. 29, 2022 | Original |
| | | |
| | | |

1.3. Test Description

| FCC Part 15 Subpart C (15.249) / RSS-210 Issue 10 | | | | |
|---------------------------------------------------|------------------|---------------|--------|---------------|
| Test Item | Standard Section | | Result | Test Engineer |
| | FCC | IC | | |
| Antenna Requirement | 15.203 | / | Pass | Jim Jiang |
| AC Power Line Conducted Emissions | 15.207 | RSS-Gen 8.8 | N/A | N/A |
| 20dB Occupied Bandwidth | 15.215/15.249 | / | Pass | Jim Jiang |
| Field strength of the Fundamental signal | 15.249(a) | RSS-210 F.1.a | Pass | Jim Jiang |
| Spurious Emissions | 15.209/15.249(a) | RSS-210 F.1.e | Pass | Jim Jiang |
| Band edge Emissions | 15.205/15.249(d) | / | Pass | Jim Jiang |

Note:

1. The measurement uncertainty is not included in the test result.
2. N/A: means this test item is not applicable for this device according to the technology characteristic of device.



1.4. Test Facility

CTC Laboratories, Inc.

Add: 1-2/F., Building 2, Jiaquan Building, Guanlan High-Tech Park, Shenzhen, Guangdong, China

Laboratory accreditation

The test facility is recognized, certified, or accredited by the following organizations:

A2LA-Lab Cert. No.: 4340.01

CTC Laboratories, Inc. EMC Laboratory has been accredited by A2LA for technical competence in the field of electrical testing, and proved to be in compliance with ISO/IEC 17025:2017 General Requirements for the Competence of Testing and Calibration Laboratories and any additional program requirements in the identified field of testing.

Industry Canada (Registration No.: 9783A, CAB Identifier: CN0029)

CTC Laboratories, Inc. EMC Laboratory has been registered by Certification and Engineer Bureau of Industry Canada for the performance of with Registration NO.: 9783A on Jan, 2016.

FCC (Registration No.: 951311, Designation Number CN1208)

CTC Laboratories, Inc. EMC Laboratory has been registered and fully described in a report filed with the (FCC) Federal Communications Commission. The acceptance letter from the FCC is maintained in our files. Registration 951311, Aug 26, 2017.

1.5. Measurement Uncertainty

The data and results referenced in this document are true and accurate. The reader is cautioned that there may be errors within the calibration limits of the equipment and facilities. The measurement uncertainty was calculated for all measurements listed in this test report acc. to TR-100028-01 "Electromagnetic compatibility and Radio spectrum Matters (ERM); Uncertainties in the measurement of mobile radio equipment characteristics; Part 1" and TR-100028-02 "Electromagnetic compatibility and Radio spectrum Matters (ERM); Uncertainties in the measurement of mobile radio equipment characteristics; Part 2" and is documented in the CTC Laboratories, Inc. quality system acc. to DIN EN ISO/IEC 17025. Furthermore, component and process variability of devices similar to that tested may result in additional deviation. The manufacturer has the sole responsibility of continued compliance of the device.

Below is the best measurement capability for CTC Laboratories, Inc.



| Test Items | Measurement Uncertainty | Notes |
|-----------------------------------------|-------------------------|-------|
| Transmitter power conducted | 0.42 dB | (1) |
| Transmitter power Radiated | 2.14 dB | (1) |
| Conducted spurious emissions 9kHz~40GHz | 1.60 dB | (1) |
| Radiated spurious emissions 9kHz~40GHz | 2.20 dB | (1) |
| Conducted Emissions 9kHz~30MHz | 3.20 dB | (1) |
| Radiated Emissions 30~1000MHz | 4.70 dB | (1) |
| Radiated Emissions 1~18GHz | 5.00 dB | (1) |
| Radiated Emissions 18~40GHz | 5.54 dB | (1) |
| Occupied Bandwidth | ----- | (1) |

Note (1): This uncertainty represents an expanded uncertainty expressed at approximately the 95% confidence level using a coverage factor of k=2.

1.6. Environmental Conditions

During the measurement the environmental conditions were within the listed ranges:

| | |
|-----------------------|-----------|
| Temperature: | 21°C~27°C |
| Relative Humidity: | 40%~60% |
| Atmospheric Pressure: | 101kPa |



2. GENERAL INFORMATION

2.1. Client Information

| | |
|---------------|--------------------------------------------------------------------------------|
| Applicant: | Shenzhen Loyal Electronics Co., Ltd. |
| Address: | No.5, First Industry Park, Shanmen Songgang, Baoan, Shenzhen, Guangdong, China |
| Manufacturer: | Shenzhen Loyal Electronics Co., Ltd. |
| Address: | No.5, First Industry Park, Shanmen Songgang, Baoan, Shenzhen, Guangdong, China |

2.2. General Description of EUT

| | |
|------------------------|---------------------|
| Product Name: | Wireless Keyboard |
| Trade Mark: | / |
| Model/Type reference: | KG9012 |
| Listed Model(s): | / |
| Model Difference: | / |
| Power supply: | Input: DC1.5V 100mA |
| Tested model: | KG9012 |
| Serial number: | 2205000008 |
| Software version: | V1.0 |
| 2.4GHz ISM Band | |
| Modulation: | GFSK |
| Operation frequency: | 2402MHz~2480MHz |
| Channel number: | 79 |
| Antenna type: | PCB Antenna |
| Antenna gain: | 2.08dBi |



2.3. Accessory Equipment Information

| Equipment Information | | | |
|---------------------------|----------------|--------------|--------------|
| Name | Model | S/N | Manufacturer |
| Notebook | ThinkPad T460s | / | Lenovo |
| Cable Information | | | |
| Name | Shielded Type | Ferrite Core | Length |
| USB Cable | Unshielded | NO | 100cm |
| Test Software Information | | | |
| Name | Version | / | / |
| FCC Test Tool | V1.6 | / | / |

CTC Laboratories, Inc.

1-2/F., Building 2, Jiaquan Building, Guanlan High-Tech Park, Shenzhen, Guangdong, China
Tel.: (86)755-27521059 Fax: (86)755-27521011 Http://www.sz-ctc.org.cnFor anti-fake verification, please visit the official website of Certification and Accreditation Administration of the People's Republic of China : yz.cnca.cn



2.4. Operation State

The EUT has been tested under test mode condition. The Applicant provides software to control the EUT for staying in continuous transmitting and receiving mode for testing.

Operation Frequency List:

| Channel | Frequency (MHz) |
|-----------|-----------------|
| 01 | 2402 |
| 02 | 2403 |
| : | : |
| 38 | 2439 |
| 39 | 2440 |
| 40 | 2441 |
| : | : |
| 78 | 2479 |
| 79 | 2480 |

Note: The display in grey were the channel selected for testing.

Test Mode:

| |
|--------------------------------------------------------------------------------------------------------------------------------------------------------------------------------------------------------------------------|
| For RF test items |
| The engineering test program was provided and enabled to make EUT continuous transmit. (duty cycle>98%). |
| For AC power line conducted emissions: |
| The EUT was set to connect with large package sizes transmission. |
| For Radiated spurious emissions test item: |
| The engineering test program was provided and enabled to make EUT continuous transmit. The EUT in each of three orthogonal axis emissions had been tested, but only the worst case (X axis) data recorded in the report. |



2.5. Measurement Instruments List

| Tonscend JS0806-2 Test system | | | | | |
|-------------------------------|-------------------------------------|-----------------|-----------|------------|------------------|
| Item | Test Equipment | Manufacturer | Model No. | Serial No. | Calibrated until |
| 1 | Spectrum Analyzer | Rohde & Schwarz | FSU26 | 100105 | Dec. 23, 2022 |
| 2 | Spectrum Analyzer | Rohde & Schwarz | FUV40-N | 101331 | Mar. 15, 2023 |
| 3 | MXG Vector Signal Generator | Agilent | N5182A | MY47420864 | Dec. 23, 2022 |
| 4 | Signal Generator | Agilent | E8257D | MY46521908 | Dec. 23, 2022 |
| 5 | Power Sensor | Agilent | U2021XA | MY5365004 | Mar. 15, 2023 |
| 6 | Power Sensor | Agilent | U2021XA | MY5365006 | Mar. 15, 2023 |
| 7 | Simultaneous Sampling DAQ | Agilent | U2531A | TW54493510 | Mar. 15, 2023 |
| 8 | Climate Chamber | TABAI | PR-4G | A8708055 | Dec. 23, 2022 |
| 9 | Wideband Radio Communication Tester | Rohde & Schwarz | CMW500 | 116410 | Dec. 23, 2022 |
| 10 | Climate Chamber | ESPEC | MT3065 | / | Dec. 23, 2022 |
| 11 | 300328 v2.2.2 test system | TONSCEND | v2.6 | / | / |

| Radiated emission | | | | | |
|-------------------|------------------------------|--------------|------------|------------|------------------|
| Item | Test Equipment | Manufacturer | Model No. | Serial No. | Calibrated until |
| 1 | Trilog-Broadband Antenna | Schwarzbeck | VULB 9168 | 9168-759 | Nov. 09, 2022 |
| 2 | Horn Antenna | Schwarzbeck | BBHA 9120D | 9120D-647 | Dec. 23, 2022 |
| 3 | Test Receiver | Keysight | N9038A | MY56400071 | Dec. 23, 2022 |
| 4 | Broadband Prempplier | SCHWARZBECK | BBV9743B | 259 | Dec. 23, 2022 |
| 5 | Mirowave Broadband Amplifier | SCHWARZBECK | BBV9718C | 111 | Dec. 23, 2022 |
| 6 | 3m chamber 3 | YIHENG | EE106 | / | Sep. 09, 2023 |

CTC Laboratories, Inc.

1-2/F., Building 2, Jiaquan Building, Guanlan High-Tech Park, Shenzhen, Guangdong, China
Tel.: (86)755-27521059 Fax: (86)755-27521011 Http://www.sz-ctc.org.cn



For anti-fake verification, please visit the official website of Certification and Accreditation Administration of the People's Republic of China : yz.cnca.cn



| Conducted Emission | | | | | |
|--------------------|-------------------|--------------|-----------|----------------|------------------|
| Item | Test Equipment | Manufacturer | Model No. | Serial No. | Calibrated until |
| 1 | LISN | R&S | ENV216 | 101112 | Dec. 23, 2022 |
| 2 | LISN | R&S | ENV216 | 101113 | Dec. 23, 2022 |
| 3 | EMI Test Receiver | R&S | ESCS30 | 100353 | Dec. 23, 2022 |
| 4 | ISN CAT6 | Schwarzbeck | NTFM 8158 | CAT6-8158-0046 | Dec. 23, 2022 |
| 5 | ISN CAT5 | Schwarzbeck | NTFM 8158 | CAT5-8158-0046 | Dec. 23, 2022 |

Note:

1. The Cal. Interval was one year.
2. The cable loss has calculated in test result which connection between each test instruments.

3. TEST ITEM AND RESULTS

3.1. Conducted Emission

Limit

FCC CFR Title 47 Part 15 Subpart C Section 15.207/ RSS - Gen 8.8

| Frequency range (MHz) | Limit (dBuV) | |
|-----------------------|--------------|-----------|
| | Quasi-peak | Average |
| 0.15-0.5 | 66 to 56* | 56 to 46* |
| 0.5-5 | 56 | 46 |
| 5-30 | 60 | 50 |

* Decreases with the logarithm of the frequency.

Test Configuration

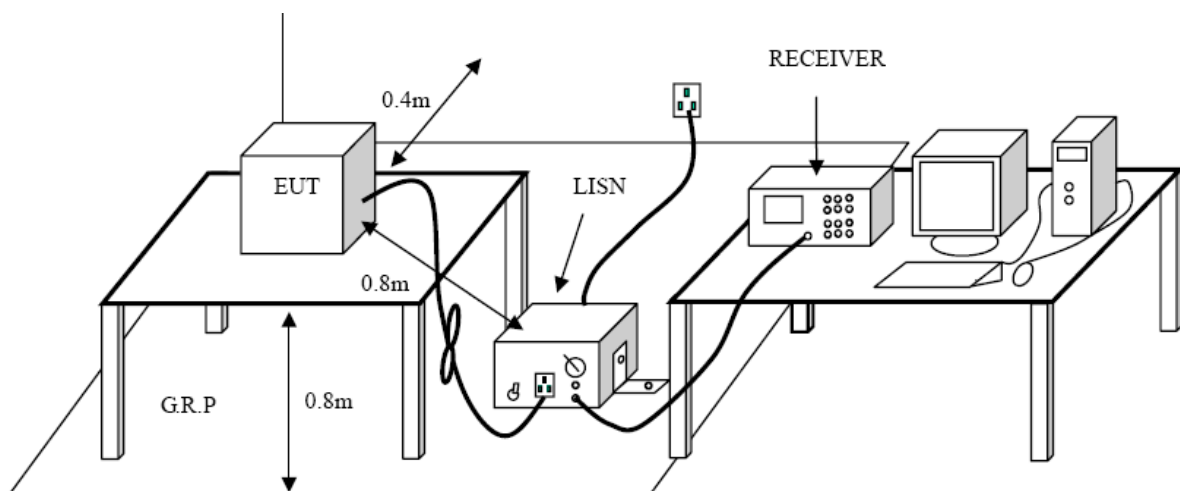

Test Procedure

1. The EUT was setup according to ANSI C63.10:2013 requirements.
2. The EUT was placed on a platform of nominal size, 1 m by 1.5 m, raised 80 cm above the conducting ground plane. The vertical conducting plane was located 40 cm to the rear of the EUT. All other surfaces of EUT were at least 80 cm from any other grounded conducting surface.
3. The EUT and simulators are connected to the main power through a line impedances stabilization network (LISN). The LISN provides a 50ohm /50uH coupling impedance for the measuring equipment. The peripheral devices are also connected to the main power through a LISN. (Please refer to the block diagram of the test setup and photographs)
4. Each current-carrying conductor of the EUT power cord, except the ground (safety) conductor, was individually connected through a LISN to the input power source.
5. The excess length of the power cord between the EUT and the LISN receptacle were folded back and forth at the center of the lead to form a bundle not exceeding 40 cm in length.
6. Conducted Emissions were investigated over the frequency range from 0.15MHz to 30MHz using a receiver bandwidth of 9 kHz.
7. During the above scans, the emissions were maximized by cable manipulation.



Test Mode

Please refer to the clause 2.4.

Test Results

Not applicable.

3.2. 20 dB Occupied Bandwidth

Limit

Operation frequency range 2400MHz~2483.5MHz.

Test Configuration

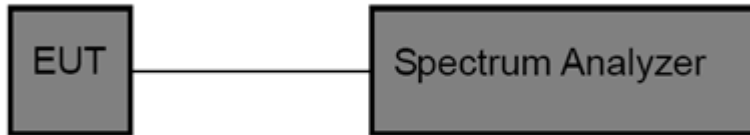

Test Procedure

1. The transmitter output was connected to the spectrum analyzer through an attenuator, the path loss was compensated to the results for each measurement.
2. Set to the maximum power setting and enable the EUT transmit continuously
3. Use the following spectrum analyzer settings:
Span = approximately 2 to 3 times the 20 dB bandwidth, centered on a test channel
RBW \geq 1% of the 20 dB bandwidth, VBW \geq RBW
Sweep = auto, Detector function = peak, Trace = max hold
4. Measure and record the results in the test report.

Test Mode

Please refer to the clause 2.4

Test Results

| Channel | 20dB Bandwidth (MHz) | 99% Bandwidth (MHz) | Result |
|---------|----------------------|---------------------|--------|
| 01 | 1.091 | 1.048 | Pass |
| 39 | 1.101 | 1.058 | Pass |
| 79 | 1.106 | 1.058 | Pass |



20dB Bandwidth:

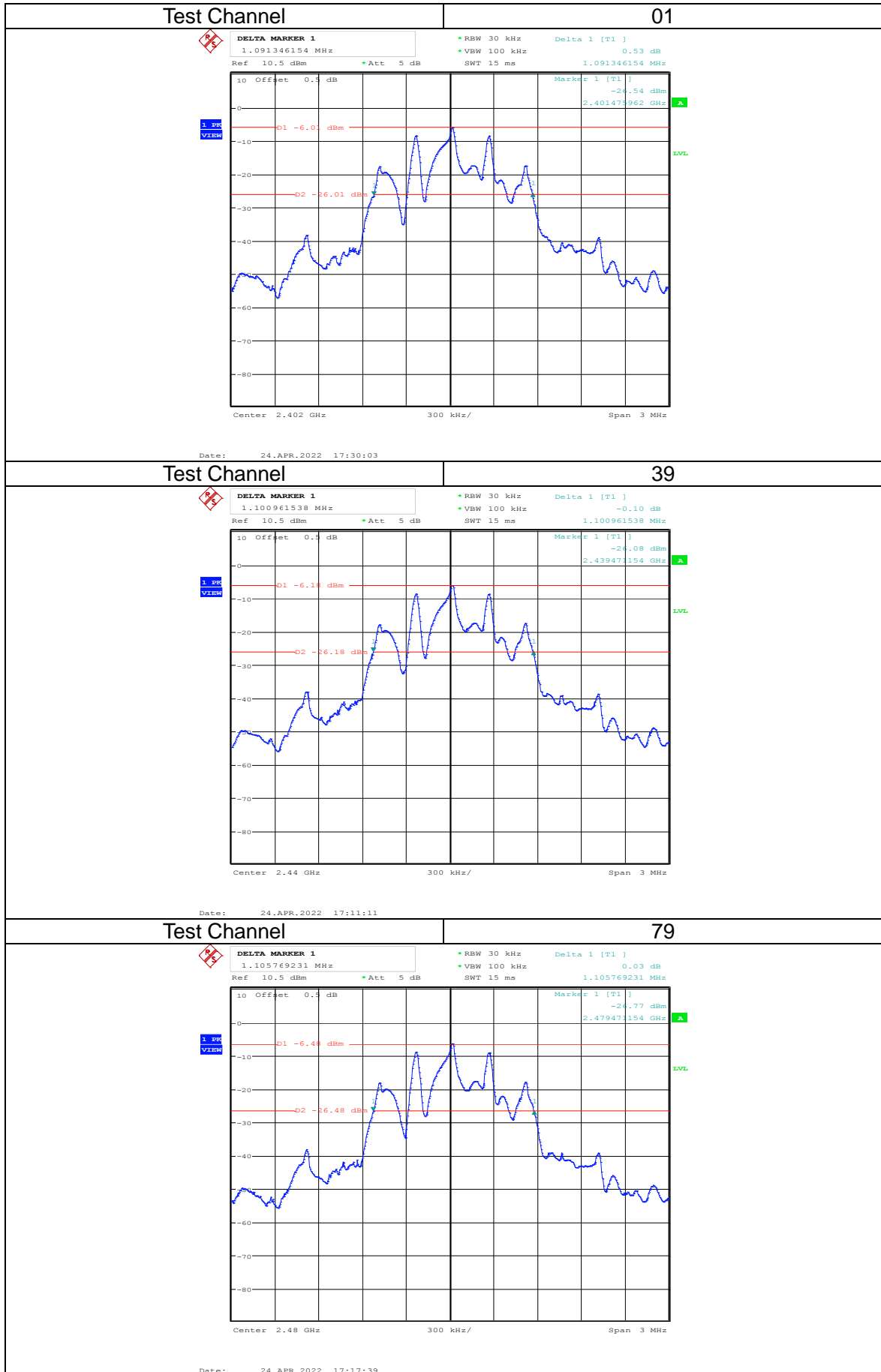

CTC Laboratories, Inc.

1-2/F., Building 2, Jiaquan Building, Guanlan High-Tech Park, Shenzhen, Guangdong, China
Tel.: (86)755-27521059 Fax: (86)755-27521011 Http://www.sz-ctc.org.cn



For anti-fake verification, please visit the official website of Certification and Accreditation Administration of the People's Republic of China : yz.cnca.cn



99% Bandwidth:

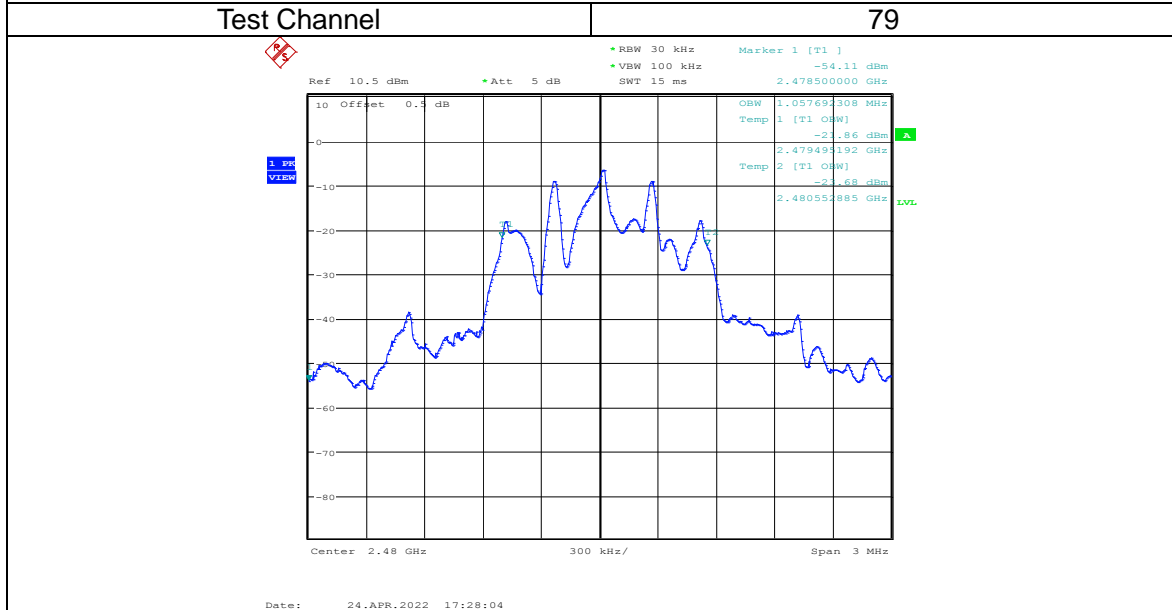
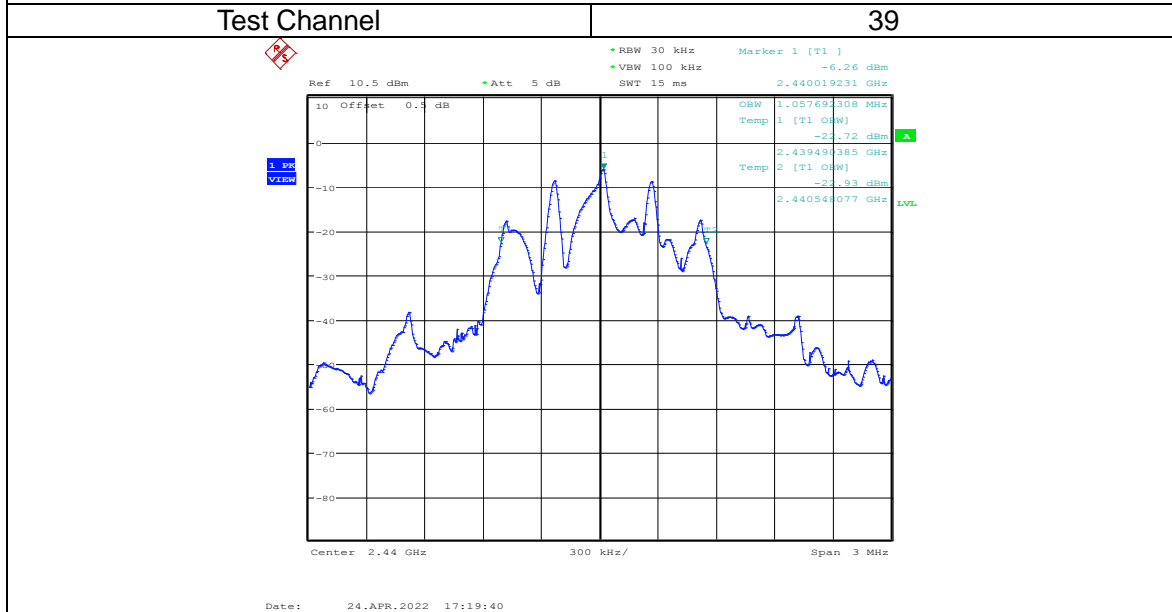
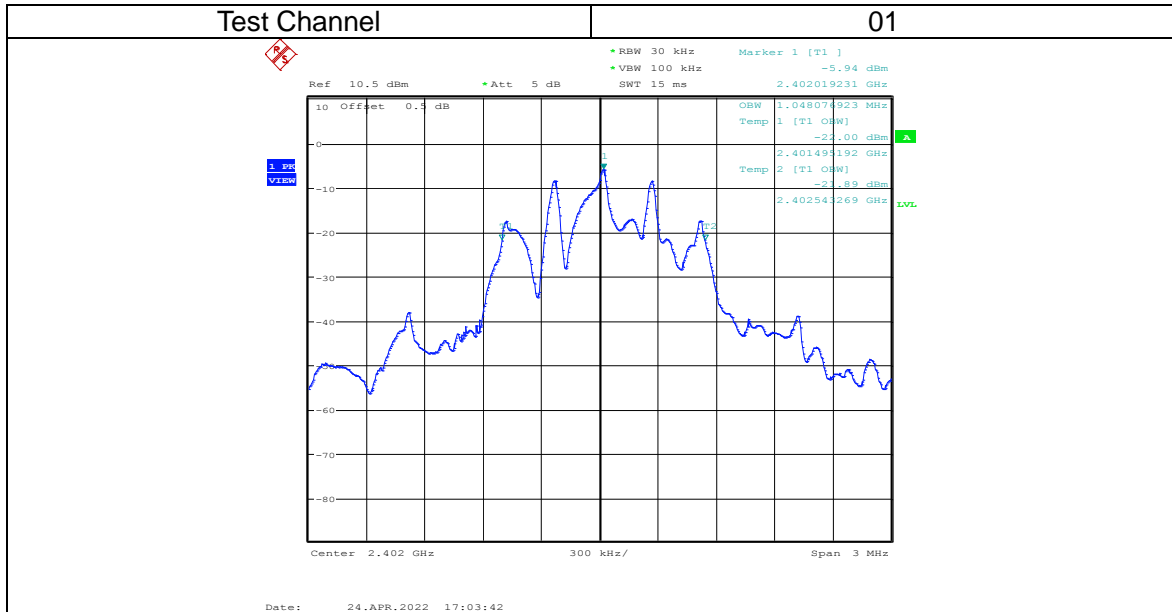

CTC Laboratories, Inc.

1-2/F., Building 2, Jiaquan Building, Guanlan High-Tech Park, Shenzhen, Guangdong, China
Tel.: (86)755-27521059 Fax: (86)755-27521011 Http://www.sz-ctc.org.cn



For anti-fake verification, please visit the official website of Certification and Accreditation Administration of the People's Republic of China : yz.cnca.cn

3.3. Radiated field strength of the fundamental signal

Limit

FCC CFR Title 47 Part 15 Subpart C Section 15.249(a)/ RSS – 210 F.1.a

| Fundamental frequency | Field strength of fundamental (millivolts/meter/ AVG) | Field strength of harmonics (microvolts/meter/ AVG) |
|-----------------------|-------------------------------------------------------|-----------------------------------------------------|
| 902-928 MHz | 50 (94dBuV/m @3m) | 500 (54dBuV/m @3m) |
| 2400-2483.5 MHz | 50 (94dBuV/m @3m) | 500 (54dBuV/m @3m) |
| 5725-5875 MHz | 50 (94dBuV/m @3m) | 500 (54dBuV/m @3m) |
| 24.0-24.25 GHz | 250 (108dBuV/m @3m) | 2500 (68dBuV/m @3m) |

Frequencies above 1000 MHz, the field strength limits are based on average limits

Test Configuration

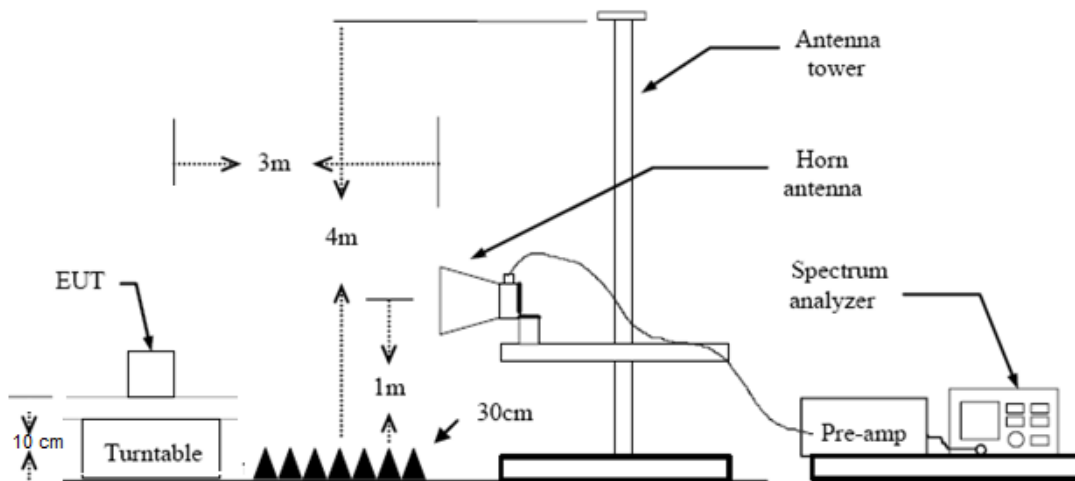

Test Procedure

1. The EUT was setup and tested according to ANSI C63.10:2013 requirements.
2. The EUT is placed on a turn table which is 0.1 meter above ground. The turn table is rotated 360 degrees to determine the position of the maximum emission level.
3. The EUT was positioned such that the distance from antenna to the EUT was 3 meters.
4. The antenna is scanned from 1 meter to 4 meters to find out the maximum emission level. This is repeated for both horizontal and vertical polarization of the antenna. In order to find the maximum emission, all of the interface cables were manipulated according to ANSI C63.10:2013 on radiated measurement.
5. The receiver set as follow:
RBW=1MHz, VBW=3MHz Peak detector for Peak value.

Test Mode

Please refer to the clause 2.4



Test Results

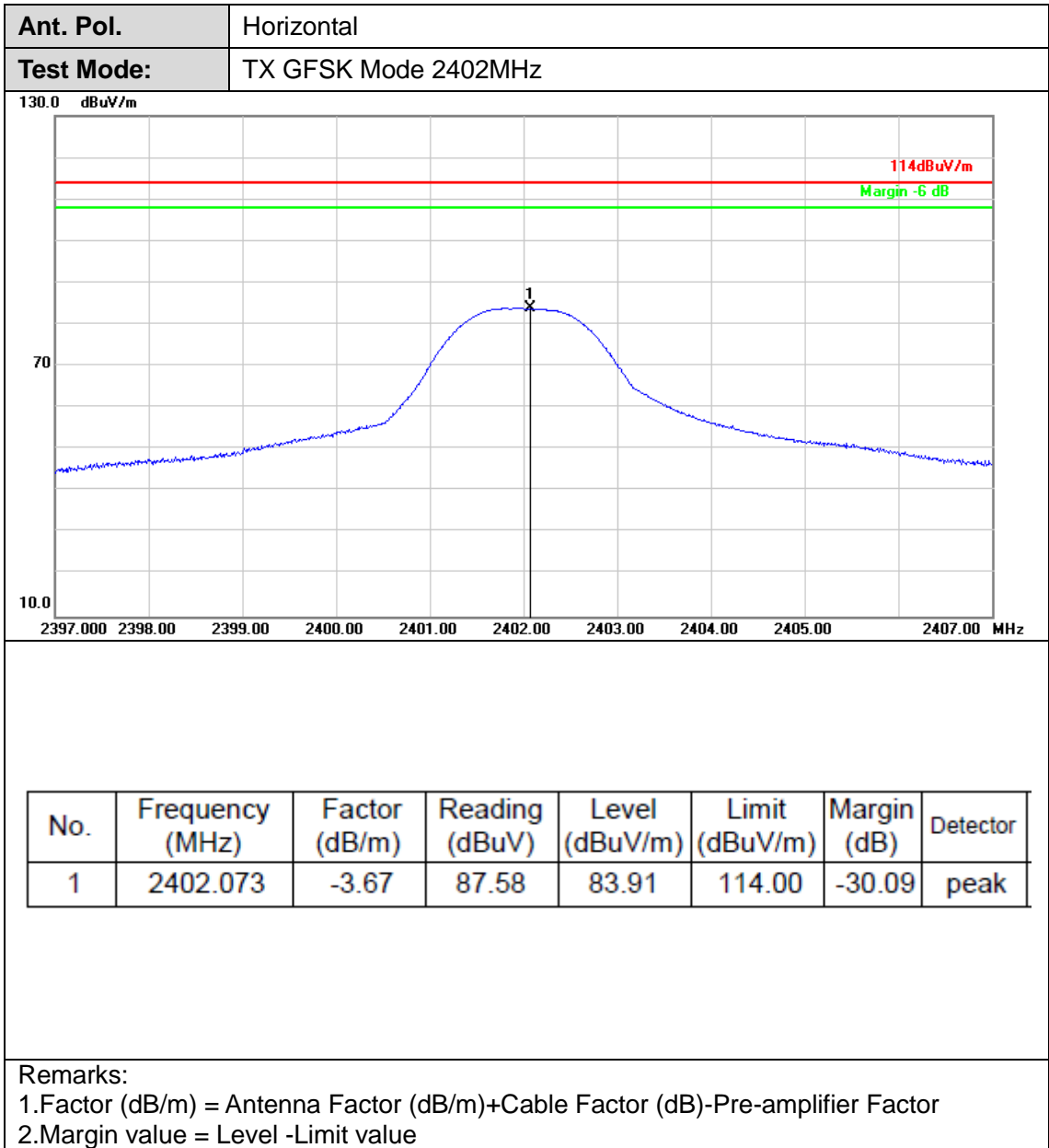

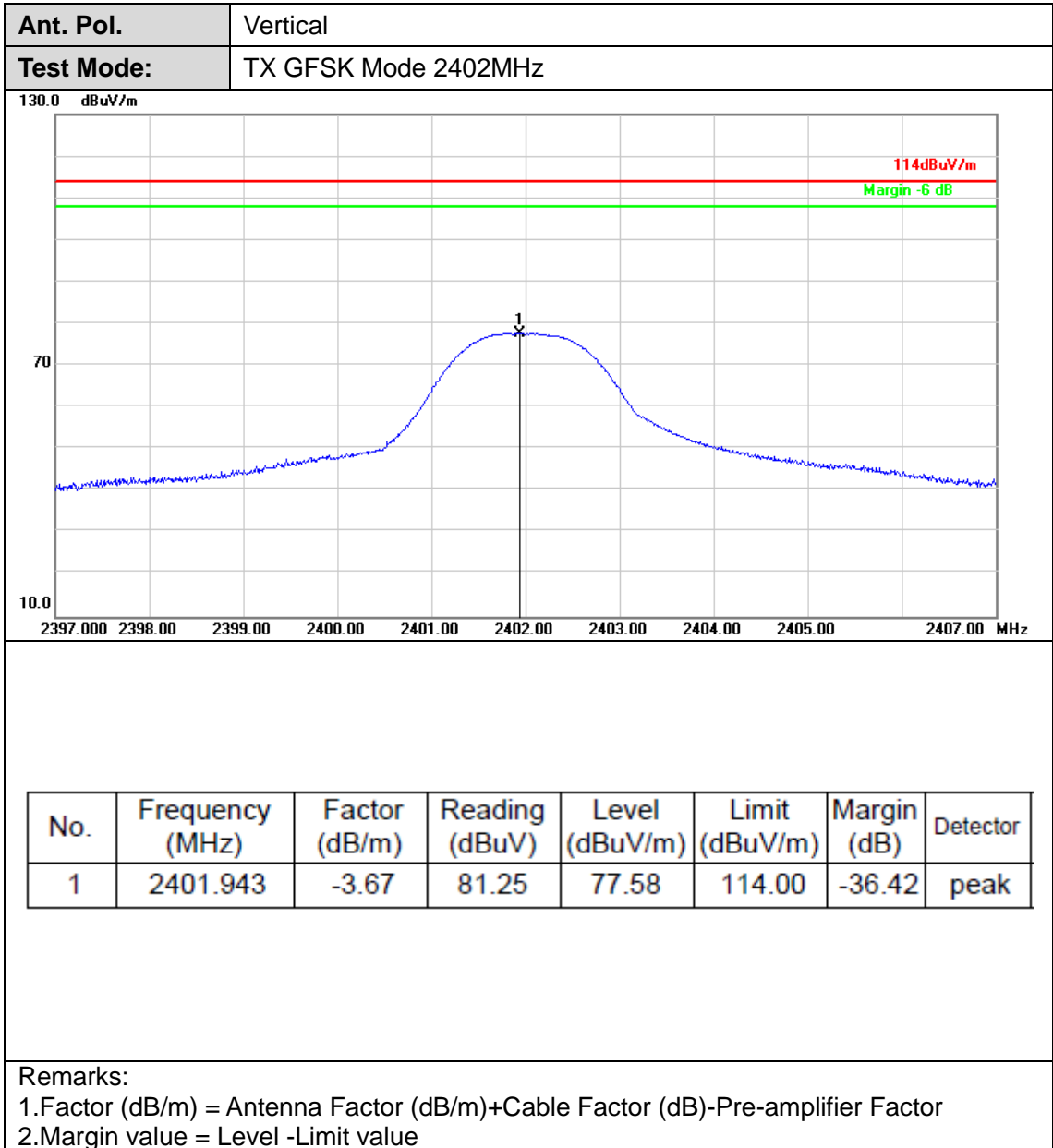

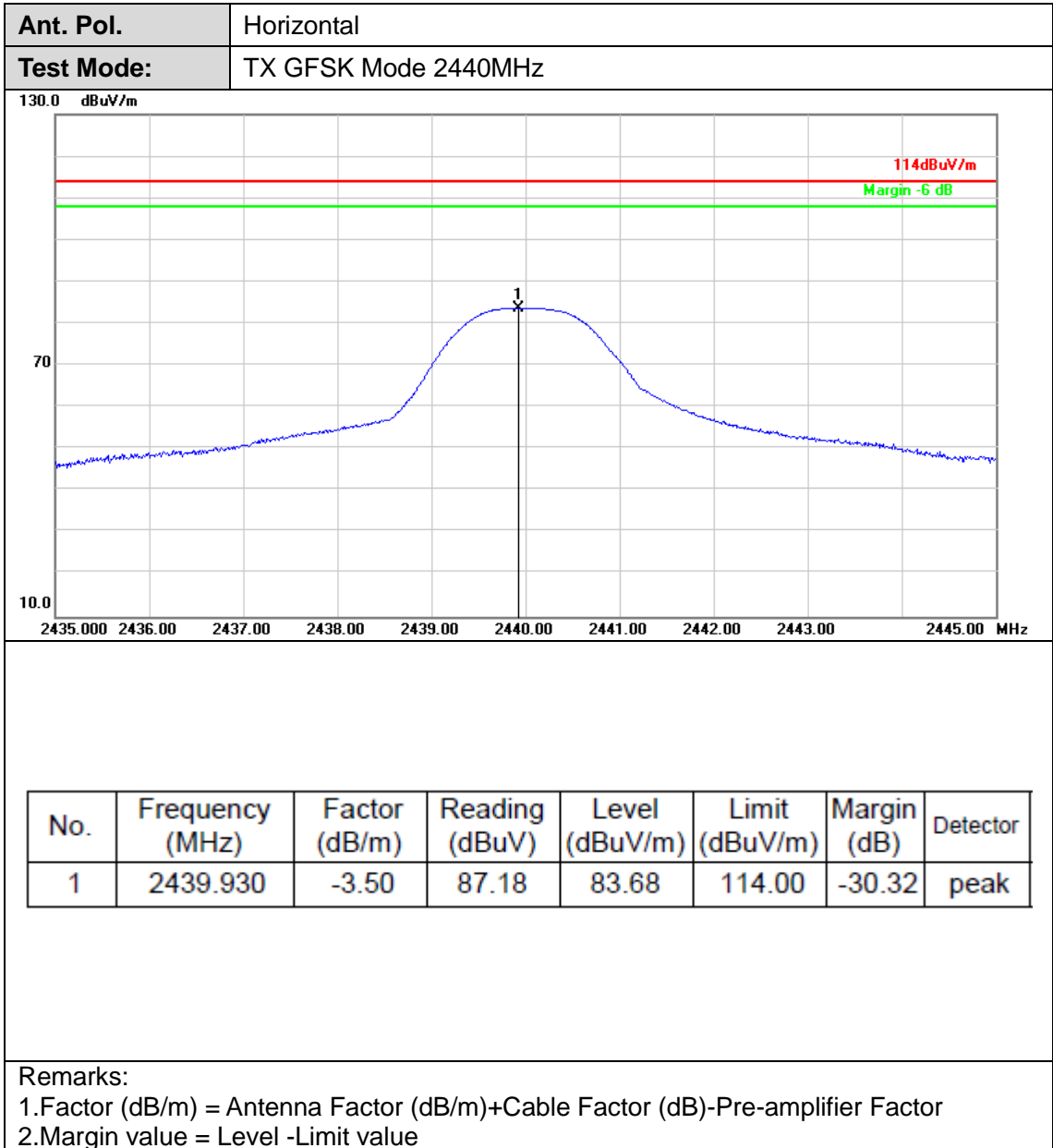



| | |
|-------------------|----------------------|
| Ant. Pol. | Vertical |
| Test Mode: | TX GFSK Mode 2440MHz |

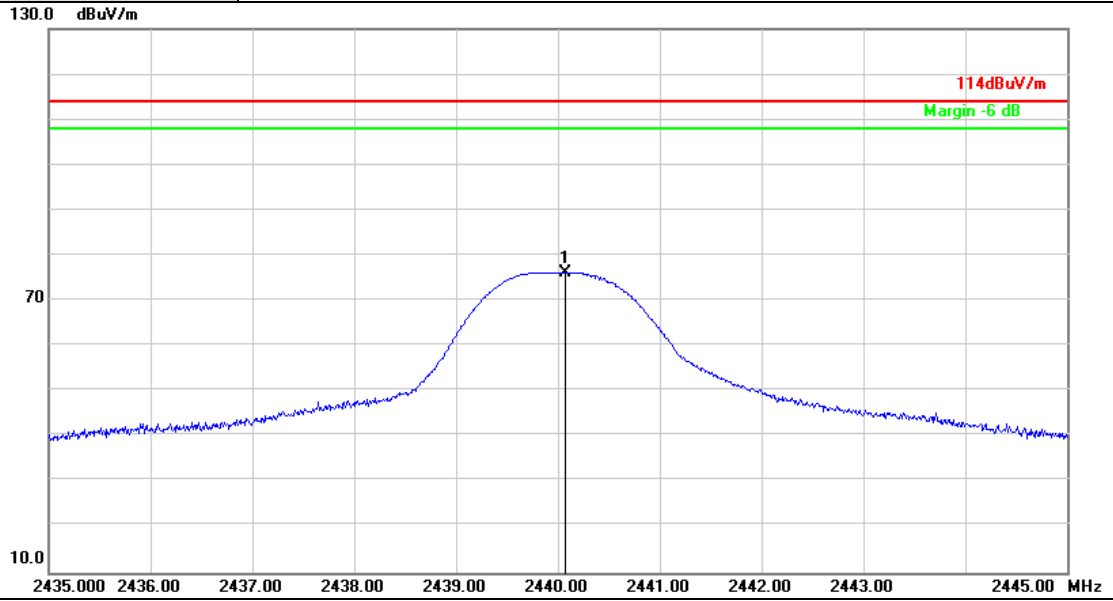

| No. | Frequency (MHz) | Factor (dB/m) | Reading (dBuV) | Level (dBuV/m) | Limit (dBuV/m) | Margin (dB) | Detector |
|-----|-----------------|---------------|----------------|----------------|----------------|-------------|----------|
| 1 | 2440.070 | -3.50 | 79.78 | 76.28 | 114.00 | -37.72 | peak |

Remarks:

- Factor (dB/m) = Antenna Factor (dB/m)+Cable Factor (dB)-Pre-amplifier Factor
- Margin value = Level -Limit value



| | |
|-------------------|----------------------|
| Ant. Pol. | Horizontal |
| Test Mode: | TX GFSK Mode 2480MHz |

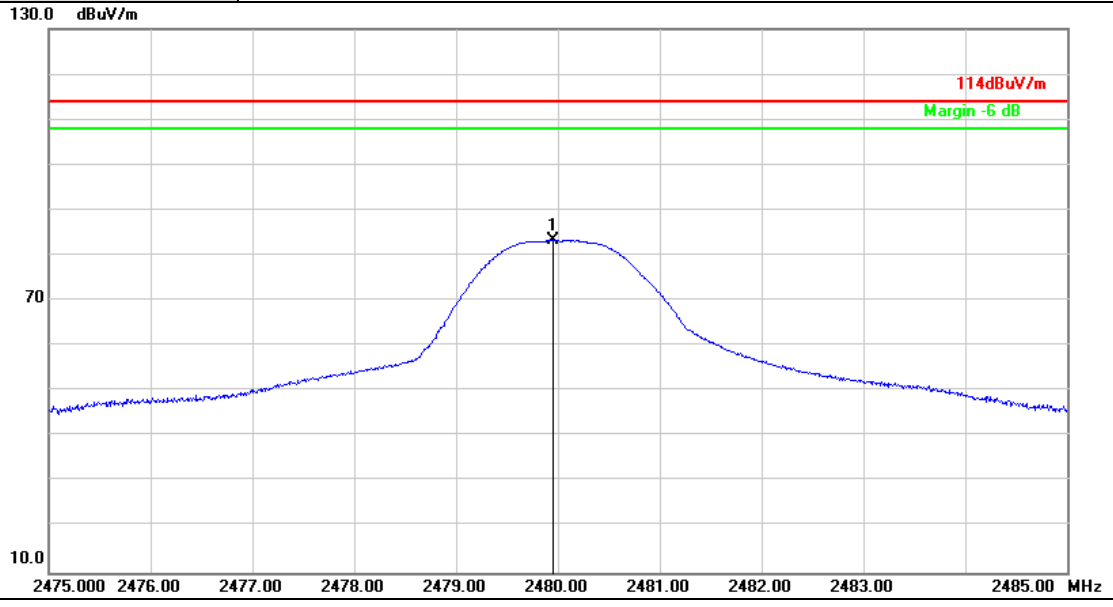

| No. | Frequency (MHz) | Factor (dB/m) | Reading (dBuV) | Level (dBuV/m) | Limit (dBuV/m) | Margin (dB) | Detector |
|-----|-----------------|---------------|----------------|----------------|----------------|-------------|----------|
| 1 | 2479.953 | -3.33 | 86.63 | 83.30 | 114.00 | -30.70 | peak |

Remarks:

- Factor (dB/m) = Antenna Factor (dB/m)+Cable Factor (dB)-Pre-amplifier Factor
- Margin value = Level -Limit value

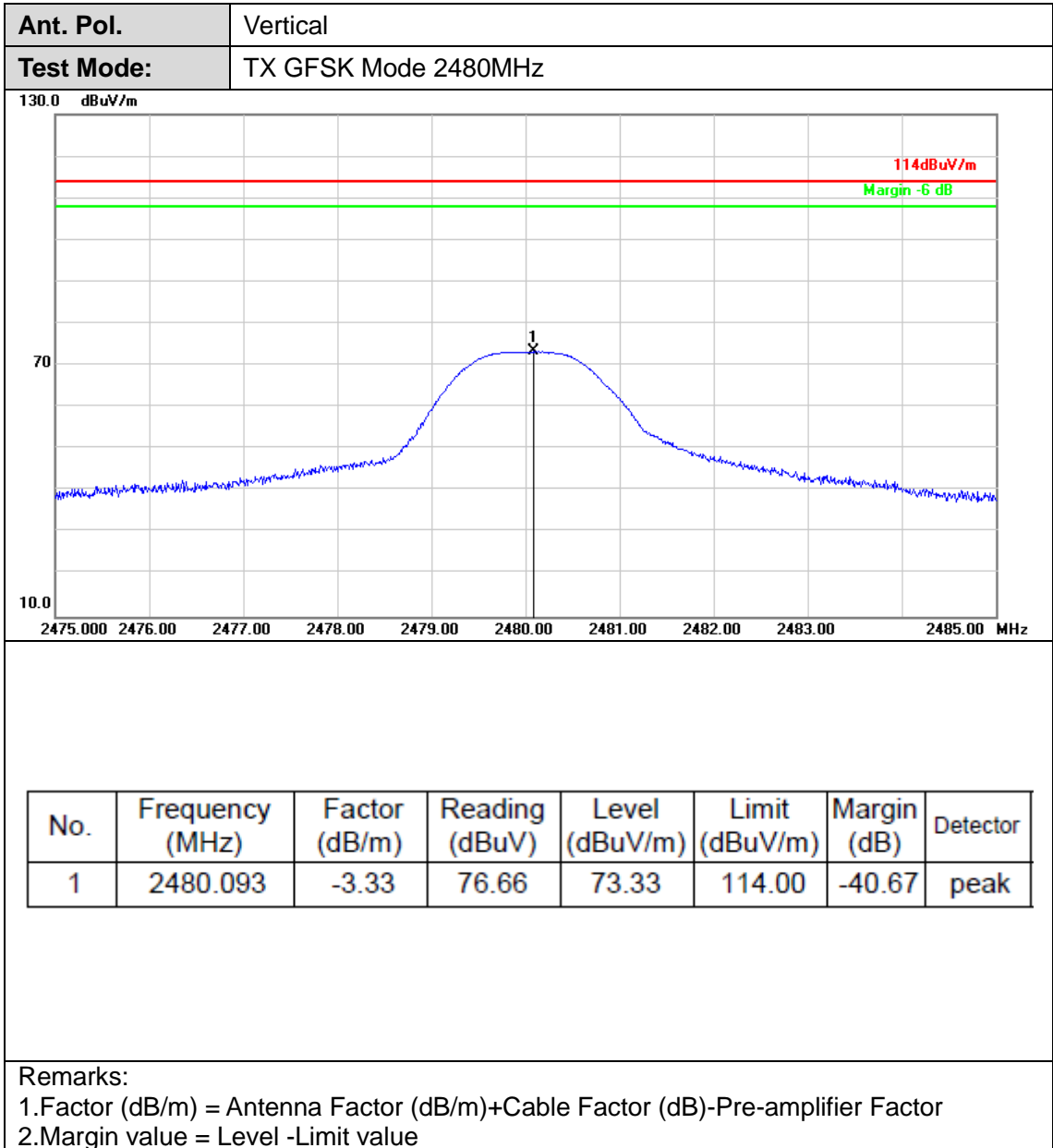



3.4. Radiated Spurious Emissions and Bandedge Emission

Limit

FCC CFR Title 47 Part 15 Subpart C Section 15.209&15.249(a)/ RSS – 210 F.1.e

| Frequency (MHz) | Field Strength (microvolts/meter) | Measurement Distance (meters) |
|-----------------|-----------------------------------|-------------------------------|
| 0.009~0.490 | 2400/F(KHz) | 300 |
| 0.490~1.705 | 24000/F(KHz) | 30 |
| 1.705~30.0 | 30 | 30 |
| 30~88 | 100 | 3 |
| 88~216 | 150 | 3 |
| 216~960 | 200 | 3 |
| 960~1000 | 500 | 3 |

| Frequency (MHz) | dB(uV/m) (at 3 meters) | |
|-----------------|------------------------|---------|
| | Peak | Average |
| Above 1000 | 74 | 54 |

Note:

- (1) The tighter limit applies at the band edges.
- (2) Emission Level (dBuV/m)=20log Emission Level (uV/m).

Test Configuration

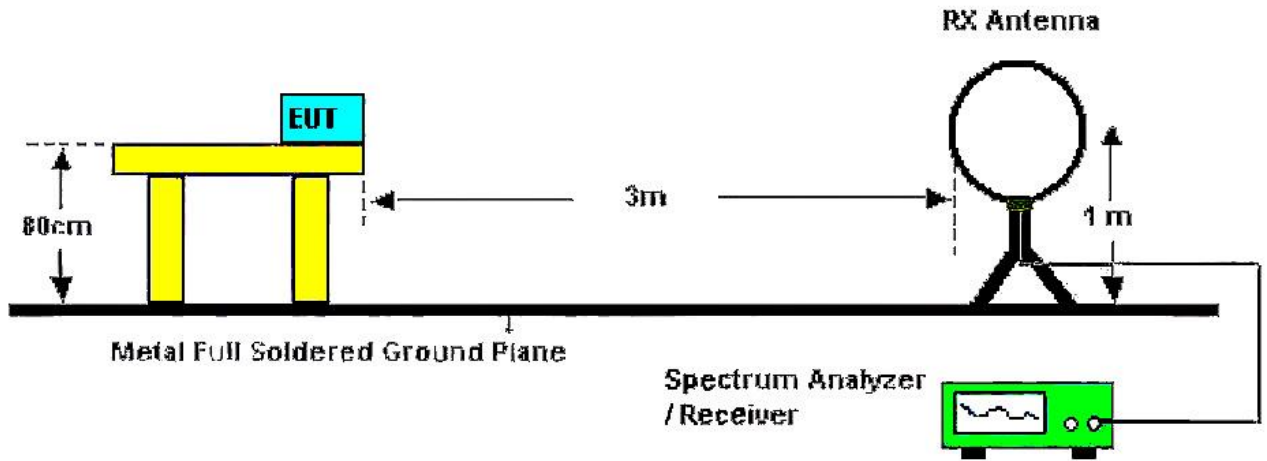

Below 30MHz Test Setup

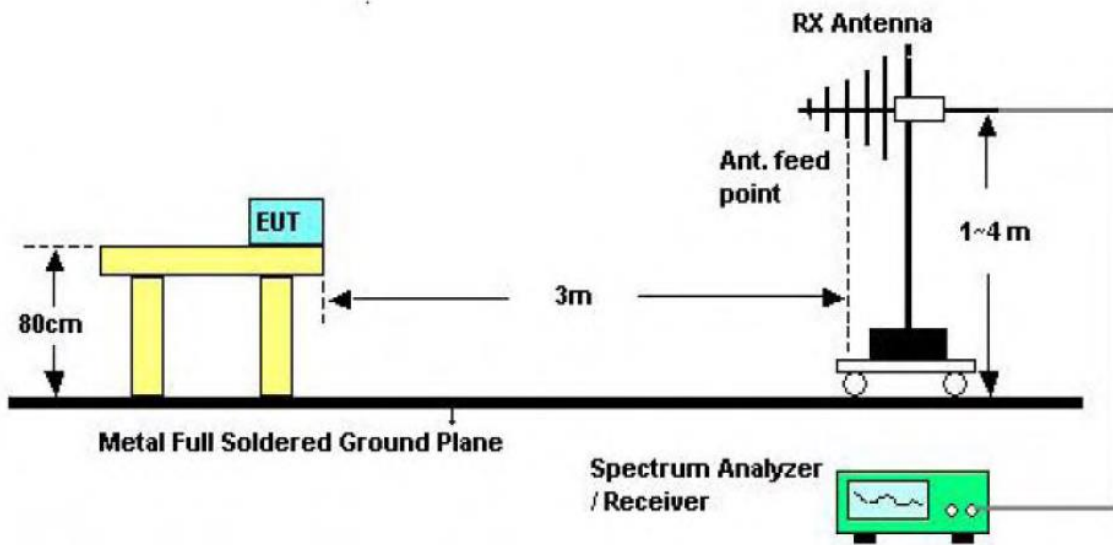

30-1000MHz Test Setup

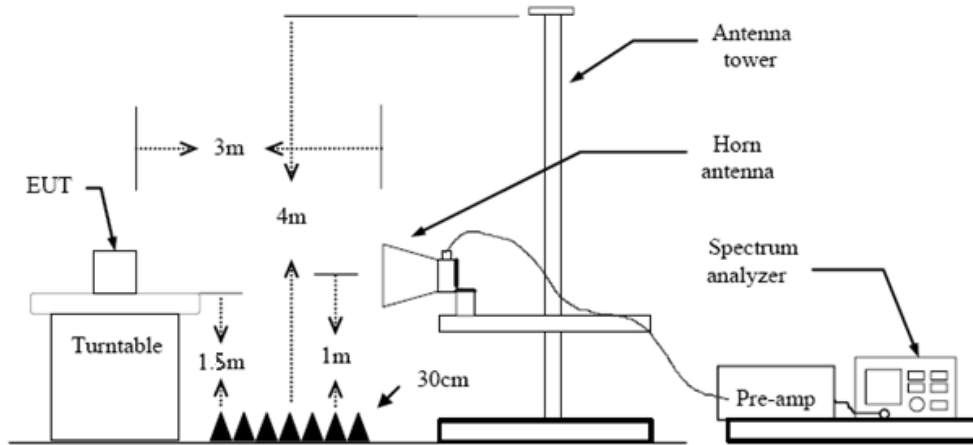

Above 1GHz Test Setup

Test Procedure

1. The EUT was setup and tested according to ANSI C63.10:2013
2. The EUT is placed on a turn table which is 0.8 meter above ground for below 1 GHz, and 1.5 m for above 1 GHz. The turn table is rotated 360 degrees to determine the position of the maximum emission level.
3. The EUT was set 3 meters from the receiving antenna, which was mounted on the top of a variable height antenna tower.
4. For each suspected emission, the EUT was arranged to its worst case and then tune the Antenna tower (from 1 m to 4 m) and turntable (from 0 degree to 360 degrees) to find the maximum reading. A pre-amp and a high pass filter are used for the test in order to get better signal level to comply with the guidelines.
5. Set to the maximum power setting and enable the EUT transmit continuously.
6. Use the following spectrum analyzer settings
 - (1) Span shall wide enough to fully capture the emission being measured;
 - (2) Below 1 GHz:
RBW=120 kHz, VBW=300 kHz, Sweep=auto, Detector function=peak, Trace=max hold;
If the emission level of the EUT measured by the peak detector is 3 dB lower than the applicable limit, the peak emission level will be reported. Otherwise, the emission measurement will be repeated using the quasi-peak detector and reported.
 - (3) From 1 GHz to 10th harmonic:
RBW=1MHz, VBW=3MHz Peak detector for Peak value.
RBW=1MHz, VBW=10Hz with Peak Detector for Average Value.

Test Mode

Please refer to the clause 2.4.

Test Result

9 KHz~30 MHz

From 9 KHz to 30 MHz: Conclusion: PASS

Note: The amplitude of spurious emissions which are attenuated by more than 20dB below the permissible value has no need to be reported.



30MHz-1GHz

| | |
|------------|-----------------------------|
| Ant. Pol. | Horizontal |
| Test Mode: | TX GFSK Mode 2402MHz |
| Remark: | Only worse case is reported |

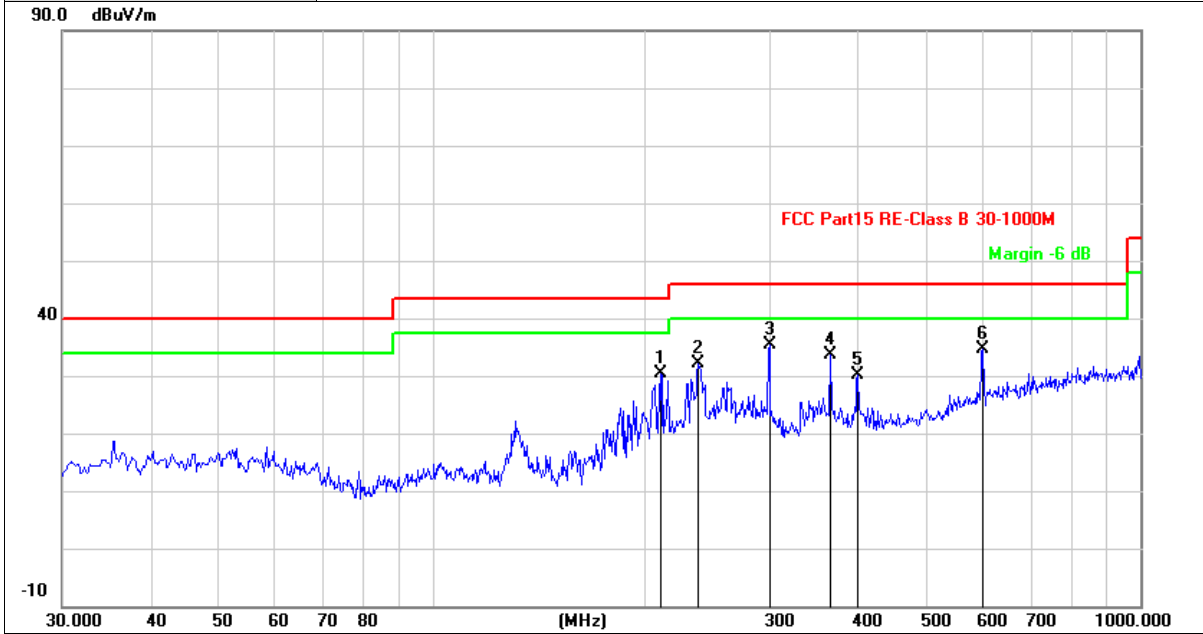

| No. | Frequency (MHz) | Factor (dB/m) | Reading (dBuV) | Level (dBuV/m) | Limit (dBuV/m) | Margin (dB) | Detector |
|-----|-----------------|---------------|----------------|----------------|----------------|-------------|----------|
| 1 | 210.7433 | -15.76 | 46.09 | 30.33 | 43.50 | -13.17 | QP |
| 2 | 237.5800 | -14.99 | 47.18 | 32.19 | 46.00 | -13.81 | QP |
| 3 | 299.9833 | -13.54 | 48.80 | 35.26 | 46.00 | -10.74 | QP |
| 4 | 365.2967 | -11.92 | 45.47 | 33.55 | 46.00 | -12.45 | QP |
| 5 | 399.8933 | -11.06 | 41.20 | 30.14 | 46.00 | -15.86 | QP |
| 6 | 600.6833 | -6.68 | 41.35 | 34.67 | 46.00 | -11.33 | QP |

Remarks:

- 1. Factor (dB/m) = Antenna Factor (dB/m)+Cable Factor (dB)-Pre-amplifier Factor
- 2. Margin value = Level -Limit value



| | |
|------------|-----------------------------|
| Ant. Pol. | Vertical |
| Test Mode: | TX GFSK Mode 2402MHz |
| Remark: | Only worse case is reported |

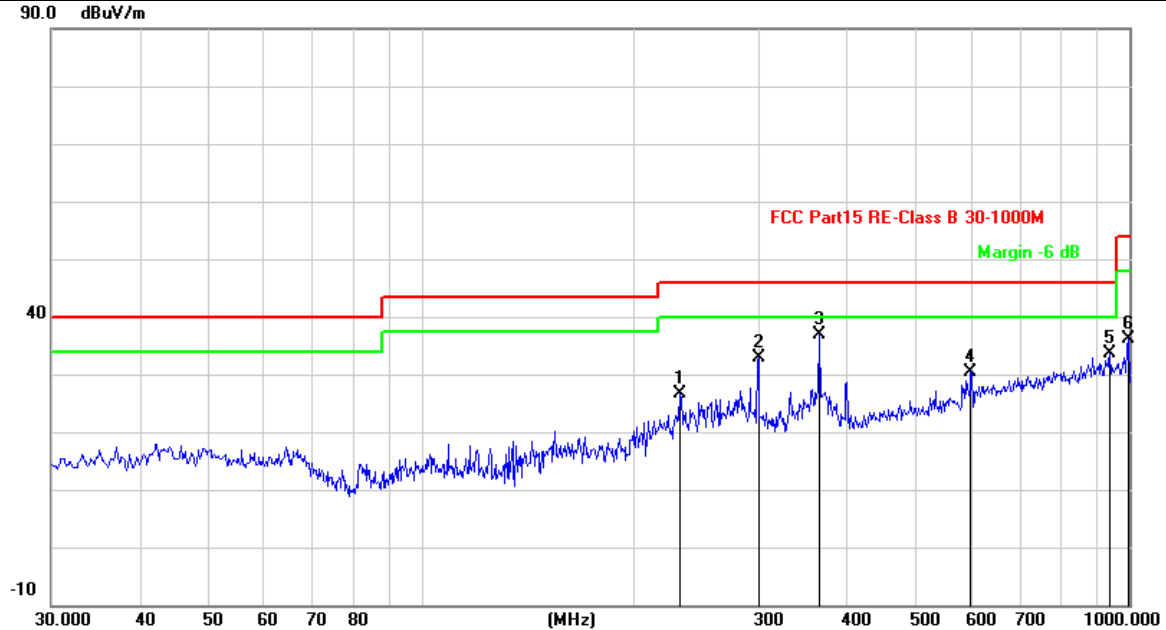

| No. | Frequency (MHz) | Factor (dB/m) | Reading (dBuV) | Level (dBuV/m) | Limit (dBuV/m) | Margin (dB) | Detector |
|-----|-----------------|---------------|----------------|----------------|----------------|-------------|----------|
| 1 | 232.4067 | -15.14 | 41.77 | 26.63 | 46.00 | -19.37 | QP |
| 2 | 299.9833 | -13.54 | 46.34 | 32.80 | 46.00 | -13.20 | QP |
| 3 | 365.2967 | -11.92 | 48.84 | 36.92 | 46.00 | -9.08 | QP |
| 4 | 598.0967 | -6.74 | 37.08 | 30.34 | 46.00 | -15.66 | QP |
| 5 | 941.4767 | -2.23 | 35.96 | 33.73 | 46.00 | -12.27 | QP |
| 6 | 998.3833 | -1.68 | 37.71 | 36.03 | 54.00 | -17.97 | QP |

Remarks:

- 1. Factor (dB/m) = Antenna Factor (dB/m)+Cable Factor (dB)-Pre-amplifier Factor
- 2. Margin value = Level -Limit value



Above 1GHz

| | |
|-------------------|------------------------------------------------------------------------------|
| Ant. Pol. | Horizontal |
| Test Mode: | TX GFSK Mode 2402MHz |
| Remark: | No report for the emission which more than 20 dB below the prescribed limit. |

| No. | Frequency (MHz) | Factor (dB/m) | Reading (dBuV) | Level (dBuV/m) | Limit (dBuV/m) | Margin (dB) | Detector |
|-----|-----------------|---------------|----------------|----------------|----------------|-------------|----------|
| 1 | 4803.921 | 2.16 | 40.82 | 42.98 | 74.00 | -31.02 | peak |
| 2 | 4804.033 | 2.16 | 29.87 | 32.03 | 54.00 | -21.97 | AVG |

Remarks:

- 1.Factor (dB/m) = Antenna Factor (dB/m)+Cable Factor (dB)-Pre-amplifier Factor
- 2.Margin value = Level -Limit value

| | |
|-------------------|------------------------------------------------------------------------------|
| Ant. Pol. | Vertical |
| Test Mode: | TX GFSK Mode 2402MHz |
| Remark: | No report for the emission which more than 20 dB below the prescribed limit. |

| No. | Frequency (MHz) | Factor (dB/m) | Reading (dBuV) | Level (dBuV/m) | Limit (dBuV/m) | Margin (dB) | Detector |
|-----|-----------------|---------------|----------------|----------------|----------------|-------------|----------|
| 1 | 4803.920 | 2.16 | 31.20 | 33.36 | 54.00 | -20.64 | AVG |
| 2 | 4804.355 | 2.16 | 43.12 | 45.28 | 74.00 | -28.72 | peak |

Remarks:

- 1.Factor (dB/m) = Antenna Factor (dB/m)+Cable Factor (dB)-Pre-amplifier Factor
- 2.Margin value = Level -Limit value



| | |
|-------------------|------------------------------------------------------------------------------|
| Ant. Pol. | Horizontal |
| Test Mode: | TX GFSK Mode 2440MHz |
| Remark: | No report for the emission which more than 20 dB below the prescribed limit. |

| No. | Frequency (MHz) | Factor (dB/m) | Reading (dBuV) | Level (dBuV/m) | Limit (dBuV/m) | Margin (dB) | Detector |
|-----|-----------------|---------------|----------------|----------------|----------------|-------------|----------|
| 1 | 4880.121 | 2.31 | 41.48 | 43.79 | 74.00 | -30.21 | peak |
| 2 | 4880.450 | 2.31 | 30.14 | 32.45 | 54.00 | -21.55 | AVG |

Remarks:

- 1.Factor (dB/m) = Antenna Factor (dB/m)+Cable Factor (dB)-Pre-amplifier Factor
- 2.Margin value = Level -Limit value

| | |
|-------------------|------------------------------------------------------------------------------|
| Ant. Pol. | Vertical |
| Test Mode: | TX GFSK Mode 2440MHz |
| Remark: | No report for the emission which more than 20 dB below the prescribed limit. |

| No. | Frequency (MHz) | Factor (dB/m) | Reading (dBuV) | Level (dBuV/m) | Limit (dBuV/m) | Margin (dB) | Detector |
|-----|-----------------|---------------|----------------|----------------|----------------|-------------|----------|
| 1 | 4880.008 | 2.31 | 30.69 | 33.00 | 54.00 | -21.00 | AVG |
| 2 | 4880.069 | 2.31 | 42.71 | 45.02 | 74.00 | -28.98 | peak |

Remarks:

- 1.Factor (dB/m) = Antenna Factor (dB/m)+Cable Factor (dB)-Pre-amplifier Factor
- 2.Margin value = Level -Limit value



| | |
|-------------------|------------------------------------------------------------------------------|
| Ant. Pol. | Horizontal |
| Test Mode: | TX GFSK Mode 2480MHz |
| Remark: | No report for the emission which more than 20 dB below the prescribed limit. |

| No. | Frequency (MHz) | Factor (dB/m) | Reading (dBuV) | Level (dBuV/m) | Limit (dBuV/m) | Margin (dB) | Detector |
|-----|-----------------|---------------|----------------|----------------|----------------|-------------|----------|
| 1 | 4959.959 | 2.48 | 29.89 | 32.37 | 54.00 | -21.63 | AVG |
| 2 | 4960.345 | 2.48 | 42.00 | 44.48 | 74.00 | -29.52 | peak |

Remarks:

- 1.Factor (dB/m) = Antenna Factor (dB/m)+Cable Factor (dB)-Pre-amplifier Factor
- 2.Margin value = Level -Limit value

| | |
|-------------------|------------------------------------------------------------------------------|
| Ant. Pol. | Vertical |
| Test Mode: | TX GFSK Mode 2480MHz |
| Remark: | No report for the emission which more than 20 dB below the prescribed limit. |

| No. | Frequency (MHz) | Factor (dB/m) | Reading (dBuV) | Level (dBuV/m) | Limit (dBuV/m) | Margin (dB) | Detector |
|-----|-----------------|---------------|----------------|----------------|----------------|-------------|----------|
| 1 | 4959.761 | 2.48 | 42.26 | 44.74 | 74.00 | -29.26 | peak |
| 2 | 4959.848 | 2.48 | 29.90 | 32.38 | 54.00 | -21.62 | AVG |

Remarks:

- 1.Factor (dB/m) = Antenna Factor (dB/m)+Cable Factor (dB)-Pre-amplifier Factor
- 2.Margin value = Level -Limit value

3.5. Band Edge Emissions (Radiated)

Limit

FCC CFR Title 47 Part 15 Subpart C Section 15.205&15.249(d)

| Restricted Frequency Band (MHz) | (dBuV/m)(at 3m) | |
|---------------------------------|-----------------|---------|
| | Peak | Average |
| 2310 ~ 2390 | 74 | 54 |
| 2483.5 ~ 2500 | 74 | 54 |

Conducted band edge limit: The highest point of the operating frequency waveform down 20dB

Test Configuration

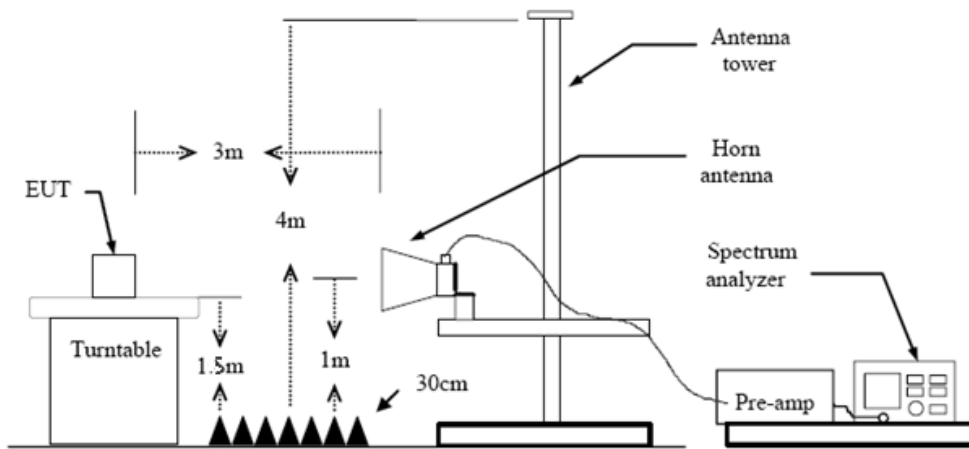

Test Procedure

1. The EUT was setup and tested according to ANSI C63.10:2013 requirements.
2. The EUT is placed on a turn table which is 1.5 meter above ground. The turn table is rotated 360 degrees to determine the position of the maximum emission level.
3. The EUT was positioned such that the distance from antenna to the EUT was 3 meters.
4. The antenna is scanned from 1 meter to 4 meters to find out the maximum emission level. This is repeated for both horizontal and vertical polarization of the antenna. In order to find the maximum emission, all of the interface cables were manipulated according to ANSI C63.10:2013 on radiated measurement.
5. The receiver set as follow:
 RBW=1MHz, VBW=3MHz Peak detector for Peak value.
 RBW=1MHz, VBW see note 1 with Peak Detector for Average Value.

Note 1: For measurements above 1 GHz the resolution bandwidth is set to 1 MHz, then the video bandwidth is set to 3 MHz for peak measurements and 1 MHz resolution bandwidth with 1/T video bandwidth with peak detector for average measurements.

Test Mode

Please refer to the clause 2.4.

Test Results



| | |
|------------|----------------------|
| Ant. Pol. | Horizontal |
| Test Mode: | TX GFSK Mode 2402MHz |

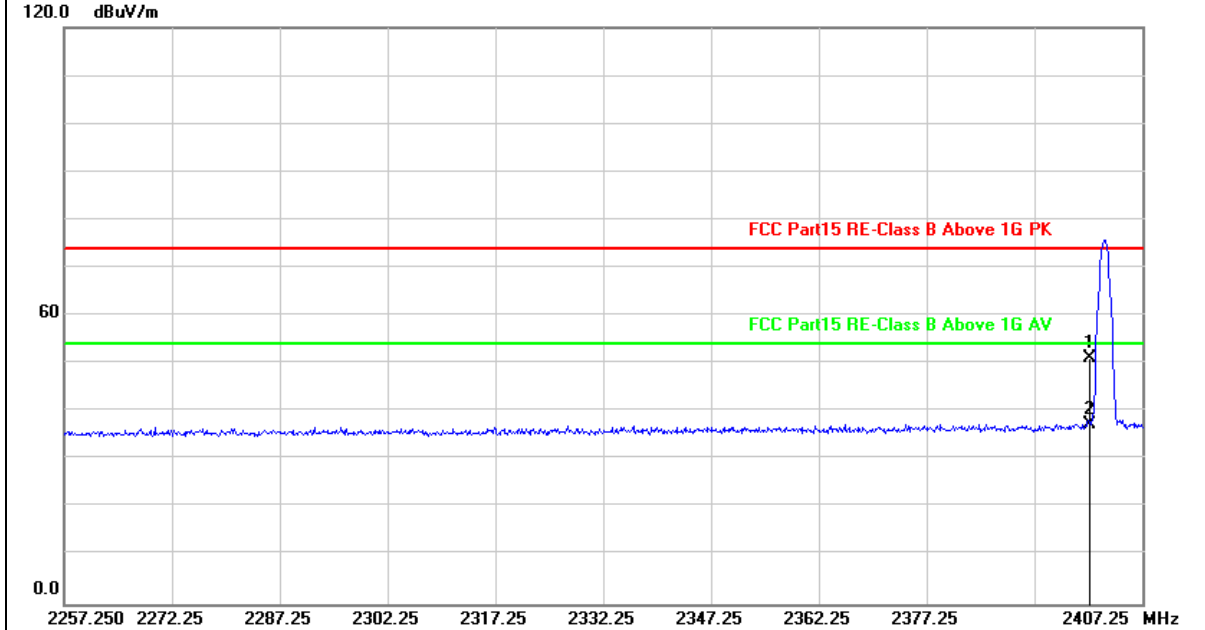

| No. | Frequency (MHz) | Factor (dB/m) | Reading (dBuV) | Level (dBuV/m) | Limit (dBuV/m) | Margin (dB) | Detector |
|-----|-----------------|---------------|----------------|----------------|----------------|-------------|----------|
| 1 | 2400.000 | 30.88 | 20.21 | 51.09 | 74.00 | -22.91 | peak |
| 2 | 2400.000 | 30.88 | 6.44 | 37.32 | 54.00 | -16.68 | AVG |

Remarks:

- 1. Factor (dB/m) = Antenna Factor (dB/m) + Cable Factor (dB) - Pre-amplifier Factor
- 2. Margin value = Level - Limit value



| | |
|-------------------|----------------------|
| Ant. Pol. | Vertical |
| Test Mode: | TX GFSK Mode 2402MHz |

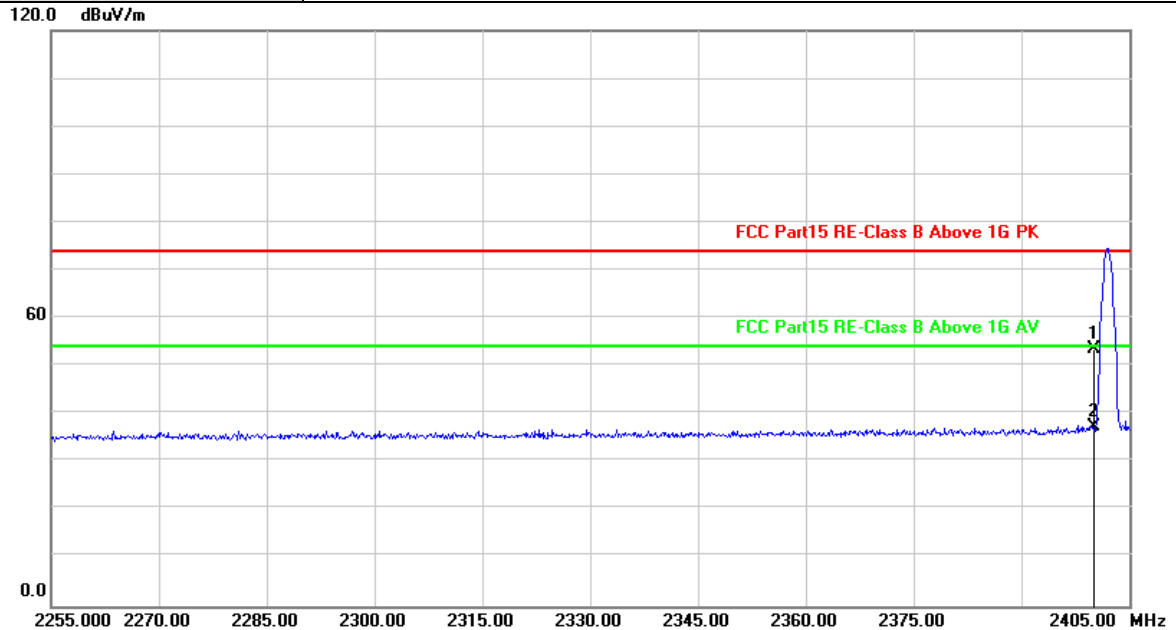

| No. | Frequency (MHz) | Factor (dB/m) | Reading (dBuV) | Level (dBuV/m) | Limit (dBuV/m) | Margin (dB) | Detector |
|-----|-----------------|---------------|----------------|----------------|----------------|-------------|----------|
| 1 | 2400.000 | 30.88 | 22.78 | 53.66 | 74.00 | -20.34 | peak |
| 2 | 2400.000 | 30.88 | 6.48 | 37.36 | 54.00 | -16.64 | AVG |

Remarks:

- 1. Factor (dB/m) = Antenna Factor (dB/m)+Cable Factor (dB)-Pre-amplifier Factor
- 2. Margin value = Level -Limit value



| | |
|-------------------|----------------------|
| Ant. Pol. | Horizontal |
| Test Mode: | TX GFSK Mode 2480MHz |

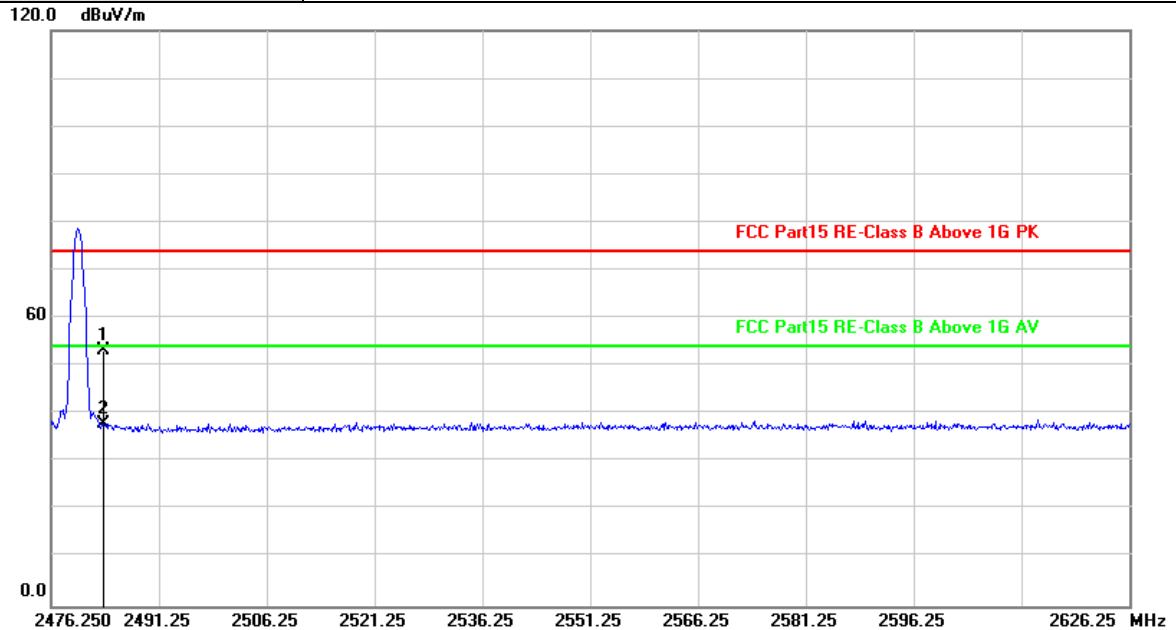

| No. | Frequency (MHz) | Factor (dB/m) | Reading (dBuV) | Level (dBuV/m) | Limit (dBuV/m) | Margin (dB) | Detector |
|-----|-----------------|---------------|----------------|----------------|----------------|-------------|----------|
| 1 | 2483.500 | 31.24 | 22.10 | 53.34 | 74.00 | -20.66 | peak |
| 2 | 2483.500 | 31.24 | 6.74 | 37.98 | 54.00 | -16.02 | AVG |

Remarks:

- 1. Factor (dB/m) = Antenna Factor (dB/m)+Cable Factor (dB)-Pre-amplifier Factor
- 2. Margin value = Level -Limit value



| | |
|-------------------|----------------------|
| Ant. Pol. | Vertical |
| Test Mode: | TX GFSK Mode 2480MHz |

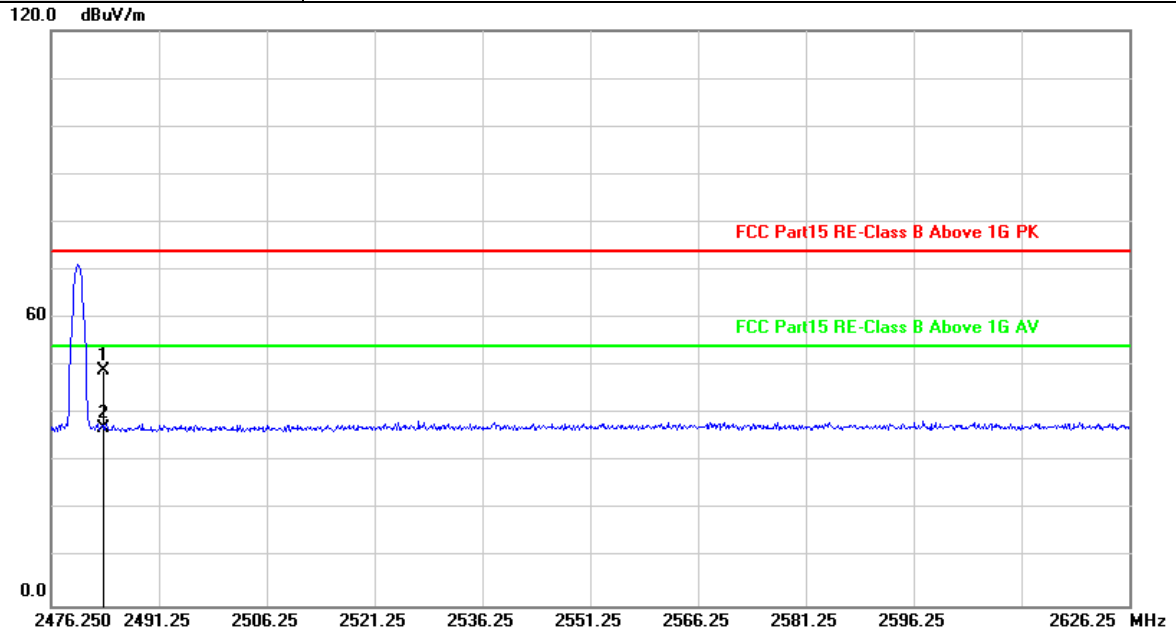

| No. | Frequency (MHz) | Factor (dB/m) | Reading (dBuV) | Level (dBuV/m) | Limit (dBuV/m) | Margin (dB) | Detector |
|-----|-----------------|---------------|----------------|----------------|----------------|-------------|----------|
| 1 | 2483.500 | 31.24 | 17.89 | 49.13 | 74.00 | -24.87 | peak |
| 2 | 2483.500 | 31.24 | 5.90 | 37.14 | 54.00 | -16.86 | AVG |

Remarks:

- 1. Factor (dB/m) = Antenna Factor (dB/m)+Cable Factor (dB)-Pre-amplifier Factor
- 2. Margin value = Level -Limit value



3.6. Antenna Requirement

Requirement

FCC CFR Title 47 Part 15 Subpart C Section 15.203:

An intentional radiator shall be designed to ensure that no antenna other than that furnished by the responsible party shall be used with the device. The use of a permanently attached antenna or of antenna that uses a unique coupling to the intentional radiator, the manufacturer may design the unit so that a broken antenna can be replaced by the user, but the use of a standard antenna jack or electrical connector is prohibited.

FCC CFR Title 47 Part 15 Subpart C Section 15.247(c) (1)(i):

(i) Systems operating in the 2400~2483.5 MHz band that is used exclusively for fixed. Point-to-point operations may employ transmitting antennas with directional gain greater than 6dBi provided the maximum conducted output power of the intentional radiator is reduced by 1 dB for every 3 dB that the directional gain of the antenna exceeds 6dBi.

Test Result

The directional gain of the antenna less than 6dBi, please refer to the EUT internal photographs antenna photo.

*****THE END*****