



FCC/IC - TEST REPORT

Report Number : 68.950.18.0570.01 Date of Issue: November 28, 2018

Model : G1023E, G1018E, M610

Product Type : Wireless Mouse

Applicant : Shenzhen Loyal Electronics Co., Ltd

Address : No.5 The First Industrial Area of Shanmen,
Songgang, Baoan, Shenzhen,China

Manufacturer : Shenzhen Loyal Electronics Co., Ltd

Address : No.5 The First Industrial Area of Shanmen,
Songgang, Baoan, Shenzhen,China

Test Result : Positive Negative

Total pages including Appendices : 37

TÜV SÜD CERTIFICATION AND TESTING (CHINA) CO., LTD. SHENZHEN BRANCH is a subcontractor to TÜV SÜD Product Service GmbH according to the principles outlined in ISO 17025. TÜV SÜD CERTIFICATION AND TESTING (CHINA) CO., LTD. SHENZHEN BRANCH reports apply only to the specific samples tested under stated test conditions. Construction of the actual test samples has been documented. It is the manufacturer's responsibility to assure that additional production units of this model are manufactured with identical electrical and mechanical components. The manufacturer/importer is responsible to the Competent Authorities in Europe for any modifications made to the production units which result in non-compliance to the relevant regulations TÜV SÜD CERTIFICATION AND TESTING (CHINA) CO., LTD. SHENZHEN BRANCH shall have no liability for any deductions, inferences or generalizations drawn by the client or others from TÜV SÜD CERTIFICATION AND TESTING (CHINA) CO., LTD. SHENZHEN BRANCH issued reports. This report is the confidential property of the client. As a mutual protection to our clients, the public and ourselves, extracts from the test report shall not be reproduced except in full without our written approval.



1 Table of Contents

1	Table of Contents	2
2	Details about the Test Laboratory	3
3	Description of the Equipment Under Test	4
4	Summary of Test Standards	5
5	Summary of Test Results.....	6
6	General Remarks	7
7	Test Setups	8
8	Systems test configuration.....	9
9	Technical Requirement	10
9.1	Conducted peak output power.....	10
9.2	20 dB bandwidth and 99% Occupied Bandwidth.....	13
9.3	Carrier Frequency Separation	17
9.4	Number of hopping frequencies.....	19
9.5	Dwell Time	21
9.6	Spurious RF conducted emissions	23
9.7	Band edge testing	29
9.8	Spurious radiated emissions for transmitter	32
10	Test Equipment List.....	36
11	System Measurement Uncertainty	37



2 Details about the Test Laboratory

Details about the Test Laboratory

Test Site 1

Company name: TÜV SÜD Certification and Testing (China) Co., Ltd. Shenzhen Branch
Building 12 & 13, Zhiheng Wisdomland Business Park, Nantou Checkpoint
Road 2, Nanshan District
Shenzhen 518052
P.R. China

Telephone: 86 755 8828 6998

Fax: 86 755 828 5299

FCC Registration 514049

No.:

IC Registration 10320A -1

No.:

3 Description of the Equipment Under Test

Product:	Wireless Mouse
Model no.:	G1023E, G1018E, M610
FCC ID:	2AAVD-G1018E
IC:	23918-G1018E
Options and accessories:	N/A
Rating:	1.5VDC, 100mA, powered by ONE AA size non-rechargeable battery
RF Transmission Frequency:	2408MHz-2474MHz
No. of Operated Channel:	34
Modulation:	FSK,
Antenna Type:	Integrated antenna
Antenna Gain:	-0.61dBi
Description of the EUT:	The Equipment Under Test (EUT) is a Wireless Mouse operated at 2.4GHz



4 Summary of Test Standards

Test Standards	
FCC Part 15 Subpart C 10-1-2017 Edition	PART 15 - RADIO FREQUENCY DEVICES Subpart C - Intentional Radiators
RSS-Gen Issue 5 April 2018	General Requirements for the Certification of Radio Apparatus
RSS-247 Issue 2 February 2017	Digital Transmission Systems (DTSS), Frequency Hopping Systems (FHSS) and License-Exempt Local Area Network (LE-LAN) Devices

All the test methods were according to KDB558074 D01 15.247 Meas Guidance v05 and ANSI C63.10 (2013).

5 Summary of Test Results

Technical Requirements					
FCC Part 15 Subpart C/RSS-247 Issue 2/RSS-Gen Issue 5					
Test Condition			Pages	Test Result	Test Site
§15.207	RSS-GEN 8.8	Conducted emission AC power port	--	N/A	--
§15.247(b)(1)	RSS-247 Clause 5.4(d)	Conducted peak output power	10	Pass	Site 1
§15.247(e)	RSS-247 Clause 5.2(b)	Power spectral density*	--	N/A	--
§15.247(a)(2)	RSS-247 Clause 5.2(a)	6dB bandwidth	--	N/A	--
§15.247(a)(1)	RSS-247 Clause 5.1(a) & RSS-Gen 6.7	20dB bandwidth and 99% Occupied Bandwidth	13	Pass	Site 1
§15.247(a)(1)	RSS-247 Clause 5.1(b)	Carrier frequency separation	17	Pass	Site 1
§15.247(a)(1)(iii)	RSS-247 Clause 5.1(d)	Number of hopping frequencies	19	Pass	Site 1
§15.247(a)(1)(iii)	RSS-247 Clause 5.1(d)	Dwell Time	21	Pass	Site 1
§15.247(d)	RSS-247 Clause 5.5	Spurious RF conducted emissions	23	Pass	Site 1
§15.247(d)	RSS-247 Clause 5.5	Band edge	29	Pass	Site 1
§15.247(d) & §15.209 &	RSS-247 Clause 5.5 & RSS-GEN 6.13	Spurious radiated emissions for transmitter and receiver	32	Pass	Site 1
§15.203	RSS-GEN 6.8	Antenna requirement	See note 2	Pass	--

Note 1: N/A=Not Applicable.

Note 2: The EUT uses an Integrated antenna, which gain is -0.61dBi. In accordance to §15.203, it is considered sufficiently to comply with the provisions of this section.



6 General Remarks

Remarks

This submittal(s) (test report) is intended for FCC ID: 2AAVD-G1018E, IC: 23918-G1018E complies with Section 15.209, 15.247 of the FCC Part 15, Subpart C, RSS-247 Issue 2 February 2017 and RSS-Gen Issue 5 April 2018 rules.

G1023E, G1018E, M610 is a Wireless Mouse with 2.4GHz Radio. The TX and RX range is 2408MHz-2474MHz.

Note: The report is for FSK only.

SUMMARY:

All tests according to the regulations cited on page 5 were

■ - Performed

□ - **Not** Performed

The Equipment Under Test

■ - **Fulfills** the general approval requirements.

□ - **Does not** fulfill the general approval requirements.

Sample Received Date: September 10, 2018

Testing Start Date: September 10, 2018

Testing End Date: November 27, 2018

Reviewed by:

Phoebe Hu
EMC Section Manager



Prepared by:

Vincent Zheng
EMC Project Engineer

Tested by:

Tree Zhan
EMC Test Engineer

7 Test Setups

7.1 Radiated test setups

Below 1GHz

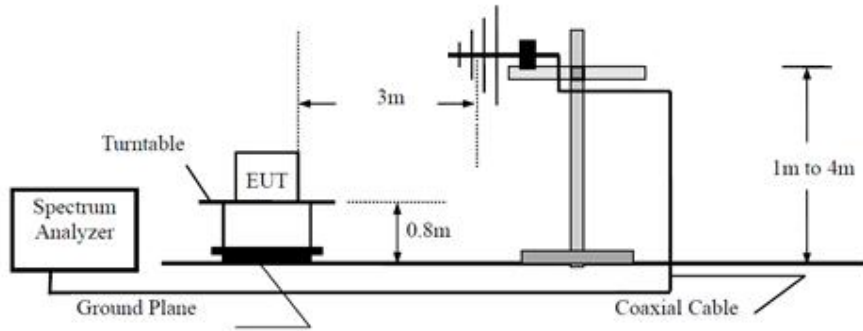

Above 1GHz

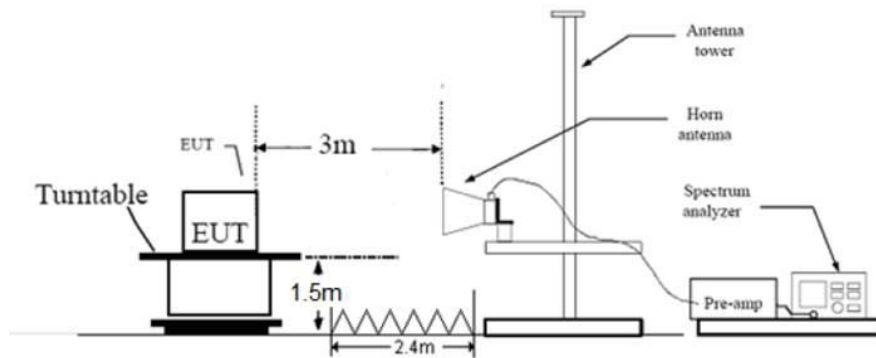

7.2 Conducted RF test setups

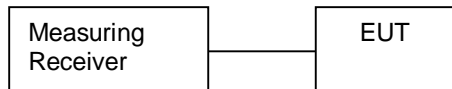



8 Systems test configuration

Auxiliary Equipment Used during Test:

DESCRIPTION	MANUFACTURER	MODEL NO.	S/N
--	--	--	

Test software: N/A

The system was configured to hopping mode and non-hopping mode.

Hopping mode: typical working mode (normal hopping status)

Non-hopping mode: The system was configured to operate at a signal channel transmitting. The test software allows the configuration and operation at the worst-case duty and the highest transmit power.



9 Technical Requirement

9.1 Conducted peak output power

Test Method

1. Use the following spectrum analyzer settings:
 Span = approximately 5 times the 20dB bandwidth, centered on a hopping channel
 RBW > the 20dB bandwidth of the emission being measured, VBW ≥ RBW,
 Sweep = auto, Detector function = peak, Trace = max hold
2. Add a correction factor to the display.
3. Allow the trace to stabilize. Use the marker-to-peak function to set the marker to the peak of the emission. The indicated level is the peak output power

Limits

Frequency Range MHz	Limit W	FCC Limit dBm	IC Limit dBm
2400-2483.5	≤1	≤30/1W	≤21/0.125W

For e.i.r.p

Frequency Range MHz	Limit W	Limit dBm
2400-2483.5	≤4W	≤36



Conducted peak output power

FSK modulation Test Result

Frequency MHz	Conducted Peak Output Power dBm	E.I.R.P dBm	Result
Low channel 2408MHz	-11.53	-12.14	Pass
Middle channel 2440MHz	-12.11	-12.72	Pass
High channel 2474MHz	-12.74	-13.35	Pass

Low channel 2408MHz

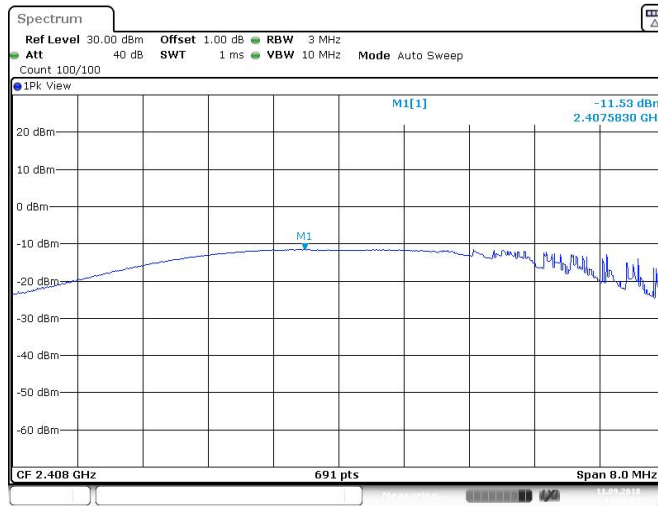

Date: 11 SEP 2018 14:00:53



Middle channel 2440MHz

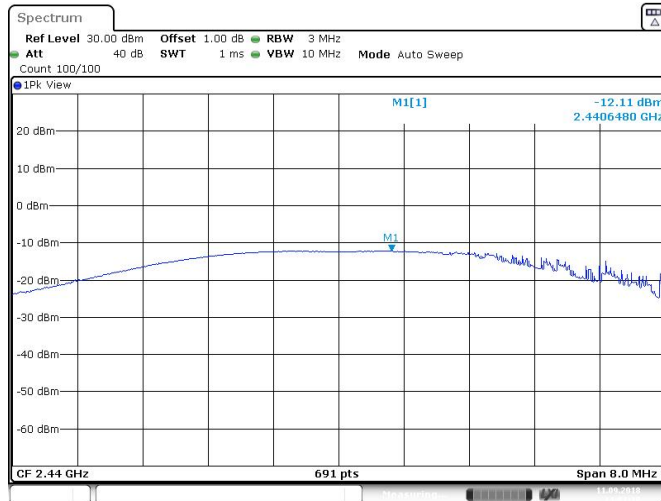

Date: 11 SEP 2018 14:01:10

High channel 2474MHz

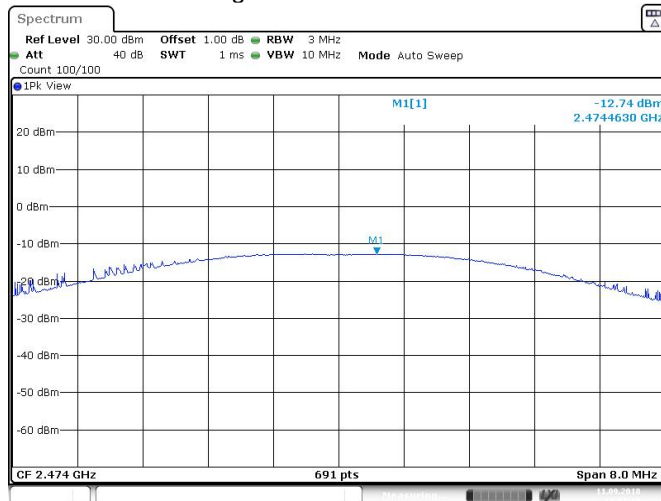

Date: 11 SEP 2018 14:01:28



9.2 20 dB bandwidth and 99% Occupied Bandwidth

Test Method

1. Check the calibration of the measuring instrument using either an internal calibrator or a known signal from an external generator.
2. Position the EUT without connection to measurement instrument. Turn on the EUT and connect it to measurement instrument. Then set it to any one convenient frequency within its operating range. Set a reference level on the measuring instrument equal to the highest peak value.
3. Measure the frequency difference of two frequencies that were attenuated 20 dB from the reference level. Record the frequency difference as the emission bandwidth.
4. Repeat above procedures until all frequencies measured were complete.

Limit

Limit [kHz]

N/A

20 dB bandwidth and 99% Occupied Bandwidth

Bluetooth Mode FSK Modulation test result

Frequency MHz	20 dB Bandwidth MHz	99% Bandwidth MHz	Limit kHz	Result
2408	2.660	2.263	--	Pass
2440	2.595	2.248	--	Pass
2474	2.555	2.263	--	Pass

Low channel 2408MHz

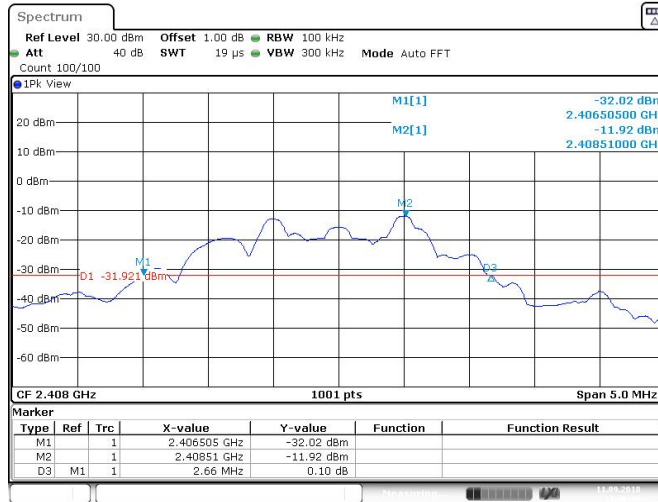

Date: 11 SEP 2018 13:48:37

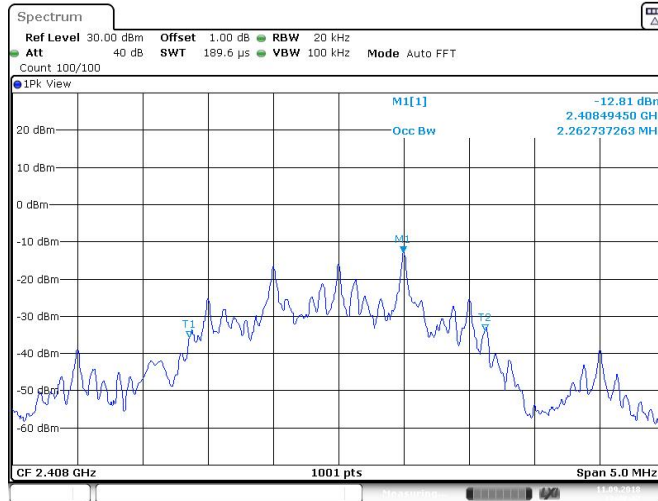

Date: 11 SEP 2018 13:48:48



Middle channel 2440MHz

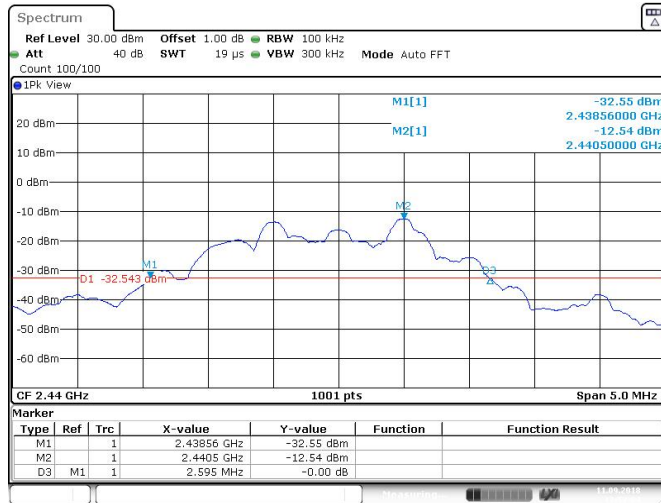

Date: 11 SEP 2018 13:52:04

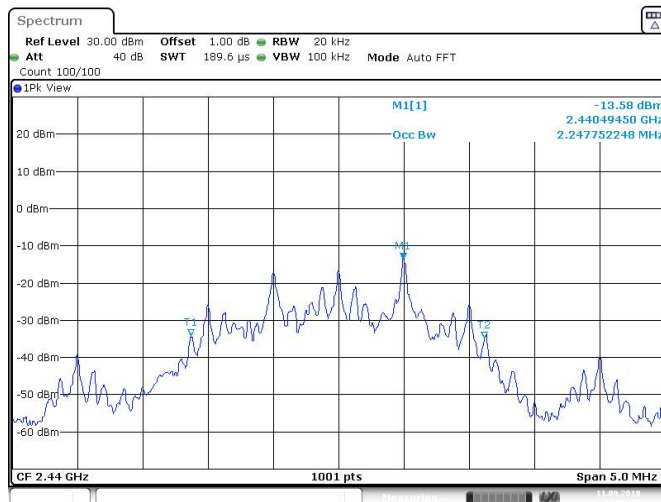

Date: 11 SEP 2018 13:52:15



High channel 2474MHz

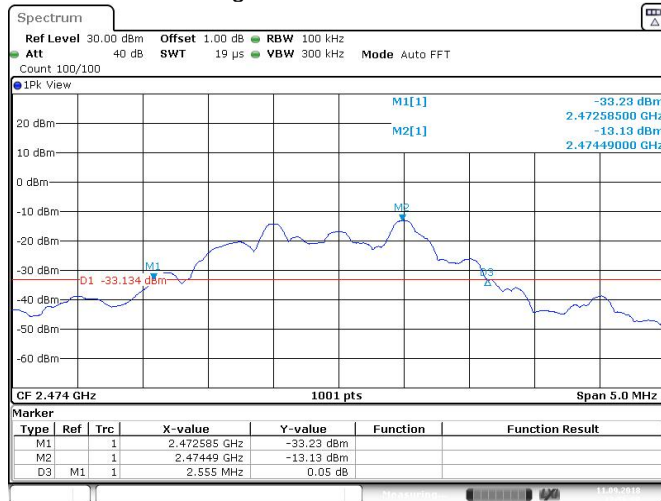

Date: 11 SEP 2018 13:56:01

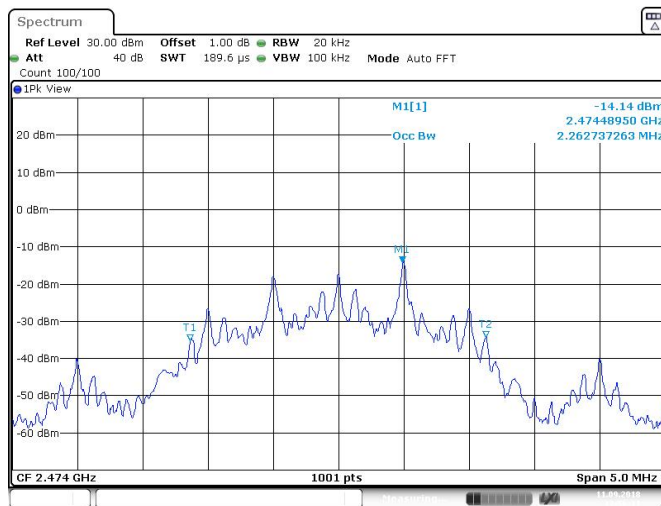

Date: 11 SEP 2018 13:56:42



9.3 Carrier Frequency Separation

Test Method

1. Use the following spectrum analyzer settings:
Span = wide enough to capture the peaks of two adjacent channels, RBW \geq 1% of the span, VBW) \geq RBW, Sweep = auto, Detector function = peak
2. By using the Max-Hold function record the separation of two adjacent channels.
3. Measure the frequency difference of these two adjacent channels by spectrum analyzer marker function.
4. Repeat above procedures until all frequencies measured were complete.

Limit

Limit
kHz

≥25KHz or 2/3 of the 20 dB bandwidth which is greater

FSK Modulation Limit

Frequency MHz	2/3 of 20 dB Bandwidth kHz
2408	628.07
2440	633.87
2474	631.00



Carrier Frequency Separation

Test result: The measurement was performed with the typical configuration (normal hopping status), here FSK modulation mode was used to show compliance.

FSK Modulation test result

Frequency MHz	Carrier Frequency Separation kHz	Result
2408	--	Pass
2440	1991	Pass
2474	--	Pass

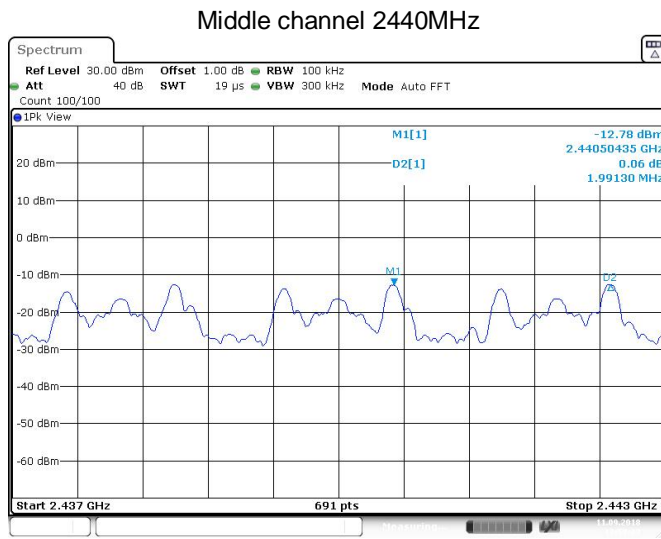

Date: 11 SEP 2018 13:59:23



9.4 Number of hopping frequencies

Test Method

1. Use the following spectrum analyzer settings:
Span = wide enough to capture the peaks of two adjacent channels, $RBW \geq 1\%$ of the span, $VBW \geq RBW$, Sweep = auto, Detector function = peak
2. Set the spectrum analyzer on Max-Hold Mode, and then keep the EUT in hopping mode.
3. Record all the signals from each channel until each one has been recorded.
4. Repeat above procedures until all frequencies measured were complete.

Limit

**Limit
number**

≥ 15



Number of hopping frequencies

Test result: The measurement was performed with the typical configuration (normal hopping status), and the total hopping channels is constant for the all modulation mode according with the Bluetooth Core Specification. Here FSK modulation mode was used to show compliance.

Number of hopping frequencies	Result
34	Pass

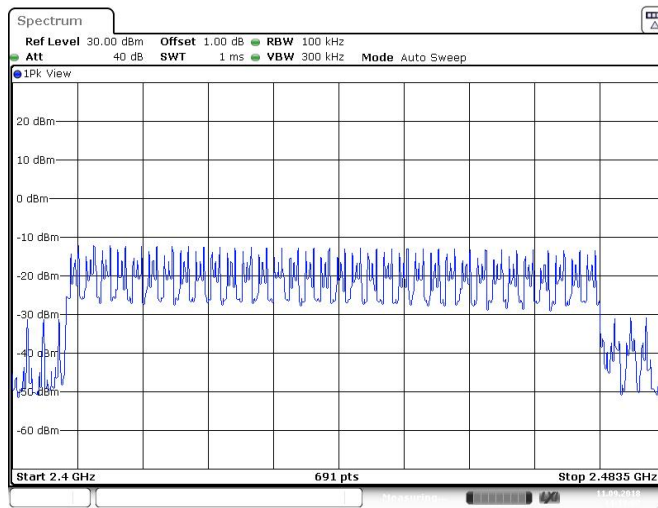

Date: 11 SEP 2018 14:19:03

9.5 Dwell Time

Test Method

1. Connect EUT antenna terminal to the spectrum analyzer with a low loss cable.
Equipment mode: Spectrum analyzer
2. RBW: 1MHz; VBW: 1MHz; SPAN: Zero Span
3. Adjust the center frequency of spectrum analyzer on any frequency be measured.
4. Measure the Dwell Time by spectrum analyzer Marker function.
5. Repeat above procedures until all frequencies measured were complete.

Limit

The average time of occupancy on any frequency shall not be greater than 0.4 seconds within a period of 0.4 seconds multiplied by the number of hopping channels employed.

Dwell Time

Dwell time

The maximum dwell time shall be 0.4 s.

The Dwell Time = Burst Width * Total Hops. The detailed calculations are showed as follows:

The duration for dwell time calculation: 0.4 [s] * hopping number = 0.4 [s] * 34 [ch] = 13.6 [s*ch];

The burst width, which is directly measured, refers to the duration on one channel hop.

The maximum number of hopping channels in 13.6s for FSK=1600 / 6 / 34 * 13.6=106.67

Test Result

Modulation	Mode	Reading (ms)	Total Hops	Test Result (ms)	Limit (ms)	Result
FSK	--	7.87	39	306.93	< 400	Pass

FSK Modulation

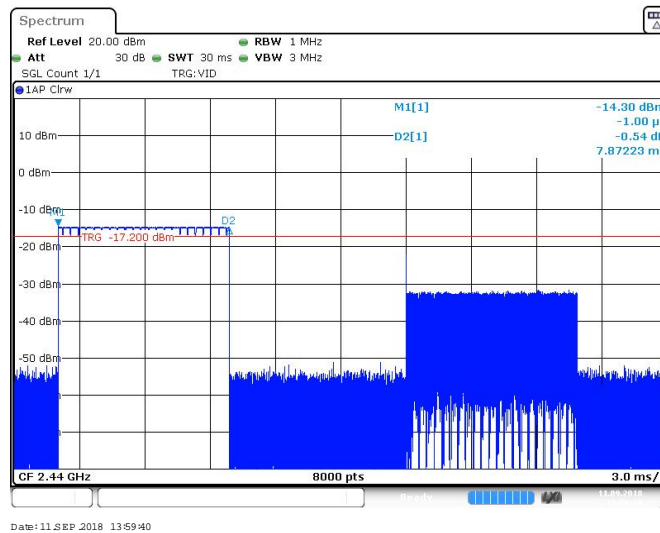



9.6 Spurious RF conducted emissions

Test Method

1. Use the following spectrum analyzer settings:
Span = wide enough to capture the peak level of the in-band emission and all spurious emissions (e.g., harmonics) from the lowest frequency generated in the EUT up through the 10th harmonic. Typically, several plots are required to cover this entire span.
RBW = 100 kHz, VBW ≥ RBW, Sweep = auto, Detector function = peak, Trace = max hold
2. Allow the trace to stabilize. Set the marker on the peak of any spurious emission recorded.
3. The level displayed must comply with the limit specified in this Section. Submit these plots.
4. Repeat above procedures until all frequencies measured were complete.

Limit

Frequency Range MHz	Limit (dBc)
30-25000	-20

Spurious RF conducted emissions

FSK Modulation:

Low channel 2408MHz

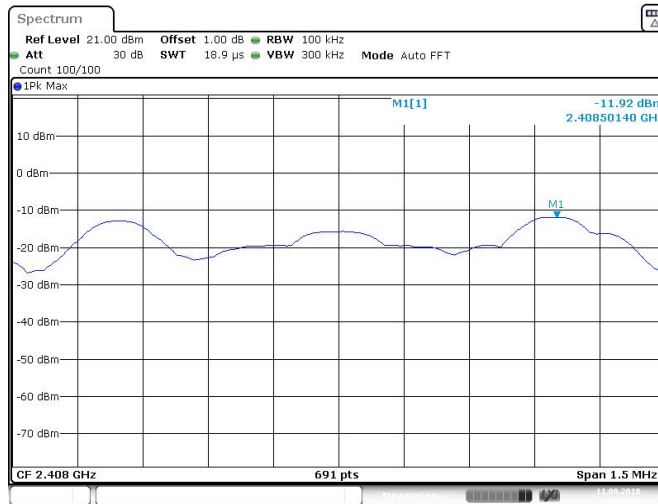

Date: 11 SEP 2018 13:49:23

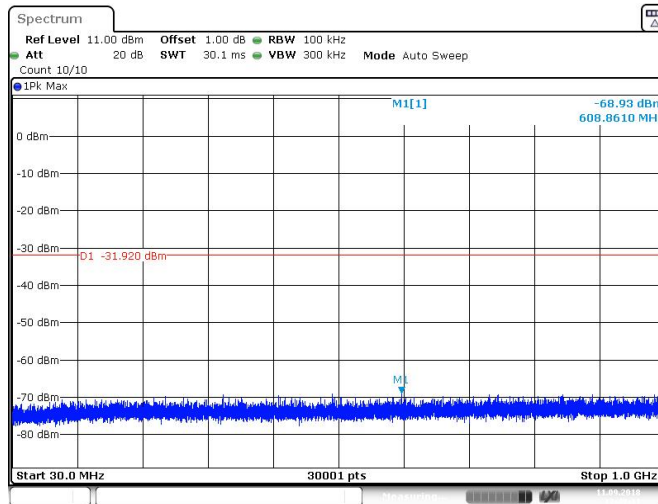

Date: 11 SEP 2018 13:49:31

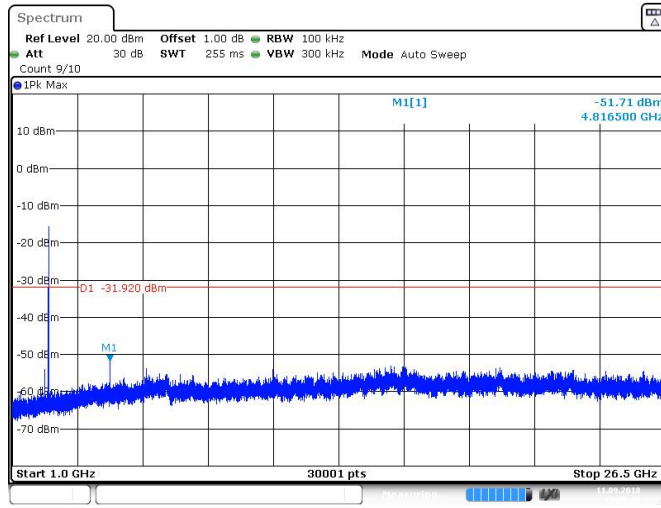

Middle channel 2440MHz

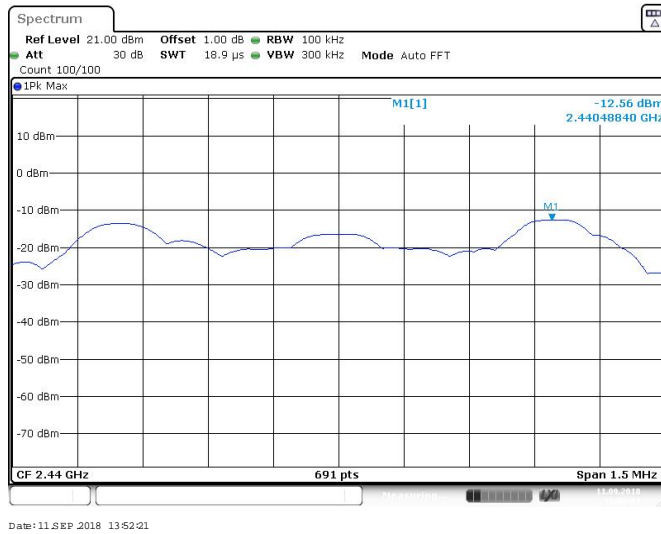

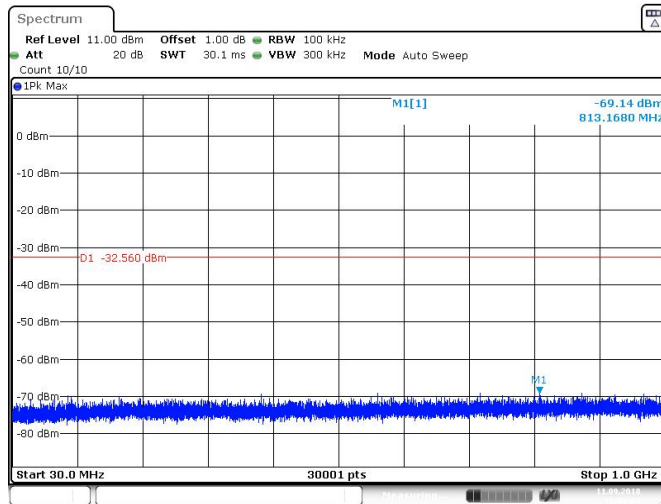

Date: 11 SEP 2018 13:52:30

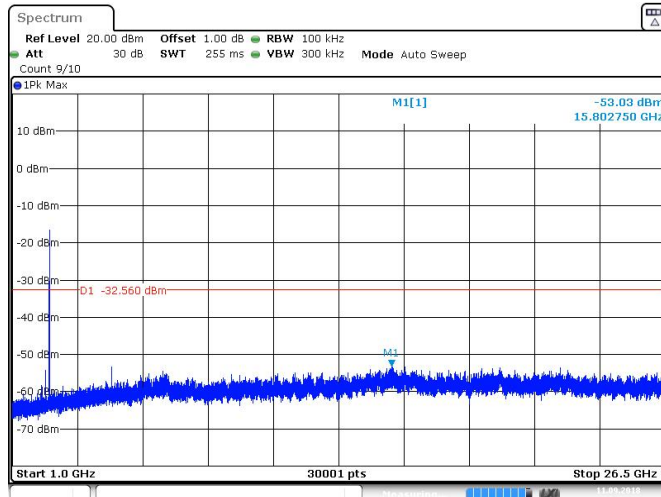

Date: 11 SEP 2018 13:52:42



High channel 2474MHz

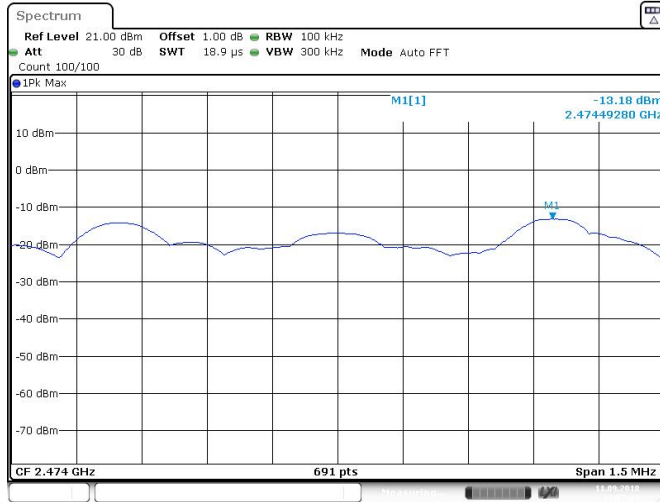

Date: 11 SEP 2018 13:57:25

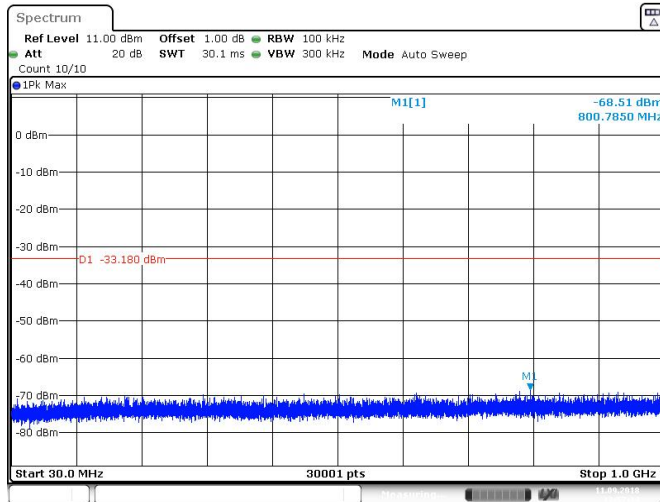

Date: 11 SEP 2018 13:57:34

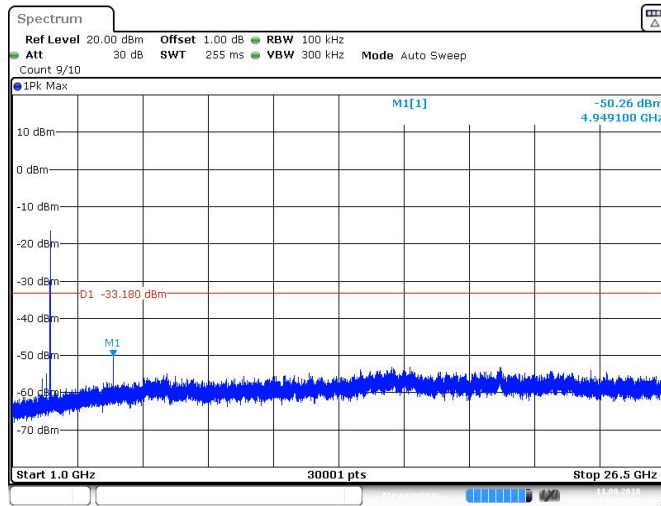

Date: 11 SEP 2018 13:57:45

9.7 Band edge testing

Test Method

- 1 Use the following spectrum analyzer settings:
Span = wide enough to capture the peak level of the in-band emission and all spurious
RBW = 100 kHz, VBW \geq RBW, Sweep = auto, Detector function = peak, Trace = max hold
- 2 Allow the trace to stabilize, use the peak and delta measurement to record the result.
- 3 The level displayed must comply with the limit specified in this Section. .
- 4 Repeat the test at the hopping off and hopping on mode, submit all the plots.

Limit:

In any 100 kHz bandwidth outside the frequency band in which the spread spectrum or digitally modulated device is operating, the RF power that is produced shall be at least 20 dB below that in the 100 kHz bandwidth within the band that contains the highest level of the desired power, based on either an RF conducted or a radiated measurement, provided that the transmitter demonstrates compliance with the peak conducted power limits.



FSK mode: Hopping off

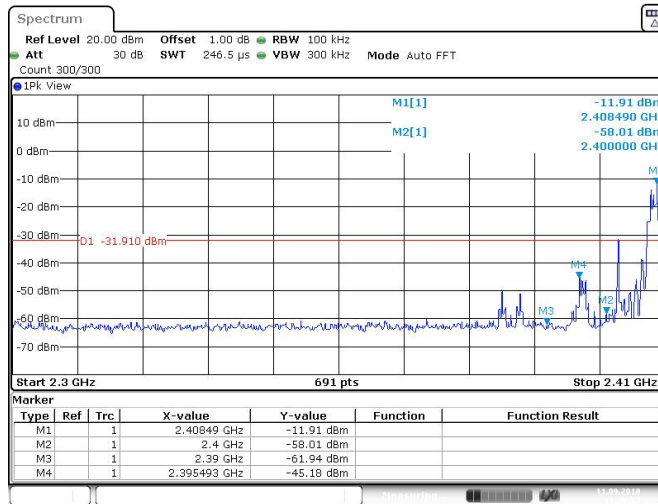

Date: 11.SEP.2018 13:48:58

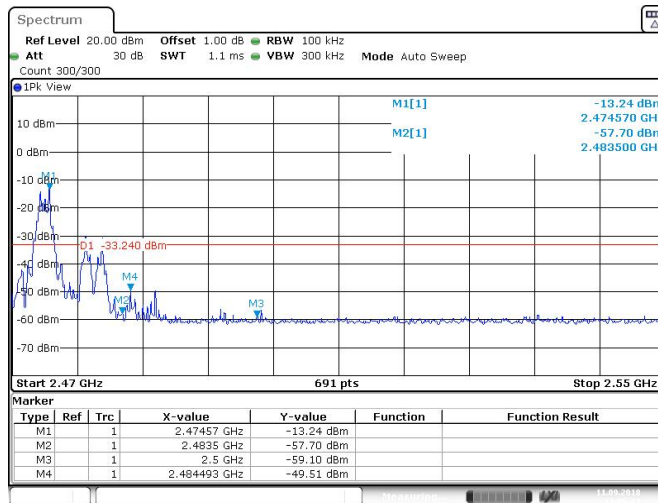

Date: 11.SEP.2018 13:56:21



FSK mode: Hopping on

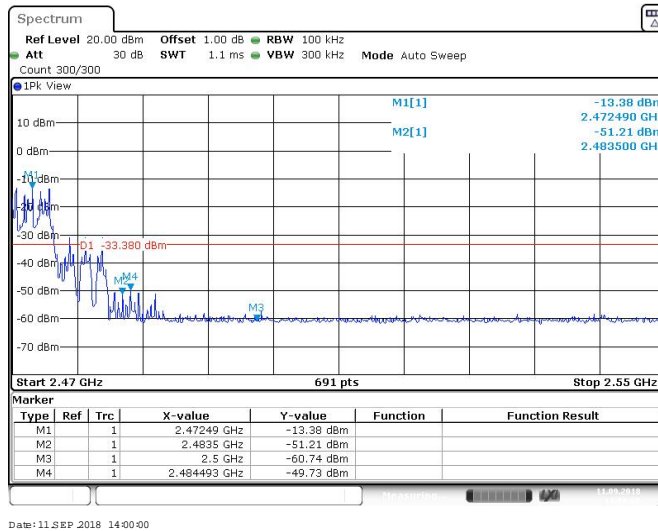
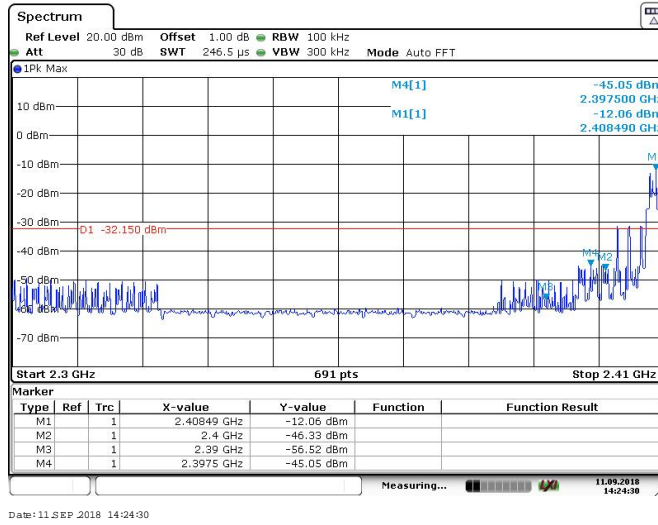

9.8 Spurious radiated emissions for transmitter

Test Method

- 1: The EUT was placed on a turn table which is 1.5m above ground plane for above 1GHz and 0.8m above ground for below 1GHz at 3 meter chamber room for test. The table was rotated 360 degrees to determine the position of the highest radiation.
- 2: The EUT was set 3 meters away from the interference – receiving antenna, which was mounted on the top of a variable – height antenna tower.
- 3: The height of antenna is varied from one meter to four meters above the ground to determine the maximum value of the field strength. Both horizontal and vertical polarizations of the antenna are set to make the measurement.
- 4: For each suspected emission, the EUT was arranged to its worst case and then the antenna was tuned to heights from 1 meter to 4 meters and the rotatable table was turned from 0 degrees to 360 degrees to find the maximum reading.
- 5: Use the following spectrum analyzer settings According to C63.10:
For Above 1GHz
Span = wide enough to capture the peak level of the in-band emission and all spurious
RBW = 1MHz, $VBW \geq RBW$ for peak measurement and $VBW = 10Hz$ for average measurement, Sweep = auto, Detector function = peak, Trace = max hold.
For Below 1GHz
Use the following spectrum analyzer settings:
Span = wide enough to capture the peak level of the in-band emission and all spurious
RBW = 100 KHz, $VBW \geq RBW$ for peak measurement, Sweep = auto, Detector function = peak, Trace = max hold.

Note:

- 1: The resolution bandwidth and video bandwidth of test receiver/spectrum analyzer is 120 KHz for Quasi-peak detection (QP) at frequency below 1GHz.
- 2: The resolution bandwidth of test receiver/spectrum analyzer is 1MHz and the video bandwidth is 3MHz for peak detection (PK) at frequency above 1GHz.
- 3: The resolution bandwidth of test receiver/spectrum analyzer is 1MHz and the video bandwidth is 3MHz for RMS Average ((duty cycle < 98%) for Average detection (AV) at frequency above 1GHz, then the measurement results was added to a correction factor ($20\log(1/\text{duty cycle})$).
- 4: The resolution bandwidth of test receiver/spectrum analyzer is 1MHz and the video bandwidth is 10Hz (duty cycle > 98%) for Average detection (AV) at frequency above 1GHz.

Limit

The radio emission outside the operating frequency band shall be at least 20 dB below that in the 100 kHz bandwidth within the band that contains the highest level of the desired power. Radiated emissions which fall in the restricted bands, as defined in section 15.205, must comply with the radiated emission limits specified in section 15.209.

Frequency MHz	Field Strength uV/m	Field Strength dBµV/m	Detector
30-88	100	40	QP
88-216	150	43.5	QP
216-960	200	46	QP
960-1000	500	54	QP
Above 1000	500	54	AV
Above 1000	5000	74	PK

Spurious radiated emissions for transmitter

According to C63.10, if the peak (or quasi-peak) measured value complies with the average limit, it is unnecessary to perform an average measurement, so AV emission value did not show in below table if the peak value complies with average limit.

Transmitting spurious emission test result as below:

FSK Modulation 2408MHz Test Result

Frequency Band	Frequency	Emission Level	Polarization	Limit	Detector	Margin	Correct factor (dB)	Result
	MHz	dBuV/m		dB μ V/m		dBuV/m		
30-1000MHz	677.96	27.07	H	46	QP	18.93	-18.8	Pass
	878.70	29.57	V	46	QP	16.43	-15.7	Pass
1000-25000MHz	4815.84*	50.94	H	74	PK	23.06	-8.3	Pass
	4816.39*	51.77	V	74	PK	22.23	-8.3	Pass
	7223.75*	49.58	H	74	PK	24.42	-7.9	Pass
	7224.36*	50.16	V	74	PK	23.84	-7.9	Pass

FSK Modulation 2440MHz Test Result

Frequency Band	Frequency	Emission Level	Polarization	Limit	Detector	Margin	Correct factor (dB)	Result
	MHz	dBuV/m		dB μ V/m		dBuV/m		
30-1000MHz	--	--	H	43.5	QP	--	--	Pass
	--	--	V	46	QP	--	--	Pass
1000-25000MHz	4880.55*	51.49	H	74	PK	22.51	-8.4	Pass
	4880.84*	50.05	V	74	PK	23.95	-8.4	Pass
	7320.50*	49.38	H	74	PK	24.62	-7.8	Pass
	7319.15*	48.55	V	74	PK	25.45	-7.8	Pass

FSK Modulation 2474MHz Test Result

Frequency Band	Frequency	Emission Level	Polarization	Limit	Detector	Margin	Correct factor (dB)	Result
	MHz	dBuV/m		dBuV/m		dBuV/m		
30-1000MHz	--	--	H	43.5	QP	--	--	Pass
	--	--	V	46	QP	--	--	Pass
1000-25000MHz	4948.71*	50.72	H	74	PK	23.28	-8.2	Pass
	4947.44*	49.08	V	74	PK	24.92	-8.2	Pass
	7422.17*	48.46	H	74	PK	25.54	-7.7	Pass
	7421.82*	51.33	V	74	PK	22.67	-7.7	Pass

Remark:

- (1) "*" means the emission(s) appear within the restrict bands shall follow the requirement of section 15.205.
- (2) Data of measurement within this frequency range shown "--" in the table above means the reading of emissions are the noise floor or attenuated more than 10dB below the permissible limits or the field strength is too small to be measured.
- (3) Above 1GHz: Corrector factor = Antenna Factor + Cable Loss- Amplifier Gain
Below 1GHz: Corrector factor = Antenna Factor + Cable Loss

10 Test Equipment List

List of Test Instruments

Radiated Emission Test

DESCRIPTION	MANUFACTURER	MODEL NO.	SERIAL NO.	CAL. DUE DATE
EMI Test Receiver	Rohde & Schwarz	ESR 26	101269	2019-7-6
Trilog Super Broadband Test Antenna	Schwarzbeck	VULB 9163	707	2019-7-14
Horn Antenna	Rohde & Schwarz	HF907	102294	2019-7-14
Pre-amplifier	Rohde & Schwarz	SCU 18	102230	2019-7-6
Signal Generator	Rohde & Schwarz	SMY01	839369/005	2019-7-6
Attenuator	Agilent	8491A	MY39264334	2019-7-6
3m Semi-anechoic chamber	TDK	9X6X6	----	2020-7-7
Test software	Rohde & Schwarz	EMC32	Version 9.15.00	N/A

TS8997 Test System

DESCRIPTION	MANUFACTURER	MODEL NO.	SERIAL NO.	CAL. DUE DATE
Signal Generator	Rohde & Schwarz	SMB100A	108272	2019-7-6
Vector Signal Generator	Rohde & Schwarz	SMBV100A	262825	2019-7-6
Communication Synthetical Test Instrument	Rohde & Schwarz	CMW 270	101251	2019-5-31
Signal Analyzer	Rohde & Schwarz	FSV40	101030	2019-7-6
Vector Signal Generator	Rohde & Schwarz	SMU 200A	105324	2019-7-6
RF Switch Module	Rohde & Schwarz	OSP120/OSP-B157	101226/100851	2019-7-6
Power Splitter	Weinschel	1580	SC319	2019-7-5
10dB Attenuator	Weinschel	4M-10	43152	2019-7-6
10dB Attenuator	R&S	DNF	DNF-001	2019-7-6
10dB Attenuator	R&S	DNF	DNF-002	2019-7-6
10dB Attenuator	R&S	DNF	DNF-003	2019-7-6
10dB Attenuator	R&S	DNF	DNF-004	2019-7-6
Test software	Rohde & Schwarz	EMC32	Version 10.38.00	N/A
Test software	Tonscend	System for BT/WIFI	Version 2.6	N/A



11 System Measurement Uncertainty

For a 95% confidence level, the measurement expanded uncertainties for defined systems, in accordance with the recommendations of ISO 17025 were:

System Measurement Uncertainty	
Test Items	Extended Uncertainty
Uncertainty for Radiated Emission in 3m chamber 30MHz-1000MHz	Horizontal: 4.91dB; Vertical: 4.89dB;
Uncertainty for Radiated Emission in 3m chamber 1000MHz-18000MHz	Horizontal: 4.80dB; Vertical: 4.79dB;
Uncertainty for Radiated Spurious Emission 18000MHz-40000MHz	Horizontal: 5.05dB; Vertical: 5.04dB;
Uncertainty for Conducted RF test with TS 8997	Power level test involved: 1.16dB Frequency test involved: 0.6×10^{-7}