

FCC TEST REPORT

Product Name : Wireless Mouse
Trade mark : N/A
Model No. : G1014E
Report Number : BLA-EMC-202001-A48
FCCID : 2AAVD- G1014E
Date of sample receipt : February 21, 2020
Date of Test : February 21, 2020–February 28, 2020
Date of Issue : March 12, 2020
Test Standards : FCC CFR Title 47 Part 15 Subpart C
Section 15.249
Test result : PASS

Prepared for:

Shenzhen Loyal Electronics Co., Ltd
No.5 The First Industrial Area of Shanmen, Songgang, Baoan,
Shenzhen, China

Prepared by:

BlueAsia of Technical Services(Shenzhen) Co., Ltd.
IOT Test Centre of BlueAsia
No. 448 Bulong Road, Bantian Street, Longgang District, Shenzhen,
China
TEL: +86-755-28682673
FAX: +86-755-28682673

Tested by:

Jozu.

Reviewed by:

Sweet. wang

Approved by:

Emen-li

Date:

March 12, 2020



2 Version

Version No.	Date	Description
<i>00</i>	<i>March 12, 2020</i>	<i>Original</i>

BlueAsia

3 Test Summary

Test Item	Test Requirement	Test method	Result
Antenna Requirement	47 CFR Part 15 Subpart C Section 15.203	ANSI C63.10-2013	PASS
AC Power Line Conducted Emission	47 CFR Part 15 Subpart C Section 15.207	ANSI C63.10-2013	N/A
Field Strength of the Fundamental Signal	47 CFR Part 15 Subpart C Section 15.249 (a)	ANSI C63.10-2013	PASS
Spurious Emissions	47 CFR Part 15 Subpart C Section 15.249 (a)/15.209	ANSI C63.10-2013	PASS
Restricted bands around fundamental frequency (Radiated Emission)	47 CFR Part 15 Subpart C Section 15.249(a)/15.205	ANSI C63.10-2013	PASS
20dB Occupied Bandwidth	47 CFR Part 15 Subpart C Section 15.215 (c)	ANSI C63.10-2013	PASS

Pass: The EUT complies with the essential requirements in the standard.

N/A: Not Applicable

4 Contents

	Page
1 COVER PAGE	1
2 VERSION	2
3 TEST SUMMARY	3
4 CONTENTS	4
5 GENERAL INFORMATION	5
5.1 CLIENT INFORMATION.....	5
5.2 GENERAL DESCRIPTION OF EUT	5
5.3 PRODUCT SPECIFICATION SUBJECTIVE TO THIS STANDARD.....	5
5.4 TEST ENVIRONMENT AND MODE	7
5.5 DESCRIPTION OF SUPPORT UNITS	7
5.6 TEST LOCATION.....	7
5.7 TEST FACILITY	7
5.8 DEVIATION FROM STANDARDS	8
5.9 ABNORMALITIES FROM STANDARD CONDITIONS.....	8
5.10 OTHER INFORMATION REQUESTED BY THE CUSTOMER	8
5.11 MEASUREMENT UNCERTAINTY (95% CONFIDENCE LEVELS, K=2).....	9
6 EQUIPMENT LIST	10
7 TEST RESULTS AND MEASUREMENT DATA	12
7.1 ANTENNA REQUIREMENT.....	12
7.2 CONDUCTED EMISSIONS	12
7.3 RADIATED EMISSION	14
7.4 RESTRICTED BANDS AROUND FUNDAMENTAL FREQUENCY	23
7.5 20DB BANDWIDTH	26
APPENDIX 1 PHOTOGRAPHS OF TEST SETUP	28
APPENDIX 2 PHOTOGRAPHS OF EUT	29

5 General Information

5.1 Client Information

Applicant:	Shenzhen Loyal Electronics Co.,Ltd
Address of Applicant:	No.5 The First Industrial Area of Shanmen, Songgang, Baoan, Shenzhen, China
Manufacturer:	Shenzhen Loyal Electronics Co.,Ltd
Address of Manufacturer:	No.5 The First Industrial Area of Shanmen, Songgang, Baoan, Shenzhen, China
Factory:	Shenzhen Loyal Electronics Co.,Ltd
Address of Factory:	No.5 The First Industrial Area of Shanmen, Songgang, Baoan, Shenzhen, China

5.2 General Description of EUT

Product Name:	Wireless Mouse
Mode No.(EUT):	G1014E
Add Mode No.:	G1014E
Trade Mark:	N/A
EUT Supports Radios application:	2.4GHz Wireless
Power Supply:	DC1.5V

5.3 Product Specification subjective to this standard

Frequency Range:	2402 MHz ~ 2480MHz
Frequency Band:	2.4GHz ISM band
Hardware:	V1.0
Software:	1107
Channel Spacing:	2MHz
Modulation Type:	GFSK
Number of Channels:	40 (declared by the client)
Sample Type:	Portable production(mobile production ;fixed production)
Antenna Type:	PCB ANT
Antenna Gain:	2.08dBi
Power Supply:	DC1.5V

Operation Frequency each of channel							
Channel	Frequency	Channel	Frequency	Channel	Frequency	Channel	Frequency
0	2402MHz	10	2422MHz	20	2442MHz	30	2462MHz
1	2404MHz	11	2424MHz	21	2444MHz	31	2464MHz
2	2406MHz	12	2426MHz	22	2446MHz	32	2466MHz
3	2408MHz	13	2428MHz	23	2448MHz	33	2468MHz
4	2410MHz	14	2430MHz	24	2450MHz	34	2470MHz
5	2412MHz	15	2432MHz	25	2452MHz	35	2472MHz
6	2414MHz	16	2434MHz	26	2454MHz	36	2474MHz
7	2416MHz	17	2436MHz	27	2456MHz	37	2476MHz
8	2418MHz	18	2438MHz	28	2458MHz	38	2478MHz
9	2420MHz	19	2440MHz	29	2460MHz	39	2480MHz

Remark: The EUT operation in above frequency list, and used test software to control the EUT for staying in continuous transmitting and receiving mode. Channel 0, 19 and 39 were chosen for testing.

Note:

In section 15.31(m), regards to the operating frequency range over 10 MHz, the Lowest frequency, the middle frequency, and the highest frequency of channel were selected to perform the test, and the selected channel see below:

Channel	Frequency
The Lowest channel(CH0)	2402MHz
The Middle channel(CH19)	2440MHz
The Highest channel(CH39)	2480MHz

5.4 Test Environment and Mode

Operating Environment:	
Temperature:	24.0 °C
Humidity:	52 % RH
Atmospheric Pressure:	1008 mbar
Test mode:	
Transmitting mode:	Keep the EUT in transmitting mode with modulation.(new battery is used)

5.5 Description of Support Units

The EUT has been tested independently and or

The EUT has been tested with associated equipment below.

1) support equipment

Description	Manufacturer	Model No.	Serial Number	Supplied by
Notebook computer	Lenovo	E470C	PF-10FB5C	/
/	/	/	/	/

2) cable

Cable No.	Description	Manufacturer	Cable Type/Length	Supplied by
/	/	/	/	/

5.6 Test Location

All tests were performed at:

BlueAsia of Technical Services(Shenzhen) Co., Ltd.

IOT Test Centre of BlueAsia

No. 448 Bulong Road, Bantian Street, Longgang District, Shenzhen, China

Telephone: TEL: +86-755-28682673 FAX: +86-755-28682673

No tests were sub-contracted.

5.7 Test Facility

The test facility is recognized, certified, or accredited by the following organizations:

FCC — Designation No.: CN1252

BlueAsia of Technical Services(Shenzhen) Co., Ltd has been registered and fully described in a report filed with the (FCC) Federal Communications Commission. The acceptance letter from the FCC is maintained in files. Designation CN1252.

ISED — CAB identifier No.: CN0028

BlueAsia of Technical Services(Shenzhen) Co., Ltd has been registered by Certification and Engineering Bureau of ISED for radio equipment testing with CAB identifier CN0028

5.8 Deviation from Standards

None.

5.9 Abnormalities from Standard Conditions

None.

5.10 Other Information Requested by the Customer

None.

BlueAsia

5.11 Measurement Uncertainty (95% confidence levels, k=2)

Test Item	Frequency Range	Measurement Uncertainty	Notes
Radiated Emission	9kHz ~ 30MHz	± 4.34dB	(1)
Radiated Emission	30MHz ~ 1000MHz	± 4.24dB	(1)
Radiated Emission	1GHz ~ 26.5GHz	± 4.68dB	(1)
AC Power Line Conducted Emission	0.15MHz ~ 30MHz	± 3.45dB	(1)

Note (1): The measurement uncertainty is for coverage factor of k=2 and a level of confidence of 95%.

BlueAsia

6 Equipment List

Radiated Emission:						
Item	Test Equipment	Manufacturer	Model No.	Serial No.	Cal.Date (mm-dd-yy)	Cal.Due date (mm-dd-yy)
1	3m SAC	SKET	9m*6 m*6m	966	06-10-2018	06-09-2023
2	Broadband Antenna	SCHWARZBECK	VULB9168	00836 P:00227	07-14-2019	07-13-2020
3	Horn Antenna	SCHWARZBECK	9120D	01892 P:00331	07-14-2019	07-13-2020
4	EMI Test Software	EZ	EZ	N/A	N/A	N/A
5	Pre-amplifier	SKET	N/A	N/A	07-19-2019	07-18-2020
6	Spectrum analyzer	Rohde & Schwarz	FSP40	100817	05-24-2019	05-23-2020
7	EMI Test Receiver	Rohde & Schwarz	ESR7	101199	03-21-2019	03-20-2020
8	Controller	SKET	N/A	N/A	N/A	N/A
9	Vector Signal Generator	Agilent	E4438C	MY45092582	05-24-2019	05-23-2020
10	Signal Generator	Agilent	E8257D	MY44320250	05-24-2019	05-23-2020
11	Coaxial Cable	BlueAsia	BLA-XC-02	N/A	N/A	N/A
12	Coaxial Cable	BlueAsia	BLA-XC-03	N/A	N/A	N/A
13	Coaxial Cable	BlueAsia	BLA-XC-01	N/A	N/A	N/A

Conducted Emission						
Item	Test Equipment	Manufacturer	Model No.	Serial No.	Cal.Date (mm-dd-yy)	Cal.Due date (mm-dd-yy)
1	EMI Test Receiver	Rohde & Schwarz	ESPI3	101082	06-10-2019	06-09-2020
2	LISN	CHASE	MN2050D	1447	12-18-2019	12-17-2020
3	LISN	Rohde & Schwarz	ENV216	3560.6550.15	07-19-2019	07-18-2020
4	EMI Test Software	EZ	EZ	N/A	N/A	N/A
5	Temperature Humidity Chamber	Mingle	TH101B	N/A	07-19-2019	07-18-2020
6	Coaxial Cable	BlueAsia	BLA-XC-05	N/A	N/A	N/A

7 Test results and Measurement Data

7.1 Antenna Requirement

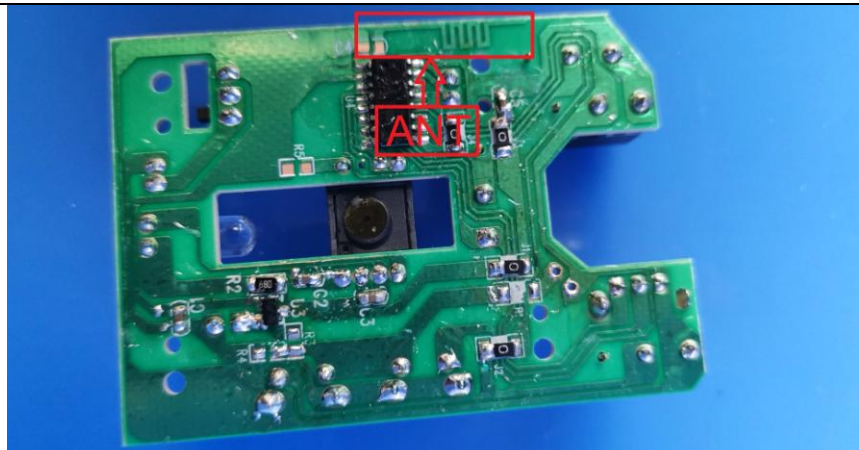
Standard requirement:	47 CFR Part 15C Section 15.203
15.203 requirement: An intentional radiator shall be designed to ensure that no antenna other than that furnished by the responsible party shall be used with the device. The use of a permanently attached antenna or of an antenna that uses a unique coupling to the intentional radiator, the manufacturer may design the unit so that a broken antenna can be replaced by the user, but the use of a standard antenna jack or electrical connector is prohibited.	
EUT Antenna:	
The antenna is integrated on the main PCB and no consideration of replacement. The best case gain of the antenna is 2.08dBi.	

7.2 Conducted Emissions

Test Requirement: 47 CFR Part 15C Section 15.207
Test Method: ANSI C63.10
Test Frequency Range: 150KHz to 30MHz

Limit:	Frequency range (MHz)	Limit (dB μ V)	
		Quasi-peak	Average
	0.15-0.5	66 to 56*	56 to 46*
	0.5-5	56	46
	5-30	60	50

* Decreases with the logarithm of the frequency.

- Test Procedure:**
- 1) The mains terminal disturbance voltage test was conducted in a shielded room.
 - 2) The EUT was connected to AC power source through a LISN 1 (Line Impedance Stabilization Network) which provides a 50 Ω /50 μ H + 5 Ω linear impedance. The power cables of all other units of the EUT were connected to a second LISN 2, which was bonded to the ground reference plane in the same way as the LISN 1 for the unit being measured. A multiple socket outlet strip was used to connect multiple power cables to a single LISN provided the rating of the LISN was not exceeded.
 - 3) The tabletop EUT was placed upon a non-metallic table 0.8m above the ground reference plane. And for floor-standing arrangement, the EUT was placed on the horizontal ground reference plane,
 - 4) The test was performed with a vertical ground reference plane. The rear of the EUT shall be 0,4 m from the vertical ground reference plane. The vertical ground reference plane was bonded to the horizontal ground reference plane. The LISN 1 was placed 0,8 m from the boundary of the unit under test and bonded to a ground reference plane for LISNs mounted on top of the ground reference plane. This distance was between the closest points of the LISN 1 and the EUT. All other units of the EUT and associated equipment was at least 0,8 m from the LISN 2.
 - 5) In order to find the maximum emission, the relative positions of

equipment and all of the interface cables must be changed according to ANSI C63.10 on conducted measurement.

Test Setup:

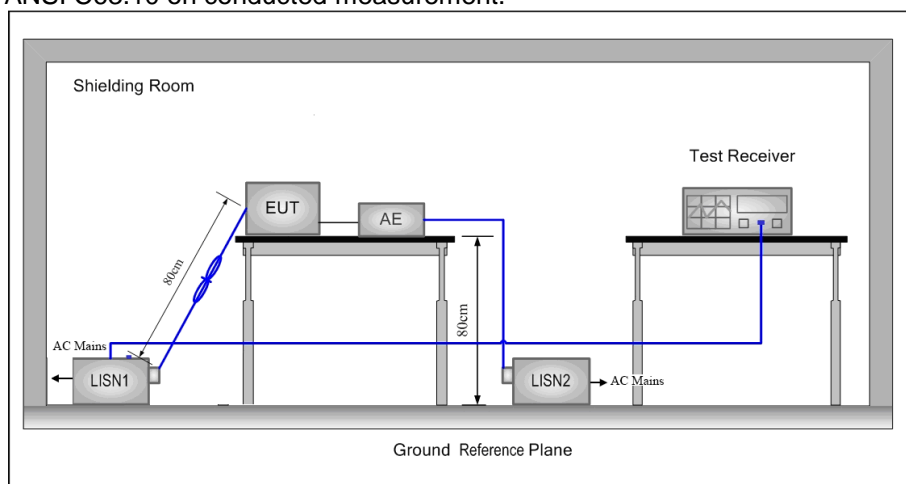

Test Mode:

Keep the EUT in transmitting mode

Instruments Used:

Refer to section 5.11 for details

Test Results:

N/A

BlueAsia

7.3 Radiated Emission

Test Requirement: 47 CFR Part 15C Section 15.249 and 15.209

Test Method: ANSI C63.10

Test Site: Measurement Distance: 3m (Semi-Anechoic Chamber)

Receiver Setup:

Frequency	Detector	RBW	VBW	Remark
0.009MHz-0.090MHz	Peak	10kHz	30KHz	Peak
0.009MHz-0.090MHz	Average	10kHz	30KHz	Average
0.090MHz-0.110MHz	Quasi-peak	10kHz	30KHz	Quasi-peak
0.110MHz-0.490MHz	Peak	10kHz	30KHz	Peak
0.110MHz-0.490MHz	Average	10kHz	30KHz	Average
0.490MHz -30MHz	Quasi-peak	10kHz	30kHz	Quasi-peak
30MHz-1GHz	Quasi-peak	120 kHz	300KHz	Quasi-peak
Above 1GHz	Peak	1MHz	3MHz	Peak
	Peak	1MHz	10Hz	Average

Test Setup:

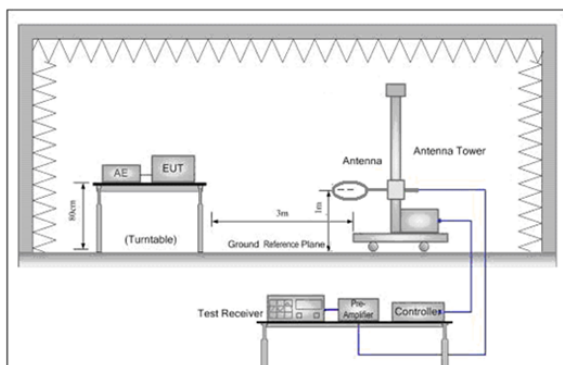

Figure 1. Below 30MHz

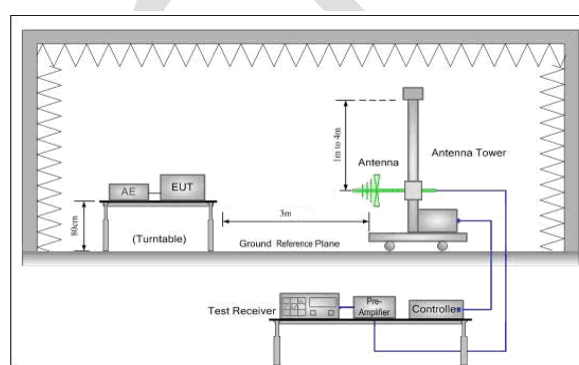

Figure 2. 30MHz to 1GHz

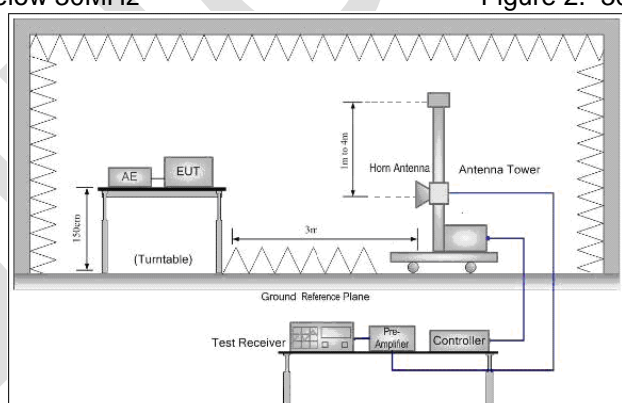

Figure 3. Above 1GHz

Test Procedure:

Below 1GHz test procedure as below:

The EUT was placed on the top of a rotating table 0.8 meters above the ground at a 3 meter semi-anechoic chamber. The table was rotated 360 degrees to determine the position of the highest radiation.

The EUT was set 3 meters away from the interference-receiving antenna, which was mounted on the top of a variable-height antenna tower.

The antenna height is varied from one meter to four meters above the ground to determine the maximum value of the field strength. Both horizontal and vertical polarizations of the antenna are set to make the measurement.

For each suspected emission, the EUT was arranged to its worst case and then the antenna was tuned to heights from 1 meter to 4 meters (for the test frequency of below 30MHz, the antenna was tuned to heights 1 meter) and the rotating table was turned from 0 degrees to 360 degrees to find the maximum reading.

The test-receiver system was set to Peak Detect Function and Specified Bandwidth with Maximum Hold Mode.

If the emission level of the EUT in peak mode was 10dB lower than the limit specified, then testing could be stopped and the peak values of the EUT would be reported. Otherwise the emissions that did not have 10dB margin would be re-tested one by one using peak, quasi-peak or average method as specified and then reported in a data sheet.

Above 1GHz test procedure as below:

Different between above is the test site, change from Semi- Anechoic Chamber to fully Anechoic Chamber and change form table 0.8 meter to 1.5 meter(Above 18GHz the distance is 1 meter and table is 1.5 meter).

Test the EUT in the lowest channel ,middle channel, the Highest channel

The radiation measurements are performed in X, Y, Z axis positioning for Transmitting mode, and found the X axis positioning which it is worse case.

Repeat above procedures until all frequencies measured was complete.

Limit:
(Spurious Emissions)

Frequency	Field strength (microvolt/meter)	Limit (dB μ V/m)	Remark	Measurement distance (m)
0.009MHz-0.490MHz	2400/F (kHz)	-	-	300
0.490MHz-1.705MHz	24000/F (kHz)	-	-	30
1.705MHz-30MHz	30	-	-	30
30MHz-88MHz	100	40.0	Quasi-peak	3
88MHz-216MHz	150	43.5	Quasi-peak	3
216MHz-960MHz	200	46.0	Quasi-peak	3
960MHz-1GHz	500	54.0	Quasi-peak	3
Above 1GHz	500	54.0	Average	3

Note: 15.35(b), Unless otherwise specified, the limit on peak radio frequency emissions is 20dB above the maximum permitted average emission limit applicable to the equipment under test. This peak limit applies to the total peak emission level radiated by the device.

Limit:
(Field strength of the fundamental signal)

Frequency	Limit (dB μ V/m @3m)	Remark
2400MHz-2483.5MHz	94.0	Average Value
	114.0	Peak Value

Instruments Used: Refer to section 5.11 for details

Exploratory Test Mode: Transmitting mode

Final Test Mode: Pretest the EUT at Transmitting mode

Test Results: Pass

Measurement Data
Field Strength Of The Fundamental Signal

Peak value:

Frequency (MHz)	Reading Level (dBuV)	Correct Factor (dB)	Level (dB μ V/m)	Limit (dB μ V/m)	Over Limit (dB)	Antenna Polaxis
2402	97.02	-3.82	93.19	114.00	-20.81	H
2402	90.38	-4.17	86.21	114.00	-27.79	V
2440	98.34	-3.62	94.72	114.00	-19.28	H
2440	89.81	-3.98	85.83	114.00	-28.17	V
2480	98.21	-3.40	94.81	114.00	-19.19	H
2480	87.94	-3.79	84.15	114.00	-29.85	V

Average value:

Frequency (MHz)	Reading Level (dBuV)	Correct Factor (dB)	Level (dB μ V/m)	Limit (dB μ V/m)	Over Limit (dB)	Antenna Polaxis
2402	76.36	-3.82	72.54	94.00	-21.46	H
2402	72.16	-4.17	67.99	94.00	-26.01	V
2440	75.89	-3.62	79.51	94.00	-14.49	H
2440	72.12	-3.98	68.14	94.00	-25.86	V
2480	76.05	-3.40	72.65	94.00	-21.35	H
2480	70.48	-3.79	66.69	94.00	-27.31	V

NOTE: RBW 3MHz VBW 10MHz , PK detector is for PK value ,RMS detector is for AV value.

Spurious Emissions
30MHz~1GHz (QP)
Test mode: Transmitting

Horizontal:

72.0 dBuV/m

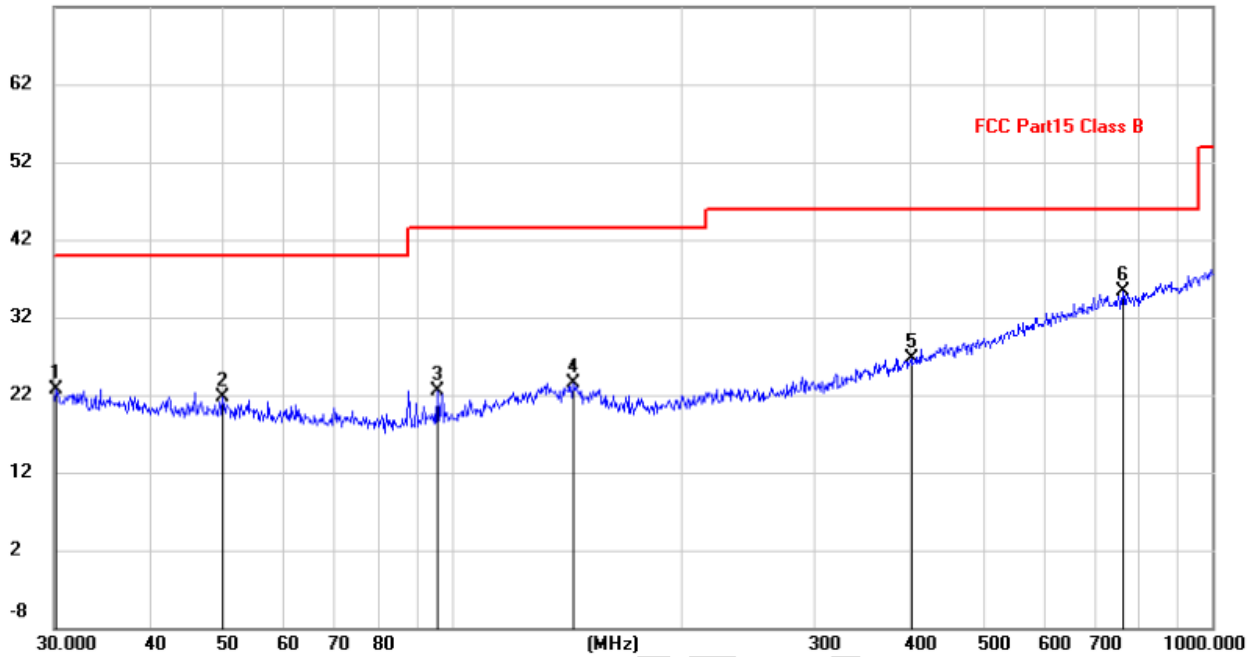

No.	Mk.	Freq. MHz	Reading Level dBuV	Correct Factor dB	Measure- ment dBuV/m	Limit dBuV/m	Over dB	Detector
1		30.2111	0.22	22.52	22.74	40.00	-17.26	QP
2		50.0566	-2.78	24.48	21.70	40.00	-18.30	QP
3		95.7622	2.37	20.21	22.58	43.50	-20.92	QP
4		144.3348	0.29	23.28	23.57	43.50	-19.93	QP
5		401.8385	-0.37	27.04	26.67	46.00	-19.33	QP
6	*	763.3757	1.56	33.72	35.28	46.00	-10.72	QP

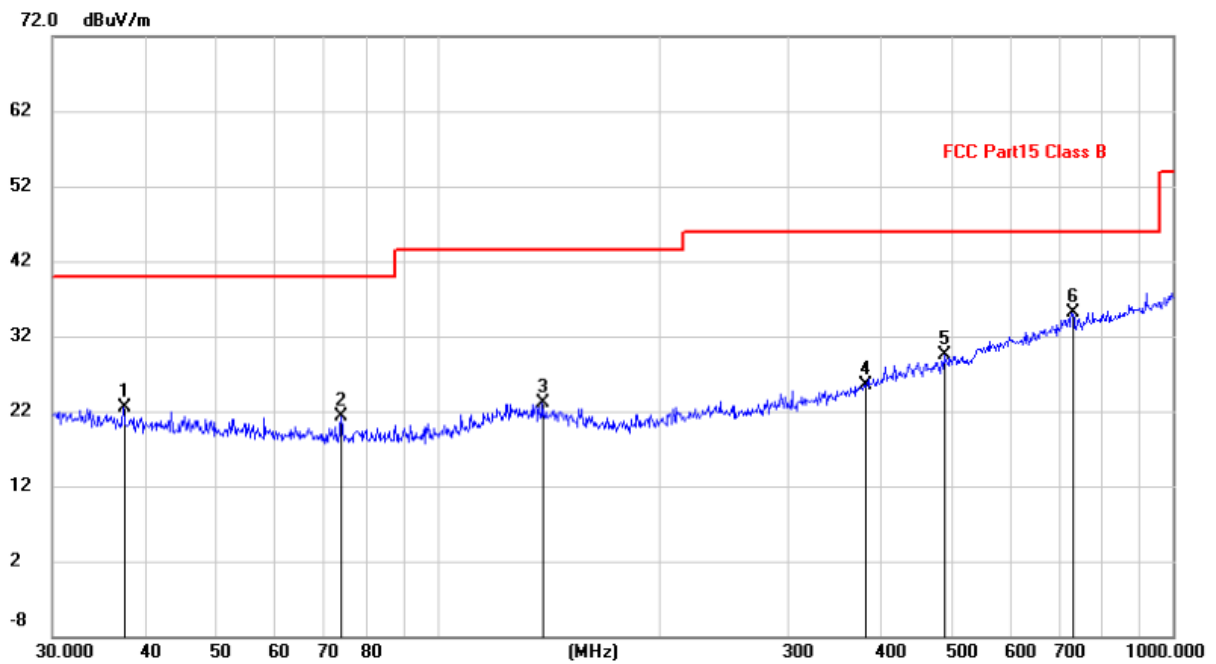
Vertical:

No.	Mk.	Freq. MHz	Reading Level dBuV	Correct Factor dB	Measure- ment dBuV/m	Limit dBuV/m	Over dB	Detector
1		37.4165	-1.17	23.72	22.55	40.00	-17.45	QP
2		74.1351	1.08	20.31	21.39	40.00	-18.61	QP
3		138.8735	-0.21	23.27	23.06	43.50	-20.44	QP
4		381.2487	-0.90	26.45	25.55	46.00	-20.45	QP
5		489.0269	0.62	28.80	29.42	46.00	-16.58	QP
6	*	729.3583	1.84	33.20	35.04	46.00	-10.96	QP

Above 1GHz						
Test mode:	Transmitting	Test channel:	Lowest	Remark:	Peak	
Frequency (MHz)	Reading Level (dBuV)	Correct Factor (dB)	Level (dB μ V/m)	Limit (dB μ V/m)	Over Limit (dB)	Antenna Polaxis
4804.00	54.70	2.38	57.08	74.00	-16.92	H
7206.00	53.43	7.58	61.01	74.00	-12.99	H
9608.00	52.16	7.62	59.78	74.00	-14.22	H
4804.00	55.16	2.38	57.54	74.00	-16.46	V
7206.00	53.85	7.58	61.43	74.00	-12.57	V
9608.00	51.34	7.62	58.96	74.00	-15.04	V

Test mode:	Transmitting	Test channel:	Lowest	Remark:	Average	
Frequency (MHz)	Reading Level (dBuV)	Correct Factor (dB)	Level (dB μ V/m)	Limit (dB μ V/m)	Over Limit (dB)	Antenna Polaxis
4804.00	41.75	2.38	44.13	54.00	-9.87	H
7206.00	40.36	7.58	47.94	54.00	-6.06	H
9608.00	41.11	7.62	48.73	54.00	-5.27	H
4804.00	39.45	2.38	41.83	54.00	-12.17	V
7206.00	40.23	7.58	47.81	54.00	-6.19	V
9608.00	40.04	7.62	47.66	54.00	-6.34	V

Test mode:	Transmitting	Test channel:	Middle	Remark:	Peak	
Frequency (MHz)	Reading Level (dBuV)	Correct Factor (dB)	Level (dB μ V/m)	Limit (dB μ V/m)	Over Limit (dB)	Antenna Polaxis
4880.00	56.13	0.17	56.30	74.00	-17.70	H
7320.00	54.36	7.60	61.96	74.00	-12.04	H
9760.00	52.05	7.62	59.67	74.00	-14.33	H
4880.00	53.93	0.17	54.10	74.00	-19.90	V
7320.00	51.89	7.60	59.49	74.00	-14.51	V
9760.00	50.74	7.62	58.36	74.00	-15.64	V

Test mode:	Transmitting	Test channel:	Middle	Remark:	Average	
Frequency (MHz)	Reading Level (dBuV)	Correct Factor (dB)	Level (dB μ V/m)	Limit (dB μ V/m)	Over Limit (dB)	Antenna Polaxis
4880.00	42.36	0.17	42.53	54.00	-11.47	H
7320.00	41.25	7.60	48.85	54.00	-5.15	H
9760.00	38.59	7.62	46.21	54.00	-7.79	H
4880.00	40.28	0.17	40.45	54.00	-13.55	V
7320.00	39.36	7.60	46.96	54.00	-7.04	V
9760.00	39.04	7.62	46.66	54.00	-7.34	V

Test mode:	Transmitting	Test channel:	Highest	Remark:	Peak	
Frequency (MHz)	Reading Level (dBuV)	Correct Factor (dB)	Level (dB μ V/m)	Limit (dB μ V/m)	Over Limit (dB)	Antenna Polaxis
4960.00	58.33	1.04	59.37	74.00	-14.63	H
7440.00	54.05	7.55	61.60	74.00	-12.40	H
9920.00	52.37	7.63	60.00	74.00	-14.00	H
4960.00	52.99	1.04	54.03	74.00	-19.97	V
7440.00	50.14	7.55	57.69	74.00	-16.31	V
9920.00	50.02	7.63	57.65	74.00	-16.35	V

Test mode:	Transmitting	Test channel:	Highest	Remark:	Average	
Frequency (MHz)	Reading Level (dBuV)	Correct Factor (dB)	Level (dB μ V/m)	Limit (dB μ V/m)	Over Limit (dB)	Antenna Polaxis
4960.00	43.25	1.04	44.29	54.00	-9.71	H
7440.00	41.92	7.55	49.47	54.00	-4.53	H
9920.00	40.25	7.63	47.88	54.00	-6.12	H
4960.00	40.02	1.04	41.06	54.00	-12.94	V
7440.00	39.87	7.55	47.42	54.00	-6.58	V
9920.00	39.55	7.63	47.18	54.00	-6.82	V

Remark:

- 1) The field strength is calculated by adding the Antenna Factor, Cable Factor & Preamplifier. The basic equation with a sample calculation is as follows:
Final Test Level = Receiver Reading + Correct Factor
Correct Factor = Antenna Factor + Cable Factor - Preamplifier Factor
- 2) Scan from 9kHz to 25GHz, The disturbance above 13GHz and below 30MHz was very low, and the above harmonics were the highest point could be found when testing, so only the above harmonics had been displayed. The amplitude of spurious emissions from the radiator which are attenuated more than 20dB below the limit need not be reported .

BlueAsia

7.4 Restricted bands around fundamental frequency

Test Requirement: 47 CFR Part 15C Section 15.209 and 15.205
Test Method: ANSI C63.10
Test Site: Measurement Distance: 3m (Semi-Anechoic Chamber)
Test Setup:

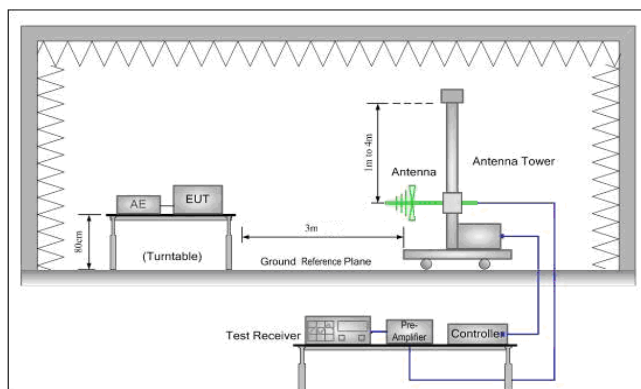

Figure 1. 30MHz to 1GHz

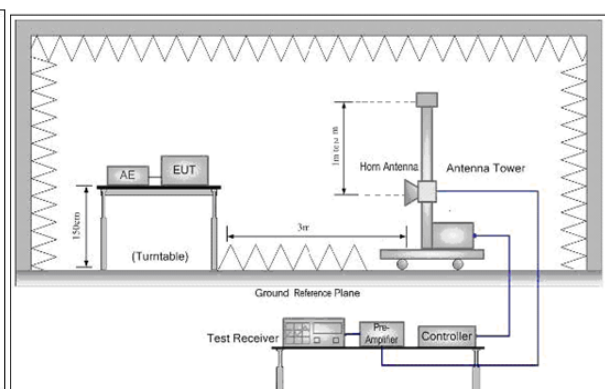

Figure 2. Above 1 GHz

Test Procedure:

Below 1GHz test procedure as below:

- The EUT was placed on the top of a rotating table 0.8 meters above the ground at a 3 meter semi-anechoic chamber. The table was rotated 360 degrees to determine the position of the highest radiation.
- The EUT was set 3 meters away from the interference-receiving antenna, which was mounted on the top of a variable-height antenna tower.
- The antenna height is varied from one meter to four meters above the ground to determine the maximum value of the field strength. Both horizontal and vertical polarizations of the antenna are set to make the measurement.
- For each suspected emission, the EUT was arranged to its worst case and then the antenna was tuned to heights from 1 meter to 4 meters (for the test frequency of below 30MHz, the antenna was tuned to heights 1 meter) and the rotatable table was turned from 0 degrees to 360 degrees to find the maximum reading.
- The test-receiver system was set to Peak Detect Function and Specified Bandwidth with Maximum Hold Mode.
- If the emission level of the EUT in peak mode was 10dB lower than the limit specified, then testing could be stopped and the peak values of the EUT would be reported. Otherwise the emissions that did not have 10dB margin would be re-tested one by one using peak, quasi-peak or average method as specified and then reported in a data sheet.

Above 1GHz test procedure as below:

- Different between above is the test site, change from Semi- Anechoic Chamber to fully Anechoic Chamber and change form table 0.8 meter to 1.5 meter(Above 18GHz the distance is 1 meter and table is 1.5 meter).
- Test the EUT in the lowest channel,,the Highest channel
- The radiation measurements are performed in X, Y, Z axis positioning for Transmitting mode, and found the X axis positioning which it is worse case.
- Repeat above procedures until all frequencies measured was complete.

Limit(band edge): Emissions radiated outside of the specified frequency bands, except for harmonics, shall be attenuated by at least 50 dB below the level of the fundamental or to the general radiated emission limits in Section 15.209, whichever is the lesser attenuation.

Frequency	Limit (dBuV/m @3m)	Remark
30MHz-88MHz	40.0	Quasi-peak Value
88MHz-216MHz	43.5	Quasi-peak Value
216MHz-960MHz	46.0	Quasi-peak Value
960MHz-1GHz	54.0	Quasi-peak Value
Above 1GHz	54.0	Average Value
	74.0	Peak Value

Instruments Used: Refer to section 5.11 for details
Exploratory Test Mode: Transmitting mode
 Pretest the EUT at Transmitting mode
Final Test Mode:
Test Results: Pass

Band edge test data (Radiated Emission)

Test channel:	Lowest			Remark:		Peak
Frequency (MHz)	Read Level (dBuV)	Correct factor (dB/m)	Level (dBuV/m)	Limit Line (dBuV/m)	Over Limit (dB)	Polarization
2310.00	44.56	-4.20	40.36	74.00	-33.64	Horizontal
2390.00	60.85	-3.88	56.97	74.00	-17.03	Horizontal
2400.00	76.79	-3.83	72.96	74.00	-1.04	Horizontal
2310.00	45.71	-4.49	41.22	74.00	-32.78	Vertical
2390.00	49.12	-4.21	44.91	74.00	-29.09	Vertical
2400.00	65.46	-4.17	61.29	74.00	-12.71	Vertical

Test channel:	Lowest			Remark:		Average
Frequency (MHz)	Read Level (dBuV)	Correct factor (dB/m)	Level (dBuV/m)	Limit Line (dBuV/m)	Over Limit (dB)	Polarization
2310.00	32.40	-4.20	28.20	54.00	-25.80	Horizontal
2390.00	38.69	-3.88	34.81	54.00	-19.19	Horizontal
2400.00	55.47	-3.83	51.64	54.00	-2.36	Horizontal
2310.00	32.15	-4.49	27.66	54.00	-26.34	Vertical
2390.00	31.81	-4.21	27.60	54.00	-26.40	Vertical
2400.00	52.03	-4.17	47.86	54.00	-6.14	Vertical

Test channel:	Highest			Remark:		Peak
Frequency (MHz)	Read Level (dBuV)	Correct factor (dB/m)	Level (dBuV/m)	Limit Line (dBuV/m)	Over Limit (dB)	Polarization
2483.50	73.92	-3.38	70.54	74.00	-3.46	Horizontal
2500.00	60.20	-3.30	56.90	74.00	-17.10	Horizontal
2483.50	62.98	-3.77	59.21	74.00	-14.79	Vertical
2500.00	51.89	-3.70	48.19	74.00	-25.81	Vertical

Test channel:	Highest			Remark:		Average
Frequency (MHz)	Read Level (dBuV)	Correct factor (dB/m)	Level (dBuV/m)	Limit Line (dBuV/m)	Over Limit (dB)	Polarization
2483.50	56.02	-3.38	52.64	54.00	-1.36	Horizontal
2500.00	48.74	-3.30	45.44	54.00	-8.56	Horizontal
2483.50	45.49	-3.77	41.72	54.00	-12.28	Vertical
2500.00	31.90	-3.70	28.20	54.00	-25.80	Vertical

Note:

The field strength is calculated by adding the Antenna Factor, Cable Factor & Pre-amplifier. The basic equation with a sample calculation is as follows:

Final Test Level = Receiver Reading + Correct Factor

Correct Factor = Antenna Factor + Cable Factor - Pre-amplifier Factor

7.5 20dB Bandwidth

Test Requirement: 47 CFR Part 15C Section 15.215

Test Method: ANSI C63.10

Test Setup:

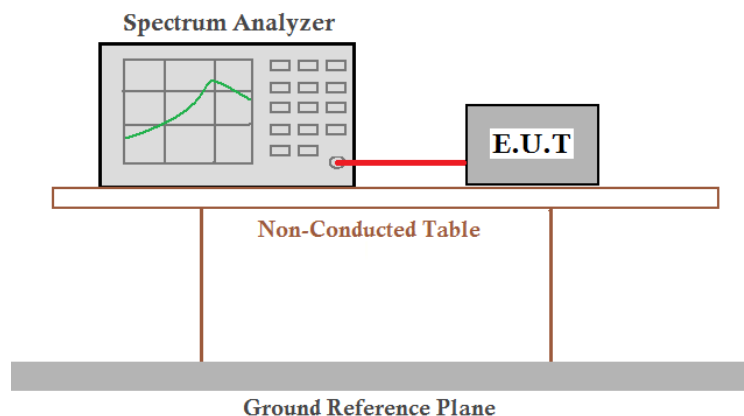

Instruments Used: Refer to section 5.11 for details

Exploratory Test Mode: Transmitting mode
Pretest the EUT at Transmitting mode

Final Test Mode:

Limit: N/A

Test Results: Pass

Measurement Data

Test channel	20dB bandwidth (MHz)	Results
Lowest	2.028	Pass
Middle	2.052	Pass
Highest	2.076	Pass

Test plot as follows:

Test channel: Lowest

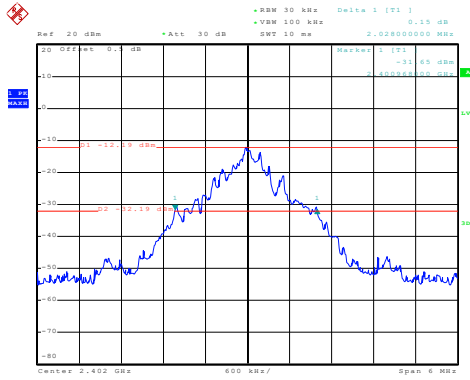

Date: 25.FEB.2020 10:04:24
Test channel: Middle

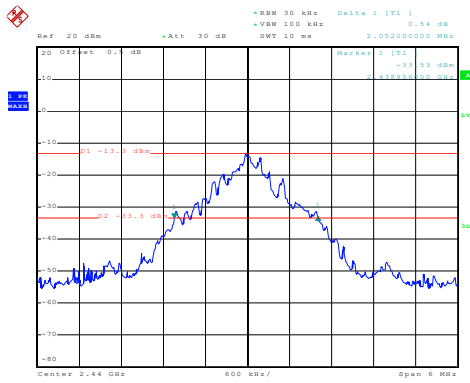

Date: 25.FEB.2020 10:07:16
Test channel: Highest

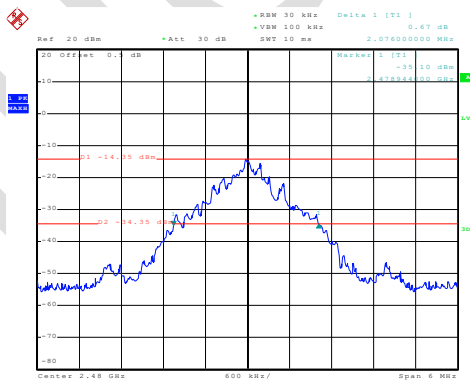

Date: 25.FEB.2020 10:12:05

APPENDIX 1 PHOTOGRAPHS OF TEST SETUP



Radiated emission Test Setup-2 (30MHz~1GHz)



Radiated spurious emission Test Setup-3(Above 1GHz)

APPENDIX 2 PHOTOGRAPHS OF EUT

Test model No.: G1014E



View of Product-1(model : G1014E)



View of Product-2(model : G1014E)



View of Product-3(model : G1014E)



View of Product-4(model : G1014E)



View of Product-5(model : G1014E)



View of Product-6(model : G1014E)

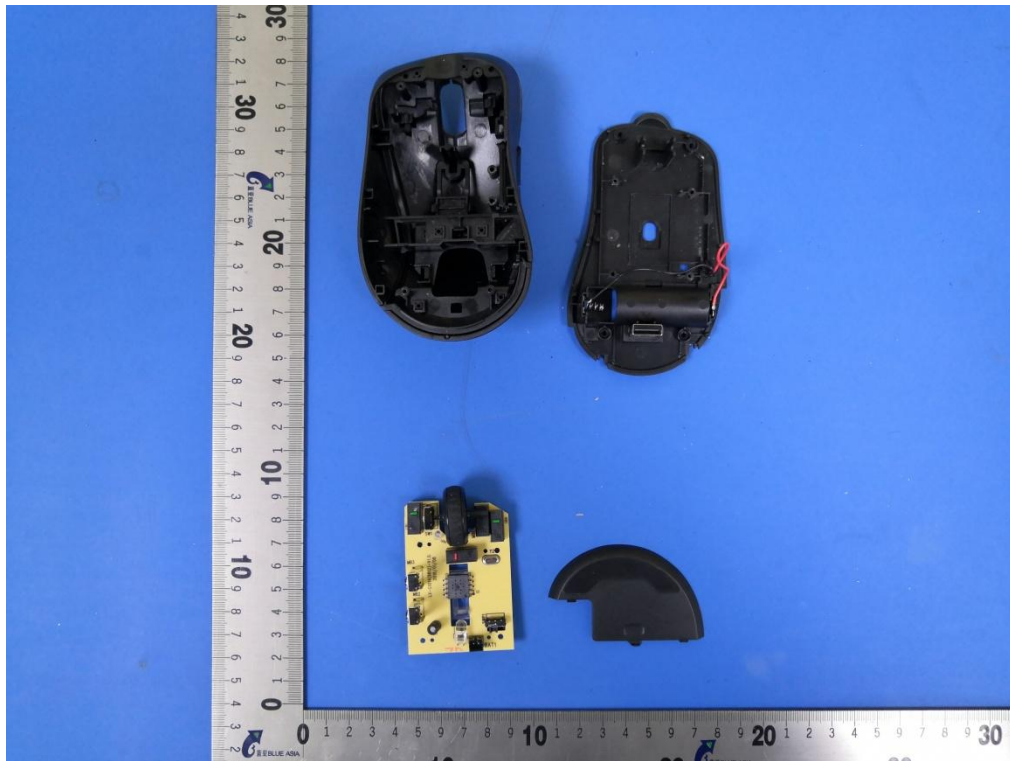

View of Product-7(model : G1014E)

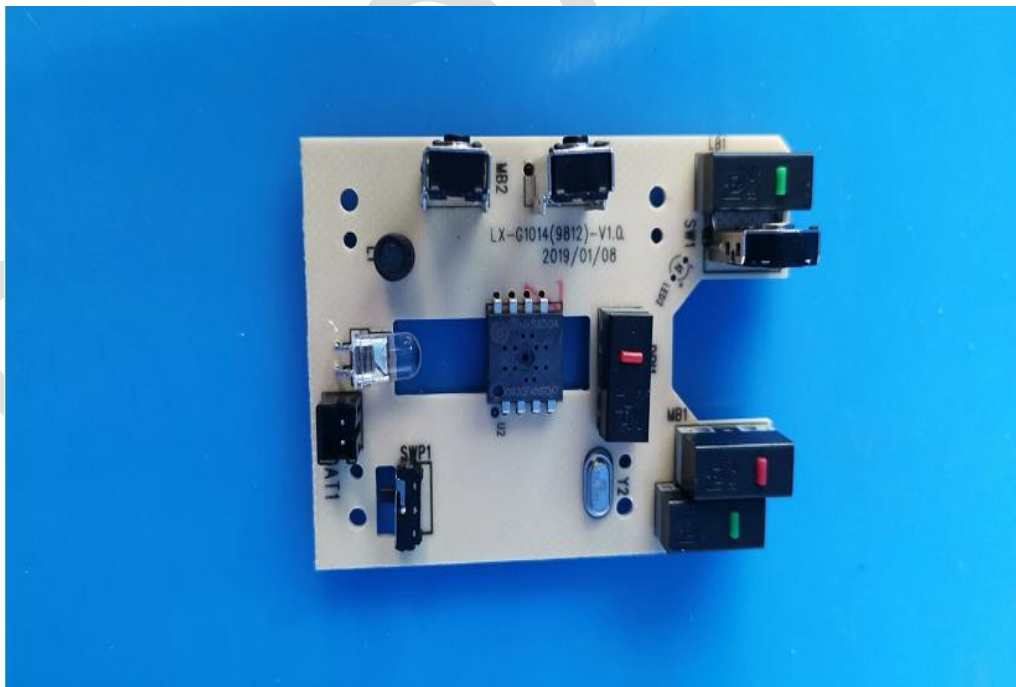

View of Product-8(model : G1014E)

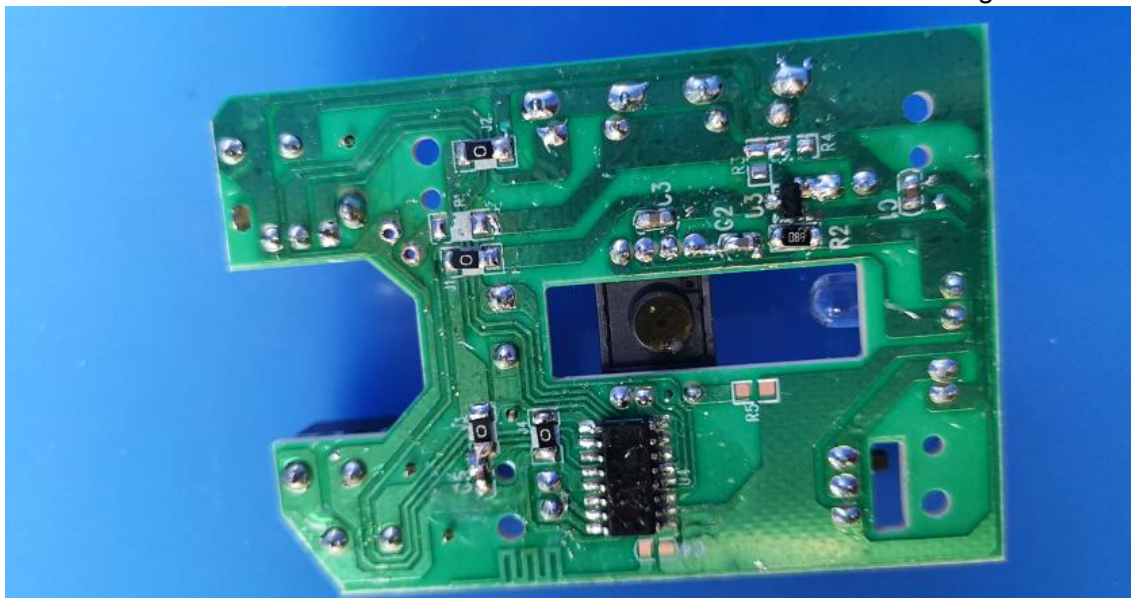

*** End of Report ***

The test report is effective only with both signature and specialized stamp, The result(s) shown in this report refer only to the sample(s) tested. Without written approval of BlueAsia, this report can't be reproduced except in full.