



CTC Laboratories, Inc.

1-2/F., Building 2, Jiaquan Building, Guanlan High-Tech Park, Shenzhen, Guangdong, China
Tel: +86-755-27521059 Fax: +86-755-27521011 <http://www.sz-ctc.org.cn>

TEST REPORT

Report No.: **CTC20220953E01**

FCC ID.....: **2AAVD-1063A**

IC.....: **23918-YC1063A**

Applicant.....: **Shenzhen Loyal Electronics Co., Ltd.**

Address.....: No.5, First Industry Park, Shanmen Songgang, Baoan, Shenzhen, Guangdong, China

Manufacturer.....: Shenzhen Loyal Electronics Co., Ltd.

Address.....: No.5, First Industry Park, Shanmen Songgang, Baoan, Shenzhen, Guangdong, China

Product Name.....: **Dongle**

Trade Mark.....: /

Model/Type reference.....: YC1063-V03

Listed Model(s): /

Standard.....: **FCC CFR Title 47 Part 15 Subpart C Section 15.249
RSS-210 Issue 10**

Date of receipt of test sample...: May 10, 2022

Date of testing.....: May 10, 2022 to May 18, 2022

Date of issue.....: May 19, 2022

Result.....: **PASS**

Compiled by:		
(Printed name+signature)	Jim Jiang	<i>Jim Jiang</i>
Supervised by:		
(Printed name+signature)	Miller Ma	<i>Miller Ma</i>
Approved by:		
(Printed name+signature)	Totti Zhao	<i>Totti Zhao</i>

Testing Laboratory Name.....: **CTC Laboratories, Inc.**

Address.....: 1-2/F., Building 2, Jiaquan Building, Guanlan High-Tech Park, Shenzhen, Guangdong, China

This test report may be duplicated completely for legal use with the approval of the applicant. It should not be reproduced except in full, without the written approval of our laboratory. The client should not use it to claim product endorsement by CTC. The test results in the report only apply to the tested sample. The test report shall be invalid without all the signatures of testing engineers, reviewer and approver. Any objections must be raised to CTC within 15 days since the date when the report is received. It will not be taken into consideration beyond this limit. The test report merely correspond to the test sample.



Table of Contents

Page

- 1. TEST SUMMARY3
 - 1.1. TEST STANDARDS.....3
 - 1.2. REPORT VERSION3
 - 1.3. TEST DESCRIPTION.....3
 - 1.4. TEST FACILITY4
 - 1.5. MEASUREMENT UNCERTAINTY4
 - 1.6. ENVIRONMENTAL CONDITIONS.....5

- 2. GENERAL INFORMATION6
 - 2.1. CLIENT INFORMATION6
 - 2.2. GENERAL DESCRIPTION OF EUT6
 - 2.3. ACCESSORY EQUIPMENT INFORMATION7
 - 2.4. OPERATION STATE8
 - 2.5. MEASUREMENT INSTRUMENTS LIST9

- 3. TEST ITEM AND RESULTS11
 - 3.1. CONDUCTED EMISSION.....11
 - 3.2. 20 DB OCCUPIED BANDWIDTH14
 - 3.3. RADIATED FIELD STRENGTH OF THE FUNDAMENTAL SIGNAL.....17
 - 3.4. RADIATED SPURIOUS EMISSIONS AND BANDEDGE EMISSION24
 - 3.5. BAND EDGE EMISSIONS (RADIATED)32
 - 3.6. ANTENNA REQUIREMENT.....37



1. TEST SUMMARY

1.1. Test Standards

The tests were performed according to following standards:

[FCC Rules Part 15.249](#): Operation within the bands 902-928 MHz, 2400-2483.5 MHz, 5725-5875 MHz, and 24.0-24.25 GHz.

[RSS-210](#): Licence-Exempt Radio Apparatus: Category I Equipment

[ANSI C63.10-2013](#): American National Standard for Testing Unlicensed Wireless Devices.

1.2. Report Version

Revised No.	Date of issue	Description
01	May 19, 2022	Original

1.3. Test Description

FCC Part 15 Subpart C (15.249) / RSS-210 Issue 10				
Test Item	Standard Section		Result	Test Engineer
	FCC	IC		
Antenna Requirement	15.203	/	Pass	Jim Jiang
AC Power Line Conducted Emissions	15.207	RSS-Gen 8.8	Pass	Jim Jiang
20dB Occupied Bandwidth	15.215/15.249	/	Pass	Jim Jiang
Field strength of the Fundamental signal	15.249(a)	RSS-210 F.1.a	Pass	Jim Jiang
Spurious Emissions	15.209/15.249(a)	RSS-210 F.1.e	Pass	Jim Jiang
Band edge Emissions	15.205/15.249(d)	/	Pass	Jim Jiang

Note:

1. The measurement uncertainty is not included in the test result.
2. N/A: means this test item is not applicable for this device according to the technology characteristic of device.



1.4. Test Facility

CTC Laboratories, Inc.

Add: 1-2/F., Building 2, Jiaquan Building, Guanlan High-Tech Park, Shenzhen, Guangdong, China

Laboratory accreditation

The test facility is recognized, certified, or accredited by the following organizations:

A2LA-Lab Cert. No.: 4340.01

CTC Laboratories, Inc. EMC Laboratory has been accredited by A2LA for technical competence in the field of electrical testing, and proved to be in compliance with ISO/IEC 17025:2017 General Requirements for the Competence of Testing and Calibration Laboratories and any additional program requirements in the identified field of testing.

Industry Canada (Registration No.: 9783A, CAB Identifier: CN0029)

CTC Laboratories, Inc. EMC Laboratory has been registered by Certification and Engineer Bureau of Industry Canada for the performance of with Registration NO.: 9783A on Jan, 2016.

FCC (Registration No.: 951311, Designation Number CN1208)

CTC Laboratories, Inc. EMC Laboratory has been registered and fully described in a report filed with the (FCC) Federal Communications Commission. The acceptance letter from the FCC is maintained in our files. Registration 951311, Aug 26, 2017.

1.5. Measurement Uncertainty

The data and results referenced in this document are true and accurate. The reader is cautioned that there may be errors within the calibration limits of the equipment and facilities. The measurement uncertainty was calculated for all measurements listed in this test report acc. to TR-100028-01 "Electromagnetic compatibility and Radio spectrum Matters (ERM); Uncertainties in the measurement of mobile radio equipment characteristics; Part 1" and TR-100028-02 "Electromagnetic compatibility and Radio spectrum Matters (ERM); Uncertainties in the measurement of mobile radio equipment characteristics; Part 2" and is documented in the CTC Laboratories, Inc. quality system acc. to DIN EN ISO/IEC 17025. Furthermore, component and process variability of devices similar to that tested may result in additional deviation. The manufacturer has the sole responsibility of continued compliance of the device.

Below is the best measurement capability for CTC Laboratories, Inc.



Test Items	Measurement Uncertainty	Notes
Transmitter power conducted	0.42 dB	(1)
Transmitter power Radiated	2.14 dB	(1)
Conducted spurious emissions 9kHz~40GHz	1.60 dB	(1)
Radiated spurious emissions 9kHz~40GHz	2.20 dB	(1)
Conducted Emissions 9kHz~30MHz	3.20 dB	(1)
Radiated Emissions 30~1000MHz	4.70 dB	(1)
Radiated Emissions 1~18GHz	5.00 dB	(1)
Radiated Emissions 18~40GHz	5.54 dB	(1)
Occupied Bandwidth	-----	(1)

Note (1): This uncertainty represents an expanded uncertainty expressed at approximately the 95% confidence level using a coverage factor of k=2.

1.6. Environmental Conditions

During the measurement the environmental conditions were within the listed ranges:

Temperature:	21°C~27°C
Relative Humidity:	40%~60%
Atmospheric Pressure:	101kPa



2. GENERAL INFORMATION

2.1. Client Information

Applicant:	Shenzhen Loyal Electronics Co., Ltd.
Address:	No.5, First Industry Park, Shanmen Songgang, Baoan, Shenzhen, Guangdong, China
Manufacturer:	Shenzhen Loyal Electronics Co., Ltd.
Address:	No.5, First Industry Park, Shanmen Songgang, Baoan, Shenzhen, Guangdong, China

2.2. General Description of EUT

Product Name:	Dongle
Trade Mark:	/
Model/Type reference:	YC1063-V03
Listed Model(s):	/
Model Difference:	/
Power supply:	Input: DC5V 100mA
Tested model:	YC1063-V03
Serial number:	2205000001
Software version:	V1.0
2.4GHz ISM Band	
Modulation:	GFSK
Operation frequency:	2402MHz~2480MHz
Channel number:	79
Antenna type:	PCB Antenna
Antenna gain:	2.34dBi



2.3. Accessory Equipment Information

Equipment Information			
Name	Model	S/N	Manufacturer
Notebook	ThinkPad T460s	/	Lenovo
Cable Information			
Name	Shielded Type	Ferrite Core	Length
USB Cable	Unshielded	NO	100cm
Test Software Information			
Name	Version	/	/
FCC Test Tool	V1.6	/	/



2.4. Operation State

The EUT has been tested under test mode condition. The Applicant provides software to control the EUT for staying in continuous transmitting and receiving mode for testing.

Operation Frequency List:

Channel	Frequency (MHz)
01	2402
02	2403
⋮	⋮
38	2439
39	2440
40	2441
⋮	⋮
78	2479
79	2480

Note: The display in grey were the channel selected for testing.

Test Mode:

For RF test items
The engineering test program was provided and enabled to make EUT continuous transmit. (duty cycle>98%).
For AC power line conducted emissions:
The EUT was set to connect with large package sizes transmission.
For Radiated spurious emissions test item:
The engineering test program was provided and enabled to make EUT continuous transmit. The EUT in each of three orthogonal axis emissions had been tested, but only the worst case (X axis) data recorded in the report.



2.5. Measurement Instruments List

Tonscend JS0806-2 Test system					
Item	Test Equipment	Manufacturer	Model No.	Serial No.	Calibrated until
1	Spectrum Analyzer	Rohde & Schwarz	FSU26	100105	Dec. 23, 2022
2	Spectrum Analyzer	Rohde & Schwarz	FUV40-N	101331	Mar. 15, 2023
3	MXG Vector Signal Generator	Agilent	N5182A	MY47420864	Dec. 23, 2022
4	Signal Generator	Agilent	E8257D	MY46521908	Dec. 23, 2022
5	Power Sensor	Agilent	U2021XA	MY5365004	Mar. 15, 2023
6	Power Sensor	Agilent	U2021XA	MY5365006	Mar. 15, 2023
7	Simultaneous Sampling DAQ	Agilent	U2531A	TW54493510	Mar. 15, 2023
8	Climate Chamber	TABAI	PR-4G	A8708055	Dec. 23, 2022
9	Wideband Radio Communication Tester	Rohde & Schwarz	CMW500	116410	Dec. 23, 2022
10	Climate Chamber	ESPEC	MT3065	/	Dec. 23, 2022
11	300328 v2.2.2 test system	TONSCEND	v2.6	/	/

Radiated emission					
Item	Test Equipment	Manufacturer	Model No.	Serial No.	Calibrated until
1	Trilog-Broadband Antenna	Schwarzbeck	VULB 9168	9168-759	Nov. 09, 2022
2	Horn Antenna	Schwarzbeck	BBHA 9120D	9120D-647	Dec. 23, 2022
3	Test Receiver	Keysight	N9038A	MY56400071	Dec. 23, 2022
4	Broadband Premplifier	SCHWARZBECK	BBV9743B	259	Dec. 23, 2022
5	Mirowave Broadband Amplifier	SCHWARZBECK	BBV9718C	111	Dec. 23, 2022
6	3m chamber 3	YIHENG	EE106	/	Sep. 09, 2023

CTC Laboratories, Inc.

1-2/F., Building 2, Jiaquan Building, Guanlan High-Tech Park, Shenzhen, Guangdong, China
Tel.: (86)755-27521059 Fax: (86)755-27521011 Http://www.sz-ctc.org.cn



For anti-fake verification, please visit the official website of Certification and Accreditation Administration of the People's Republic of China : yz.cnca.cn



Conducted Emission					
Item	Test Equipment	Manufacturer	Model No.	Serial No.	Calibrated until
1	LISN	R&S	ENV216	101112	Dec. 23, 2022
2	LISN	R&S	ENV216	101113	Dec. 23, 2022
3	EMI Test Receiver	R&S	ESCS30	100353	Dec. 23, 2022
4	ISN CAT6	Schwarzbeck	NTFM 8158	CAT6-8158-0046	Dec. 23, 2022
5	ISN CAT5	Schwarzbeck	NTFM 8158	CAT5-8158-0046	Dec. 23, 2022

Note:

1. The Cal. Interval was one year.
2. The cable loss has calculated in test result which connection between each test instruments.

3. TEST ITEM AND RESULTS

3.1. Conducted Emission

Limit

FCC CFR Title 47 Part 15 Subpart C Section 15.207/ RSS - Gen 8.8

Frequency range (MHz)	Limit (dBuV)	
	Quasi-peak	Average
0.15-0.5	66 to 56*	56 to 46*
0.5-5	56	46
5-30	60	50

* Decreases with the logarithm of the frequency.

Test Configuration

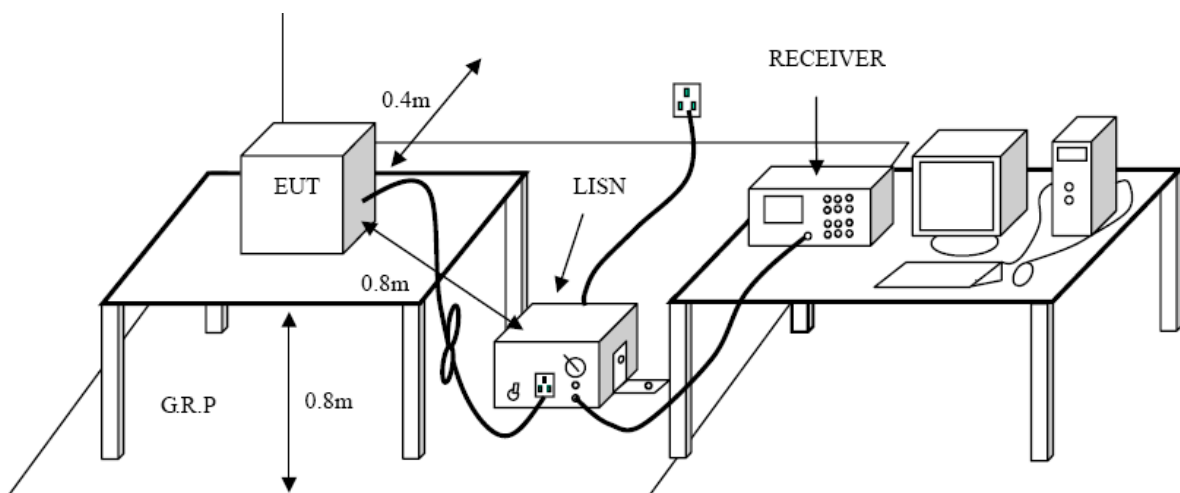

Test Procedure

1. The EUT was setup according to ANSI C63.10:2013 requirements.
2. The EUT was placed on a platform of nominal size, 1 m by 1.5 m, raised 80 cm above the conducting ground plane. The vertical conducting plane was located 40 cm to the rear of the EUT. All other surfaces of EUT were at least 80 cm from any other grounded conducting surface.
3. The EUT and simulators are connected to the main power through a line impedances stabilization network (LISN). The LISN provides a 50ohm /50uH coupling impedance for the measuring equipment. The peripheral devices are also connected to the main power through a LISN. (Please refer to the block diagram of the test setup and photographs)
4. Each current-carrying conductor of the EUT power cord, except the ground (safety) conductor, was individually connected through a LISN to the input power source.
5. The excess length of the power cord between the EUT and the LISN receptacle were folded back and forth at the center of the lead to form a bundle not exceeding 40 cm in length.
6. Conducted Emissions were investigated over the frequency range from 0.15MHz to 30MHz using a receiver bandwidth of 9 kHz.
7. During the above scans, the emissions were maximized by cable manipulation.



Test Mode

Please refer to the clause 2.4.

Test Results

Test Voltage:	AC 120V/60 Hz
Terminal:	Line

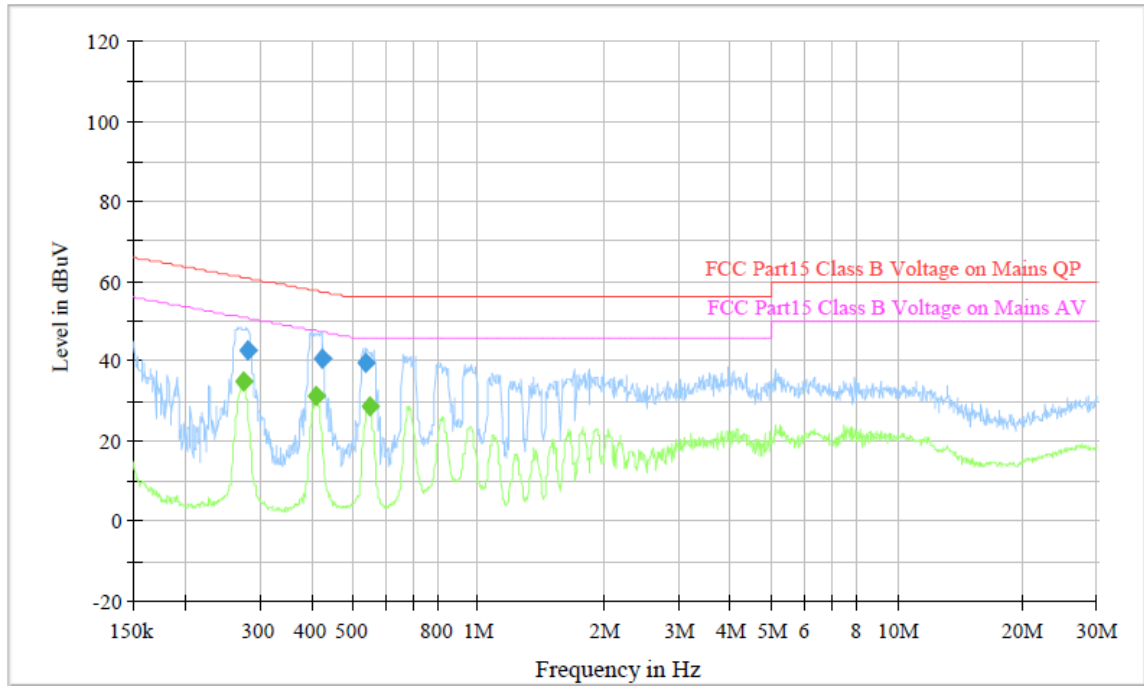

Final Measurement Detector 1

Frequency (MHz)	QuasiPeak (dB μV)	Meas. Time (ms)	Bandwidth (kHz)	Filter	Line	Corr. (dB)	Margin (dB)	Limit (dB μV)	Comment
0.281850	42.7	1000.00	9.000	On	L1	9.7	18.1	60.8	
0.421820	40.6	1000.00	9.000	On	L1	9.7	16.8	57.4	
0.540270	39.5	1000.00	9.000	On	L1	9.7	16.5	56.0	

Final Measurement Detector 2

Frequency (MHz)	Average (dB μV)	Meas. Time (ms)	Bandwidth (kHz)	Filter	Line	Corr. (dB)	Margin (dB)	Limit (dB μV)	Comment
0.272990	34.8	1000.00	9.000	On	L1	9.7	16.2	51.0	
0.408560	31.4	1000.00	9.000	On	L1	9.7	16.3	47.7	
0.548970	28.7	1000.00	9.000	On	L1	9.7	17.3	46.0	

Emission Level= Read Level+ Correct Factor



Test Voltage:	AC 120V/60 Hz
Terminal:	Neutral

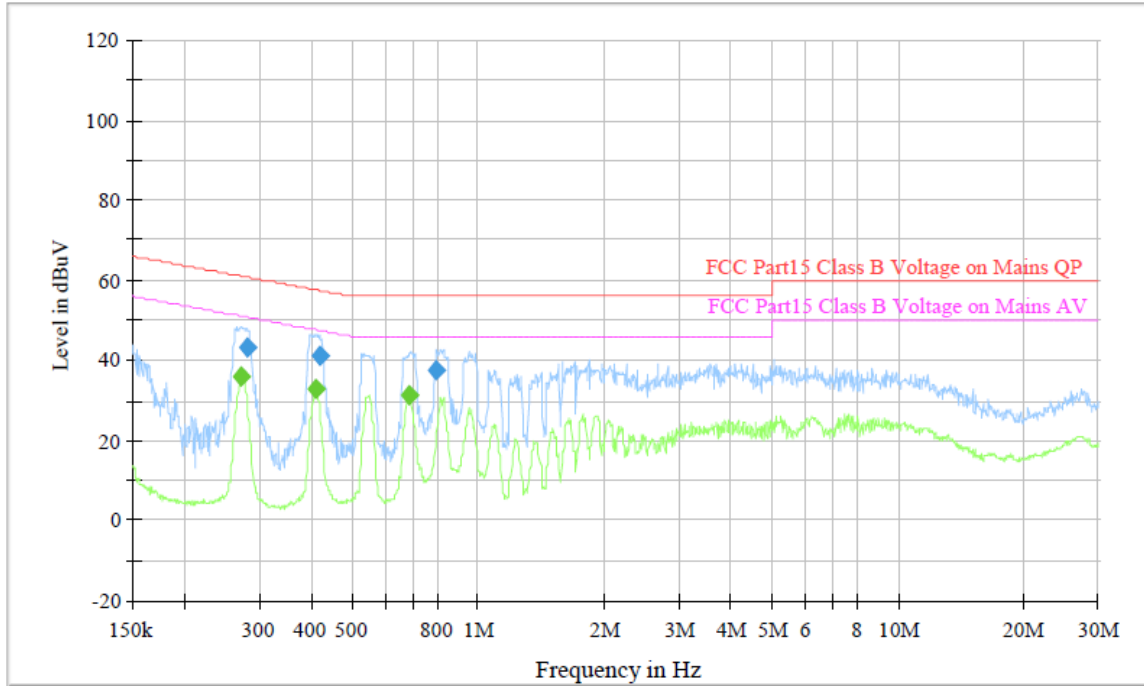

Final Measurement Detector 1

Frequency (MHz)	QuasiPeak (dB μ V)	Meas. Time (ms)	Bandwidth (kHz)	Filter	Line	Corr. (dB)	Margin (dB)	Limit (dB μ V)	Comment
0.280730	43.5	1000.00	9.000	On	N	10.0	17.3	60.8	
0.418460	41.0	1000.00	9.000	On	N	10.0	16.5	57.5	
0.792590	37.5	1000.00	9.000	On	N	10.0	18.5	56.0	

Final Measurement Detector 2

Frequency (MHz)	Average (dB μ V)	Meas. Time (ms)	Bandwidth (kHz)	Filter	Line	Corr. (dB)	Margin (dB)	Limit (dB μ V)	Comment
0.271900	35.8	1000.00	9.000	On	N	10.0	15.3	51.1	
0.408560	33.1	1000.00	9.000	On	N	10.0	14.6	47.7	
0.686490	31.3	1000.00	9.000	On	N	10.0	14.7	46.0	

Emission Level= Read Level+ Correct Factor

3.2. 20 dB Occupied Bandwidth

Limit

Operation frequency range 2400MHz~2483.5MHz.

Test Configuration

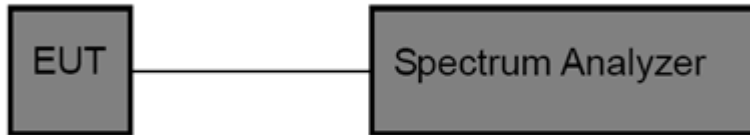

Test Procedure

1. The transmitter output was connected to the spectrum analyzer through an attenuator, the path loss was compensated to the results for each measurement.
2. Set to the maximum power setting and enable the EUT transmit continuously
3. Use the following spectrum analyzer settings:
Span = approximately 2 to 3 times the 20 dB bandwidth, centered on a test channel
RBW \geq 1% of the 20 dB bandwidth, VBW \geq RBW
Sweep = auto, Detector function = peak, Trace = max hold
4. Measure and record the results in the test report.

Test Mode

Please refer to the clause 2.4

Test Results

Channel	20dB Bandwidth (MHz)	99% Bandwidth (MHz)	Result
01	1.389	1.212	Pass
39	1.447	1.231	Pass
79	1.447	1.231	Pass



20dB Bandwidth:

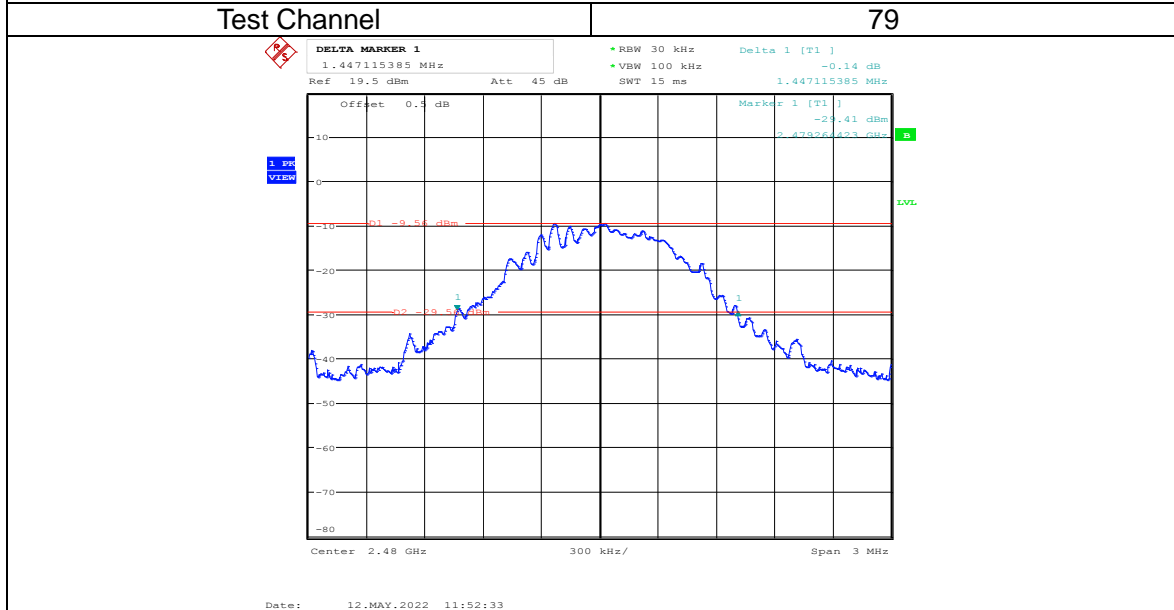
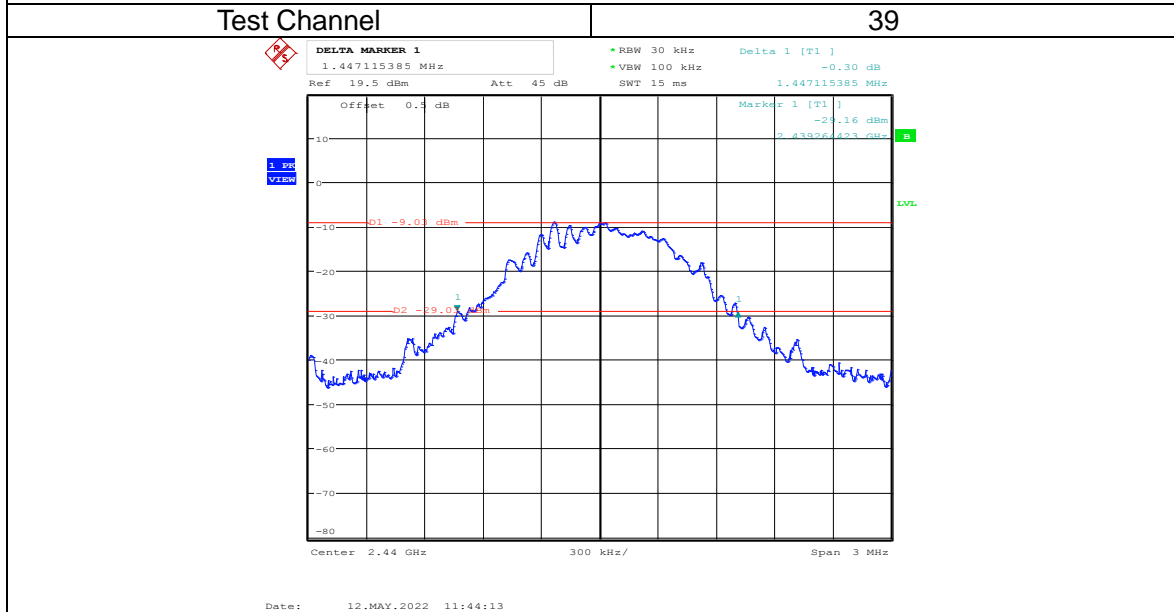
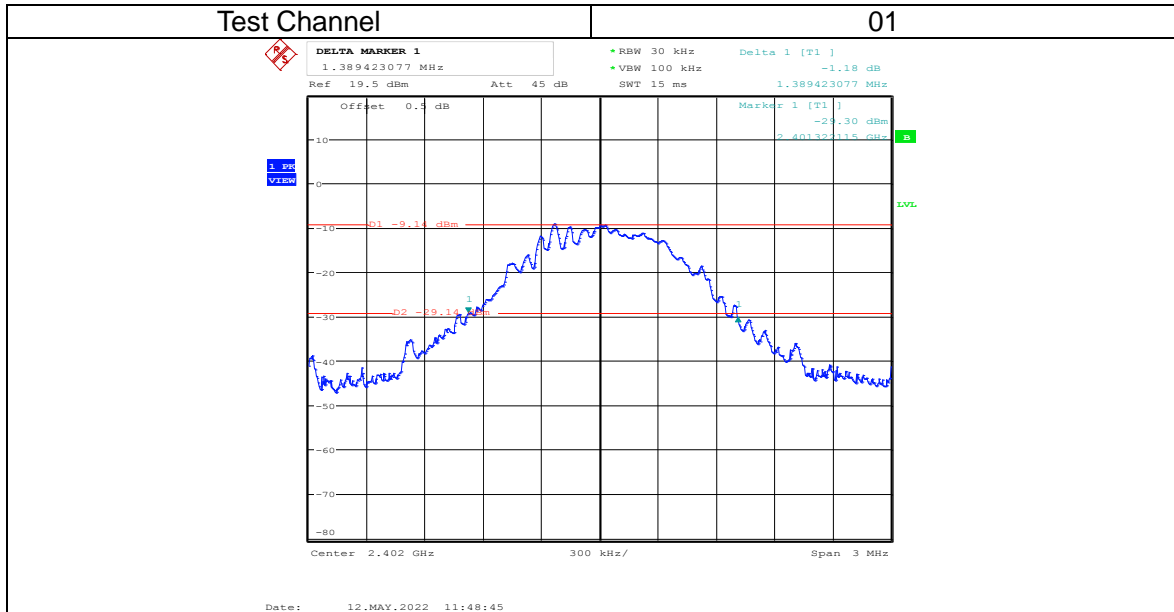



99% Bandwidth:

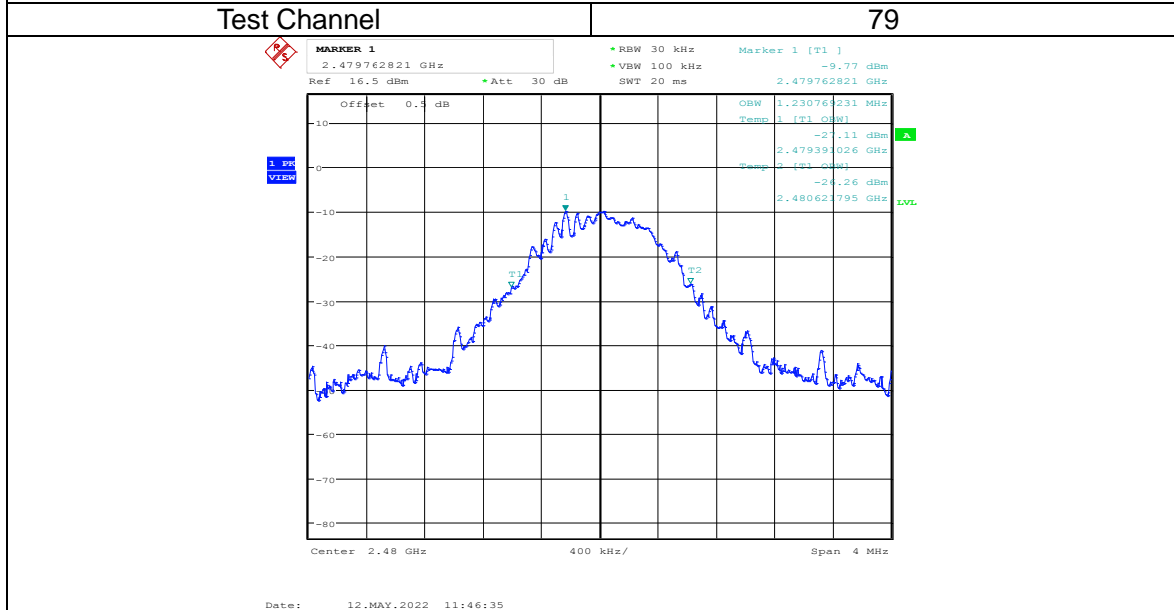
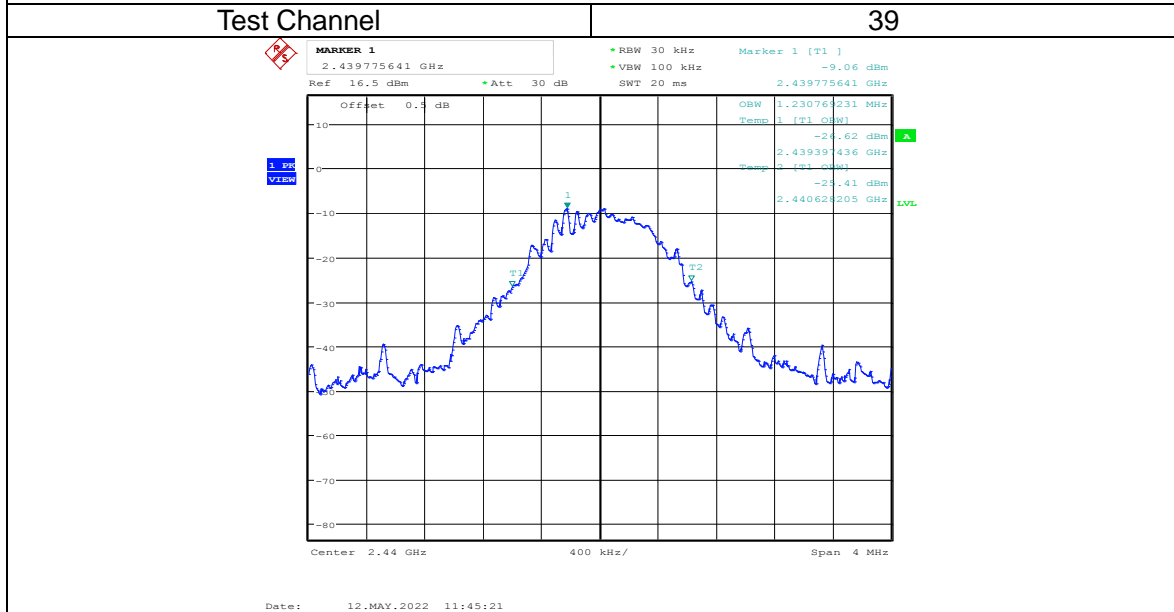
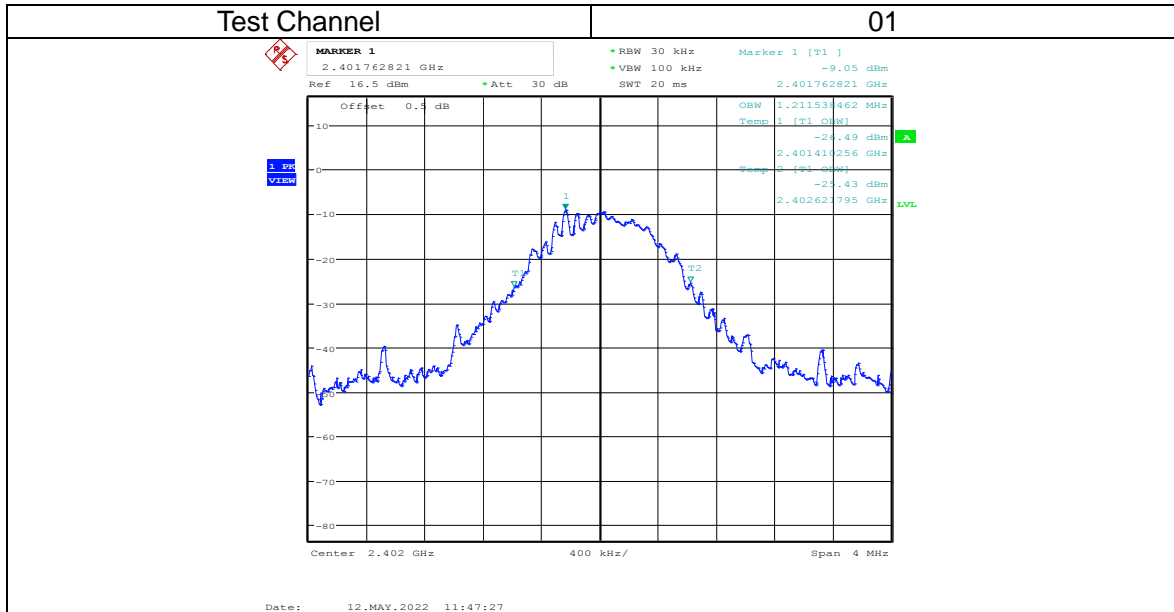

3.3. Radiated field strength of the fundamental signal

Limit

FCC CFR Title 47 Part 15 Subpart C Section 15.249(a)/ RSS – 210 F.1.a

Fundamental frequency	Field strength of fundamental (millivolts/meter/ AVG)	Field strength of harmonics (microvolts/meter/ AVG)
902-928 MHz	50 (94dBuV/m @3m)	500 (54dBuV/m @3m)
2400-2483.5 MHz	50 (94dBuV/m @3m)	500 (54dBuV/m @3m)
5725-5875 MHz	50 (94dBuV/m @3m)	500 (54dBuV/m @3m)
24.0-24.25 GHz	250 (108dBuV/m @3m)	2500 (68dBuV/m @3m)

Frequencies above 1000 MHz, the field strength limits are based on average limits

Test Configuration

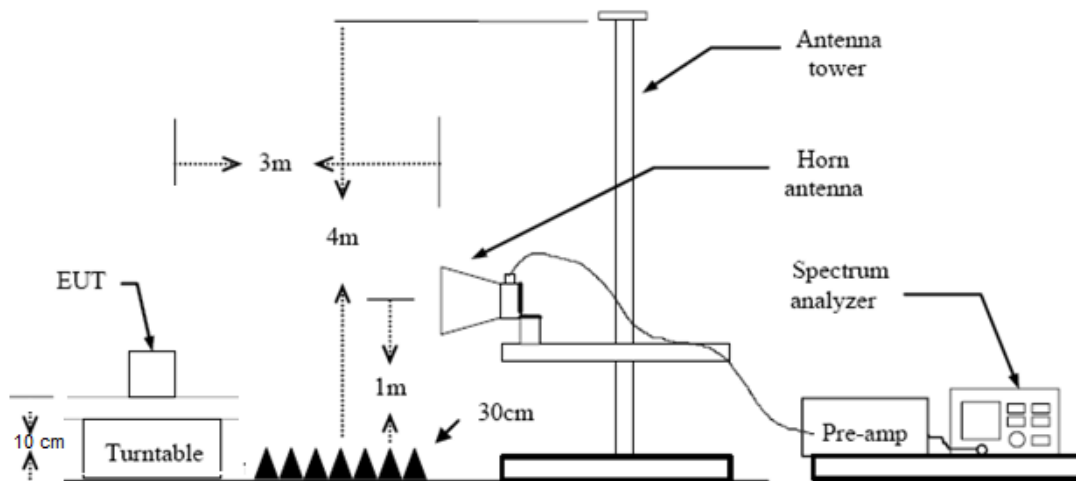

Test Procedure

1. The EUT was setup and tested according to ANSI C63.10:2013 requirements.
2. The EUT is placed on a turn table which is 0.1 meter above ground. The turn table is rotated 360 degrees to determine the position of the maximum emission level.
3. The EUT was positioned such that the distance from antenna to the EUT was 3 meters.
4. The antenna is scanned from 1 meter to 4 meters to find out the maximum emission level. This is repeated for both horizontal and vertical polarization of the antenna. In order to find the maximum emission, all of the interface cables were manipulated according to ANSI C63.10:2013 on radiated measurement.
5. The receiver set as follow:
RBW=1MHz, VBW=3MHz Peak detector for Peak value.

Test Mode

Please refer to the clause 2.4

Test Results

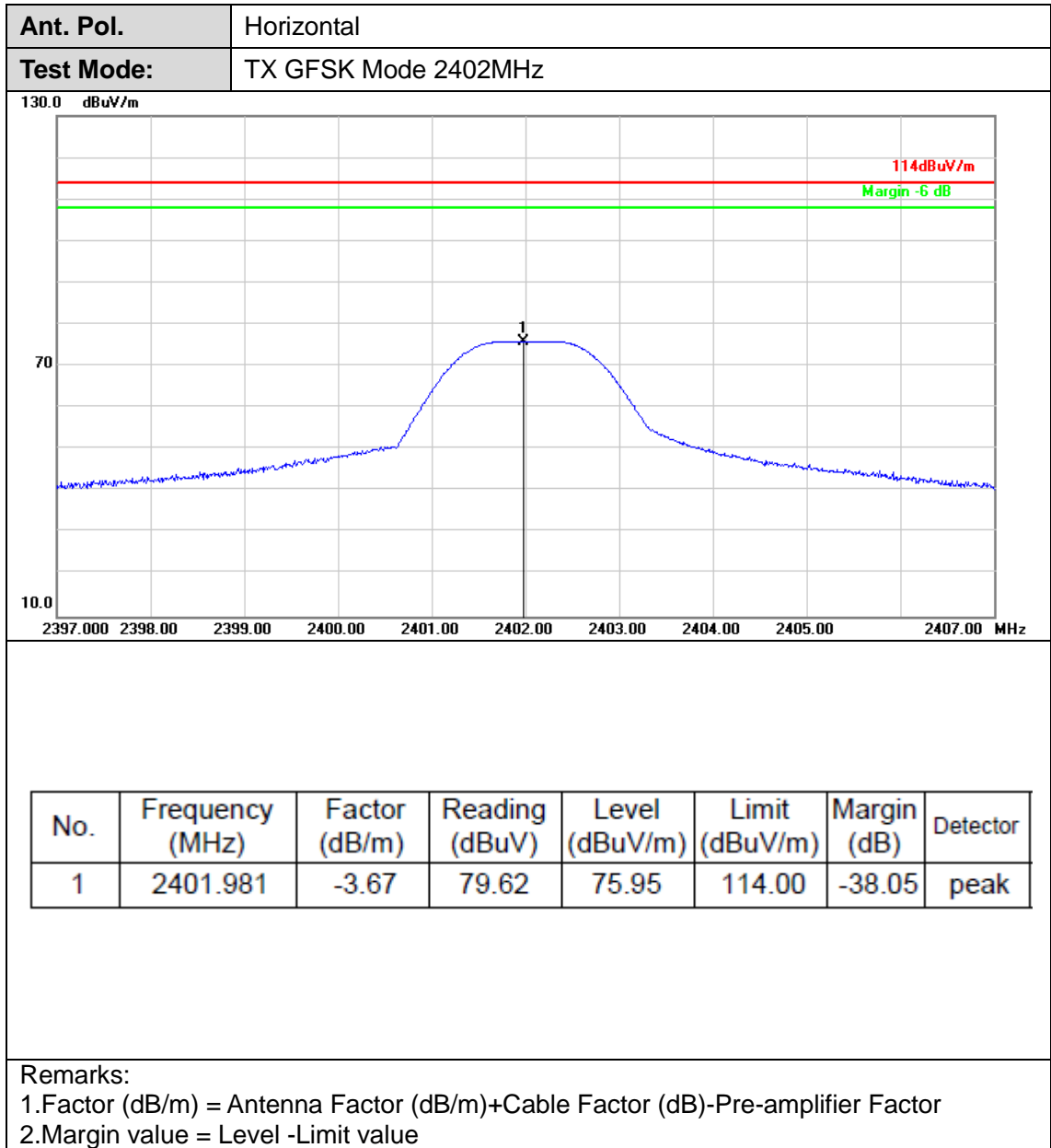

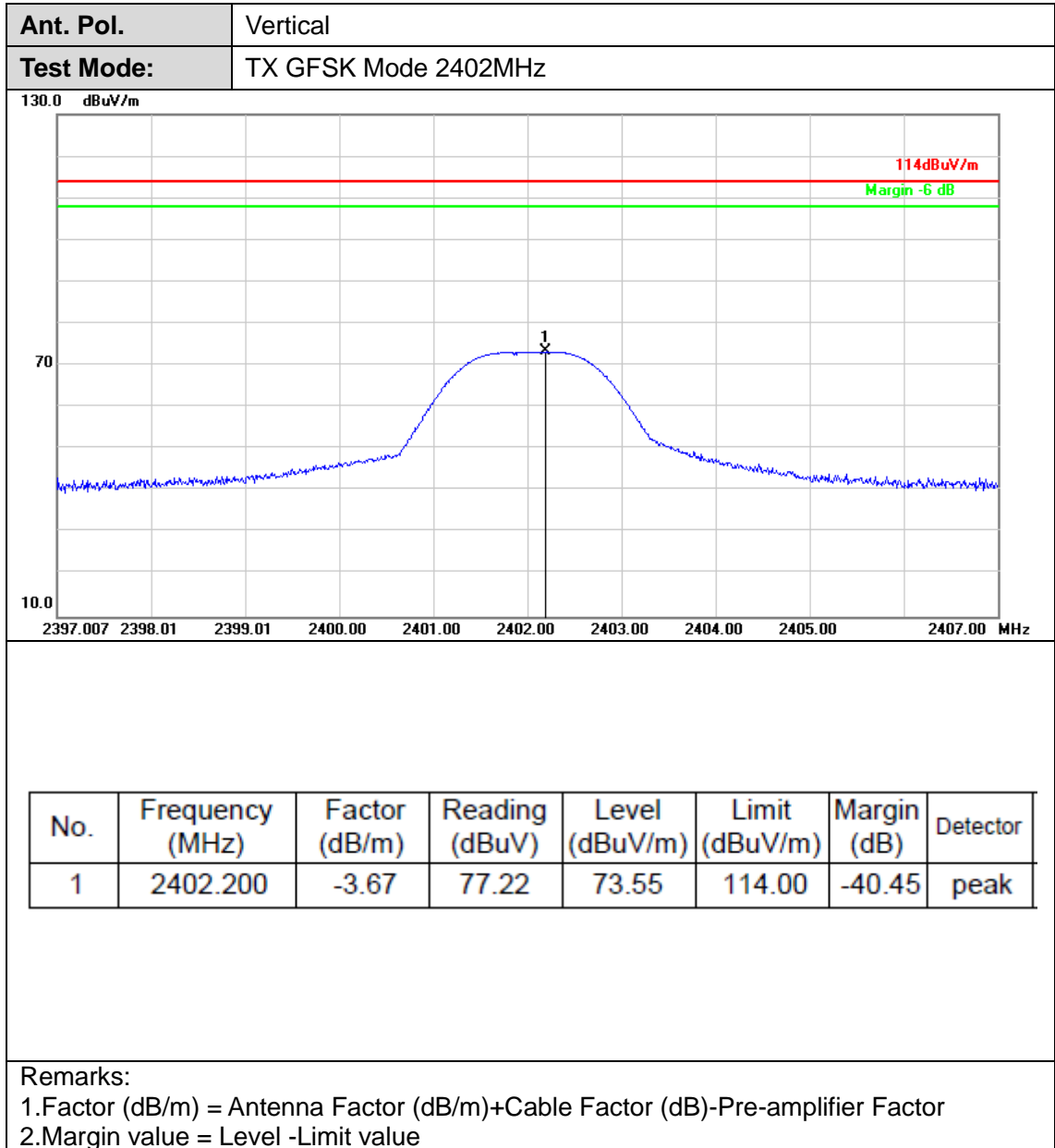



Ant. Pol.	Horizontal
Test Mode:	TX GFSK Mode 2440MHz

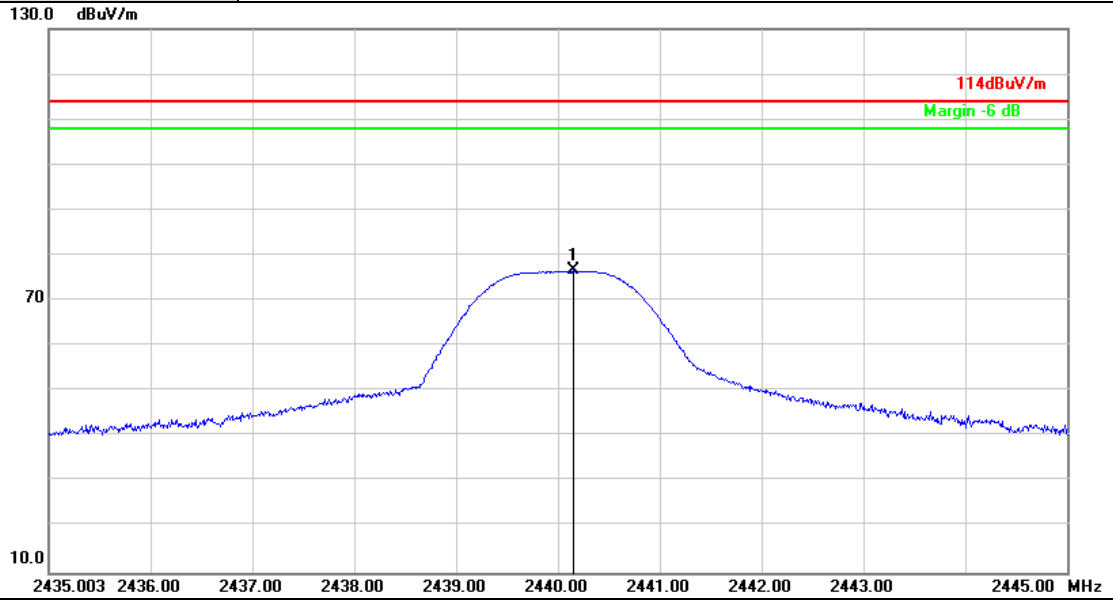

No.	Frequency (MHz)	Factor (dB/m)	Reading (dBuV)	Level (dBuV/m)	Limit (dBuV/m)	Margin (dB)	Detector
1	2440.160	-3.50	80.31	76.81	114.00	-37.19	peak

Remarks:
 1. Factor (dB/m) = Antenna Factor (dB/m)+Cable Factor (dB)-Pre-amplifier Factor
 2. Margin value = Level -Limit value

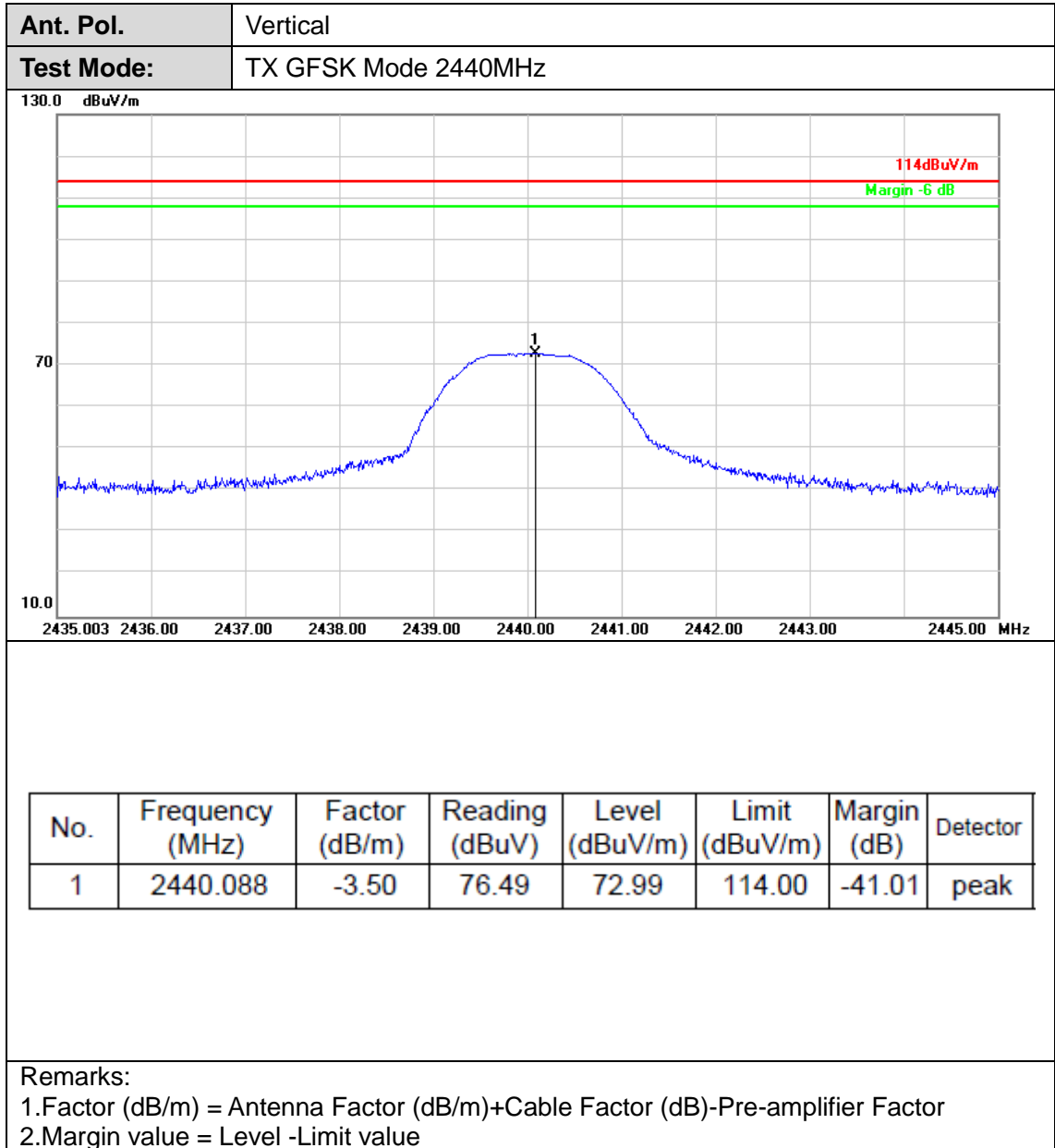



Ant. Pol.	Horizontal
Test Mode:	TX GFSK Mode 2480MHz

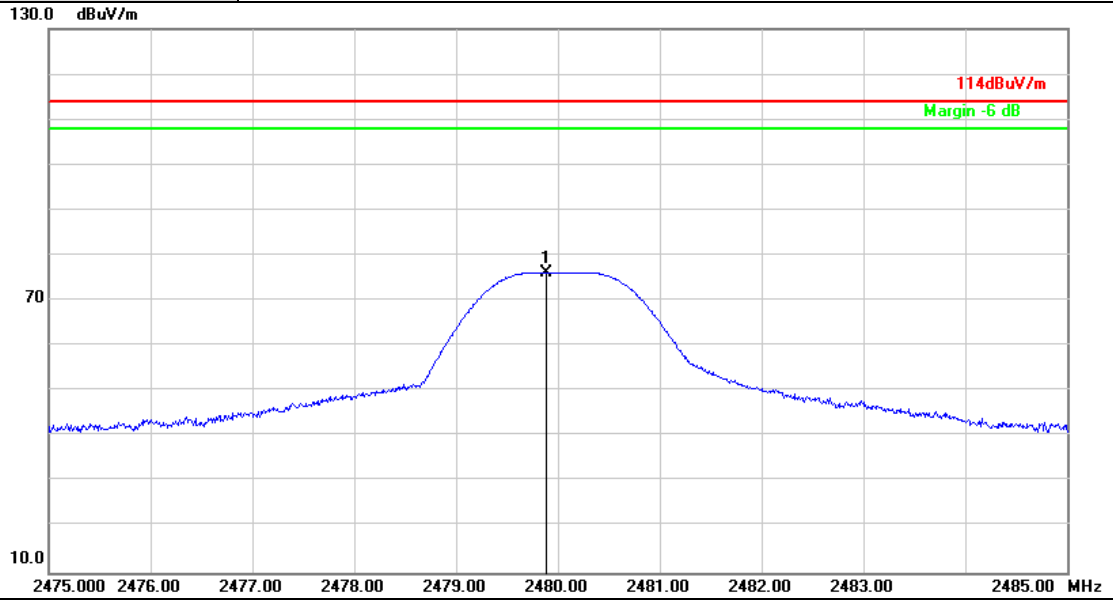

No.	Frequency (MHz)	Factor (dB/m)	Reading (dBuV)	Level (dBuV/m)	Limit (dBuV/m)	Margin (dB)	Detector
1	2479.891	-3.33	79.59	76.26	114.00	-37.74	peak

Remarks:
 1. Factor (dB/m) = Antenna Factor (dB/m)+Cable Factor (dB)-Pre-amplifier Factor
 2. Margin value = Level -Limit value

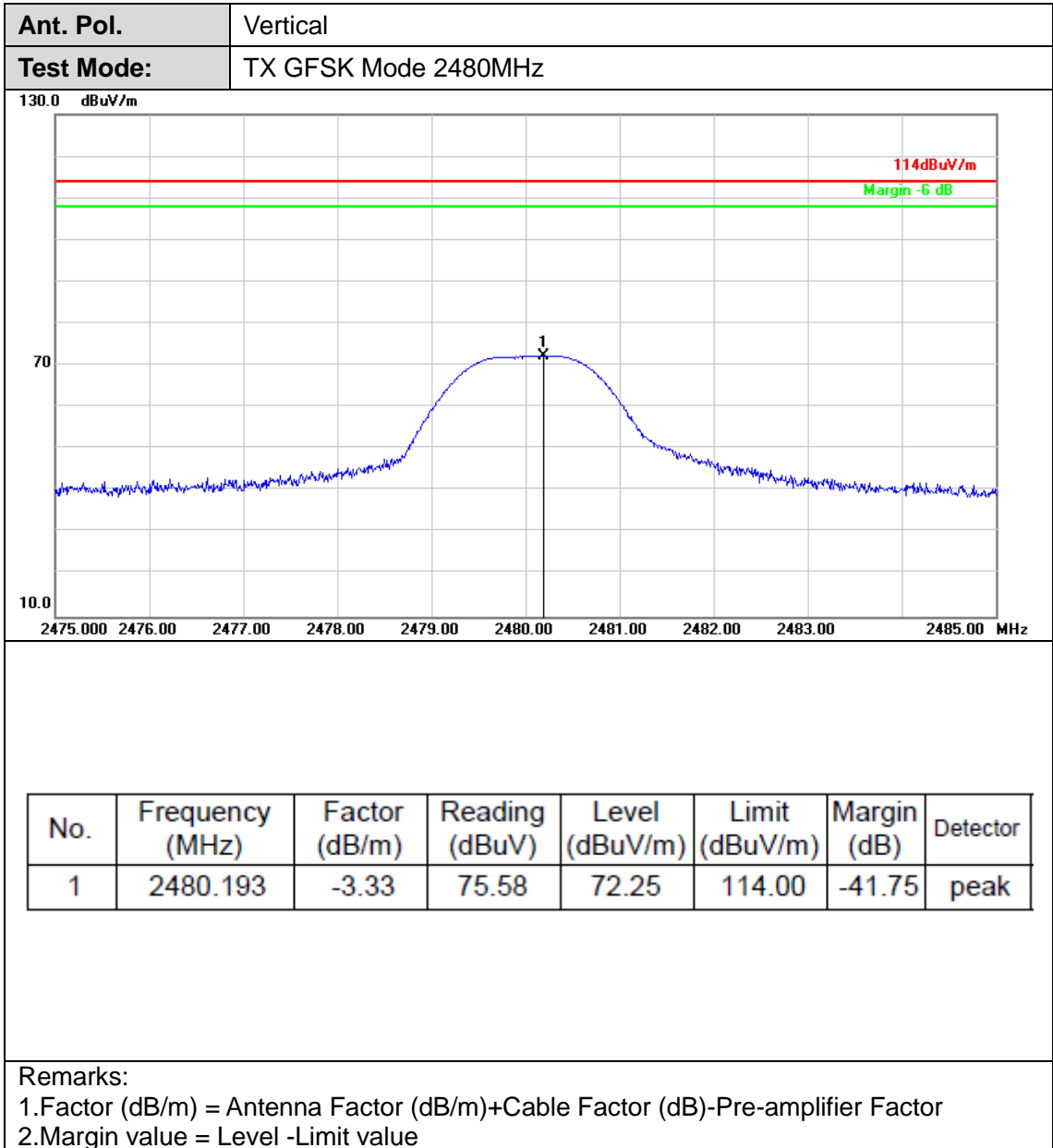



3.4. Radiated Spurious Emissions and Bandedge Emission

Limit

FCC CFR Title 47 Part 15 Subpart C Section 15.209&15.249(a)/ RSS – 210 F.1.e

Frequency (MHz)	Field Strength (microvolts/meter)	Measurement Distance (meters)
0.009~0.490	2400/F(KHz)	300
0.490~1.705	24000/F(KHz)	30
1.705~30.0	30	30
30~88	100	3
88~216	150	3
216~960	200	3
960~1000	500	3

Frequency (MHz)	dB(uV/m) (at 3 meters)	
	Peak	Average
Above 1000	74	54

Note:

- (1) The tighter limit applies at the band edges.
- (2) Emission Level (dBuV/m)=20log Emission Level (uV/m).

Test Configuration

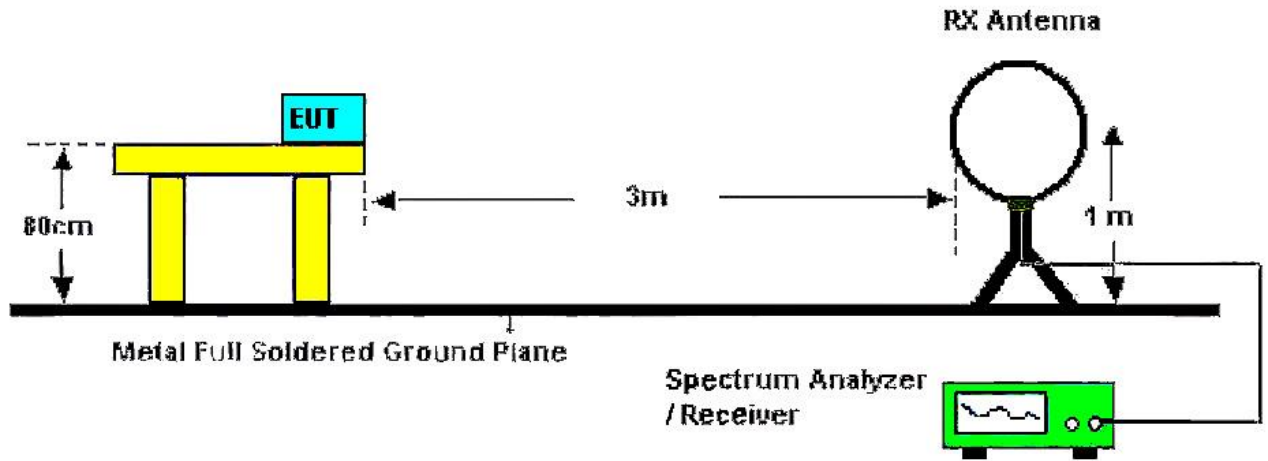

Below 30MHz Test Setup

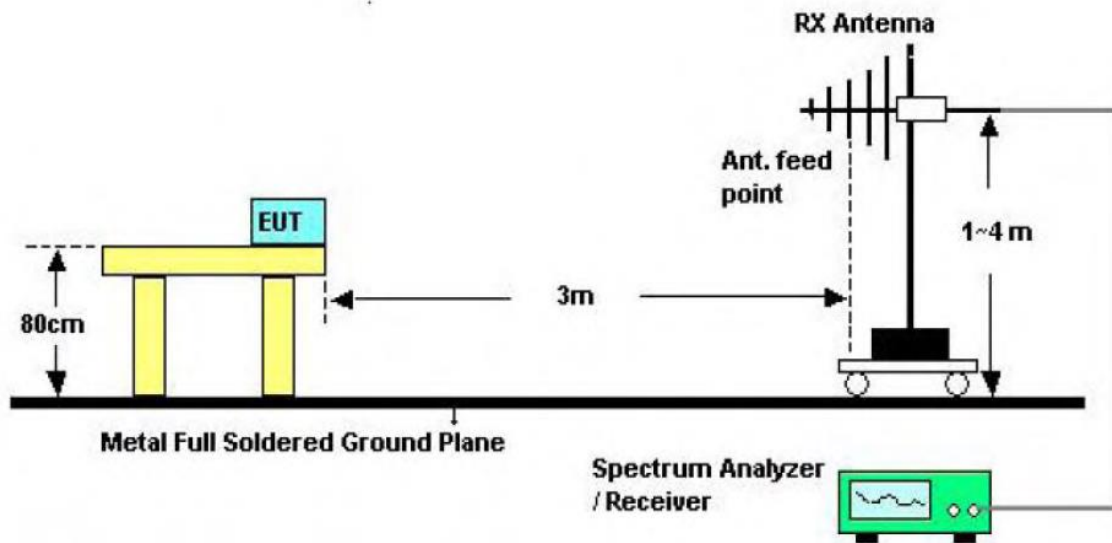

30-1000MHz Test Setup

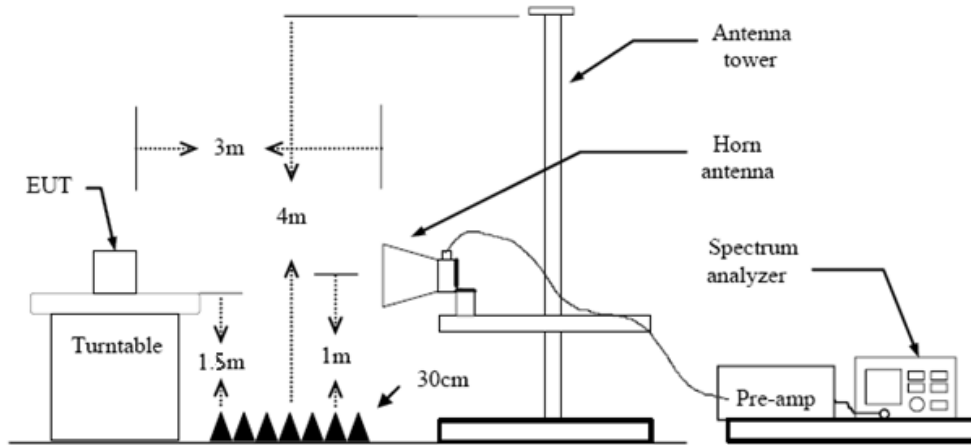

Above 1GHz Test Setup

Test Procedure

1. The EUT was setup and tested according to ANSI C63.10:2013
2. The EUT is placed on a turn table which is 0.8 meter above ground for below 1 GHz, and 1.5 m for above 1 GHz. The turn table is rotated 360 degrees to determine the position of the maximum emission level.
3. The EUT was set 3 meters from the receiving antenna, which was mounted on the top of a variable height antenna tower.
4. For each suspected emission, the EUT was arranged to its worst case and then tune the Antenna tower (from 1 m to 4 m) and turntable (from 0 degree to 360 degrees) to find the maximum reading. A pre-amp and a high pass filter are used for the test in order to get better signal level to comply with the guidelines.
5. Set to the maximum power setting and enable the EUT transmit continuously.
6. Use the following spectrum analyzer settings
 - (1) Span shall wide enough to fully capture the emission being measured;
 - (2) Below 1 GHz:
RBW=120 kHz, VBW=300 kHz, Sweep=auto, Detector function=peak, Trace=max hold;
If the emission level of the EUT measured by the peak detector is 3 dB lower than the applicable limit, the peak emission level will be reported. Otherwise, the emission measurement will be repeated using the quasi-peak detector and reported.
 - (3) From 1 GHz to 10th harmonic:
RBW=1MHz, VBW=3MHz Peak detector for Peak value.
RBW=1MHz, VBW=10Hz with Peak Detector for Average Value.

Test Mode

Please refer to the clause 2.4.

Test Result

9 KHz~30 MHz

From 9 KHz to 30 MHz: Conclusion: PASS

Note: The amplitude of spurious emissions which are attenuated by more than 20dB below the permissible value has no need to be reported.



30MHz-1GHz

Ant. Pol.	Horizontal
Test Mode:	TX GFSK Mode 2402MHz
Remark:	Only worse case is reported

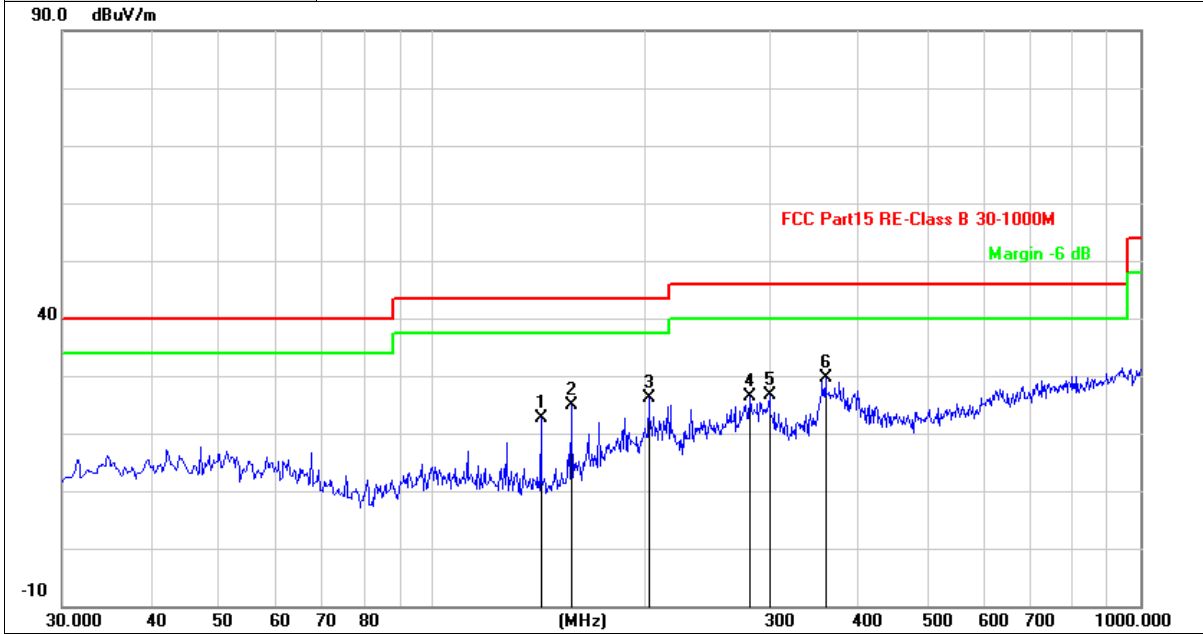

No.	Frequency (MHz)	Factor (dB/m)	Reading (dBuV)	Level (dBuV/m)	Limit (dBuV/m)	Margin (dB)	Detector
1	142.5200	-19.89	42.50	22.61	43.50	-20.89	QP
2	157.3933	-19.31	44.29	24.98	43.50	-18.52	QP
3	202.6600	-15.99	42.00	26.01	43.50	-17.49	QP
4	281.5532	-13.95	40.34	26.39	46.00	-19.61	QP
5	300.3067	-13.53	40.10	26.57	46.00	-19.43	QP
6	360.1233	-12.05	41.71	29.66	46.00	-16.34	QP

Remarks:

- 1. Factor (dB/m) = Antenna Factor (dB/m)+Cable Factor (dB)-Pre-amplifier Factor
- 2. Margin value = Level -Limit value



Ant. Pol.	Vertical
Test Mode:	TX GFSK Mode 2402MHz
Remark:	Only worse case is reported

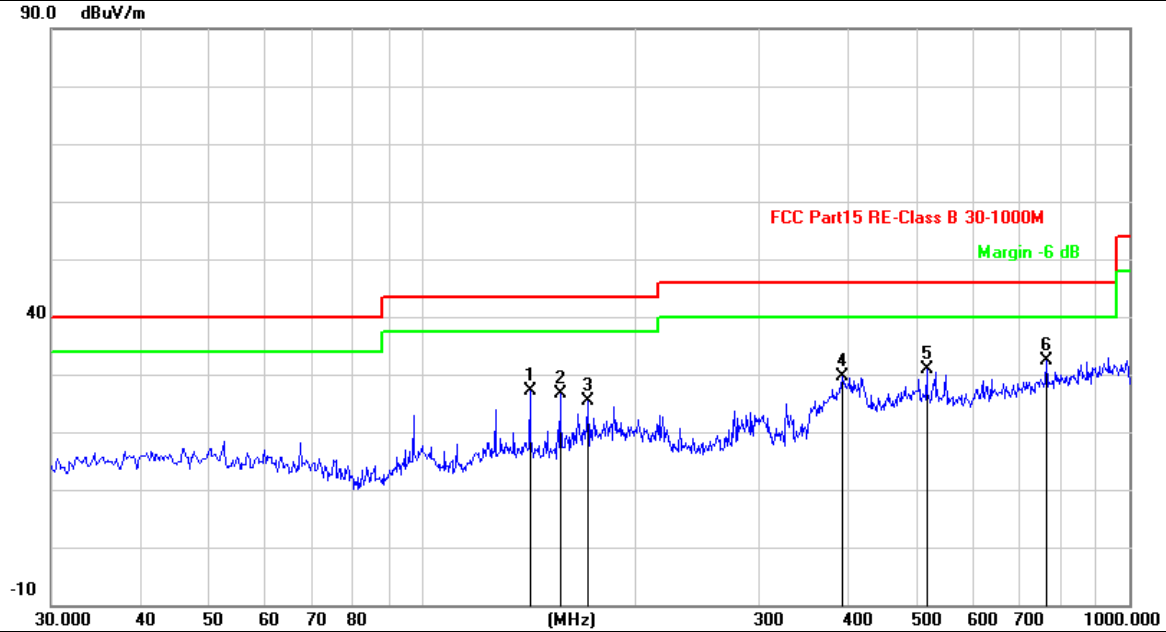

No.	Frequency (MHz)	Factor (dB/m)	Reading (dBuV)	Level (dBuV/m)	Limit (dBuV/m)	Margin (dB)	Detector
1	142.5200	-19.89	46.92	27.03	43.50	-16.47	QP
2	157.3933	-19.31	45.83	26.52	43.50	-16.98	QP
3	172.5900	-18.48	43.76	25.28	43.50	-18.22	QP
4	394.0733	-11.21	40.76	29.55	46.00	-16.45	QP
5	517.5866	-8.75	39.63	30.88	46.00	-15.12	QP
6	765.2600	-4.60	37.07	32.47	46.00	-13.53	QP

Remarks:

- Factor (dB/m) = Antenna Factor (dB/m)+Cable Factor (dB)-Pre-amplifier Factor
- Margin value = Level -Limit value



Above 1GHz

Ant. Pol.	Horizontal
Test Mode:	TX GFSK Mode 2402MHz
Remark:	No report for the emission which more than 20 dB below the prescribed limit.

No.	Frequency (MHz)	Factor (dB/m)	Reading (dBuV)	Level (dBuV/m)	Limit (dBuV/m)	Margin (dB)	Detector
1	4804.310	2.16	30.04	32.20	54.00	-21.80	AVG
2	4804.312	2.16	41.35	43.51	74.00	-30.49	peak

Remarks:

- 1.Factor (dB/m) = Antenna Factor (dB/m)+Cable Factor (dB)-Pre-amplifier Factor
- 2.Margin value = Level -Limit value

Ant. Pol.	Vertical
Test Mode:	TX GFSK Mode 2402MHz
Remark:	No report for the emission which more than 20 dB below the prescribed limit.

No.	Frequency (MHz)	Factor (dB/m)	Reading (dBuV)	Level (dBuV/m)	Limit (dBuV/m)	Margin (dB)	Detector
1	4803.860	2.16	29.45	31.61	54.00	-22.39	AVG
2	4804.092	2.16	42.24	44.40	74.00	-29.60	peak

Remarks:

- 1.Factor (dB/m) = Antenna Factor (dB/m)+Cable Factor (dB)-Pre-amplifier Factor
- 2.Margin value = Level -Limit value



Ant. Pol.	Horizontal
Test Mode:	TX GFSK Mode 2440MHz
Remark:	No report for the emission which more than 20 dB below the prescribed limit.

No.	Frequency (MHz)	Factor (dB/m)	Reading (dBuV)	Level (dBuV/m)	Limit (dBuV/m)	Margin (dB)	Detector
1	4880.090	2.31	28.99	31.30	54.00	-22.70	AVG
2	4880.202	2.31	40.75	43.06	74.00	-30.94	peak

Remarks:

- 1.Factor (dB/m) = Antenna Factor (dB/m)+Cable Factor (dB)-Pre-amplifier Factor
- 2.Margin value = Level -Limit value

Ant. Pol.	Vertical
Test Mode:	TX GFSK Mode 2440MHz
Remark:	No report for the emission which more than 20 dB below the prescribed limit.

No.	Frequency (MHz)	Factor (dB/m)	Reading (dBuV)	Level (dBuV/m)	Limit (dBuV/m)	Margin (dB)	Detector
1	4880.110	2.31	40.74	43.05	74.00	-30.95	peak
2	4880.125	2.31	28.68	30.99	54.00	-23.01	AVG

Remarks:

- 1.Factor (dB/m) = Antenna Factor (dB/m)+Cable Factor (dB)-Pre-amplifier Factor
- 2.Margin value = Level -Limit value



Ant. Pol.	Horizontal
Test Mode:	TX GFSK Mode 2480MHz
Remark:	No report for the emission which more than 20 dB below the prescribed limit.

No.	Frequency (MHz)	Factor (dB/m)	Reading (dBuV)	Level (dBuV/m)	Limit (dBuV/m)	Margin (dB)	Detector
1	4959.974	2.48	29.26	31.74	54.00	-22.26	AVG
2	4960.001	2.48	41.47	43.95	74.00	-30.05	peak

Remarks:

- 1.Factor (dB/m) = Antenna Factor (dB/m)+Cable Factor (dB)-Pre-amplifier Factor
- 2.Margin value = Level -Limit value

Ant. Pol.	Vertical
Test Mode:	TX GFSK Mode 2480MHz
Remark:	No report for the emission which more than 20 dB below the prescribed limit.

No.	Frequency (MHz)	Factor (dB/m)	Reading (dBuV)	Level (dBuV/m)	Limit (dBuV/m)	Margin (dB)	Detector
1	4960.130	2.48	40.65	43.13	74.00	-30.87	peak
2	4960.200	2.48	28.65	31.13	54.00	-22.87	AVG

Remarks:

- 1.Factor (dB/m) = Antenna Factor (dB/m)+Cable Factor (dB)-Pre-amplifier Factor
- 2.Margin value = Level -Limit value

3.5. Band Edge Emissions (Radiated)

Limit

FCC CFR Title 47 Part 15 Subpart C Section 15.205&15.249(d)

Restricted Frequency Band (MHz)	(dBuV/m)(at 3m)	
	Peak	Average
2310 ~ 2390	74	54
2483.5 ~ 2500	74	54

Conducted band edge limit: The highest point of the operating frequency waveform down 20dB

Test Configuration

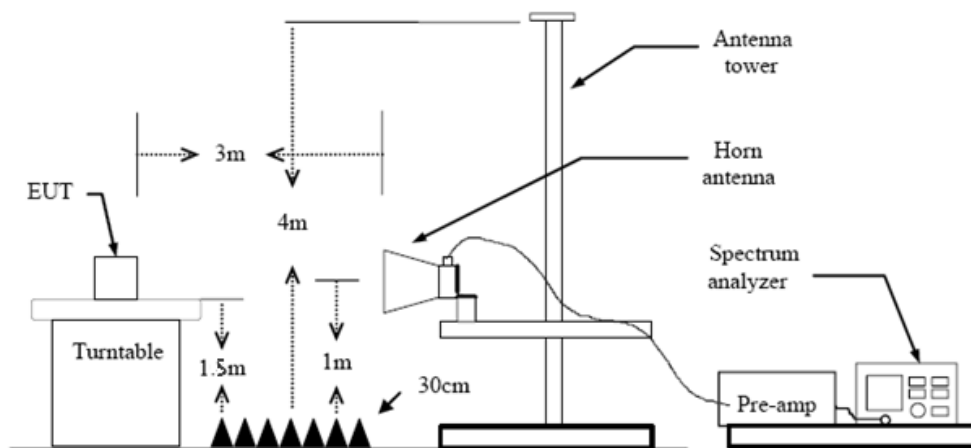

Test Procedure

1. The EUT was setup and tested according to ANSI C63.10:2013 requirements.
2. The EUT is placed on a turn table which is 1.5 meter above ground. The turn table is rotated 360 degrees to determine the position of the maximum emission level.
3. The EUT was positioned such that the distance from antenna to the EUT was 3 meters.
4. The antenna is scanned from 1 meter to 4 meters to find out the maximum emission level. This is repeated for both horizontal and vertical polarization of the antenna. In order to find the maximum emission, all of the interface cables were manipulated according to ANSI C63.10:2013 on radiated measurement.
5. The receiver set as follow:
 RBW=1MHz, VBW=3MHz Peak detector for Peak value.
 RBW=1MHz, VBW see note 1 with Peak Detector for Average Value.

Note 1: For measurements above 1 GHz the resolution bandwidth is set to 1 MHz, then the video bandwidth is set to 3 MHz for peak measurements and 1 MHz resolution bandwidth with 1/T video bandwidth with peak detector for average measurements.

Test Mode

Please refer to the clause 2.4.

Test Results



Ant. Pol.	Horizontal
Test Mode:	TX GFSK Mode 2402MHz

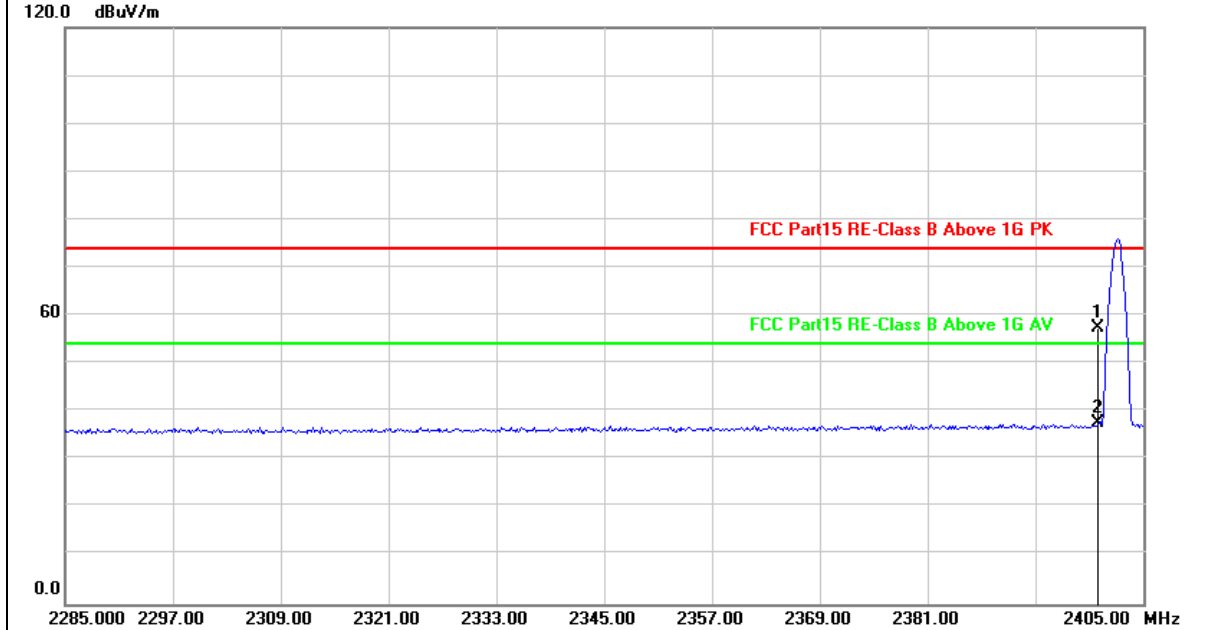

No.	Frequency (MHz)	Factor (dB/m)	Reading (dBuV)	Level (dBuV/m)	Limit (dBuV/m)	Margin (dB)	Detector
1	2400.000	30.88	26.53	57.41	74.00	-16.59	peak
2	2400.000	30.88	6.75	37.63	54.00	-16.37	AVG

Remarks:

- 1. Factor (dB/m) = Antenna Factor (dB/m)+Cable Factor (dB)-Pre-amplifier Factor
- 2. Margin value = Level -Limit value



Ant. Pol.	Vertical
Test Mode:	TX GFSK Mode 2402MHz

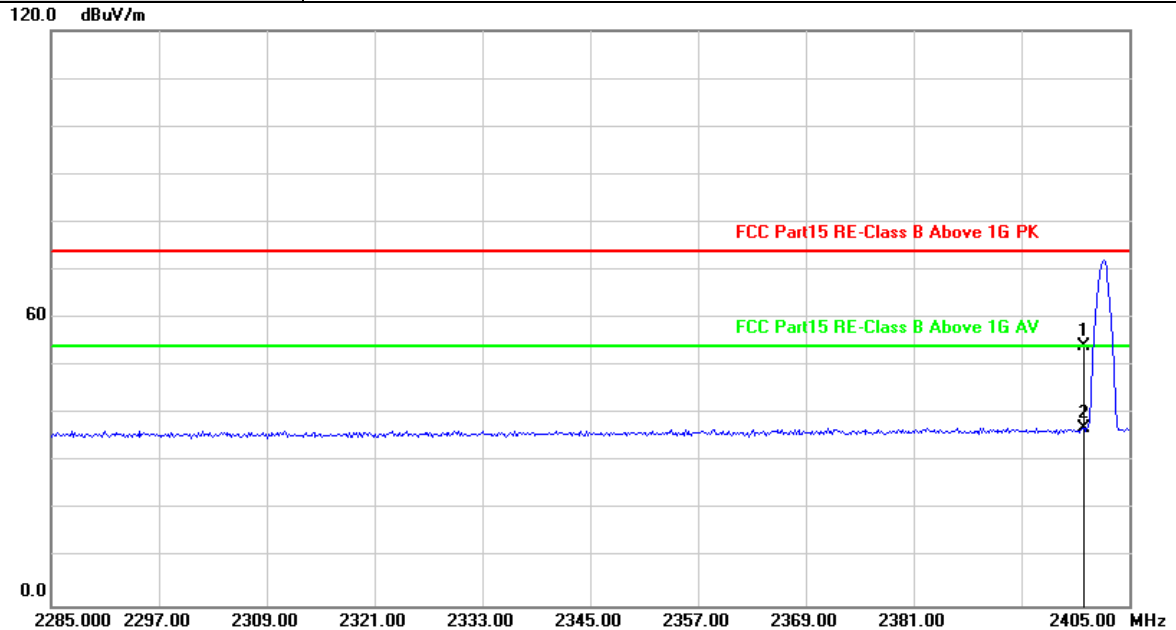

No.	Frequency (MHz)	Factor (dB/m)	Reading (dBuV)	Level (dBuV/m)	Limit (dBuV/m)	Margin (dB)	Detector
1	2400.000	30.88	23.26	54.14	74.00	-19.86	peak
2	2400.000	30.88	6.09	36.97	54.00	-17.03	AVG

Remarks:

- 1. Factor (dB/m) = Antenna Factor (dB/m)+Cable Factor (dB)-Pre-amplifier Factor
- 2. Margin value = Level -Limit value



Ant. Pol.	Horizontal
Test Mode:	TX GFSK Mode 2480MHz

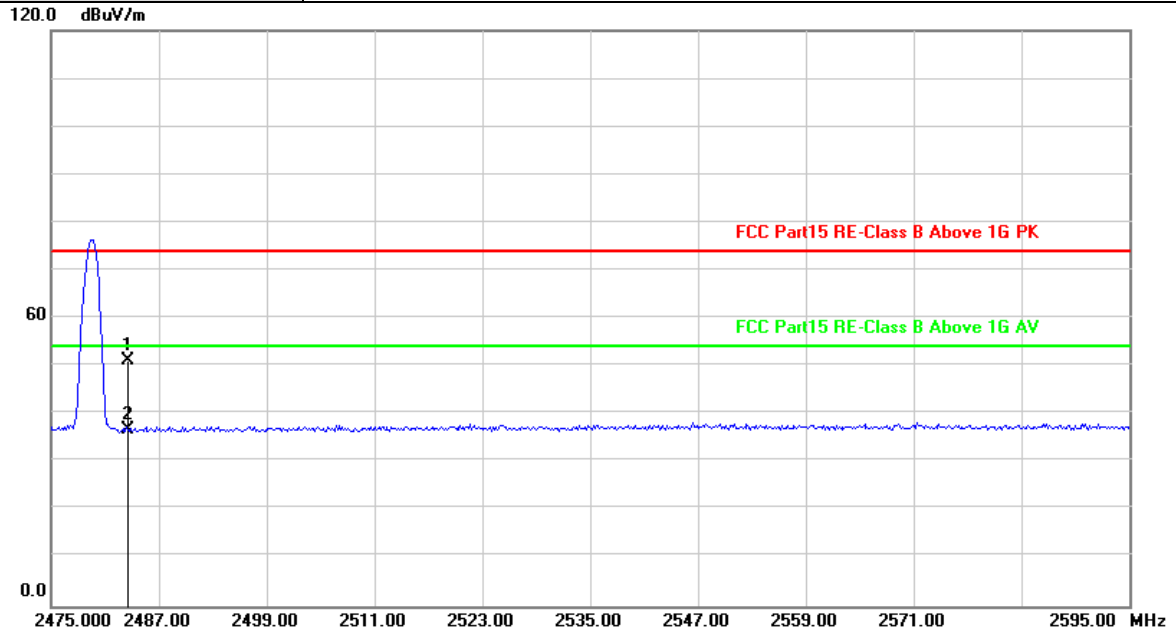

No.	Frequency (MHz)	Factor (dB/m)	Reading (dBuV)	Level (dBuV/m)	Limit (dBuV/m)	Margin (dB)	Detector
1	2483.500	31.24	19.91	51.15	74.00	-22.85	peak
2	2483.500	31.24	5.45	36.69	54.00	-17.31	AVG

Remarks:

- 1. Factor (dB/m) = Antenna Factor (dB/m)+Cable Factor (dB)-Pre-amplifier Factor
- 2. Margin value = Level -Limit value



Ant. Pol.	Vertical
Test Mode:	TX GFSK Mode 2480MHz

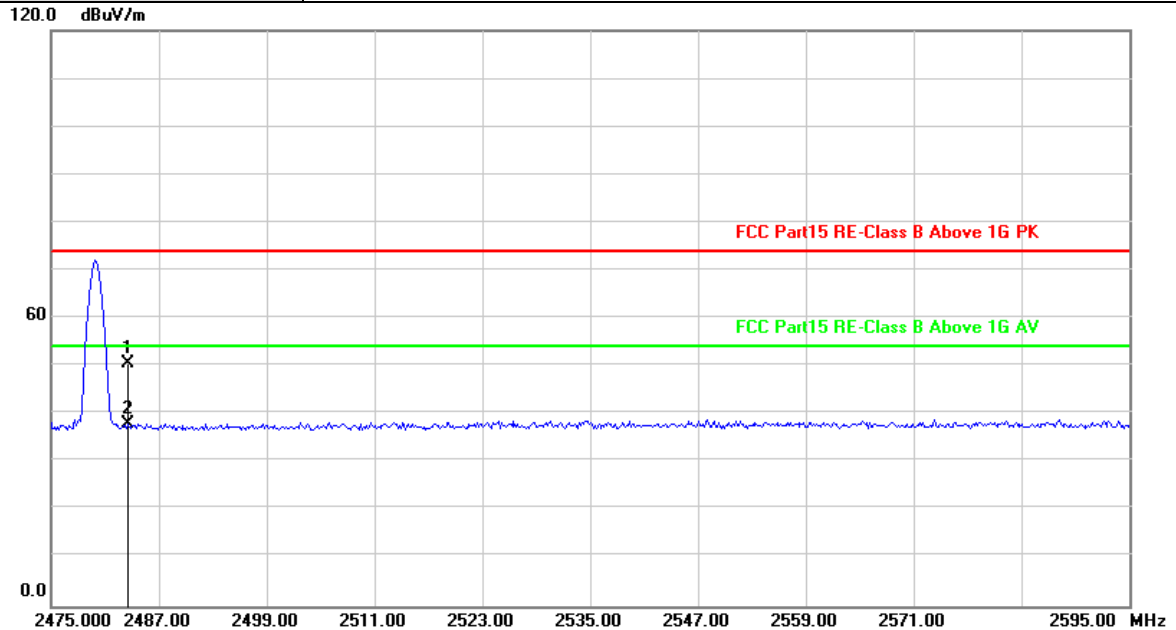

No.	Frequency (MHz)	Factor (dB/m)	Reading (dBuV)	Level (dBuV/m)	Limit (dBuV/m)	Margin (dB)	Detector
1	2483.500	31.24	19.33	50.57	74.00	-23.43	peak
2	2483.500	31.24	6.62	37.86	54.00	-16.14	AVG

Remarks:

- 1. Factor (dB/m) = Antenna Factor (dB/m)+Cable Factor (dB)-Pre-amplifier Factor
- 2. Margin value = Level -Limit value



3.6. Antenna Requirement

Requirement

FCC CFR Title 47 Part 15 Subpart C Section 15.203:

An intentional radiator shall be designed to ensure that no antenna other than that furnished by the responsible party shall be used with the device. The use of a permanently attached antenna or of antenna that uses a unique coupling to the intentional radiator, the manufacturer may design the unit so that a broken antenna can be replaced by the user, but the use of a standard antenna jack or electrical connector is prohibited.

FCC CFR Title 47 Part 15 Subpart C Section 15.247(c) (1)(i):

(i) Systems operating in the 2400~2483.5 MHz band that is used exclusively for fixed. Point-to-point operations may employ transmitting antennas with directional gain greater than 6dBi provided the maximum conducted output power of the intentional radiator is reduced by 1 dB for every 3 dB that the directional gain of the antenna exceeds 6dBi.

Test Result

The directional gain of the antenna less than 6dBi, please refer to the EUT internal photographs antenna photo.

*****THE END*****