

FCC TEST REPORT
FCC CFR 47 PART 15 C(15.247): 2013

Report Reference No. : LCS1410130263E

Date of Issue : October 25, 2014

Testing Laboratory Name : Shenzhen LCS Compliance Testing Laboratory Ltd.

Address : 1/F., Xingyuan Industrial Park, Tongda Road, Bao'an Avenue, Bao'an District, Shenzhen, Guangdong, China

Testing Location/ Procedure : Full application of Harmonised standards [checked]
Partial application of Harmonised standards [unchecked]
Other standard testing method [unchecked]

Applicant's Name : SHENZHEN ACADIA ELECTRONIC CO., LTD

Address : 39 Building, B Industry Zone, Tang Lang, Xili Lake, Shenzhen, China

Test Specification

Standard : FCC CFR 47 PART 15 C(15.247): 2013

Test Report Form No. : LCSEMC-1.0

TRF Originator : Shenzhen LCS Compliance Testing Laboratory Ltd.

Master TRF : Dated 2011-03

Shenzhen LCS Compliance Testing Laboratory Ltd. All rights reserved.

This publication may be reproduced in whole or in part for non-commercial purposes as long as the Shenzhen LCS Compliance Testing Laboratory Ltd. is acknowledged as copyright owner and source of the material. Shenzhen LCS Compliance Testing Laboratory Ltd. takes no responsibility for and will not assume liability for damages resulting from the reader's interpretation of the reproduced material due to its placement and context.

Test Item Description : Bluetooth Speaker

Trade Mark : N/A

Model/ Type reference : ES-53803BT

Ratings : DC 3.7V by battery(400mAh)

Result : Positive

Compiled by:

Supervised by:

Approved by:

[Signature of Tree Zhan]

[Signature of Danny Huang]

[Signature of Gavin Liang]

Tree Zhan/ File administrators

Danny Huang/ Technique principal

Gavin Liang/ Manager

FCC -- TEST REPORT

Test Report No. : LCS1410130263E	<u>October 25, 2014</u> Date of issue
---	--

Type / Model..... : ES-53803BT
EUT..... : Bluetooth Speaker
Applicant..... : SHENZHEN ACADIA ELECTRONIC CO., LTD Address..... : 39 Building, B Industry Zone, Tang Lang, Xili Lake, Shenzhen, China Telephone..... : / Fax..... : /
Manufacturer..... : SHENZHEN ACADIA ELECTRONIC CO., LTD Address..... : 39 Building, B Industry Zone, Tang Lang, Xili Lake, Shenzhen, China Telephone..... : / Fax..... : /
Factory..... : SHENZHEN ACADIA ELECTRONIC CO., LTD Address..... : 39 Building, B Industry Zone, Tang Lang, Xili Lake, Shenzhen, China Telephone..... : / Fax..... : /

Test Result	Positive
--------------------	-----------------

The test report merely corresponds to the test sample.
 It is not permitted to copy extracts of these test result without the written permission of the test laboratory.

TABLE OF CONTENTS

Description	Page
1. GENERAL INFORMATION.....	5
1.1 Description of Device (EUT).....	5
1.2 Support equipment List.....	5
1.3 External I/O	5
1.4 Description of Test Facility	6
1.5 Statement of The Measurement Uncertainty	6
1.6 Measurement Uncertainty	6
1.7 Description Of Test Modes.....	7
2. TEST METHODOLOGY	8
2.1 EUT Configuration	8
2.2 EUT Exercise.....	8
2.3 General Test Procedures	8
3. SYSTEM TEST CONFIGURATION.....	9
3.1 Justification.....	9
3.2 EUT Exercise Software	9
3.3 Special Accessories	9
3.4 Block Diagram/Schematics.....	9
3.5 Equipment Modifications	9
3.6 Test Setup	9
4. ANTENNA PORT MEASUREMENT	10
4.1 Peak Power	10
4.2 Frequency Separation And 20 dB Bandwidth	11
4.3 Number Of Hopping Frequency	20
4.4 Time Of Occupancy (Dwell Time).....	22
4.5 Conducted Spurious Emissions and Band Edges Test.....	25
5. RADIATED MEASUREMENT	32
5.1 Test Equipment.....	32
5.2 Block Diagram of Test Setup.....	32
5.3 Radiated Emission Limit	33
5.4 Instruments Setting	34
5.5 Test Procedures.....	35
5.6 Results for Radiated Emissions	35
5.5 Results for Band edge Testing (Radiated)	38
6. LINE CONDUCTED EMISSIONS.....	39
6.1 Standard Applicable.....	39
6.2 Test Equipment.....	39
6.3 Block Diagram of Test Setup.....	39
6.4 Test Results.....	39
7. ANTENNA REQUIREMENT	41
7.1 Standard Applicable.....	41
7.2 Antenna Connected Construction	41
8. MANUFACTURER/ APPROVAL HOLDER DECLARATION	42

1. GENERAL INFORMATION

1.1 Description of Device (EUT)

EUT	: Bluetooth Speaker
Model Number	: ES-53803BT
Power Supply	: DC 3.7V by battery(400mAh)
Frequency Range	: 2402.00-2480.00MHz (Channel Frequency=2402+1(K-1), K=1, 2, 379)
Modulation Technology	: GFSK(1Mbps) π /4-DQPSK(2Mbps) 8-DPSK(3Mbps)
Module Channel	: 79
Channel Spacing	: 1MHz
Bluetooth Version	: V2.1+EDR
Antenna Gain	: Integral antenna, 0dBi(Max.)

1.2 Support equipment List

Manufacturer	Description	Model	Serial Number	Certificate
Lenovo	Notebook	B470	WB05067151	DOC

1.3 External I/O

I/O Port Description	Quantity	Cable
USB Port	1	0.6m

1.4 Description of Test Facility

Site Description EMC Lab.

: Accredited by CNAS, June 04, 2010
The Certificate Registration Number. is L4595.
Accredited by FCC, July 14, 2011
The Certificate Registration Number. is 899208.
Accredited by Industry Canada, May. 02, 2011
The Certificate Registration Number. is 9642A-1
Accredited by VCCI, Japan January 30, 2012
The Certificate Registration Number. is C-4260 and R-3804
Accredited by ESMD, April 24, 2012
The Certificate Registration Number. is ARCB0108.
Accredited by UL, June 11, 2012
The Certificate Registration Number. is 100571-492.
Accredited by TUV, November 21, 2012
The Certificate Registration Number. is SCN1081
Accredited by Intertek, December 21, 2012
The Certificate Registration Number. is 2011-RTL-L1-50.

Name of Firm

: Shenzhen LCS Compliance Testing Laboratory Ltd.

Site Location

: 1/F., Xingyuan Industrial Park, Tongda Road, Bao'an Avenue,
Bao'an District, Shenzhen, Guangdong, China

1.5 Statement of The Measurement Uncertainty

The data and results referenced in this document are true and accurate. The reader is cautioned that there may be errors within the calibration limits of the equipment and facilities. The measurement uncertainty was calculated for all measurements listed in this test report acc. To CISPR 16 – 4 “Specification for radio disturbance and immunity measuring apparatus and methods – Part 4: Uncertainty in EMC Measurements” and is documented in the LCS quality system acc. To DIN EN ISO/IEC 17025. Furthermore, component and process variability of devices similar to that tested may result in additional deviation. The manufacturer has the sole responsibility of continued compliance of the device.

1.6 Measurement Uncertainty

Test Item	Frequency Range	Uncertainty	Note
Radiation Uncertainty	9KHz~30MHz	$\pm 3.10\text{dB}$	(1)
	30MHz~200MHz	$\pm 2.96\text{dB}$	(1)
	200MHz~1000MHz	$\pm 3.10\text{dB}$	(1)
	1GHz~26.5GHz	$\pm 3.80\text{dB}$	(1)
	26.5GHz~40GHz	$\pm 3.90\text{dB}$	(1)
Conduction Uncertainty	150kHz~30MHz	$\pm 1.63\text{dB}$	(1)
Power disturbance	30MHz~300MHz	$\pm 1.60\text{dB}$	(1)

(1). This uncertainty represents an expanded uncertainty expressed at approximately the 95% confidence level using a coverage factor of $k=2$.

1.7 Description Of Test Modes

Bluetooth operates in the unlicensed ISM Band at 2.4GHz. With the introduction of the enhanced data rate (EDR) feature, the data rates can be up to 3 Mb/s. An increase in the peak data rate beyond the basic rate of 1 Mb/s is achieved by modulating the RF carrier using GFSK techniques, resulting in an increase of two to three times the number of bits per symbol. The 2 Mb/s EDR packets use a $\pi/4$ -DQPSK modulation and the 3 Mb/s EDR packets use 8DPSK modulation.

All 3axis have been tested. The following operating modes were applied for the related test items. All test modes were tested, only the result of the worst case was recorded in the report.

Mode of Operations	Frequency Range (MHz)	Data Rate (Mbps)
GFSK	2402	1
	2441	1
	2480	1
$\pi/4$ DQPSK	2402	2
	2441	2
	2480	2
8-DPSK	2402	3
	2441	3
	2480	3
For Conducted Emission		
Test Mode	TX Mode	
For Radiated Emission		
Test Mode	TX Mode	

Worst-case mode and channel used for 150kHz-30 MHz power line conducted emissions was the mode and channel with the highest output power, that was determined to be TX(1Mbps-Hopping Mode).

Worst-case mode and channel used for 9kHz-1000 MHz radiated emissions was the mode and channel with the highest output power, that was determined to be TX(1Mbps---Low Channel).

2. TEST METHODOLOGY

The tests documented in this report were performed in accordance with ANSI C63.4-2009, RSS-210, FCC CFR PART 15C 15.207, 15.209, 15.247 and DA 00-705.

2.1 EUT Configuration

The EUT configuration for testing is installed on RF field strength measurement to meet the Commissions requirement and operating in a manner that intends to maximize its emission characteristics in a continuous normal application.

2.2 EUT Exercise

The EUT was operated in the engineering mode to fix the TX frequency that was for the purpose of the measurements.

According to its specifications, the EUT must comply with the requirements of the Section 15.207, 15.209, 15.247 under the FCC Rules Part 15 Subpart C and RSS-210.

2.3 General Test Procedures

2.3.1 Conducted Emissions

The EUT is placed on the turntable, which is 0.8 m above ground plane. According to the requirements in Section 13.1.4.1 of ANSI C63.4-2009 Conducted emissions from the EUT measured in the frequency range between 0.15 MHz and 30MHz using Quasi-peak and average detector modes.

2.3.2 Radiated Emissions

The EUT is placed on a turn table, which is 0.8 m above ground plane. The turntable shall rotate 360 degrees to determine the position of maximum emission level. EUT is set 3m away from the receiving antenna, which varied from 1m to 4m to find out the highest emission. And also, each emission was to be maximized by changing the polarization of receiving antenna both horizontal and vertical. In order to find out the maximum emissions, exploratory radiated emission measurements were made according to the requirements in Section 13.1.4.1 of ANSI C63.4-2009

3. SYSTEM TEST CONFIGURATION

3.1 Justification

The system was configured for testing in a continuous transmit condition.

3.2 EUT Exercise Software

N/A.

3.3 Special Accessories

N/A.

3.4 Block Diagram/Schematics

Please refer to the related document.

3.5 Equipment Modifications

Shenzhen LCS Compliance Testing Laboratory Ltd. has not done any modification on the EUT.

3.6 Test Setup

Please refer to the test setup photo.

4. ANTENNA PORT MEASUREMENT

4.1 Peak Power

4.1.1 Test Equipment

Item	Equipment	Manufacturer	Model No.	Serial No.	Last Cal.	Next Cal.
1	Power Sensor	R&S	NRV-Z51	100458	2014-06-18	2015-06-17
2	Power Sensor	R&S	NRV-Z32	10057	2014-06-18	2015-06-17
3	Power Meter	R&S	NRVS	100444	2014-06-18	2015-06-17
4	DC Filter	MPE	23872C	N/A	2014-06-18	2015-06-17
5	Coaxial Cable	ACE	S112	N/A	2014-06-18	2015-06-17

4.1.2 Block Diagram of Test Setup

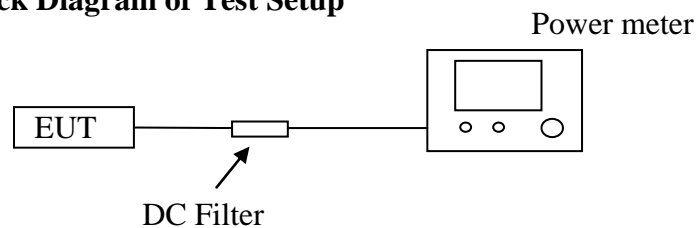

4.1.3 Limit

According to §15.247(a)(1) or A8.4 (2), For frequency hopping systems operating in the 2400-2483.5 MHz band may have hopping channel carrier frequencies that are separated by 25 kHz or two-thirds of the 20 dB bandwidth of the hopping channel, whichever is greater, provided the systems operate with an output power no greater than 125mW..

4.1.4 Test Procedure

The transmitter output is connected to the Power Meter.

4.1.5 Test Results

Channel	Frequency (MHz)	Output Power (dBm)	Output Power (mW)	Limit (mW)	Result
GFSK	2402	3.57	2.27	125	Pass
	2441	3.62	2.30	125	Pass
	2480	3.81	2.40	125	Pass
π /4 DQPSK	2402	3.10	2.04	125	Pass
	2441	3.12	2.05	125	Pass
	2480	3.23	2.10	125	Pass
8-DPSK	2402	2.71	1.87	125	Pass
	2441	2.83	1.92	125	Pass
	2480	2.90	1.95	125	Pass

4.2 Frequency Separation And 20 dB Bandwidth

4.2.1 Limit

According to §15.247(c) or A8.1(a), in any 100 kHz bandwidth outside the frequency bands in which the spread spectrum intentional radiator is operating, the radio frequency power that is produced by the intentional radiator shall be at least 20dB below that in the 100kHz bandwidth within the band that contains the highest level of the desired power. In addition, radiated emissions which fall in the restricted bands, as defined in §15.205(a), must also comply with the radiated emission limits specified in 15.209(a).

4.2.2 Test Equipment

Item	Equipment	Manufacturer	Model No.	Serial No.	Last Cal.	Next Cal.
1	Spectrum Analyzer	Agilent	E4407B	MY41440292	2014-06-16	2015-06-15
2	Signal analyzer	Agilent	E4448A(External mixers to 40GHz)	US44300469	2014-06-16	2015-06-15
3	RF Cable	Hubersuhne	Sucoflex104	FP2RX2	2014-06-18	2015-06-17
4	DC Filter	MPE	23872C	N/A	2014-06-18	2015-06-17

4.2.3 Block Diagram of Test Setup

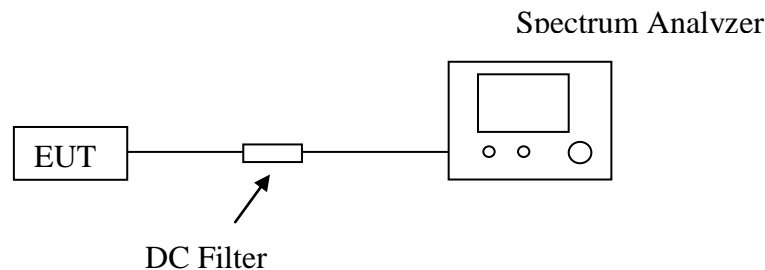

4.2.4 Test Procedure

- Place the EUT on the table and set it in transmitting mode.
- Remove the antenna from the EUT and then connect a low loss RF cable from the antenna port to the Spectrum Analyzer.
- Set to the maximum power setting and enable the EUT transmit continuously.
- For carrier frequency separation measurement, use the following spectrum analyzer settings:
 - Span = wide enough to capture the peaks of two adjacent channels;
 - RBW / VBW=100KHz / 100KHz; Sweep = auto; Detector function = peak;
 - Trace = max hold.
- For 20dB bandwidth measurement, use the following spectrum analyzer settings:
 - Span = approximately 2 to 3 times the 20 dB bandwidth, centered on a hopping channel;
 - RBW/VBW=30KHz / 100KHz; Sweep = auto; Detector function = peak;
 - Trace = max hold.

4.2.5 Test Results

The Measurement Result With 1Mbps For GFSK Modulation				
Channel	20dB Bandwidth (KHz)	Channel Separation (MHz)	Limit (MHz)	Result
Low	892.137	1.000	≥ 25 KHz or 2/3 20 dB BW	Pass
Middle	888.194		≥ 25 KHz or 2/3 20 dB BW	Pass
High	895.599		≥ 25 KHz or 2/3 20 dB BW	Pass

The Measurement Result With 2Mbps For $\pi/4$ DQPSK Modulation				
Channel	20dB Bandwidth (MHz)	Channel Separation (MHz)	Limit (MHz)	Result
Low	1.137	1.000	≥ 25 KHz or 2/3 20 dB BW	Pass
Middle	1.134		≥ 25 KHz or 2/3 20 dB BW	Pass
High	1.139		≥ 25 KHz or 2/3 20 dB BW	Pass

The Measurement Result With 3Mbps For 8-DPSK Modulation				
Channel	20dB Bandwidth (MHz)	Channel Separation (MHz)	Limit (MHz)	Result
Low	1.161	1.000	≥ 25 KHz or 2/3 20 dB BW	Pass
Middle	1.162		≥ 25 KHz or 2/3 20 dB BW	Pass
High	1.157		≥ 25 KHz or 2/3 20 dB BW	Pass

The test data refer to the following page.

Test Plot Of Frequency Separation (1Mbps)

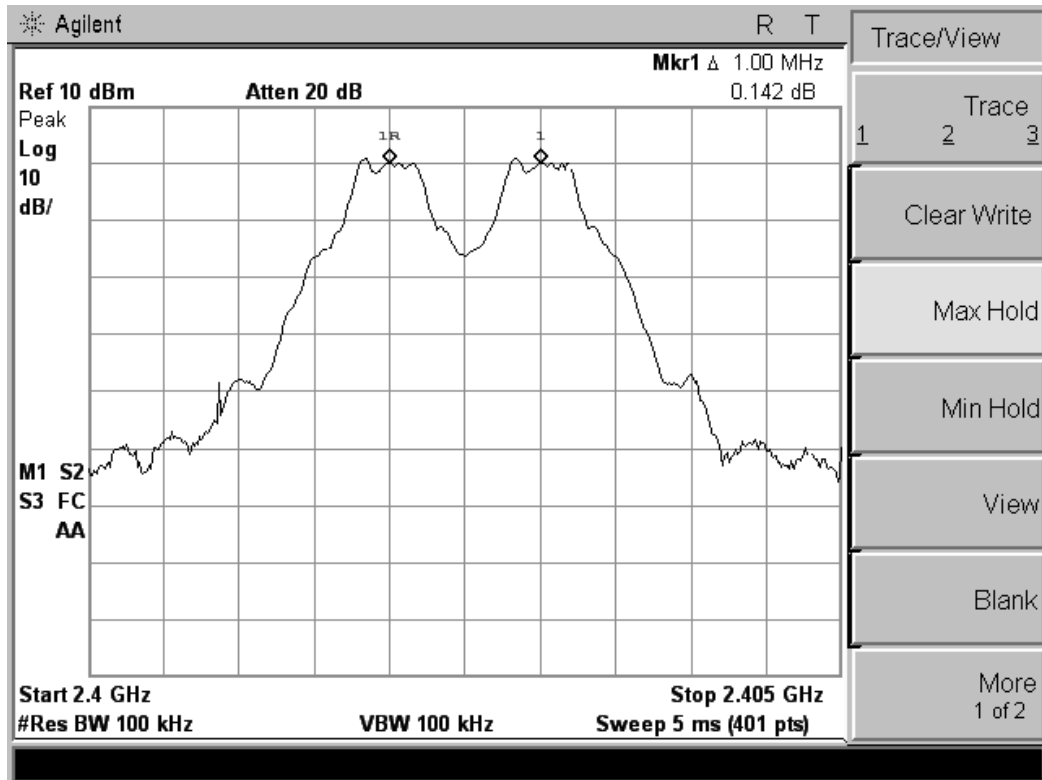

Test Plot Of Frequency Separation (2Mbps)

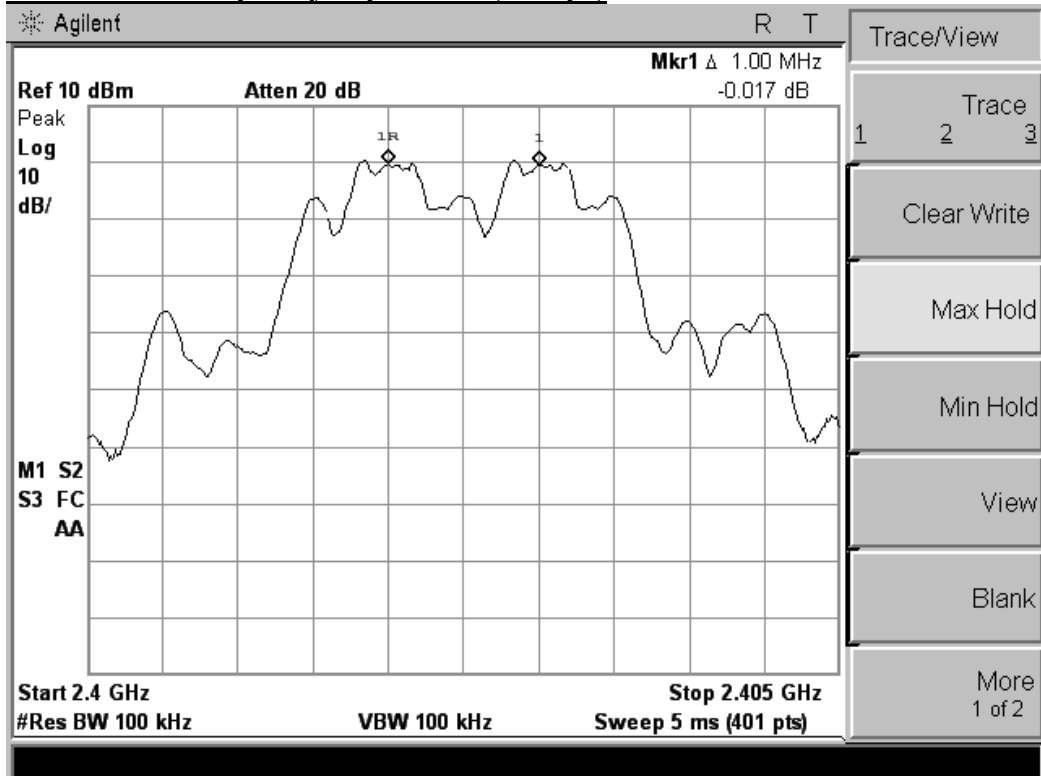

Test Plot Of Frequency Separation (3Mbps)

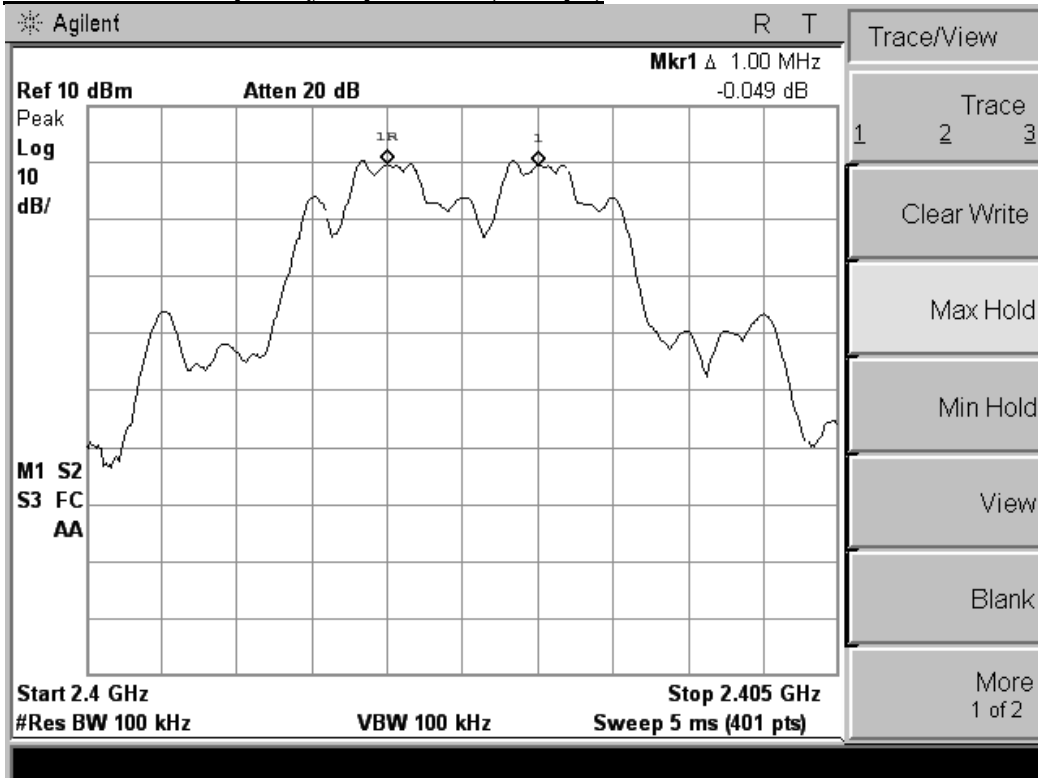

Measurement of 20dB Bandwidth

Test frequency: 2402MHz(1Mbps)

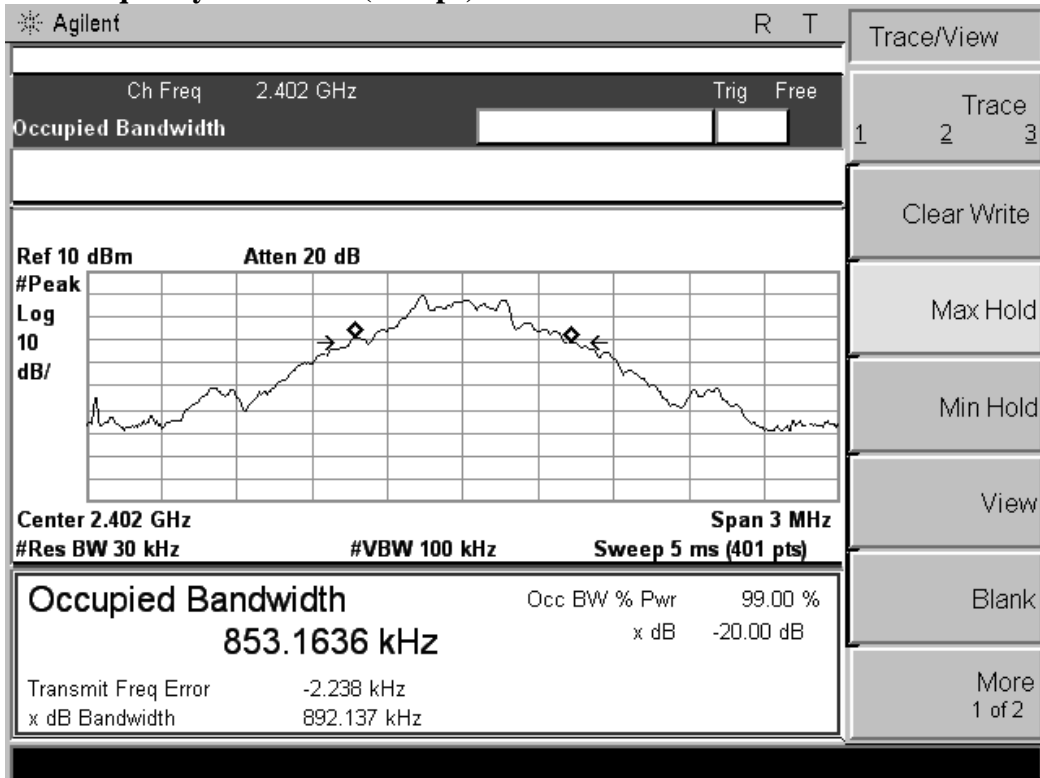

Test frequency: 2441MHz(1Mbps)

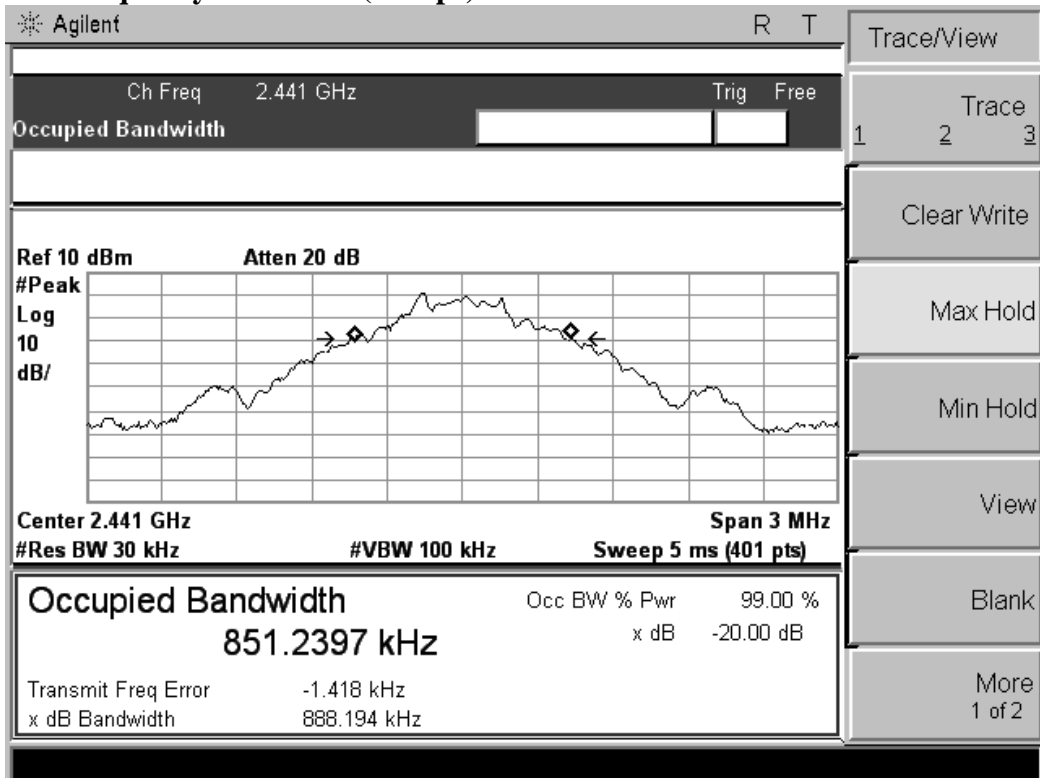

Test frequency: 2480MHz(1Mbps)

Agilent		R	T	Trace/View	
Ch Freq 2.48 GHz		Trig Free		Trace 1 2 3	
Occupied Bandwidth				Clear Write	
Ref 10 dBm Atten 20 dB #Peak Log 10 dB/				Max Hold	
Center 2.48 GHz		Span 3 MHz		Min Hold	
#Res BW 30 kHz		#VBW 100 kHz		View	
Sweep 5 ms (401 pts)				Blank	
Occupied Bandwidth 850.8433 kHz		Occ BW % Pwr 99.00 % x dB -20.00 dB		More 1 of 2	
Transmit Freq Error -3.115 kHz x dB Bandwidth 895.599 kHz					

Test frequency: 2402MHz(2Mbps)

Agilent		R	T	Trace/View	
Ch Freq 2.402 GHz		Trig Free		Trace 1 2 3	
Occupied Bandwidth				Clear Write	
Ref 10 dBm Atten 20 dB #Peak Log 10 dB/				Max Hold	
Center 2.402 GHz		Span 3 MHz		Min Hold	
#Res BW 30 kHz		#VBW 100 kHz		View	
Sweep 5 ms (401 pts)				Blank	
Occupied Bandwidth 1.0823 MHz		Occ BW % Pwr 99.00 % x dB -20.00 dB		More 1 of 2	
Transmit Freq Error -8.221 kHz x dB Bandwidth 1.137 MHz					

Test frequency: 2441MHz(2Mbps)

Agilent		R	T	Trace/View	
Ch Freq 2.441 GHz		Trig Free		Trace 1 2 3	
Occupied Bandwidth				Clear Write	
Ref 10 dBm Atten 20 dB #Peak Log 10 dB/				Max Hold	
Center 2.441 GHz		Span 3 MHz		Min Hold	
#Res BW 30 kHz		#VBW 100 kHz		View	
		Sweep 5 ms (401 pts)		Blank	
Occupied Bandwidth 1.0758 MHz		Occ BW % Pwr 99.00 % x dB -20.00 dB		More 1 of 2	
Transmit Freq Error -8.631 kHz					
x dB Bandwidth 1.134 MHz					

Test frequency: 2480MHz(2Mbps)

Agilent		R	T	Trace/View	
Ch Freq 2.48 GHz		Trig Free		Trace 1 2 3	
Occupied Bandwidth				Clear Write	
Ref 10 dBm Atten 20 dB #Peak Log 10 dB/				Max Hold	
Center 2.48 GHz		Span 3 MHz		Min Hold	
#Res BW 30 kHz		#VBW 100 kHz		View	
		Sweep 5 ms (401 pts)		Blank	
Occupied Bandwidth 1.0748 MHz		Occ BW % Pwr 99.00 % x dB -20.00 dB		More 1 of 2	
Transmit Freq Error -9.572 kHz					
x dB Bandwidth 1.139 MHz					

Test frequency: 2402MHz(3Mbps)

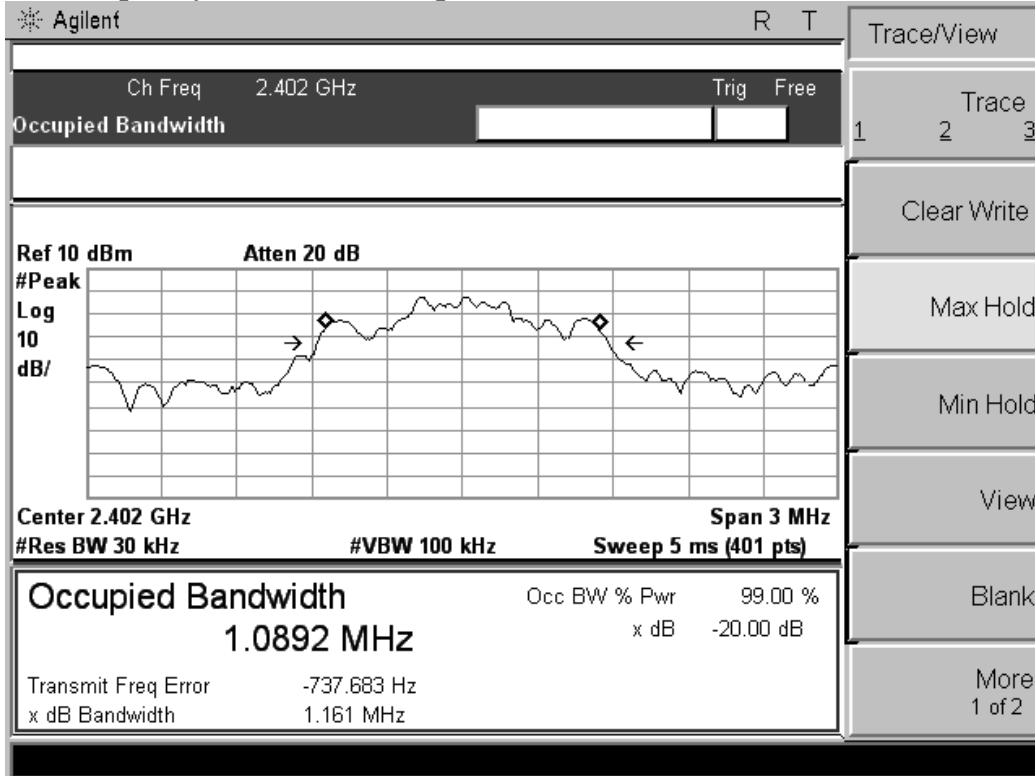

Test frequency: 2441MHz(3Mbps)

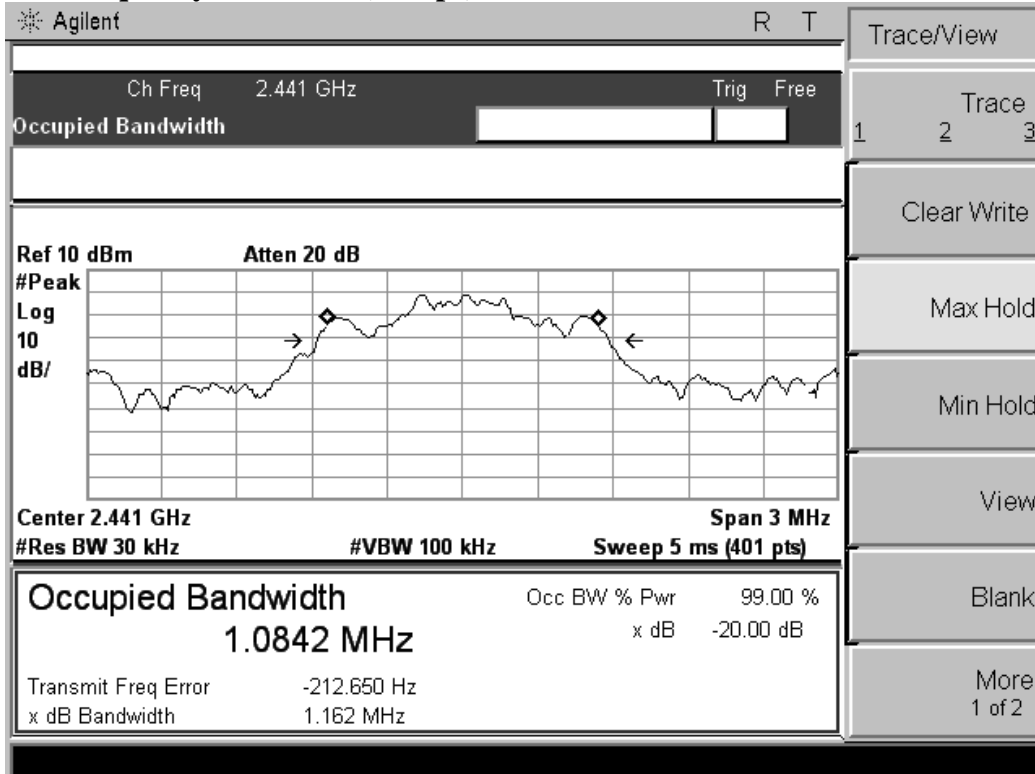

Test frequency: 2480MHz(3Mbps)

Agilent		R	T	Trace/View	
Ch Freq 2.48 GHz		Trig Free		Trace 1 2 3	
Occupied Bandwidth				Clear Write	
<p>Ref 10 dBm Atten 20 dB</p> <p>#Peak</p> <p>Log</p> <p>10</p> <p>dB/</p>				Max Hold	
Center 2.48 GHz		Span 3 MHz		Min Hold	
#Res BW 30 kHz		#VBW 100 kHz		View	
		Sweep 5 ms (401 pts)		Blank	
Occupied Bandwidth		Occ BW % Pwr		99.00 %	
1.0800 MHz		x dB		-20.00 dB	
Transmit Freq Error		-764.954 Hz		More	
x dB Bandwidth		1.157 MHz		1 of 2	

4.3 Number Of Hopping Frequency

4.3.1 Limit

According to §15.247(a)(1)(ii) or A8.1 (d), Frequency hopping systems operating in the band 2400-2483.5 MHz shall use at least 15 hopping channels.

4.3.2 Test Equipment

Item	Equipment	Manufacturer	Model No.	Serial No.	Last Cal.	Next Cal.
1	Spectrum Analyzer	Agilent	E4407B	MY41440292	2014-06-16	2015-06-15
2	Signal analyzer	Agilent	E4448A(External mixers to 40GHz)	US44300469	2014-06-16	2015-06-15
3	RF Cable	Hubersuhne	Sucoflex104	FP2RX2	2014-06-18	2015-06-17
4	DC Filter	MPE	23872C	N/A	2014-06-18	2015-06-17

4.3.3 Block Diagram of Test Setup

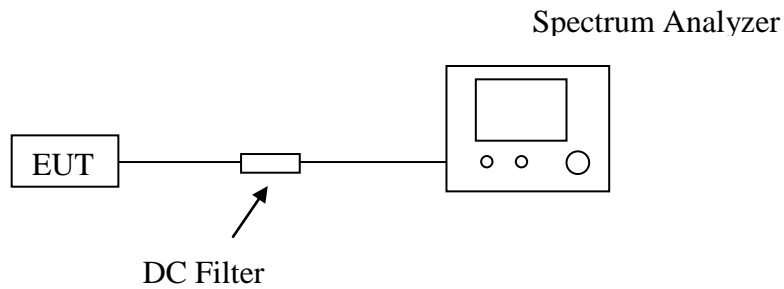

4.3.4 Test Procedure

- Place the EUT on the table and set it in transmitting mode.
- Remove the antenna from the EUT and then connect a low loss RF cable from the antenna port to the Spectrum Analyzer.
- Set Spectrum Analyzer Start=2400MHz, Stop = 2483.5MHz, Sweep = auto.
- Set the Spectrum Analyzer as RBW, VBW=1MHz.
- Max hold, view and count how many channel in the band.

4.3.5 Test Results

The Measurement Result With The Worst Case of 1Mbps For GFSK Modulation			
Total No. of Hopping Channel	Measurement Result (No. of Ch)	Limit (MHz)	Result
	79	≥15	Pass

The test data refer to the following page.

Test Plot-1 For Number of Hopping Channel

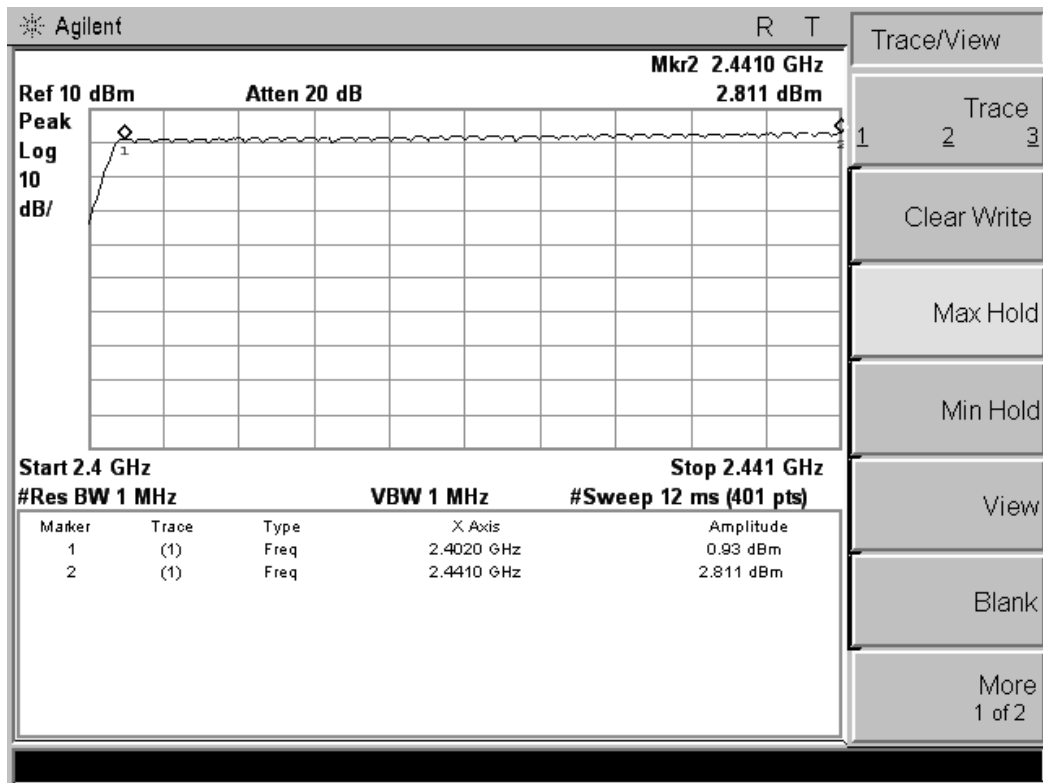

Test Plot-2 For Number of Hopping Channel

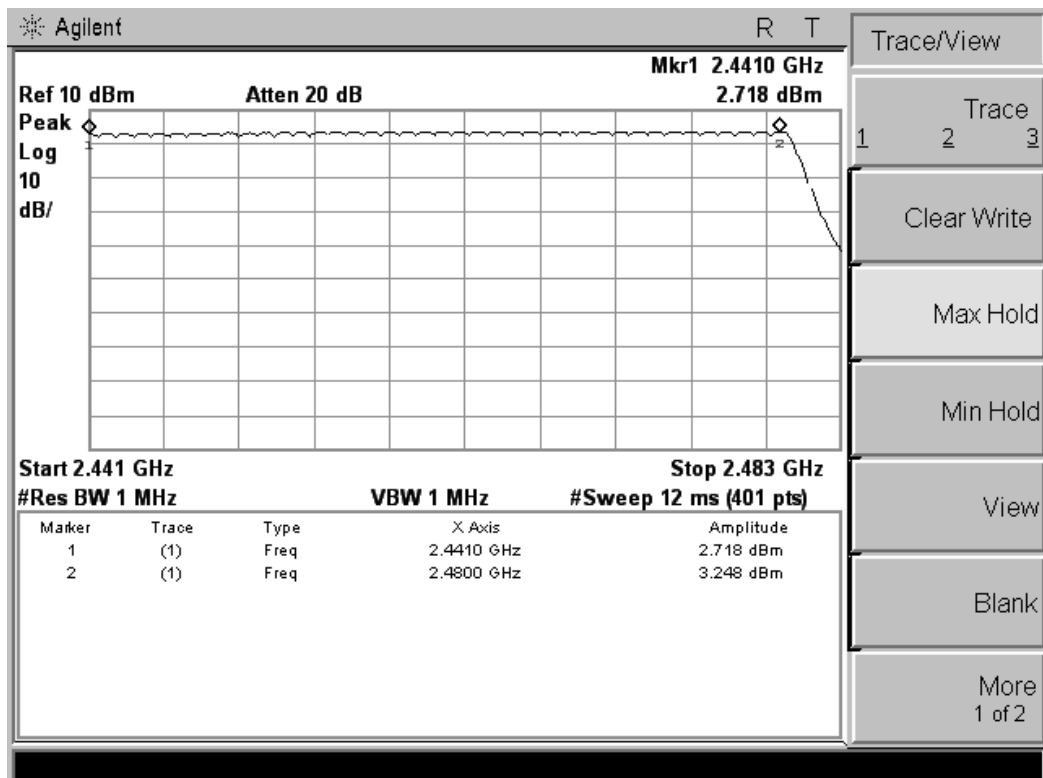

4.4 Time Of Occupancy (Dwell Time)

4.4.1 Limit

According to §15.247(a)(1)(iii) or A8.1 (d), Frequency hopping systems operating in the 2400MHz- 2483.5 MHz bands. The average time of occupancy on any channels shall not greater than 0.4 s within a period 0.4 s multiplied by the number of hopping channels employed.

4.4.2 Test Equipment

Item	Equipment	Manufacturer	Model No.	Serial No.	Last Cal.	Next Cal.
1	Spectrum Analyzer	Agilent	E4407B	MY41440292	2014-06-16	2015-06-15
2	Signal analyzer	Agilent	E4448A(External mixers to 40GHz)	US44300469	2014-06-16	2015-06-15
3	RF Cable	Hubersuhne	Sucoflex104	FP2RX2	2014-06-18	2015-06-17
4	DC Filter	MPE	23872C	N/A	2014-06-18	2015-06-17

4.4.3 Block Diagram of Test Setup

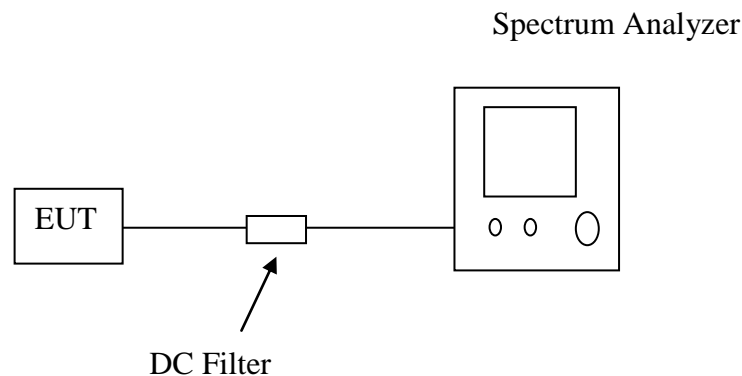

4.4.4 Test Procedure

- A. Place the EUT on the table and set it in transmitting mode.
- B. Remove the antenna from the EUT and then connect a low loss RF cable from the antenna port to the Spectrum Analyzer.
- C. Set center frequency of Spectrum Analyzer = operating frequency.
- D. Set the Spectrum Analyzer as RBW, VBW=1MHz, Span = 0Hz, Sweep = auto.
- E. Repeat above procedures until all frequency measured were complete.

4.5.5 Test Results

The Measurement Result With The Worst Case of 3Mbps For 8-DPSK Modulation				
Channel	Time of Pulse for 3DH5 (ms)	Period Time (s)	Sweep Time (ms)	Limit (ms)
Low	2.88	31.6	307.2	400
Middle	2.88	31.6	307.2	400
High	2.88	31.6	307.2	400

Low Channel

$$2.88 * (1600/6) / 79 * 31.6 = 307.2 \text{ms}$$

Middle Channel

$$2.88 * (1600/6) / 79 * 31.6 = 307.2 \text{ms}$$

High Channel

$$2.88 * (1600/6) / 79 * 31.6 = 307.2 \text{ms}$$

The test data refer to the following:

Low Channel

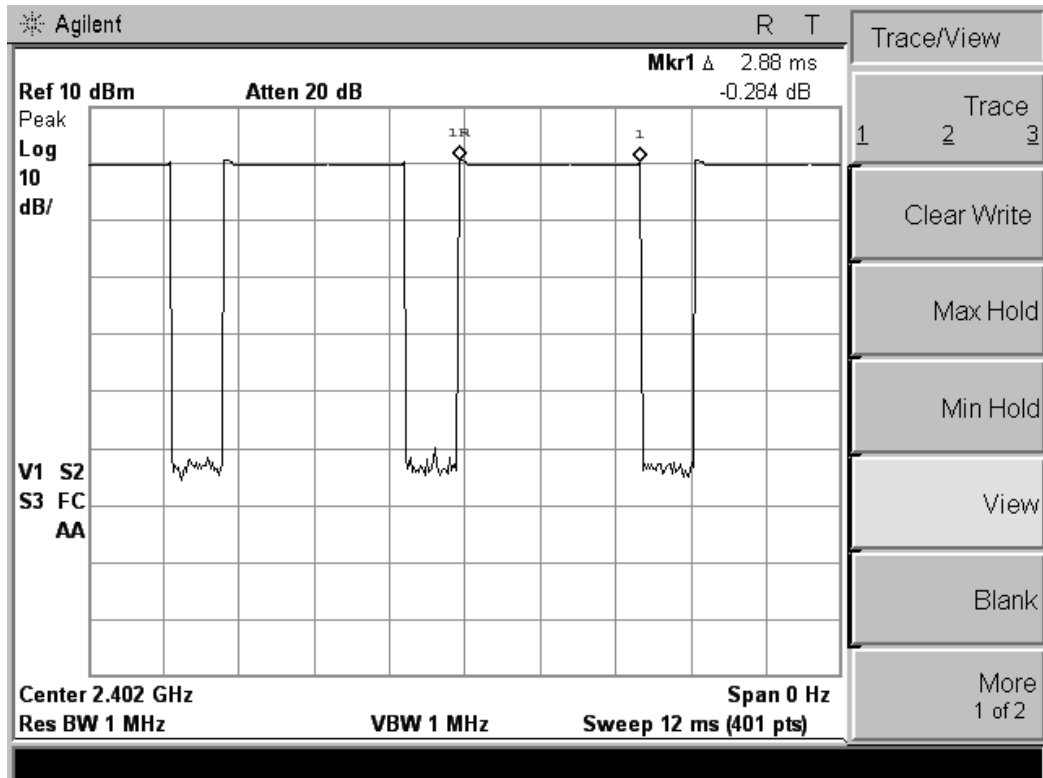

Middle Channel

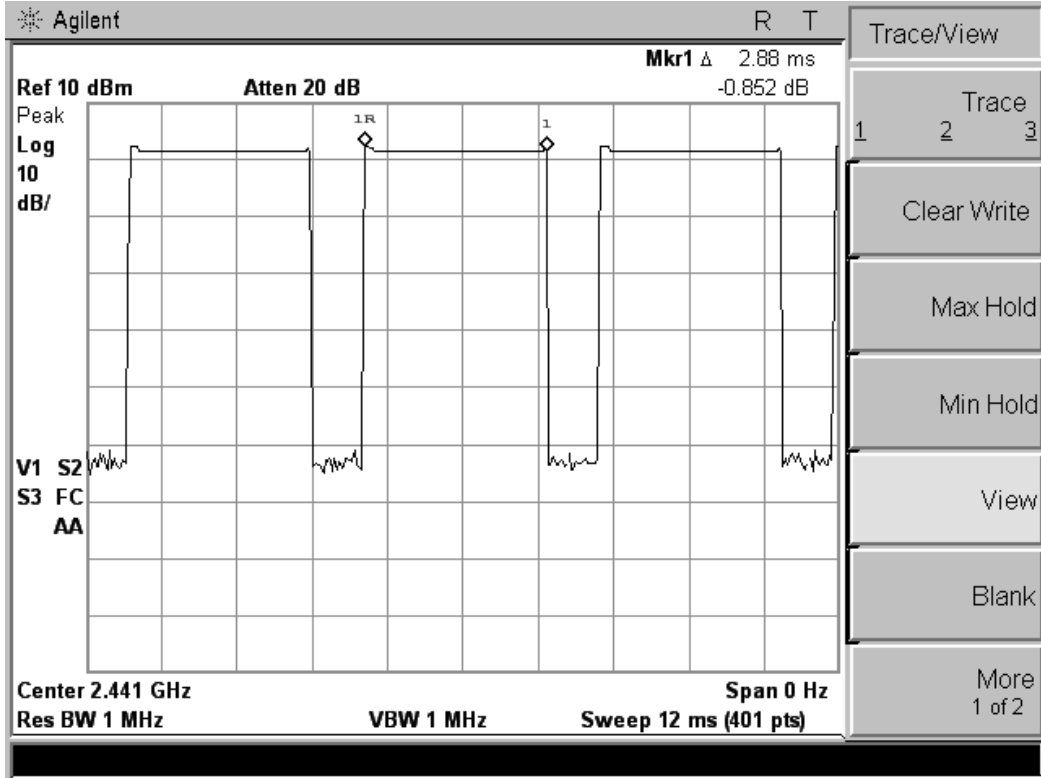

High Channel

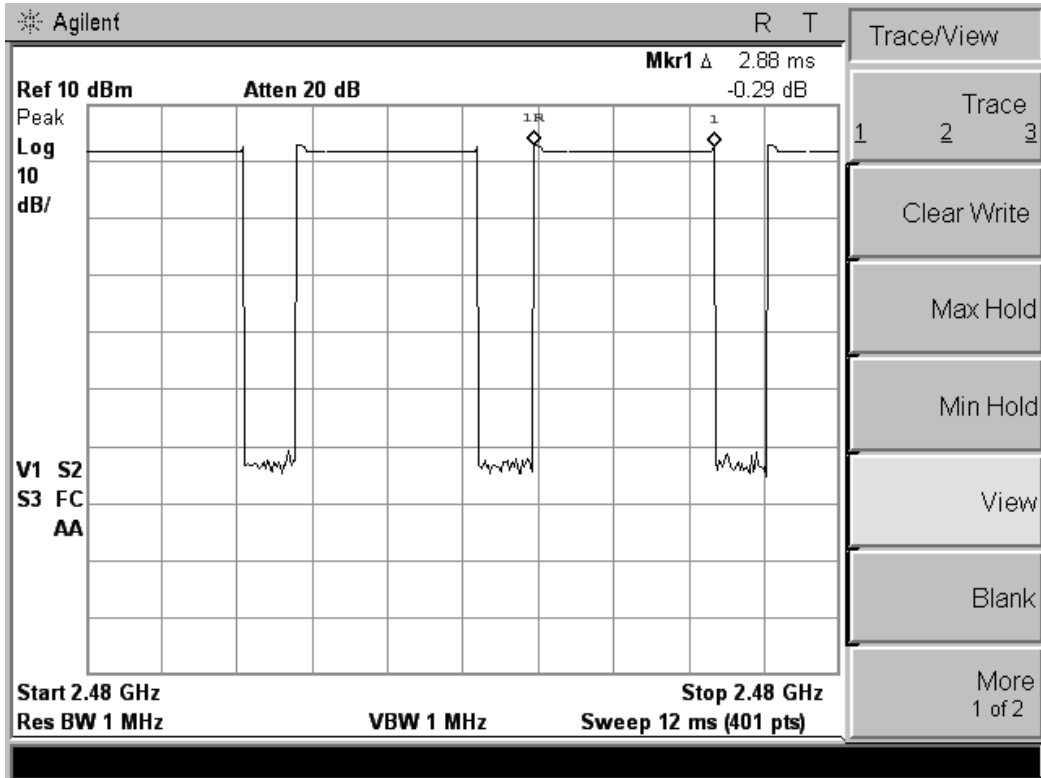

4.5 Conducted Spurious Emissions and Band Edges Test

4.5.1 Limit

In any 100 kHz bandwidth outside the frequency band in which the spread spectrum or digitally modulated intentional radiator is operating, the radio frequency power that is produced by the intentional radiator shall be at least 20 dB below that in the 100 kHz bandwidth within the band that contains the highest level of the desired power, based on either an RF conducted or a radiated measurement. Attenuation below the general limits specified in Section 15.209(a) is not required. In addition, radiated emissions which fall in the restricted bands, as defined in Section 15.205(a), must also comply with the radiated emission limits specified in Section 15.209(a) (see Section 15.205(c)).

4.5.2 Test Equipment

Item	Equipment	Manufacturer	Model No.	Serial No.	Last Cal.	Next Cal.
1	Spectrum Analyzer	Agilent	E4407B	MY41440292	2014-06-16	2015-06-15
2	Signal analyzer	Agilent	E4448A(External mixers to 40GHz)	US44300469	2014-06-16	2015-06-15
3	RF Cable	Hubersuhne	Sucoflex104	FP2RX2	2014-06-18	2015-06-17
4	DC Filter	MPE	23872C	N/A	2014-06-18	2015-06-17

4.5.3 Block Diagram of Test Setup

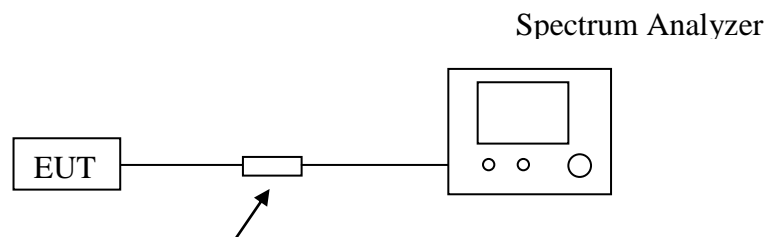

4.5.4 Test Proced DC Filter

Conducted RF measurements of the transmitter output were made to confirm that the EUT antenna port conducted emissions meet the specified limit and to identify any spurious signals that require further investigation or measurements on the radiated emissions site.

The transmitter output is connected to the spectrum analyzer. The resolution bandwidth is set to 100 KHz. The video bandwidth is set to 300 KHz.

Measurements are made over the 9kHz to 26.5GHz range with the transmitter set to the lowest, middle, and highest channels

4.5.5 Test Results of Conducted Spurious Emissions

No non-compliance noted. Only record the worst test result (TX-GFSK) in this report. The test data refer to the following page.

Test Plot

9KHz-26.5GHz Low Channel(GFSK)

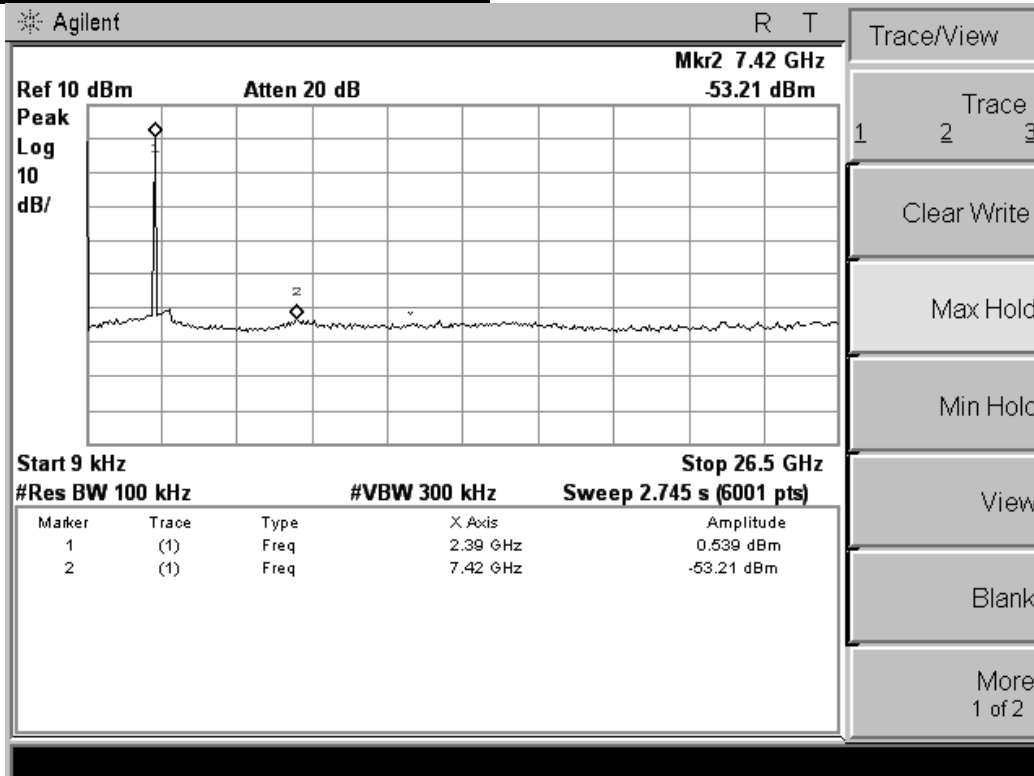

9KHz-26.5GHz Middle Channel(GFSK)

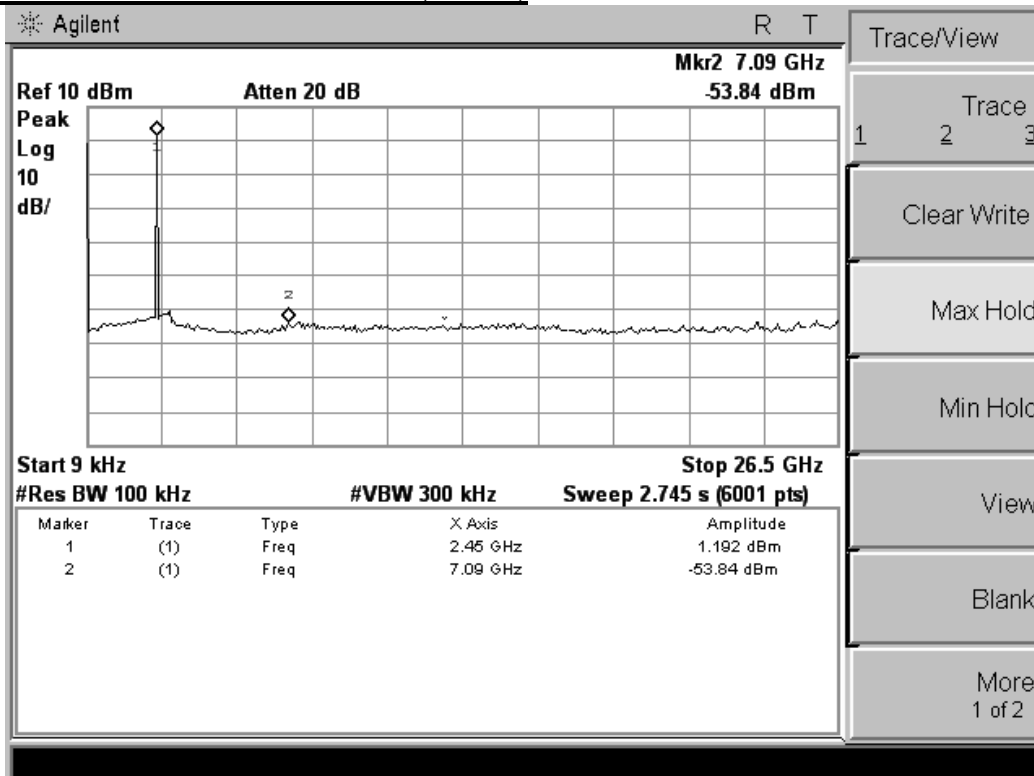

9KHz-26.5GHz High Channel(GFSK)

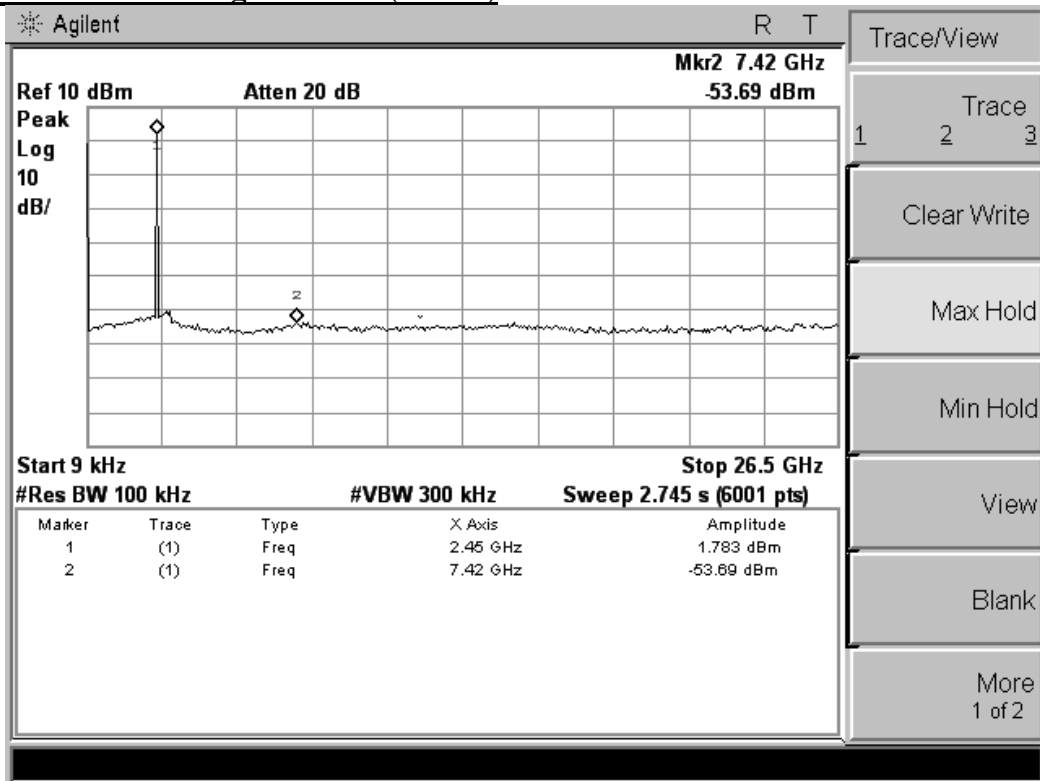

4.5.5 Test Results of Band Edges Test

No non-compliance noted. Only record the worst test result in this report. The test data refer to the following page.

Test Plot

Hopping On - (GFSK)

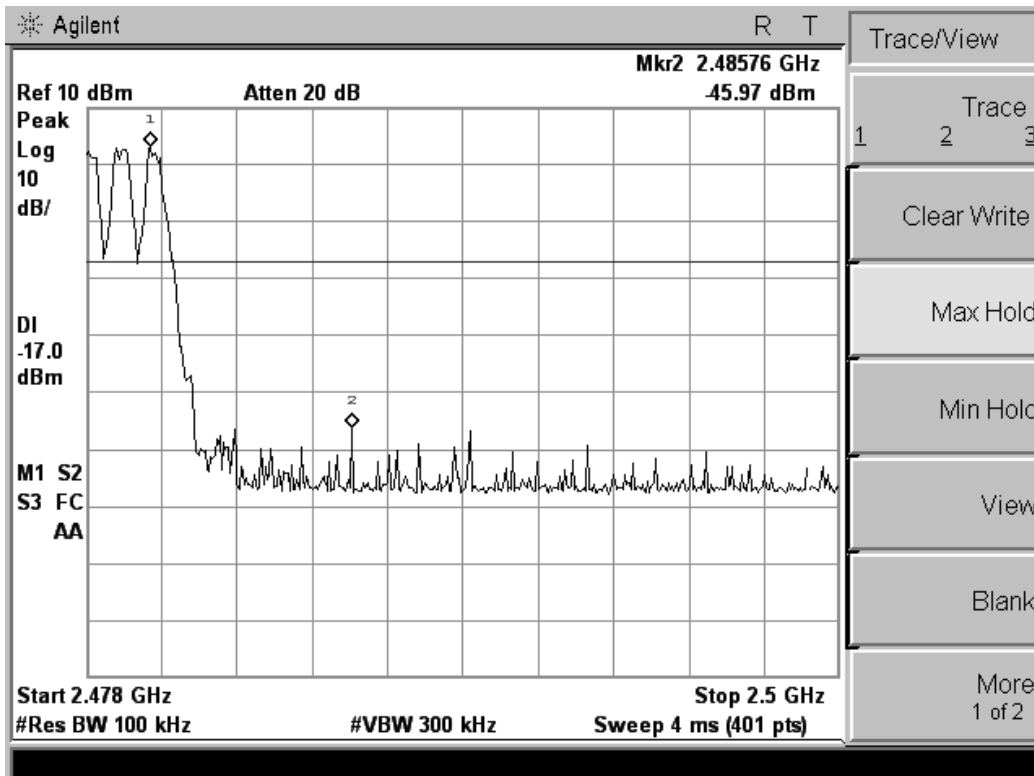
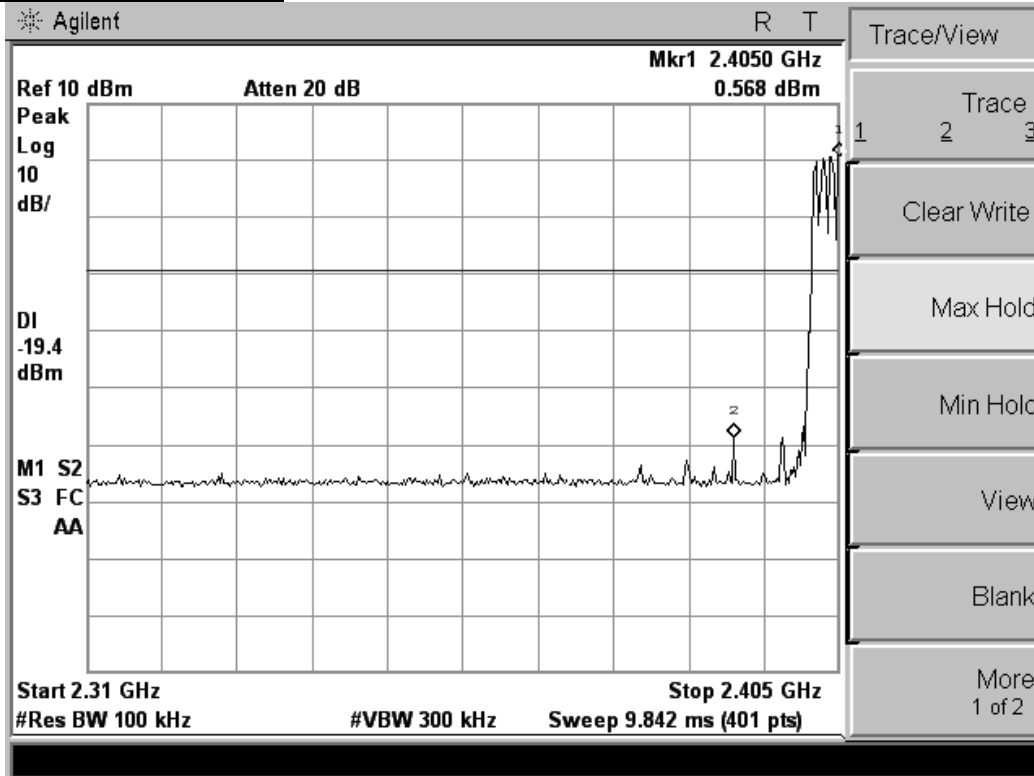

Hopping Off - (GFSK)

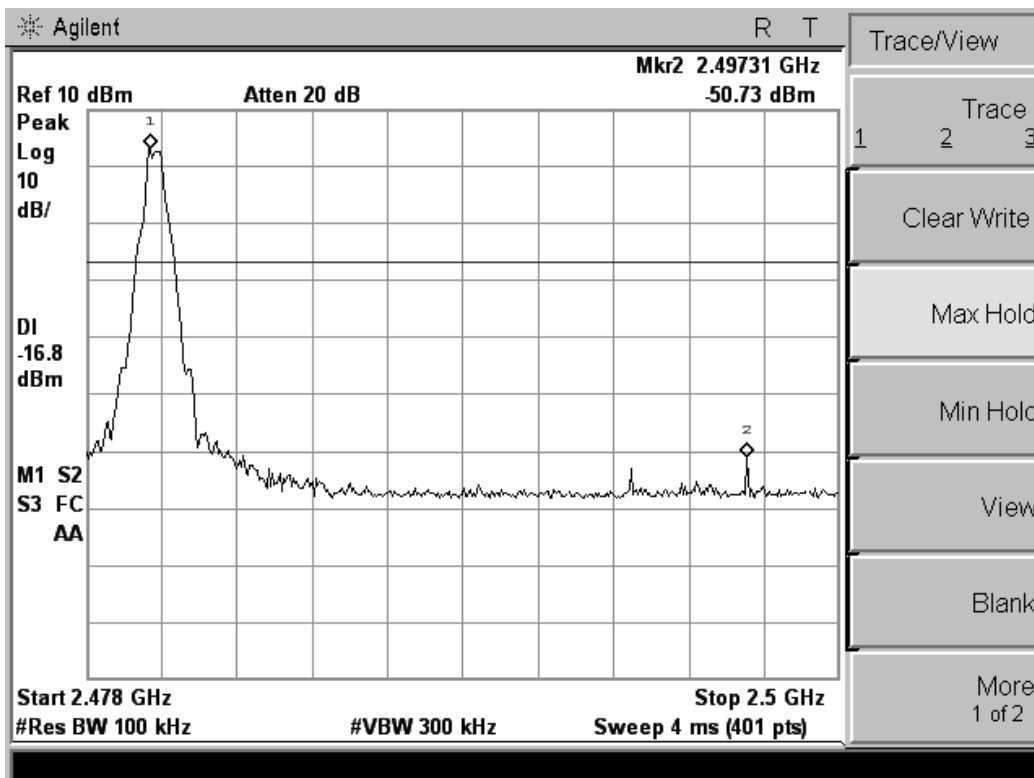
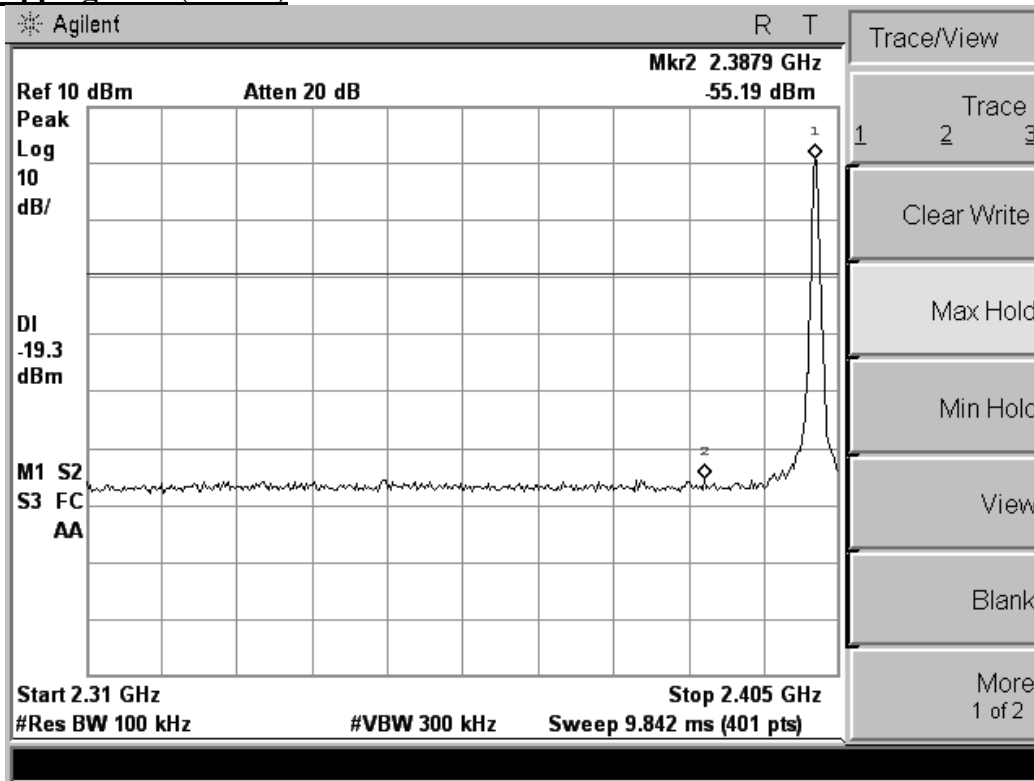

Hopping On - (8-DPSK)

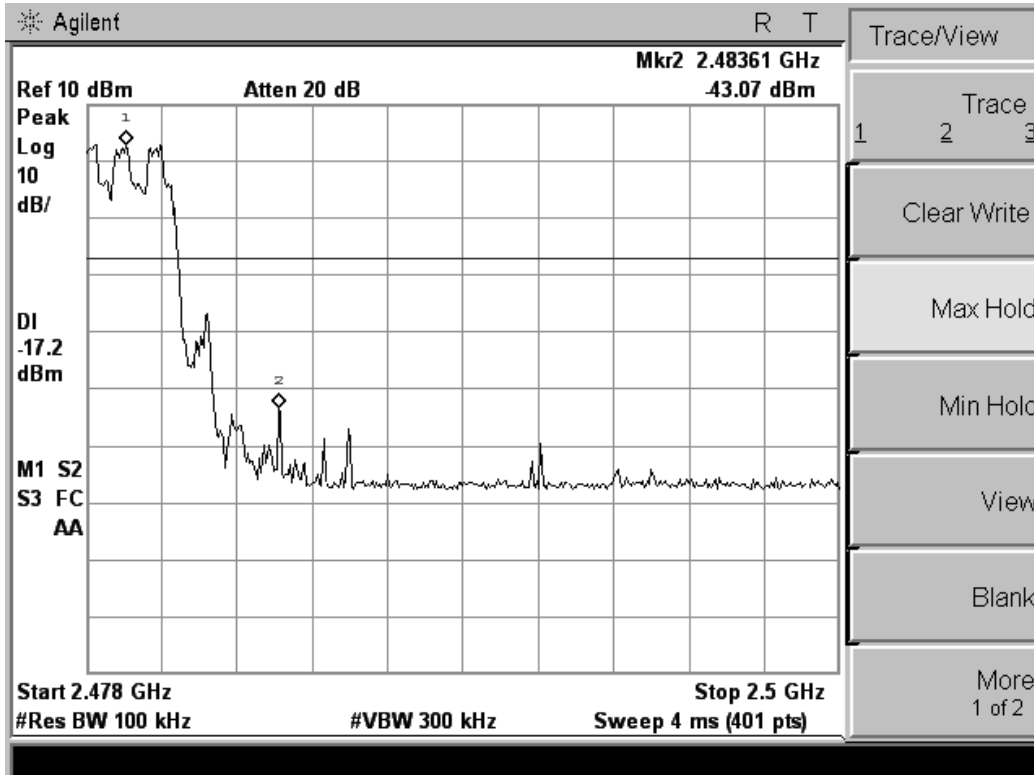
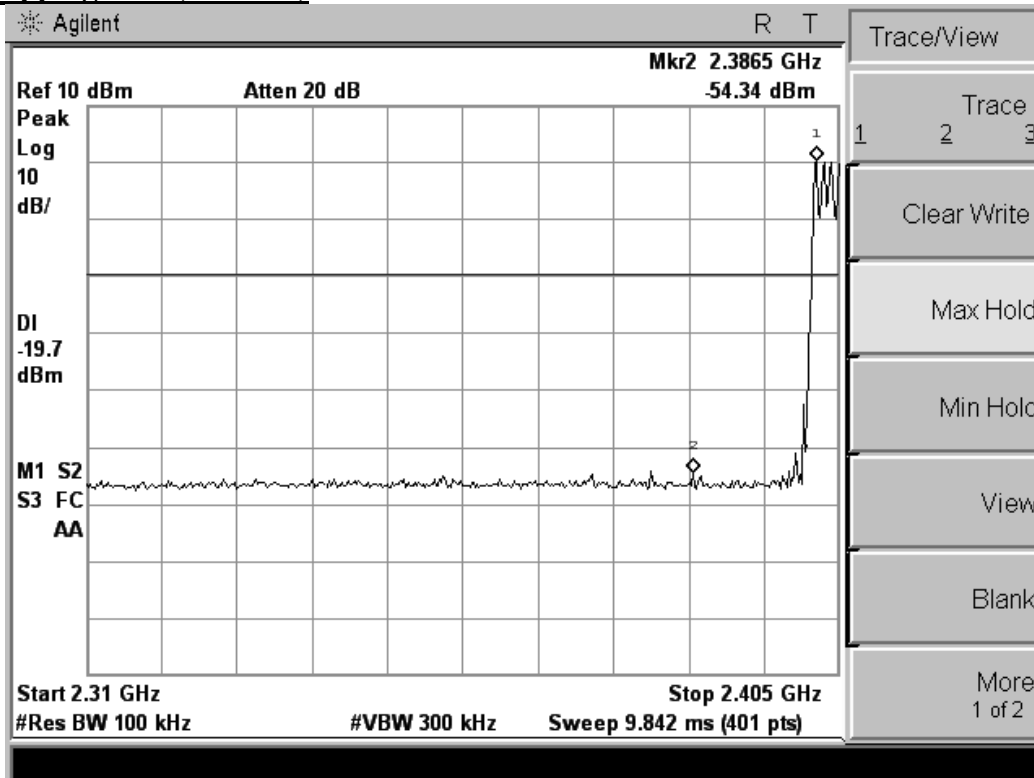

Hopping Off - (8-DPSK)

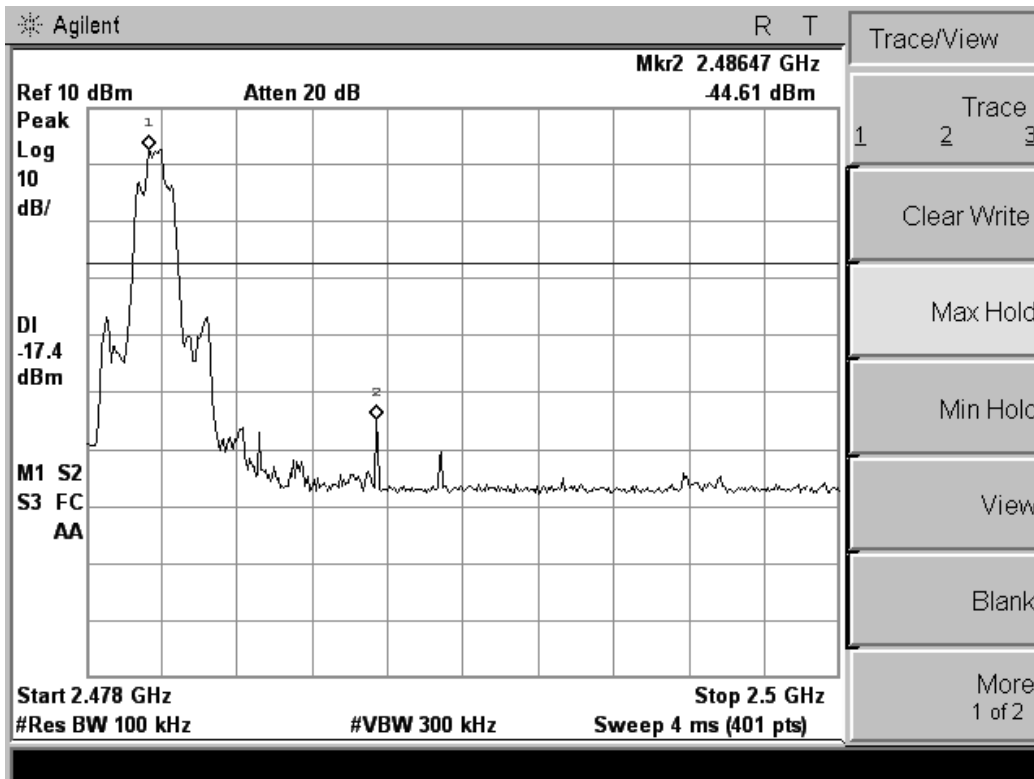
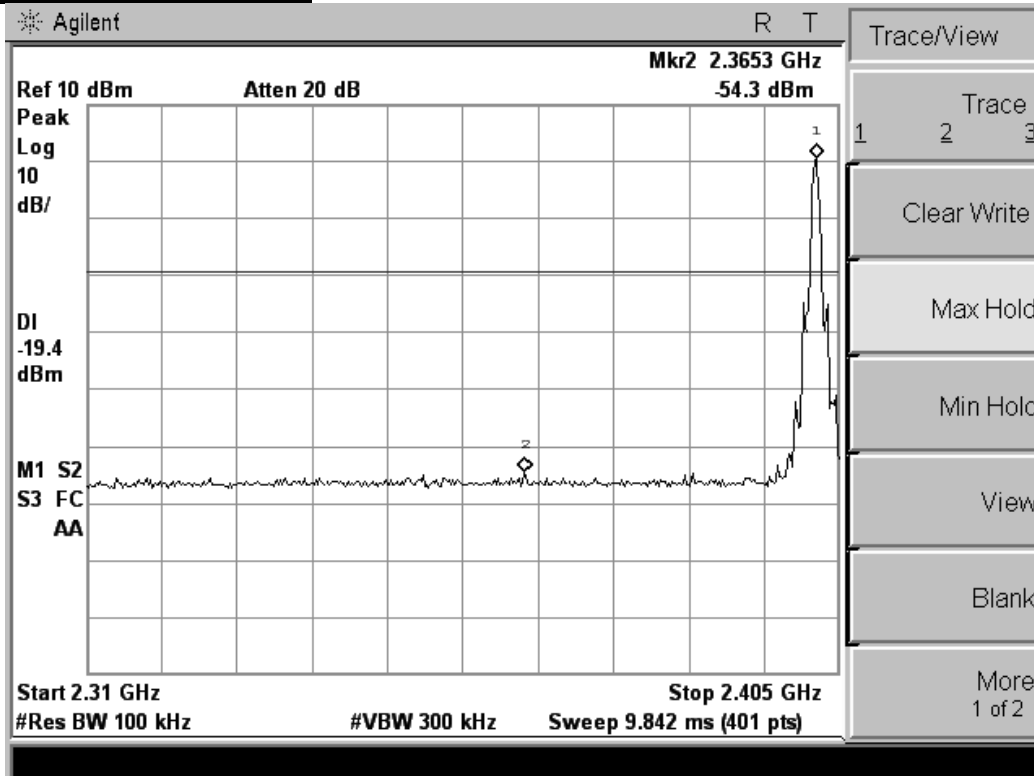

5. RADIATED MEASUREMENT

5.1 Test Equipment

Item	Equipment	Manufacturer	Model No.	Serial No.	Last Cal.	Next Cal.
1	3m Semi Anechoic Chamber	SIDT FRANKONIA	SAC-3M	03CH03-HY	2014-06-18	2015-06-17
2	Amplifier	SCHAFFNER	COA9231A	18667	2014-06-18	2015-06-17
3	Amplifier	Agilent	8449B	3008A02120	2014-06-16	2015-06-15
4	Amplifier	MITEQ	AMF-6F-260 400	9121372	2014-06-16	2015-06-15
5	Spectrum Analyzer	Agilent	E4407B	MY41440292	2014-06-16	2015-06-15
6	Signal analyzer	Agilent	E4448A(External mixers to 40GHz)	US44300469	2014-06-16	2015-06-15
7	Loop Antenna	R&S	HFH2-Z2	860004/001	2014-06-18	2015-06-17
8	By-log Antenna	SCHWARZBECK	VULB9163	9163-470	2014-06-10	2015-06-09
9	Horn Antenna	EMCO	3115	6741	2014-06-10	2015-06-09
10	Horn Antenna	SCHWARZBECK	BBHA9170	BBHA91701 54	2014-06-10	2015-06-09
11	RF Cable-R03m	Jye Bao	RG142	CB021	2014-06-18	2015-06-17
12	RF Cable-HIGH	SUHNER	SUCOFLEX 106	03CH03-HY	2014-06-18	2015-06-17

5.2 Block Diagram of Test Setup

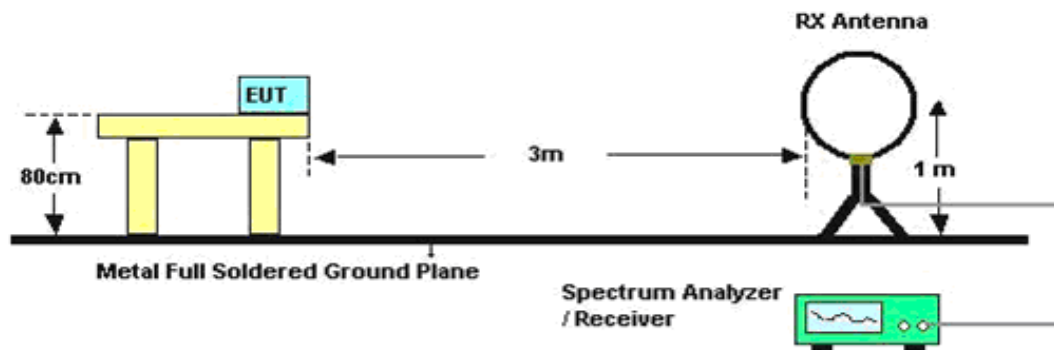

Below 30MHz

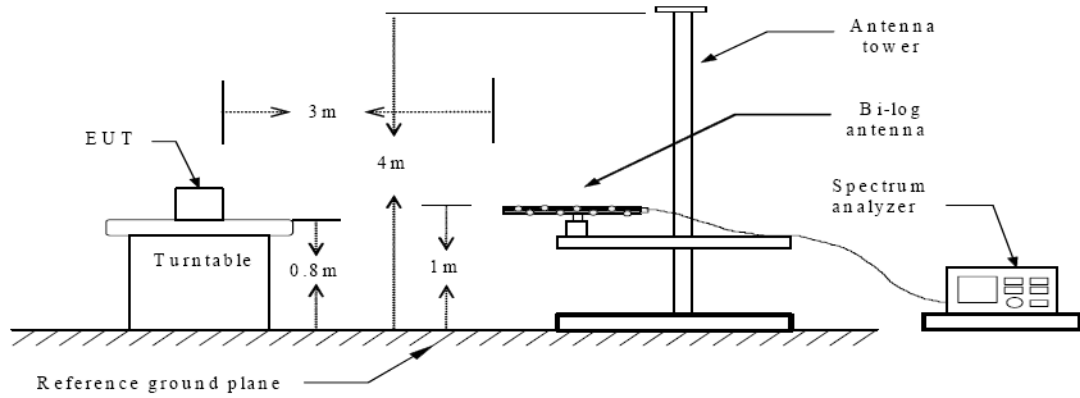

Below 1 GHz

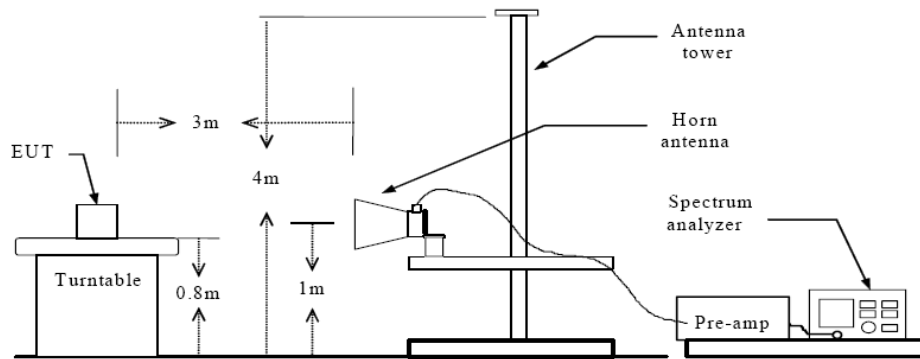

Above 1 GHz

5.3 Radiated Emission Limit

15.205 (a) Except as shown in paragraph (d) of this section, only spurious emissions are permitted in any of the frequency bands listed below:

MHz	MHz	MHz	GHz
0.090-0.110	16.42-16.423	399.9-410	4.5-5.15
\1\ 0.495-0.505	16.69475-16.69525	608-614	5.35-5.46
2.1735-2.1905	16.80425-16.80475	960-1240	7.25-7.75
4.125-4.128	25.5-25.67	1300-1427	8.025-8.5
4.17725-4.17775	37.5-38.25	1435-1626.5	9.0-9.2
4.20725-4.20775	73-74.6	1645.5-1646.5	9.3-9.5
6.215-6.218	74.8-75.2	1660-1710	10.6-12.7
6.26775-6.26825	108-121.94	1718.8-1722.2	13.25-13.4
6.31175-6.31225	123-138	2200-2300	14.47-14.5
8.291-8.294	149.9-150.05	2310-2390	15.35-16.2
8.362-8.366	156.52475-156.52525	2483.5-2500	17.7-21.4
8.37625-8.38675	156.7-156.9	2690-2900	22.01-23.12
8.41425-8.41475	162.0125-167.17	3260-3267	23.6-24.0
12.29-12.293.	167.72-173.2	3332-3339	31.2-31.8
12.51975-12.52025	240-285	3345.8-3358	36.43-36.5
12.57675-12.57725	322-335.4	3600-4400	(\2\)
13.36-13.41			

\1\ Until February 1, 1999, this restricted band shall be 0.490-0.510 MHz.

\2\ Above 38.6

Part 15.205 (b) Except as provided in paragraphs (d) and (e), the field strength of emissions appearing within these frequency bands shall not exceed the limits shown in Section 15.209. At frequencies equal to or less than 1000 MHz, compliance with the limits in Section 15.209 shall be demonstrated using measurement instrumentation employing a CISPR quasi-peak detector.

Above 1000 MHz, compliance with the emission limits in Section 15.209 shall be demonstrated based on the average value of the measured emissions. The provisions in Section 15.35 apply to these measurements.

Part 15.209 (a) Except as provided elsewhere in this Subpart, the emissions from an intentional radiator shall not exceed the field strength levels specified in the following table:

Frequency (MHz)	Field strength (microvolts/meter)	Measurement distance (meters)
0.009–0.490	2400/F(kHz)	300
0.490–1.705	24000/F(kHz)	30
1.705–30.0	30	30
30–88	100**	3
88–216	150**	3
216–960	200**	3
Above 960	500	3

5.4 Instruments Setting

The following table is the setting of spectrum analyzer and receiver.

Spectrum Parameter	Setting
Attenuation	Auto
Start Frequency	1000 MHz
Stop Frequency	10th carrier harmonic
RB / VB (Emission in restricted band)	1MHz / 1MHz for Peak, 1 MHz / 10Hz for Average
RB / VB (Emission in non-restricted band)	1MHz / 1MHz for Peak, 1 MHz / 10Hz for Average

Receiver Parameter	Setting
Attenuation	Auto
Start ~ Stop Frequency	9kHz~150kHz / RB 200Hz for QP
Start ~ Stop Frequency	150kHz~30MHz / RB 9kHz for QP
Start ~ Stop Frequency	30MHz~1000MHz / RB 100kHz for QP

5.5 Test Procedures

1. Configure the EUT according to ANSI C63.4. The EUT was placed on the top of the turntable 0.8 meter above ground. The phase center of the receiving antenna mounted on the top of a height-variable antenna tower was placed 3 meters far away from the turntable.
2. Power on the EUT and all the supporting units. The turntable was rotated by 360 degrees to determine the position of the highest radiation.
3. The height of the broadband receiving antenna was varied between one meter and four meters above ground to find the maximum emissions field strength of both horizontal and vertical polarization.
4. For each suspected emissions, the antenna tower was scan (from 1 m to 4 m) and then the turntable was rotated (from 0 degree to 360 degrees) to find the maximum reading
5. Set the test-receiver system to Peak or CISPR quasi-peak Detect Function with specified bandwidth under Maximum Hold Mode.
6. For emissions above 1GHz, use 1MHz VBW and RBW for peak reading. Then 1MHz RBW and 10Hz VBW for average reading in spectrum analyzer.
7. When the radiated emissions limits are expressed in terms of the average value of the emissions, and pulsed operation is employed, the measurement field strength shall be determined by averaging over one complete pulse train, including blanking intervals, as long as the pulse train does not exceed 0.1 seconds. As an alternative (provided the transmitter operates for longer than 0.1 seconds) or in cases where the pulse train exceeds 0.1 seconds, the measured field strength shall be determined from the average absolute voltage during a 0.1 second interval during which the field strength is at its maximum value.
8. If the emissions level of the EUT in peak mode was 3 dB lower than the average limit specified, then testing will be stopped and peak values of EUT will be reported, otherwise, the emissions which do not have 3 dB margin will be repeated one by one using the quasi-peak method for below 1GHz.
9. For testing above 1GHz, the emissions level of the EUT in peak mode was lower than average limit (that means the emissions level in peak mode also complies with the limit in average mode), then testing will be stopped and peak values of EUT will be reported, otherwise, the emissions will be measured in average mode again and reported.
10. In case the emission is lower than 30MHz, loop antenna has to be used for measurement and the recorded data should be QP measured by receiver. High – Low scan is not required in this case.

5.6 Results for Radiated Emissions

PASS.

Only record the worst test result in this report.

The test data please refer to following page:

Below 1GHz

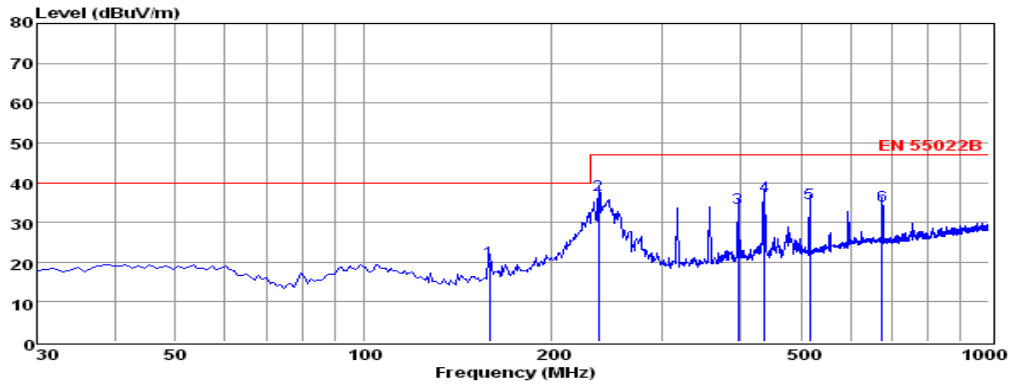

Env./Ins: 24°C/56%
 EUT: Bluetooth Speaker
 M/N: ES-53803BT
 Power Rating: DC 3.7V
 Test Mode: TX-2402
 Operator: Tree
 Memo:
 pol: HORIZONTAL

	Freq MHz	Reading dBuV	CabLos dB	Antfac dB/m	Measured dBuV/m	Limit dBuV/m	Over dB	Remark
1	159.01	10.66	0.83	8.63	20.12	40.00	-19.88	QP
2	237.58	24.06	0.96	11.98	37.00	47.00	-10.00	QP
3	396.66	17.26	1.30	14.98	33.54	47.00	-13.46	QP
4	437.40	19.47	1.41	15.55	36.43	47.00	-10.57	QP
5	516.94	16.49	1.42	16.90	34.81	47.00	-12.19	QP
6	675.05	14.04	1.57	18.72	34.33	47.00	-12.67	QP

Note: 1. All readings are Quasi-peak values.
 2. Measured= Reading + Antenna Factor + Cable Loss
 3. The emission that at 20db blow the official limit are not reported

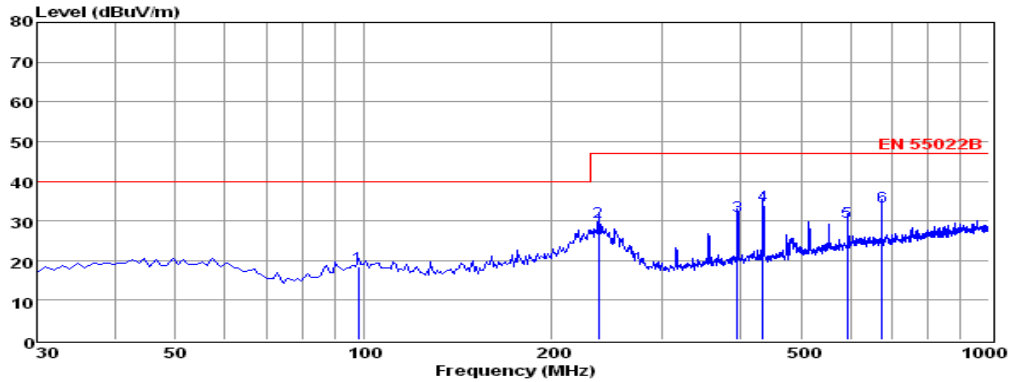

Env./Ins: 24°C/56%
 EUT: Bluetooth Speaker
 M/N: ES-53803BT
 Power Rating: DC 3.7V
 Test Mode: TX-2402
 Operator: Tree
 Memo:
 pol: VERTICAL

	Freq MHz	Reading dBuV	CabLos dB	Antfac dB/m	Measured dBuV/m	Limit dBuV/m	Over dB	Remark
1	97.90	4.88	0.61	13.03	18.52	40.00	-21.48	QP
2	237.58	16.76	0.96	11.98	29.70	47.00	-17.30	QP
3	395.69	14.90	1.30	14.96	31.16	47.00	-15.84	QP
4	435.46	16.81	1.41	15.54	33.76	47.00	-13.24	QP
5	593.57	9.95	1.51	18.33	29.79	47.00	-17.21	QP
6	674.08	13.21	1.57	18.72	33.50	47.00	-13.50	QP

Note: 1. All readings are Quasi-peak values.
 2. Measured= Reading + Antenna Factor + Cable Loss
 3. The emission that at 20db blow the official limit are not reported

***Note: Pre-scan all mode and recorded the worst case results in this report.

Above 1GHz

The worst test result for GFSK, Tx-Low Channel:

Freq. MHz	Reading dBuV	Ant. Fac. dB/m	Pre. Fac. dB	Cab. Loss dB	Measured dBuV/m	Limit dBuV/m	Margin dB	Remark	Pol.
4804.00	54.19	33.06	35.04	3.94	56.15	74	-17.85	Peak	Horizontal
4804.00	45.56	33.06	35.04	3.94	47.52	54	-6.48	Average	Horizontal
4804.00	54.94	33.06	35.04	3.94	56.90	74	-17.10	Peak	Vertical
4804.00	46.40	33.06	35.04	3.94	48.36	54	-5.64	Average	Vertical

The worst test result for GFSK, Tx-Middle Channel:

Freq. MHz	Reading dBuV	Ant. Fac. dB/m	Pre. Fac. dB	Cab. Loss dB	Measured dBuV/m	Limit dBuV/m	Margin dB	Remark	Pol.
4882.00	55.03	33.16	35.15	3.96	57.00	74	-17.00	Peak	Horizontal
4882.00	46.57	33.16	35.15	3.96	48.54	54	-5.46	Average	Horizontal
4882.00	56.61	33.16	35.15	3.96	58.58	74	-15.42	Peak	Vertical
4882.00	47.61	33.16	35.15	3.96	49.58	54	-4.42	Average	Vertical

The worst test result for GFSK, Tx-High Channel:

Freq. MHz	Reading dBuV	Ant. Fac. dB/m	Pre. Fac. dB	Cab. Loss dB	Measured dBuV/m	Limit dBuV/m	Margin dB	Remark	Pol.
4960.00	53.50	33.26	35.14	3.98	55.60	74	-18.40	Peak	Horizontal
4960.00	44.36	33.26	35.14	3.98	46.46	54	-7.54	Average	Horizontal
4960.00	54.93	33.26	35.14	3.98	57.03	74	-16.97	Peak	Vertical
4960.00	45.19	33.26	35.14	3.98	47.29	54	-6.71	Average	Vertical

Notes:

1. Measuring frequencies from 9k~10th harmonic (ex. 26GHz), No emission found between lowest internal used/generated frequency to 30MHz.
2. Radiated emissions measured in frequency range from 9k~10th harmonic (ex. 26GHz) were made with an instrument using Peak detector mode.
3. 18~25GHz at least have 20dB margin. No recording in the test report.

5.5 Results for Band edge Testing (Radiated)

Only record the worst test case (Tx, GFSK, Non-hopping) as following:

Tx-2402, GFSK, Non-hopping

Freq. MHz	Reading Level dBuV	Ant. Fac. dB/m	Pre. Fac. dB	Cab. Loss dB	Measured dBuV/m	Limit dBuV/m	Margin dB	Remark	Pol.
2361.14	45.73	32.89	35.16	3.51	46.97	74	-27.03	Peak	Horizontal
2361.19	36.03	32.90	35.16	3.51	37.28	54	-16.72	Average	Horizontal
2400.00	50.74	32.92	35.16	3.54	52.04	74	-21.96	Peak	Horizontal
2400.00	42.28	32.92	35.16	3.54	43.58	54	-10.42	Average	Horizontal
2375.37	48.16	32.89	35.16	3.51	49.40	74	-24.60	Peak	Vertical
2375.30	37.79	32.90	35.16	3.51	39.04	54	-14.96	Average	Vertical
2400.00	53.35	32.92	35.16	3.54	54.65	74	-19.35	Peak	Vertical
2400.00	43.00	32.92	35.16	3.54	44.30	54	-9.70	Average	Vertical

Tx-2480, GFSK, Non-hopping

Freq. MHz	Reading Level dBuV	Ant. Fac. dB/m	Pre. Fac. dB	Cab. Loss dB	Measured dBuV/m	Limit dBuV/m	Margin dB	Remark	Pol.
2483.50	49.16	33.06	35.18	3.60	50.64	74	-23.36	Peak	Horizontal
2483.50	37.82	33.08	35.18	3.60	39.32	54	-14.68	Average	Horizontal
2477.39	46.15	33.08	35.18	3.62	47.67	74	-26.33	Peak	Horizontal
2477.34	35.22	33.08	35.18	3.62	36.74	54	-17.26	Average	Horizontal
2483.50	48.98	33.06	35.18	3.60	50.46	74	-23.54	Peak	Vertical
2483.50	40.03	33.08	35.18	3.60	41.53	54	-12.47	Average	Vertical
2492.53	44.23	33.08	35.18	3.62	45.75	74	-28.25	Peak	Vertical
2492.41	35.93	33.08	35.18	3.62	37.45	54	-16.55	Average	Vertical

6. LINE CONDUCTED EMISSIONS

6.1 Standard Applicable

According to §15.207 (a) or RSS-GEN: For an intentional radiator which is designed to be connected to the public utility (AC) power line, the radio frequency voltage that is conducted back onto the AC power line on any frequency or frequencies within the band 150 kHz to 30 MHz shall not exceed 250 microvolt (The limit decreases linearly with the logarithm of the frequency in the range 0.15 MHz to 0.50 MHz). The limits at specific frequency range are listed as follows:

Frequency Range(MHz)	Limits (dB μ V)	
	Quasi-peak	Average
0.15 to 0.50	66 to 56	56 to 46
0.50 to 5	56	46
5 to 30	60	50

6.2 Test Equipment

Item	Equipment	Manufacturer	Model No.	Serial No.	Last Cal.	Next Cal.
1	EMC Receiver	R&S	ESCS30	100174	2014-06-18	2015-06-17
2	L.I.S.N	MESS Tec	NNB-2/16Z	99079	2014-06-18	2015-06-17
3	50 Ω Coaxial Switch	R&S	MP59B	M20531	2014-06-18	2015-06-17
4	Pulse Limiter	Anritsu	ESH3-Z2	100006	2014-06-18	2015-06-17
5	Voltage Probe	Rohde & Schwarz	TK9416	N/A	2014-06-18	2015-06-17
6	2M Cable	Huber+Suhner	SG	2231U	2014-06-18	2015-06-17

6.3 Block Diagram of Test Setup

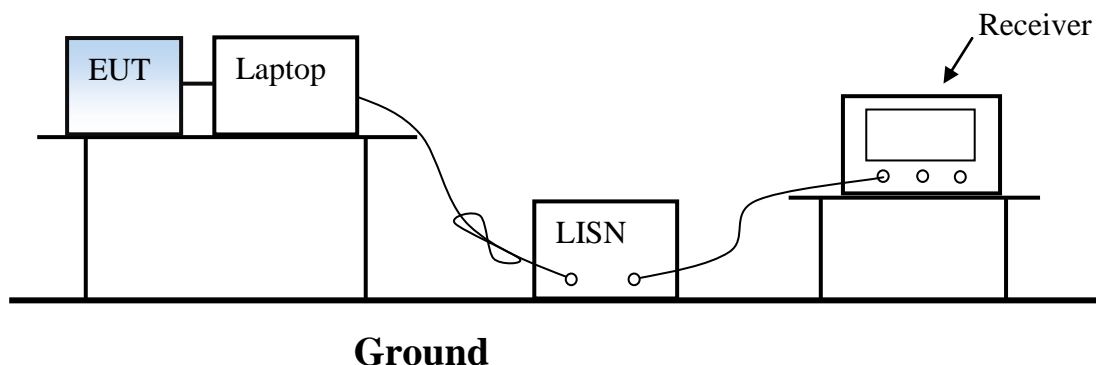

6.4 Test Results

PASS.

The test data please refer to following page.

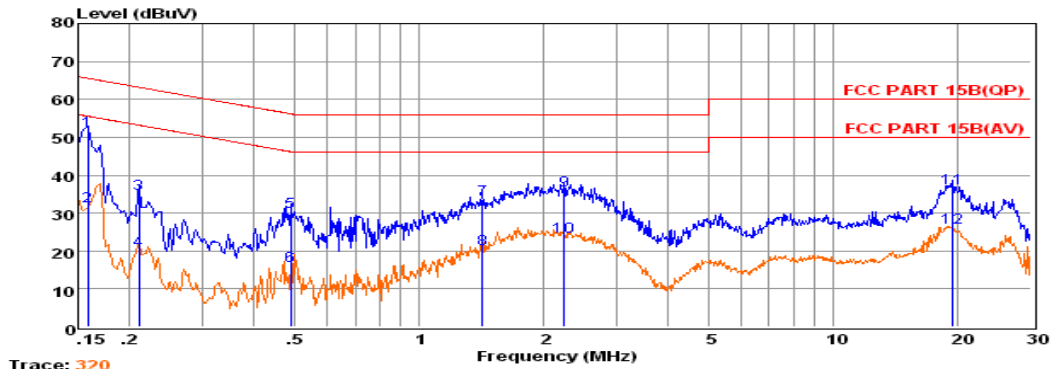

Trace: 320
 Env. Ins: 24*/56%
 EUT: Bluetooth Speaker
 M/N: ES-53803BT
 Power Rating: AC 120V/60Hz
 Test Mode: TX
 Operator: Tree
 Memo:
 Pol: NEUTRAL

	Freq	Reading	LisnFac	CabLos	Atten_Fac	Measured	Limit	Over	Remark
	MHz	dBuV	dB	dB	dB	dBuV	dBuV	dB	
1	0.15816	32.16	9.68	0.02	10.00	51.86	65.56	-13.70	QP
2	0.15826	12.19	9.68	0.02	10.00	31.89	55.55	-23.66	Average
3	0.21055	15.56	9.59	0.03	10.00	35.18	63.18	-28.00	QP
4	0.21065	0.75	9.59	0.03	10.00	20.37	53.18	-32.81	Average
5	0.48890	10.65	9.62	0.04	10.00	30.31	56.19	-25.88	QP
6	0.48900	-3.67	9.62	0.04	10.00	15.99	46.18	-30.19	Average
7	1.41817	13.78	9.63	0.05	10.00	33.46	56.00	-22.54	QP
8	1.41917	0.98	9.63	0.05	10.00	20.66	46.00	-25.34	Average
9	2.23675	16.38	9.63	0.05	10.00	36.06	56.00	-19.94	QP
10	2.23775	4.09	9.63	0.05	10.00	23.77	46.00	-22.23	Average
11	1119.42839	16.68	9.87	0.12	10.00	36.67	60.00	-23.33	QP
12	1219.42939	6.25	9.87	0.12	10.00	26.24	50.00	-23.76	Average

Remarks: 1. Measured = Reading + Lisn Factor +Cable Loss+Atten_Fac.
 2. The emission levels that are 20dB below the official limit are not reported.

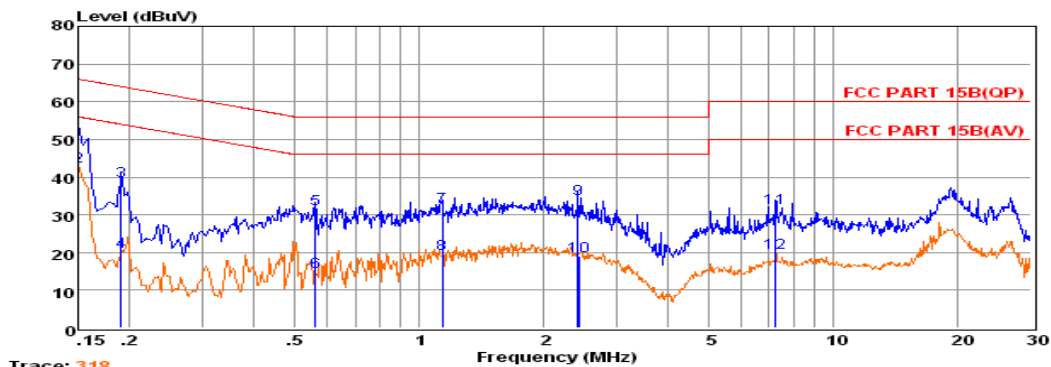

Trace: 318
 Env. Ins: 24*/56%
 EUT: Bluetooth Speaker
 M/N: ES-53803BT
 Power Rating: AC 120V/60Hz
 Test Mode: TX
 Operator: Tree
 Memo:
 Pol: LINE

	Freq	Reading	LisnFac	CabLos	Atten_Fac	Measured	Limit	Over	Remark
	MHz	dBuV	dB	dB	dB	dBuV	dBuV	dB	
1	0.15000	33.12	9.57	0.02	10.00	52.71	66.00	-13.29	QP
2	0.15010	23.35	9.57	0.02	10.00	42.94	55.99	-13.05	Average
3	0.19039	19.34	9.62	0.02	10.00	38.98	64.02	-25.04	QP
4	0.19049	0.47	9.62	0.02	10.00	20.11	54.02	-33.91	Average
5	0.56111	11.71	9.63	0.04	10.00	31.38	56.00	-24.62	QP
6	0.56121	-4.81	9.63	0.04	10.00	14.86	46.00	-31.14	Average
7	1.13523	12.37	9.63	0.05	10.00	32.05	56.00	-23.95	QP
8	1.13623	-0.03	9.63	0.05	10.00	19.65	46.00	-26.35	Average
9	2.42177	14.39	9.64	0.05	10.00	34.08	56.00	-21.92	QP
10	2.42277	-0.68	9.64	0.05	10.00	19.01	46.00	-26.99	Average
11	7.25179	12.05	9.68	0.07	10.00	31.80	60.00	-28.20	QP
12	7.25279	0.20	9.68	0.07	10.00	19.95	50.00	-30.05	Average

Remarks: 1. Measured = Reading + Lisn Factor +Cable Loss+Atten_Fac.
 2. The emission levels that are 20dB below the official limit are not reported.

Note: Pre-scan all modes and recorded the worst case results in this report.

7. ANTENNA REQUIREMENT

7.1 Standard Applicable

According to antenna requirement of §15.203.

An intentional radiator shall be designed to ensure that no antenna other than that furnished by the responsible party shall be used with the device. The use of a permanently attached antenna or of an antenna that uses a unique coupling to the intentional radiator shall be considered sufficient to comply with the provisions of this Section. The manufacturer may design the unit so that a broken antenna can be re-placed by the user, but the use of a standard antenna jack or electrical connector is prohibited. This requirement does not apply to carrier current devices or to devices operated under the provisions of Sections 15.211, 15.213, 15.217, 15.219, or 15.221. Further, this requirement does not apply to intentional radiators that must be professionally installed, such as perimeter protection systems and some field disturbance sensors, or to other intentional radiators which, in accordance with Section 15.31(d), must be measured at the installation site. However, the installer shall be responsible for ensuring that the proper antenna is employed so that the limits in this Part are not exceeded.

And according to §15.247(4)(1), system operating in the 2400-2483.5MHz bands that are used exclusively for fixed, point-to-point operations may employ transmitting antennas with directional gain greater than 6dBi provided the maximum peak output power of the intentional radiator is reduced by 1 dB for every 3 dB that the directional gain of the antenna exceeds 6dBi.

7.2 Antenna Connected Construction

7.2.1. Standard Applicable

According to § 15.203 & RSS-Gen, an intentional radiator shall be designed to ensure that no antenna other than that furnished by the responsible party shall be used with the device.

7.2.2. Antenna Connector Construction

The directional gains of antenna used for transmitting is 1.0dBi, and the antenna is on PCB board and no consideration of replacement. Please see EUT photo for details.

7.2.3. Results: Compliance.

.

8. MANUFACTURER/ APPROVAL HOLDER DECLARATION

The following series model(s):

--	--	--	--
----	----	----	----

Belong to the tested device:

Product description : Bluetooth Speaker

Model name : ES-53803BT

Remark: No additional models were tested.

-----THE END OF REPORT-----