

## Trademark Acknowledgment

BLACK+DECKER® and the BLACK+DECKER Logo are trademarks of the BLACK+DECKER Industrial Tool Co., or an affiliate thereof and are used under license.

The color scheme is a trademark for BLACK+DECKER power tools & accessories.

© 2021 BLACK+DECKER  
U.S. & Canada Only

Made in CHINA

Product Distributed by:  
CT Nova US LLC  
4700 Duke Drive Suite 200, Mason, OH 45040, USA

For product, service or warranty information contact us at:  
[support@ctnovatech.com](mailto:support@ctnovatech.com)  
**1-855-207-3922.**



**BDXNMBP01**  
**INSTRUCTION MANUAL**

# BLACK+ DECKER®

## INSTRUCTION MANUAL

### Digital Video Baby Monitor - PLUS



## BDXNMBP01

Part No. BMP-PUM-000-006  
English

Please read before returning this product for any reason.

## Before operating the appliance, please read all safety and operating instructions. Save all instructions in a safe place for future reference.

### Definitions: Safety Alert Symbols and Words

This instruction manual uses the following safety alert symbols and words to alert you to hazardous situations and your risk of personal injury or property damage.

**⚠ DANGER:** Indicates an imminently hazardous situation which, if not avoided, **will** result in death or serious injury.

**⚠ WARNING:** Indicates a potentially hazardous situation which, if not avoided, **could** result in death or serious injury.

**⚠ CAUTION:** Indicates a potentially hazardous situation which, if not avoided, **may** result in minor or moderate injury.

**⚠** (Used without word) Indicates a safety related message.

**NOTICE:** Indicates a practice **not related to personal injury** which, if not avoided, **may** result in property damage.

**⚠ WARNING:** *This product can expose you to chemicals including Bisphenol A (BPA), which is known to the State of California to cause birth defects or other reproductive harm. For more information, go to [www.P65Warnings.ca.gov](http://www.P65Warnings.ca.gov).*

**⚠ WARNING!** *Read all safety warnings and all instructions. Failure to follow the warnings and instructions may result in electric shock, fire and/or serious injury.*

**👤 WARNING:** *To reduce the risk of injury, read the instruction manual.*

## DISPOSING OF APPLIANCE



Do not dispose of the appliance via household trash!

## IMPORTANT SAFETY INSTRUCTIONS

When using an electrical appliances, basic precautions should always be followed, including the following:

**⚠ WARNING:** *To reduce the risk of fire, electrical shock or injury:*

- *Shock Hazard. To protect against risk of electrical shock, do not put the power adapter in water or other liquid.*
- *Use only as described in this manual. Use only manufacturer's recommended attachments.*
- *Never modify the product or any part of it. Damage or personal injury could result.*
- *Do not use with damaged cord or power adapter. If appliance is not working as it should, has been dropped, damaged, left outdoors, or dropped into water, return it to a service center.*
- *Do not pull or carry by cord, use cord as a handle, close a door on cord, or pull cord around sharp edges or corners. Do not run appliance over cord. Keep cord away from heated surfaces.*
- *Do not operate outdoors.*
- *This appliance is intended for household use only and not for commercial or industrial use.*
- *Plug the plug directly into an electrical outlet.*
- *Do not handle power adapter with wet hands.*
- *Use the power adapter only in a standard electrical outlet (120V/60Hz).*
- *Turn off the switch before unplugging.*
- *Turn off the appliance if you need to remove.*
- *This appliance shall not be used by children. Keep the appliance and its cord out of reach of children.*
- *Place the appliance on a still and stable surface while use.*
- *Pull the power adapter out of the socket when not in use.*
- *Never place items on top of the appliance when it is in use.*
- *Please store the product in a cool and dry location.*
- *If the chargers and power adapters damaged, it must be replaced by the manufacturer, its service agent or similarly qualified persons in order to avoid a hazard.*
- *This product is not a toy. Do not allow children to play with it.*
- *This Baby Monitor is not a substitute for responsible adult supervision.*
- *Keep this User's Guide for future reference.*
- *Do not place the Baby Unit or cords in the cot or within reach of the baby (the unit and cords should be more than 1 metre away).*
- *Keep the cords out of reach of children.*
- *Do not cover the Baby Monitor with a towel or blanket.*
- *Never use extension cords with power adapters. Only use the power adapters provided.*
- *Test this monitor and all its functions so that you are familiar with it prior to actual use.*
- *Do not use the Baby Monitor near water.*
- *Do not place the Baby Monitor near a heat source.*
- *Only use the chargers and power adapters provided. Do not use other chargers or power adapters as this may damage the device and battery pack.*

## SAFETY INSTRUCTIONS

### **⚠ WARNING:**

- **Have servicing performed by a qualified repair person using only identical replacement parts.** This will ensure that the safety of the product is maintained.
- **Do not store or use the appliance near high temperature areas and keep away from direct sunlight.**
- **Use of improper extension cord could result in risk of fire, electric shock or electrocution.**
- **Do not operate the product if it has received a sharp blow, been dropped or otherwise damaged in any way.** Take it to an authorized service center.
- **Do not disassemble the product; take it to an authorized service center when service or repair is required.** Incorrect reassembly may result in a risk of electric shock, electrocution or fire.
- **Disconnect the power adapter from the outlet before attempting any cleaning.** This will reduce the risk of electric shock.

## CUSTOMER ASSISTANCE

### Product Service & Support

For any questions about operating this new BLACK+DECKER branded product, PLEASE CONTACT US FIRST... do not return this product to the retail store. The contact information for support will vary depending on the country in which you purchased and utilize the product.

To obtain warranty service or other information for products purchased from CT Nova itself or through its authorized reseller or agent and utilized in the U.S.A., please visit [www.ctnovatech.com](http://www.ctnovatech.com). You will receive instructions on how to ship the products at your expense to an our Authorized Service Center. To obtain service, you must include: (a) a copy of your receipt, bill of sale or other comparable proof of purchase; (b) a written description of the problem; and, most importantly; (c) your address and telephone number.

For further information needed on its features, please visit [www.ctnovatech.com](http://www.ctnovatech.com) for frequently asked questions and the electronic manual.

©2021 CT Nova US LLC  
4700 Duke Drive Suite 200, Mason, OH 45040, USA

## SAVE THESE INSTRUCTIONS

### Important Safety Instructions for All Battery Packs

#### **⚠ WARNING:**

**Read all safety warnings and all instructions for the battery pack and charger base. Failure to follow the warnings and instructions may result in electric shock, fire and/or serious injury.**

- **Do not charge the battery pack/product in explosive atmospheres, such as in the presence of flammable liquids, gases or dust.**
- **Recharge only with the charger specified by the manufacturer.**
- **DO NOT splash or immerse in water or other liquids.**
- **Do not store or use the product in locations where the temperature may reach or exceed 104 °F (40 °C) (such as outside sheds or metal buildings in summer).** For best life, store product in a cool, dry location.
- **Do not incinerate the battery pack/product even if it is severely damaged or is completely worn out.** The battery pack can explode in a fire. Toxic fumes and materials are created when lithium ion battery packs are burned.
- **If battery contents come into contact with the skin, immediately wash area with mild soap and water.** If battery liquid gets into the eye, rinse water over the open eye for 10 minutes or until irritation ceases.

#### **⚠ WARNING:**

**Burn hazard.** Battery liquid may be flammable if exposed to spark or flame.

#### **⚠ WARNING:**

**Fire hazard.** Never attempt to open the battery pack for any reason. If the battery pack case is cracked or damaged, do not insert into the charger. Do not crush, drop or damage the battery pack. Do not use a battery pack or charger that has received a sharp blow, been dropped, run over or damaged in any way (e.g., pierced with a nail, hit with a hammer, stepped on). Damaged battery packs should be returned to the service center for recycling.

### Important Safety Instructions for All Battery Chargers

#### **⚠ WARNING:**

- **DO NOT attempt to charge the battery pack with any chargers other than the ones in this manual.** The charger and battery pack are specifically designed to work together.
- **Do not expose the charger to rain or snow.**
- **Place the product in a position away from any heat source.**
- **Do not disassemble the product; take it to an authorized service center when service or repair is required.** Incorrect reassembly may result in a risk of electric shock, electrocution or fire.
- **The charger is designed to operate on standard 120V household electrical power. Do not attempt to use it on any other voltage.**

# COMPLIANCE

## FCC Caution

Any Changes or modifications not expressly approved by the party responsible for compliance could void the user's authority to operate the equipment.

This device complies with part 15 of the FCC Rules. Operation is subject to the following two conditions: (1) This device may not cause harmful interference, and (2) this device must accept any interference received, including interference that may cause undesired operation.

## IMPORTANT NOTE

This equipment has been tested and found to comply with the limits for a Class B digital device, pursuant to part 15 of the FCC Rules. These limits are designed to provide reasonable protection against harmful interference in a residential installation. This equipment generates, uses and can radiate radio frequency energy and, if not installed and used in accordance with the instructions, may cause harmful interference to radio communications. However, there is no guarantee that interference will not occur in a particular installation. If this equipment does cause harmful interference to radio or television reception, which can be determined by turning the equipment off and on, the user is encouraged to try to correct the interference by one or more of the following measures:

- Reorient or relocate the receiving antenna.
- Increase the separation between the equipment and receiver.
- Connect the equipment into an outlet on a circuit different from that to which the receiver is connected.
- Consult the dealer or an experienced radio/TV technician for help.

## FCC Radiation Exposure Statement

This equipment complies with FCC radiation exposure limits set forth for an uncontrolled environment. This equipment should be installed and operated with minimum distance 20cm between the radiator& your body.

## ISED Warning

This device complies with Innovation, Science, and Economic Development Canada licence-exempt RSS standard(s). Operation is subject to the following two conditions:

- (1) this device may not cause interference, and
- (2) this device must accept any interference, including interference that may cause undesired operation of the device.

The device is compliance with RF exposure guidelines, users can obtain Canadian information on RF exposure and compliance. The minimum distance from body to use the device is 20cm.

The device has been tested and comply with ISED SAR limits.

## Radiation Exposure

The baby unit complies with FCC/ISED radiation exposure limits set forth for an uncontrolled environment. The baby unit should be installed and operated with minimum distance 20cm between the radiator& your body.

The parent unit complies with FCC/ISED radiation exposure limits set forth for an uncontrolled environment.

# PRODUCT VIEW - PARENT UNIT

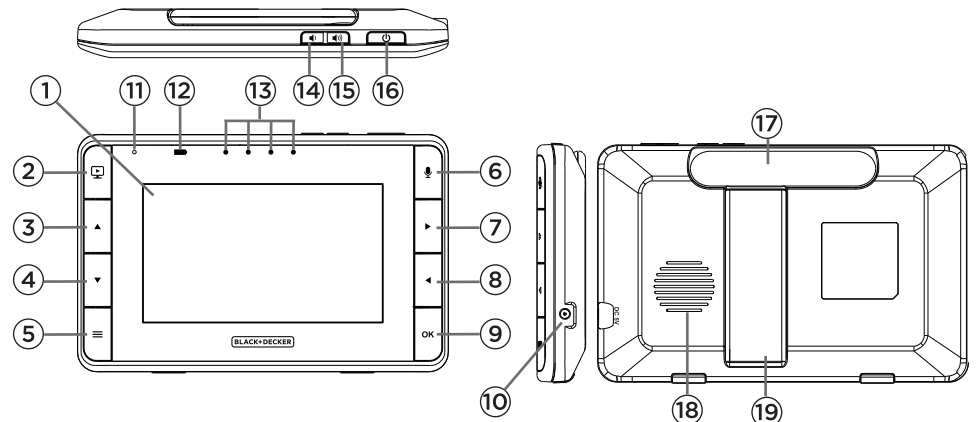

- |   |   |   |
|---|---|---|
| 1. Display (LCD screen)                                     | 7. RIGHT button<br>Normal Mode: Pan Right<br>Menu Mode: Right | 16. Power button                          |
| 2. VIDEO ON/OFF<br>Press to turn the LCD screen ON/OFF      | 8. LEFT button<br>Normal Mode: Pan Left<br>Menu Mode: Left    | 17. Antenna                               |
| 3. UP button<br>Normal Mode: Tilt Up<br>Menu Mode: Up       | 9. OK button  | 18. Speaker                               |
| 4. DOWN button<br>Normal mode: Tilt Down<br>Menu mode: Down | 10. Power adapter socket                                      | 19. Stand (Reset button behind the stand) |
| 5. MENU button<br>Press to open the Menu options            | 11. Mic   |   |
| 6. Talk button<br>Press and hold to speak to your baby      | 12. LED Indicators for charging                               |   |
|   | 13. Audio Level LEDs (4 Levels)                               |   |
|   | 14. -Volume button  |   |
|   | 15. +Volume button  |   |

## Menu icons

	Signal Level (5 Levels)
	Night Vision Mode (Screen changes to Black/White)
	Talk Mode
	Battery Level Indication (4 Levels)
	Pan Left
	Pan Right
	Tilt Up
	Tilt Down
	Zoom Level Control (1X, 2X)
	Temperature scale select (°F / °C)

	Lullaby Control (5 Sound Selections)
	Alarm Setting (off, 2h, 4h, 6h)
	Readings display in White, but turn RED >84°F / 29°C or < 57°F / 14°C, Display Hi °F/°C if > 97°F / 36°C, Display Lo °F/°C if < 34°F / 1°C
	Camera Control (delete, add, view, scan)
	Set Screen Off Timer (Off <input type="checkbox"/> , 5 mins, 30 mins, 60 mins)
	Volume Level Control (8 Levels)
	No Baby Unit detected

## PRODUCT VIEW - BABY UNIT

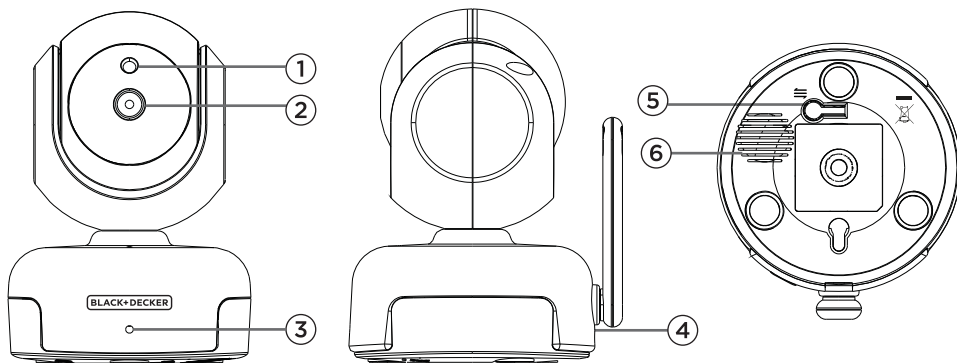

1. Photo Sensor (Night Vision Mode)
2. Camera Lens
3. Power LED
4. Power ON/OFF switch
5. Pairing button
6. Speaker

## MAJOR COMPONENTS AND ATTACHMENTS



Parent Unit



Baby Unit (Camera)



Power adaptor x2



Instruction Manual

## INSTALLATION GUIDE

### Important guidelines for installing your Baby Monitor

- To use your Video Monitor Baby and Parent Units together, you must be able to establish a radio link between them, and the range will be affected by environmental conditions.
- Any large metal object, like a refrigerator, a mirror, a filing cabinet, metallic doors or reinforced concrete between the Baby and Parent Unit may block the radio signal.
- The signal strength may also be reduced by other solid structures, like walls, or by radio or electrical equipment, such as TVs, computers, cordless or mobile phones, fluorescent lights or dimmer switches.
- Use of other 2.4 GHz products, such as wireless networks (Wi-Fi® routers), Bluetooth™ systems, or microwave ovens, may cause interference with this product, so keep the Baby Monitor away if appears to be causing interference.
- If the signal is weak, try moving the Parent and/or the Baby Unit to different positions in the room(s).

**⚠ WARNING:** Strangulation Hazard: Children have STRANGLED in cords. Keep this cord out of the reach of children (more than 1m (3ft) away). Never use extension cords with power adapters. Only use the power adapters provided.

## BABY UNIT SET UP & USE

- Choose a location for the Baby Unit that will provide the best view of your baby in their cot.
- Place the Baby Unit on a flat surface, such as dresser, desk, or shelf or mount the Unit to a wall securely using the keyhole slots on the underside of the stand.

### ⚠ WARNING:

- NEVER place the Baby Unit or cords inside your child's cot.
- Do not place the Baby Unit or cords in the cot or within reach of the baby (the unit and cords should be more than 1 meter away).
- This digital video Baby Monitor is compliant with all relevant standards regarding electromagnetic fields and is, when handled as described in the User's Guide, safe to use.
- Always read the instructions in this User's Guide carefully before using the device.

### ⚠ CAUTION:

- The Parent Unit includes a built-in, lithium-ion rechargeable battery pack, which is not a user-accessible item. If you think the battery needs replacing, please contact CT Nova. Do not try to replace it yourself.
- Risk of explosion if battery is replaced by an unapproved battery type. Dispose of used batteries according to their instructions.
- The Unit should be set up and used so that parts of the user's body other than the hands are maintained at a distance of approximately 8 inches (20 cm) or more.

## Baby Unit Power Supply

1. Connect the power adapter to the Baby Unit (camera). Only use the enclosed power adapter (5V DC /1000mA).
2. Slide the POWER ON/OFF switch to the ON position. The power LED will light up in blue.
3. Slide the POWER ON/OFF switch to the OFF position to turn the Baby Unit off.

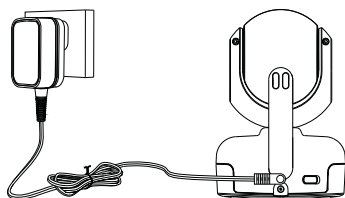

## Parent Unit Power Supply

**CAUTION:** The Parent Unit is assembled with a built-in rechargeable battery pack (Lithiumion battery 3.8V 2000mAh), please charge it for 16 hours before initial use. The battery is not a user-accessible item. Please contact CT NOVA if you think it needs replacing.

1. Connect the power adapter to the Parent Unit. Only use the enclosed power adapter (5V DC / 1000mA).
2. Press and hold the POWER ON/OFF button for 3 seconds to turn ON the Parent Unit.
3. Once the Baby and Parent Units are switched on, the display on the Parent Unit will show the video captured by the Baby Unit.
4. If there is no connection or you are out of range, the unit will beep every few seconds. Move the Parent Unit closer to the Baby Unit until the link is re-established.
5. Press and hold the ON/OFF button, until the progress bar finishes scrolling, to turn OFF the Parent Unit.

**Note:** The battery icon  indicate that the battery is low, and the parent unit will beeping. The battery needs to be recharged; it will take 16 hours to charge fully.

### When charging



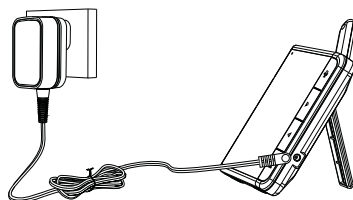















1. If the Parent Unit is turned OFF with the adapter plugged in, a flashing battery logo will display. The Red LED at the top left will light up; indicating that the adapter is plugged in and charging is continuing.
2. Whilst the power is ON, and the adapter is plugged in, the battery icon at the top right corner of the screen will show that the battery is charging. The Red LED at the top left will light up to indicate that the adapter is plugged in.





## Registration (Pairing)

The Baby Monitor is pre-registered to your Parent Unit. You do not need to register it again unless the Baby Unit loses its link with the Parent Unit.

To re-register your Baby Unit, or register a new Baby Unit, follow the procedures below:

1. Press the  button of the Parent Unit and the menu bar will pop up.
2. Press the  LEFT button or  RIGHT button until  is highlighted, the  del /  add /  view /  scan menu will pop up.
3. Press the  UP button or  DOWN button to select  add, and press the **OK** button to confirm.
4. Camera  1 /  2 /  3 /  4 will pop up, press the  UP button or  DOWN button to select the desired Camera and press the **OK** button  to start searching for a camera unit.

**Note:** If a camera is currently paired with the Parent Unit, its camera location (with a  against it) cannot be selected for a new registration.

5. Press the camera  pairing button to confirm.
6. Press and hold the  pairing button underneath the Baby Unit until the Parent Unit finds the camera, beeps and PAIR OK appears on the screen. The video from the camera will then appear.

**Note:** If a particular Baby Unit was registered previously, registering this current Baby Unit again will cancel its old registration.

## Setting up

- Place the Baby Unit in a convenient location (e.g. on a table) and point the camera lens towards the area you want to monitor.
- Adjust the angle of the Baby Unit's camera by moving it up, down, left and right until you are satisfied with the image shown on the Parent Unit.

**WARNING:** Do not place the Baby Unit within the baby's reach! If there is interference with the picture or sound, try moving the units to different locations, and ensure they are not close to other electrical equipment.

## Pan and Tilt



The camera can be remotely controlled from the Parent Unit when in a camera viewing mode.

1. Press the  UP button or  DOWN button to tilt up or down.
2. Press the  LEFT button or  RIGHT button to pan left or right.

## Night Vision Mode

The Baby Unit has infrared LEDs for picking up clear images in the dark. When the built-in photo sensor on the front of the unit detects a low level of ambient light, the LEDs will automatically activate and the screen on the Parent Unit will display in black and white. The  icon will be displayed at the top of the screen.

## Talk Mode

Press and hold the  TALK button on the Parent Unit to talk to your baby through the Baby Unit's loudspeaker. The  icon will be display at the top of the LCD screen.

## Video ON/OFF

Press  VIDEO ON/OFF button to turn the LCD screen on or off, whilst still leaving the audio monitor on.

## Temperature Display (Hi °F / °C or Lo °F / °C)

The temperature reading from the temperature sensor at the back of the Baby Unit will be displayed at the top of the LCD screen. The readings will turn RED if the temperature goes above 84°F / 29°C or below 57°F / 14°C. The reading will change to Hi °F / °C if the temperature goes above 97°F / 36°C. The reading will change to Lo °F / °C if the temperature goes below 34°F / 1°C.

## PARENT UNIT MENU OPTIONS

### Volume

Press the Volume button or to adjust the volume level, the icon will pop up and you can select the desired volume level from level 0-8.(The default volume level setting is level 5, and level 0 is OFF.)

### Brightness

1. Press the button and the menu bar will pop up.
2. Press the LEFT button or RIGHT button until is highlighted.
3. Press the UP button or DOWN button to select the desired brightness level from level 1 - 8.

### Lullaby

1. Press the button and the menu bar will pop up.
2. Press the LEFT button or RIGHT button until is highlighted.
3. Press the UP button or DOWN button to select from the 5 sounds available. If a sound is selected, it will repeat continually until it is unselected.

**Note: Select** will randomly start playing sounds

### Zoom

1. Press the button and the menu bar will pop up with highlighted.
2. Press the UP button or DOWN button to select 1X or 2X **Zoom**.

### Alarm

1. Press the button and the menu bar will pop up.
2. Press the LEFT button or RIGHT button until is highlighted.
3. Press the UP button or DOWN button to select the alarm time (2h, 4h, 6h).
4. If an alarm time is selected, the Parent Unit will beep for about 45 seconds after every 2, 4 or 6 hour period.

## View a camera

1. Press the button and the menu bar will pop up.
2. Press the LEFT button or RIGHT button until is highlighted, and the del/ add/ view/ scan menu will pop up.
3. Press the UP button or DOWN button to select view, and press the **OK** button to confirm.
4. Camera 1/ 2 / 3 / 4 will pop up, press the UP button or DOWN button to select the desired Camera, and press the **OK** button to view the picture from that camera.

Note: Only camera locations with a can selected.

TIP: Quick Method to View Cameras instead of entering into the menu bar. Directly press the **OK** button repeatedly to select the available Camera options from 1/ 2 / 3 / 4.

## Delete a camera

1. Press the button and the menu bar will pop up.
2. Press the LEFT button or RIGHT button until is highlighted, and the del/ add/ view/ scan menu will pop up.
3. Press the UP button or DOWN button to select del, and press the **OK** button to confirm.
4. Camera 1/ 2 / 3 / 4 will pop up, press the UP button or DOWN button to select the desired Camera, and press the **OK** button.
5. Press the UP button or DOWN button to select , then press the **OK** button to delete that registration.

NOTE : You are not allowed to delete the camera if there is only one registered camera in the system.

## Scan camera

This function is only available when you have more than 1 Baby Unit (Camera).







1. Press the button and the menu bar will pop up.
2. Press the LEFT button or RIGHT button until is highlighted, and the del/ add/ view/ scan menu will pop up.
3. Press the UP button or DOWN button to select scan, and press the **OK** button to confirm.
4. The screen will then display images from different registered cameras in a loop of Camera 1/ 2 / 3 / 4 , changing about every 12 seconds.

## Temperature

1. Press the button and the menu bar will pop up.
2. Press the LEFT button or RIGHT button until is highlighted.
3. Press **OK**, then UP button or DOWN to select °F or °C.

## Battery power saving mode

**NOTE:** (only available when the Parent Unit is not connected with power adapter)

1. Press the  button and the menu bar will pop up.
2. Press the  LEFT button or  RIGHT button until  is highlighted.
3. Press the  UP button or  DOWN button to select auto video off after 5 mins, 30 mins or 60 mins.
4.  will display on top of screen.

**NOTE:** You can press any key to switch the video back on.

## CLEANING

### **WARNING:** Unplug and turn off before cleaning.

Clean the Baby Monitor with a slightly damp cloth or with an anti-static cloth. Never use cleaning agents or abrasive solvents.

- Do not clean any part of the product with thinners or other solvents and chemicals – this may cause permanent damage to the product which is not covered by the warranty.
- Keep the Baby Monitor away from hot, humid areas or strong sunlight, and don't let it get wet.
- Every effort has been made to ensure high standards of reliability for your Baby Monitor. However, if something does go wrong, please do not try to repair it yourself – contact CT Nova for assistance.

	Problem	Checklist	Solution
1	Display - No display	<ul style="list-style-type: none"> <li>• Baby Unit turned on (Red &amp; Blue ON/OFF LED lit).</li> <li>• Select correct camera</li> <li>• Turn on video display</li> <li>• Try recharging or press the RESET button once on the Parent Unit (behind the stand).</li> </ul>	<ul style="list-style-type: none"> <li>• Press and hold the ON/OFF button on the Parent Unit to turn it ON.</li> <li>• Change the camera number.</li> <li>• Press the VIDEO ON/OFF button to turn it on.</li> <li>• Try recharging or press the RESET button once on the Parent Unit.</li> </ul>
2	Registration - Baby Unit has lost its link with the Parent Unit	<ul style="list-style-type: none"> <li>• If the Baby Unit is too far away it may be going out of range.</li> <li>• Reset the units by disconnecting the Baby Unit from electrical power and press the RESET button once on the Parent Unit. Wait about 15 seconds before reconnecting.</li> <li>• If there is a need to re-register the units.</li> </ul>	<ul style="list-style-type: none"> <li>• Move the Baby Unit closer to the Parent Unit.</li> <li>• Allow up to one minute for the Baby Unit and the Parent Unit to synchronise.</li> <li>• See P.13 Registration (Pairing).</li> </ul>
3	Interference - Noise interference on your Parent Unit	<ul style="list-style-type: none"> <li>• Your Baby and Parent Units may be too close.</li> <li>• Make sure there is at least 1 to 2 metres between the 2 units to avoid audio feedback.</li> <li>• Baby unit is too far away it may be out of range.</li> <li>• Make sure the Baby and Parent Units are not near other electrical equipment, such as a television, computer or cordless/mobile telephone.</li> <li>• Use of other 2.4 GHz products, such as wireless networks (Wi-Fi® routers), Bluetooth™ systems, or microwave ovens, may cause interference with this product.</li> <li>• Signal is weak.</li> </ul>	<ul style="list-style-type: none"> <li>• Move them farther apart.</li> <li>• Move the Baby Unit closer to the Parent Unit.</li> <li>• Keep the baby monitor away at least 1.5m (5ft) from these types of products, or turn them off if they appear to be causing interference.</li> <li>• Try moving the Parent and/or Baby Unit to different positions in the rooms.</li> </ul>



## Technical Specifications

### BABY UNIT

Image Sensor	colour CMOS 0.3M Pixels
Power Adapter	Input: 100-240V AC, 50/60Hz, 300mA; Output: 5.0V DC, 1000mA WARNING: Use only with supplied power supply.

### PARENT UNIT

Display	4.3" TFT LCD
Brightness control	8 level
Volume control	8 level
Power Adapter	Input: 100-240V AC, 50/60Hz, 300mA; Output: 5.0V DC, 1000mA WARNING: Use only with supplied power supply.
Battery (built-in)	3.8V, 2000mAh Lithium-Ion Polymer, rechargeable battery pack WARNING: Do not attempt to replace the battery, contact Customer Service if it needs replacing.

## WARRANTY & TRADEMARK ACKNOWLEDGMENT

### Three-Year Limited Warranty

CT Nova warrants to the original consumer purchaser only that this product and the component parts thereof, will be free from defects in workmanship and materials. CT Nova will, repair or replace, at its sole option and discretion, this product or any defective parts. CT Nova's liability hereunder shall be limited to repair or replacement of the defective part or parts, and such correction shall constitute a fulfillment of all of CT Nova's warranties hereunder.

This limited 3-year warranty is only valid for the original consumer purchaser in limited jurisdictions and is not transferrable. This limited 3-year warranty will automatically terminate if this product is sold or otherwise transferred to another party. The product must be purchased from CT Nova or an authorized dealer or the warranty is void. This limited 3-year warranty is valid only for products purchased and utilized in specific jurisdictions. Please visit our website at [www.ctnovatech.com](http://www.ctnovatech.com) for a list of jurisdictions wherein this 3-year limited warranty is valid.

This limited 3-year warranty does not apply to accessories and consumables and does not cover damage due to misuse, abuse, negligence, acts of God, accident, commercial use or modification of, or to any part of this product. This warranty does not cover damage due to improper operation, maintenance or installation; ordinary wear and tear; or attempted alterations or repairs by anyone other than CT Nova or someone authorized by CT Nova to do warranty work. Any unauthorized alterations or repairs will void this warranty. This limited 3-year warranty does not cover product sold AS IS or WITH ALL FAULTS. This limited 3-year warranty is invalid if the factory applied serial number or date stamp has been altered, defaced or removed from this product. This limited 3-year warranty does not cover product purchased or utilized in a jurisdiction not covered.

The procedure for obtaining service and support, and the applicability of this warranty, will vary depending on the country or jurisdiction in which you purchase and utilize the product. For details on obtaining product service, support and other warranty information please visit [www.ctnovatech.com](http://www.ctnovatech.com).

This warranty gives you specific legal rights, and you may also have other rights which vary from state to state and country to country.

EXCEPT AS EXPRESSLY SET FORTH IN THIS WARRANTY, CT NOVA MAKES NO OTHER WARRANTIES, EXPRESSED OR IMPLIED, INCLUDING ANY IMPLIED WARRANTIES OF MERCHANTABILITY AND FITNESS FOR A PARTICULAR PURPOSE. CT NOVA EXPRESSLY DISCLAIMS ALL WARRANTIES NOT STATED IN THIS LIMITED WARRANTY. ANY IMPLIED WARRANTIES THAT MAY BE IMPOSED BY LAW ARE LIMITED TO THE TERMS OF THIS EXPRESSED WARRANTY.

LIMITATION OF REMEDIES AND DAMAGES. REPAIR OR REPLACEMENT AS PROVIDED UNDER THIS WARRANTY IS THE EXCLUSIVE REMEDY OF THE CONSUMER. CT NOVA SHALL NOT BE LIABLE FOR ANY INCIDENTAL OR CONSEQUENTIAL DAMAGES, INCLUDING BUT NOT LIMITED TO ATTORNEYS' FEES AND/OR COSTS OF LITIGATION, FOR BREACH OF ANY EXPRESS OR IMPLIED WARRANTY ON THIS PRODUCT. CT NOVA IS NOT LIABLE FOR ANY DAMAGES CAUSED BY THE PRODUCT OR BY THE PRODUCT TO PERFORM, INCLUDING ANY LOST PROFITS, LOST SAVINGS, INCIDENTAL DAMAGES, OR CONSEQUENTIAL DAMAGES. CT NOVA IS NOT LIABLE FOR ANY CLAIM MADE BY A THIRD PARTY OR MADE BY YOU FOR A THIRD PARTY. THIS LIMITATION APPLIES WHETHER DAMAGES ARE SOUGHT, OR A CLAIM MADE, UNDER THIS WARRANTY OR AS A TORT CLAIM (INCLUDING NEGLIGENCE OR STRICT PRODUCT LIABILITY), A CONTRACT CLAIM, OR ANY OTHER CLAIM. THIS LIMITATION CANNOT BE WAIVED OR AMENDED BY ANY PERSON. THIS LIMITATION OF LIABILITY WILL BE EFFECTIVE EVEN IF CT NOVA OR AN AUTHORIZED REPRESENTATIVE OF CT NOVA HAS BEEN ADVISED BY YOU OF THE POSSIBILITY OF ANY SUCH DAMAGES.

Some states and countries do not allow limitations on how long an implied warranty lasts and do not allow the exclusion or limitation of incidental or consequential damages, so the above limitations may not apply to you. This warranty gives you specific legal rights, and you may also have other rights which vary from state to state and country to country.

Provided that the product was purchased from CT Nova itself or through its authorized reseller or agent and utilized in the U.S.A., CT Nova will, without charge, repair or replace, at its option, defective products, products or component parts upon delivery to the authorized CT Nova Authorized Service Center, accompanied by proof of the date of first customer purchase, such as a duplicated copy of a sales receipt.

You must pay any initial shipping charges required to ship the product for warranty service, but the return charges, to an address in the U.S.A, will be at CT Nova's expense, if the product is under warranty.

#### For Products Purchased Outside the U.S.A.

Please contact your authorized local reseller or agent for warranty information.