

Extreme Sub ES08

Models: GDI-EXESW801

POWERSPORTS + GOLF CARS + MARINE SUBWOOFER

What's in the Box

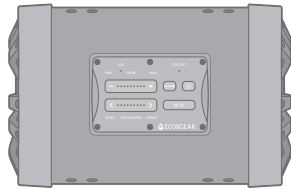

Extreme Sub Subwoofer



Extreme Sub User Guide



Remote Gain Level Controller



6.6ft Power Cable - EC5, Female



(8pcs) Lock Washers - small



(8pcs) Washers - small

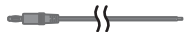

6.6ft Remote Turn-On Cable - Dark Blue



(8pcs) 10-24 x 29/32" Stainless Steel Button Head Screws



(8pcs) 1/4 Lock Washers



(8pcs) 1/4-20 Nuts

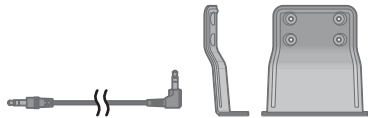

6.6ft 3.5mm Audio Cable (2pcs) Vertical Mounting Plates



(8pcs) 1/4 Washers



(2pcs) Horizontal Mount Standoffs



(8pcs) 1/4-20 stainless steel Hex Bolts - 3" long



Horizontal Mounting Plate



(8pcs) 1/4-20 stainless steel Hex Bolts - 3.5" long



User Guide

Extreme Sub Layout

Backlit Subwoofer (Passive)

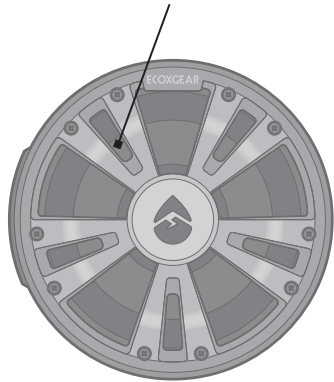

RIGHT SIDE

Control Panel

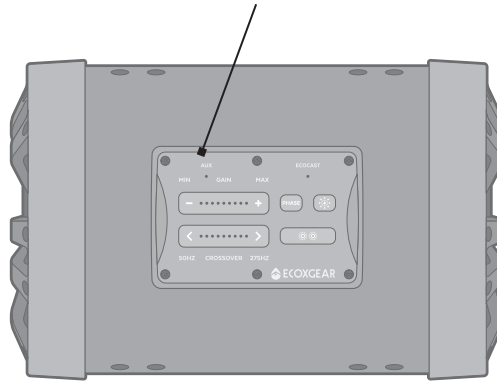

FRONT

Backlit Subwoofer

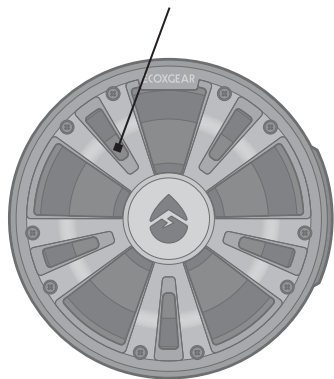

LEFT SIDE

Auto-Turn-On Switch

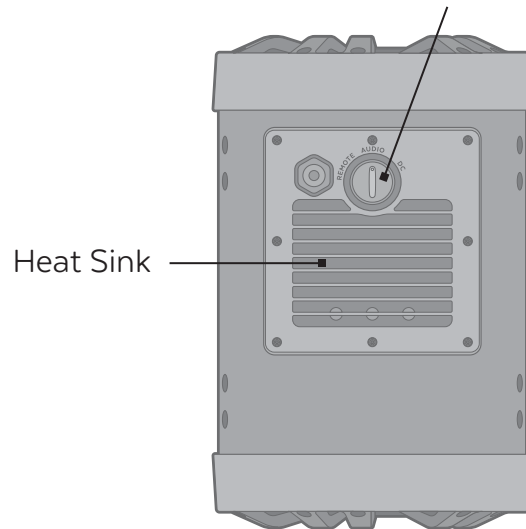

Heat Sink

BACK

- 3.) Properly clean the ECOXGEAR and ensure the gaskets have no sand, dirt, or water on them prior to storage.
- 4.) Store your unit with all caps properly sealed to avoid long term internal moisture damage inside your unit.
- 5.) Return the ECOXGEAR to Grace Digital if you suspect water ingress into the unit or if the unit has experienced a severe impact that may have affected the integrity of the unit to take on water.

You should never

- 1.) Never power your ECOXGEAR if you suspect water has entered the device. Powering a device with water inside could be potentially hazardous and cause fire or a spark.
- 2.) Never use your ECOXGEAR if you have dropped it or thrown it against a hard surface which may have destroyed the integrity of the subwoofer, housing, or gaskets. In the event of a severe impact to your unit, please return the unit to Grace Digital to review for potential damage.
- 3.) Never open the auxiliary doors in a water environment. This could cause water to ingress into the unit which could potentially be hazardous and cause a fire or a spark.
- 4.) Never connect a device to the auxiliary input jacks when in a water environment. The auxiliary jacks should only be used in a dry environment.
- 5.) Never attempt to fix, repair your ECOXGEAR unit. Please send it back to Grace Digital for any assessments and repairs.

CARE, MAINTENANCE & PRECAUTIONS:

- 1.) The unit is waterproof only when the caps and door are properly closed.
- 2.) Close the caps and door properly before use. If the unit is placed in a water environment without the caps or door properly closed, water may enter into the unit and void your warranty.
- 3.) Dry unit completely before opening the caps. Do **NOT** open the caps if wet or in a wet environment.
- 4.) Do **NOT** apply excessive force to any surfaces of the unit when wet or in a wet environment.
- 5.) Do **NOT** use or store the unit in places with high temperature.
- 6.) **AVOID** prolonged exposure to ultraviolet radiation (UV sunlight) and strong magnetic fields.
- 7.) Periodically check the rubber seal on the caps and door for premature wear.
- 8.) Periodically clean the rubber with a soft moist cloth and ensure no objects such as dirt, hair, sand are on the rubber seal ring. Do **NOT** use any oily solvent or chemicals for cleaning.
- 9.) Rinse off the unit with tap water after use in salt water.
- 10.) Power the unit by attaching the 12VDC Power-In Connector (EC5, male) to the 6.6ft Power Cable (EC5, female) intended for use with the unit. The unit must be connected to a 12VDC, 30A rating power source. If the battery terminal voltage is not 12V, you will need a DC-DC converter with output 12V. Connecting the unit to a non-12VDC power source will lead to a malfunction or damage to the unit.

LIMITED MANUFACTURER'S WARRANTY:

Extreme Sub is covered by a 1-year limited warranty that covers defects in workmanship and / or materials for a period of 1 year from original purchase date. This warranty does not apply to any products which have been abused, neglected, modified or used for a purpose other than the one for which they were manufactured. Please refer to the above care and maintenance instructions for suggested care details. The warranty is valid only for the original owner who purchases the unit from an authorized dealer. Transfers do not qualify for warranty protection. Grace Digital reserves the right to replace any out-of-stock or discontinued product with a comparable product. Discontinued products may not be available for warranty replacement. Any contents are **NOT** covered by the limited manufacturer's warranty. Warranty terms may be revised without notification at the discretion of the manufacturer. Please visit www.ecoxgear.com for additional product & warranty information.



Extreme Sub ES08 by ECOXGEAR, a division of Grace Digital Inc., San Diego, California.
Designed in California. Made in China.

Patents pending.

FCC STATEMENT:

This device complies with Part 15 of the FCC Rules. Operation is subject to the following two conditions:

- 1.) This device may not cause harmful interference, and
- 2.) This device must accept any interference received, including interference that may cause undesired operation.

WARNING: Changes or modifications not expressly approved by the party responsible for compliance could void the user's authority to operate the equipment.

NOTE: To maintain compliance with FCC's RF Exposure guidelines, this equipment should be installed and operated with minimum distance between 20cm the radiator to your body: Use only the supplied antenna. FCC ID: 2AAU1-GDIEXS801.

This equipment has been tested and found to comply with the limits for a Class B digital device, pursuant to Part 15 of the FCC Rules. These limits are designed to provide reasonable protection against harmful interference in a residential installation. This equipment generates, uses, and can radiate radio frequency energy and, if not installed and used in accordance with the instructions, may cause harmful interference to radio communications. However, there is no guarantee that interference will not occur in a particular installation. If this equipment does cause harmful interference to radio or television reception, which can be determined by turning the equipment off and on, the user is encouraged to try to correct the interference by one or more of the following measures: reorient or relocate the receiving antenna, increase the separation between the equipment and receiver, connect the equipment into an outlet on a circuit different from that to which the receiver is connected, consult the dealer or an experienced radio/TV technician for help.

IC STATEMENT:

This device complies with Industry Canada licence-exempt RSS standard(s). Operation is subject to the following two conditions:

- 1.) This device may not cause interference, and
- 2.) This device must accept any interference, including interference that may cause undesired operation of the device.

PRODUCT USE AND PROTECTION:

Read and follow all instructions. Use only as intended.

The ECOXGEAR subwoofer is intended to be used indoors or outdoors and in land or water environments. The subwoofer has been tested to IP66 waterproofing standards, which means the subwoofer can be exposed to dust and water, but should not be submerged underwater. The subwoofer is **NOT** intended for constant underwater use.

Always make sure the cap(s) / cover(s) are clean, free from sand or debris, and correctly fitted. The subwoofer will only meet IP66 ratings if all rubber seals, gasket(s) and cover(s) / cap(s) are in place. If you notice a muffling of audio after submersion, gently shake the unit to clear excess water. If your subwoofer is exposed to salt water, clean it thoroughly after use with fresh water.

To prevent fire or shock, do **NOT** attempt to power this unit if it is wet or you suspect water has entered the unit. In this situation, please return the unit to Grace Digital for a free assessment. If we have found that the unit has carried water, we will repair or replace the unit free of charge.

SAFETY ADVISORY & WARNING:

Read and follow all instructions. Use only as intended.

CAUTION: Do **NOT** open to repair. A qualified technician must carry out repair work.

ATTENTION: Do **NOT** connect to a 12VDC power supply while the unit is wet. Make sure all connections are dry **BEFORE** connecting to a power source. Failure to do so may result in electrical damage to the unit and may void the warranty.

WARNING: Cancer and Reproductive Harm - www.P65Warnings.ca.gov

WARNING: Danger of explosion if battery is incorrectly replaced.

ATTENTION: Do **NOT** dispose of in a landfill. Contact Grace Digital at www.gracesupport.com or a certified recycling agent to dispose of the unit.

SAFETY:

This product has a limited life span of use and should be replaced when it shows obvious signs of wear.

Do not modify or remove any original component parts of the subwoofer. Doing so could cause damage to the unit, allowing water to ingress. A unit with water ingress should not be charged due to potential risk of fire or shock.

Please exercise care and good judgment when using your ECOXGEAR subwoofer. Audio levels should be appropriate to your environment, comply with all local regulations, and always ensure that you can hear and be aware of any potential hazards around you.

You should always

- 1) Use the ECOXGEAR subwoofer in accordance with any music or noise rules and regulations.
- 2) Properly seal the ECOXGEAR prior and after each use when in humid or water environments to avoid water damage to the internal components. Salt water / air is particularly corrosive. Always make sure that the gaskets are sealed when in a salt water environment and that the unit is properly rinsed off after use.

In/Out Connections

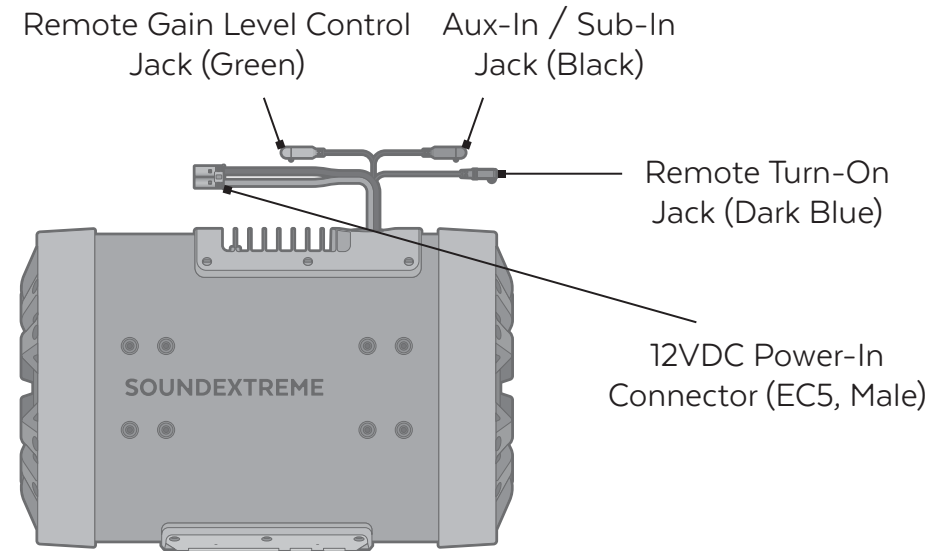

Do **NOT** use these connections if they are wet.

Aux-In / Sub-In Jack: If you do not want to connect the Extreme Sub wirelessly via EcoCast or want to connect it to a non-ECOXGEAR amplifier or speaker, you can connect the subwoofer using this input and the supplied 3.5mm Audio Cable. Connect it to any brand of stereo, amplifier, or soundbar's wired subwoofer-out or line-out.

Remote Gain Level Control Jack: This input can be connected to the supplied Remote Gain Level Controller, which allows for easy adjustment of the Extreme Sub's overall output.

Remote Turn-On Jack: This input can be used to turn on or turn off the Extreme Sub by another device. When the Auto-Turn-On Switch is turned to "Remote," a 12VDC signal will turn on the Extreme Sub. A (Dark Blue) Remote Turn-On Cable has been provided for your convenience.

12V Power-In Connector: This connector is used to connect to an external 12VDC power supply, with a minimum of a 30A current rating, via the supplied 6.6ft Power Cable (EC5, female).

Connecting to 12VDC Power Supply

The Extreme Sub does not have an internal battery. It must be connected to an external 12VDC power supply to function. Before you connect the Extreme Sub to a battery or a voltage regulator on a golf cart, a boat, a quad bike, a UTV, or another vehicle, you need to confirm the following:

1. Your vehicle battery or battery pack's terminal voltage is 12VDC.
2. Your vehicle battery or battery pack can supply a 30A current rating to the Extreme Sub.

If both an Extreme Sub and an ECOXGEAR SoundExtreme soundbar are connected to the same battery or battery pack, it requires a 40A current rating supply. So, before connecting to the vehicle's power supply, please check your vehicle's electrical specifications, or consult with the vehicle's manufacturer or distributor.

If the battery terminal voltage is not 12V, it requires a DC-DC converter with output 12V and 30A or 40A rating, as explained above.

Connecting the Extreme Sub to a non-12VDC power source will lead to a malfunction or damage to the subwoofer.

On electric vehicles, a DC-DC converter is required to avoid damage to the unit and the vehicle.

The accessory power output on the SoundExtreme soundbar (sold separately) does not have enough current capacity to supply the Extreme Sub. Do **NOT** connect the Extreme Sub Power-In Connector to the SoundExtreme accessory power output.

WARNING: In certain power modes, the Extreme Sub will still draw power when it is off. To avoid battery drain, connect the supplied Remote Turn-On Cable (Dark Blue) to a power on/off switch or disconnect the subwoofer from the power source when storing for long periods of time.

Installation: Gas Vehicle

1. Loosen the nuts on the battery terminals.

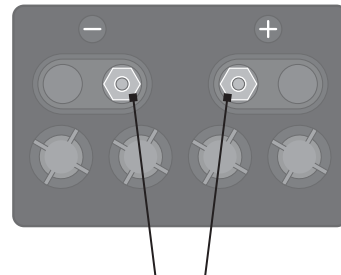

Loosen Nuts

Unit + Horizontal Mount Dimensions

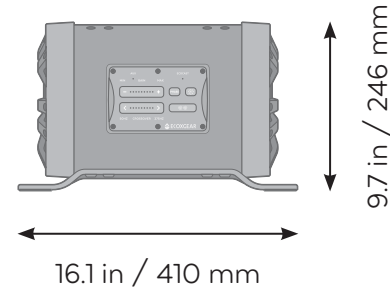

Unit + Horizontal Mount + Mount Standoffs Dimensions

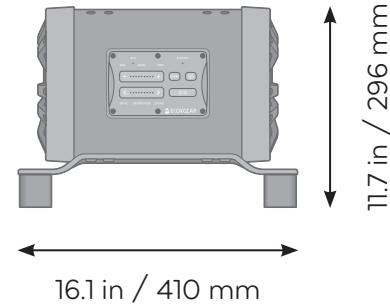

Unit + Vertical Mount Dimensions

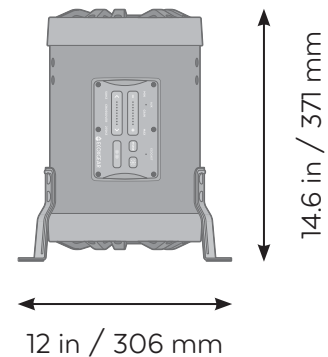

Unit Weight

16.87 lbs (7.65 kg)

Horizontal Mount Weight

1.5 lbs (0.68 kg)

Vertical Mounts Weight

1.28 lbs (0.64 lbs x2)

0.58 kg (0.29 kg x2)

Bluetooth Compliance

Bluetooth V 5.0

Bluetooth Frequency Band

2.402-2.480GHz ISM Spectrum

Modulation

GFSK, $\pi/4$ -DQPSK, 8DPSK

Crossover Range

50Hz - 275Hz

Subwoofer

8" (203.2 mm) subwoofer

Passive Subwoofer

8" (203.2 mm) subwoofer

Audio Output Power

500W (peak)

Power Supply

Input Voltage: 12VDC, 30A
(requires connection to external DC battery for power)

EcoCast

Using Qualcomm® Broadcast Audio technology

EcoCast Range

30 ft / 9.1 m between Casting speaker and Receiving speakers

Blade Fuse

30A, 32V

Storage Temperature

-40°F to 122°F / -40°C to 50°C

Operating Temperature

23°F to 95°F / -5°C to 35°C

Waterproof / Dust Rating

IP66

Troubleshooting

No audio and LED indicator are off

Check if there is voltage at Power-In connector or if there is an ignition signal when the Auto-Turn-On Switch is set to Remote, or if there is an audio signal input when the Auto-Turn-On Switch is set to Audio.

Poor audio quality

Check if the Gain Level is set properly. Check wires for shorts or grounds. Check the source signal. Check if the 3.5mm Audio Cable or the Remote Gain Level Controller cable is close to the vehicle's electrical wiring.

LED Party Lights for show and off-road use only

Check with local ordinance before using LED lights. Do **NOT** drive on public roads with LED lights on. LED lights are not DOT compliant.

Please do NOT attempt to fix your Extreme Sub

Please contact our Customer Support at support@gracedigital.com or call us at **800.903.9524**.

Specifications

Unit Dimensions

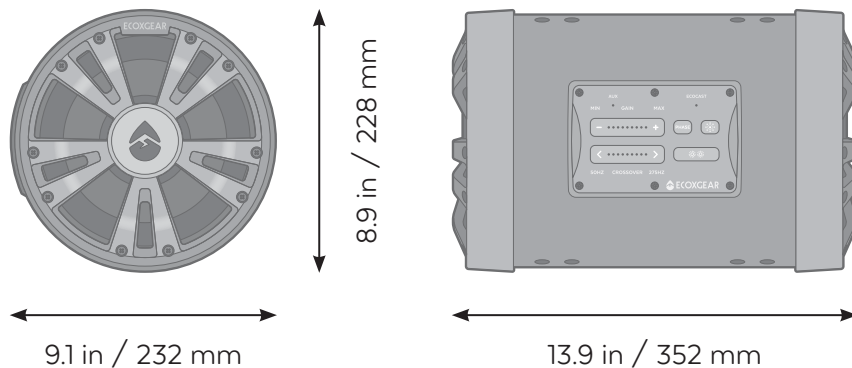

Use Caution: Do **NOT** attempt to loosen nuts if battery is wet. Contact may cause electric shock and injury if wet.

2. Connect the **BLACK** wire to the **BLACK**, negative terminal.
3. Connect the **RED** wire to the **RED**, positive terminal. Unit will not work correctly and may be damaged if wires are not correctly attached.
4. Tighten the nuts on the battery terminals until the connectors are held firmly in place.
5. Connect the (EC5) female connector on the 6.6ft Power Cable to the (EC5) male 12VDC Power-In Connector.

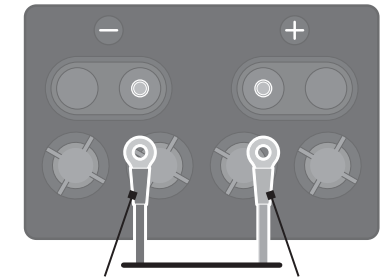

Black Cable Red Cable

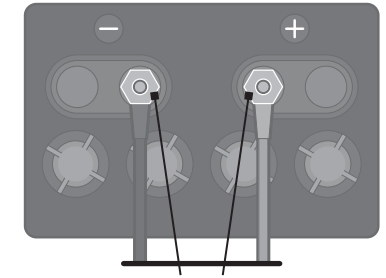

Tighten Nuts

Use Caution: Do **NOT** connect to 12V Battery if the 6.6ft Power Cable or the (EC5) Power-In Connector are wet. Contact may cause electric shock and injury if wet.

6. Turn the Auto-Turn-On Switch toward, "DC" in order to turn on the subwoofer.

Tip: Use zip ties to gather any excess wires, and secure them so that they are not dangling, loosely.

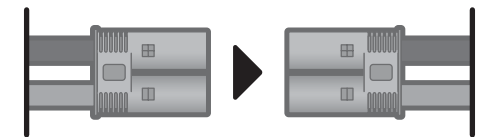

EC5, Female

EC5, Male

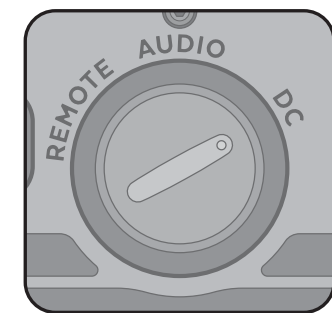

Turn Auto-Turn-On Switch to DC

Installation: Electric Vehicle

1. Switch your vehicle to TOW mode.
2. Wire the **BLACK** wire on the Extreme Sub power cable to the **GROUND** on output of the DC-DC Converter.
3. Wire the **RED** wire on the Extreme Sub to the **POSITIVE (+)** post on the output of the DC-DC converter. Unit will not work correctly and may be damaged if wires are not correctly attached.
5. Connect the (EC5) female connector on the 6.6ft Power Cable to the (EC5) male 12VDC Power-In Connector.

Use Caution: Do **NOT** connect to DC-DC converter if the 6.6ft Power Cable or the (EC5) Power-In Connector are wet. Contact may cause electric shock and injury if wet.

4. Turn the Auto-Turn-On Switch toward, "DC" in order to turn on the subwoofer.

Tip: Use zip ties to gather any excess wires, and secure them so that they are not dangling, loosely.

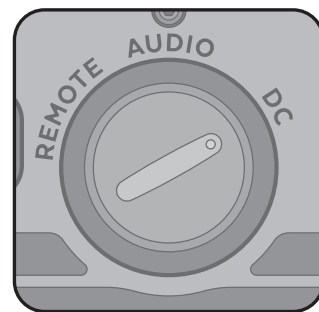
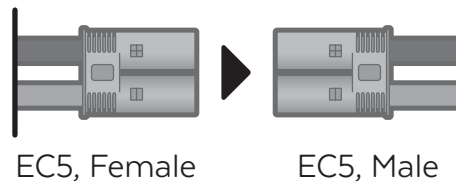
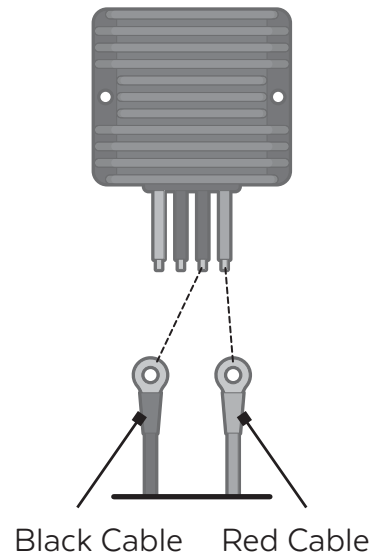

Turn Auto-Turn-On Switch to DC

Optional: Place the Mount Standoffs under both ends of the Mounting Plate. Use these optional Standoffs when there is not enough clearance between the Mounting Plate and the vehicle's mounting surface.

4. Attach the Mounting Plate to your vehicle with the provided ¼-20 Hex Bolts, Washers, Lock Washers, and Nuts. Tighten securely.

Mounting Your Subwoofer

Use Caution:

- The Extreme Sub weighs 17 lbs. Please use caution when lifting or handling.
- The Extreme Sub vibrates when playing heavy bass music at maximum gain. It is important to fasten the subwoofer securely to a flat surface on the vehicle. Whether mounting the subwoofer horizontally or vertically, the supplied Washers and Lock Washers **MUST** be used.
- There is a Heat Sink on the back of the Extreme Sub. For optimal performance, install the subwoofer so that the Heat Sink is not in direct sunlight.

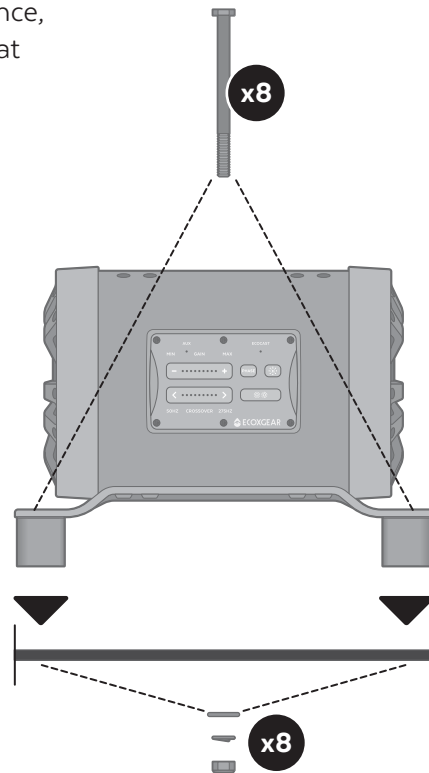
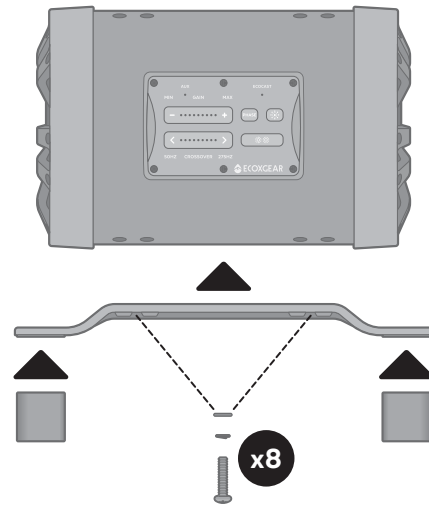

Horizontal Mount

1. To mount the subwoofer in a horizontal orientation, first attach the Horizontal Mounting Plate, using eight 29/32" Screws, Lock Washers, and Washers. Tighten securely.
2. Ensure that the subwoofer fits in the desired location and mark where the mounts will be attached to your vehicle.
3. Drill holes at the desired mounting points on your vehicle, large enough for the provided Hex Bolts to fit.

Controls

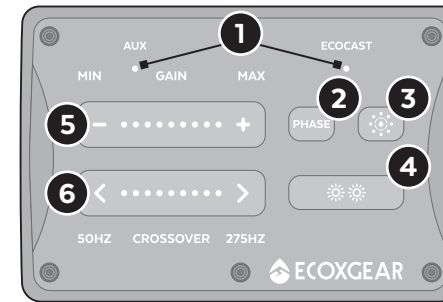

CONTROL
PANEL

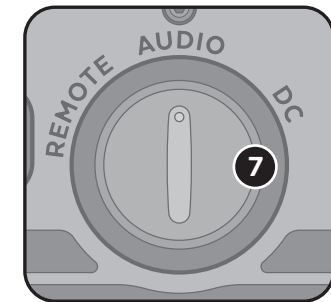

AUTO-TURN-
ON SWITCH

1. **LED Indicators:** Each of the 2 LEDs correspond to different functions: AUX, Phase, and EcoCast Receiving.
2. **Phase Button:** Press this button to toggle the Extreme Sub sound output from in phase to out of phase. If the AUX LED flashes Green 3 times, the sound output is in phase. If the AUX LED flashes Red 3 times, the sound output is out of phase.
3. **EcoCast Button:** When turned on, the Extreme Sub enters EcoCast Receiving Mode. If it is not paired with a SoundExtreme, press this button to put the Extreme Sub into Pairing Mode.
4. **Party Lights Button:** Press to cycle through the following 12 Party Light Modes: Red, Orange, Yellow, Green, Cyan, Blue, Purple, White, Music Sync, FADE7, JUMP7, Color Fade. Press and hold to turn off the Party Lights.
5. **Gain Control Buttons:** Press to increase or decrease the gain level of the Extreme Sub. The Gain Controls allow you to change the relative value of the Extreme Sub compared to the SoundExtreme.
6. **Crossover Control Buttons:** Press to decrease or increase the frequency range of the Extreme Sub. Reducing the Crossover Frequency will result in the Extreme Sub performing solely as a low frequency subwoofer.
7. **Auto-Turn-On Switch:** Turn the switch to select one of three modes: Remote, Audio, and DC.

Operations

Auto-Turn-On Switch

Turn the Auto-Turn-On Switch to select one of three modes: Remote, Audio, and DC.

Remote: When the switch is turned to this position, the (Dark Blue) Remote Turn-On Cable must be connected to the vehicle ignition switch or the vehicle's 12VDC power supply. When the vehicle's ignition is on or the Remote Turn-On Cable has a 12VDC signal, the Extreme Sub will turn on.



Audio: When the switch is turned to this position, the Aux-In / Sub-In Jack must have an Aux-In audio input connection from a soundbar, an amplifier, or stereo receivers. The Extreme Sub will turn on only when there is an audio signal input.

DC: When the switch is turned to this position, the Extreme Sub will turn on whenever there is a 12VDC power supply.

LED Indicators

There are two LED Indicators at the top of the Control Panel. The left LED Indicator corresponds to AUX and Phase, and the right LED Indicator corresponds to EcoCast Receiving.

1. AUX

Solid Blue: When an Aux-In cable is plugged in

Phase - Sound Output

When the Phase Button has been pressed, the AUX LED flashes 3 times to indicate if the Extreme Sub sound output is in or out of phase.

Flashing Green: Sound output is in phase

Flashing Red: Sound output is out of phase

2. ECOCAST

Flashing Green: EcoCast Receiving Mode - Pairing

Solid Green: EcoCast Receiving Mode - Paired

Remote Gain Level Controller

1. Mount the Remote Gain Level Controller in an accessible location. Keep the cable away from the vehicle's electrical wiring to avoid possible interferences from the vehicle's electrical system.



2. Connect the Remote Gain Level Controller to the (Green) Remote Gain Level Control Jack on the Extreme Sub. The LED on the Remote Gain Level Controller will shine solid Red if the Extreme Sub is turned on.





3. Turn the knob to adjust the gain level.

Important: Maintaining Waterproofness

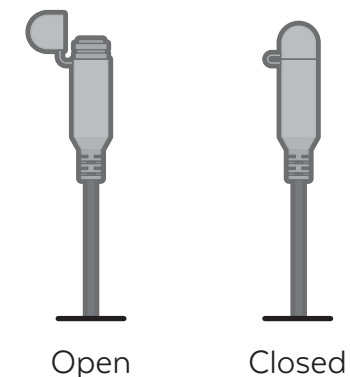

If the caps on the Aux-In, Remote Gain Level Control, and Remote Turn-On jacks are not properly closed, the unit is **NOT** waterproof.

To close the Aux-In, Remote Gain Level Control Connector, and Remote Turn-On jacks properly, push firmly to be sure the cap snaps securely into place.



2. On **Speaker A** (the speaker with the Mode LED Indicator shining solid Red), **PRESS AND HOLD**  for 6 seconds. The Mode LED Indicator will flash Red.
3. Once the connection between the speakers is successful, **Speaker C** (and **Sub D**) will announce, "Connection Successful," and start playing music from your Bluetooth device.

Notes:

- If all the speakers are turned off, then turned on, the speaker(s) and sub(s) in EcoCast Receiving Mode (**Speakers** and **Subs B, C, and D**) will automatically re-connect to the speaker in Transmitting Mode (**Speaker A**). If they are not automatically re-connected, please follow the above steps. To clear pairing records on an Extreme Sub, **PRESS AND HOLD**  for 6 seconds.
- You can also pair the SoundExtreme with any other ECOXGEAR speaker bearing the EcoCast symbol .
- The EcoCast functionality is only available while using Bluetooth as your Audio Source at a maximum range of 30 feet between speakers.
- While connecting the SoundExtreme speakers, make sure that the speakers are within a few feet of each other.
- If you do not want to connect the subwoofer wirelessly or want to connect it to a non-ECOXGEAR amplifier or speaker, you can connect the subwoofer via its Aux-In / Sub-In Jack, using the supplied 3.5mm Audio Cable.

Aux-In Audio Connection



To use an Aux-In audio source, connect the audio output from the source unit to the Extreme Sub's Aux-In / Sub-In Jack with the supplied 3.5 Audio Cable.

Once the 3.5mm Audio Cable is plugged in, the Aux-In LED Indicator will shine solid Blue.

Phase Button

Press **PHASE** briefly to toggle the Extreme Sub sound output from in phase to out of phase. If the AUX LED flashes Green 3 times, the sound output is in phase. If the AUX LED flashes Red 3 times, the sound output is out of phase.

Note: Pairing multiple subwoofers, depending on their location to one another, can result in the subwoofers sounding out of phase with each other and a reduction in their overall, perceived volume output. Toggle the **PHASE** button to determine which setting provides the optimal bass performance.

Adjust Gain



Press  briefly to reduce the gain. Press  briefly to increase the gain.

The LEDs between the Gain Control Buttons indicate the gain level. When increased, the LEDs will light up, towards the right. When decreased, the LEDs will turn off, towards the left.

Notes:

- When you adjust the volume level on your connected ECOXGEAR SoundExtreme soundbar, the volume level will adjust automatically on the Extreme Sub. The gain controls allow you to change the relative value of the subwoofer compared to the soundbar.
- The Gain Control Buttons control the sensitivity of the amplifier built into the subwoofer. You will want to optimize the gain level of the subwoofer depending on the type of music you enjoy as well as the location of the Extreme Sub.

Adjust Crossover

Press  briefly to reduce the frequency range that the amplifier sends to the subwoofer. Press  briefly to increase the frequency range.

The LEDs between the Crossover Control Buttons indicate the frequency level. When increased, the LEDs will light up, towards the right. When decreased, the LEDs will turn off, towards the left.

Notes:

- When the crossover frequency is set to 275Hz, you receive the full range of the Extreme Sub's capability. This allows it to play low woofer frequencies, not just subwoofer frequencies, to produce a more full sound profile when paired with ECOXGEAR SoundExtreme soundbars.
- When the crossover frequency is reduced down to 50Hz, the Extreme sub will perform solely as a low-frequency subwoofer.

Party Lights

Press  briefly to cycle through 12 Party Light Modes: Red, Orange, Yellow, Green, Cyan, Blue, Purple, White, Music Sync, FADE7, JUMP7, Color Fade.

PRESS AND HOLD  to turn off the Party Lights.

EcoCast – Broadcast Your Music to Multiple Speakers and Extreme Subs



The ECOXGEAR SoundExtreme speaker is designed to be paired with one or more SoundExtreme speakers and Extreme Subs. You can build a broadcast system by initiating EcoCast Transmitting Mode in one SoundExtreme speaker and broadcasting your music to one or more Extreme Subs and SoundExtreme speakers in EcoCast Receiving Mode.

Note: The Extreme Sub is always in EcoCast Receiving Mode.

RF Exposure Statement:

The distance between user and products should be no less than 20cm.

La distance entre l'utilisateur et le produit ne doit pas être inférieure à 20 cm.

EcoCast: SoundExtreme to Extreme Sub



1. Follow the **Pairing a Bluetooth Device** instructions in your SoundExtreme user guide to connect one SoundExtreme (**Speaker A**) to your Bluetooth device. After your device is connected to **Speaker A**, you can select a song to play.
2. Press  on **Speaker A** to initiate EcoCast Transmitting Mode. The Mode LED Indicator (the third LED Indicator from the left) will flash Red, and the speaker will announce, "EcoCast transmitting."
3. Power on your Extreme Sub (**Sub B**). It will already be in EcoCast Receiving Mode. The subwoofer will announce, "EcoCast receiving."
4. Once the connection between the speakers is successful, **Sub B** will announce, "Connection Successful," and start playing music from your Bluetooth device.

EcoCast: Additional Receiving Speakers and/or Subwoofers

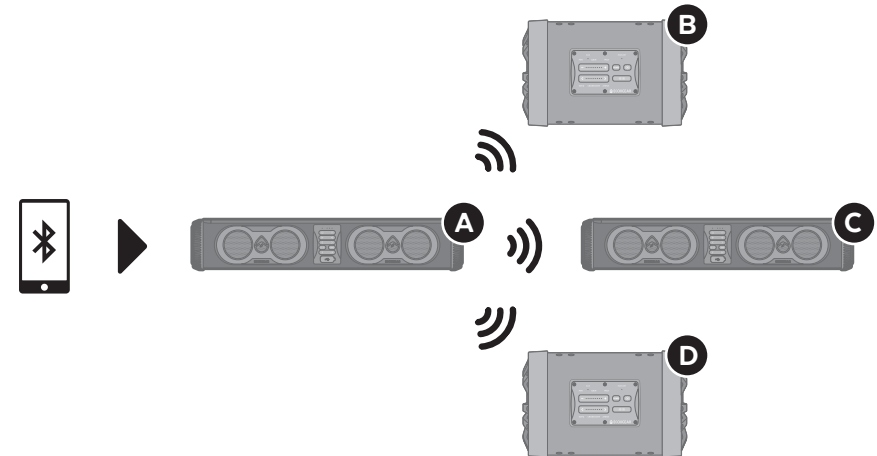

1. Power on the additional SoundExtreme speaker(s) (**Speaker C** and **Sub D**). Press  on **Speaker C** to cycle through to and initiate EcoCast Receiving Mode. The Mode LED Indicator will flash Green, and the speaker(s) will announce, "EcoCast receiving."