



RADIO TEST REPORT

FCC ID: 2AAUI-GDIEXBM901

Product: EcoBoulder
Trade Name: ECOXGEAR
Model No.: GDI-EXBM901
Serial Model: N/A
Report No.: NTEK-2016NT05306119F1
Issue Date: 21 Jun 2016

Prepared for

Grace Digital Inc.
Grace Digital Inc. 10531 4S Commons Drive #166, Suite #430,
San Diego, California, United States

Prepared by

NTEK TESTING TECHNOLOGY CO., LTD.
1/F, Building E, Fenda Science Park, Sanwei Community,
Xixiang Street Bao'an District, Shenzhen, P.R. China
Tel.: +86-0755-61156588
Fax.: +86-0755-61156599
Website: www.ntek.org.cn

TABLE OF CONTENTS

1	TEST RESULT CERTIFICATION	3
2	SUMMARY OF TEST RESULTS.....	4
3	FACILITIES AND ACCREDITATIONS	5
3.1	FACILITIES.....	5
3.2	LABORATORY ACCREDITATIONS AND LISTINGS	5
3.3	MEASUREMENT UNCERTAINTY	5
4	GENERAL DESCRIPTION OF EUT	6
5	DESCRIPTION OF TEST MODES	8
6	SETUP OF EQUIPMENT UNDER TEST	9
6.1	BLOCK DIAGRAM CONFIGURATION OF TEST SYSTEM.....	9
6.2	SUPPORT EQUIPMENT.....	10
6.3	EQUIPMENTS LIST FOR ALL TEST ITEMS.....	11
7	TEST REQUIREMENTS	12
7.1	CONDUCTED EMISSIONS TEST	12
7.2	RADIATED SPURIOUS EMISSION	17
7.3	NUMBER OF HOPPING CHANNEL.....	26
7.4	HOPPING CHANNEL SEPARATION MEASUREMENT	28
7.5	AVERAGE TIME OF OCCUPANCY (DWELL TIME)	34
7.6	20DB BANDWIDTH TEST	41
7.7	PEAK OUTPUT POWER	47
7.8	CONDUCTED BAND EDGE MEASUREMENT.....	53
7.9	ANTENNA APPLICATION	61



1 TEST RESULT CERTIFICATION

Applicant's name.....:	Grace Digital Inc.
Address	Grace Digital Inc. 10531 4S Commons Drive #166, Suite #430, San Diego, California, United States
Manufacture's Name	Xingtet Xiamen Group Co., Ltd.
Address	Xingtet Building,Chuangxin Road, Torch Hi-Tech Industrial District, Xiamen 361006, PR China
Product description	
Product name.....:	EcoBoulder
Model and/or type reference	GDI-EXBM901
Serial Model	N/A

Measurement Procedure Used:

APPLICABLE STANDARDS	
STANDARD/ TEST PROCEDURE	TEST RESULT
FCC 47 CFR Part 2, Subpart J:2015 FCC 47 CFR Part 15, Subpart C:2015 KDB 174176 D01 Line Conducted FAQ v01r01 ANSI C63.10-2013 DA 00-705	Complied

This device described above has been tested by NTEK Testing Technology Co., Ltd., and the test results show that the equipment under test (EUT) is in compliance with the FCC requirements. And it is applicable only to the tested sample identified in the report.

This report shall not be reproduced except in full, without the written approval of NTEK Testing Technology Co., Ltd., this document may be altered or revised by NTEK Testing Technology Co., Ltd., personnel only, and shall be noted in the revision of the document.

The test results of this report relate only to the tested sample identified in this report.

Date of Test : 30 May. 2016 ~ 21 Jun. 2016

Testing Engineer : Susan Su
(Susan Su)

Technical Manager : Jason Chen
(Jason Chen)

Authorized Signatory : Sam. Chen
(Sam Chen)

2 SUMMARY OF TEST RESULTS

FCC Part15 (15.247), Subpart C			
Standard Section	Test Item	Verdict	Remark
15.207	Conducted Emission	PASS	
15.247(c)	Radiated Spurious Emission	PASS	
15.247(a)(1)	Hopping Channel Separation	PASS	
15.247(b)(1)	Peak Output Power	PASS	
15.247(a)(iii)	Number of Hopping Frequency	PASS	
15.247(a)(iii)	Dwell Time	PASS	
15.247(a)(1)	Bandwidth	PASS	
15.205	Band Edge Emission	PASS	
15.203	Antenna Requirement	PASS	

Remark:

1. "N/A" denotes test is not applicable in this Test Report.
2. All test items were verified and recorded according to the standards and without any deviation during the test.
3. This EUT has also been tested and complied with the requirements of FCC Part 15, Subpart B, recorded in a separate test report.

3 FACILITIES AND ACCREDITATIONS

3.1 FACILITIES

All measurement facilities used to collect the measurement data are located at 1/F, Building E, Fenda Science Park, Sanwei Community, Xixiang Street, Bao'an District, Shenzhen P.R. China.

The sites are constructed in conformance with the requirements of ANSI C63.7, ANSI C63.10 and CISPR Publication 22.

3.2 LABORATORY ACCREDITATIONS AND LISTINGS

Site Description

EMC Lab. : Accredited by CNAS, 2014.09.04
 The certificate is valid until 2017.09.03
 The Laboratory has been assessed and proved to be in compliance with CNAS-CL01:2006 (identical to ISO/IEC 17025:2005)
 The Certificate Registration Number is L5516.

Accredited by FCC, September 6, 2013
 The Certificate Registration Number is 238937.

Accredited by Industry Canada, August 29, 2012
 The Certificate Registration Number is 9270A-1.

Name of Firm : NTEK Testing Technology Co., Ltd
 Site Location : 1/F, Building E, Fenda Science Park, Sanwei Community, Xixiang Street, Bao'an District, Shenzhen P.R. China.

3.3 MEASUREMENT UNCERTAINTY

The reported uncertainty of measurement $y \pm U$, where expanded uncertainty U is based on a standard uncertainty multiplied by a coverage factor of $k=2$, providing a level of confidence of approximately 95 %.

No.	Item	Uncertainty
1	Conducted Emission Test	$\pm 1.38\text{dB}$
2	RF power, conducted	$\pm 0.16\text{dB}$
3	Spurious emissions, conducted	$\pm 0.21\text{dB}$
4	All emissions, radiated(<1G)	$\pm 4.68\text{dB}$
5	All emissions, radiated(>1G)	$\pm 4.89\text{dB}$
6	Temperature	$\pm 0.5^\circ\text{C}$
7	Humidity	$\pm 2\%$

4 GENERAL DESCRIPTION OF EUT

Product Feature and Specification	
Equipment	EcoBoulder
Trade Name	ECOXGEAR
FCC ID	2AAUIGDI-GDIEXBM901
Model No.	GDI-EXBM901
Serial Model	N/A
Model Difference	N/A
Operating Frequency	2402MHz~2480MHz
Modulation	GFSK,π/4-DQPSK, 8DPSK
Number of Channels	79 Channels
Antenna Type	PCB Antenna
Antenna Gain	0 dBi
Power supply	<input checked="" type="checkbox"/> DC supply: DC 12V/7AH from Battery.
	<input checked="" type="checkbox"/> AC supply: Input voltage: 100-240V~50/60Hz
HW Version	V2.1
SW Version	V1.7

Note: Based on the application, features, or specification exhibited in User's Manual, the EUT is considered as an ITE/Computing Device. More details of EUT technical specification, please refer to the User's Manual.

5 DESCRIPTION OF TEST MODES

To investigate the maximum EMI emission characteristics generates from EUT, the test system was pre-scanning tested base on the consideration of following EUT operation mode or test configuration mode which possible have effect on EMI emission level. Each of these EUT operation mode(s) or test configuration mode(s) mentioned above was evaluated respectively.

The Transmitter was operated in the normal operating mode. The TX frequency was fixed which was for the purpose of the measurements.

Test of channel included the lowest and middle and highest frequency to perform the test, then record on this report.

Those data rates (1Mbps for GFSK modulation; 2Mbps for $\pi/4$ -DQPSK modulation; 3Mbps for 8DPSK modulation) were used for all test.

The EUT was pretested with 3 orientations placed on the table for the radiated emission measurement –X, Y, and Z-plane. The Y-plane results were found as the worst case and were shown in this report.

Carrier Frequency and Channel list:

Channel	Frequency(MHz)
0	2402
1	2403
...	...
39	2441
40	2442
...	...
77	2479
78	2480

Note: $f_c=2402\text{MHz}+k \times 1\text{MHz}$ $k=0$ to 78

The following summary table is showing all test modes to demonstrate in compliance with the standard.

For AC Conducted Emission	
Final Test Mode	Description
Mode 1	Normal Link

Note: AC power line Conducted Emission was tested under maximum output power.

For Radiated Test Cases	
Final Test Mode	Description
Mode 1	Normal Link
Mode 2	CH00(2402MHz)
Mode 3	CH39(2441MHz)
Mode 4	CH78(2480MHz)

Note: For radiated test cases, the worst mode data rate 1Mbps was reported only, because this data rate has the highest RF output power at preliminary tests, and no other significantly frequencies found in conducted spurious emission.

For Conducted Test Cases	
Final Test Mode	Description
Mode 2	CH00(2402MHz)
Mode 3	CH39(2441MHz)
Mode 4	CH78(2480MHz)

Note: The engineering test program was provided and the EUT was programmed to be in continuously transmitting mode.

6 SETUP OF EQUIPMENT UNDER TEST

6.1 BLOCK DIAGRAM CONFIGURATION OF TEST SYSTEM

For AC Conducted Emission Mode

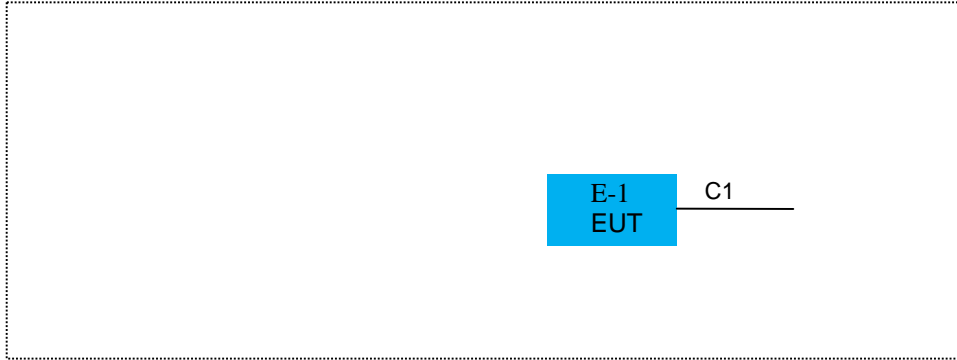

For Radiated Test Cases

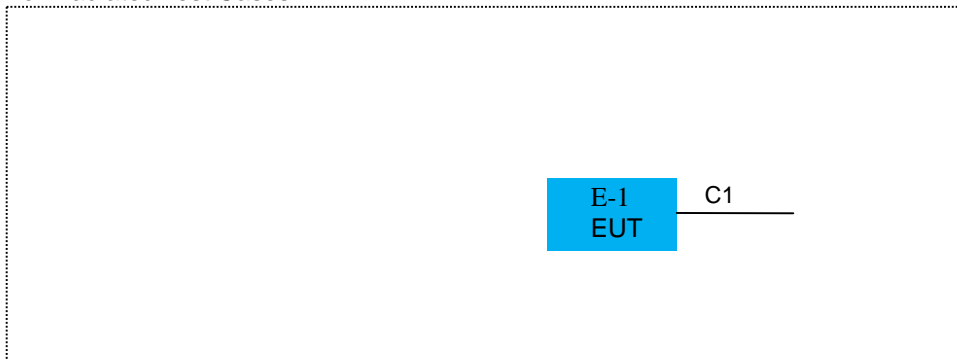

For Conducted Test Cases

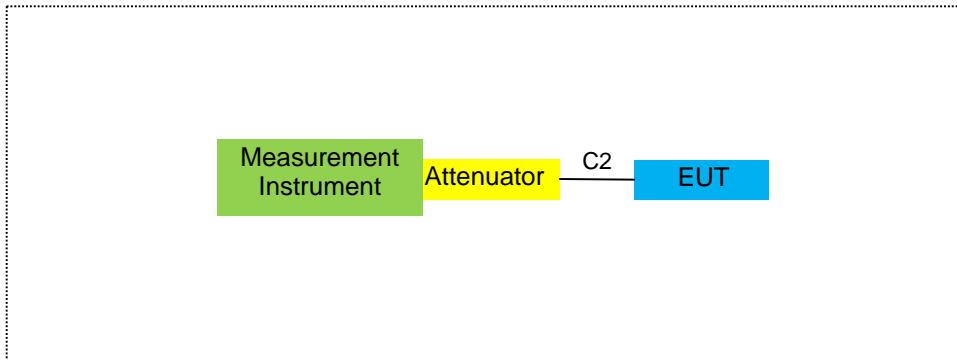

6.2 SUPPORT EQUIPMENT

The EUT has been tested as an independent unit together with other necessary accessories or support units. The following support units or accessories were used to form a representative test configuration during the tests.

Item	Equipment	Mfr/Brand	Model/Type No.	FCC ID	Note
E-1	EcoBoulder	ECOXGEAR	GDI-EXBM901	2AAUIGDI-GDIEXB M901	EUT
E-2	iPhone5s	Apple	A1518	N/A	Peripherals

Item	Cable Type	Shielded Type	Ferrite Core	Length
C-1	AC PLUG	YES	NO	1.2m
C-2	RF Cable	NO	NO	0.5m

Notes:

- (1) The support equipment was authorized by Declaration of Confirmation.
- (2) For detachable type I/O cable should be specified the length in cm in 『Length』 column.
- (3) “YES” is means “shielded” “with core”; “NO” is means “unshielded” “without core”.

6.3 EQUIPMENTS LIST FOR ALL TEST ITEMS

Radiation Test equipment

Item	Kind of Equipment	Manufacturer	Type No.	Serial No.	Last calibration	Calibrated until	Calibration period
1	Spectrum Analyzer	Agilent	E4407B	MY45108040	2015.07.06	2016.07.05	1 year
2	Test Receiver	R&S	ESPI	101318	2016.06.07	2017.06.06	1 year
3	Bilog Antenna	TESEQ	CBL6111D	31216	2015.07.06	2016.07.05	1 year
4	50Ω Coaxial Switch	Anritsu	MP59B	6200264416	2016.06.07	2017.06.06	1 year
5	Spectrum Analyzer	ADVANTEST	R3132	150900201	2016.06.07	2017.06.06	1 year
6	Horn Antenna	EM	EM-AH-10180	2011071402	2015.07.06	2016.07.05	1 year
7	Horn Ant	Schwarzbeck	BBHA 9170	9170-181	2015.07.06	2016.07.05	1 year
8	Amplifier	EM	EM-30180	060538	2015.12.22	2016.12.21	1 year
9	Loop Antenna	ARA	PLA-1030/B	1029	2016.06.08	2017.06.07	1 year
10	Power Meter	R&S	NRVS	100696	2015.07.06	2016.07.05	1 year
11	Power Sensor	R&S	URV5-Z4	0395.1619.05	2015.07.06	2016.07.05	1 year
12	Test Cable	N/A	R-01	N/A	2015.07.06	2016.07.05	1 year
13	Test Cable	N/A	R-02	N/A	2015.07.06	2016.07.05	1 year

Conduction Test equipment

Item	Kind of Equipment	Manufacturer	Type No.	Serial No.	Last calibration	Calibrated until	Calibration period
1	Test Receiver	R&S	ESCI	101160	2016.06.06	2017.06.05	1 year
2	LISN	R&S	ENV216	101313	2015.08.24	2016.08.23	1 year
3	LISN	EMCO	3816/2	00042990	2015.08.24	2016.08.23	1 year
4	50Ω Coaxial Switch	Anritsu	MP59B	6200264417	2016.06.07	2017.06.06	1 year
5	Passive Voltage Probe	R&S	ESH2-Z3	100196	2016.06.07	2017.06.06	1 year
6	Absorbing clamp	R&S	MOS-21	100423	2016.06.08	2017.06.07	1 year
7	Test Cable	N/A	C01	N/A	2016.06.08	2017.06.07	1 year
8	Test Cable	N/A	C02	N/A	2016.06.08	2017.06.07	1 year
9	Test Cable	N/A	C03	N/A	2016.06.08	2017.06.07	1 year
1	Attenuation	MCE	24-10-34	BN9258	2016.06.08	2017.06.07	1 year

Note: Each piece of equipment is scheduled for calibration once a year.

7 TEST REQUIREMENTS

7.1 CONDUCTED EMISSIONS TEST

7.1.1 Applicable Standard

According to FCC Part 15.207(a) and KDB 174176 D01 Line Conducted FAQ v01r01

7.1.2 Conformance Limit

Frequency(MHz)	Conducted Emission Limit	
	Quasi-peak	Average
0.15-0.5	66-56*	56-46*
0.5-5.0	56	46
5.0-30.0	60	50

Note: 1. *Decreases with the logarithm of the frequency
 2. The lower limit shall apply at the transition frequencies
 3. The limit decreases in line with the logarithm of the frequency in the range of 0.15 to 0.50MHz.

7.1.3 Test Configuration

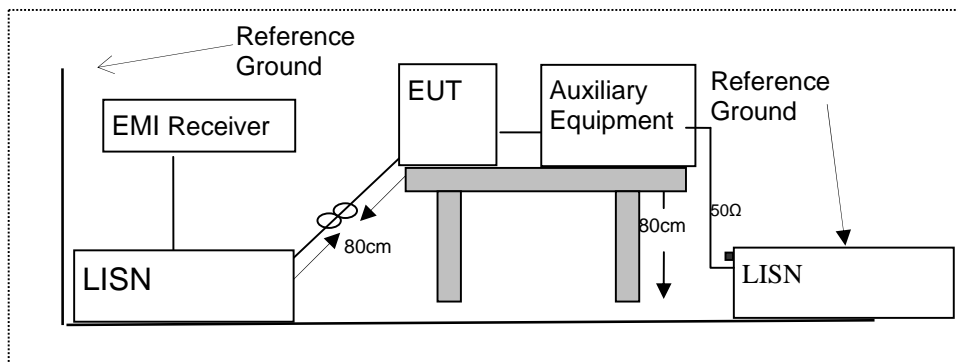

7.1.4 Test Procedure

According to the requirements in Section 13.1.4.1 of ANSI C63.10-2013 Conducted emissions the EUT measured in the frequency range between 0.15 MHz and 30 MHz using CISPR Quasi-Peak and average detector mode.

1. The EUT was placed 0.4 meter from the conducting wall of the shielding room.
2. The EUT was placed on a table which is 0.8m above ground plane.
3. Connect EUT to the power mains through a line impedance stabilization network (LISN). All other support equipments powered from additional LISN(s). The LISN provide 50 Ohm/ 50uH of coupling impedance for the measuring instrument.
4. Interconnecting cables that hang closer than 40 cm to the ground plane shall be folded back and forth in the center forming a bundle 30 to 40cm long.
5. I/O cables that are not connected to a peripheral shall be bundled in the center. The end of the cable may be terminated, if required, using the correct terminating impedance. The overall length shall not exceed 1 m.
6. LISN at least 80 cm from nearest part of EUT chassis.
7. The frequency range from 150KHz to 30MHz was searched.
8. Set the test-receiver system to Peak Detect Function and specified bandwidth(IF bandwidth=9KHz) with Maximum Hold Mode
9. For the actual test configuration, please refer to the related Item –EUT Test Photos.

7.1.5 Test Results

Pass

7.1.6 Test Results

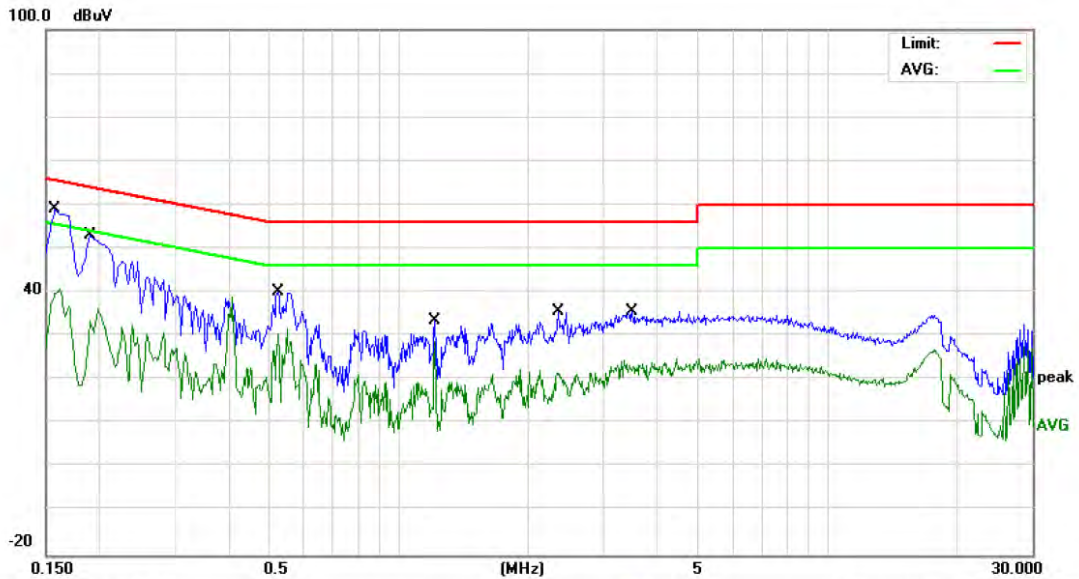

Site CONDUCTION #1 Phase: **L1** Temperature: 22
 Limit: FCC Part 15B_(0.15-30MHz) _Main_QP Power: AC 120V/60Hz Humidity: 51 %
 Mode: Normal Link
 Note:

No.	Mk.	Freq. MHz	Reading Level dBuV	Correct Factor dB	Measure- ment dBuV	Limit dBuV	Over dB	Detector	Comment
1	*	0.1580	48.97	10.12	59.09	65.56	-6.47	QP	
2		0.1580	29.74	10.12	39.86	55.56	-15.70	AVG	
3		0.1900	42.94	10.13	53.07	64.03	-10.96	QP	
4		0.1900	23.10	10.13	33.23	54.03	-20.80	AVG	
5		0.5220	30.27	9.80	40.07	56.00	-15.93	QP	
6		0.5220	20.64	9.80	30.44	46.00	-15.56	AVG	
7		1.2099	23.80	9.82	33.62	56.00	-22.38	QP	
8		1.2099	19.02	9.82	28.84	46.00	-17.16	AVG	
9		2.3500	25.95	9.73	35.68	56.00	-20.32	QP	
10		2.3500	11.90	9.73	21.63	46.00	-24.37	AVG	
11		3.4980	25.76	9.74	35.50	56.00	-20.50	QP	
12		3.4980	12.55	9.74	22.29	46.00	-23.71	AVG	

*:Maximum data x:Over limit !:over margin

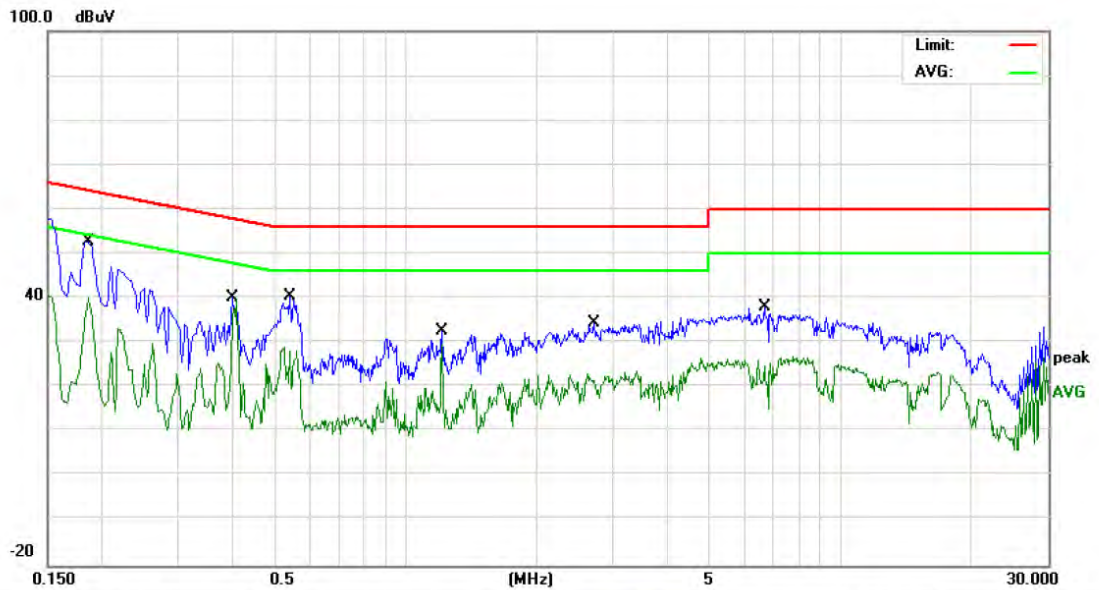

Site CONDUCTION #1 Phase: **N** Temperature: 22
 Limit: FCC Part 15B_(0.15-30MHz) _Main_QP Power: AC 120V/60Hz Humidity: 51 %
 Mode: Normal Link
 Note:

No.	Mk.	Freq.	Reading Level	Correct Factor	Measurement	Limit	Over	Detector	Comment
		MHz	dBuV	dB	dBuV	dBuV	dB		
1	*	0.1859	42.80	10.04	52.84	64.21	-11.37	QP	
2		0.1859	29.76	10.04	39.80	54.21	-14.41	AVG	
3		0.3980	30.03	10.05	40.08	57.89	-17.81	QP	
4		0.3980	25.72	10.05	35.77	47.89	-12.12	AVG	
5		0.5420	30.49	9.82	40.31	56.00	-15.69	QP	
6		0.5420	18.21	9.82	28.03	46.00	-17.97	AVG	
7		1.2098	22.77	9.84	32.61	56.00	-23.39	QP	
8		1.2098	19.68	9.84	29.52	46.00	-16.48	AVG	
9		2.7139	24.57	9.74	34.31	56.00	-21.69	QP	
10		2.7139	11.85	9.74	21.59	46.00	-24.41	AVG	
11		6.6779	28.36	9.74	38.10	60.00	-21.90	QP	
12		6.6779	12.37	9.74	22.11	50.00	-27.89	AVG	

*:Maximum data x:Over limit !:over margin

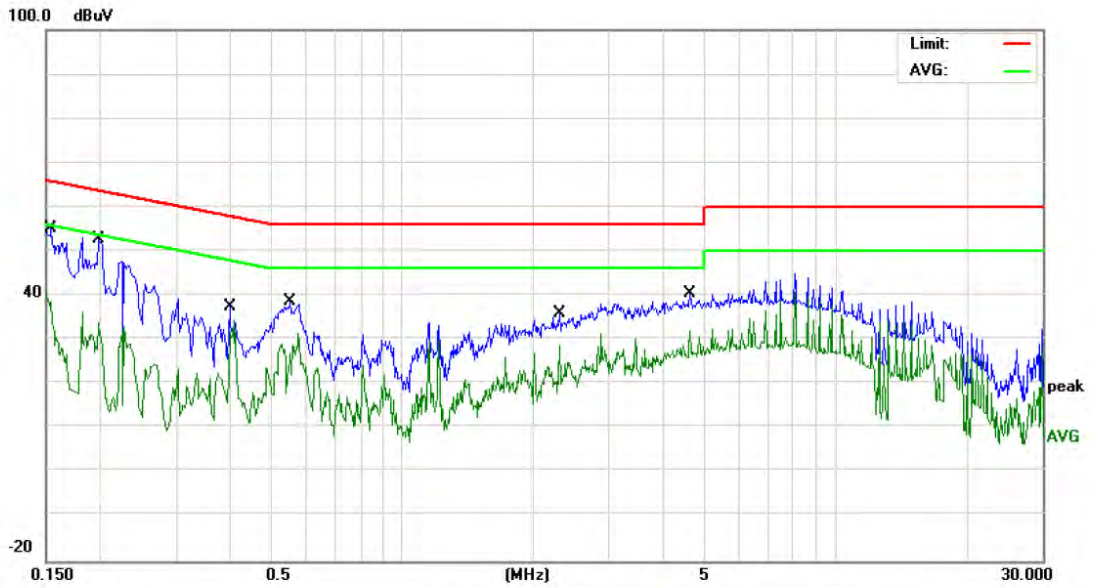

Site CONDUCTION #1 Phase: **L1** Temperature: 22
 Limit: FCC Part 15B_(0.15-30MHz) _Main_QP Power: AC 240V/50Hz Humidity: 51 %

Mode: Normal Link
 Note:

No.	Mk.	Freq.	Reading Level	Correct Factor	Measurement	Limit	Over	Detector	Comment
		MHz	dBuV	dB	dBuV	dBuV	dB		
1	*	0.1539	45.18	10.12	55.30	65.78	-10.48	QP	
2		0.1539	28.65	10.12	38.77	55.78	-17.01	AVG	
3		0.1980	42.54	10.13	52.67	63.69	-11.02	QP	
4		0.1980	23.63	10.13	33.76	53.69	-19.93	AVG	
5		0.3980	27.35	10.04	37.39	57.89	-20.50	QP	
6		0.3980	24.46	10.04	34.50	47.89	-13.39	AVG	
7		0.5500	28.73	9.79	38.52	56.00	-17.48	QP	
8		0.5500	17.12	9.79	26.91	46.00	-19.09	AVG	
9		2.2980	26.08	9.73	35.81	56.00	-20.19	QP	
10		2.2980	18.94	9.73	28.67	46.00	-17.33	AVG	
11		4.5979	30.76	9.75	40.51	56.00	-15.49	QP	
12		4.5979	22.25	9.75	32.00	46.00	-14.00	AVG	

!:Maximum data x:Over limit !:over margin

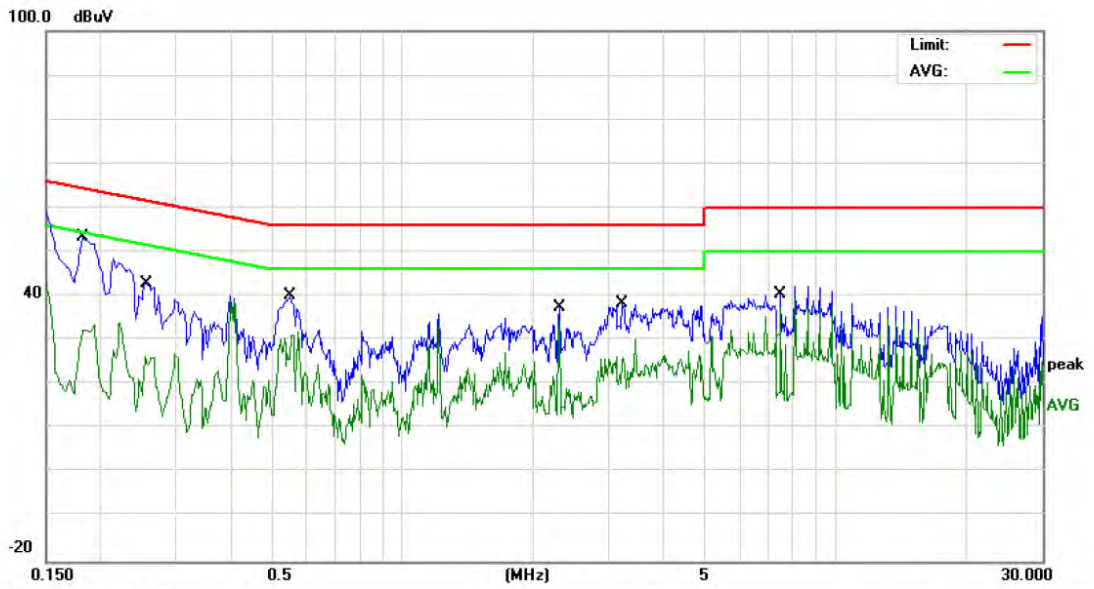

Site CONDUCTION #1 Phase: **N** Temperature: 22
 Limit: FCC Part 15B_(0.15-30MHz) _Main_QP Power: AC 240V/50Hz Humidity: 51 %

Mode: Normal Link

Note:

No.	Mk.	Freq.	Reading Level	Correct Factor	Measurement	Limit	Over	Detector	Comment
		MHz	dBuV	dB	dBuV	dBuV	dB		
1	*	0.1819	43.17	10.04	53.21	64.39	-11.18	QP	
2		0.1819	22.32	10.04	32.36	54.39	-22.03	AVG	
3		0.2586	32.26	10.08	42.34	61.47	-19.13	QP	
4		0.2586	14.37	10.08	24.45	51.47	-27.02	AVG	
5		0.5500	30.20	9.82	40.02	56.00	-15.98	QP	
6		0.5500	16.09	9.82	25.91	46.00	-20.09	AVG	
7		2.2980	27.78	9.75	37.53	56.00	-18.47	QP	
8		2.2980	21.07	9.75	30.82	46.00	-15.18	AVG	
9		3.2179	28.51	9.73	38.24	56.00	-17.76	QP	
10		3.2179	15.71	9.73	25.44	46.00	-20.56	AVG	
11		7.4659	30.67	9.74	40.41	60.00	-19.59	QP	
12		7.4659	8.43	9.74	18.17	50.00	-31.83	AVG	

*:Maximum data x:Over limit !:over margin

7.2 RADIATED SPURIOUS EMISSION

7.2.1 Applicable Standard

According to FCC Part 15.247(d) and 15.209 and DA 00-705

7.2.2 Conformance Limit

According to FCC Part 15.247(d): radiated emissions which fall in the restricted bands, as defined in §15.205(a), must also comply with the radiated emission limits specified in §15.209(a) (see §15.205(c)).
According to FCC Part 15.205, Restricted bands

MHz	MHz	MHz	GHz
0.090-0.110	16.42-16.423	399.9-410	4.5-5.15
10.495-0.505	16.69475-16.69525	608-614	5.35-5.46
2.1735-2.1905	16.80425-16.80475	960-1240	7.25-7.75
4.125-4.128	25.5-25.67	1300-1427	8.025-8.5
4.17725-4.17775	37.5-38.25	1435-1626.5	9.0-9.2
4.20725-4.20775	73-74.6	1645.5-1646.5	9.3-9.5
6.215-6.218	74.8-75.2	1660-1710	10.6-12.7
6.26775-6.26825	123-138	2200-2300	14.47-14.5
8.291-8.294	149.9-150.05	2310-2390	15.35-16.2
8.362-8.366	156.52475-156.52525	2483.5-2500	17.7-21.4
8.37625-8.38675	156.7-156.9	2690-2900	22.01-23.12
8.41425-8.41475	162.0125-167.17	3260-3267	23.6-24.0
12.29-12.293	167.72-173.2	3332-3339	31.2-31.8
12.51975-12.52025	240-285	3345.8-3358	36.43-36.5
12.57675-12.57725	322-335.4	3600-4400	(2)
13.36-13.41			

20dBc in any 100 kHz bandwidth outside the operating frequency band. In case the emission fall within the restricted band specified on 15.205(a), then the 15.209(a) limit in the table below has to be followed.

Restricted Frequency(MHz)	Field Strength (µV/m)	Field Strength (dBµV/m)	Measurement Distance
0.009~0.490	2400/F(KHz)	20 log (uV/m)	300
0.490~1.705	2400/F(KHz)	20 log (uV/m)	30
1.705~30.0	30	29.5	30
30-88	100	40	3
88-216	150	43.5	3
216-960	200	46	3
Above 960	500	54	3

Limits of Radiated Emission Measurement(Above 1000MHz)

Frequency(MHz)	Class B (dBuV/m) (at 3M)	
	PEAK	AVERAGE
Above 1000	74	54

- Remark :1. Emission level in dBuV/m=20 log (uV/m)
 2. Measurement was performed at an antenna to the closed point of EUT distance of meters.
 3. Distance extrapolation factor =40log(Specific distance/ test distance)(dB);
 Limit line=Specific limits(dBuV) + distance extrapolation factor.

7.2.3 Measuring Instruments

The Measuring equipment is listed in the section 6.3 of this test report.

7.2.4 Test Configuration

(a) For radiated emissions below 30MHz

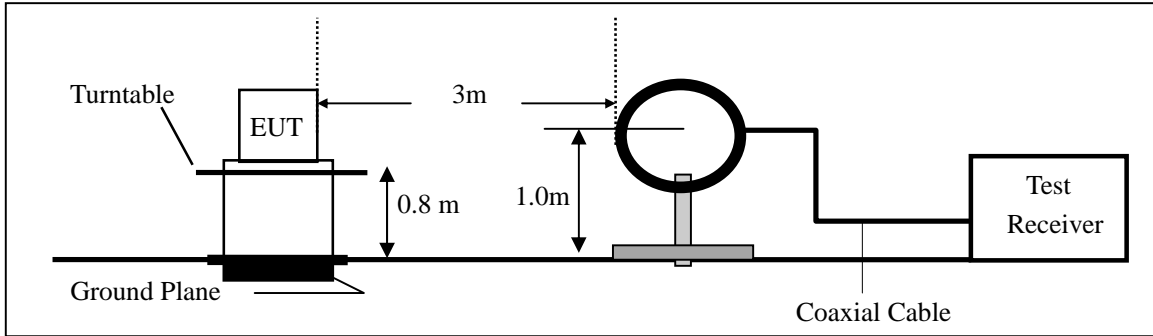

(b) For radiated emissions from 30MHz to 1000MHz

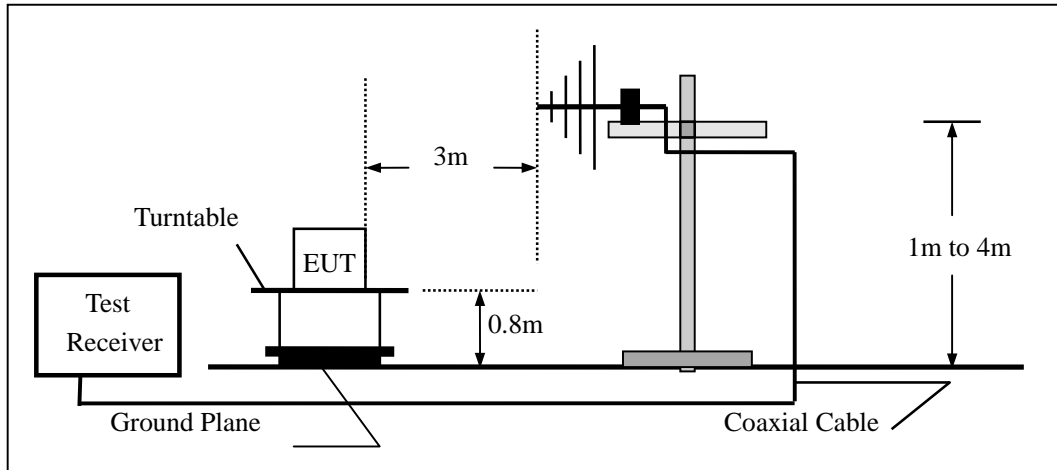

(c) For radiated emissions above 1000MHz

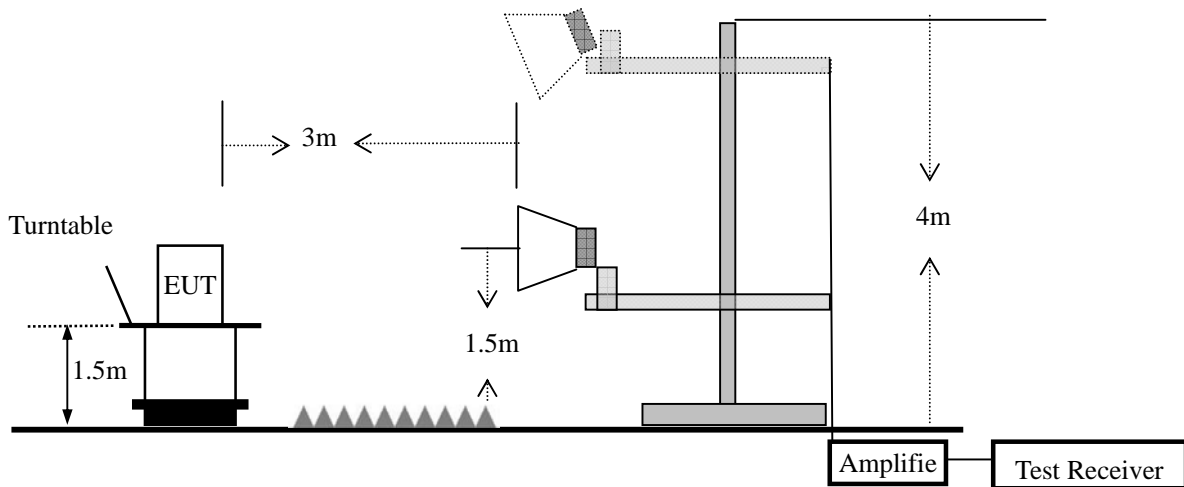

7.2.5 Test Procedure

The test site semi-anechoic chamber has met the requirement of NSA tolerance 4 dB according to the standards: ANSI C63.10-2013. The test distance is 3m. The setup is according to the requirements in Section 13.1.4.1 of ANSI C63.10-2013 and CAN/CSA-CEI/IEC CISPR 22.

This test is required for any spurious emission that falls in a Restricted Band, as defined in Section 15.205. It must be performed with the highest gain of each type of antenna proposed for use with the EUT.

Use the following spectrum analyzer settings:

Spectrum Parameter	Setting
Attenuation	Auto
Start Frequency	1000 MHz
Stop Frequency	10th carrier harmonic
RB / VB (emission in restricted band)	1 MHz / 1 MHz for Peak, 1 MHz / 10Hz for Average

Receiver Parameter	Setting
Attenuation	Auto
Start ~ Stop Frequency	9kHz~150kHz / RB 200Hz for QP
Start ~ Stop Frequency	150kHz~30MHz / RB 9kHz for QP
Start ~ Stop Frequency	30MHz~1000MHz / RB 120kHz for QP

- The measuring distance of at 3 m shall be used for measurements at frequency up to 1GHz. For frequencies above 1GHz, any suitable measuring distance may be used.
- The EUT was placed on the top of a rotating table 0.8 m for below 1GHz and 1.5m for above 1GHz the ground at a 3 meter. The table was rotated 360 degrees to determine the position of the highest radiation.
- The height of the equipment or of the substitution antenna shall be 0.8 m for below 1GHz and 1.5m for above 1GHz; the height of the test antenna shall vary between 1 m to 4 m. Both horizontal and vertical polarizations of the antenna are set to make the measurement.
- The initial step in collecting conducted emission data is a spectrum analyzer peak detector mode pre-scanning the measurement frequency range. Significant peaks are then marked and then Quasi Peak detector mode re-measured.
- If the Peak Mode measured value compliance with and lower than Quasi Peak Mode Limit, the EUT shall be deemed to meet QP Limits and then no additional QP Mode measurement performed.
- For the actual test configuration, please refer to the related Item –EUT Test Photos.

Note:

Both horizontal and vertical antenna polarities were tested and performed pretest to three orthogonal axis. The worst case emissions were reported

During the radiated emission test, the Spectrum Analyzer was set with the following configurations:

Frequency Band (MHz)	Function	Resolution bandwidth	Video Bandwidth
30 to 1000	QP	120 kHz	300 kHz
Above 1000	Peak	1 MHz	1 MHz
	Average	1 MHz	10 Hz

Note: for the frequency ranges below 30 MHz, a narrower RBW is used for these ranges but the measured value should add a RBW correction factor (RBWCF) where $RBWCF [dB] = 10 \cdot \lg(100 [kHz] / \text{narrower RBW [kHz]})$. , the narrower RBW is 1 kHz and RBWCF is 20 dB for the frequency 9 kHz to 150 kHz, and the narrower RBW is 10 kHz and RBWCF is 10 dB for the frequency 150 kHz to 30 MHz.

7.2.6 Test Results

■ Spurious Emission below 30MHz (9KHz to 30MHz)

EUT:	EcoBoulder	Model No.:	GDI-EXBM901
Temperature:	20 °C	Relative Humidity:	48%
Test Mode:	Mode2/Mode3/Mode4	Test By:	Susan Su

Freq. (MHz)	Ant.Pol. H/V	Emission Level(dBuV/m)		Limit 3m(dBuV/m)		Over(dB)	
		PK	AV	PK	AV	PK	AV
--	--	--	--	--	--	--	--

Note: the amplitude of spurious emission that is attenuated by more than 20dB below the permissible limit has no need to be reported.

Distance extrapolation factor = $20\log(\text{Specific distance/ test distance})$ (dB);

Limit line=Specific limits(dBuV) + distance extrapolation factor

- Spurious Emission below 1GHz (30MHz to 1GHz)
All the modulation modes have been tested, and the worst result was report as below:

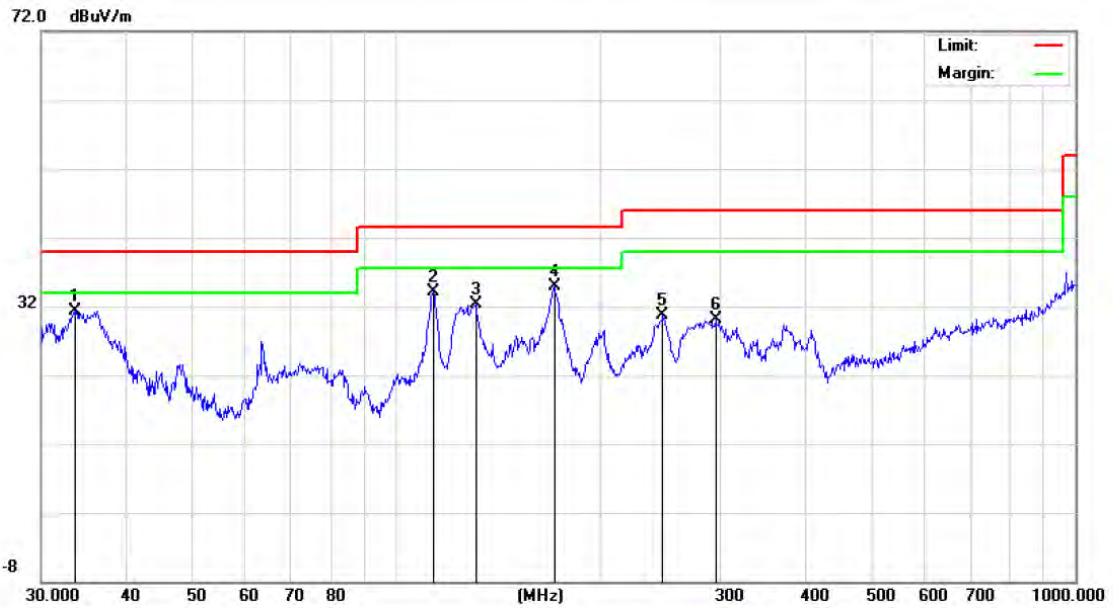

Site: Polarization: **Vertical** Temperature: 24
 Limit: FCC_PART15_B_03m_QP Power: AC 120V/60Hz Humidity: 50 %
 Mode: Normal Link
 Note:

No.	Mk.	Freq.	Reading Level	Correct Factor	Measurement	Limit	Over	Antenna Height	Table Degree	
		MHz	dBuV	dB	dBuV/m	dBuV/m	dB	cm	degree	Comment
1		33.5624	12.79	18.51	31.30	40.00	-8.70			QP
2		113.3163	22.76	11.29	34.05	43.50	-9.45			QP
3		130.8369	20.23	12.00	32.23	43.50	-11.27			QP
4	*	170.7926	21.23	13.58	34.81	43.50	-8.69			QP
5		246.8147	18.74	11.94	30.68	46.00	-15.32			QP
6		295.1469	16.42	13.71	30.13	46.00	-15.87			QP

*:Maximum data x:Over limit !:over margin

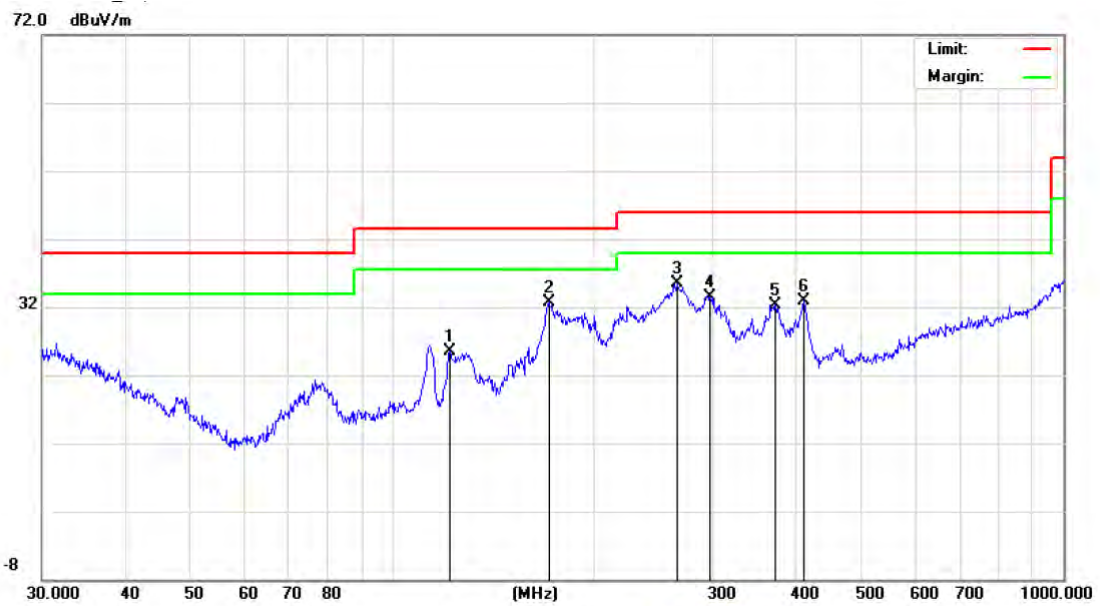

Site: Polarization: *Horizontal* Temperature: 24
 Limit: FCC_PART15_B_03m_QP Power: AC 120V/60Hz Humidity: 50 %
 Mode: Normal Link
 Note:

No.	Mk.	Freq.	Reading Level	Correct Factor	Measurement	Limit	Over	Antenna Height	Table Degree	
		MHz	dBuV	dB	dBuV/m	dBuV/m	dB	cm	degree	Comment
1		121.5485	13.89	11.65	25.54	43.50	-17.96	QP		
2		170.7926	19.16	13.58	32.74	43.50	-10.76	QP		
3	*	265.6757	22.83	12.62	35.45	46.00	-10.55	QP		
4		297.2241	19.83	13.76	33.59	46.00	-12.41	QP		
5		372.0045	16.37	16.01	32.38	46.00	-13.62	QP		
6		410.3825	16.83	15.99	32.82	46.00	-13.18	QP		

*:Maximum data x:Over limit !:over margin

■ Spurious Emission Above 1GHz (1GHz to 25GHz)

EUT:	EcoBoulder	Model No.:	GDI-EXBM901
Temperature:	20 °C	Relative Humidity:	48%
Test Mode:	Mode2/Mode3/Mode4	Test By:	Susan Su

All the modulation modes have been tested, and the worst result was report as below:

Frequency (MHz)	Meter Reading (dBµV)	Factor (dB)	Emission Level (dBµV/m)	Limits (dBµV/m)	Margin (dB)	Remark	Comment
Low Channel (2402 MHz)-Above 1G							
4804.204	52.61	-3.64	56.25	74.00	-17.75	Pk	Vertical
4804.135	44.72	-3.64	48.36	54.00	-5.64	AV	Vertical
7206.182	53.15	-0.95	54.10	74.00	-19.90	Pk	Vertical
7206.024	42.64	-0.95	43.59	54.00	-10.41	AV	Vertical
4804.134	57.37	-3.64	61.01	74.00	-12.99	Pk	Horizontal
4804.204	44.48	-3.64	48.12	54.00	-5.88	AV	Horizontal
7206.171	55.54	-0.95	56.49	74.00	-17.51	Pk	Horizontal
7206.236	40.46	-0.95	41.41	54.00	-12.59	AV	Horizontal
Mid Channel (2441 MHz)-Above 1G							
4882.121	58.25	-3.68	61.93	74.00	-12.07	Pk	Vertical
4882.126	42.69	-3.68	46.37	54.00	-7.63	AV	Vertical
7323.025	55.37	-0.82	56.19	74.00	-17.81	Pk	Vertical
7323.131	43.64	-0.82	44.46	54.00	-9.54	AV	Vertical
4882.314	60.31	-3.68	63.99	74.00	-10.01	Pk	Horizontal
4882.274	41.42	-3.68	45.10	54.00	-8.90	AV	Horizontal
7323.125	57.55	-0.82	58.37	74.00	-15.63	Pk	Horizontal
7323.102	43.62	-0.82	44.44	54.00	-9.56	AV	Horizontal
High Channel (2480 MHz)- Above 1G							
4960.102	60.14	-3.59	63.73	74.00	-10.27	Pk	Vertical
4960.078	43.59	-3.59	47.18	54.00	-6.82	AV	Vertical
7440.314	54.92	-0.68	55.60	74.00	-18.40	Pk	Vertical
7440.224	39.12	-0.68	39.80	54.00	-14.20	AV	Vertical
4960.345	59.45	-3.59	63.04	74.00	-10.96	Pk	Horizontal
4960.202	41.54	-3.59	45.13	54.00	-8.87	AV	Horizontal
7440.127	54.85	-0.68	55.53	74.00	-18.47	Pk	Horizontal
7440.214	39.94	-0.68	40.62	54.00	-13.38	AV	Horizontal

Note: (1) All Readings are Peak Value (VBW=3MHz) and Peak Value (VBW=10Hz).
 (2) Emission Level= Reading Level+Probe Factor +Cable Loss.
 (3)All other emissions more than 20dB below the limit.

■ Spurious Emission in Band edge

EUT:	EcoBoulder	Model No.:	GDI-EXBM901
Temperature:	20 °C	Relative Humidity:	48%
Test Mode:	Mode2/Mode4	Test By:	Susan Su

All the modulation modes have been tested, and the worst result was report as below:

Frequency (MHz)	Meter Reading (dBμV)	Factor (dB)	Emission Level (dBμV/m)	Limits (dBμV/m)	Margin (dB)	Detector Type	Comment
1Mbps Non-hopping							
2390	50.42	-13.06	37.36	74.00	-36.64	Pk	Vertical
2390	51.36	-13.06	38.30	74.00	-35.70	pk	Horizontal
2483.5	56.24	-12.78	43.46	74.00	-30.54	Pk	Vertical
2483.5	57.43	-12.78	44.65	74.00	-29.35	Pk	Horizontal
1Mbps hopping							
2390	56.25	-13.06	43.19	74.00	-30.81	Pk	Vertical
2390	57.61	-13.06	44.55	74.00	-29.45	Pk	Horizontal
2483.5	58.42	-12.78	45.64	74.00	-28.36	Pk	Vertical
2483.5	57.43	-12.78	44.65	74.00	-29.35	Pk	Horizontal

Note: (1) All other emissions more than 20dB below the limit.

■ Spurious Emission in Restricted Band 3260MHz-18000MHz

EUT:	EcoBoulder	Model No.:	GDI-EXBM901
Temperature:	20 °C	Relative Humidity:	48%
Test Mode:	Mode2/Mode3/Mode4	Test By:	Susan Su

All the modulation modes have been tested, and the worst result was report as below:

Frequency (MHz)	Meter Reading (dBµV)	Factor (dB)	Emission Level (dBµV/m)	Limits (dBµV/m)	Margin (dB)	Detector Type	Comment
1Mbps Non-hopping							
3260	30.56	-13.06	17.5	74	-56.5	Pk	Vertical
3260	57.73	-13.06	44.67	54	-9.33	AV	Vertical
3260	58.93	-13.06	45.87	74	-28.13	Pk	Horizontal
3260	52.26	-13.06	39.2	54	-14.8	AV	Horizontal
3332	63.37	-12.78	50.59	74	-23.41	Pk	Vertical
3332	49.62	-12.78	36.84	54	-17.16	AV	Vertical
3332	60.52	-12.78	47.74	74	-26.26	Pk	Horizontal
3332	50.4	-12.78	37.62	54	-16.38	AV	Horizontal
17789	63.82	-12.24	51.58	74	-22.42	Pk	Vertical
17789	53.5	-12.24	41.26	54	-12.74	AV	Vertical
17957	64.31	-12.24	52.07	74	-21.93	Pk	Horizontal
17957	54.26	-12.24	42.02	54	-11.98	AV	Horizontal
1Mbps hopping							
3260	60.81	-13.06	47.75	74	-26.25	Pk	Vertical
3260	50.39	-13.06	37.33	54	-16.67	AV	Vertical
3260	59.37	-13.06	46.31	74	-27.69	Pk	Horizontal
3260	50.06	-13.06	37	54	-17	AV	Horizontal
3332	61.16	-12.78	48.38	74	-25.62	Pk	Vertical
3332	48.29	-12.78	35.51	54	-18.49	AV	Vertical
3332	62.48	-12.78	49.7	74	-24.3	Pk	Horizontal
3332	50.45	-12.78	37.67	54	-16.33	AV	Horizontal
17781	63.19	-12.24	50.95	74	-23.05	Pk	Vertical
17781	53.42	-12.24	41.18	54	-12.82	AV	Vertical
17955	64.23	-12.24	51.99	74	-22.01	Pk	Horizontal
17955	54.22	-12.24	41.98	54	-12.02	AV	Horizontal

Note: (1) All other emissions more than 20dB below the limit.

7.3 NUMBER OF HOPPING CHANNEL

7.3.1 Applicable Standard

According to FCC Part 15.247(a)(1) (iii)and DA 00-705

7.3.2 Conformance Limit

Frequency hopping systems in the 2400-2483.5MHz band shall use at least 15 channels.

7.3.3 Measuring Instruments

The Measuring equipment is listed in the section 6.3 of this test report.

7.3.4 Test Setup

Please refer to Section 6.1 of this test report.

7.3.5 Test Procedure

The testing follows ANSI C63.10-2013 clause 7.8.3
 The RF output of EUT was connected to the spectrum analyzer by RF cable and attenuator.
 The path loss was compensated to the results for each measurement.
 Set to the maximum power setting and enable the EUT transmit continuously.
 The EUT must have its hopping function enabled.
 Use the following spectrum analyzer settings:
 Span = the frequency band of operation
 RBW ≥ 1% of the span
 VBW ≥ RBW
 Sweep = auto
 Detector function = peak
 Trace = max hold

7.3.6 Test Results

EUT:	EcoBoulder	Model No.:	GDI-EXBM901
Temperature:	20 °C	Relative Humidity:	48%
Test Mode:	Mode2/Mode3/Mode4	Test By:	Susan Su

Number of Hopping (Channel)	Adaptive Frequency hopping (Channel)	limit	Verdict
79	20	≥15	Pass

Number of Hopping Channel Plot

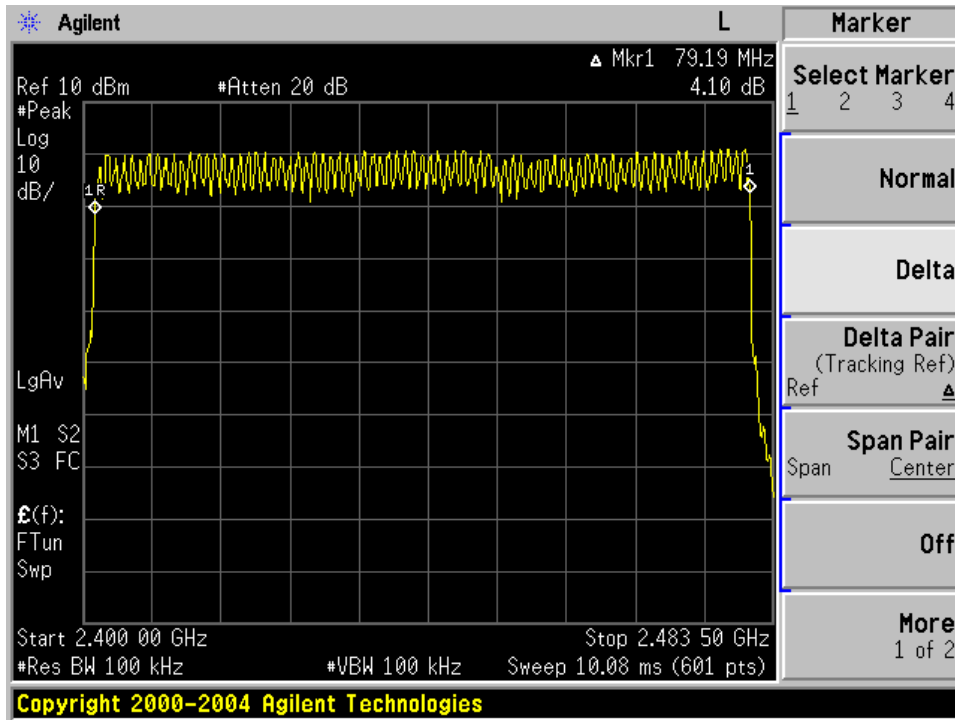

7.4 HOPPING CHANNEL SEPARATION MEASUREMENT

7.4.1 Applicable Standard

According to FCC Part 15.247(a)(1) and DA 00-705

7.4.2 Conformance Limit

Frequency hopping systems operating in the 2400-2483.5MHz band shall have hopping channel carrier frequencies that are separated by 25kHz or two-thirds of the 20dB bandwidth of the hopping channel, whichever is greater.

7.4.3 Measuring Instruments

The Measuring equipment is listed in the section 6.3 of this test report.

7.4.4 Test Setup

Please refer to Section 6.1 of this test report.

7.4.5 Test Procedure

The testing follows ANSI C63.10-2013 clause 7.8.2
 The RF output of EUT was connected to the spectrum analyzer by RF cable and attenuator.
 The path loss was compensated to the results for each measurement.
 Set to the maximum power setting and enable the EUT transmit continuously.
 The EUT was operating in controlled its channel.
 Use the following spectrum analyzer settings:
 Span = Measurement Bandwidth or Channel Separation
 RBW ≥ 30KHz
 VBW ≥ 3*RBW
 Sweep = auto
 Detector function = peak
 Trace = max hold

7.4.6 Test Results

EUT:	EcoBoulder	Model No.:	GDI-EXBM901
Temperature:	20 °C	Relative Humidity:	48%
Test Mode:	Mode2/Mode3/Mode4	Test By:	Susan Su

Modulation Mode	Channel Number	Channel Frequency (MHz)	Measurement Bandwidth (kHz)	Limit (kHz)		Verdict
GFSK	0	2402	1000	>912.233	20dB BW	PASS
	39	2441	1000	>875.199	20dB BW	PASS
	78	2480	1000	>875.022	20dB BW	PASS
π/4-DQPSK	0	2402	1000	>814.667	2/3 of 20dB BW	PASS
	39	2441	1000	>816.667	2/3 of 20dB BW	PASS
	78	2480	1000	>814.000	2/3 of 20dB BW	PASS
8DPSK	0	2402	1000	>808.667	2/3 of 20dB BW	PASS
	39	2441	1000	>810.000	2/3 of 20dB BW	PASS
	78	2480	1000	>808.667	2/3 of 20dB BW	PASS

Channel Separation plot on channel 00-01

1Mbps

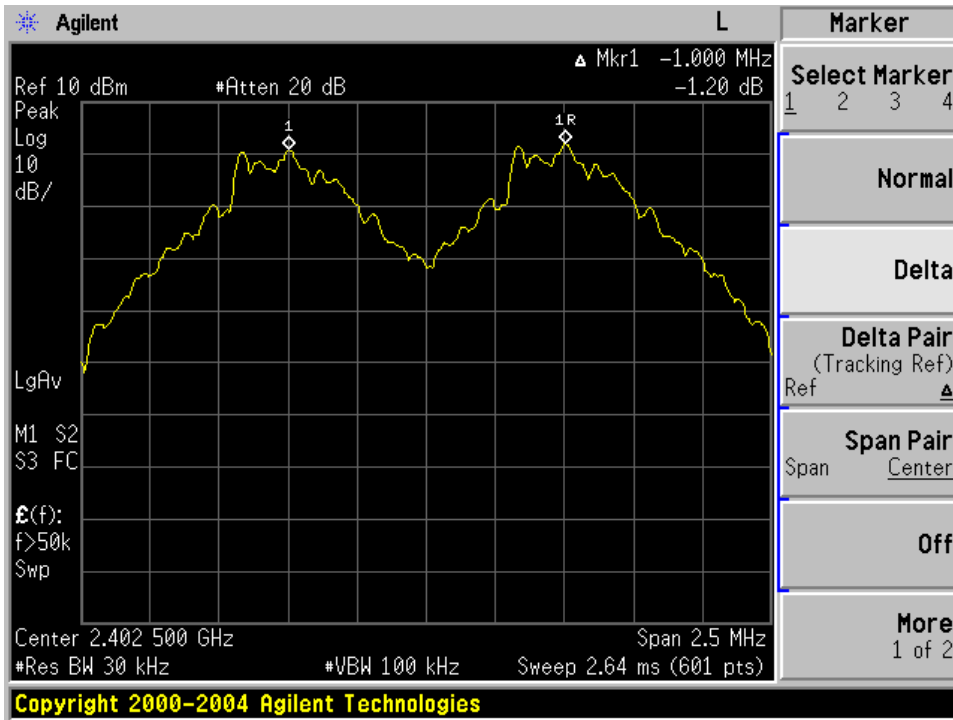

Channel Separation plot on channel 39-40

1Mbps

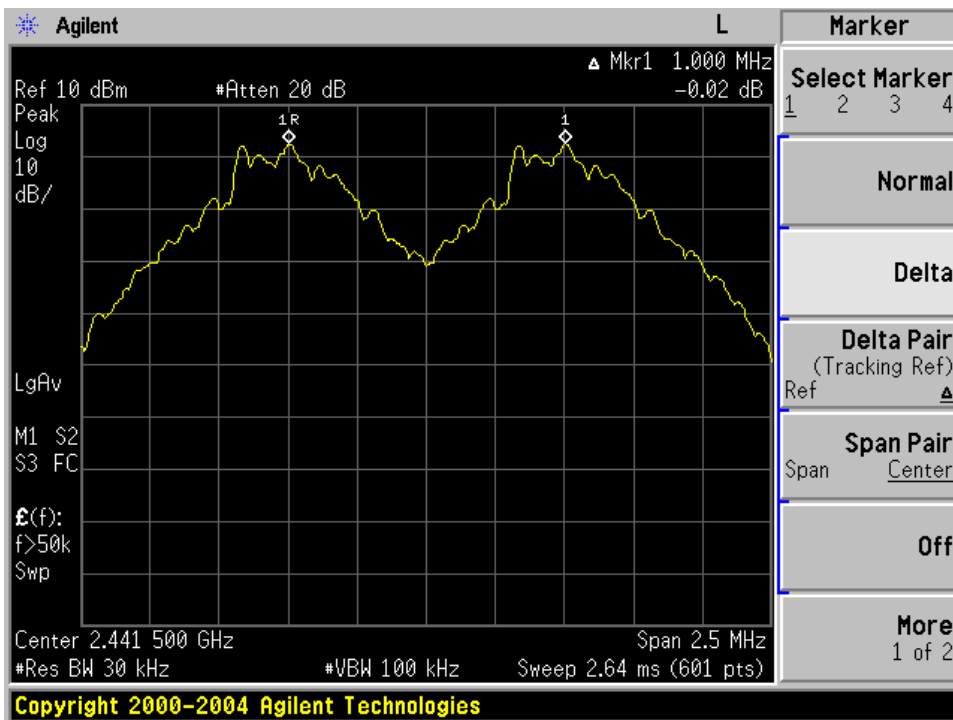

Channel Separation plot on channel 77-78

1Mbps

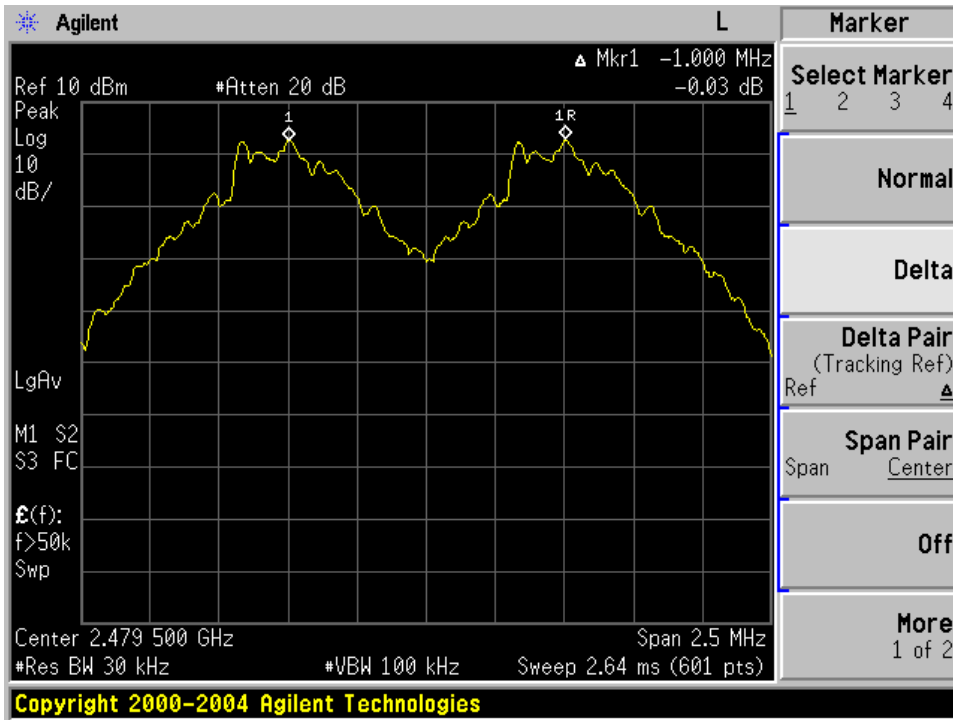

Channel Separation plot on channel 00-01

2Mbps

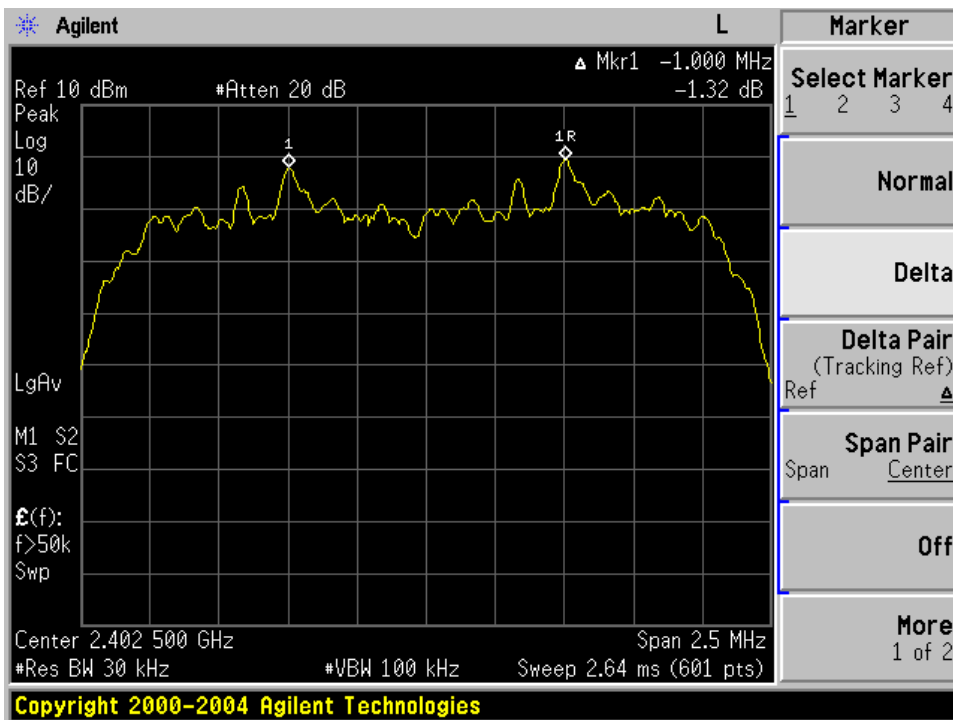

Channel Separation plot on channel 39-40

2Mbps

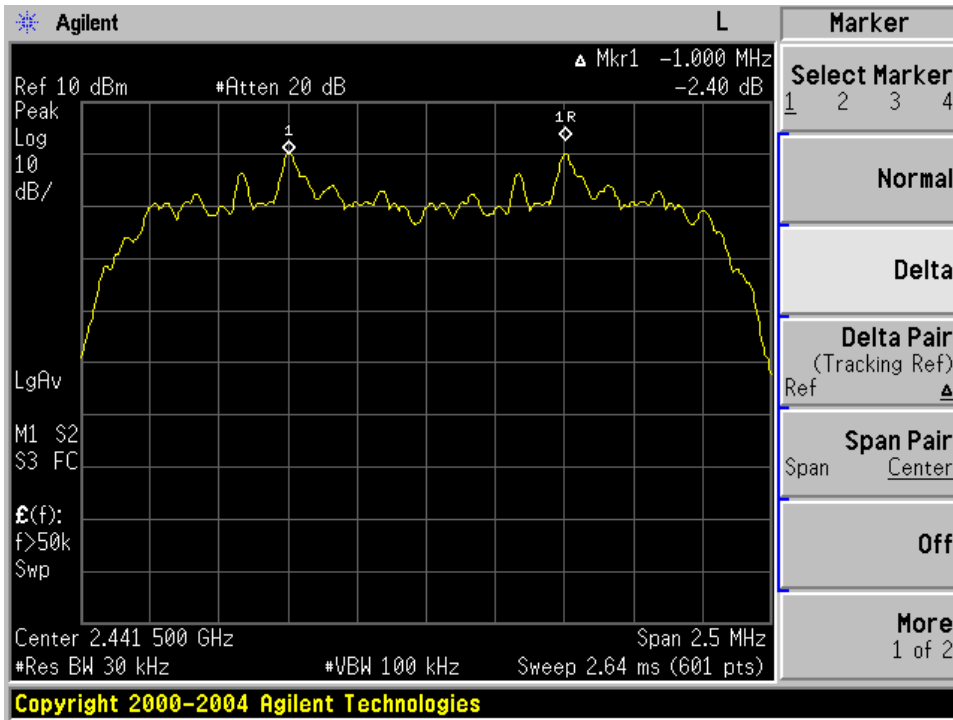

Channel Separation plot on channel 77-78

2Mbps

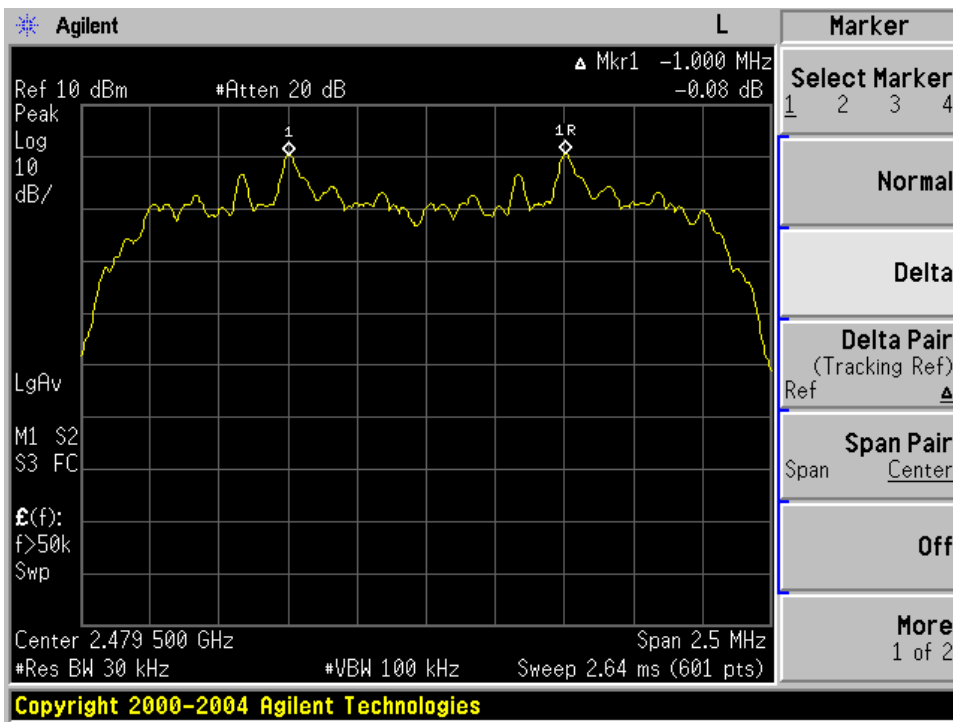

Channel Separation plot on channel 00-01

3Mbps

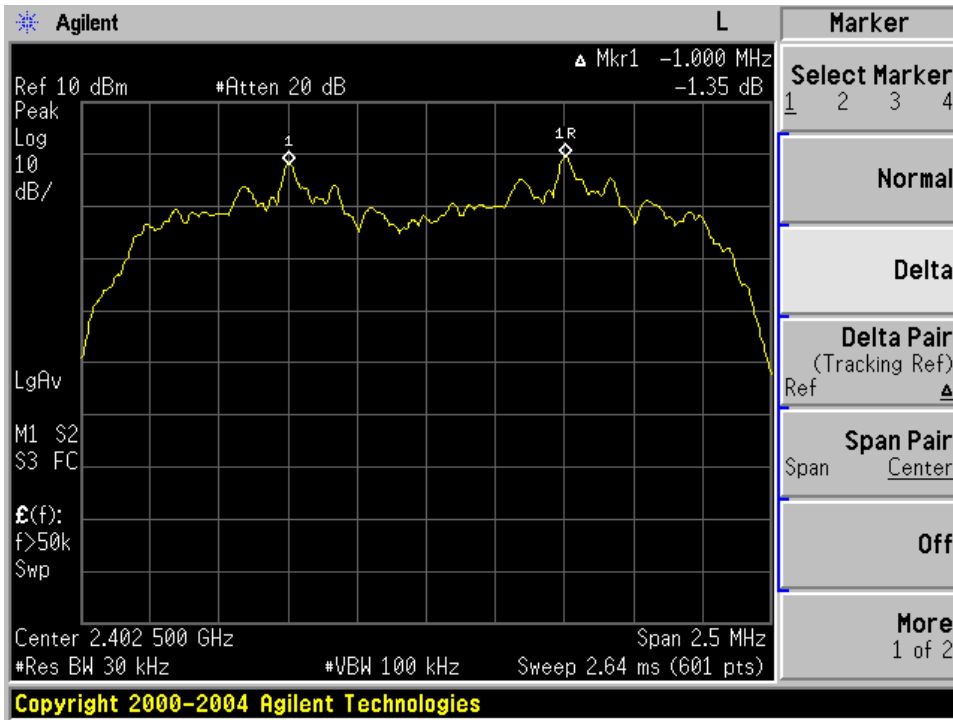

Channel Separation plot on channel 39-40

3Mbps

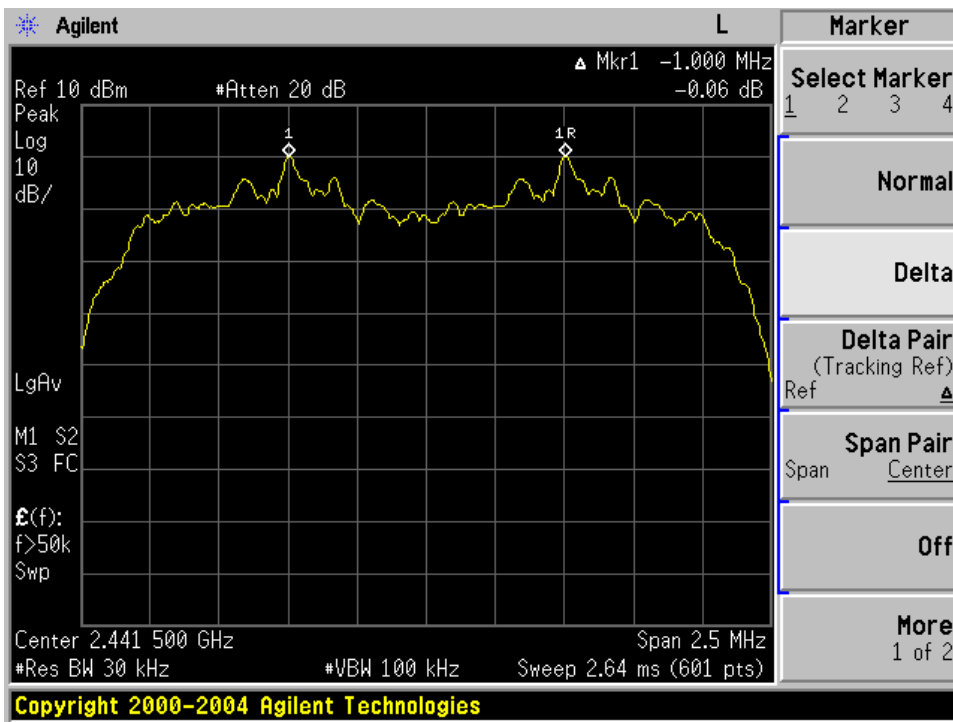

Channel Separation plot on channel 77-78

3Mbps

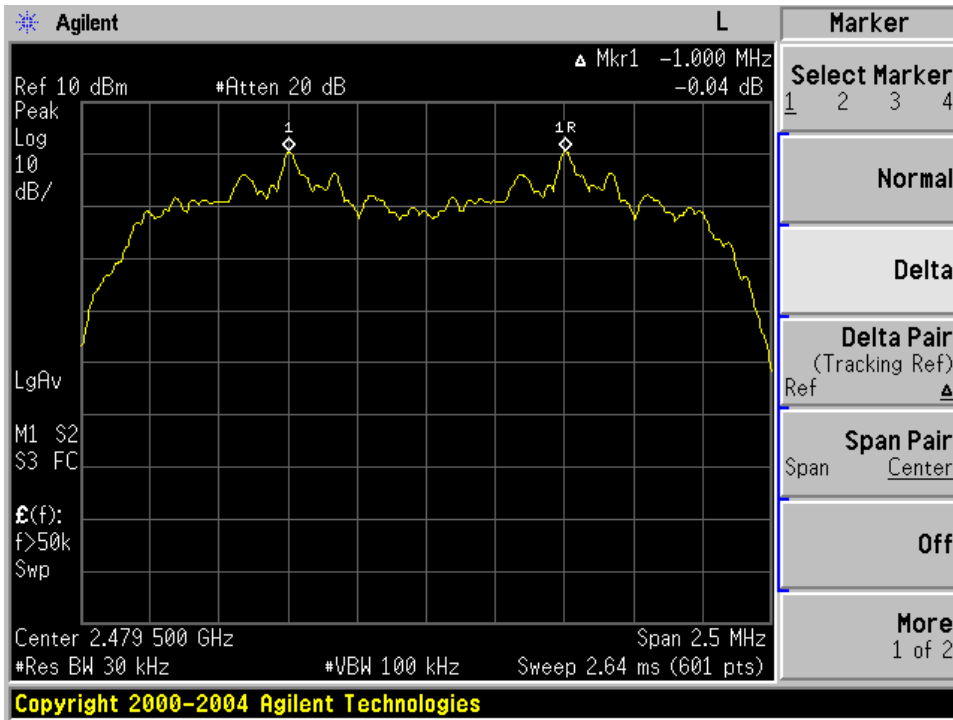

7.5 AVERAGE TIME OF OCCUPANCY (DWELL TIME)

7.5.1 Applicable Standard

According to FCC Part 15.247(a)(1)(iii) and DA 00-705

7.5.2 Conformance Limit

The average time of occupancy on any channel shall not be greater than 0.4s within a period of 0.4s multiplied by the number of hopping channels employed.

7.5.3 Measuring Instruments

The Measuring equipment is listed in the section 6.3 of this test report.

7.5.4 Test Setup

Please refer to Section 6.1 of this test report.

7.5.5 Test Procedure

The testing follows ANSI C63.10-2013 clause 7.8.4

The RF output of EUT was connected to the spectrum analyzer by RF cable and attenuator.

The path loss was compensated to the results for each measurement.

Set to the maximum power setting and enable the EUT transmit continuously.

The EUT must have its hopping function enabled.

Use the following spectrum analyzer settings:

Span = zero span, centered on a hopping channel

RBW \geq 1MHz

VBW \geq RBW

Sweep = as necessary to capture the entire dwell time per hopping channel

Detector function = peak

Trace = max hold

Measure the maximum time duration of one single pulse.

Set the EUT for DH5, DH3 and DH1 packet transmitting.

Measure the maximum time duration of one single pulse.

7.5.6 Test Results

EUT:	EcoBoulder	Model No.:	GDI-EXBM901
Temperature:	20 °C	Relative Humidity:	48%
Test Mode:	Mode2/Mode3/Mode4	Test By:	Susan Su

Modulation Mode	Channel Number	Packet type	Mode	Hops Over Occupancy Time (ms)	Pulse width (ms)	dwll time (ms)	Limit (ms)	Verdict
GFSK	39	DH1	Normal	320.00	0.452	144.640	<400	PASS
	39		AFH	160.00	0.452	72.320	<400	PASS
	39	DH3	Normal	160.00	1.668	266.880	<400	PASS
	39		AFH	80.00	1.668	133.440	<400	PASS
	39	DH5	Normal	106.67	2.911	310.516	<400	PASS
	39		AFH	53.33	2.911	155.244	<400	PASS
π/4-DQPSK	39	2DH1	Normal	320.00	0.424	135.680	<400	PASS
	39		AFH	160.00	0.424	67.840	<400	PASS
	39	2DH3	Normal	160.00	1.668	266.880	<400	PASS
	39		AFH	80.00	1.668	133.440	<400	PASS
	39	2DH5	Normal	106.67	2.926	312.116	<400	PASS
	39		AFH	53.33	2.926	156.044	<400	PASS
8DPSK	39	3DH1	Normal	320.00	0.424	135.680	<400	PASS
	39		AFH	160.00	0.424	67.840	<400	PASS
	39	3DH3	Normal	160.00	1.682	269.120	<400	PASS
	39		AFH	80.00	1.682	134.560	<400	PASS
	39	3DH5	Normal	106.67	2.911	310.516	<400	PASS
	39		AFH	53.33	2.911	155.244	<400	PASS

Note:

A Period Time = (channel number)*0.4

DH1 Time Slot: Reading * (1600/2)*31.6/(channel number)

DH3 Time Slot: Reading * (1600/4)*31.6/(channel number)

DH5 Time Slot: Reading * (1600/6)*31.6/(channel number)

For Example:

1. In normal mode, hopping rate is 1600 hops/s with 6 slots in 79 hopping channels. With channel hopping rate (1600 / 6 / 79) in Occupancy Time Limit (0.4 x 79) (s), Hops Over Occupancy Time comes to (1600 / 6 / 79) x (0.4 x 79) = 106.67 hops.
2. In AFH mode, hopping rate is 800 hops/s with 6 slots in 20 hopping channels. With channel hopping rate (800 / 6 / 20) in Occupancy Time Limit (0.4 x 20) (s), Hops Over Occupancy Time comes to (800 / 6 / 20) x (0.4 x 20) = 53.33 hops.
3. Dwell Time(s) = Hops Over Occupancy Time (hops) x Package Transfer Time

Package Transfer Time Plot CH39-DH1

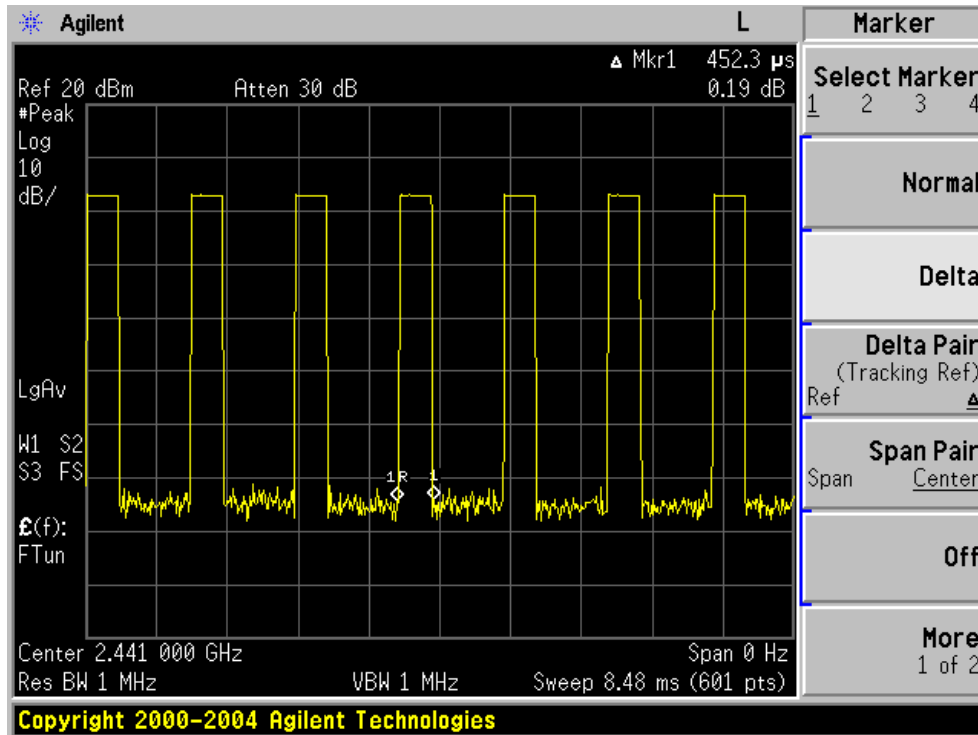

Package Transfer Time Plot CH39-DH3

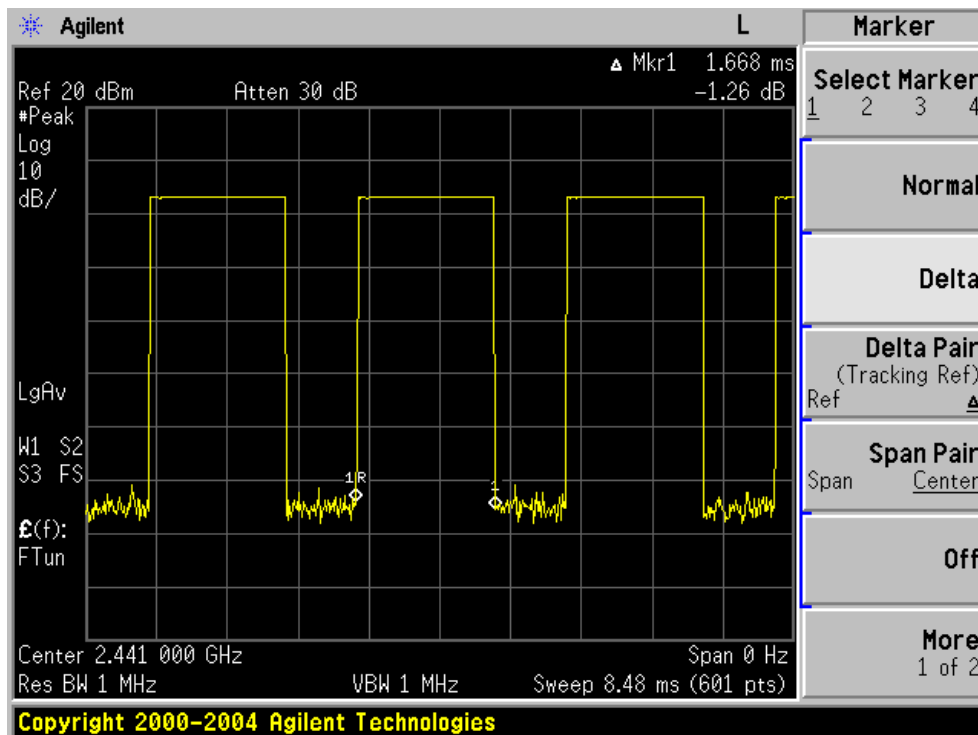

Package Transfer Time Plot CH39-DH5

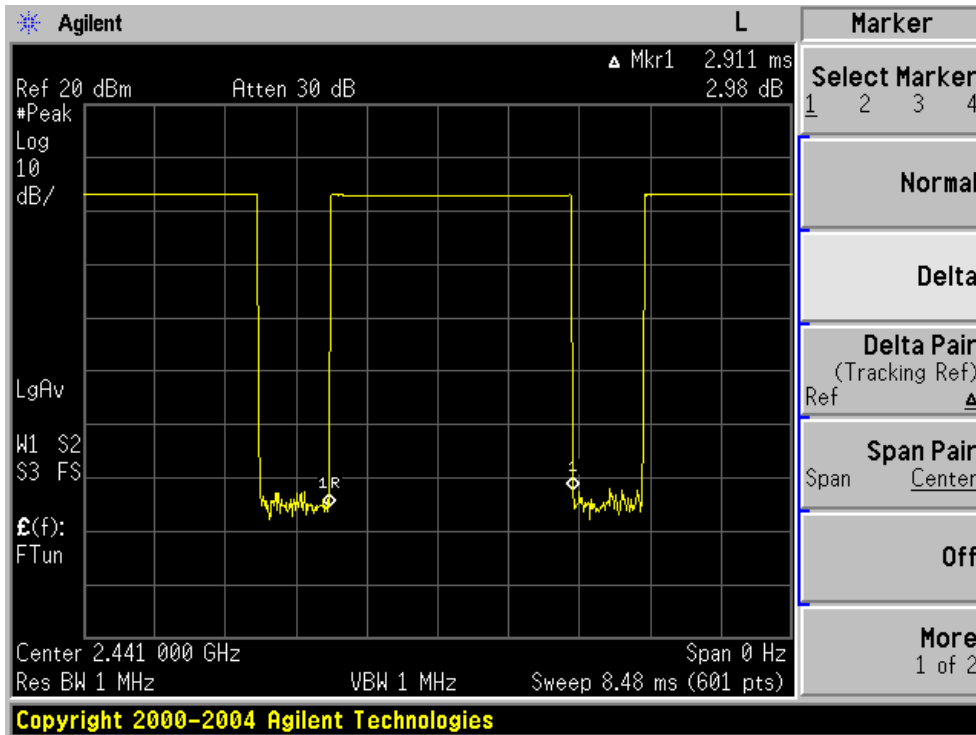

Package Transfer Time Plot CH39-2DH1

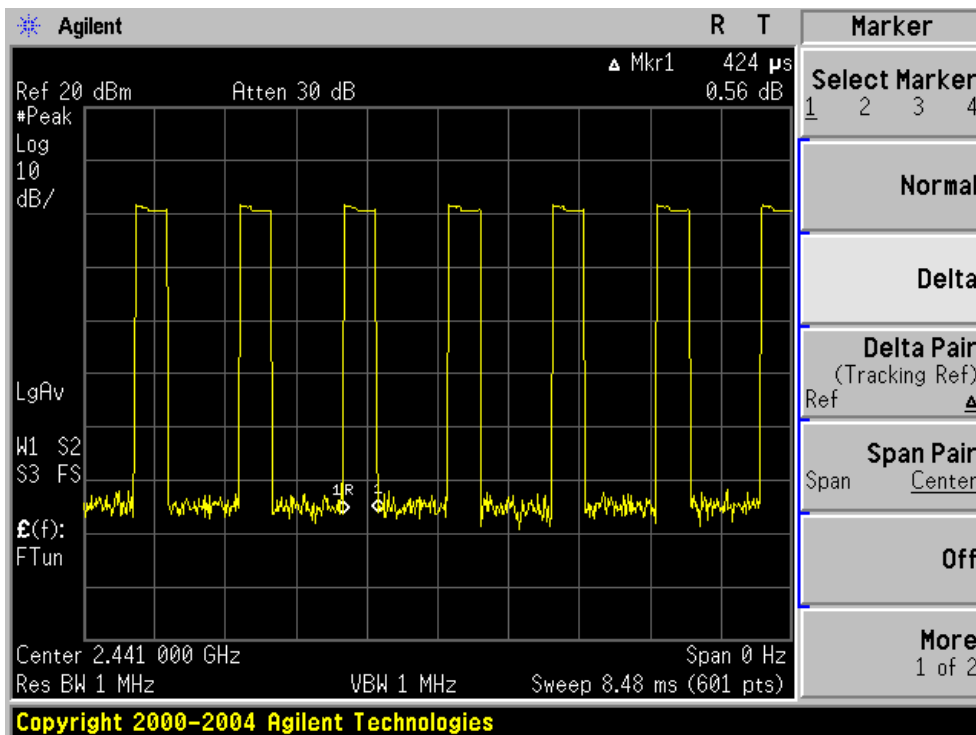

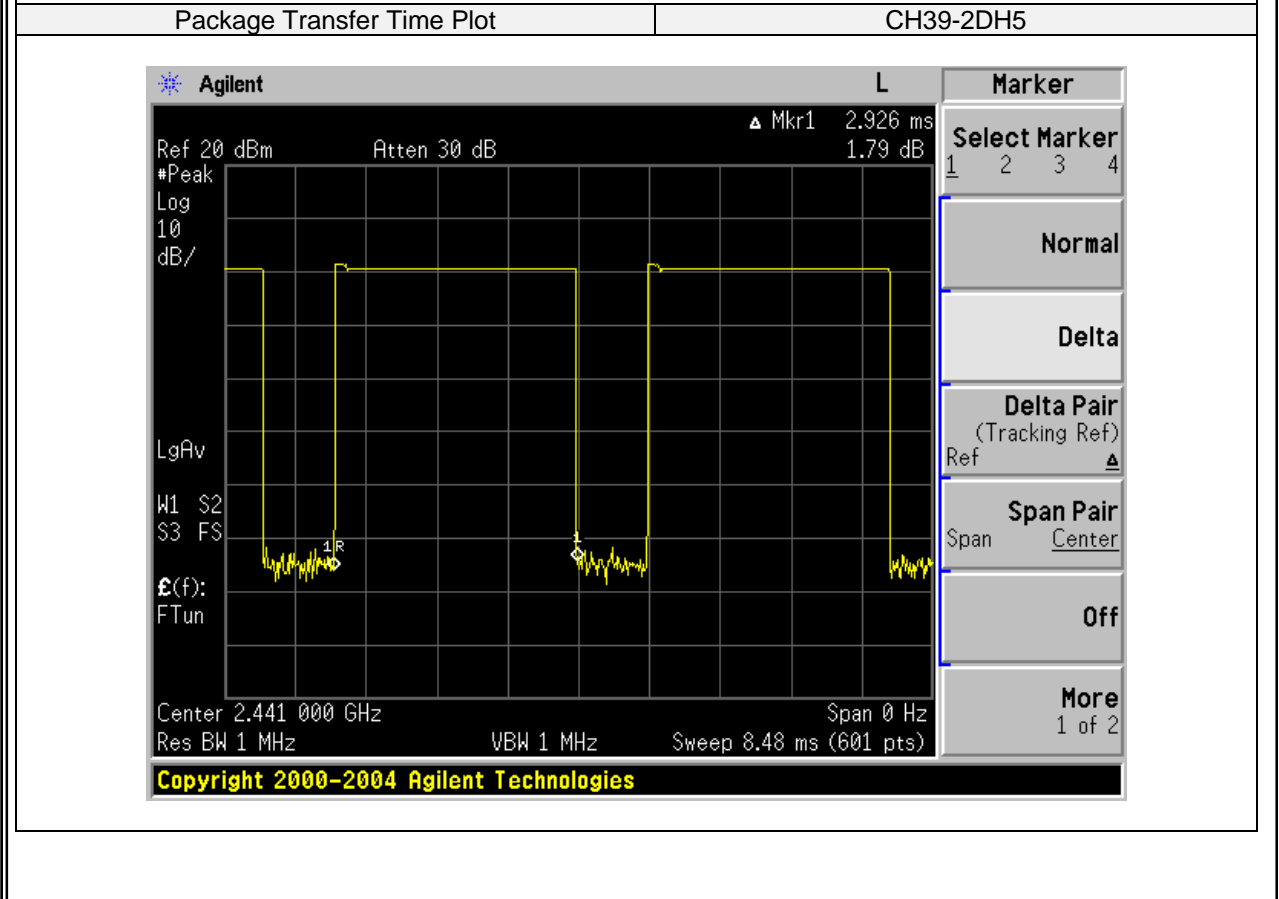
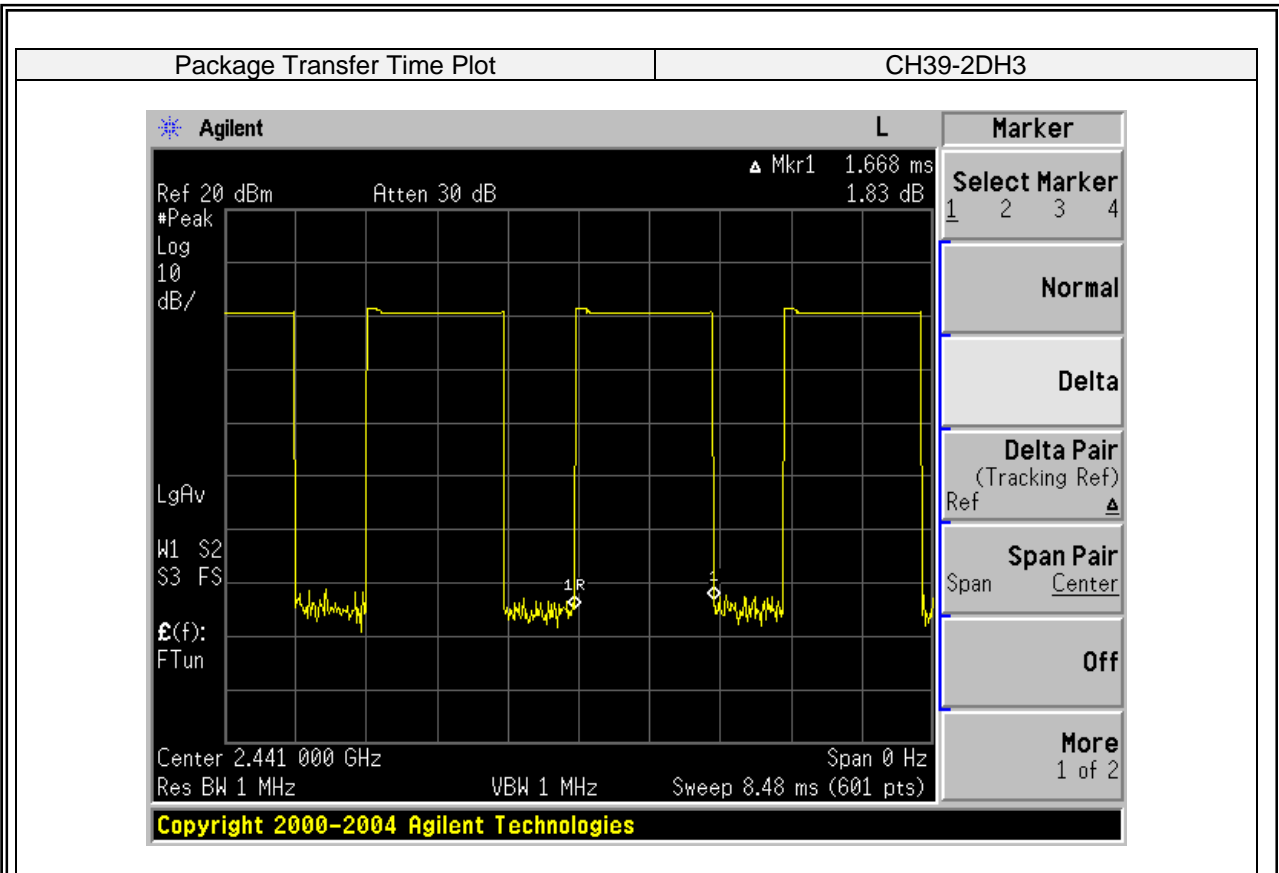

Package Transfer Time Plot CH39-3DH1

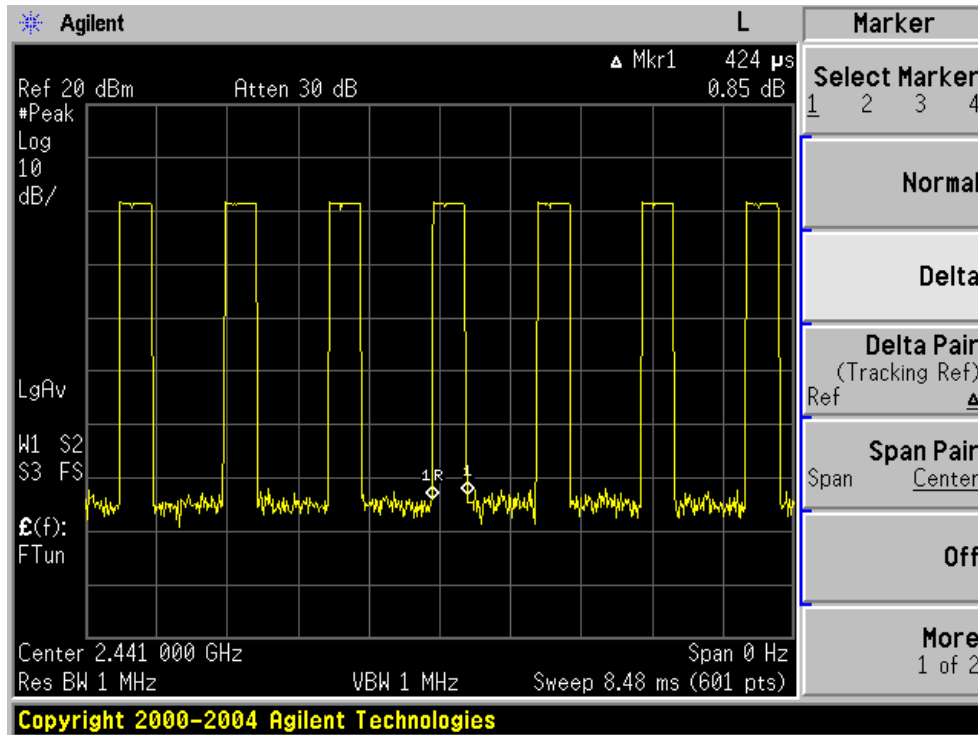

Package Transfer Time Plot CH39-3DH3

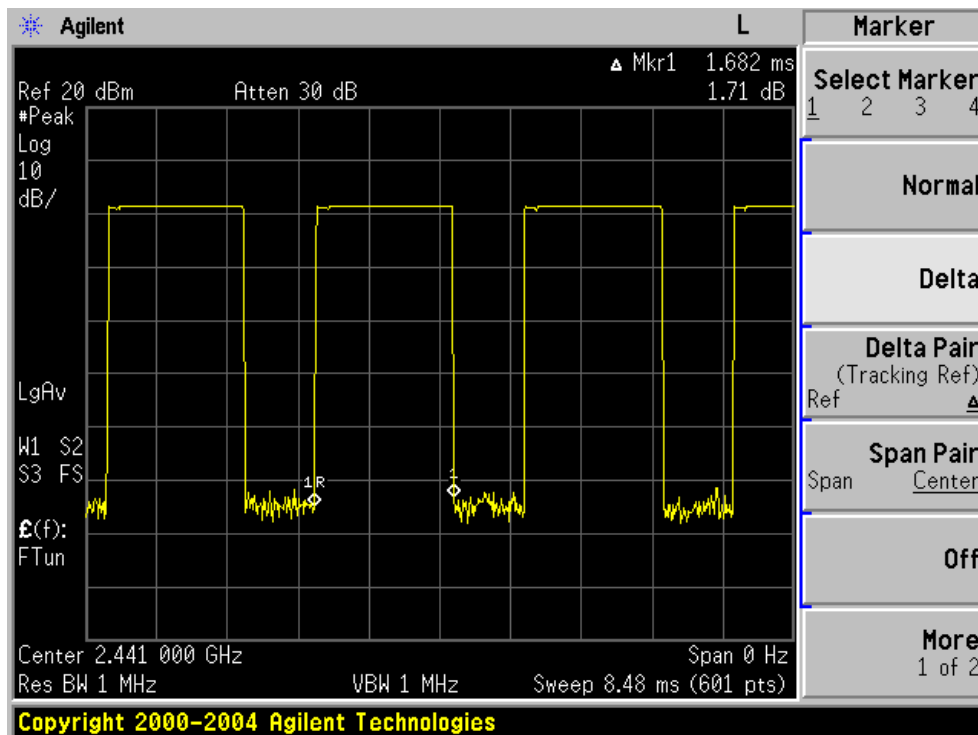

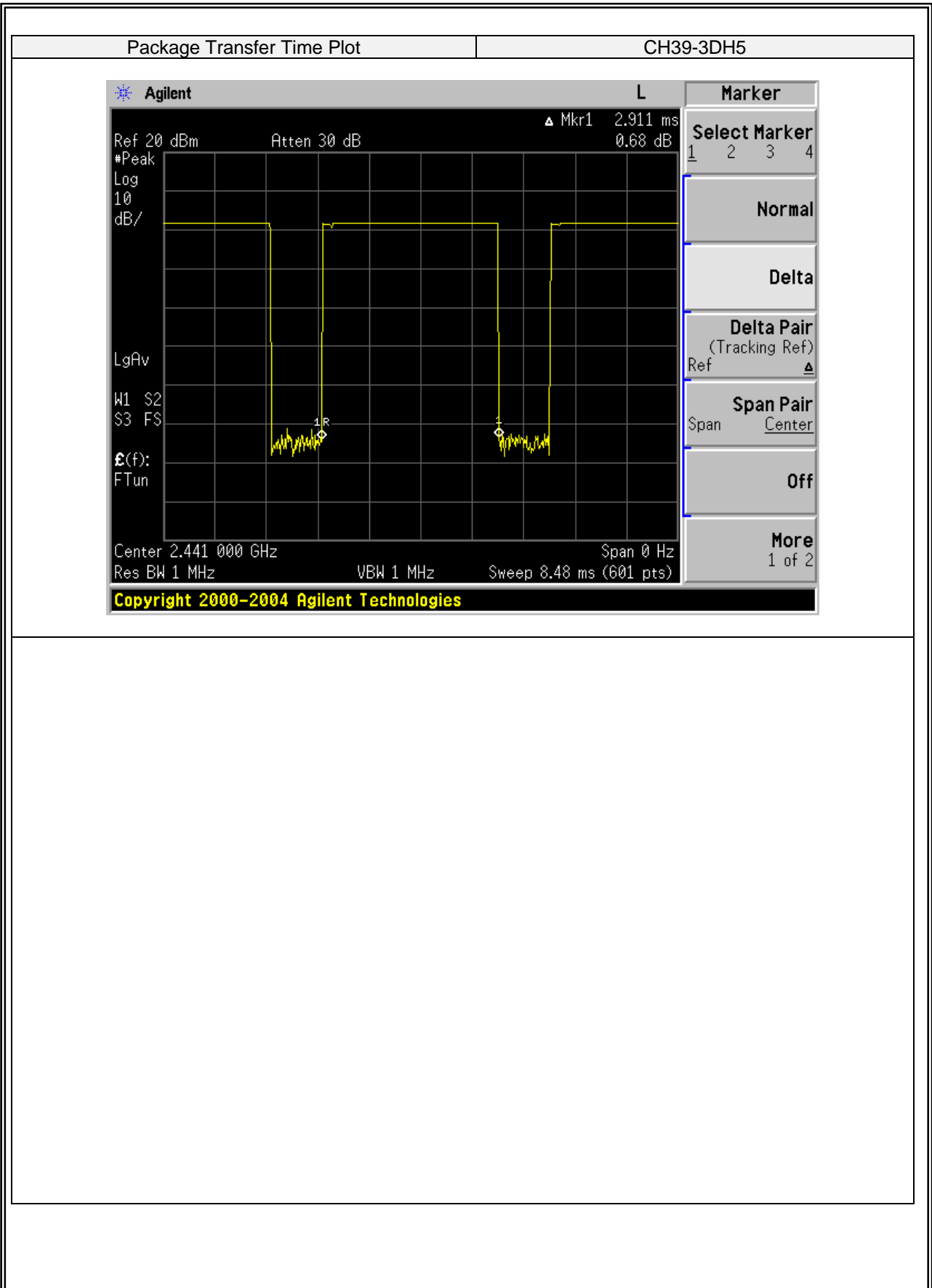

7.6 20DB BANDWIDTH TEST

7.6.1 Applicable Standard

According to FCC Part 15.247(a)(1) and DA 00-705

7.6.2 Conformance Limit

No limit requirement.

7.6.3 Measuring Instruments

The Measuring equipment is listed in the section 6.3 of this test report.

7.6.4 Test Setup

Please refer to Section 6.1 of this test report.

7.6.5 Test Procedure

The testing follows ANSI C63.10-2013 clause 6.9.2
 The RF output of EUT was connected to the spectrum analyzer by RF cable and attenuator.
 The path loss was compensated to the results for each measurement.
 Set to the maximum power setting and enable the EUT transmit continuously.
 The EUT was operating in controlled its channel.
 Use the following spectrum analyzer settings:
 Span = approximately 2 to 3 times the 20 dB bandwidth, centered on a hopping channel
 RBW ≥ 1% of the 20 dB bandwidth
 VBW ≥ RBW
 Sweep = auto
 Detector function = peak
 Trace = max hold

7.6.6 Test Results

EUT:	EcoBoulder	Model No.:	GDI-EXBM901
Temperature:	20 °C	Relative Humidity:	48%
Test Mode:	Mode2/Mode3/Mode4	Test By:	Susan Su

Test Channel	Frequency (MHz)	Measurement Bandwidth (KHz)	Limit (kHz)	Verdict
1Mbps				
00	2402	912.233	N/A	PASS
39	2441	875.199	N/A	PASS
78	2480	875.022	N/A	PASS
2Mbps				
00	2402	1222.000	N/A	PASS
39	2441	1225.000	N/A	PASS
78	2480	1221.000	N/A	PASS
3Mbps				
00	2402	1213.000	N/A	PASS
39	2441	1215.000	N/A	PASS
78	2480	1213.000	N/A	PASS

Note: N/A (Not Applicable)

20dB Bandwidth plot on channel 00 1Mbps

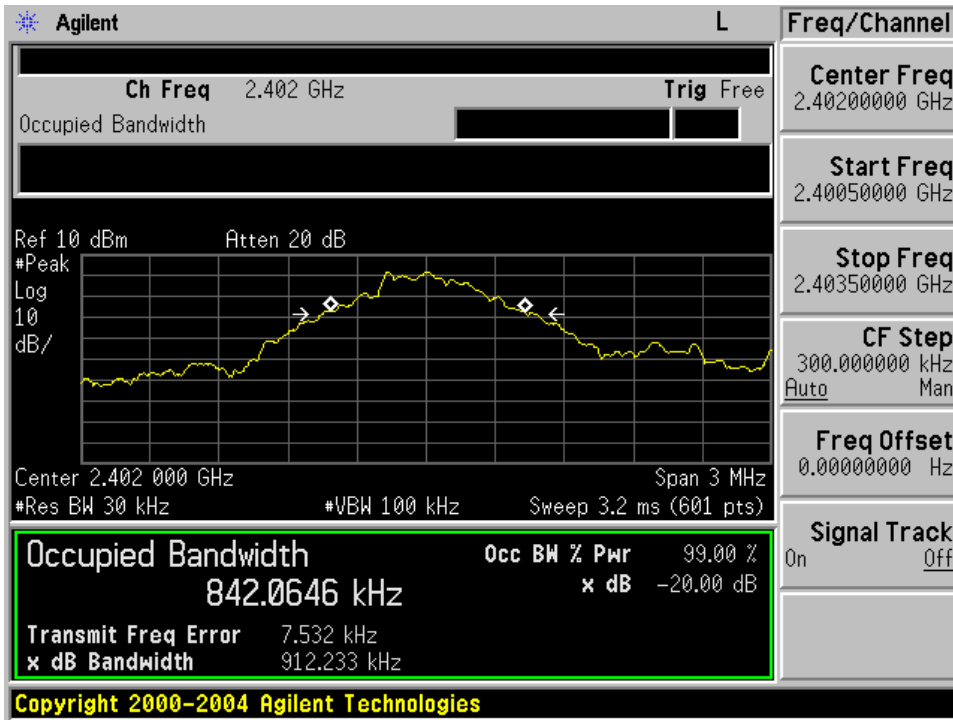

20dB Bandwidth plot on channel 39 1Mbps

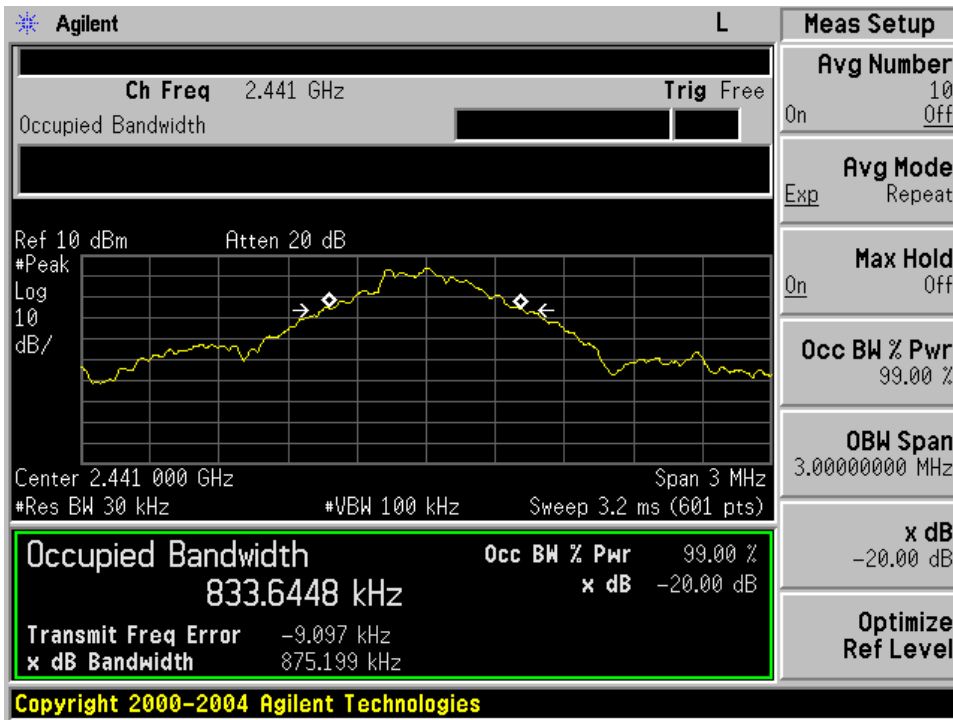

20dB Bandwidth plot on channel 78 1Mbps

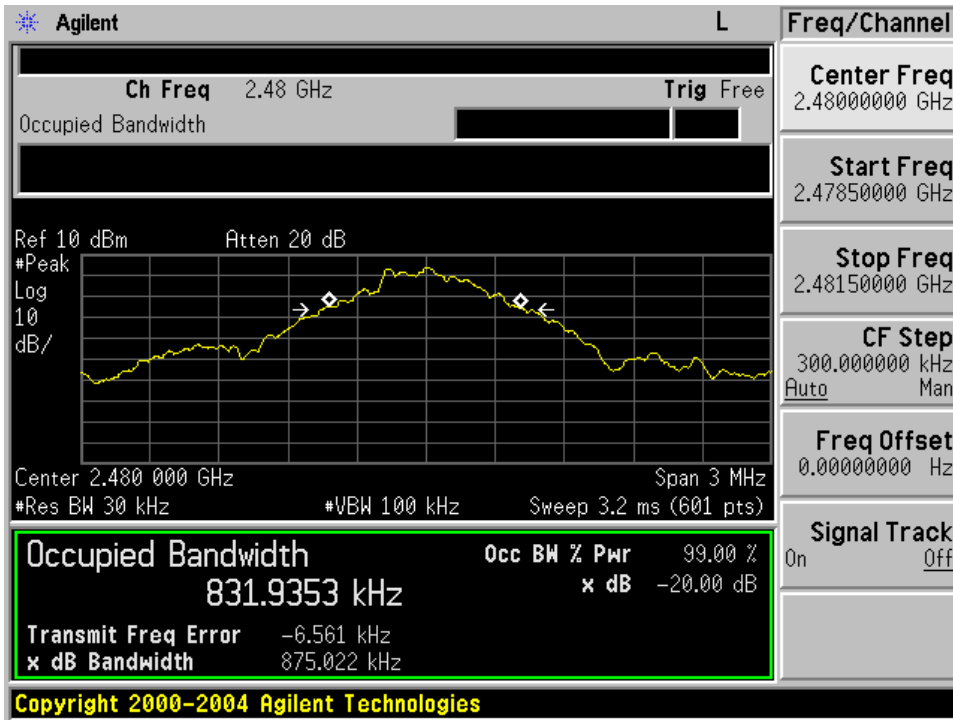

20dB Bandwidth plot on channel 00 2Mbps

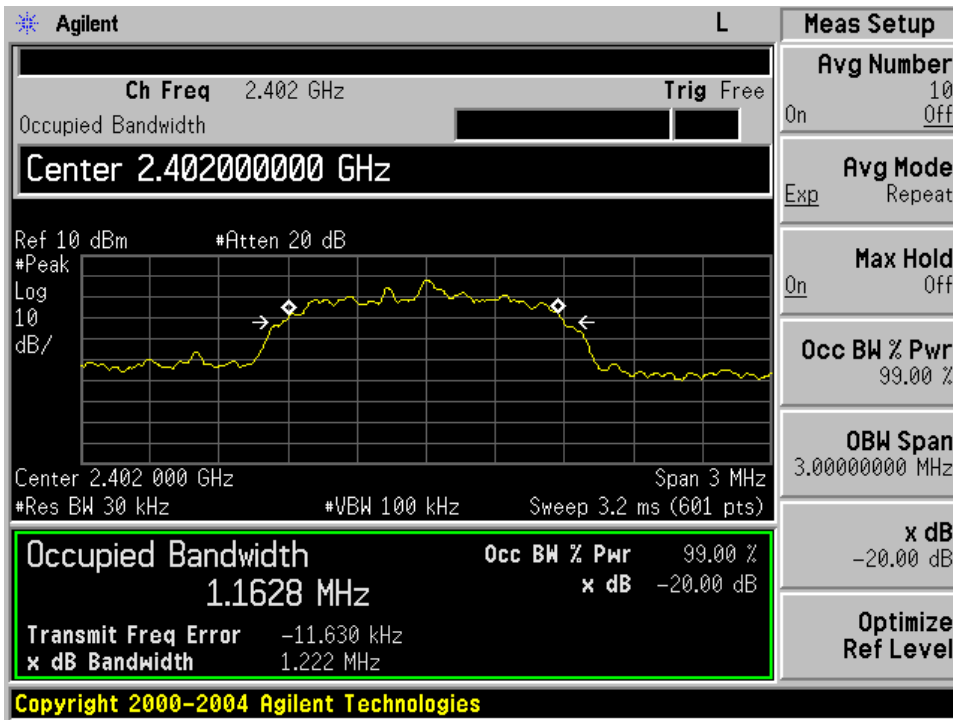

20dB Bandwidth plot on channel 39 2Mbps

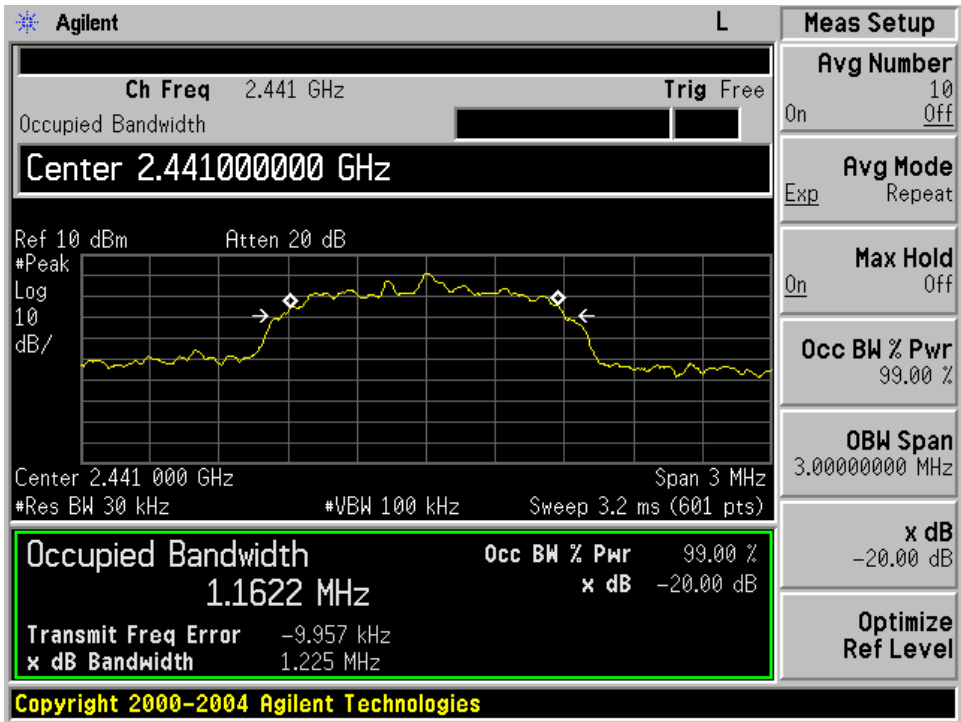

20dB Bandwidth plot on channel 78 2Mbps

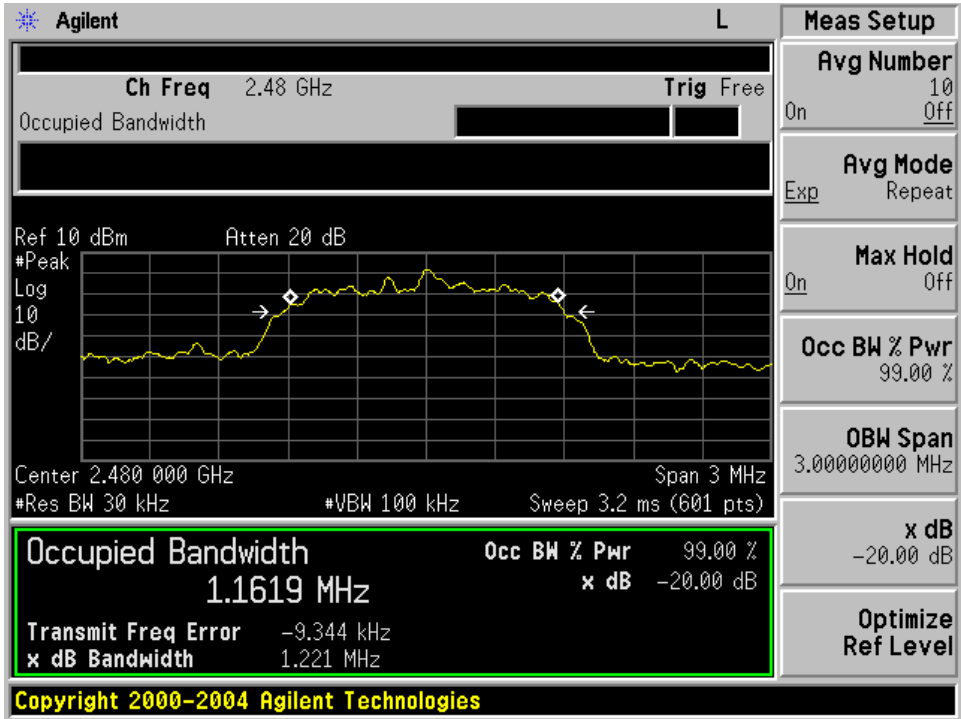

20dB Bandwidth plot on channel 00 3Mbps

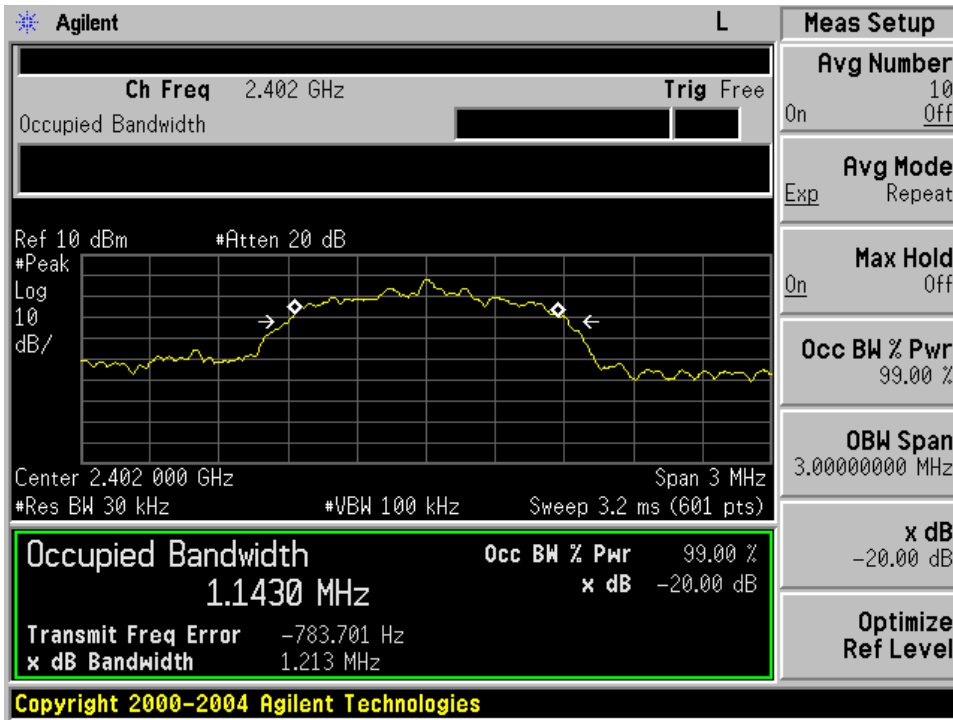

20dB Bandwidth plot on channel 39 3Mbps

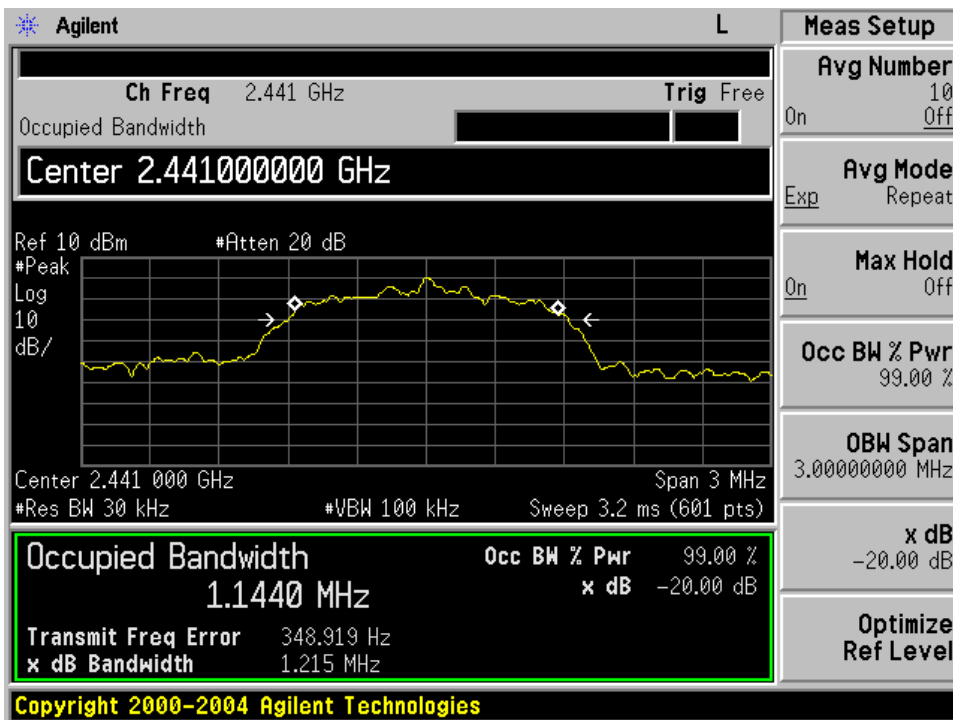

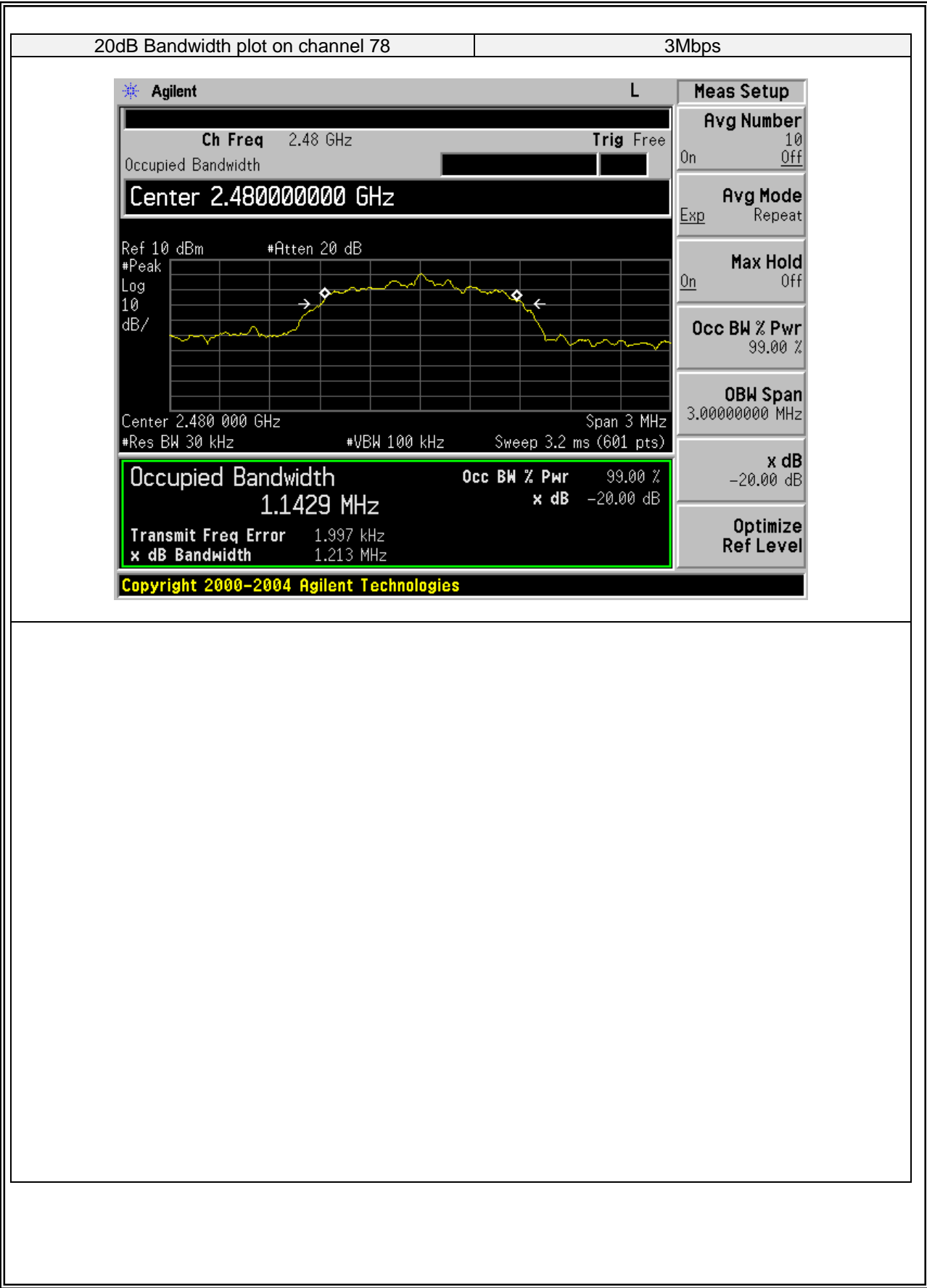

7.7 PEAK OUTPUT POWER

7.7.1 Applicable Standard

According to FCC Part 15.247(b)(1) and DA 00-705

7.7.2 Conformance Limit

The maximum peak conducted output power of the intentional radiator shall not exceed the following: (1) For frequency hopping systems operating in the 2400-2483.5 MHz band employing at least 75 non-overlapping hopping channels, and all frequency hopping systems in the 5725-5850 MHz band: 1 watt. For all other frequency hopping systems in the 2400-2483.5 MHz band 0.125 watts.

7.7.3 Measuring Instruments

The Measuring equipment is listed in the section 6.3 of this test report.

7.7.4 Test Setup

Please refer to Section 6.1 of this test report.

7.7.5 Test Procedure

The testing follows ANSI C63.10-2013 clause 7.8.5.
 The RF output of EUT was connected to the spectrum analyzer by RF cable and attenuator.
 The path loss was compensated to the results for each measurement.
 Set to the maximum power setting and enable the EUT transmit continuously.
 The EUT was operating in controlled its channel.
 Use the following spectrum analyzer settings:
 Span = approximately 5 times the 20 dB bandwidth, centered on a hopping channel
 RBW ≥ the 20 dB bandwidth of the emission being measured
 VBW ≥ RBW
 Sweep = auto
 Detector function = peak
 Trace = max hold

7.7.6 Test Results

EUT:	EcoBoulder	Model No.:	GDI-EXBM901
Temperature:	20 °C	Relative Humidity:	48%
Test Mode:	Mode2/Mode3/Mode4	Test By:	Susan Su

Test Channel	Frequency (MHz)	Power Setting	Peak Output Power (dBm)	LIMIT (dBm)	Verdict
1Mbps					
00	2402	Default	2.97	30	PASS
39	2441	Default	3.52	30	PASS
78	2480	Default	3.74	30	PASS
2Mbps					
00	2402	Default	2.20	20.97	PASS
39	2441	Default	3.68	20.97	PASS
78	2480	Default	3.86	20.97	PASS
3Mbps					
00	2402	Default	2.19	20.97	PASS
39	2441	Default	3.74	20.97	PASS
78	2480	Default	2.56	20.97	PASS

Peak output Power plot on channel 00 1Mbps

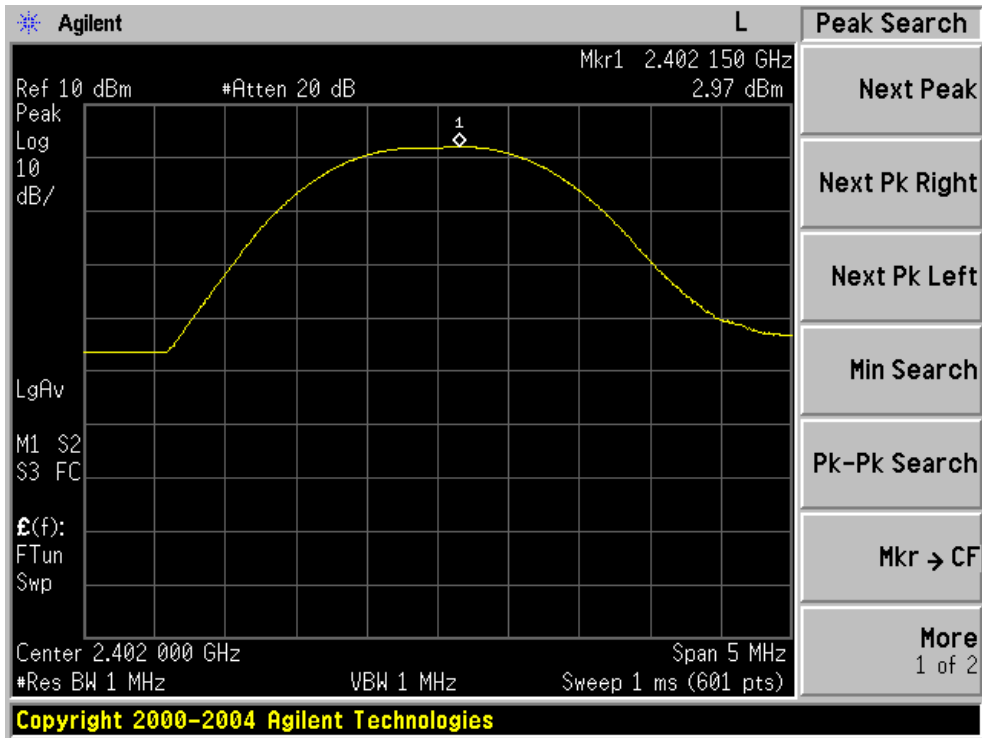

Peak output Power plot on channel 39 1Mbps

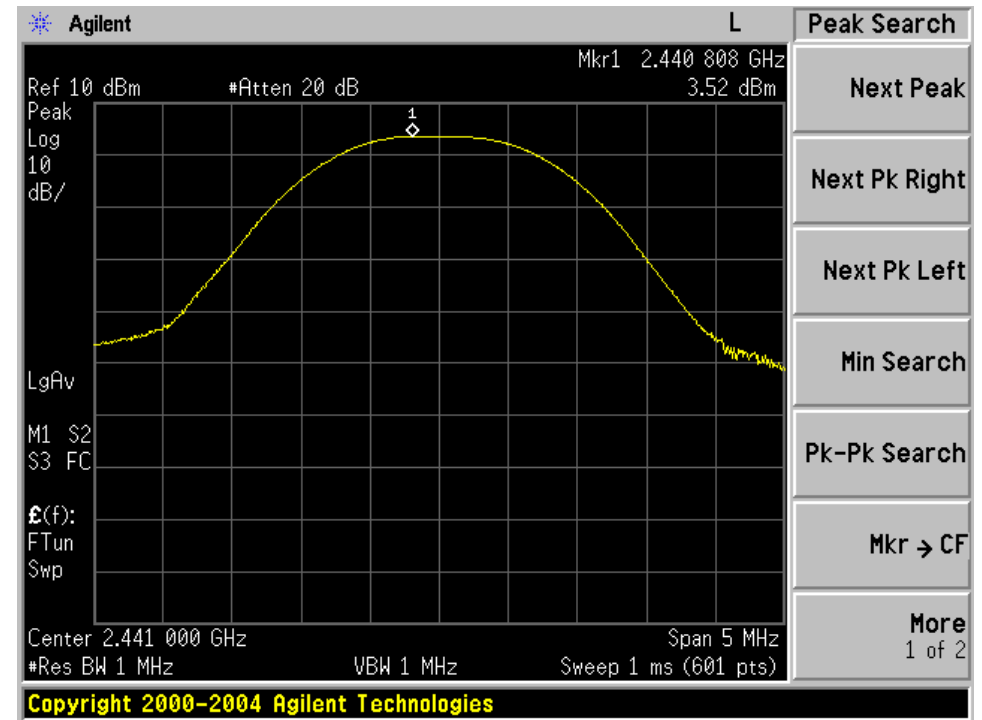

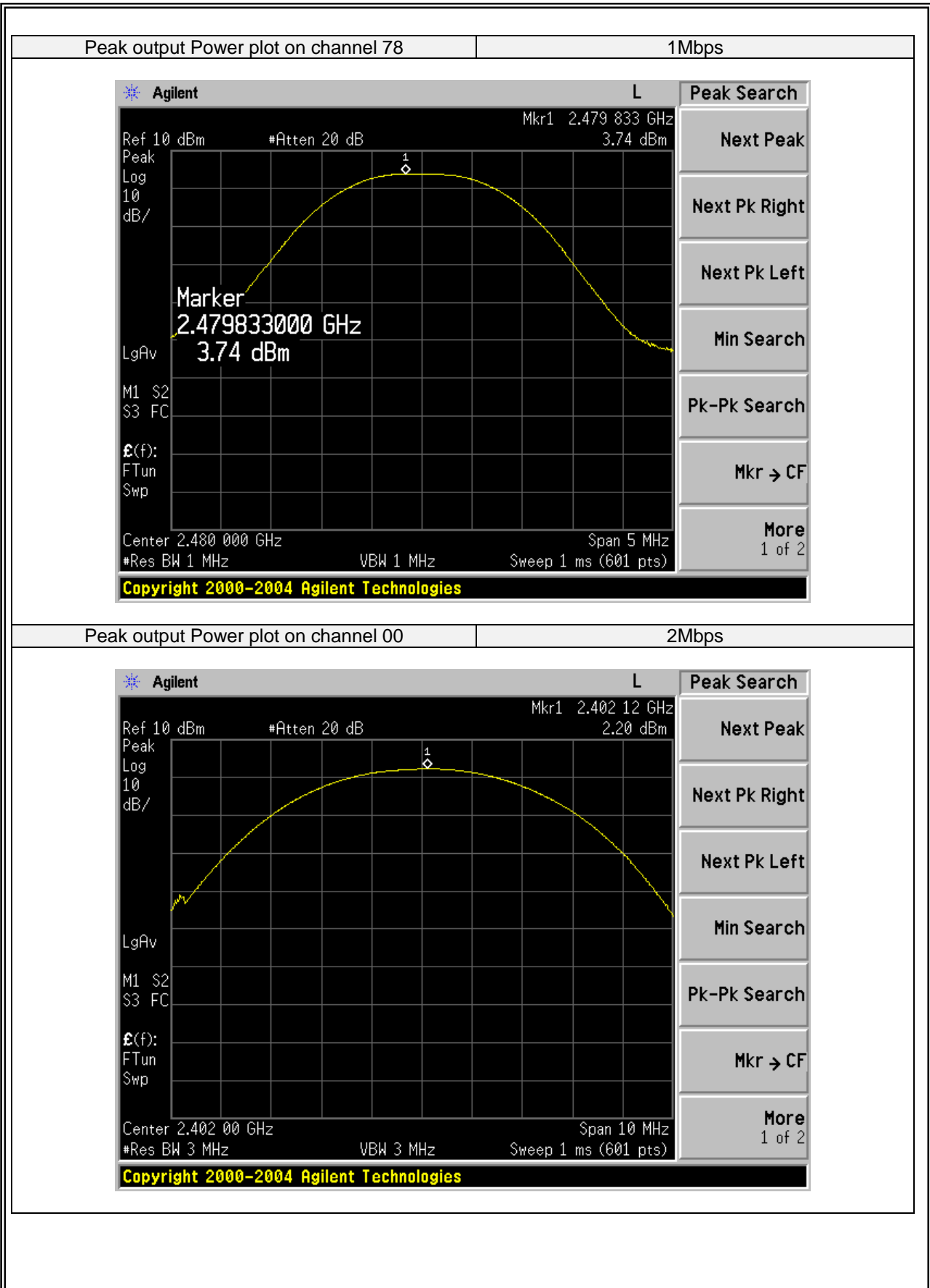

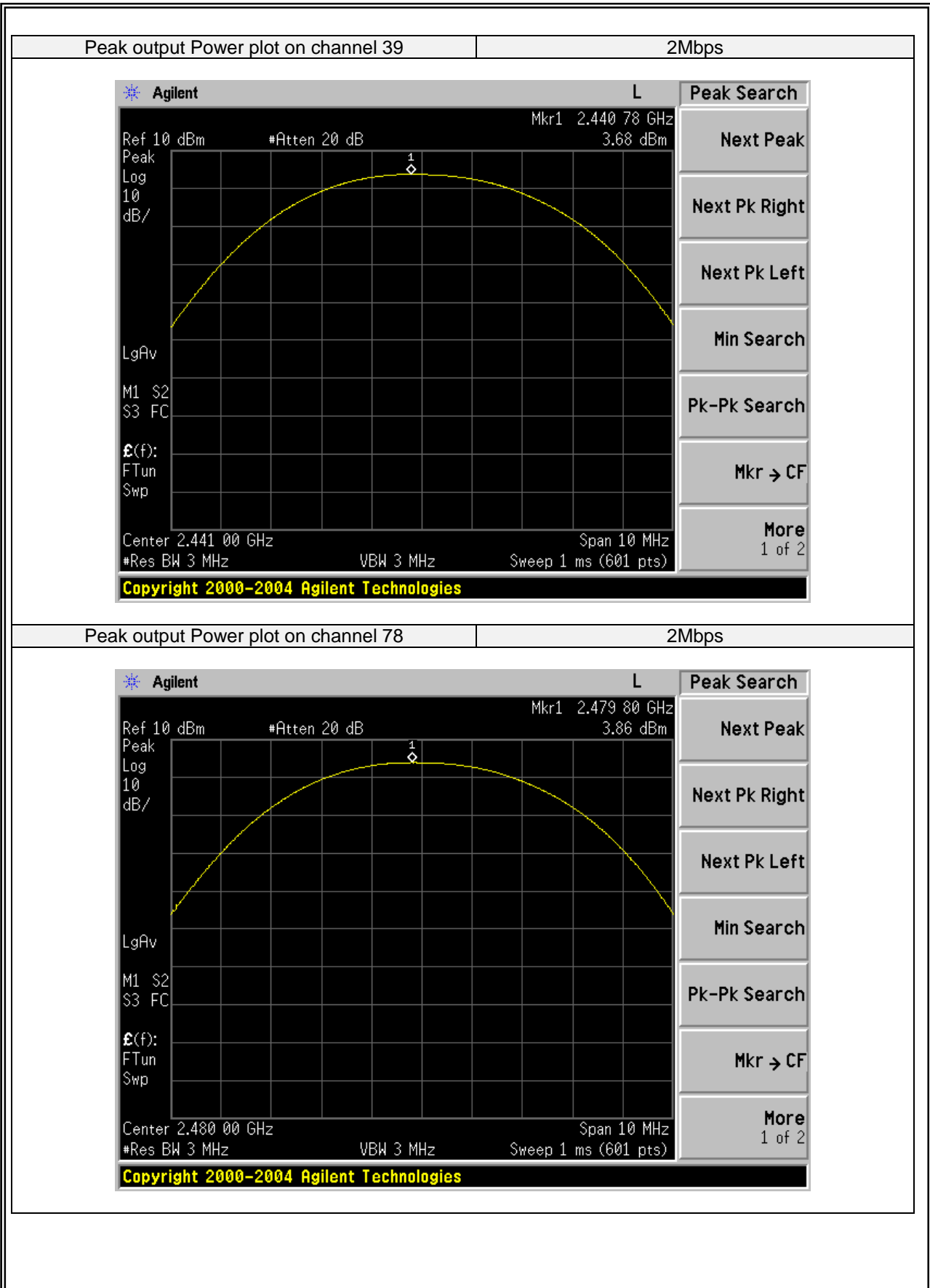

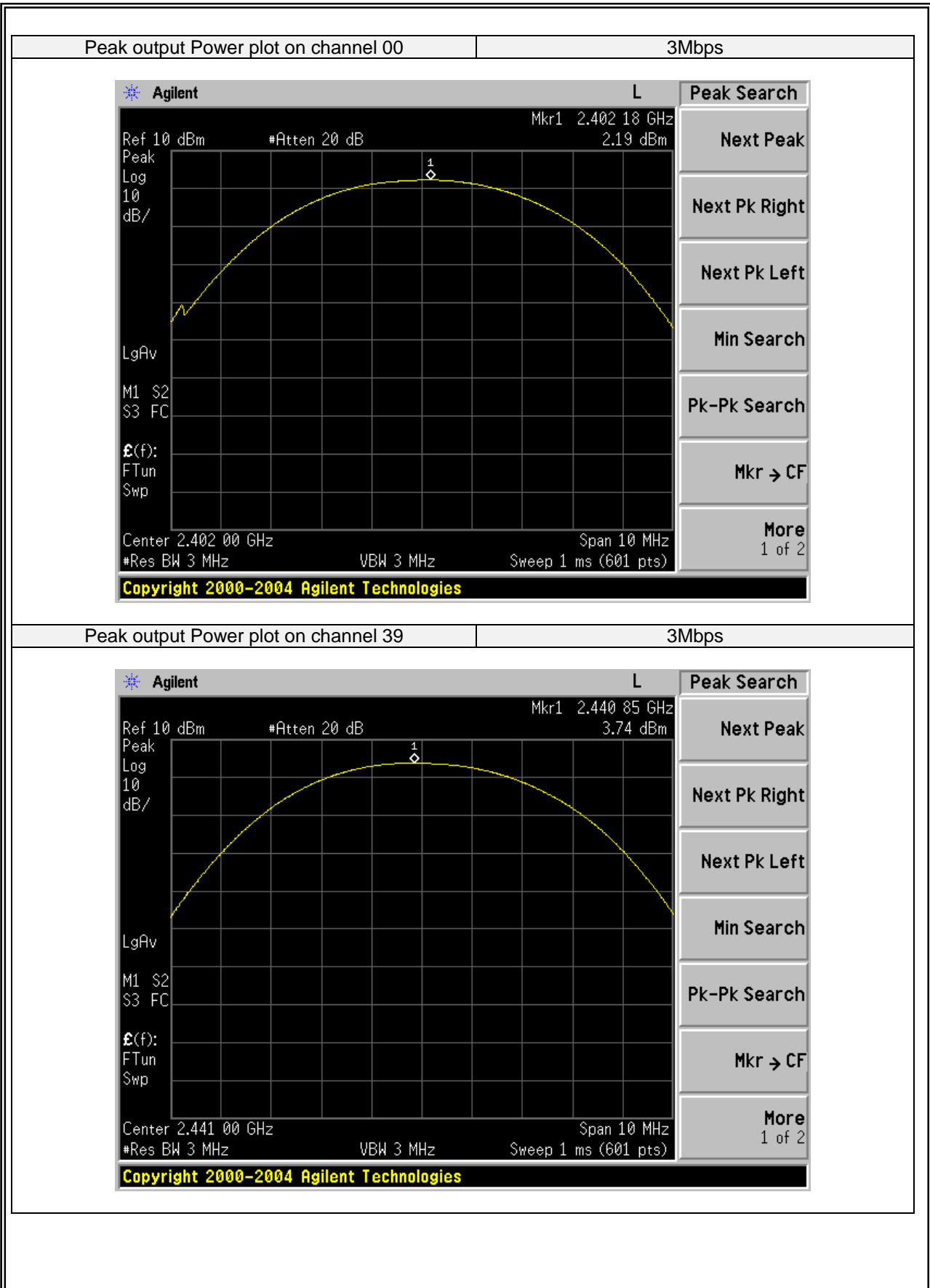

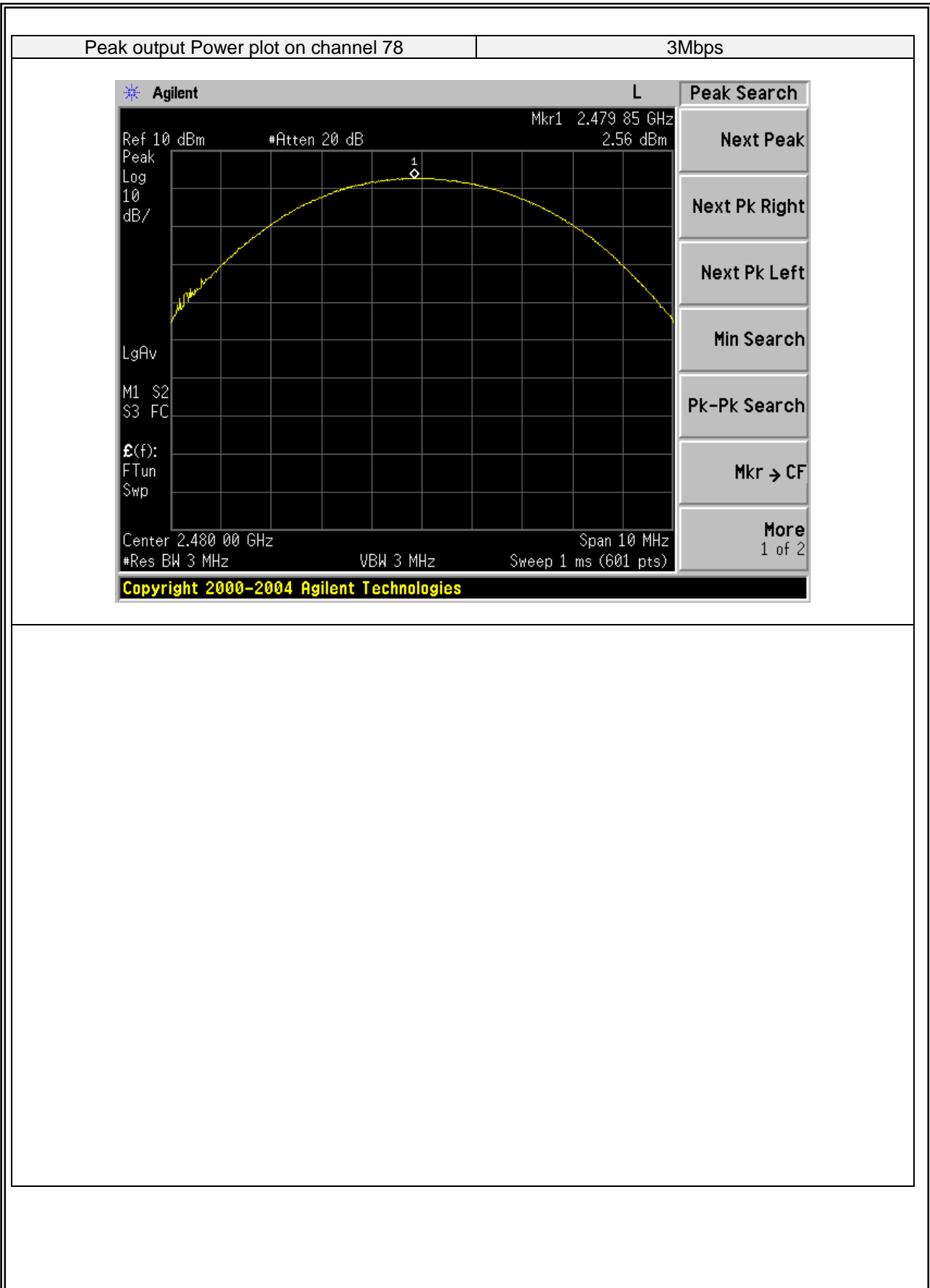

7.8 CONDUCTED BAND EDGE MEASUREMENT

7.8.1 Applicable Standard

According to FCC Part 15.247(d) and DA 00-705

7.8.2 Conformance Limit

In any 100 kHz bandwidth outside the frequency band in which the spread spectrum or digitally modulated intentional radiator is operating, the radio frequency power that is produced by the intentional radiator shall be at least 20 dB below that in the 100 kHz bandwidth within the band that contains the highest level of the desired power, based on either an RF conducted or a radiated measurement, provided the transmitter demonstrates compliance with the peak conducted power limits. If the transmitter complies with the conducted power limits based on the use of RMS averaging over a time interval, as permitted under paragraph (b)(3) of this section, the attenuation required under this paragraph shall be 30 dB instead of 20 dB. Attenuation below the general limits specified in §15.209(a) is not required. In addition, radiated emissions which fall in the restricted bands, as defined in §15.205(a), must also comply with the radiated emission limits specified in §15.209(a) (see §15.205(c)).

7.8.3 Measuring Instruments

The Measuring equipment is listed in the section 6.3 of this test report.

7.8.4 Test Setup

Please refer to Section 6.1 of this test report.

7.8.5 Test Procedure

The testing follows ANSI C63.10-2013 clause 7.8.6.

The RF output of EUT was connected to the spectrum analyzer by RF cable and attenuator.

The path loss was compensated to the results for each measurement.

Set to the maximum power setting and enable the EUT transmit continuously.

The EUT must have its hopping function enabled.

Use the following spectrum analyzer settings:

Span = approximately 5 times the 20 dB bandwidth, centered on a hopping channel

RBW = 100KHz

VBW = 300KHz

Band edge emissions must be at least 20 dB down from the highest emission level within the authorized band as measured with a 100kHz RBW. The attenuation shall be 30 dB instead of 20 dB when RMS conducted output power procedure is used.

Measure the highest amplitude appearing on spectral display and set it as a reference level. Plot the graph with marking the highest point and edge frequency.

Repeat above procedures until all measured frequencies were complete.



7.8.6 Test Results

EUT:	EcoBoulder	Model No.:	GDI-EXBM901
Temperature:	20 °C	Relative Humidity:	48%
Test Mode:	Mode2/Mode4	Test By:	Susan Su

Note: Hopping enabled and disabled have evaluated,and the worstest data was reported

BDR mode (GFSK): Band Edge-Low Channel

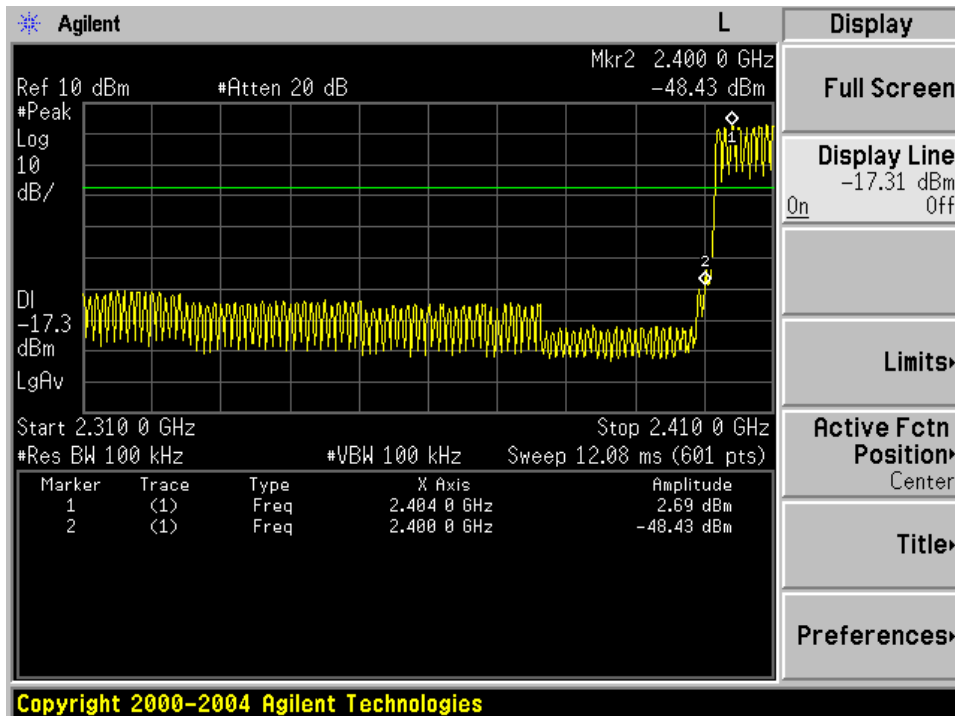
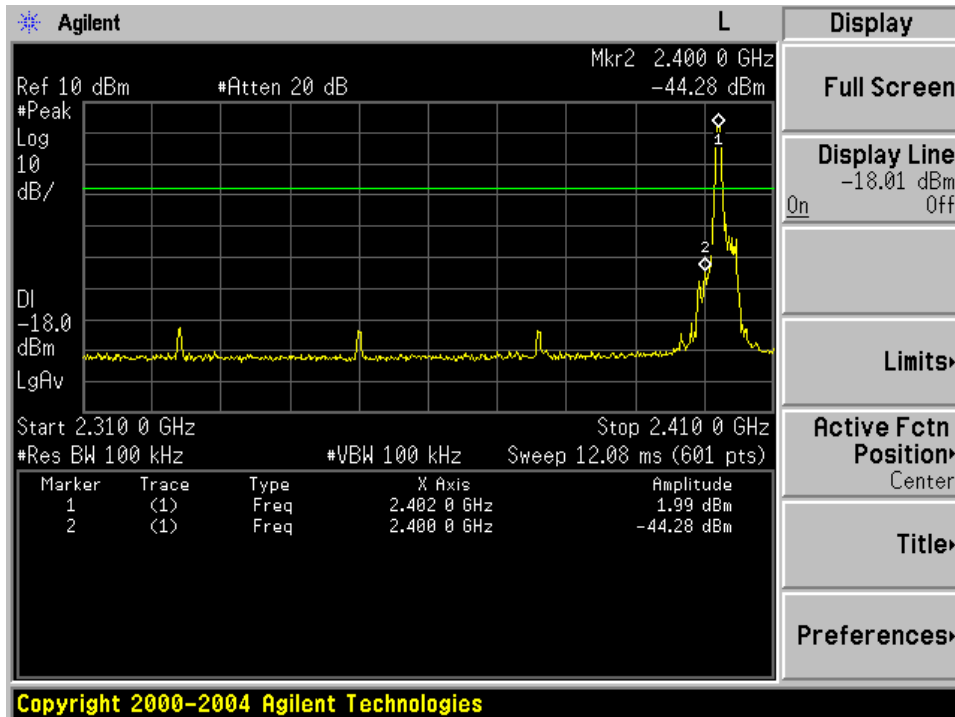

BDR mode (GFSK): Band Edge-High Channel

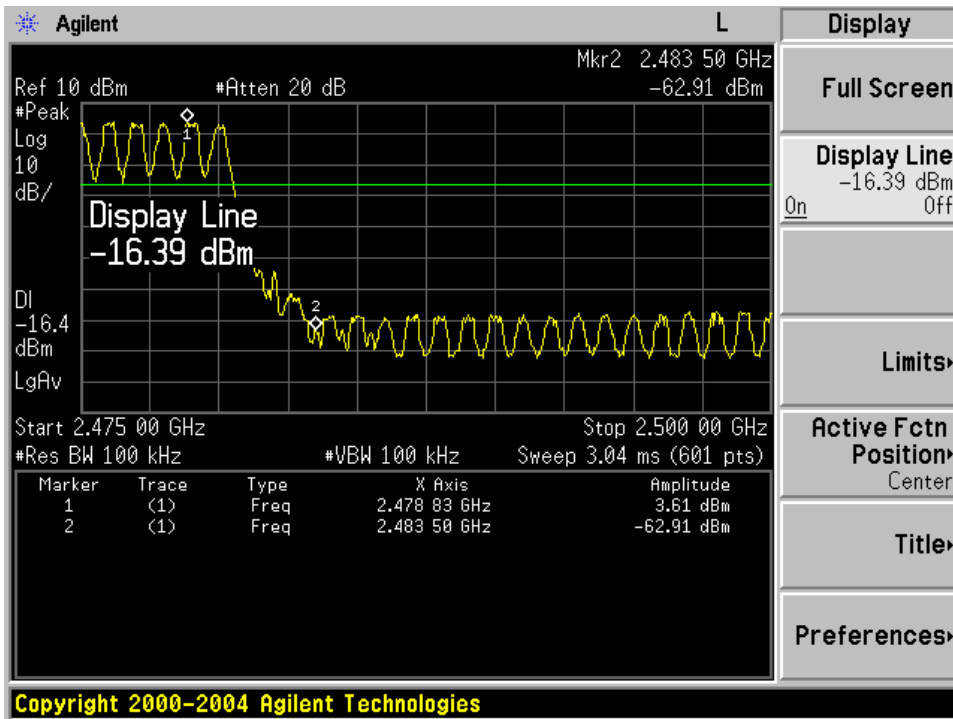
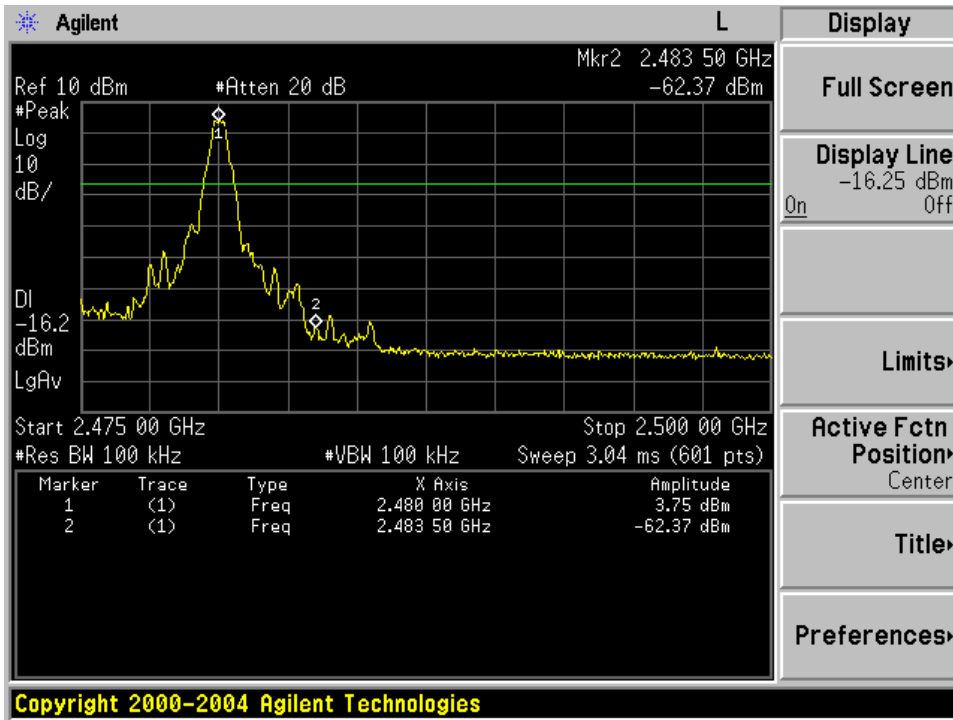

EDR mode ($\pi/4$ -DQPSK): Band Edge-Low Channel

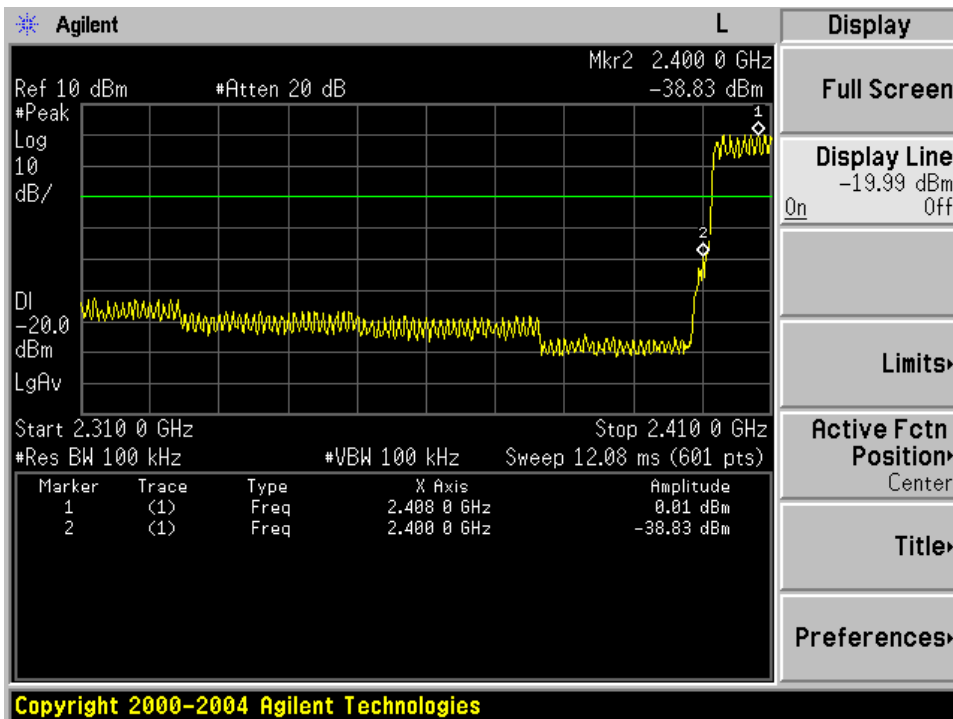
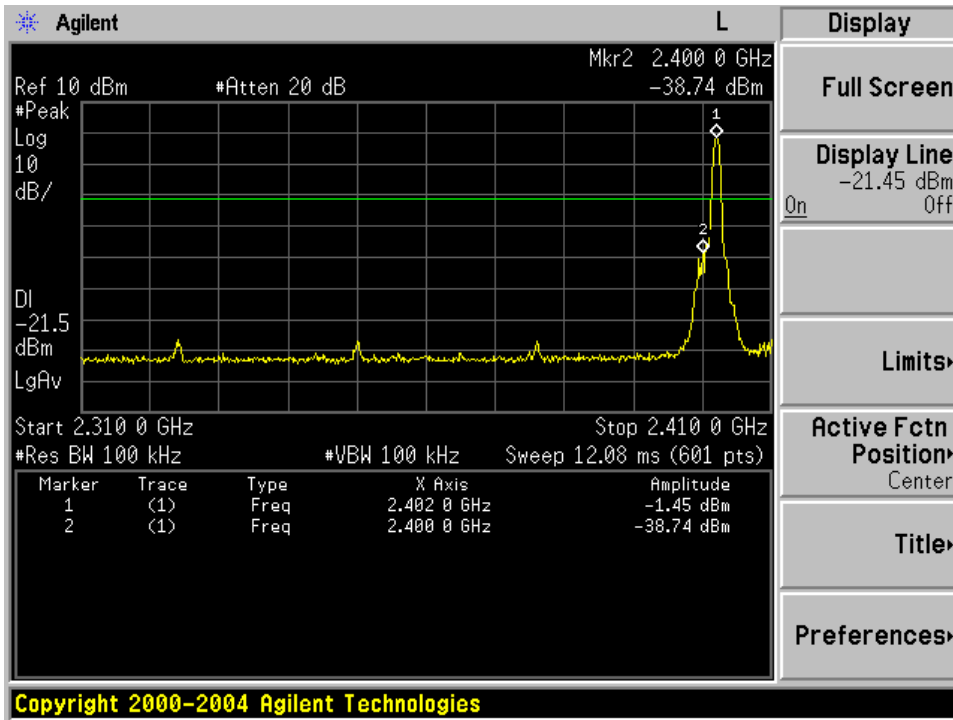

EDR mode ($\pi/4$ -DQPSK): Band Edge- High Channel

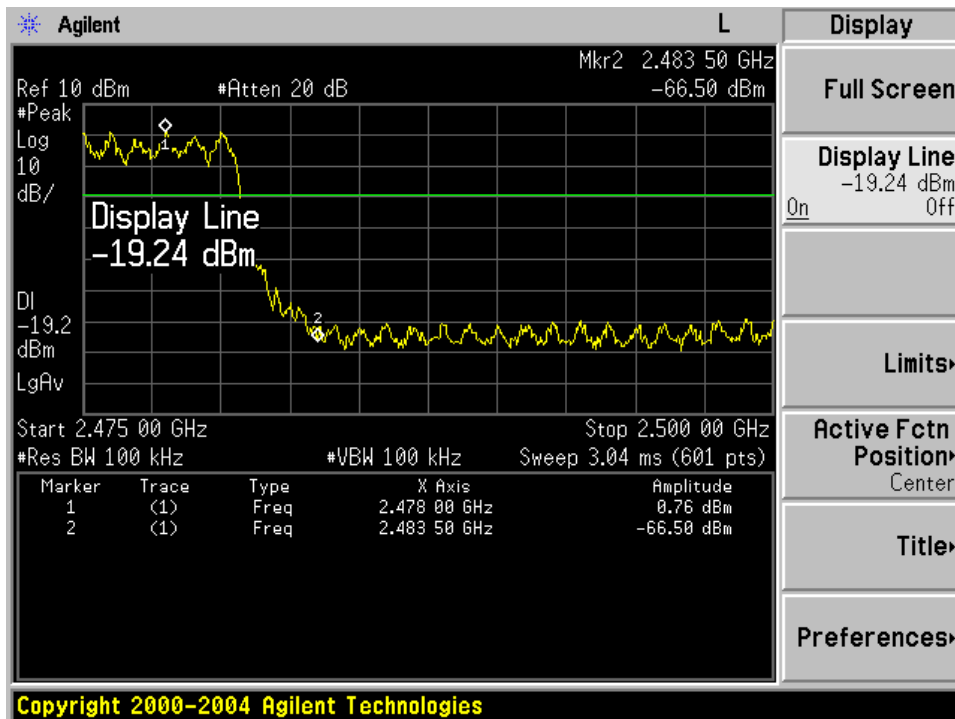
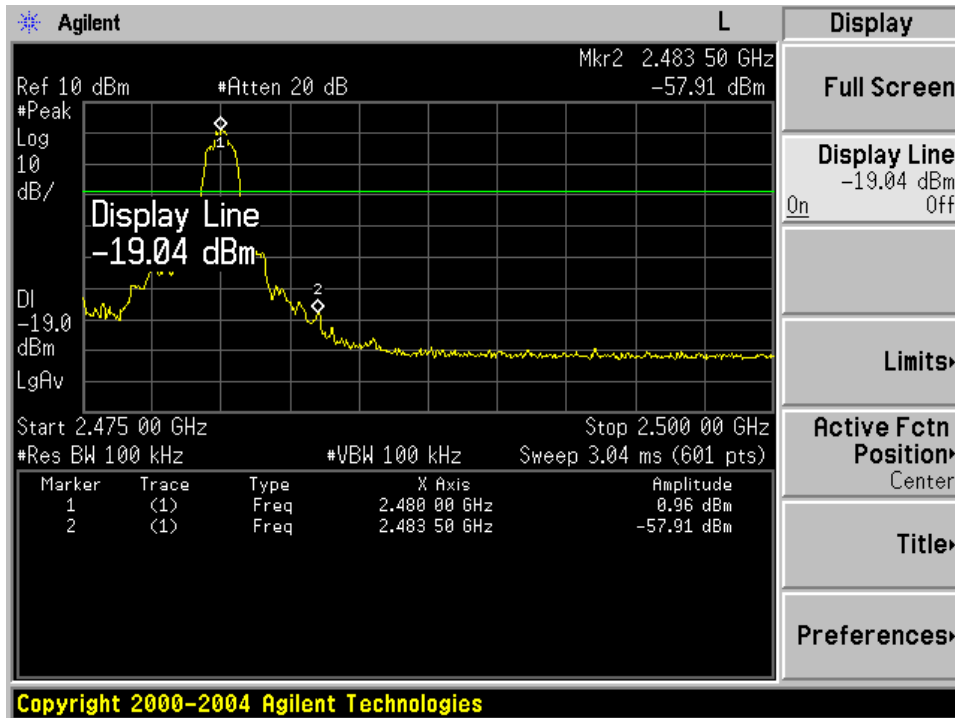

EDR mode (8DPSK): Band Edge-Low Channel

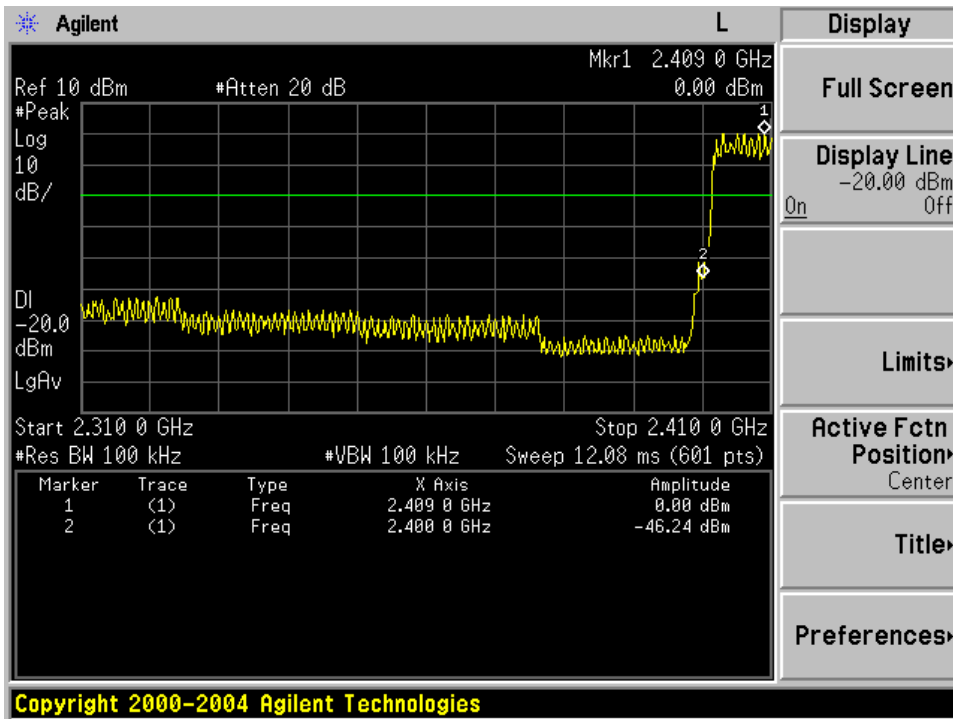
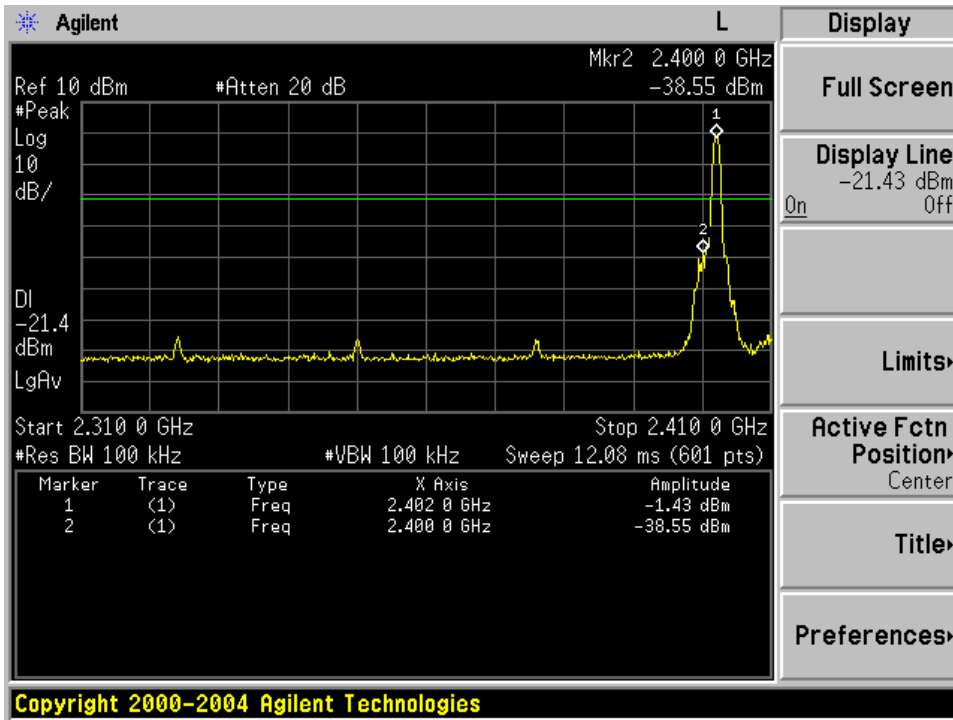

EDR mode (8DPSK): Band Edge- High Channel

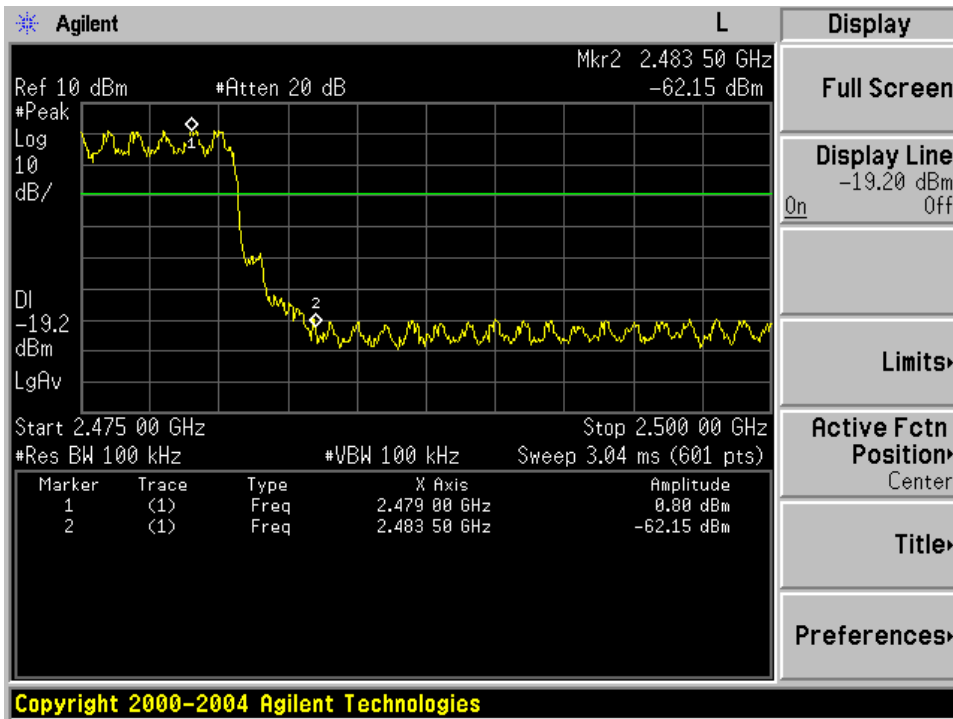
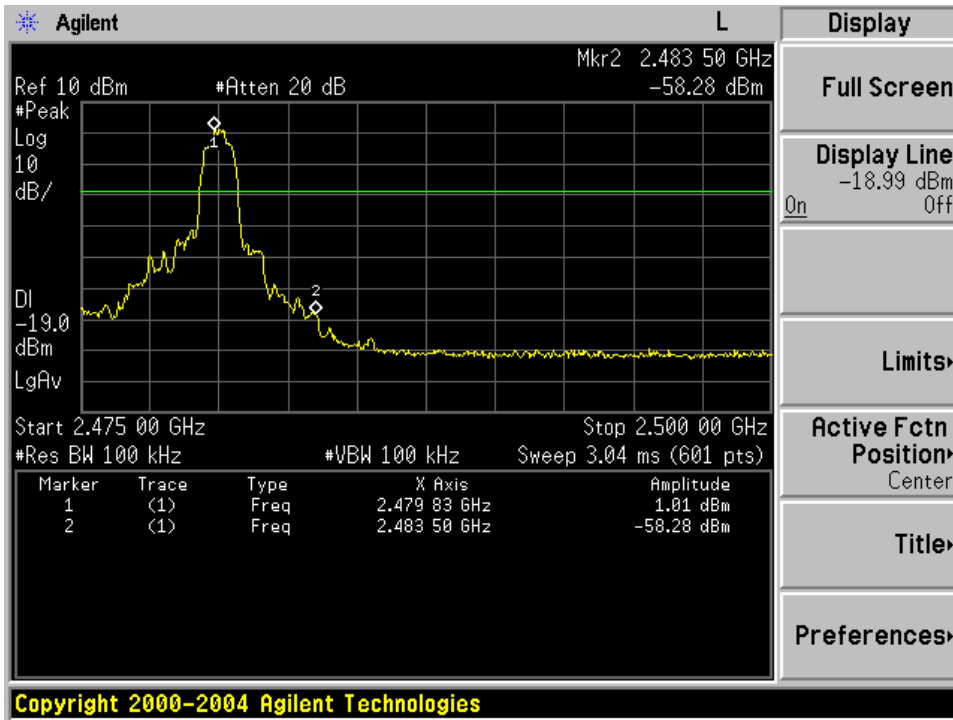

7.9 ANTENNA APPLICATION

7.9.1 Antenna Requirement

15.203 requirement: For intentional device, according to 15.203: an intentional radiator shall be designed to ensure that no antenna other than that furnished by the responsible party shall be used with the device.

7.9.2 Result

The EUT antenna is permanent attached antenna. It comply with the standard requirement.

END OF REPORT