

RADIO TEST REPORT

FCC ID:2AAUI-EXSEB26

Product: SoundExtreme SEB26

Trade Mark: ECOXGEAR

Model No.: GDI-EXSEB2601

Family Model: N/A

Report No.: S23060201614001

Issue Date: Jul 21. 2023

Prepared for

Grace Digital Inc.

10531 4S Commons Drive #166 Suite #430, San Diego, CA 92127

Prepared by

Shenzhen NTEK Testing Technology Co., Ltd.

1&5/F, Building C, 1&2/F, Building E, Fenda Science Park, Sanwei
Community, Hangcheng Street, Baoan District,
Shenzhen, Guangdong, China

Tel. 400-800-6106, 0755-2320 0050, 0755-2320 0090

Website: <http://www.ntek.org.cn>

TABLE OF CONTENTS

| | | |
|----------|--|-----------|
| 1 | TEST RESULT CERTIFICATION | 3 |
| 2 | SUMMARY OF TEST RESULTS..... | 4 |
| 3 | FACILITIES AND ACCREDITATIONS | 5 |
| 3.1 | FACILITIES..... | 5 |
| 3.2 | LABORATORY ACCREDITATIONS AND LISTINGS | 5 |
| 3.3 | MEASUREMENT UNCERTAINTY | 5 |
| 4 | GENERAL DESCRIPTION OF EUT | 6 |
| 5 | DESCRIPTION OF TEST MODES | 8 |
| 6 | SETUP OF EQUIPMENT UNDER TEST | 9 |
| 6.1 | BLOCK DIAGRAM CONFIGURATION OF TEST SYSTEM..... | 9 |
| 6.2 | SUPPORT EQUIPMENT..... | 10 |
| 6.3 | EQUIPMENTS LIST FOR ALL TEST ITEMS..... | 11 |
| 7 | TEST REQUIREMENTS | 12 |
| 7.1 | CONDUCTED EMISSIONS TEST | 12 |
| 7.2 | RADIATED SPURIOUS EMISSION | 14 |
| 7.3 | NUMBER OF HOPPING CHANNEL..... | 23 |
| 7.4 | HOPPING CHANNEL SEPARATION MEASUREMENT | 24 |
| 7.5 | AVERAGE TIME OF OCCUPANCY (DWELL TIME) | 25 |
| 7.6 | 20DB BANDWIDTH TEST | 27 |
| 7.7 | PEAK OUTPUT POWER..... | 28 |
| 7.8 | CONDUCTED BAND EDGE MEASUREMENT..... | 29 |
| 7.9 | SPURIOUS RF CONDUCTED EMISSION..... | 30 |
| 7.10 | ANTENNA APPLICATION | 31 |
| 7.11 | FREQUENCY HOPPING SYSTEM (FHSS) EQUIPMENT REQUIREMENTS | 32 |
| 8 | TEST RESULTS..... | 33 |
| 8.1 | DWELL TIME..... | 33 |
| 8.2 | MAXIMUM CONDUCTED OUTPUT POWER | 43 |
| 8.3 | -20DB BANDWIDTH | 49 |
| 8.4 | OCCUPIED CHANNEL BANDWIDTH..... | 55 |
| 8.5 | CARRIER FREQUENCIES SEPARATION | 61 |
| 8.6 | NUMBER OF HOPPING CHANNEL..... | 67 |
| 8.7 | BAND EDGE | 70 |
| 8.8 | BAND EDGE(HOPPING) | 77 |
| 8.9 | CONDUCTED RF SPURIOUS EMISSION..... | 84 |

1 TEST RESULT CERTIFICATION

| | |
|-----------------------------------|--|
| Applicant's name | Grace Digital Inc. |
| Address..... | 10531 4S Commons Drive #166 Suite #430, San Diego, CA 92127 |
| Manufacturer's Name | Xingtel Xiamen Group Co., Ltd. |
| Address..... | Xingtel Building, Chuangxin Road, Torch Hi-Tech Industrial District, Xiamen 361006, PR China |
| Product description | |
| Product name | SoundExtreme SEB26 |
| Model and/or type reference | GDI-EXSEB2601 |
| Family Model | N/A |
| Sample number | S230602016014 |

Measurement Procedure Used:

| APPLICABLE STANDARDS | |
|---|-------------|
| STANDARD/ TEST PROCEDURE | TEST RESULT |
| FCC 47 CFR Part 2, Subpart J FCC 47 CFR Part 15, Subpart C ANSI C63.10-2013 | Complied |

This device described above has been tested by Shenzhen NTEK Testing Technology Co., Ltd., and the test results show that the equipment under test (EUT) is in compliance with the FCC requirements. And it is applicable only to the tested sample identified in the report.

This report shall not be reproduced except in full, without the written approval of Shenzhen NTEK Testing Technology Co., Ltd., this document may be altered or revised by Shenzhen NTEK Testing Technology Co., Ltd., personnel only, and shall be noted in the revision of the document.

The test results of this report relate only to the tested sample identified in this report.

Date of Test : Jun 05. 2023 ~ Jul 21. 2023

Testing Engineer : 
(Allen Liu)

Authorized Signatory : 
(Alex Li)

2 SUMMARY OF TEST RESULTS

FCC Part15 (15.247), Subpart C

| Standard Section | Test Item | Verdict | Remark |
|--------------------------|--------------------------------|---------|--------|
| 15.207 | Conducted Emission | N/A | |
| 15.209 (a) 15.205 (a) | Radiated Spurious Emission | PASS | |
| 15.247(a)(1) | Hopping Channel Separation | PASS | |
| 15.247(b)(1) | Peak Output Power | PASS | |
| 15.247(a)(iii) | Number of Hopping Frequency | PASS | |
| 15.247(a)(iii) | Dwell Time | PASS | |
| 15.247(a)(1) | Bandwidth | PASS | |
| 15.247 (d) | Band Edge Emission | PASS | |
| 15.247 (d) | Spurious RF Conducted Emission | PASS | |
| 15.203 | Antenna Requirement | PASS | |

Remark:

1. "N/A" denotes test is not applicable in this Test Report.
2. All test items were verified and recorded according to the standards and without any deviation during the test.

3 FACILITIES AND ACCREDITATIONS

3.1 FACILITIES

All measurement facilities used to collect the measurement data are located at 1&5/F, Building C, 1&2/F, Building E, Fenda Science Park, Sanwei Community, Hangcheng Street, Baoan District, Shenzhen, Guangdong, China.

The sites are constructed in conformance with the requirements of ANSI C63.7, ANSI C63.10 and CISPR Publication 22.

3.2 LABORATORY ACCREDITATIONS AND LISTINGS

Site Description

CNAS-Lab. : The Certificate Registration Number is L5516.

IC-Registration : The Certificate Registration Number is 9270A.
CAB identifier:CN0074

FCC- Accredited : Test Firm Registration Number: 463705.

Designation Number: CN1184

A2LA-Lab. : The Certificate Registration Number is 4298.01

This laboratory is accredited in accordance with the recognized International Standard ISO/IEC 17025:2005 General requirements for the competence of testing and calibration laboratories.

This accreditation demonstrates technical competence for a defined scope and the operation of a laboratory quality management system (refer to joint ISO-ILAC-IAF Communiqué dated 8 January 2009).

Name of Firm : Shenzhen NTEK Testing Technology Co., Ltd.

Site Location : 1/F, Building E, Fenda Science Park, Sanwei Community, Xixiang Street, Bao'an District, Shenzhen 518126 P.R. China.

3.3 MEASUREMENT UNCERTAINTY

The reported uncertainty of measurement $y \pm U$, where expanded uncertainty U is based on a standard uncertainty multiplied by a coverage factor of $k=2$, providing a level of confidence of approximately 95 %.

| No. | Item | Uncertainty |
|-----|-------------------------------------|-------------------------|
| 1 | Conducted Emission Test | $\pm 2.80\text{dB}$ |
| 2 | RF power, conducted | $\pm 0.16\text{dB}$ |
| 3 | Spurious emissions, conducted | $\pm 0.21\text{dB}$ |
| 4 | All emissions, radiated(30MHz~1GHz) | $\pm 2.64\text{dB}$ |
| 5 | All emissions, radiated(1GHz~6GHz) | $\pm 2.40\text{dB}$ |
| 6 | All emissions, radiated(>6GHz) | $\pm 2.52\text{dB}$ |
| 7 | Temperature | $\pm 0.5^\circ\text{C}$ |
| 8 | Humidity | $\pm 2\%$ |
| 9 | All emissions, radiated(9KHz~30MHz) | $\pm 6\text{dB}$ |

4 GENERAL DESCRIPTION OF EUT

| Product Feature and Specification | |
|-----------------------------------|--|
| Equipment | SoundExtreme SEB26 |
| Trade Mark | ECOXGEAR |
| FCC ID | 2AAUI-EXSEB26 |
| Model No. | GDI-EXSEB2601 |
| Family Model | N/A |
| Model Difference | N/A |
| Operating Frequency | 2402MHz~2480MHz |
| Modulation | GFSK, $\pi/4$ -DQPSK, 8-DPSK |
| Number of Channels | 79 Channels |
| Antenna Type | PCB Antenna |
| Antenna Gain | 0 dBi |
| Power supply | DC 10.8V from battery |
| Adapter | MODEL: P24C120200 US INPUT: 100-240V~50/60Hz 0.6A OUTPUT: 12.0V---2.0A 24.0W |
| Battery | 13400mAh 10.8V 144.72Wh |
| HW Version | BT-333C-M-V1.3 |
| SW Version | BTM321_xinglian_BT333_V1218 |

Note 1: Based on the application, features, or specification exhibited in User's Manual, the EUT is considered as an ITE/Computing Device. More details of EUT technical specification, please refer to the User's Manual.

Note 2: The engineering test program was provided and the EUT was programmed to be in continuously transmitting mode.

5 DESCRIPTION OF TEST MODES

To investigate the maximum EMI emission characteristics generated from EUT, the test system was pre-scanning tested based on the consideration of following EUT operation mode or test configuration mode which possibly have effect on EMI emission level. Each of these EUT operation mode(s) or test configuration mode(s) mentioned above was evaluated respectively.

The Transmitter was operated in the normal operating mode. The TX frequency was fixed which was for the purpose of the measurements.

Test of channel included the lowest and middle and highest frequency to perform the test, then record on this report.

Those data rates (1Mbps for GFSK modulation; 2Mbps for $\pi/4$ -DQPSK modulation; 3Mbps for 8-DPSK modulation) were used for all test.

The EUT was pretested with 3 orientations placed on the table for the radiated emission measurement –X, Y, and Z-plane. The X-plane results were found as the worst case and were shown in this report.

Carrier Frequency and Channel list:

| Channel | Frequency(MHz) |
|---------|----------------|
| 0 | 2402 |
| 1 | 2403 |
| ... | ... |
| 39 | 2441 |
| 40 | 2442 |
| ... | ... |
| 77 | 2479 |
| 78 | 2480 |

Note: $f_c=2402\text{MHz}+k \times 1\text{MHz}$ $k=0$ to 78

The following summary table is showing all test modes to demonstrate in compliance with the standard.

| For Radiated Test Cases | |
|-------------------------|------------------|
| Final Test Mode | Description |
| Mode 1 | normal link mode |
| Mode 2 | CH00(2402MHz) |
| Mode 3 | CH39(2441MHz) |
| Mode 4 | CH78(2480MHz) |

Note: For radiated test cases, the worst mode data rate 3Mbps was reported only, because this data rate has the highest RF output power at preliminary tests, and no other significant frequencies found in conducted spurious emission.

| For Conducted Test Cases | |
|--------------------------|---------------|
| Final Test Mode | Description |
| Mode 2 | CH00(2402MHz) |
| Mode 3 | CH39(2441MHz) |
| Mode 4 | CH78(2480MHz) |
| Mode 5 | Hopping mode |

Note: The engineering test program was provided and the EUT was programmed to be in continuously transmitting mode.

6 SETUP OF EQUIPMENT UNDER TEST

6.1 BLOCK DIAGRAM CONFIGURATION OF TEST SYSTEM

For Radiated Test Cases

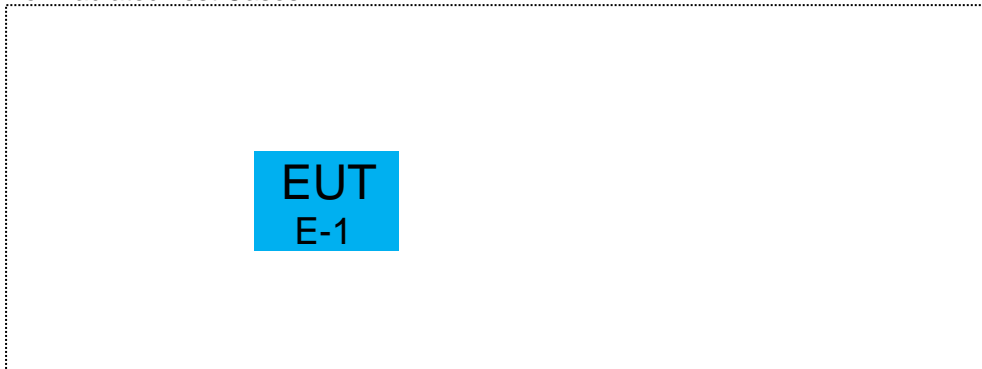

For Conducted Test Cases

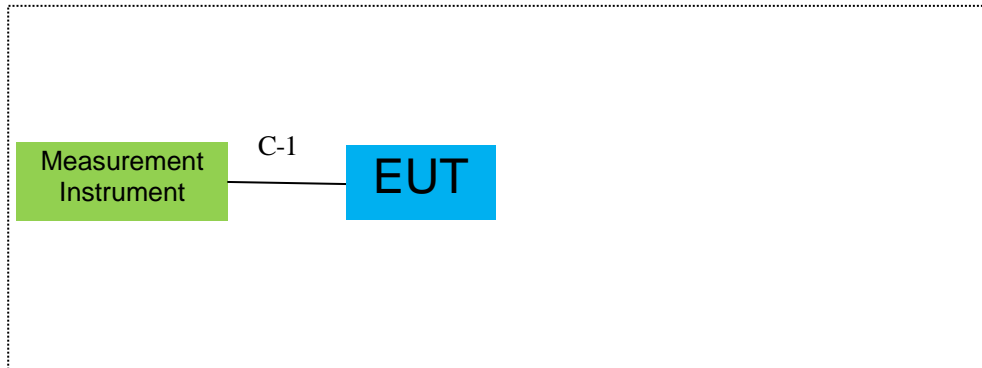

- Note: 1. The temporary antenna connector is soldered on the PCB board in order to perform conducted tests and this temporary antenna connector is listed in the equipment list.
2. EUT built-in battery-powered, the battery is fully-charged.

6.2 SUPPORT EQUIPMENT

The EUT has been tested as an independent unit together with other necessary accessories or support units. The following support units or accessories were used to form a representative test configuration during the tests.

| Item | Equipment | Model/Type No. | Series No. | Note |
|------|--------------------|----------------|------------|------|
| E-1 | SoundExtreme SEB26 | GDI-EXSEB2601 | N/A | EUT |
| | | | | |
| | | | | |
| | | | | |

| Item | Cable Type | Shielded Type | Ferrite Core | Length |
|------|------------|---------------|--------------|--------|
| C-1 | RF Cable | YES | NO | 0.1m |
| | | | | |
| | | | | |
| | | | | |
| | | | | |

Notes:

- (1) The support equipment was authorized by Declaration of Confirmation.
- (2) For detachable type I/O cable should be specified the length in cm in [Length] column.
- (3) "YES" is means "shielded" "with core"; "NO" is means "unshielded" "without core".

6.3 EQUIPMENTS LIST FOR ALL TEST ITEMS

Radiation& Conducted Test equipment

| Item | Kind of Equipment | Manufacturer | Type No. | Serial No. | Last calibration | Calibrated until | Calibration period |
|------|------------------------------------|--------------|-------------|---------------|------------------|------------------|--------------------|
| 1 | Spectrum Analyzer | Agilent | E4407B | MY45108040 | 2023.03.27 | 2024.03.26 | 1 year |
| 2 | Spectrum Analyzer | Agilent | N9020A | MY49100060 | 2023.05.29 | 2024.05.28 | 1 year |
| 3 | Spectrum Analyzer | R&S | FSV40 | 101417 | 2023.03.27 | 2024.03.26 | 1 year |
| 4 | Test Receiver | R&S | ESPI7 | 101318 | 2023.03.27 | 2024.03.26 | 1 year |
| 5 | Bilog Antenna | TESEQ | CBL6111D | 31216 | 2023.03.27 | 2024.03.26 | 1 year |
| 6 | 50Ω Coaxial Switch | Anritsu | MP59B | 6200983705 | 2023.05.06 | 2026.05.05 | 3 year |
| 7 | Horn Antenna | EM | EM-AH-10180 | 2011071402 | 2023.03.27 | 2024.03.26 | 1 year |
| 8 | Broadband Horn Antenna | SCHWARZBECK | BBHA 9170 | 803 | 2022.11.08 | 2023.11.07 | 1 year |
| 9 | Amplifier | EMC | EMC051835SE | 980246 | 2023.05.29 | 2024.05.28 | 1 year |
| 10 | Active Loop Antenna | SCHWARZBECK | FMZB 1519B | 055 | 2022.11.08 | 2023.11.07 | 1 year |
| 11 | Power Meter | DARE | RPR3006W | 15I00041SN084 | 2022.11.08 | 2023.11.07 | 1 year |
| 12 | Test Cable (9KHz-30MHz) | N/A | R-01 | N/A | 2023.05.06 | 2026.05.05 | 3 year |
| 13 | Test Cable (30MHz-1GHz) | N/A | R-02 | N/A | 2023.05.06 | 2026.05.05 | 3 year |
| 14 | High Test Cable(1G-40GHz) | N/A | R-03 | N/A | 2022.06.17 | 2025.06.16 | 3 year |
| 15 | Filter | TRILTHIC | 2400MHz | 29 | 2022.11.08 | 2023.11.07 | 1 year |
| 16 | temporary antenna connector (Note) | NTS | R001 | N/A | N/A | N/A | N/A |

Note:

We will use the temporary antenna connector (soldered on the PCB board) When conducted test And this temporary antenna connector is listed within the instrument list

7 TEST REQUIREMENTS

7.1 CONDUCTED EMISSIONS TEST

7.1.1 Applicable Standard

According to FCC Part 15.207(a)

7.1.2 Conformance Limit

| Frequency(MHz) | Conducted Emission Limit | |
|----------------|--------------------------|---------|
| | Quasi-peak | Average |
| 0.15-0.5 | 66-56* | 56-46* |
| 0.5-5.0 | 56 | 46 |
| 5.0-30.0 | 60 | 50 |

Note: 1. *Decreases with the logarithm of the frequency
 2. The lower limit shall apply at the transition frequencies
 3. The limit decreases in line with the logarithm of the frequency in the range of 0.15 to 0.50MHz.

7.1.3 Test Configuration

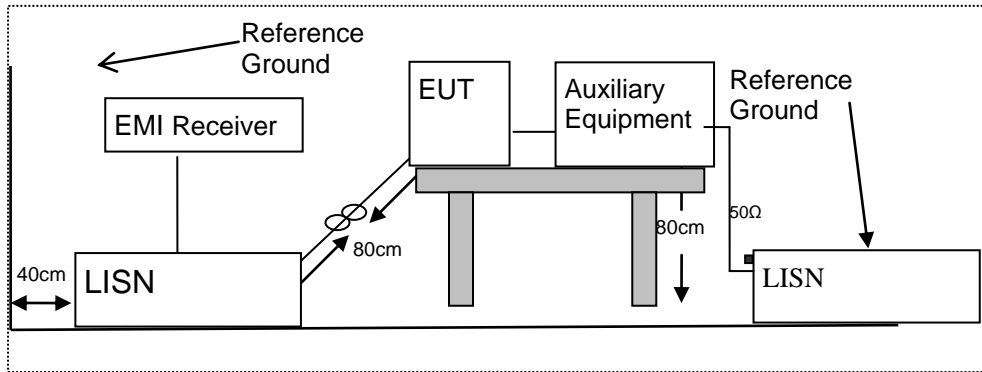

7.1.4 Test Procedure

According to the requirements in Section 13.1.4.1 of ANSI C63.10-2013 Conducted emissions the EUT measured in the frequency range between 0.15 MHz and 30 MHz using CISPR Quasi-Peak and average detector mode.

1. The EUT was placed 0.4 meter from the conducting wall of the shielding room.
2. The EUT was placed on a table which is 0.8m above ground plane.
3. Connect EUT to the power mains through a line impedance stabilization network (LISN). All other support equipments powered from additional LISN(s). The LISN provide 50 Ohm/ 50uH of coupling impedance for the measuring instrument.
4. Interconnecting cables that hang closer than 40 cm to the ground plane shall be folded back and forth in the center forming a bundle 30 to 40cm long.
5. I/O cables that are not connected to a peripheral shall be bundled in the center. The end of the cable may be terminated, if required, using the correct terminating impedance. The overall length shall not exceed 1 m.
6. LISN at least 80 cm from nearest part of EUT chassis.
7. The frequency range from 150KHz to 30MHz was searched.
8. Set the test-receiver system to Peak Detect Function and specified bandwidth(IF bandwidth=9KHz) with Maximum Hold Mode
9. For the actual test configuration, please refer to the related Item –EUT Test Photos.

7.1.5 Test Results

| | | | |
|----------------|--------------------|--------------------|---------------|
| EUT: | SoundExtreme SEB26 | Model Name : | GDI-EXSEB2601 |
| Temperature: | 22°C | Relative Humidity: | 57% |
| Pressure: | 1010hPa | Phase : | N/A |
| Test Voltage : | N/A | Test Mode: | N/A |

Note: EUT is battery powered,not Applicable.

7.2 RADIATED SPURIOUS EMISSION

7.2.1 Applicable Standard

According to FCC Part 15.247(d) and 15.209 and ANSI C63.10-2013

7.2.2 Conformance Limit

According to FCC Part 15.247(d): radiated emissions which fall in the restricted bands, as defined in §15.205(a), must also comply with the radiated emission limits specified in §15.209(a) (see §15.205(c)).
According to FCC Part 15.205, Restricted bands

| MHz | MHz | MHz | GHz |
|-------------------|---------------------|---------------|-------------|
| 0.090-0.110 | 16.42-16.423 | 399.9-410 | 4.5-5.15 |
| 0.495-0.505 | 16.69475-16.69525 | 608-614 | 5.35-5.46 |
| 2.1735-2.1905 | 16.80425-16.80475 | 960-1240 | 7.25-7.75 |
| 4.125-4.128 | 25.5-25.67 | 1300-1427 | 8.025-8.5 |
| 4.17725-4.17775 | 37.5-38.25 | 1435-1626.5 | 9.0-9.2 |
| 4.20725-4.20775 | 73-74.6 | 1645.5-1646.5 | 9.3-9.5 |
| 6.215-6.218 | 74.8-75.2 | 1660-1710 | 10.6-12.7 |
| 6.26775-6.26825 | 123-138 | 2200-2300 | 14.47-14.5 |
| 8.291-8.294 | 149.9-150.05 | 2310-2390 | 15.35-16.2 |
| 8.362-8.366 | 156.52475-156.52525 | 2483.5-2500 | 17.7-21.4 |
| 8.37625-8.38675 | 156.7-156.9 | 2690-2900 | 22.01-23.12 |
| 8.41425-8.41475 | 162.0125-167.17 | 3260-3267 | 23.6-24.0 |
| 12.29-12.293 | 167.72-173.2 | 3332-3339 | 31.2-31.8 |
| 12.51975-12.52025 | 240-285 | 3345.8-3358 | 36.43-36.5 |
| 12.57675-12.57725 | 322-335.4 | 3600-4400 | (2) |
| 13.36-13.41 | | | |

20dBc in any 100 kHz bandwidth outside the operating frequency band. In case the emission fall within the restricted band specified on 15.205(a), then the 15.209(a) limit in the table below has to be followed.

| Restricted Frequency(MHz) | Field Strength (μV/m) | Field Strength (dBμV/m) | Measurement Distance |
|---------------------------|-----------------------|-------------------------|----------------------|
| 0.009~0.490 | 2400/F(KHz) | 20 log (uV/m) | 300 |
| 0.490~1.705 | 24000/F(KHz) | 20 log (uV/m) | 30 |
| 1.705~30.0 | 30 | 29.5 | 30 |
| 30-88 | 100 | 40 | 3 |
| 88-216 | 150 | 43.5 | 3 |
| 216-960 | 200 | 46 | 3 |
| Above 960 | 500 | 54 | 3 |

Limits of Radiated Emission Measurement(Above 1000MHz)

| Frequency(MHz) | Class B (dBuV/m) (at 3M) | |
|----------------|--------------------------|---------|
| | PEAK | AVERAGE |
| Above 1000 | 74 | 54 |

Remark :1. Emission level in dBuV/m=20 log (uV/m)
 2. Measurement was performed at an antenna to the closed point of EUT distance of meters.
 3. For Frequency 9kHz~30MHz:
 Distance extrapolation factor =40log(Specific distance/ test distance)(dB);
 Limit line=Specific limits(dBuV) + distance extrapolation factor.
 For Frequency above 30MHz:
 Distance extrapolation factor =20log(Specific distance/ test distance)(dB);
 Limit line=Specific limits(dBuV) + distance extrapolation factor.

7.2.3 Measuring Instruments

The Measuring equipment is listed in the section 6.3 of this test report.

7.2.4 Test Configuration

(a) For radiated emissions below 30MHz

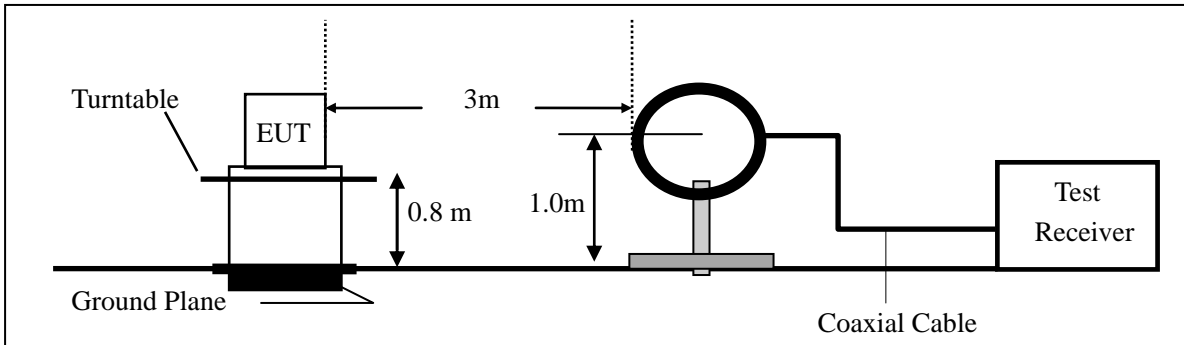

(b) For radiated emissions from 30MHz to 1000MHz

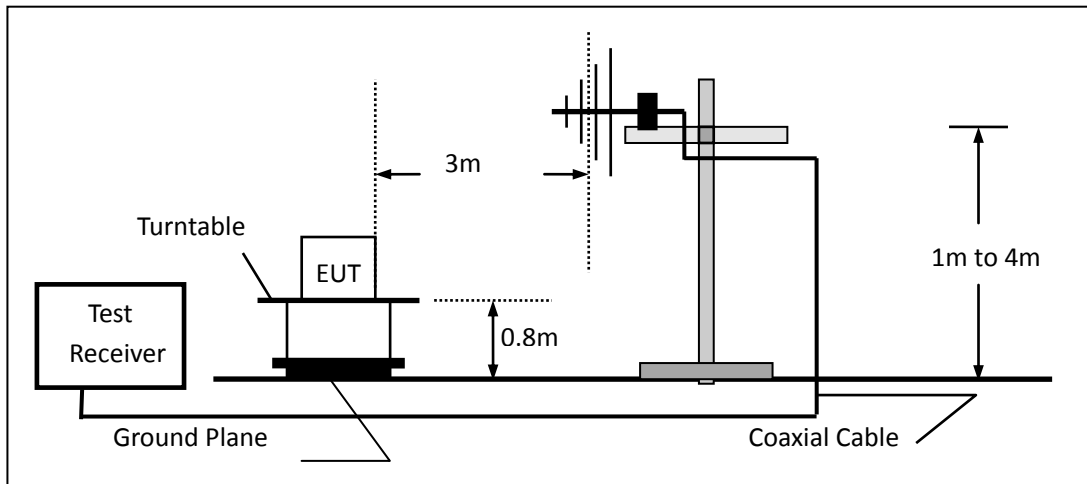

(c) For radiated emissions above 1000MHz

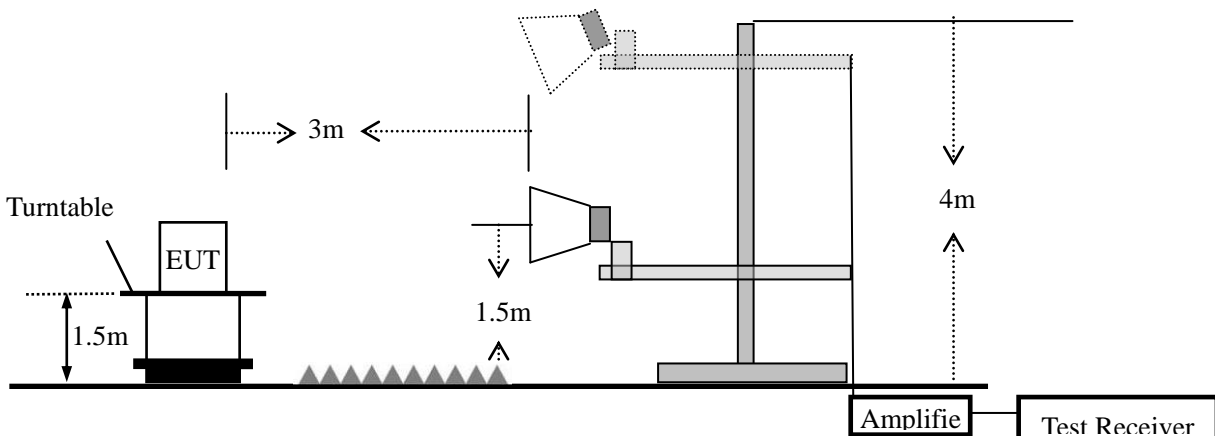

7.2.5 Test Procedure

The test site semi-anechoic chamber has met the requirement of NSA tolerance 4 dB according to the standards: ANSI C63.10-2013. The test distance is 3m. The setup is according to the requirements in Section 13.1.4.1 of ANSI C63.10-2013 and CAN/CSA-CEI/IEC CISPR 22.

This test is required for any spurious emission that falls in a Restricted Band, as defined in Section 15.205. It must be performed with the highest gain of each type of antenna proposed for use with the EUT.

Use the following spectrum analyzer settings:

| Spectrum Parameter | Setting |
|---------------------------------------|---|
| Attenuation | Auto |
| Start Frequency | 1000 MHz |
| Stop Frequency | 10th carrier harmonic |
| RB / VB (emission in restricted band) | 1 MHz / 1 MHz for Peak, 1 MHz / 1 MHz for Average |

| Receiver Parameter | Setting |
|------------------------|----------------------------------|
| Attenuation | Auto |
| Start ~ Stop Frequency | 9kHz~150kHz / RB 200Hz for QP |
| Start ~ Stop Frequency | 150kHz~30MHz / RB 9kHz for QP |
| Start ~ Stop Frequency | 30MHz~1000MHz / RB 120kHz for QP |

- a. The measuring distance of at 3 m shall be used for measurements at frequency up to 1GHz. For frequencies above 1GHz, any suitable measuring distance may be used.
- b. The EUT was placed on the top of a rotating table 0.8 m for below 1GHz and 1.5m for above 1GHz the ground at a 3 meter. The table was rotated 360 degrees to determine the position of the highest radiation.
- c. The height of the equipment or of the substitution antenna shall be 0.8 m for below 1GHz and 1.5m for above 1GHz; the height of the test antenna shall vary between 1 m to 4 m. Both horizontal and vertical polarizations of the antenna are set to make the measurement.
- d. For the radiated emission test above 1GHz:
Place the measurement antenna away from each area of the EUT determined to be a source of emissions at the specified measurement distance, while keeping the measurement antenna aimed at the source of emissions at each frequency of significant emissions, with polarization oriented for maximum response. The measurement antenna may have to be higher or lower than the EUT, depending on the radiation pattern of the emission and staying aimed at the emission source for receiving the maximum signal. The final measurement antenna elevation shall be that which maximizes the emissions. The measurement antenna elevation for maximum emissions shall be restricted to a range of heights of from 1 m to 4 m above the ground or reference ground plane.
- e. The initial step in collecting conducted emission data is a spectrum analyzer peak detector mode pre-scanning the measurement frequency range. Significant peaks are then marked and then Quasi Peak detector mode re-measured.
- f. If the Peak Mode measured value compliance with and lower than Quasi Peak Mode Limit, the EUT shall be deemed to meet QP Limits and then no additional QP Mode measurement performed.
- g. For the actual test configuration, please refer to the related Item –EUT Test Photos.

Note:

Both horizontal and vertical antenna polarities were tested and performed pretest to three orthogonal axis. The worst case emissions were reported

During the radiated emission test, the Spectrum Analyzer was set with the following configurations:

| Frequency Band (MHz) | Function | Resolution bandwidth | Video Bandwidth |
|----------------------|----------|----------------------|-----------------|
| 30 to 1000 | QP | 120 kHz | 300 kHz |
| Above 1000 | Peak | 1 MHz | 1 MHz |
| | Average | 1 MHz | 1 MHz |

Note: for the frequency ranges below 30 MHz, a narrower RBW is used for these ranges but the measured value should add a RBW correction factor (RBWCF) where $RBWCF [dB] = 10 \cdot \lg(100 [kHz]/\text{narrower RBW [kHz]})$. , the narrower RBW is 1 kHz and RBWCF is 20 dB for the frequency 9 kHz to 150 kHz, and the narrower RBW is 10 kHz and RBWCF is 10 dB for the frequency 150 kHz to 30 MHz.

7.2.6 Test Results

■ Spurious Emission below 30MHz (9KHz to 30MHz)

| | | | |
|--------------|--------------------|--------------------|---------------|
| EUT: | SoundExtreme SEB26 | Model No.: | GDI-EXSEB2601 |
| Temperature: | 20 °C | Relative Humidity: | 48% |
| Test Mode: | Mode2/Mode3/Mode4 | Test By: | Allen Liu |

| Freq. (MHz) | Ant.Pol. H/V | Emission Level(dBuV/m) | | Limit 3m(dBuV/m) | | Over(dB) | |
|-------------|--------------|------------------------|----|------------------|----|----------|----|
| | | PK | AV | PK | AV | PK | AV |
| -- | -- | -- | -- | -- | -- | -- | -- |

Note: the amplitude of spurious emission that is attenuated by more than 20dB below the permissible limit has no need to be reported.

- Spurious Emission below 1GHz (30MHz to 1GHz)
All the modulation modes have been tested, and the worst result was report as below:

| | | | |
|----------------|--------------------|--------------------|---------------|
| EUT: | SoundExtreme SEB26 | Model Name : | GDI-EXSEB2601 |
| Temperature: | 25°C | Relative Humidity: | 55% |
| Pressure: | 1010hPa | Test Mode: | Mode 1 |
| Test Voltage : | DC 10.8V | | |

| Polar (H/V) | Frequency | Meter Reading | Factor | Emission Level | Limits | Margin | Remark |
|-------------|-----------|---------------|--------|----------------|----------|--------|--------|
| | (MHz) | (dBuV) | (dB) | (dBuV/m) | (dBuV/m) | (dB) | |
| V | 112.1305 | 19.67 | 18.45 | 38.12 | 43.50 | -5.38 | QP |
| V | 165.4866 | 15.85 | 17.75 | 33.60 | 43.50 | -9.90 | QP |
| V | 393.4723 | 9.95 | 23.06 | 33.01 | 46.00 | -12.99 | QP |
| V | 423.5403 | 9.86 | 23.71 | 33.57 | 46.00 | -12.43 | QP |
| V | 578.6699 | 7.72 | 26.15 | 33.87 | 46.00 | -12.13 | QP |
| V | 993.0114 | 7.91 | 32.35 | 40.26 | 54.00 | -13.74 | QP |

Remark:
Emission Level= Meter Reading+ Factor, Margin= Emission Level - Limit

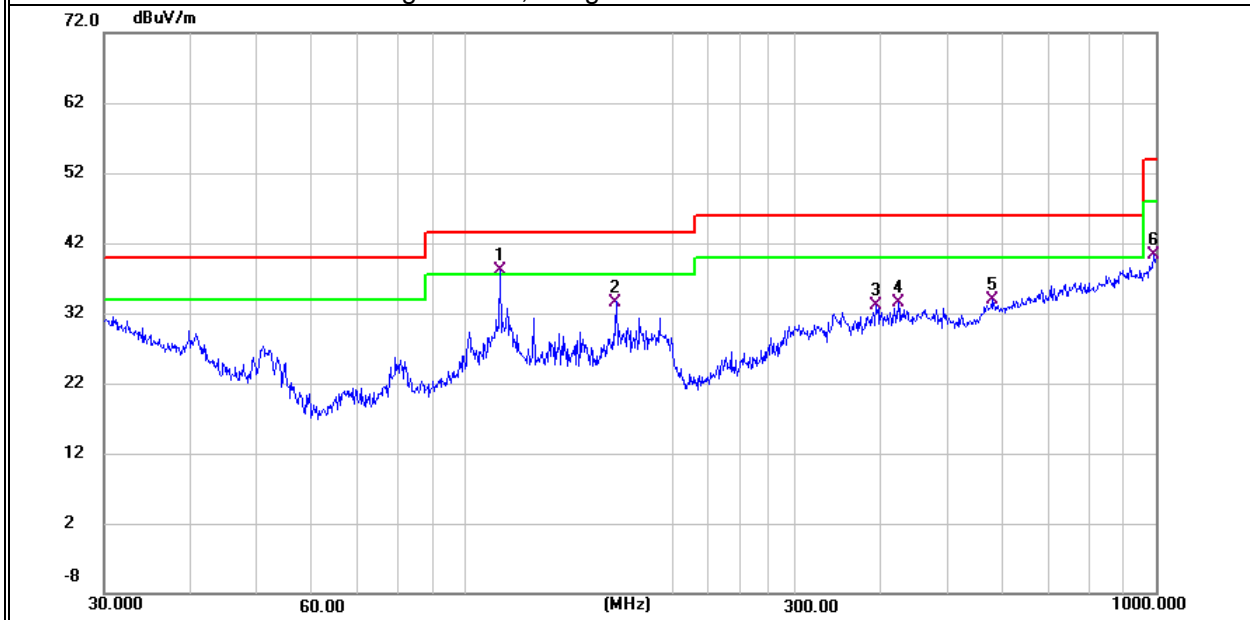

| Polar (H/V) | Frequency | Meter Reading | Factor | Emission Level | Limits | Margin | Remark |
|-------------|-----------|---------------|--------|----------------|----------|--------|--------|
| | (MHz) | (dBuV) | (dB) | (dBuV/m) | (dBuV/m) | (dB) | |
| H | 79.2426 | 19.80 | 15.25 | 35.05 | 40.00 | -4.95 | QP |
| H | 101.2885 | 17.74 | 17.78 | 35.52 | 43.50 | -7.98 | QP |
| H | 138.8735 | 17.84 | 18.72 | 36.56 | 43.50 | -6.94 | QP |
| H | 165.4866 | 19.59 | 17.75 | 37.34 | 43.50 | -6.16 | QP |
| H | 178.7584 | 22.31 | 17.00 | 39.31 | 43.50 | -4.19 | QP |
| H | 397.6334 | 17.83 | 23.15 | 40.98 | 46.00 | -5.02 | QP |

Remark:

Emission Level= Meter Reading+ Factor, Margin= Emission Level - Limit

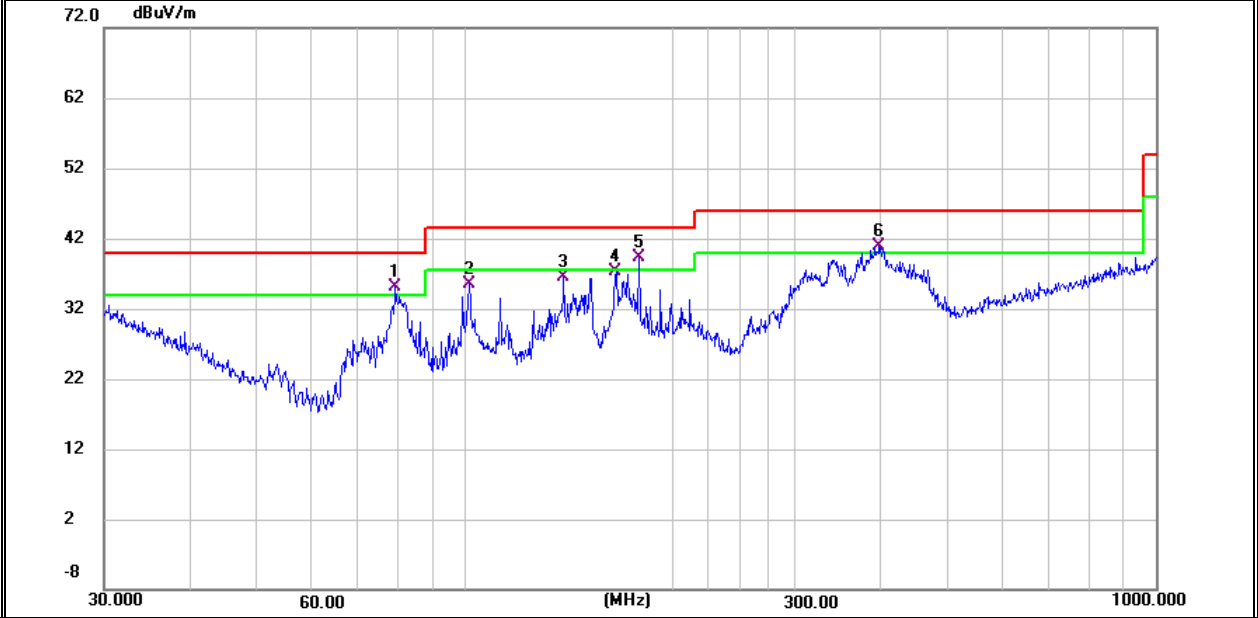

■ Spurious Emission Above 1GHz (1GHz to 25GHz)

| | | | |
|--------------|--------------------|--------------------|---------------|
| EUT: | SoundExtreme SEB26 | Model No.: | GDI-EXSEB2601 |
| Temperature: | 20 °C | Relative Humidity: | 48% |
| Test Mode: | Mode2/Mode3/Mode4 | Test By: | Allen Liu |

All the modulation modes have been tested, and the worst result was report as below:

| Frequency (MHz) | Read Level (dBμV) | Cable loss (dB) | Antenna Factor (dB/m) | Preamp Factor (dB) | Emission Level (dBμV/m) | Limits (dBμV/m) | Margin (dB) | Remark | Comment |
|--|----------------------|--------------------|--------------------------|-----------------------|----------------------------|--------------------|----------------|--------|------------|
| Low Channel (2402 MHz)(GFSK)--Above 1G | | | | | | | | | |
| 4804.214 | 63.68 | 5.21 | 35.59 | 44.30 | 60.18 | 74.00 | -13.82 | Pk | Vertical |
| 4804.214 | 40.98 | 5.21 | 35.59 | 44.30 | 37.48 | 54.00 | -16.52 | AV | Vertical |
| 7206.265 | 61.49 | 6.48 | 36.27 | 44.60 | 59.64 | 74.00 | -14.36 | Pk | Vertical |
| 7206.265 | 43.65 | 6.48 | 36.27 | 44.60 | 41.80 | 54.00 | -12.20 | AV | Vertical |
| 4804.109 | 61.26 | 5.21 | 35.55 | 44.30 | 57.72 | 74.00 | -16.28 | Pk | Horizontal |
| 4804.109 | 42.73 | 5.21 | 35.55 | 44.30 | 39.19 | 54.00 | -14.81 | AV | Horizontal |
| 7206.224 | 62.43 | 6.48 | 36.27 | 44.52 | 60.66 | 74.00 | -13.34 | Pk | Horizontal |
| 7206.224 | 48.44 | 6.48 | 36.27 | 44.52 | 46.67 | 54.00 | -7.33 | AV | Horizontal |
| Mid Channel (2441 MHz)(GFSK)--Above 1G | | | | | | | | | |
| 4882.396 | 62.66 | 5.21 | 35.66 | 44.20 | 59.33 | 74.00 | -14.67 | Pk | Vertical |
| 4882.396 | 43.00 | 5.21 | 35.66 | 44.20 | 39.67 | 54.00 | -14.33 | AV | Vertical |
| 7323.241 | 61.14 | 7.10 | 36.50 | 44.43 | 60.31 | 74.00 | -13.69 | Pk | Vertical |
| 7323.241 | 46.78 | 7.10 | 36.50 | 44.43 | 45.95 | 54.00 | -8.05 | AV | Vertical |
| 4882.108 | 60.89 | 5.21 | 35.66 | 44.20 | 57.56 | 74.00 | -16.44 | Pk | Horizontal |
| 4882.108 | 48.12 | 5.21 | 35.66 | 44.20 | 44.79 | 54.00 | -9.21 | AV | Horizontal |
| 7323.132 | 61.62 | 7.10 | 36.50 | 44.43 | 60.79 | 74.00 | -13.21 | Pk | Horizontal |
| 7323.132 | 42.04 | 7.10 | 36.50 | 44.43 | 41.21 | 54.00 | -12.79 | AV | Horizontal |
| High Channel (2480 MHz)(GFSK)-- Above 1G | | | | | | | | | |
| 4960.397 | 65.92 | 5.21 | 35.52 | 44.21 | 62.44 | 74.00 | -11.56 | Pk | Vertical |
| 4960.397 | 43.65 | 5.21 | 35.52 | 44.21 | 40.17 | 54.00 | -13.83 | AV | Vertical |
| 7440.201 | 62.30 | 7.10 | 36.53 | 44.60 | 61.33 | 74.00 | -12.67 | Pk | Vertical |
| 7440.201 | 45.40 | 7.10 | 36.53 | 44.60 | 44.43 | 54.00 | -9.57 | AV | Vertical |
| 4960.225 | 67.77 | 5.21 | 35.52 | 44.21 | 64.29 | 74.00 | -9.71 | Pk | Horizontal |
| 4960.225 | 46.75 | 5.21 | 35.52 | 44.21 | 43.27 | 54.00 | -10.73 | AV | Horizontal |
| 7440.298 | 61.67 | 7.10 | 36.53 | 44.60 | 60.70 | 74.00 | -13.30 | Pk | Horizontal |
| 7440.298 | 45.77 | 7.10 | 36.53 | 44.60 | 44.80 | 54.00 | -9.20 | AV | Horizontal |

Note:

- (1) Emission Level= Antenna Factor + Cable Loss + Read Level - Preamp Factor
- (2) All other emissions more than 20dB below the limit.

■ Spurious Emission in Restricted Band 2310-2390MHz and 2483.5-2500MHz

| | | | |
|--------------|--------------------|--------------------|---------------|
| EUT: | SoundExtreme SEB26 | Model No.: | GDI-EXSEB2601 |
| Temperature: | 20 °C | Relative Humidity: | 48% |
| Test Mode: | Mode2/ Mode4 | Test By: | Allen Liu |

All the modulation modes have been tested, and the worst result was report as below:

| Frequency | Meter Reading | Cable Loss | Antenna Factor | Preamp Factor | Emission Level | Limits | Margin | Detector | Comment |
|-------------------------|---------------|------------|----------------|---------------|----------------|----------|--------|----------|------------|
| (MHz) | (dBμV) | (dB) | dB/m | (dB) | (dBμV/m) | (dBμV/m) | (dB) | Type | |
| 1Mbps(GFSK)-Non-hopping | | | | | | | | | |
| 2310.00 | 58.92 | 2.97 | 27.80 | 43.80 | 45.89 | 74 | -28.11 | Pk | Horizontal |
| 2310.00 | 44.16 | 2.97 | 27.80 | 43.80 | 31.13 | 54 | -22.87 | AV | Horizontal |
| 2310.00 | 58.31 | 2.97 | 27.80 | 43.80 | 45.28 | 74 | -28.72 | Pk | Vertical |
| 2310.00 | 41.94 | 2.97 | 27.80 | 43.80 | 28.91 | 54 | -25.09 | AV | Vertical |
| 2390.00 | 59.04 | 3.14 | 27.21 | 43.80 | 45.59 | 74 | -28.41 | Pk | Vertical |
| 2390.00 | 43.43 | 3.14 | 27.21 | 43.80 | 29.98 | 54 | -24.02 | AV | Vertical |
| 2390.00 | 57.77 | 3.14 | 27.21 | 43.80 | 44.32 | 74 | -29.68 | Pk | Horizontal |
| 2390.00 | 42.76 | 3.14 | 27.21 | 43.80 | 29.31 | 54 | -24.69 | AV | Horizontal |
| 2483.50 | 58.22 | 3.58 | 27.70 | 44.00 | 45.50 | 74 | -28.50 | Pk | Vertical |
| 2483.50 | 43.87 | 3.58 | 27.70 | 44.00 | 31.15 | 54 | -22.85 | AV | Vertical |
| 2483.50 | 59.80 | 3.58 | 27.70 | 44.00 | 47.08 | 74 | -26.92 | Pk | Horizontal |
| 2483.50 | 42.66 | 3.58 | 27.70 | 44.00 | 29.94 | 54 | -24.06 | AV | Horizontal |
| 1Mbps(GFSK)-hopping | | | | | | | | | |
| 2310.00 | 50.57 | 2.97 | 27.80 | 43.80 | 37.54 | 74.00 | -36.46 | Pk | Vertical |
| 2310.00 | 42.37 | 2.97 | 27.80 | 43.80 | 29.34 | 54.00 | -24.66 | AV | Vertical |
| 2310.00 | 53.51 | 2.97 | 27.80 | 43.80 | 40.48 | 74.00 | -33.52 | Pk | Horizontal |
| 2310.00 | 42.69 | 2.97 | 27.80 | 43.80 | 29.66 | 54.00 | -24.34 | AV | Horizontal |
| 2390.00 | 51.42 | 3.14 | 27.21 | 43.80 | 37.97 | 74.00 | -36.03 | Pk | Vertical |
| 2390.00 | 41.21 | 3.14 | 27.21 | 43.80 | 27.76 | 54.00 | -26.24 | AV | Vertical |
| 2390.00 | 52.52 | 3.14 | 27.21 | 43.80 | 39.07 | 74.00 | -34.93 | Pk | Horizontal |
| 2390.00 | 40.13 | 3.14 | 27.21 | 43.80 | 26.68 | 54.00 | -27.32 | AV | Horizontal |
| 2483.50 | 53.80 | 3.58 | 27.70 | 44.00 | 41.08 | 74.00 | -32.92 | Pk | Vertical |
| 2483.50 | 40.94 | 3.58 | 27.70 | 44.00 | 28.22 | 54.00 | -25.78 | AV | Vertical |
| 2483.50 | 54.13 | 3.58 | 27.70 | 44.00 | 41.41 | 74.00 | -32.59 | Pk | Horizontal |
| 2483.50 | 42.86 | 3.58 | 27.70 | 44.00 | 30.14 | 54.00 | -23.86 | AV | Horizontal |

Note: (1) All other emissions more than 20dB below the limit.

■ Spurious Emission in Restricted Band 3260MHz-18000MHz

| | | | |
|--------------|--------------------|--------------------|---------------|
| EUT: | SoundExtreme SEB26 | Model No.: | GDI-EXSEB2601 |
| Temperature: | 20 °C | Relative Humidity: | 48% |
| Test Mode: | Mode2/ Mode4 | Test By: | Allen Liu |

All the modulation modes have been tested, and the worst result was report as below:

| Frequency (MHz) | Reading Level (dBμV) | Cable Loss (dB) | Antenna Factor dB/m | Preamp Factor (dB) | Emission Level (dBμV/m) | Limits (dBμV/m) | Margin (dB) | Detector Type | Comment |
|--------------------|-------------------------|--------------------|------------------------|-----------------------|----------------------------|--------------------|----------------|------------------|------------|
| 3260 | 61.08 | 4.04 | 29.57 | 44.70 | 49.99 | 74 | -24.01 | Pk | Vertical |
| 3260 | 56.03 | 4.04 | 29.57 | 44.70 | 44.94 | 54 | -9.06 | AV | Vertical |
| 3260 | 62.88 | 4.04 | 29.57 | 44.70 | 51.79 | 74 | -22.21 | Pk | Horizontal |
| 3260 | 57.25 | 4.04 | 29.57 | 44.70 | 46.16 | 54 | -7.84 | AV | Horizontal |
| 3332 | 65.91 | 4.26 | 29.87 | 44.40 | 55.64 | 74 | -18.36 | Pk | Vertical |
| 3332 | 53.38 | 4.26 | 29.87 | 44.40 | 43.11 | 54 | -10.89 | AV | Vertical |
| 3332 | 62.89 | 4.26 | 29.87 | 44.40 | 52.62 | 74 | -21.38 | Pk | Horizontal |
| 3332 | 52.49 | 4.26 | 29.87 | 44.40 | 42.22 | 54 | -11.78 | AV | Horizontal |
| 17797 | 44.85 | 10.99 | 43.95 | 43.50 | 56.29 | 74 | -17.71 | Pk | Vertical |
| 17797 | 33.31 | 10.99 | 43.95 | 43.50 | 44.75 | 54 | -9.25 | AV | Vertical |
| 17788 | 45.13 | 11.81 | 43.69 | 44.60 | 56.03 | 74 | -17.97 | Pk | Horizontal |
| 17788 | 31.71 | 11.81 | 43.69 | 44.60 | 42.61 | 54 | -11.39 | AV | Horizontal |

Note: (1) All other emissions more than 20dB below the limit.

7.3 NUMBER OF HOPPING CHANNEL

7.3.1 Applicable Standard

According to FCC Part 15.247(a)(1) (iii) and ANSI C63.10-2013

7.3.2 Conformance Limit

Frequency hopping systems in the 2400-2483.5MHz band shall use at least 15 channels.

7.3.3 Measuring Instruments

The Measuring equipment is listed in the section 6.3 of this test report.

7.3.4 Test Setup

Please refer to Section 6.1 of this test report.

7.3.5 Test Procedure

The testing follows ANSI C63.10-2013 clause 7.8.3
 The RF output of EUT was connected to the spectrum analyzer by RF cable and attenuator.
 The path loss was compensated to the results for each measurement.
 Set to the maximum power setting and enable the EUT transmit continuously.
 The EUT must have its hopping function enabled.
 Use the following spectrum analyzer settings:
 Span = the frequency band of operation
 RBW : To identify clearly the individual channels, set the RBW to less than 30% of the channel spacing or the 20 dB bandwidth, whichever is smaller.
 VBW \geq RBW
 Sweep = auto
 Detector function = peak
 Trace = max hold

7.3.6 Test Results

| | | | |
|--------------|--------------------|--------------------|---------------|
| EUT: | SoundExtreme SEB26 | Model No.: | GDI-EXSEB2601 |
| Temperature: | 20 °C | Relative Humidity: | 48% |
| Test Mode: | Mode 5(1Mbps) | Test By: | Allen Liu |

Test data reference attachment.

7.4 HOPPING CHANNEL SEPARATION MEASUREMENT

7.4.1 Applicable Standard

According to FCC Part 15.247(a)(1) and ANSI C63.10-2013

7.4.2 Conformance Limit

Frequency hopping systems shall have hopping channel carrier frequencies separated by a minimum of 25 kHz or the 20 dB bandwidth of the hopping channel, whichever is greater. Alternatively, frequency hopping systems operating in the 2400-2483.5MHz band shall have hopping channel carrier frequencies that are separated by 25kHz or two-thirds of the 20dB bandwidth of the hopping channel, whichever is greater.

7.4.3 Measuring Instruments

The Measuring equipment is listed in the section 6.3 of this test report.

7.4.4 Test Setup

Please refer to Section 6.1 of this test report.

7.4.5 Test Procedure

The testing follows ANSI C63.10-2013 clause 7.8.2
 The RF output of EUT was connected to the spectrum analyzer by RF cable and attenuator.
 The path loss was compensated to the results for each measurement.
 Set to the maximum power setting and enable the EUT transmit continuously.
 The EUT was operating in controlled its channel.
 Use the following spectrum analyzer settings:
 Span = Measurement Bandwidth or Channel Separation
 RBW: Start with the RBW set to approximately 30% of the channel spacing; adjust as necessary to best identify the center of each individual channel.
 VBW ≥ RBW
 Sweep = auto
 Detector function = peak
 Trace = max hold

7.4.6 Test Results

| | | | |
|--------------|--------------------|--------------------|---------------|
| EUT: | SoundExtreme SEB26 | Model No.: | GDI-EXSEB2601 |
| Temperature: | 20 °C | Relative Humidity: | 48% |
| Test Mode: | Mode2/Mode3/Mode4 | Test By: | Allen Liu |

Test data reference attachment.

7.5 AVERAGE TIME OF OCCUPANCY (DWELL TIME)

7.5.1 Applicable Standard

According to FCC Part 15.247(a)(1)(iii) and ANSI C63.10-2013

7.5.2 Conformance Limit

The average time of occupancy on any channel shall not be greater than 0.4s within a period of 0.4s multiplied by the number of hopping channels employed.

7.5.3 Measuring Instruments

The Measuring equipment is listed in the section 6.3 of this test report.

7.5.4 Test Setup

Please refer to Section 6.1 of this test report.

7.5.5 Test Procedure

The testing follows ANSI C63.10-2013 clause 7.8.4

The RF output of EUT was connected to the spectrum analyzer by RF cable and attenuator.

The path loss was compensated to the results for each measurement.

Set to the maximum power setting and enable the EUT transmit continuously.

The EUT must have its hopping function enabled.

Use the following spectrum analyzer settings:

Span = zero span, centered on a hopping channel

RBW \geq 1MHz

VBW \geq RBW

Sweep = as necessary to capture the entire dwell time per hopping channel

Detector function = peak

Trace = max hold

Measure the maximum time duration of one single pulse.

Set the EUT for DH5, DH3 and DH1 packet transmitting.

Measure the maximum time duration of one single pulse.

7.5.6 Test Results

| | | | |
|--------------|--------------------|--------------------|---------------|
| EUT: | SoundExtreme SEB26 | Model No.: | GDI-EXSEB2601 |
| Temperature: | 20 °C | Relative Humidity: | 48% |
| Test Mode: | Mode2/Mode3/Mode4 | Test By: | Allen Liu |

Test data reference attachment.

Note:

A Period Time = (channel number)*0.4

DH1 Dwell time: Reading * (1600/2)*31.6/(channel number)

DH3 Dwell time: Reading * (1600/4)*31.6/(channel number)

DH5 Dwell time: Reading * (1600/6)*31.6/(channel number)

For Example:

1. In normal mode, hopping rate is 1600 hops/s with 6 slots in 79 hopping channels.
With channel hopping rate (1600 / 6 / 79) in Occupancy Time Limit (0.4 x 79) (s),
Hops Over Occupancy Time comes to (1600 / 6 / 79) x (0.4 x 79) = 106.67 hops.
2. In AFH mode, hopping rate is 800 hops/s with 6 slots in 20 hopping channels.
With channel hopping rate (800 / 6 / 20) in Occupancy Time Limit (0.4 x 20) (s),
Hops Over Occupancy Time comes to (800 / 6 / 20) x (0.4 x 20) = 53.33 hops.
3. Dwell Time(s) = Hops Over Occupancy Time (hops) x Package Transfer Time

7.6 20DB BANDWIDTH TEST

7.6.1 Applicable Standard

According to FCC Part 15.247(a)(1) and ANSI C63.10-2013

7.6.2 Conformance Limit

No limit requirement.

7.6.3 Measuring Instruments

The Measuring equipment is listed in the section 6.3 of this test report.

7.6.4 Test Setup

Please refer to Section 6.1 of this test report.

7.6.5 Test Procedure

The testing follows ANSI C63.10-2013 clause 6.9.2

The RF output of EUT was connected to the spectrum analyzer by RF cable and attenuator.

The path loss was compensated to the results for each measurement.

Set to the maximum power setting and enable the EUT transmit continuously.

The EUT was operating in controlled its channel.

Use the following spectrum analyzer settings:

Span = approximately 2 to 3 times the 20 dB bandwidth, centered on a hopping channel

RBW \geq 1% of the 20 dB bandwidth

VBW \geq RBW

Sweep = auto

Detector function = peak

Trace = max hold

7.6.6 Test Results

| | | | |
|--------------|--------------------|--------------------|---------------|
| EUT: | SoundExtreme SEB26 | Model No.: | GDI-EXSEB2601 |
| Temperature: | 20 °C | Relative Humidity: | 48% |
| Test Mode: | Mode2/Mode3/Mode4 | Test By: | Allen Liu |

Test data reference attachment.

7.7 PEAK OUTPUT POWER

7.7.1 Applicable Standard

According to FCC Part 15.247(b)(1) and ANSI C63.10-2013

7.7.2 Conformance Limit

The maximum peak conducted output power of the intentional radiator shall not exceed the following: (1) For frequency hopping systems operating in the 2400-2483.5 MHz band employing at least 75 non-overlapping hopping channels, and all frequency hopping systems in the 5725-5850 MHz band: 1 watt. For all other frequency hopping systems in the 2400-2483.5 MHz band 0.125 watts.

7.7.3 Measuring Instruments

The Measuring equipment is listed in the section 6.3 of this test report.

7.7.4 Test Setup

Please refer to Section 6.1 of this test report.

7.7.5 Test Procedure

The testing follows ANSI C63.10-2013 clause 7.8.5.

The RF output of EUT was connected to the spectrum analyzer by RF cable and attenuator.

The path loss was compensated to the results for each measurement.

Set to the maximum power setting and enable the EUT transmit continuously.

The EUT was operating in controlled its channel.

Use the following spectrum analyzer settings:

Span = approximately 5 times the 20 dB bandwidth, centered on a hopping channel

RBW \geq the 20 dB bandwidth of the emission being measured

VBW \geq RBW

Sweep = auto

Detector function = peak

Trace = max hold

7.7.6 Test Results

| | | | |
|--------------|--------------------|--------------------|---------------|
| EUT: | SoundExtreme SEB26 | Model No.: | GDI-EXSEB2601 |
| Temperature: | 20 °C | Relative Humidity: | 48% |
| Test Mode: | Mode2/Mode3/Mode4 | Test By: | Allen Liu |

Test data reference attachment.

7.8 CONDUCTED BAND EDGE MEASUREMENT

7.8.1 Applicable Standard

According to FCC Part 15.247(d) and ANSI C63.10-2013

7.8.2 Conformance Limit

In any 100 kHz bandwidth outside the frequency band in which the spread spectrum or digitally modulated intentional radiator is operating, the radio frequency power that is produced by the intentional radiator shall be at least 20 dB below that in the 100 kHz bandwidth within the band that contains the highest level of the desired power, based on either an RF conducted or a radiated measurement, provided the transmitter demonstrates compliance with the peak conducted power limits. If the transmitter complies with the conducted power limits based on the use of RMS averaging over a time interval, as permitted under paragraph (b)(3) of this section, the attenuation required under this paragraph shall be 30 dB instead of 20 dB. Attenuation below the general limits specified in §15.209(a) is not required. In addition, radiated emissions which fall in the restricted bands, as defined in §15.205(a), must also comply with the radiated emission limits specified in §15.209(a) (see §15.205(c)).

7.8.3 Measuring Instruments

The Measuring equipment is listed in the section 6.3 of this test report.

7.8.4 Test Setup

Please refer to Section 6.1 of this test report.

7.8.5 Test Procedure

The testing follows ANSI C63.10-2013 clause 7.8.6.
 The RF output of EUT was connected to the spectrum analyzer by RF cable and attenuator.
 The path loss was compensated to the results for each measurement.
 Set to the maximum power setting and enable the EUT transmit continuously.
 The EUT must have its hopping function enabled.
 Use the following spectrum analyzer settings:
 Span = approximately 5 times the 20 dB bandwidth, centered on a hopping channel
 RBW = 100KHz
 VBW = 300KHz
 Band edge emissions must be at least 20 dB down from the highest emission level within the authorized band as measured with a 100kHz RBW. The attenuation shall be 30 dB instead of 20 dB when RMS conducted output power procedure is used.
 Measure the highest amplitude appearing on spectral display and set it as a reference level. Plot the graph with marking the highest point and edge frequency.
 Repeat above procedures until all measured frequencies were complete.

7.8.6 Test Results

| | | | |
|--------------|----------------------|--------------------|---------------|
| EUT: | SoundExtreme SEB26 | Model No.: | GDI-EXSEB2601 |
| Temperature: | 20 °C | Relative Humidity: | 48% |
| Test Mode: | Mode2 /Mode4/ Mode 5 | Test By: | Allen Liu |

Test data reference attachment.

7.9 SPURIOUS RF CONDUCTED EMISSION

7.9.1 Applicable Standard

According to FCC Part 15.247(d) and ANSI C63.10-2013.

7.9.2 Conformance Limit

In any 100 kHz bandwidth outside the frequency band in which the spread spectrum or digitally modulated intentional radiator is operating, the radio frequency power that is produced by the intentional radiator shall be at least 20 dB below that in the 100 kHz bandwidth within the band that contains the highest level of the desired power, based on either an RF conducted or a radiated measurement, provided the transmitter demonstrates compliance with the peak conducted power limits. If the transmitter complies with the conducted power limits based on the use of RMS averaging over a time interval, as permitted under paragraph (b)(3) of this section, the attenuation required under this paragraph shall be 30 dB instead of 20 dB. Attenuation below the general limits specified in §15.209(a) is not required. In addition, radiated emissions which fall in the restricted bands, as defined in §15.205(a), must also comply with the radiated emission limits specified in §15.209(a) (see §15.205(c)).

7.9.3 Measuring Instruments

The Measuring equipment is listed in the section 6.3 of this test report.

7.9.4 Test Setup

Please refer to Section 6.1 of this test report.

7.9.5 Test Procedure

Establish an emission level by using the following procedure:

- a) Set the center frequency and span to encompass frequency range to be measured.
 - b) Set the RBW = 100 kHz.
 - c) Set the VBW $\geq [3 \times \text{RBW}]$.
 - d) Detector = peak.
 - e) Sweep time = auto couple.
 - f) Trace mode = max hold.
 - g) Allow trace to fully stabilize.
 - h) Use the peak marker function to determine the maximum amplitude level.
- Then the limit shall be attenuated by at least 20 dB relative to the maximum amplitude level in 100 kHz.

7.9.6 Test Results

Remark: The measurement frequency range is from 30MHz to the 10th harmonic of the fundamental frequency. The lowest, middle and highest channels are tested to verify the spurious emissions and bandedge measurement data.

Test data reference attachment.

7.10 ANTENNA APPLICATION

7.10.1 Antenna Requirement

15.203 requirement: For intentional device, according to 15.203: an intentional radiator shall be designed to ensure that no antenna other than that furnished by the responsible party shall be used with the device.

7.10.2 Result

The EUT antenna is permanent attached PCB antenna (Gain: 0dBi). It comply with the standard requirement.

7.11 FREQUENCY HOPPING SYSTEM (FHSS) EQUIPMENT REQUIREMENTS

7.11.1 Standard Applicable

According to FCC Part 15.247(a)(1), The system shall hop to channel frequencies that are selected at the system hopping rate from a pseudo randomly ordered list of hopping frequencies. Each frequency must be used equally on the average by each transmitter. The system receivers shall have input bandwidths that match the hopping channel bandwidths of their corresponding transmitters and shall shift frequencies in synchronization with the transmitted signals. (g) Frequency hopping spread spectrum systems are not required to employ all available hopping channels during each transmission. However, the system, consisting of both the transmitter and the receiver, must be designed to comply with all of the regulations in this section should the transmitter be presented with a continuous data (or information) stream. In addition, a system employing short transmission bursts must comply with the definition of a frequency hopping system and must distribute its transmissions over the minimum number of hopping channels specified in this section. (h) The incorporation of intelligence within a frequency hopping spread spectrum system that permits the system to recognize other users within the spectrum band so that it individually and independently chooses and adapts its hopsets to avoid hopping on occupied channels is permitted. The coordination of frequency hopping systems in any other manner for the express purpose of avoiding the simultaneous occupancy of individual hopping frequencies by multiple transmitters is not permitted.

7.11.2 Frequency Hopping System

This transmitter device is frequency hopping device, and complies with FCC part 15.247 rule. This device uses Bluetooth radio which operates in 2400-2483.5 MHz band. Bluetooth uses a radio technology called frequency-hopping spread spectrum, which chops up the data being sent and transmits chunks of it on up to 79 bands (1 MHz each; centred from 2402 to 2480 MHz) in the range 2,400-2,483.5 MHz. The transmitter switches hop frequencies 1,600 times per second to assure a high degree of data security. All Bluetooth devices participating in a given piconet are synchronized to the frequency-hopping channel for the piconet. The frequency hopping sequence is determined by the master's device address and the phase of the hopping sequence (the frequency to hop at a specific time) is determined by the master's internal clock. Therefore, all slaves in a piconet must know the master's device address and must synchronize their clocks with the master's clock. Adaptive Frequency Hopping (AFH) was introduced in the Bluetooth specification to provide an effective way for a Bluetooth radio to counteract normal interference. AFH identifies "bad" channels, where either other wireless devices are interfering with the Bluetooth signal or the Bluetooth signal is interfering with another device. The AFH-enabled Bluetooth device will then communicate with other devices within its piconet to share details of any identified bad channels. The devices will then switch to alternative available "good" channels, away from the areas of interference, thus having no impact on the bandwidth used.

This device was tested with an bluetooth system receiver to check that the device maintained hopping synchronization, and the device complied with these requirements for FCC Part 15.247 rule.

7.11.3 EUT Pseudorandom Frequency Hopping Sequence

Pseudorandom Frequency Hopping Sequence Table as below: Channel: 08, 24, 40, 56, 40, 56, 72, 09, 01, 09, 33, 41, 33, 41, 65, 73, 53, 69, 06, 22, 04, 20, 36, 52, 38, 46, 70, 78, 68, 76, 21, 29, 10, 26, 42, 58, 44, 60, 76, 13, 03, 11, 35, 43, 37, 45, 69, 77, 55, 71, 08, 24, 08, 24, 40, 56, 40, 48, 72, 01, 72, 01, 25, 33, 12, 28, 44, 60, 42, 58, 74, 11, 05, 13, 37, 45 etc.

The system receiver have input bandwidths that match the hopping channel bandwidths of their corresponding transmitters and shift frequencies in synchronization with the transmitted signals.

8 TEST RESULTS

8.1 DWELL TIME

| Condition | Mode | Frequency (MHz) | Antenna | Pulse Time (ms) | Total Dwell Time (ms) | Burst Count | Period Time (ms) | Limit (ms) | Verdict |
|-----------|-------|-----------------|---------|-----------------|-----------------------|-------------|------------------|------------|---------|
| NVNT | 1-DH1 | 2441 | Ant1 | 0.381 | 121.539 | 319 | 31600 | 400 | Pass |
| NVNT | 1-DH3 | 2441 | Ant1 | 1.635 | 259.965 | 159 | 31600 | 400 | Pass |
| NVNT | 1-DH5 | 2441 | Ant1 | 2.888 | 306.128 | 106 | 31600 | 400 | Pass |
| NVNT | 2-DH1 | 2441 | Ant1 | 0.39 | 124.41 | 319 | 31600 | 400 | Pass |
| NVNT | 2-DH3 | 2441 | Ant1 | 1.64 | 260.76 | 159 | 31600 | 400 | Pass |
| NVNT | 2-DH5 | 2441 | Ant1 | 2.888 | 309.016 | 107 | 31600 | 400 | Pass |
| NVNT | 3-DH1 | 2441 | Ant1 | 0.387 | 123.453 | 319 | 31600 | 400 | Pass |
| NVNT | 3-DH3 | 2441 | Ant1 | 1.635 | 259.965 | 159 | 31600 | 400 | Pass |
| NVNT | 3-DH5 | 2441 | Ant1 | 2.896 | 306.976 | 106 | 31600 | 400 | Pass |

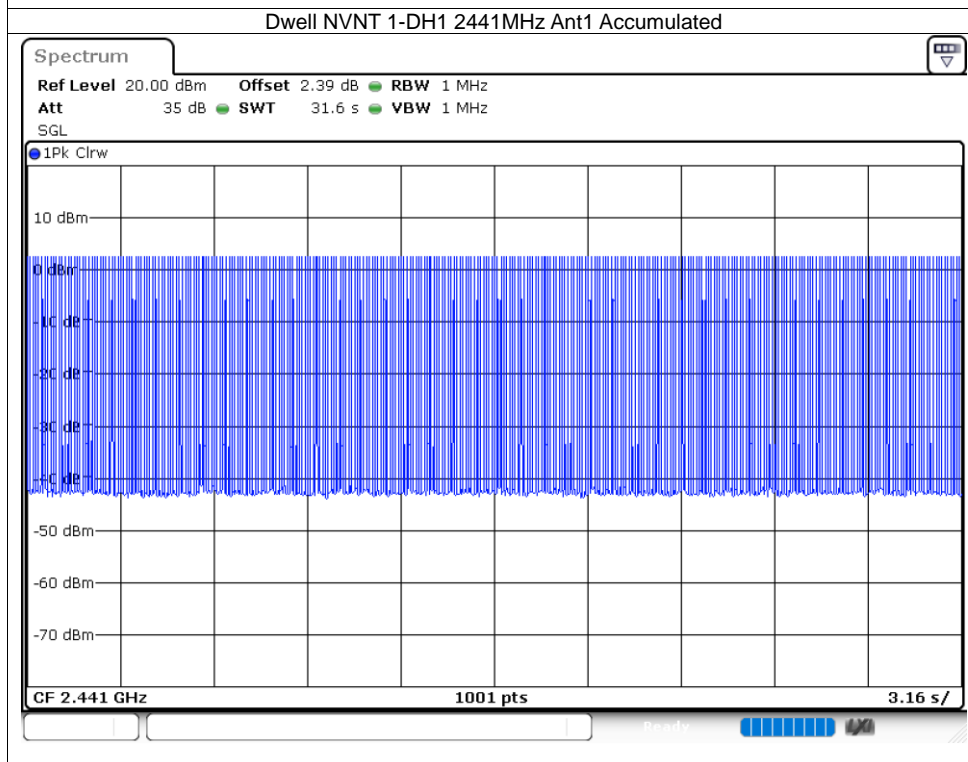
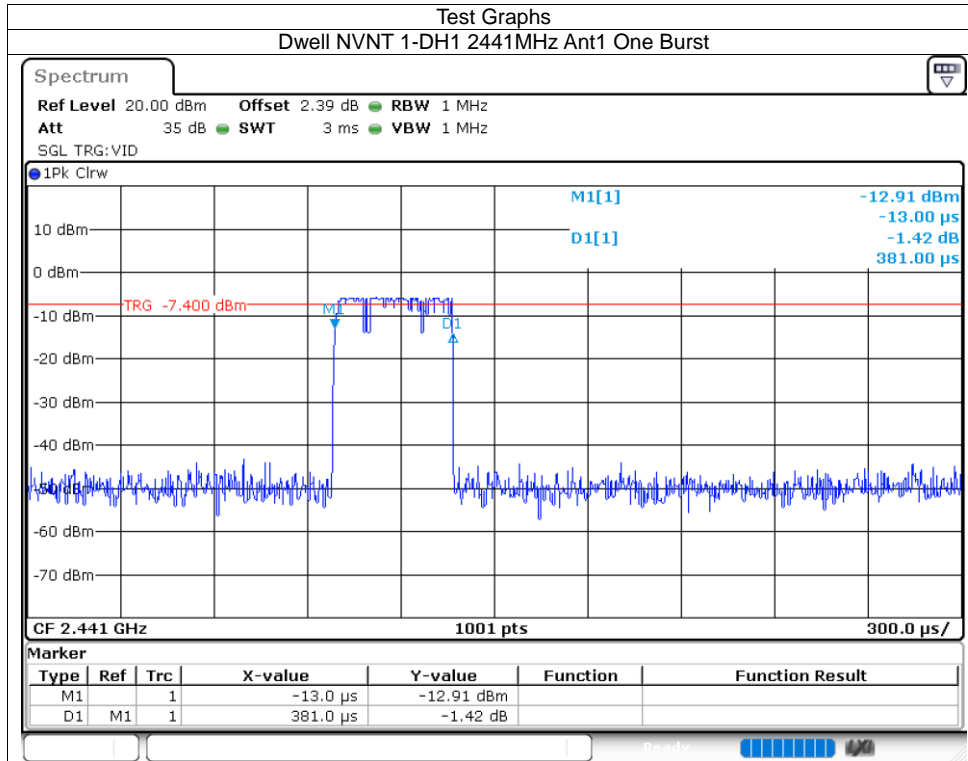

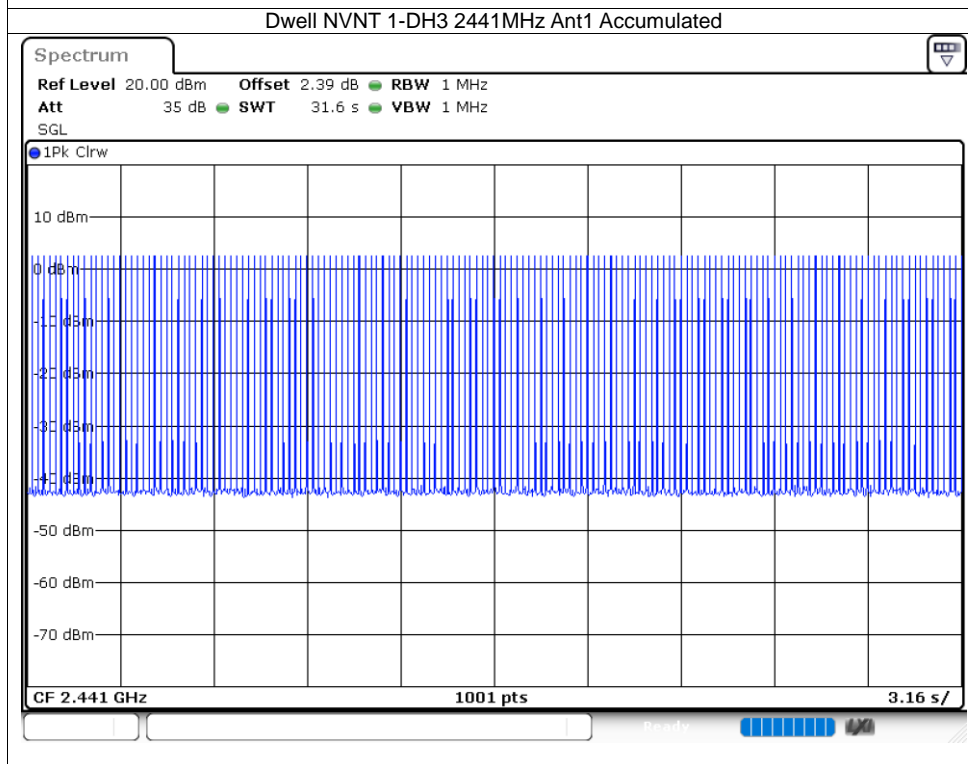
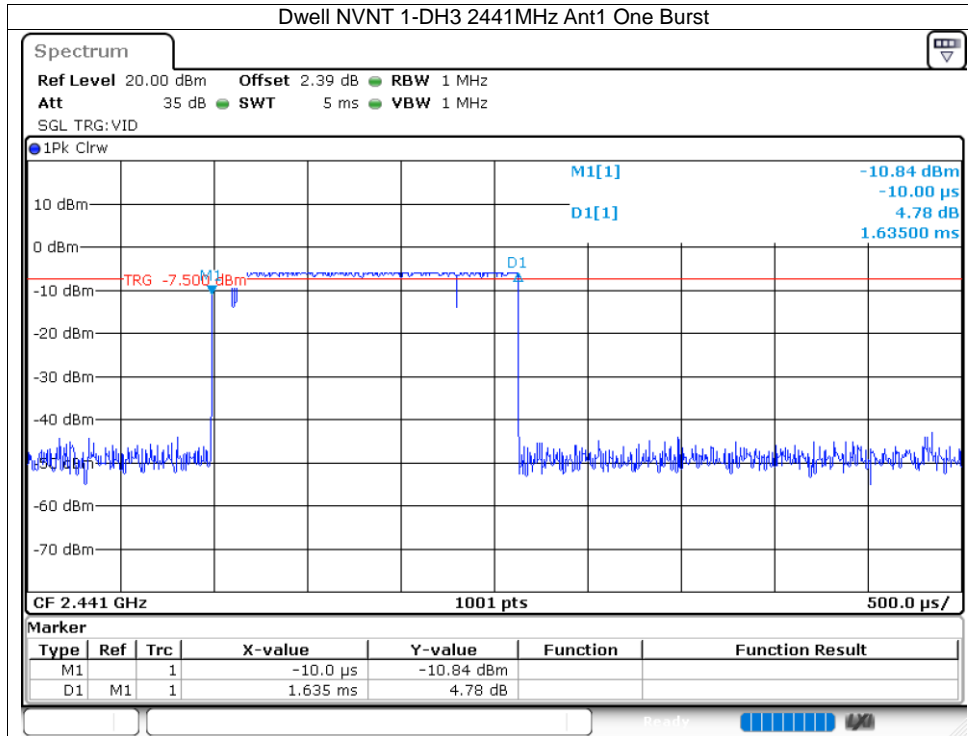

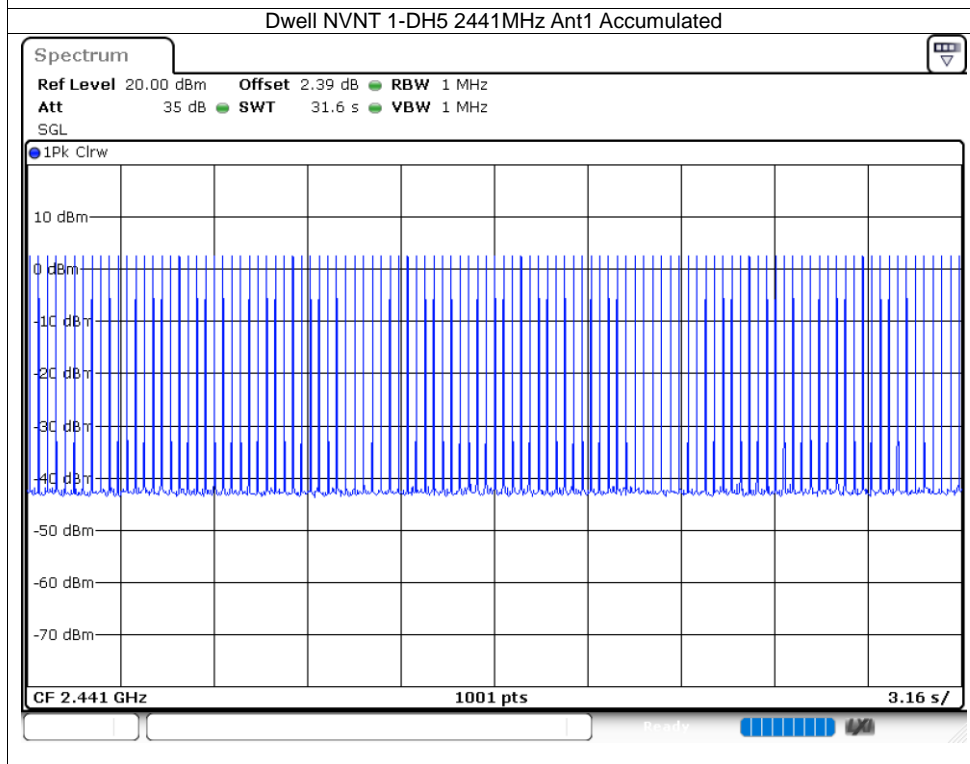
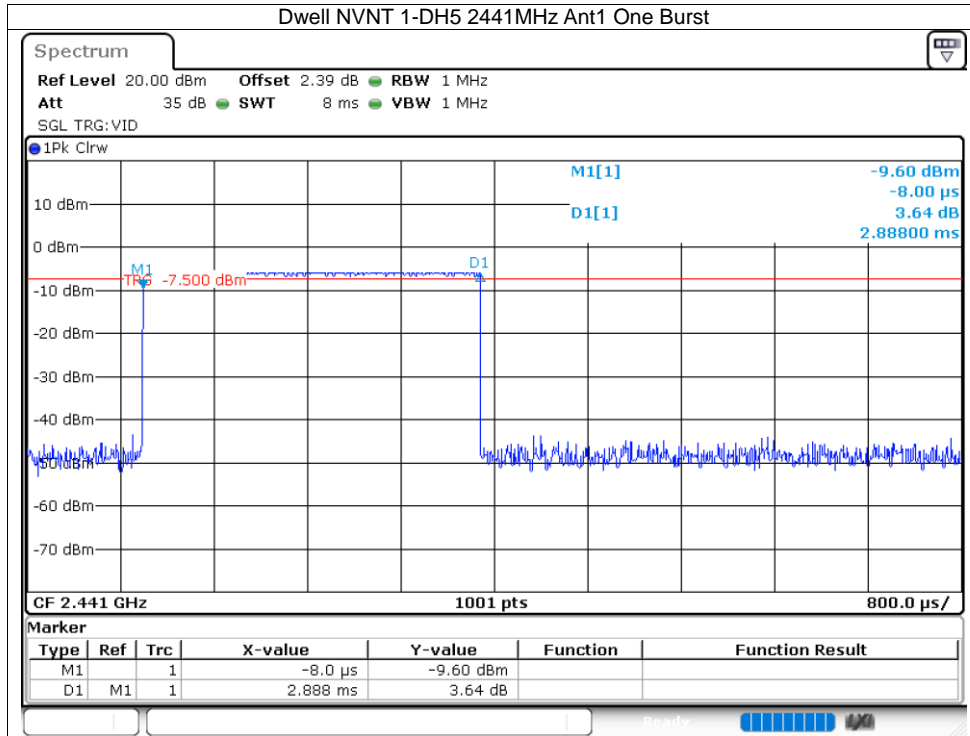

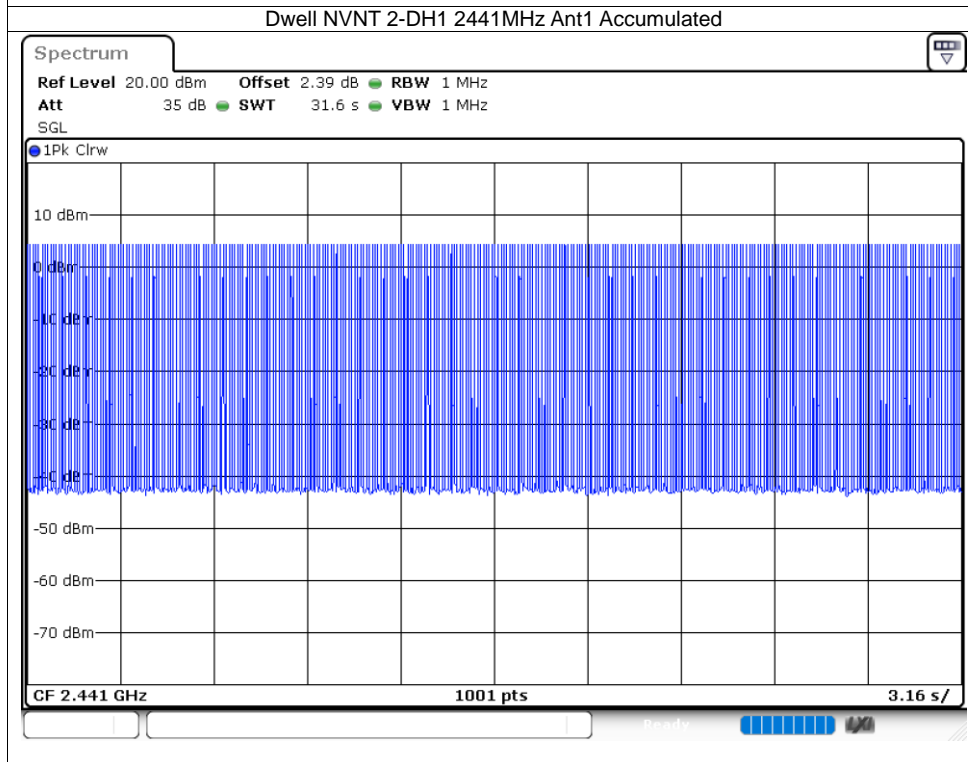
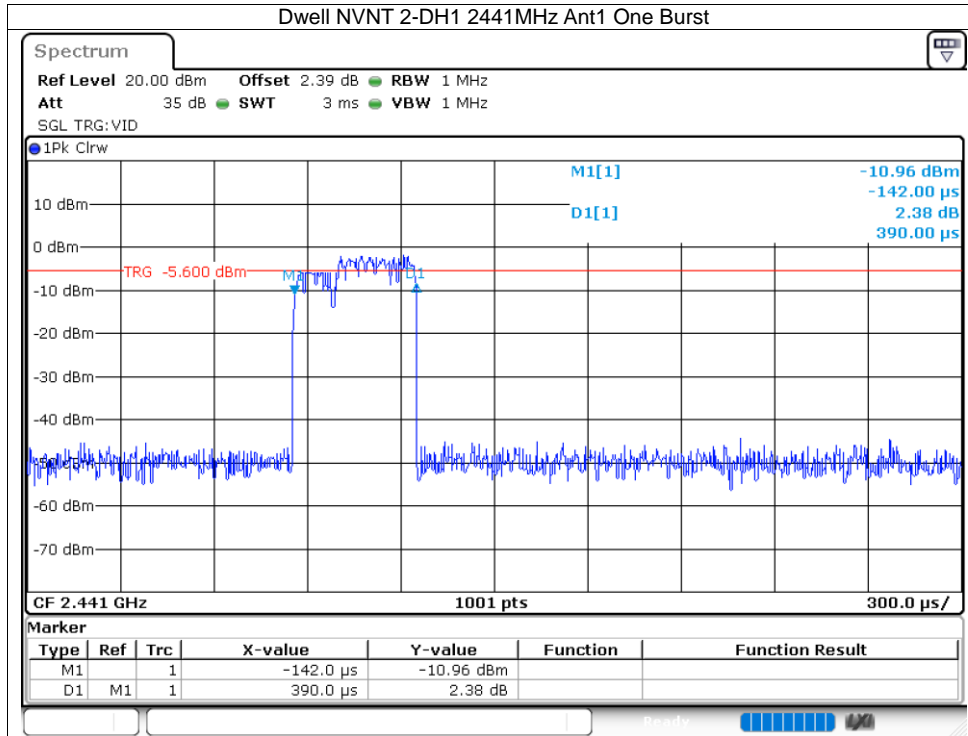

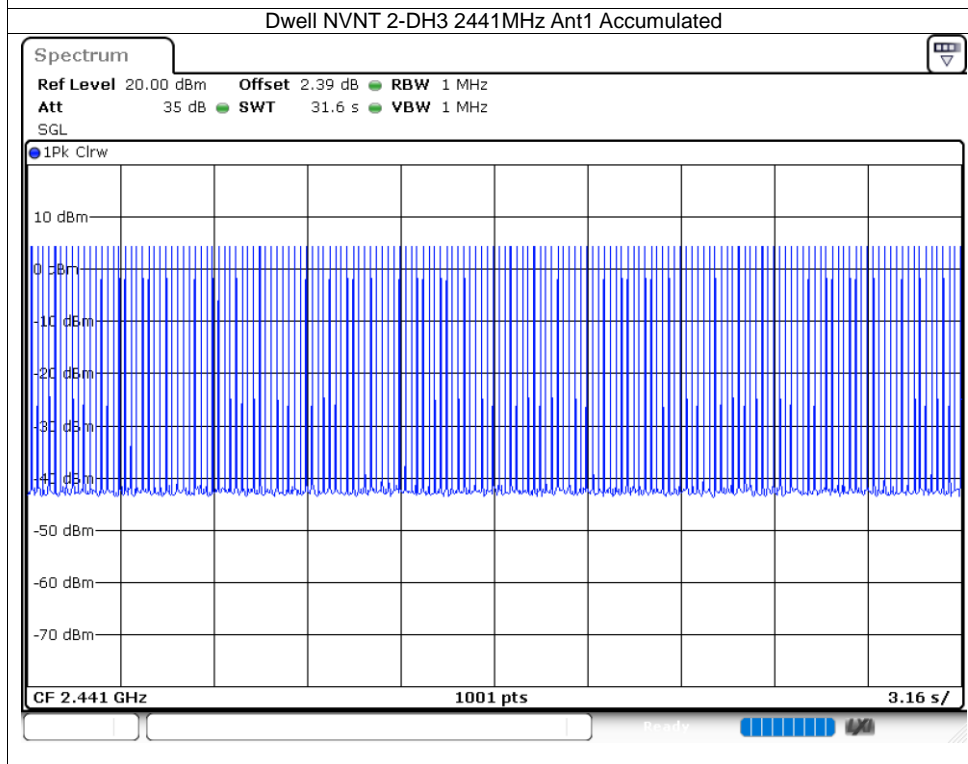
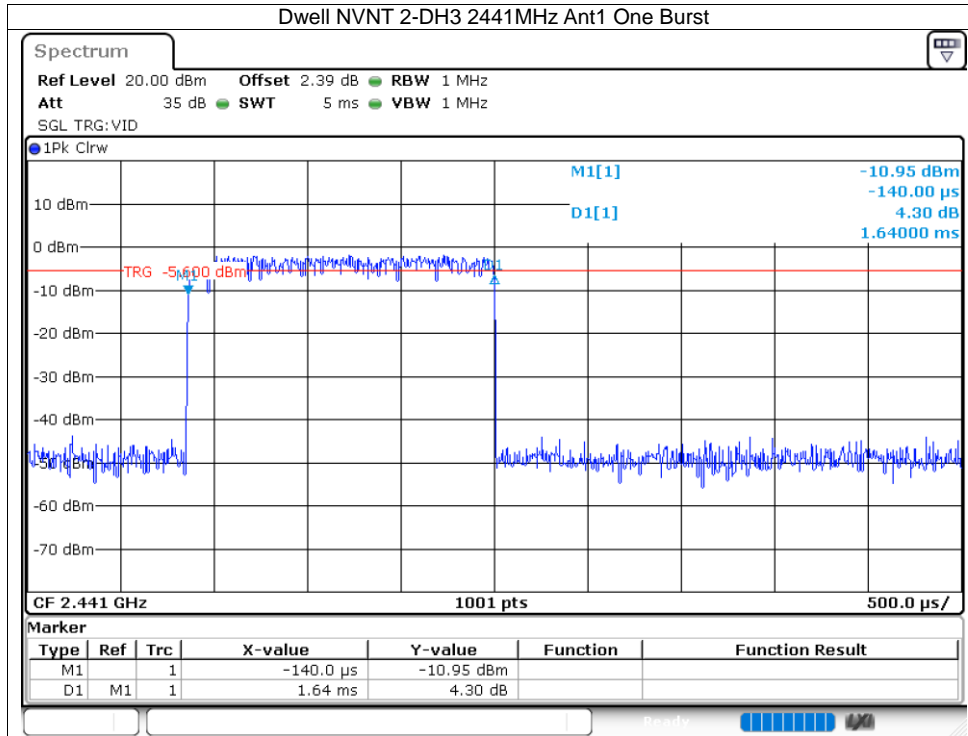

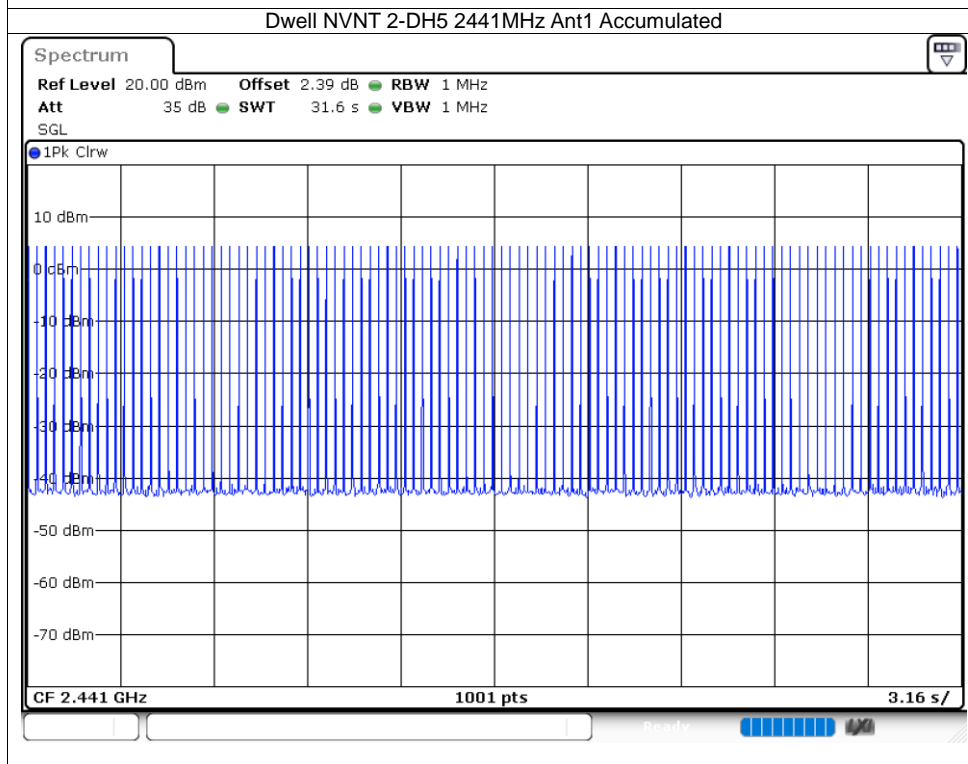
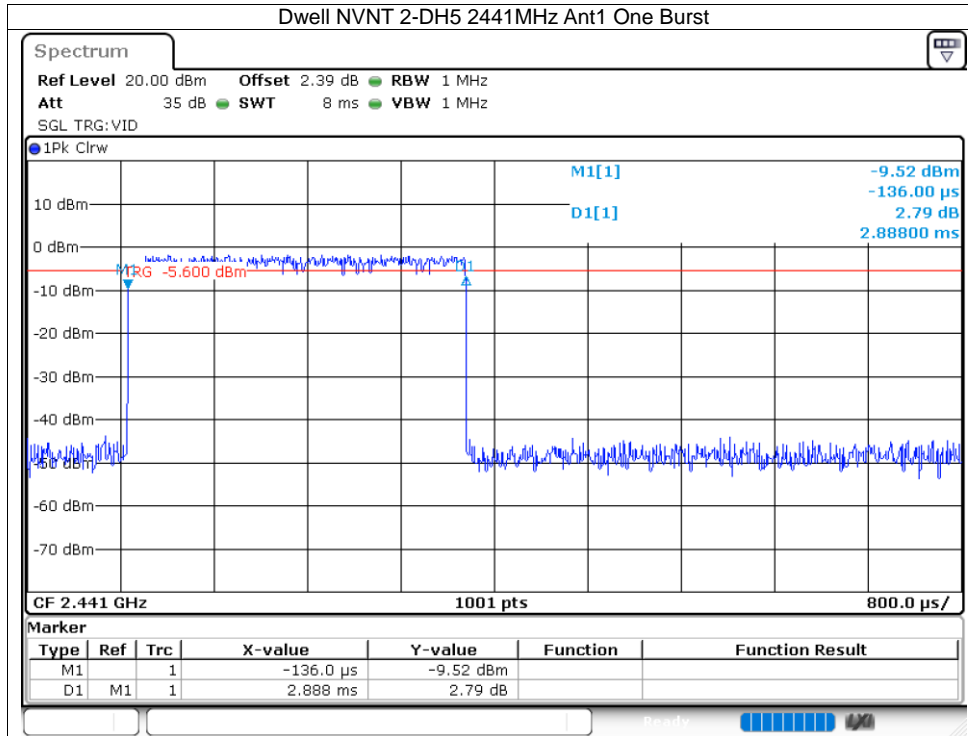

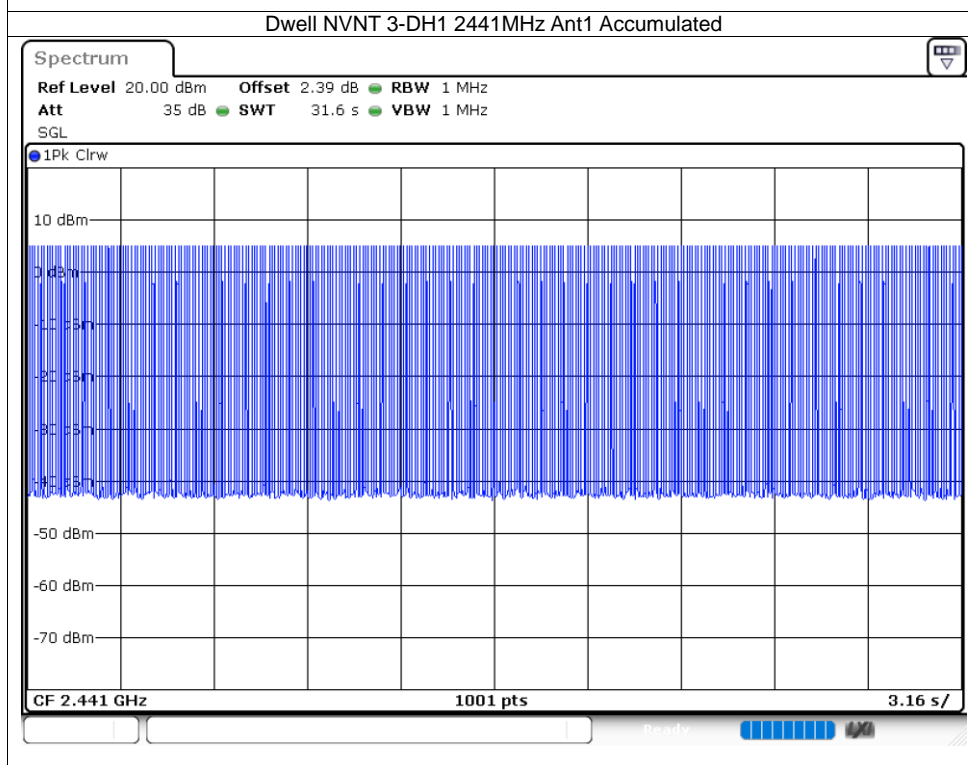
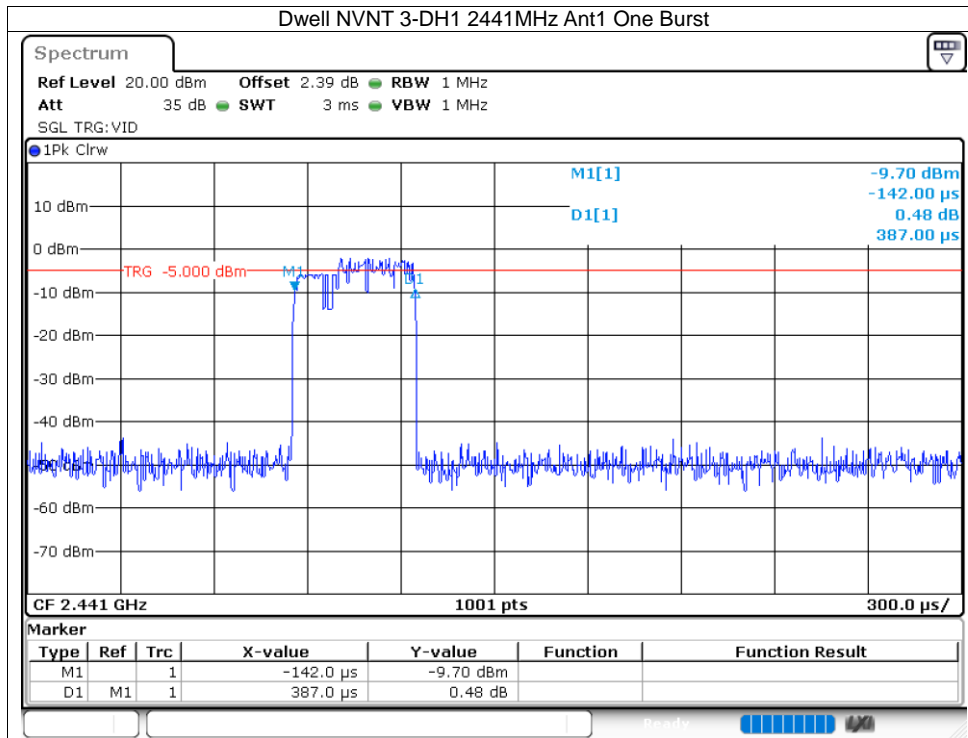

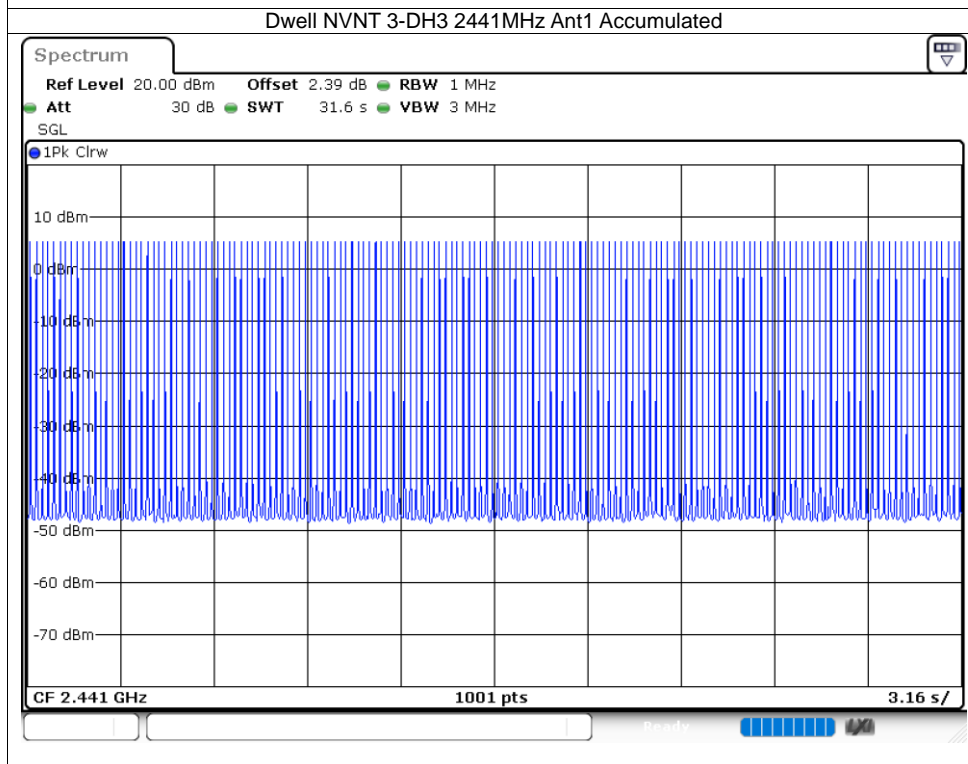
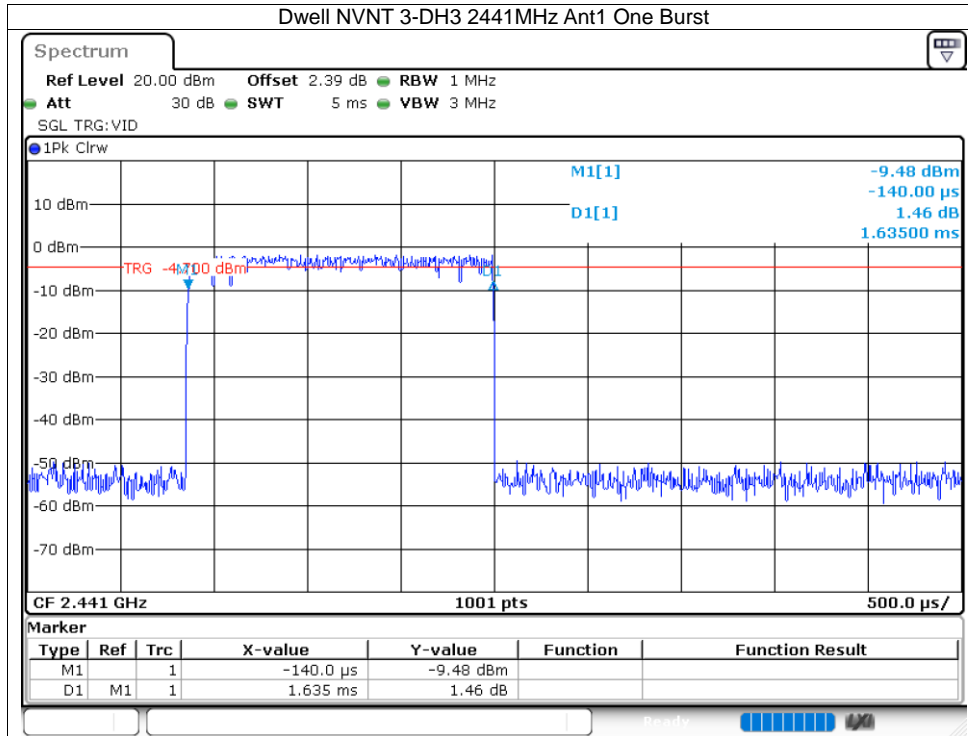

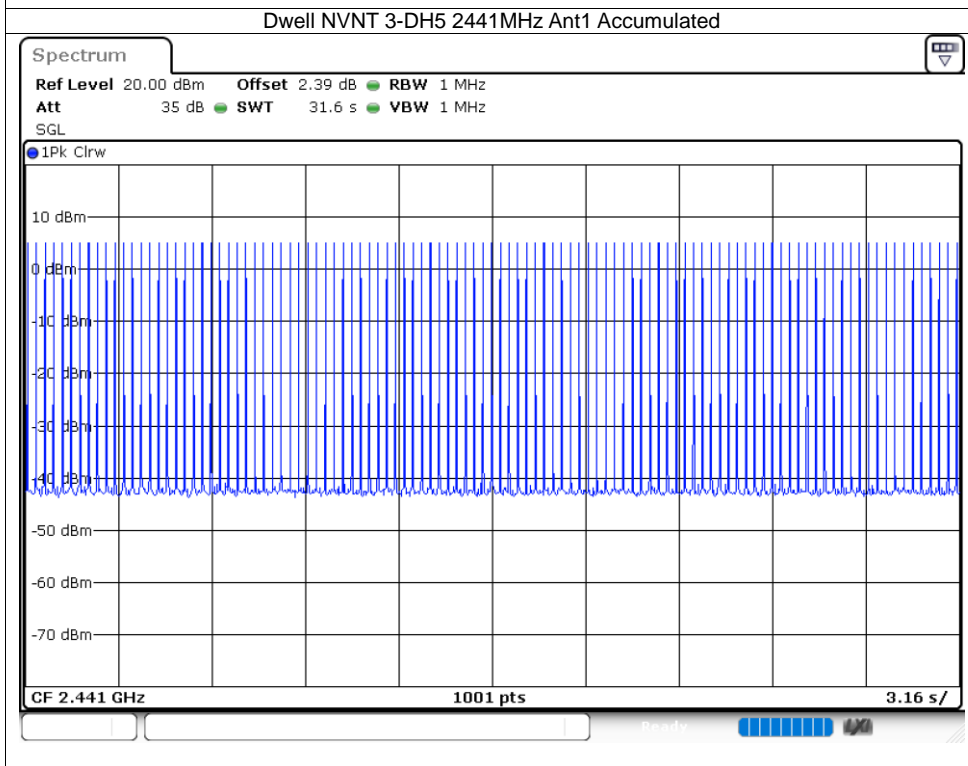
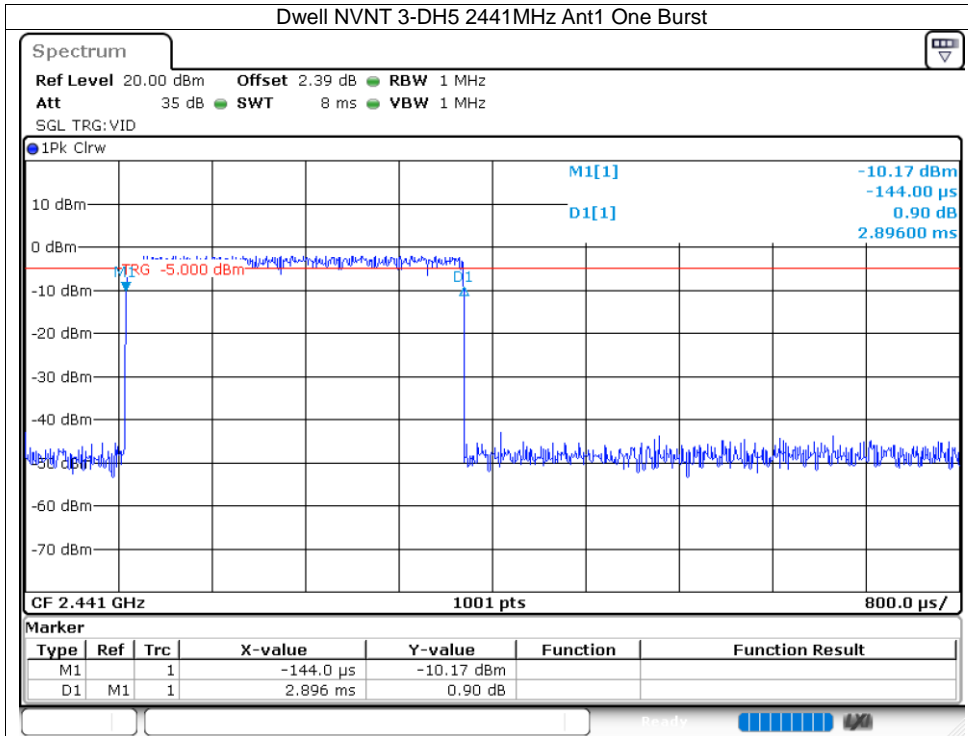

8.2 MAXIMUM CONDUCTED OUTPUT POWER

| Condition | Mode | Frequency (MHz) | Antenna | Conducted Power (dBm) | Limit (dBm) | Verdict |
|-----------|-------|-----------------|---------|-----------------------|-------------|---------|
| NVNT | 1-DH5 | 2402 | Ant1 | 2.55 | 21 | Pass |
| NVNT | 1-DH5 | 2441 | Ant1 | 2.57 | 21 | Pass |
| NVNT | 1-DH5 | 2480 | Ant1 | 3.86 | 21 | Pass |
| NVNT | 2-DH5 | 2402 | Ant1 | 5.05 | 21 | Pass |
| NVNT | 2-DH5 | 2441 | Ant1 | 5.07 | 21 | Pass |
| NVNT | 2-DH5 | 2480 | Ant1 | 6.28 | 21 | Pass |
| NVNT | 3-DH5 | 2402 | Ant1 | 5.6 | 21 | Pass |
| NVNT | 3-DH5 | 2441 | Ant1 | 5.78 | 21 | Pass |
| NVNT | 3-DH5 | 2480 | Ant1 | 6.87 | 21 | Pass |

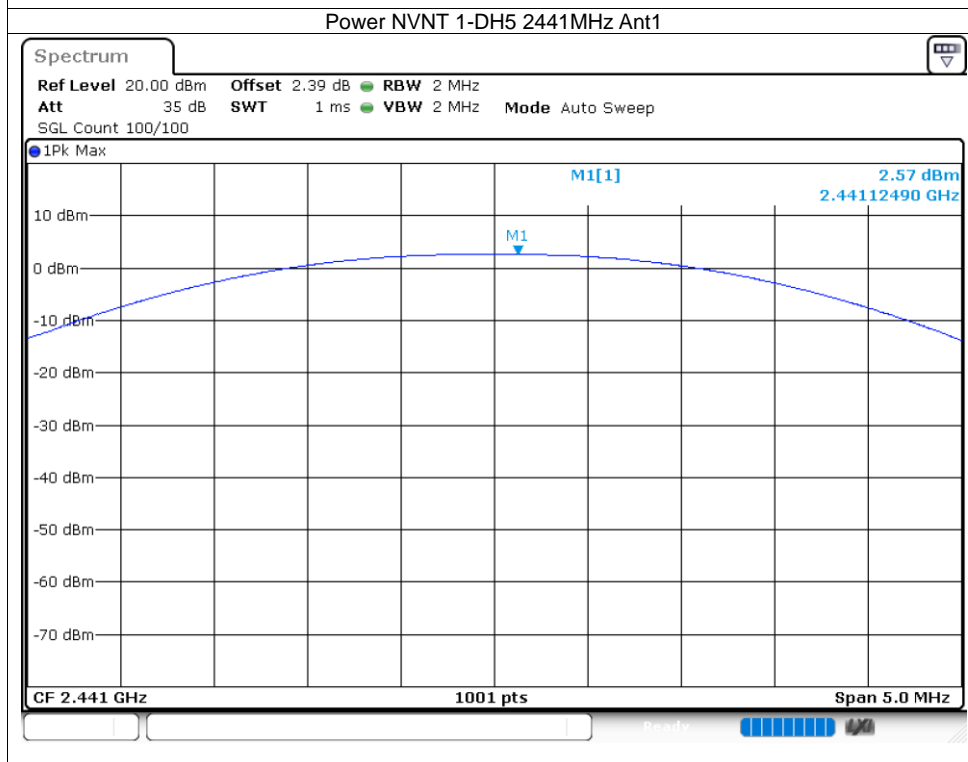
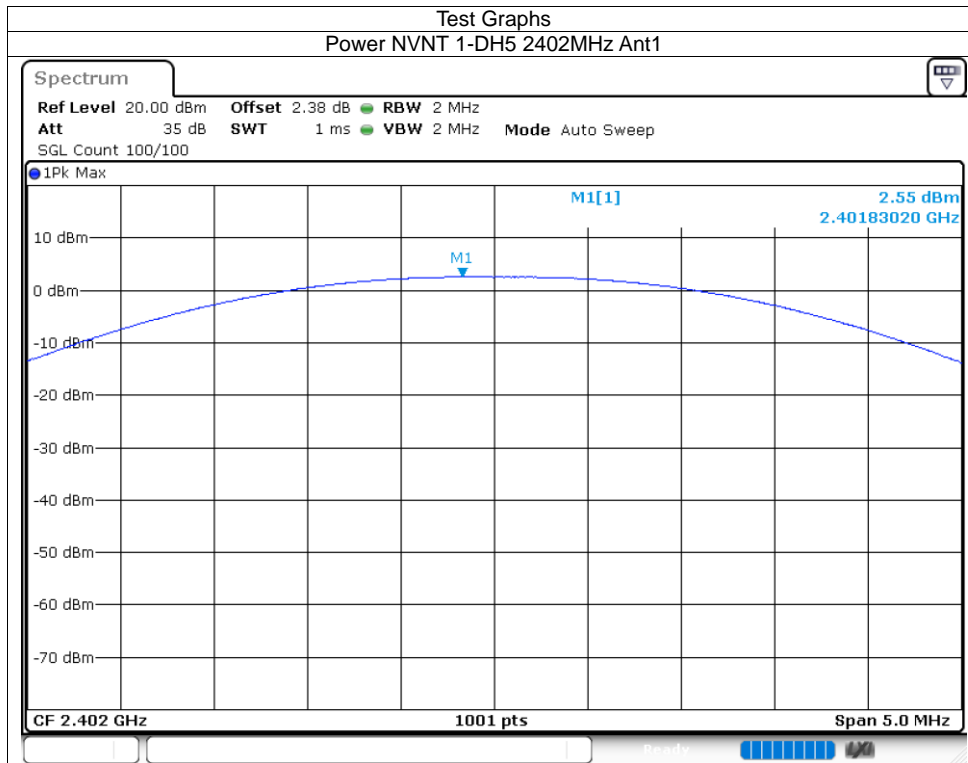

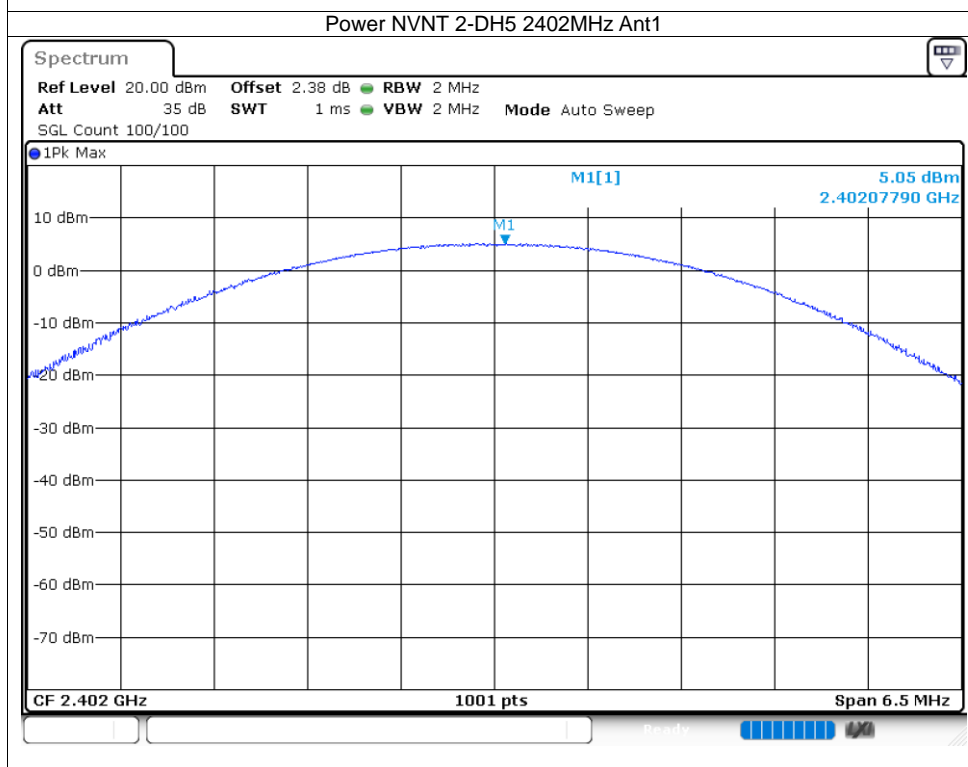
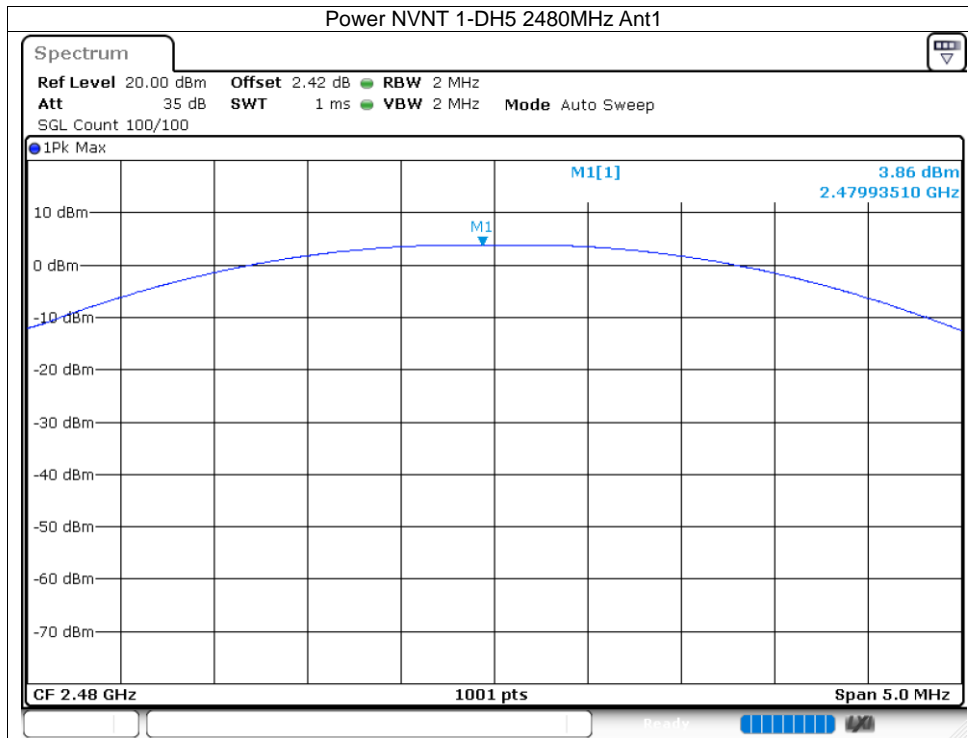

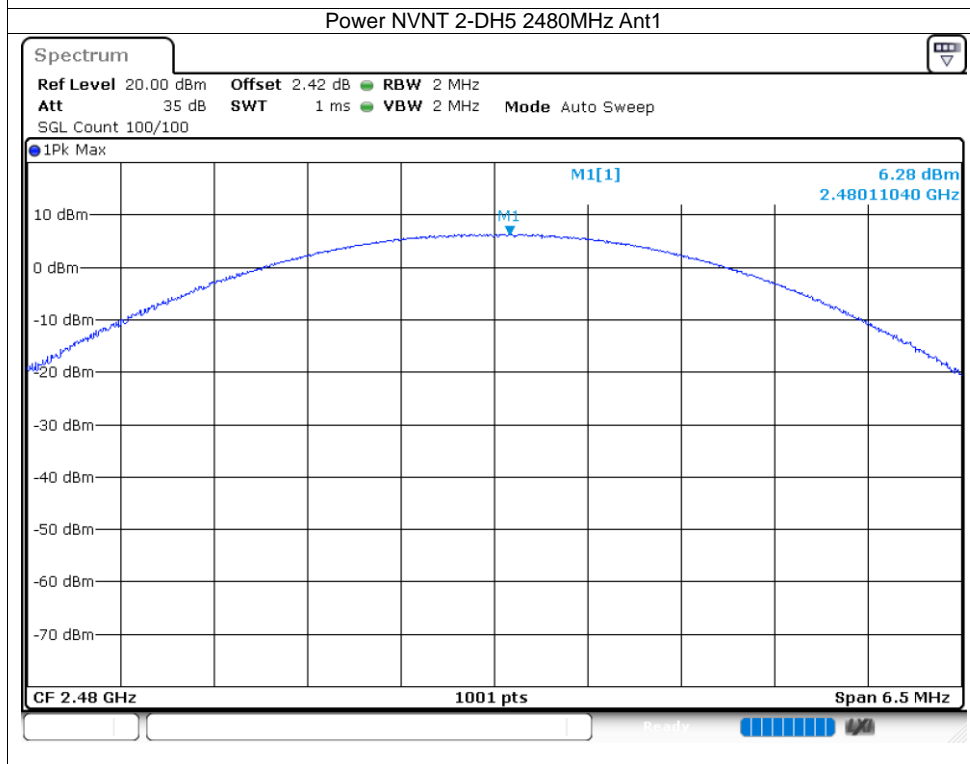
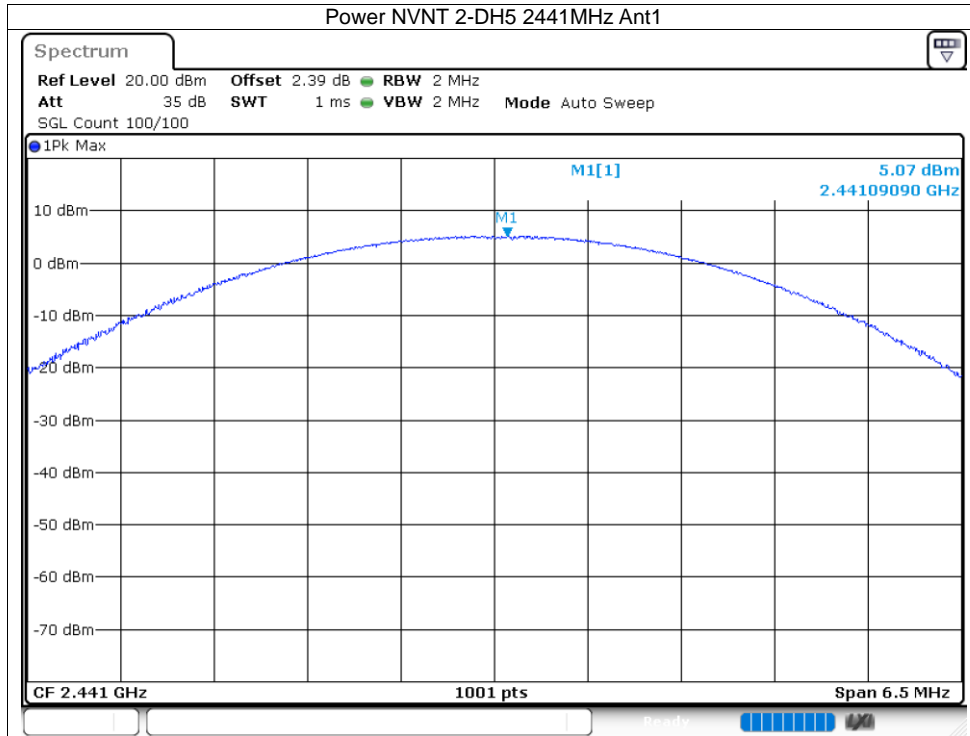

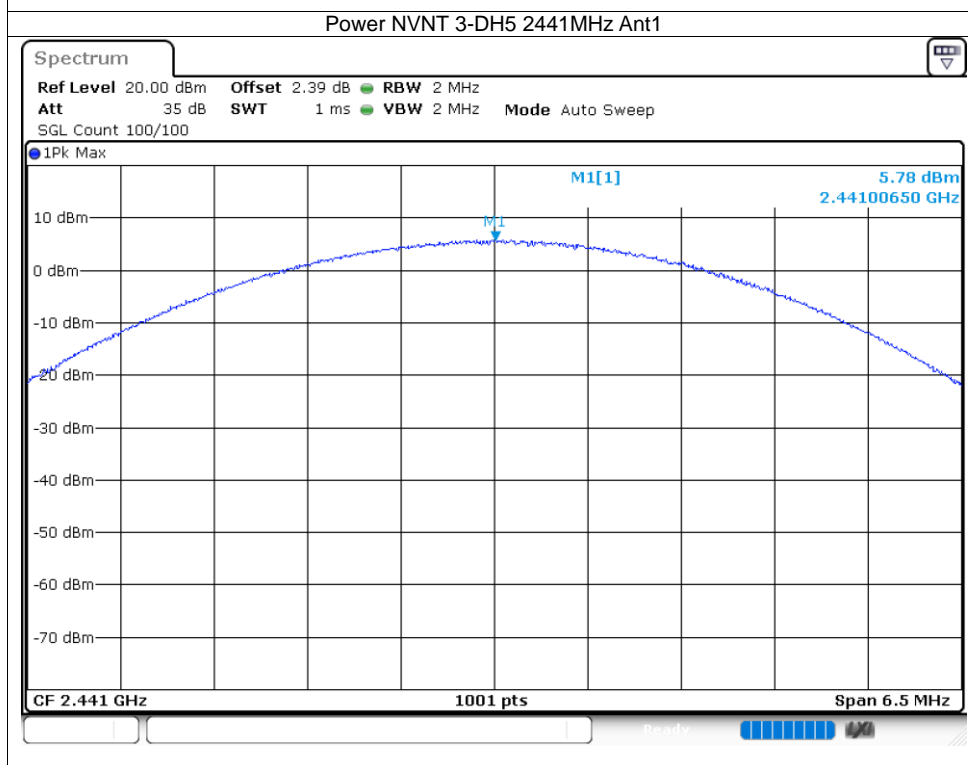
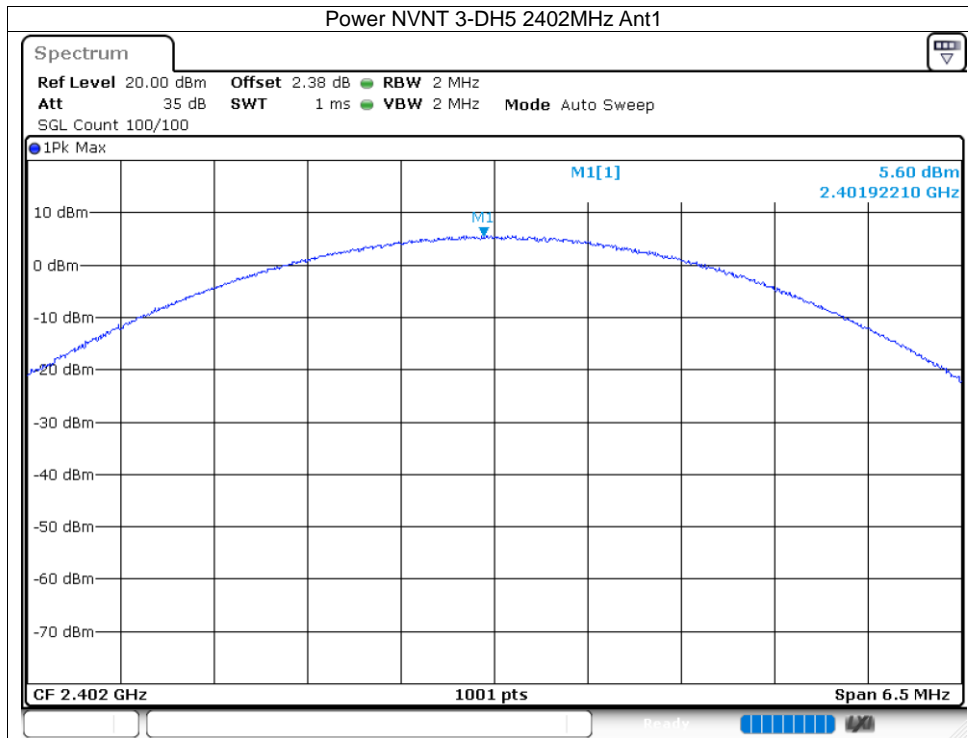

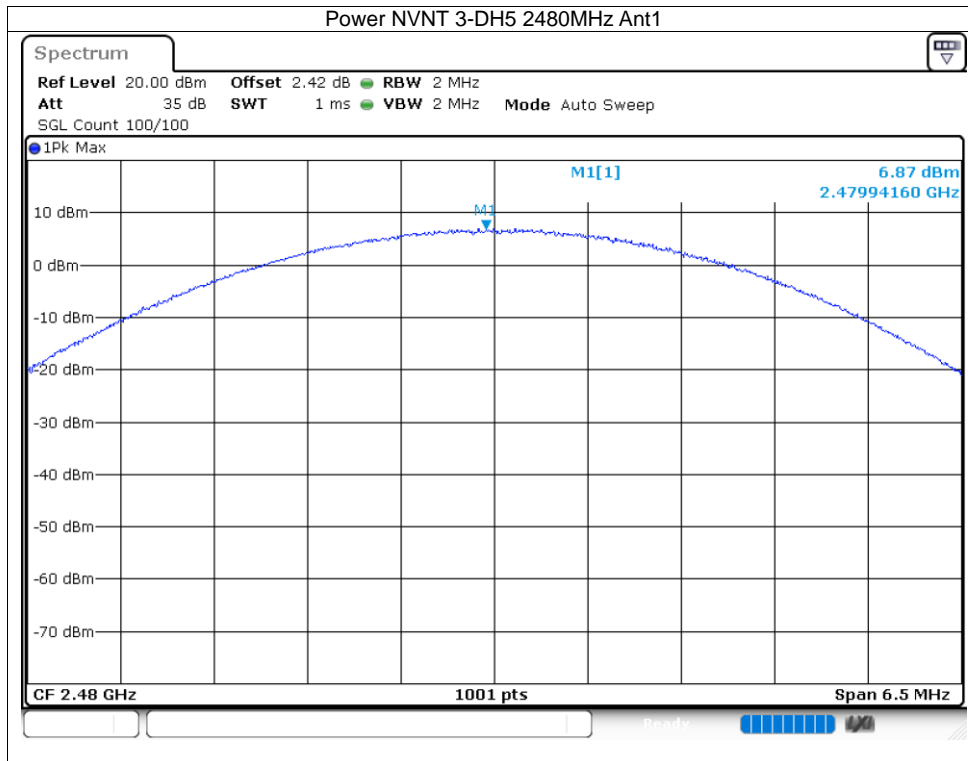

8.3 -20dB BANDWIDTH

| Condition | Mode | Frequency (MHz) | Antenna | -20 dB Bandwidth (MHz) | Verdict |
|-----------|-------|-----------------|---------|------------------------|---------|
| NVNT | 1-DH5 | 2402 | Ant1 | 0.952 | Pass |
| NVNT | 1-DH5 | 2441 | Ant1 | 0.954 | Pass |
| NVNT | 1-DH5 | 2480 | Ant1 | 0.956 | Pass |
| NVNT | 2-DH5 | 2402 | Ant1 | 1.342 | Pass |
| NVNT | 2-DH5 | 2441 | Ant1 | 1.34 | Pass |
| NVNT | 2-DH5 | 2480 | Ant1 | 1.334 | Pass |
| NVNT | 3-DH5 | 2402 | Ant1 | 1.334 | Pass |
| NVNT | 3-DH5 | 2441 | Ant1 | 1.308 | Pass |
| NVNT | 3-DH5 | 2480 | Ant1 | 1.306 | Pass |

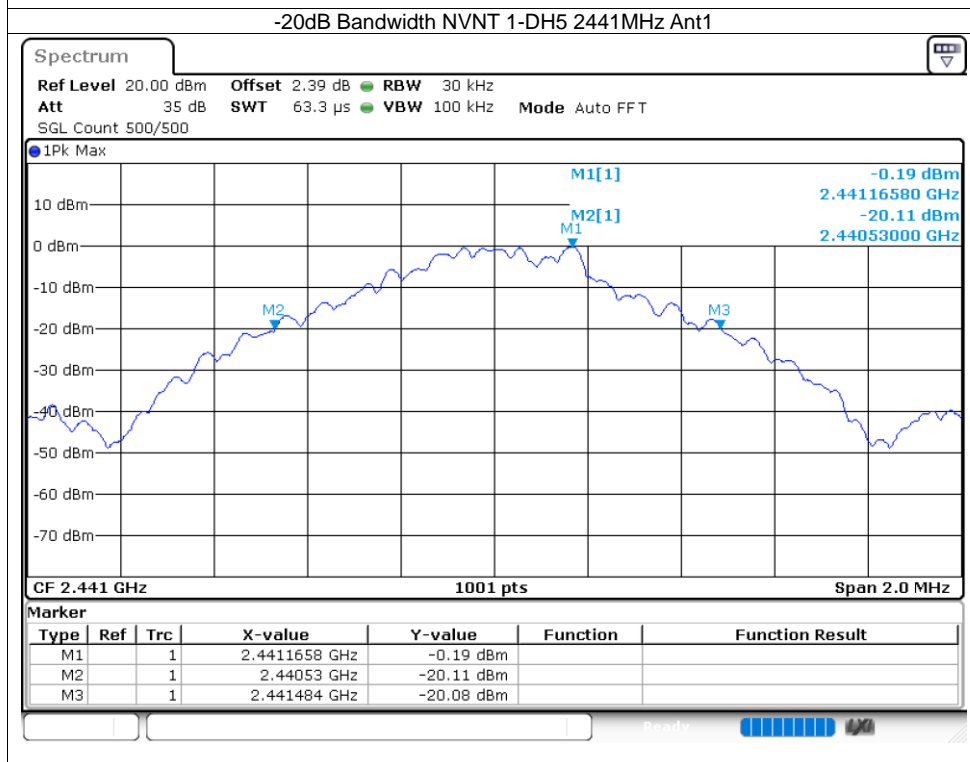
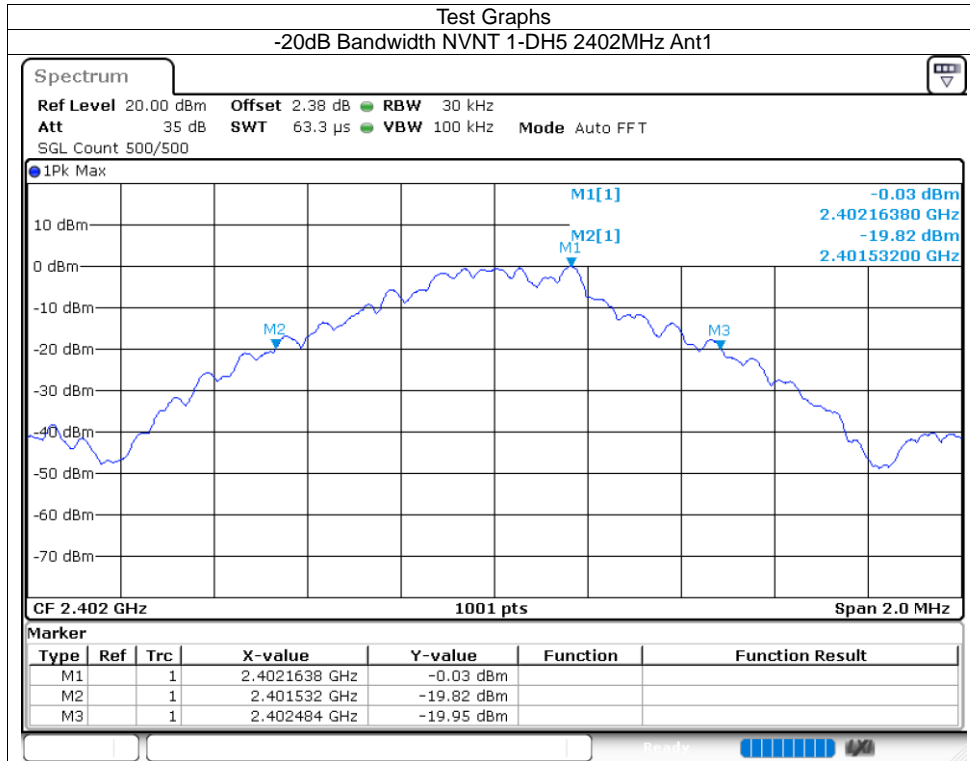

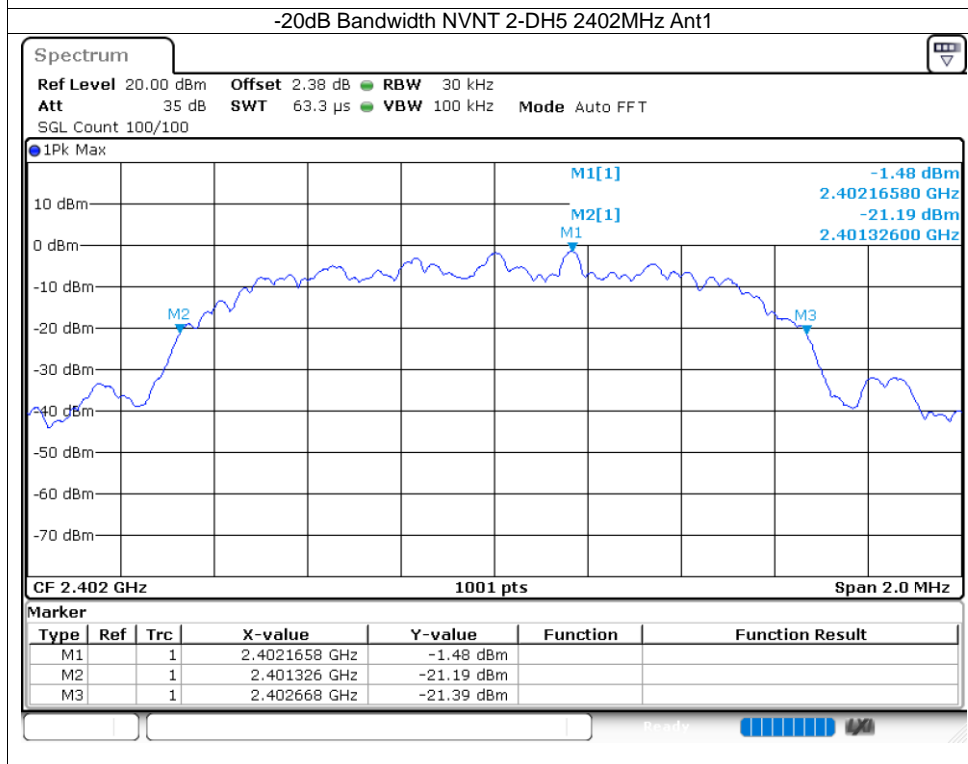
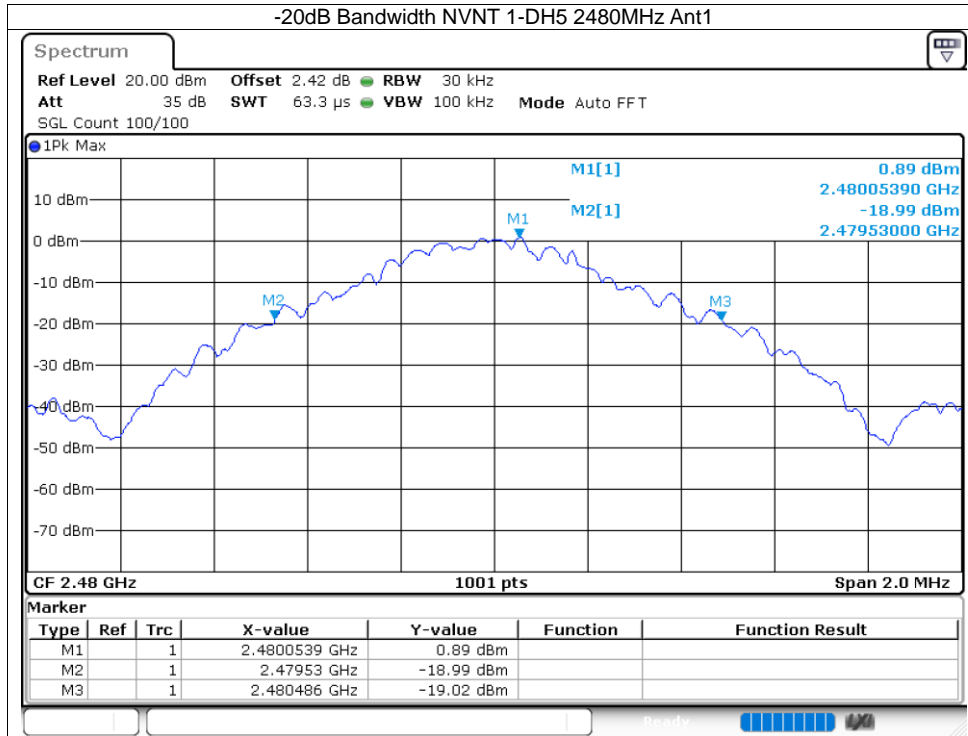

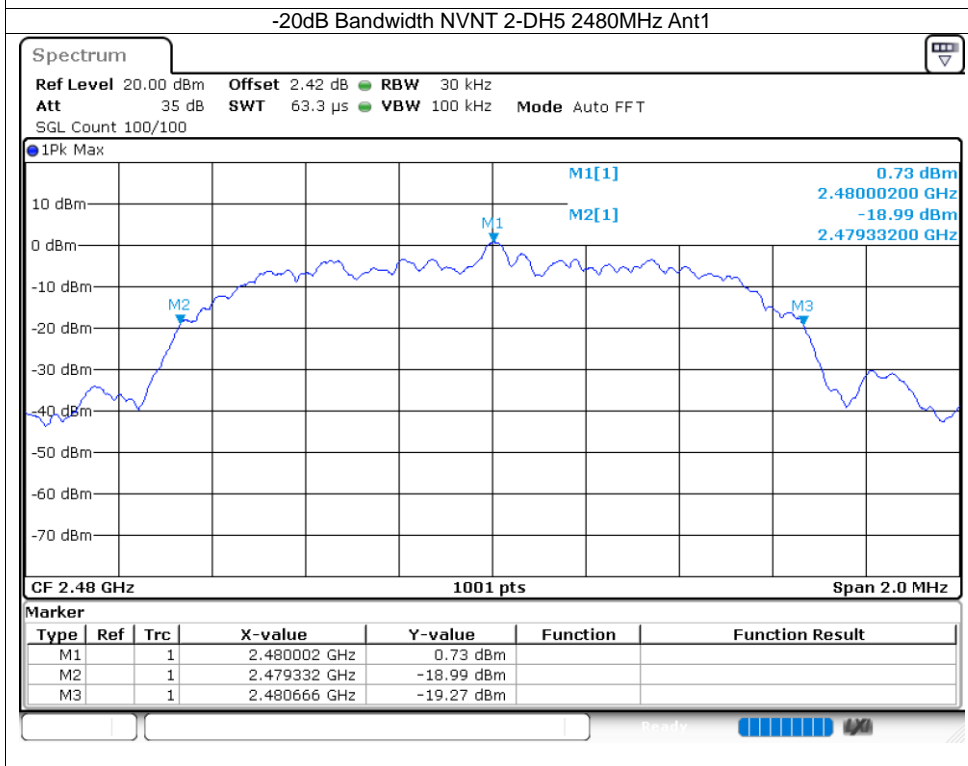
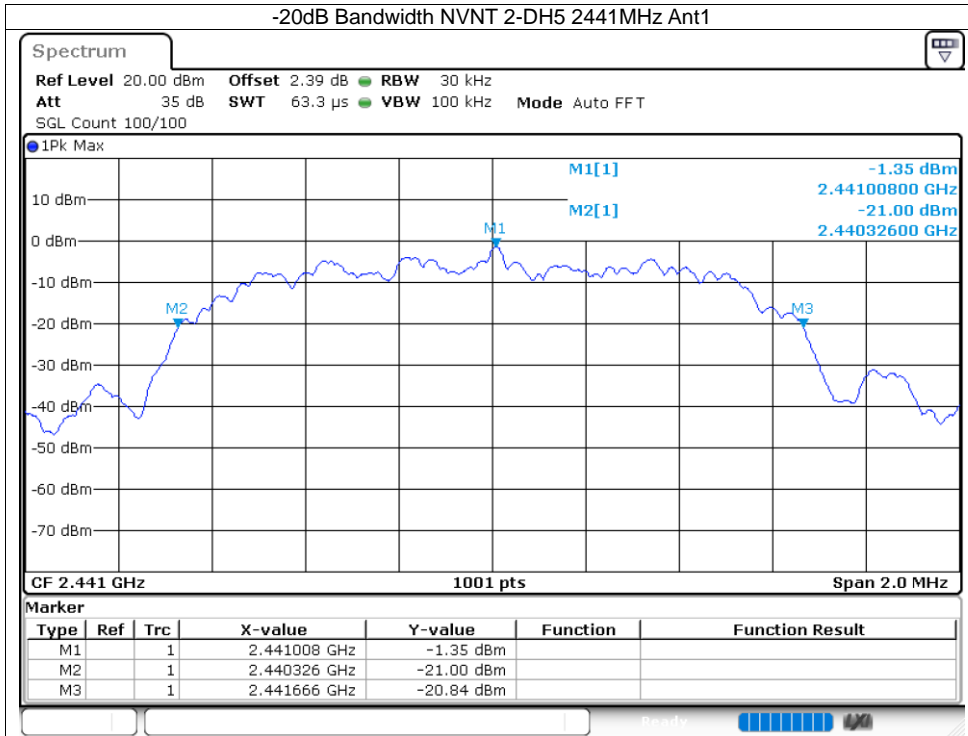

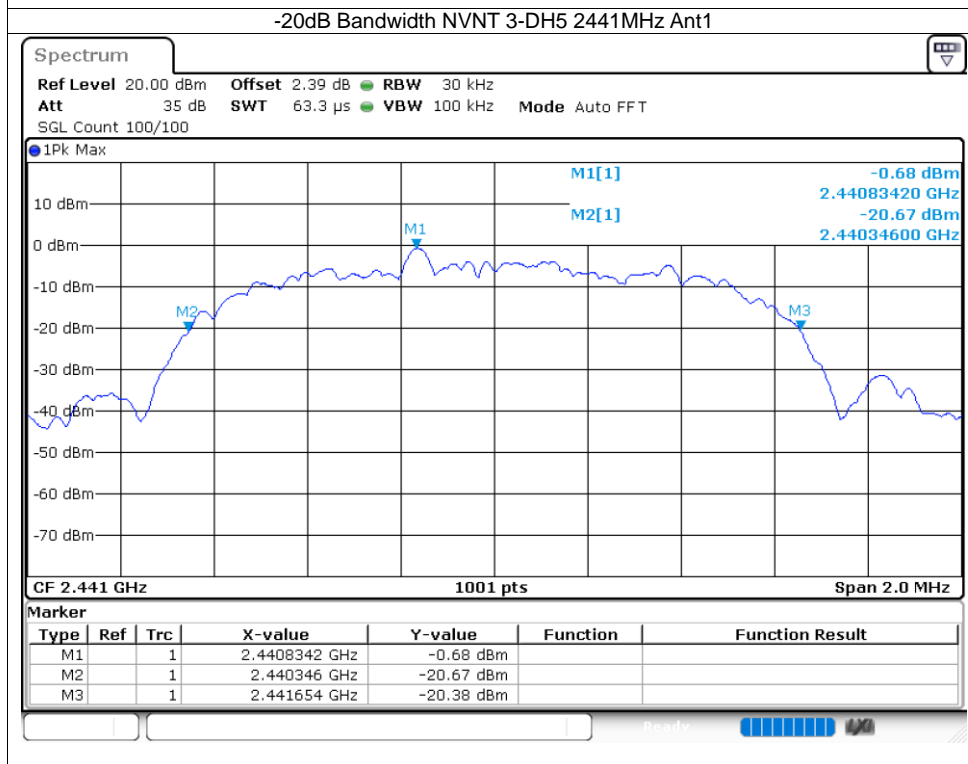
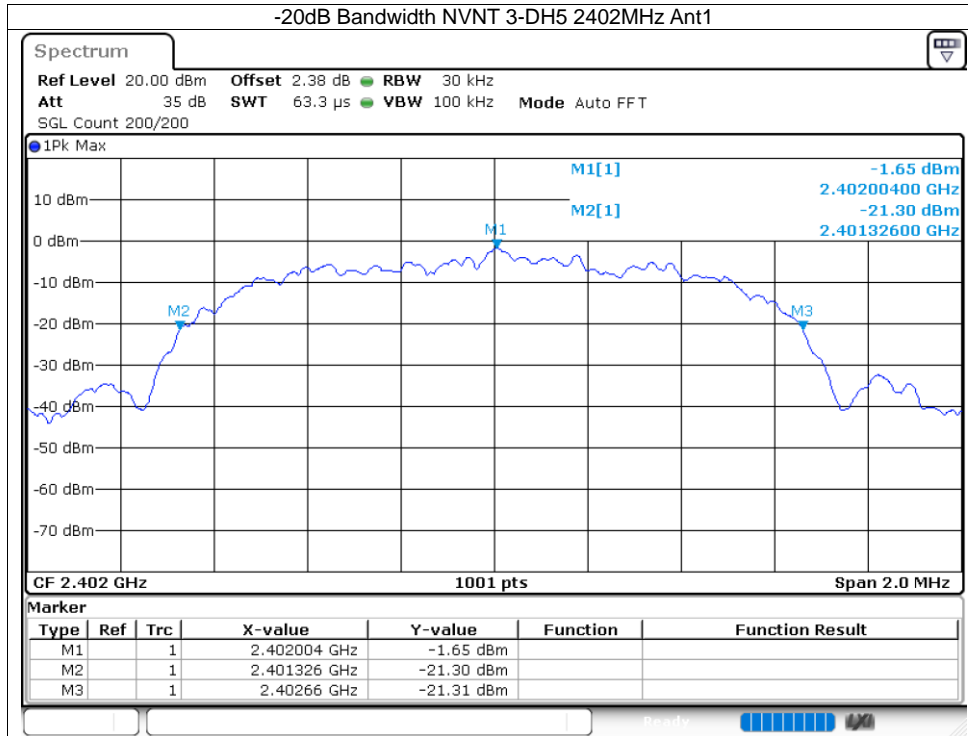

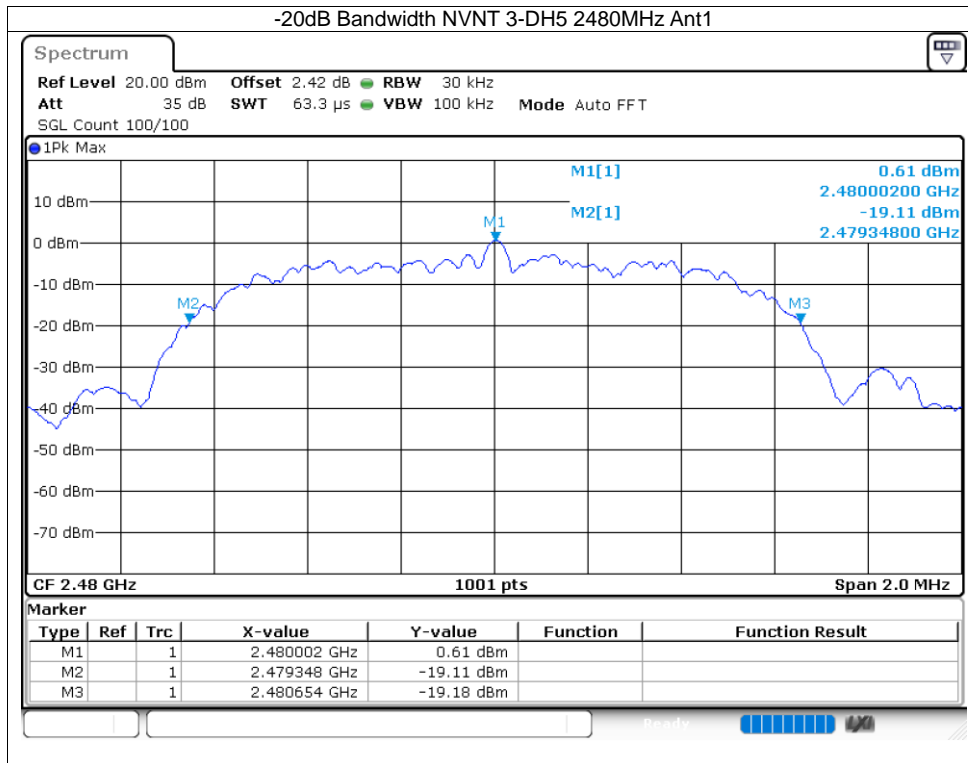

8.4 OCCUPIED CHANNEL BANDWIDTH

| Condition | Mode | Frequency (MHz) | Antenna | 99% OBW (MHz) |
|-----------|-------|-----------------|---------|---------------|
| NVNT | 1-DH5 | 2402 | Ant1 | 0.871 |
| NVNT | 1-DH5 | 2441 | Ant1 | 0.869 |
| NVNT | 1-DH5 | 2480 | Ant1 | 0.871 |
| NVNT | 2-DH5 | 2402 | Ant1 | 1.189 |
| NVNT | 2-DH5 | 2441 | Ant1 | 1.197 |
| NVNT | 2-DH5 | 2480 | Ant1 | 1.207 |
| NVNT | 3-DH5 | 2402 | Ant1 | 1.185 |
| NVNT | 3-DH5 | 2441 | Ant1 | 1.203 |
| NVNT | 3-DH5 | 2480 | Ant1 | 1.185 |

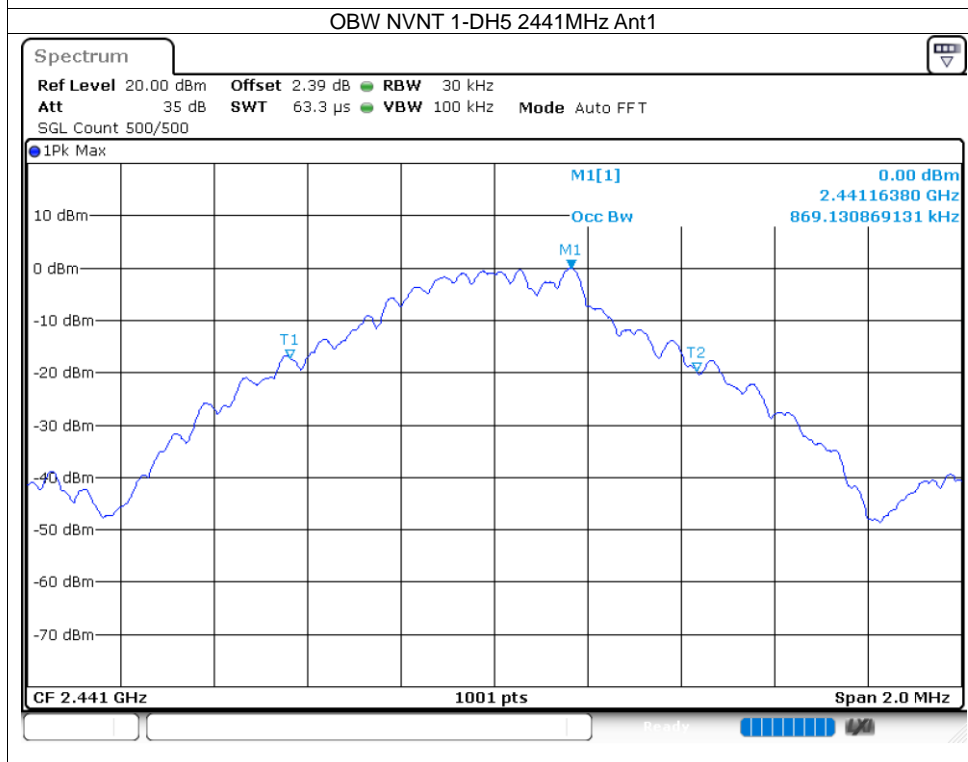
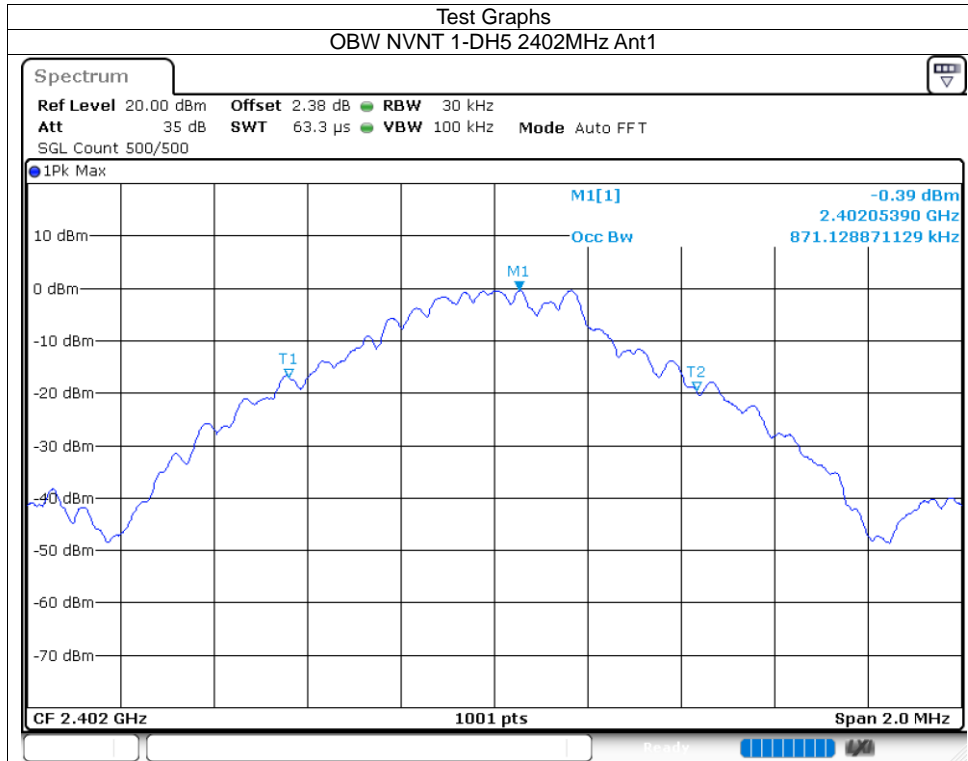

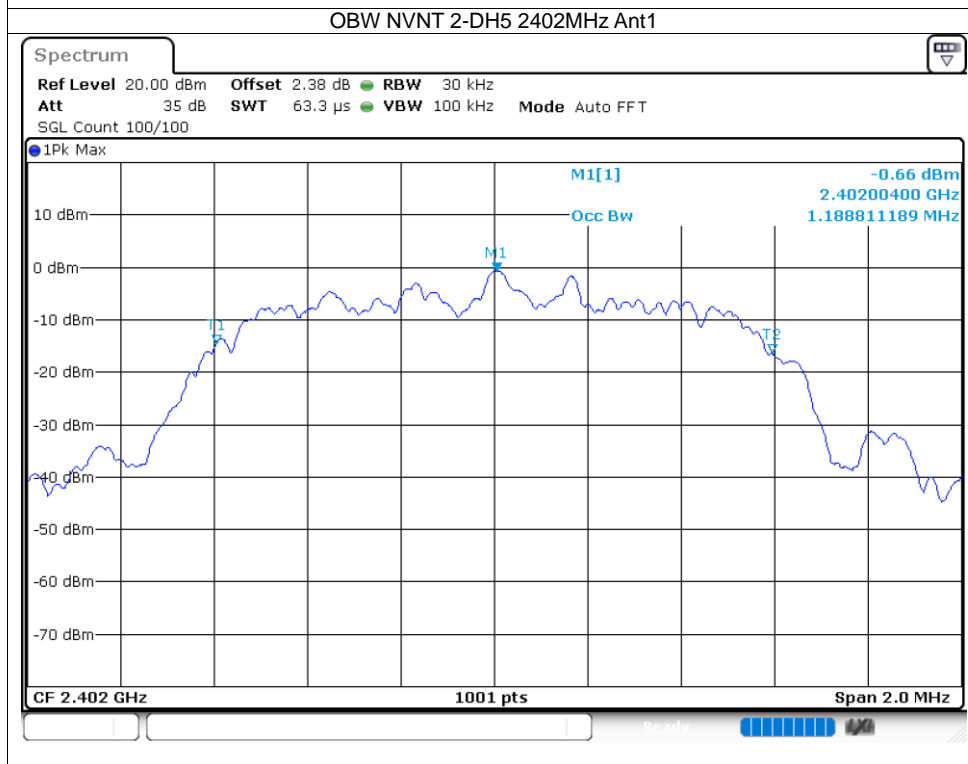
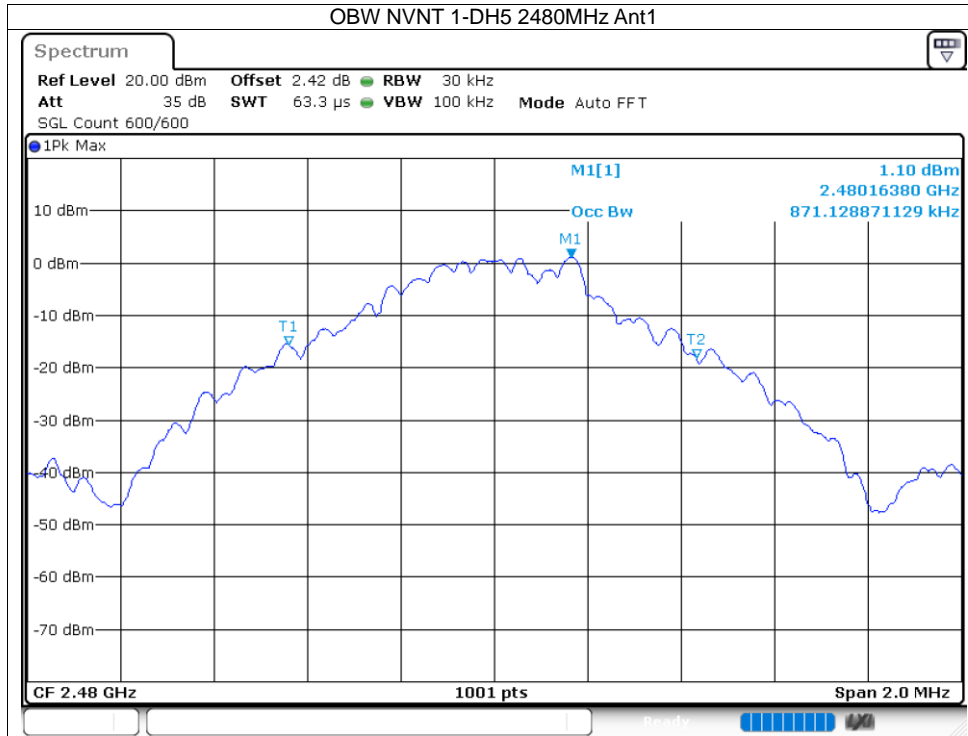

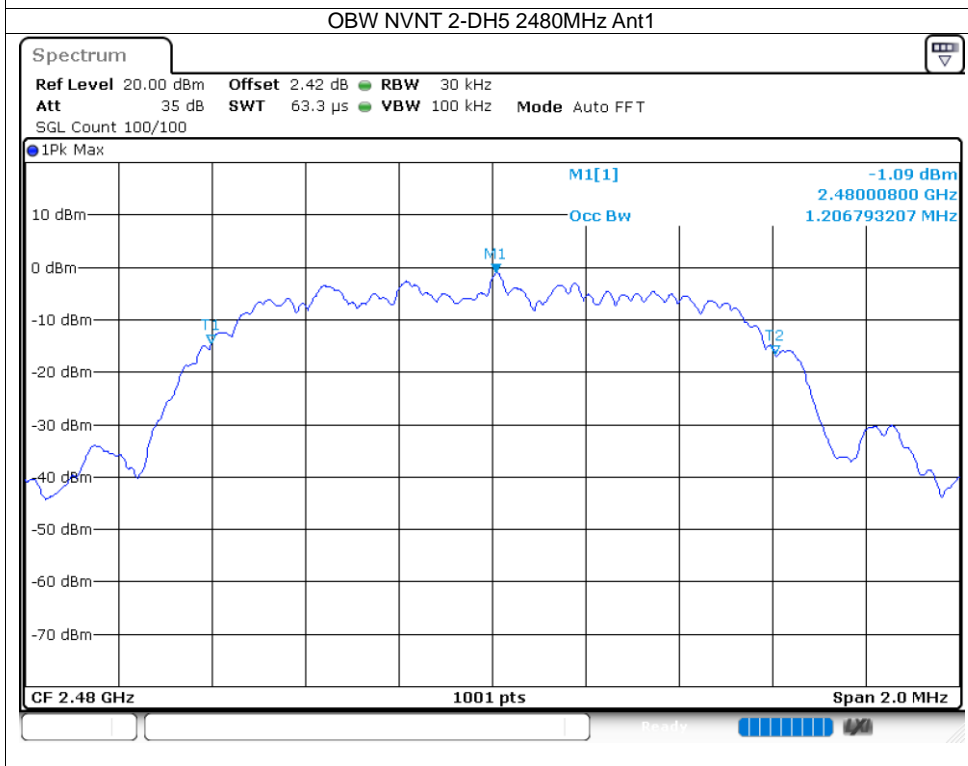
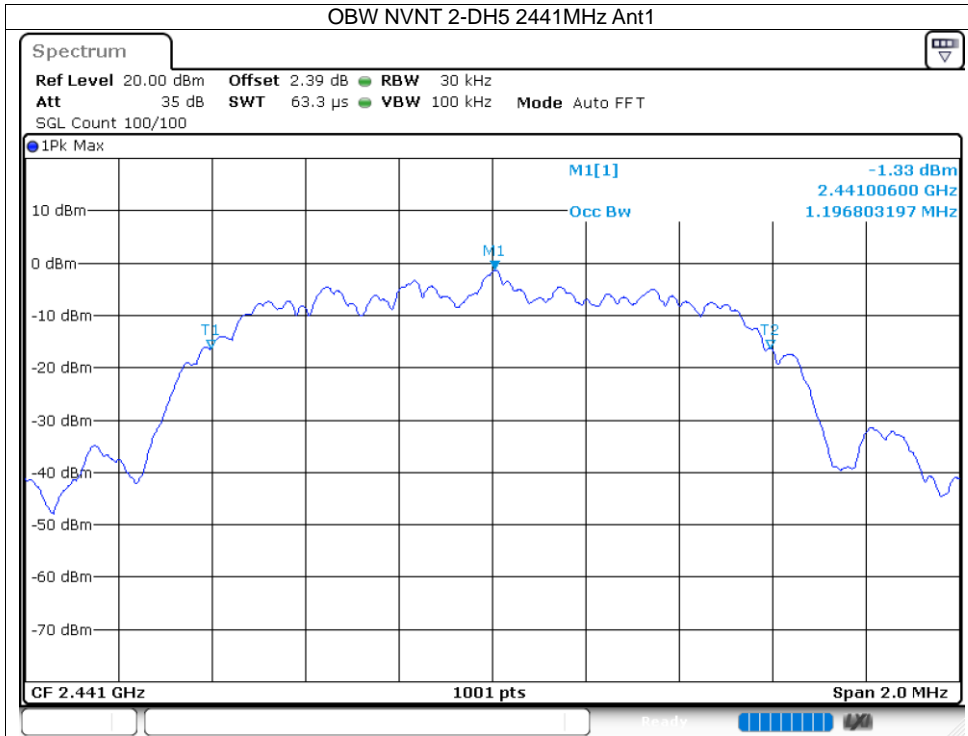

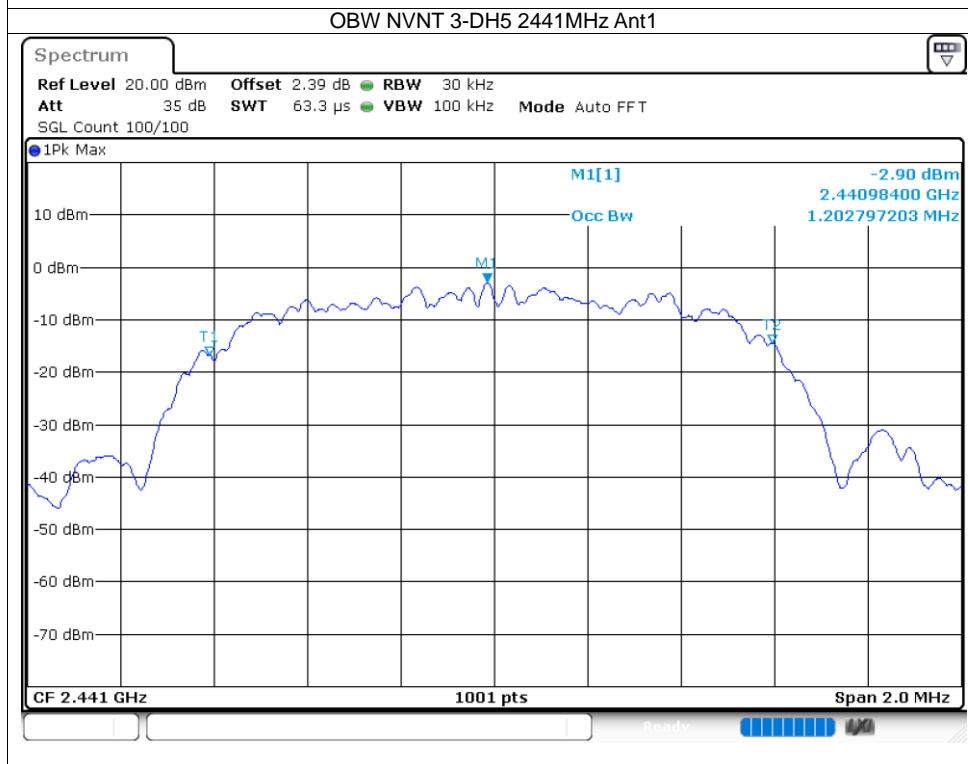
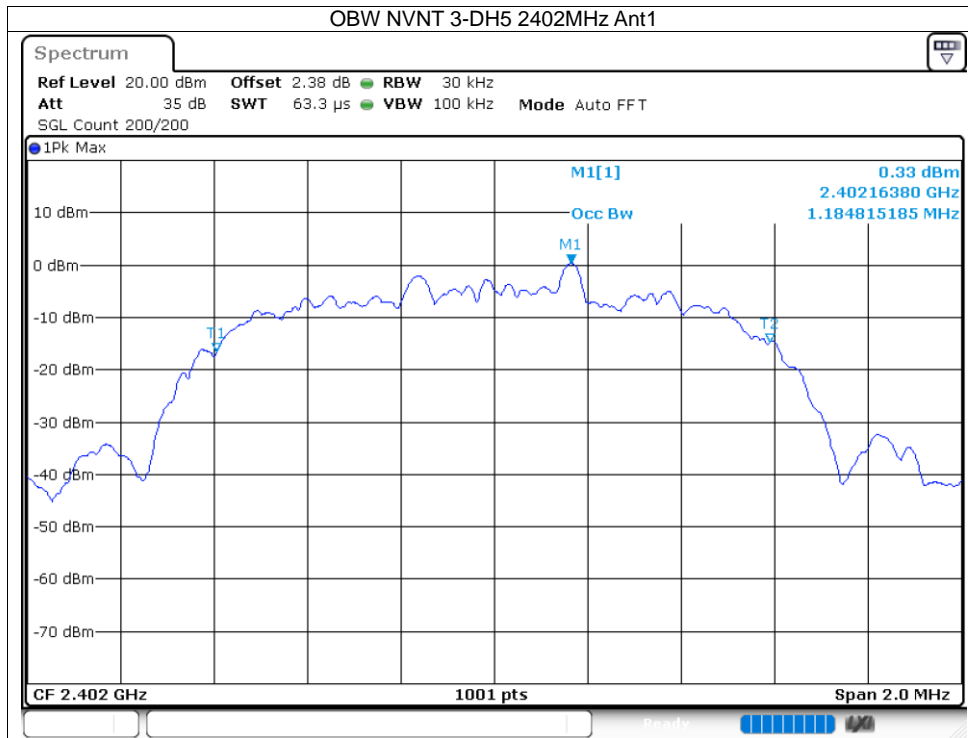

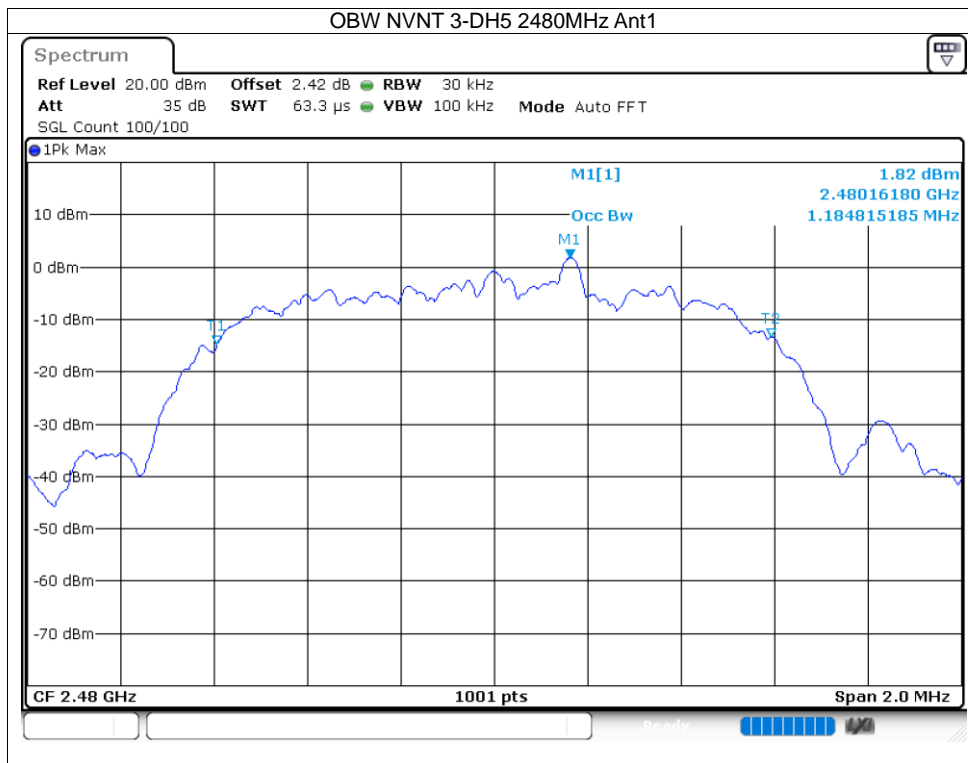

8.5 CARRIER FREQUENCIES SEPARATION

| Condition | Mode | Antenna | Hopping Freq1 (MHz) | Hopping Freq2 (MHz) | HFS (MHz) | Limit (MHz) | Verdict |
|-----------|-------|---------|---------------------|---------------------|-----------|-------------|---------|
| NVNT | 1-DH5 | Ant1 | 2401.976 | 2403.058 | 1.082 | 0.635 | Pass |
| NVNT | 1-DH5 | Ant1 | 2441.002 | 2442.054 | 1.052 | 0.636 | Pass |
| NVNT | 1-DH5 | Ant1 | 2479.054 | 2480.164 | 1.11 | 0.637 | Pass |
| NVNT | 2-DH5 | Ant1 | 2402.008 | 2403.164 | 1.156 | 0.895 | Pass |
| NVNT | 2-DH5 | Ant1 | 2441.002 | 2442.166 | 1.164 | 0.893 | Pass |
| NVNT | 2-DH5 | Ant1 | 2479.164 | 2480.166 | 1.002 | 0.889 | Pass |
| NVNT | 3-DH5 | Ant1 | 2401.992 | 2403.01 | 1.018 | 0.889 | Pass |
| NVNT | 3-DH5 | Ant1 | 2440.975 | 2441.977 | 1.002 | 0.872 | Pass |
| NVNT | 3-DH5 | Ant1 | 2479.162 | 2480.166 | 1.004 | 0.871 | Pass |

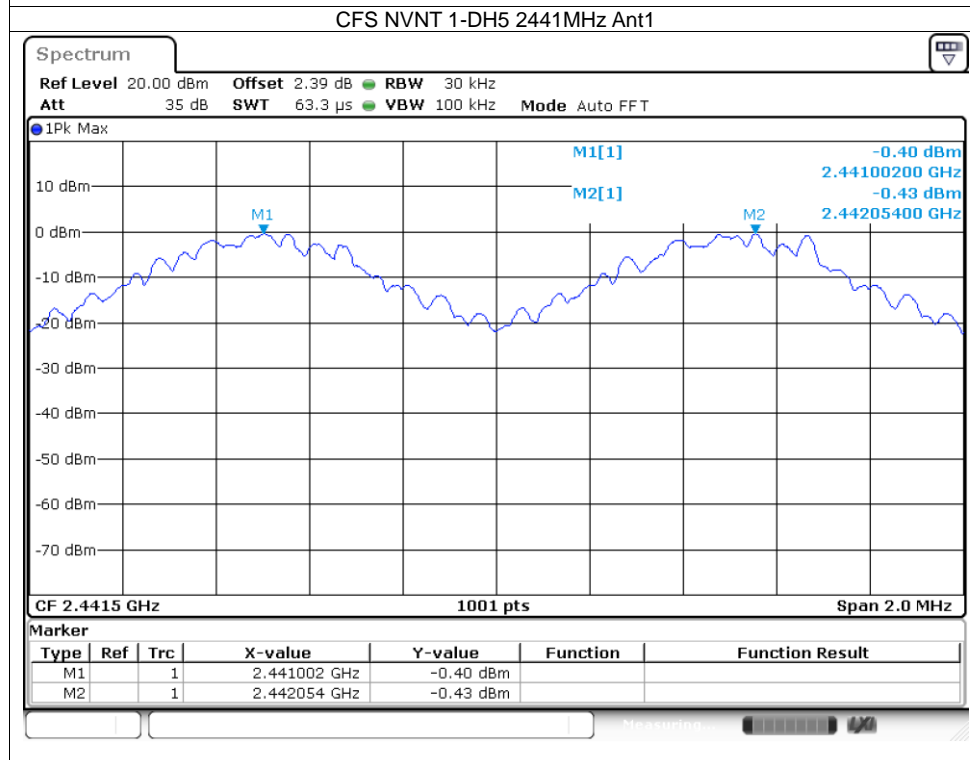
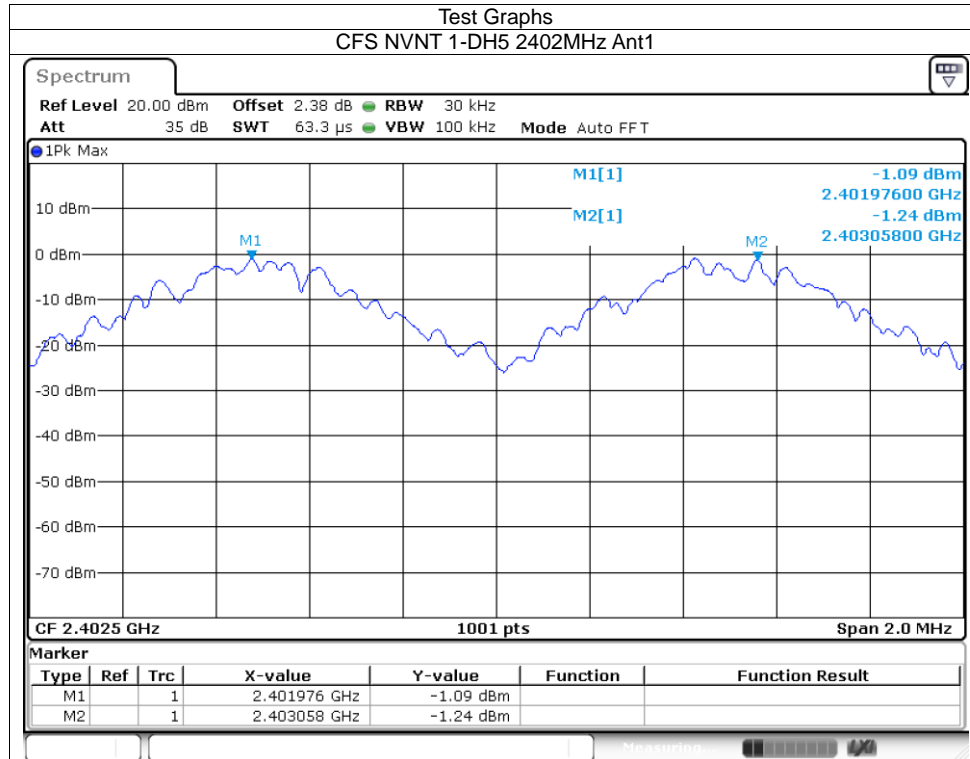

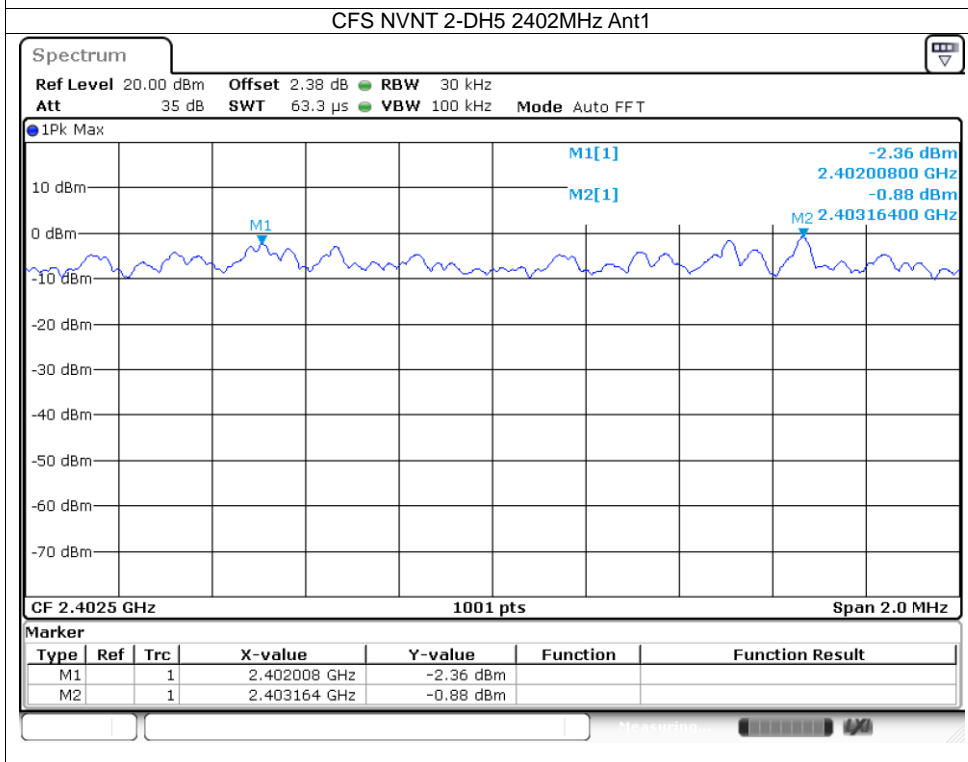
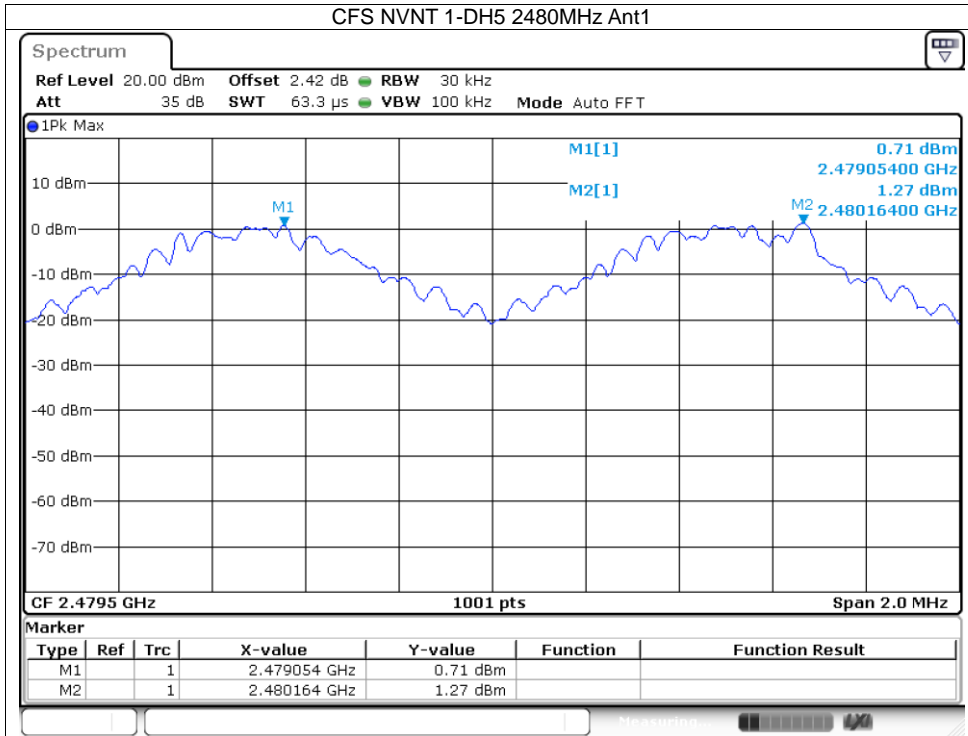

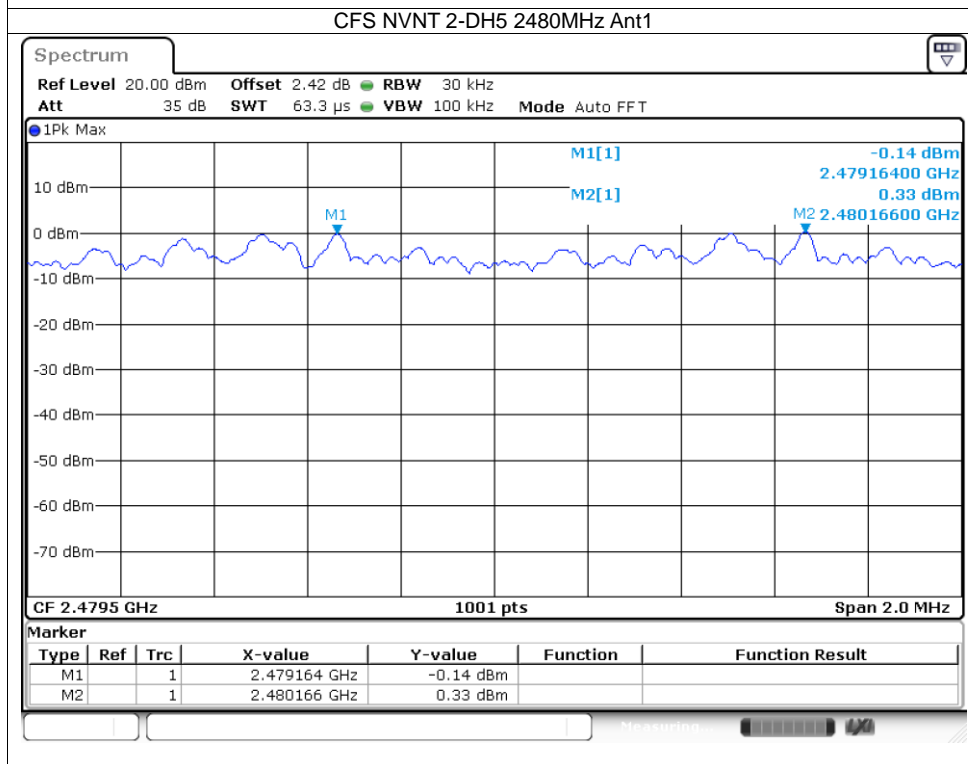
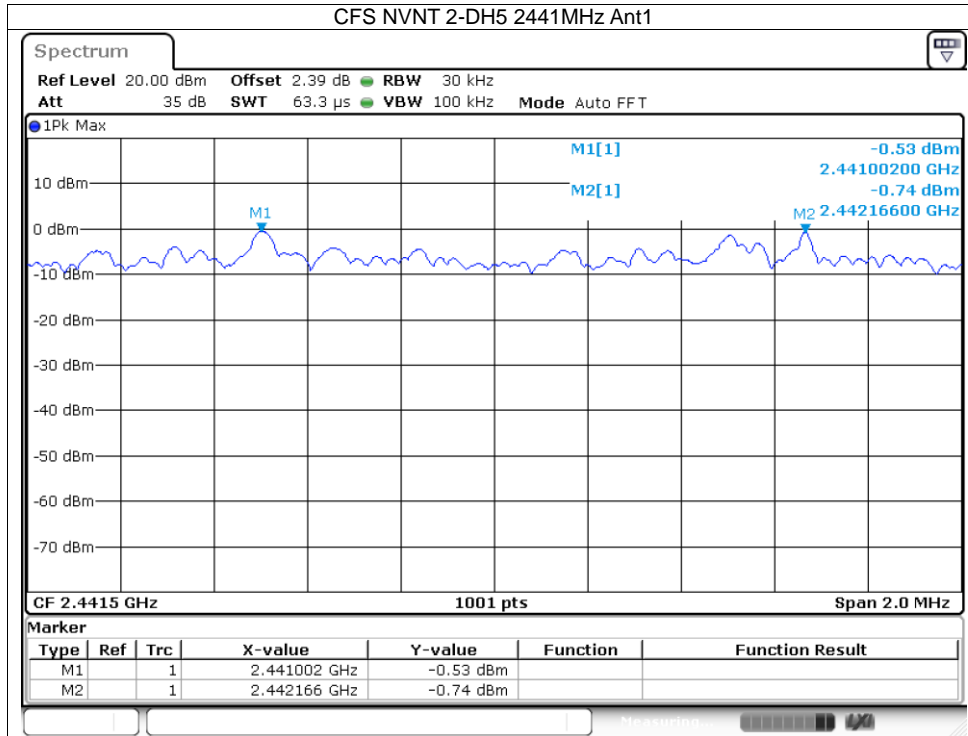

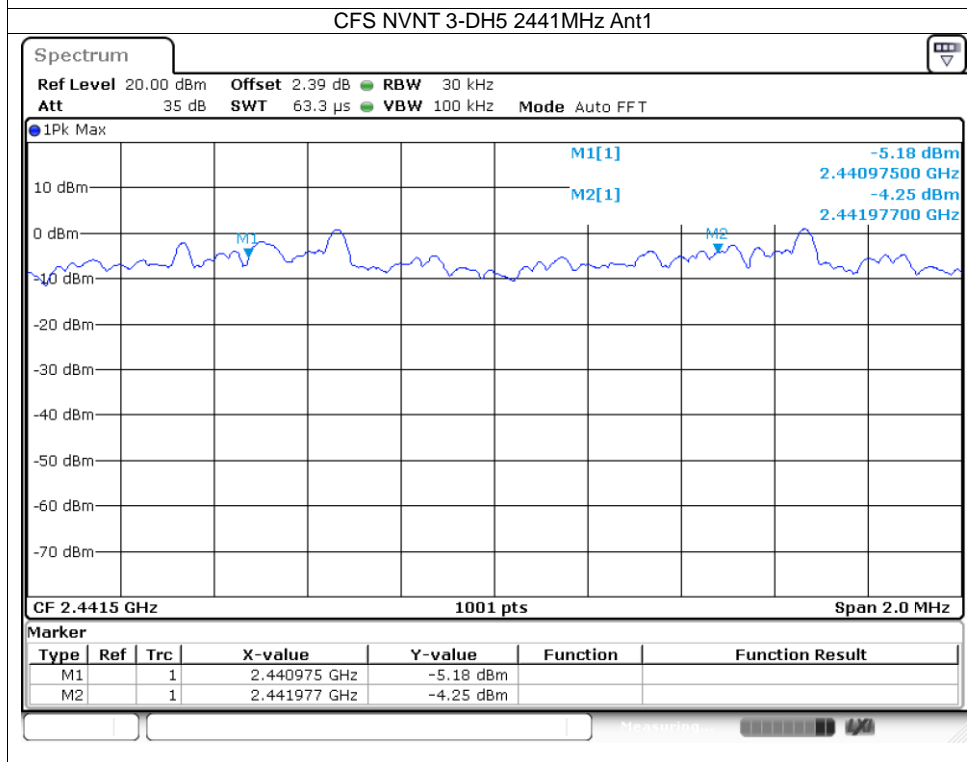
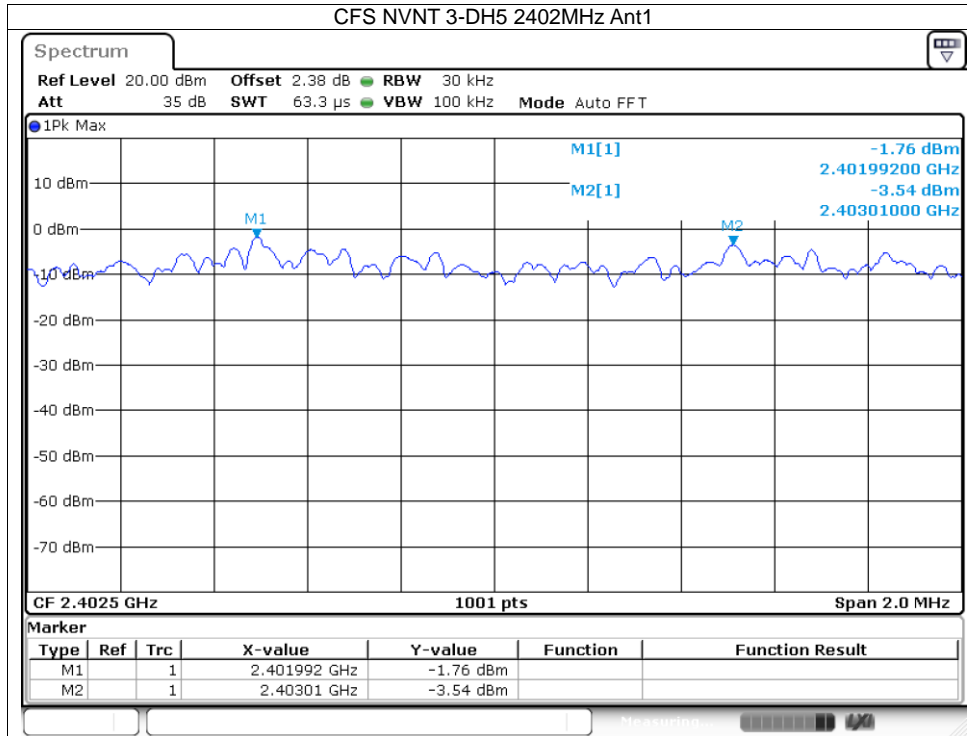

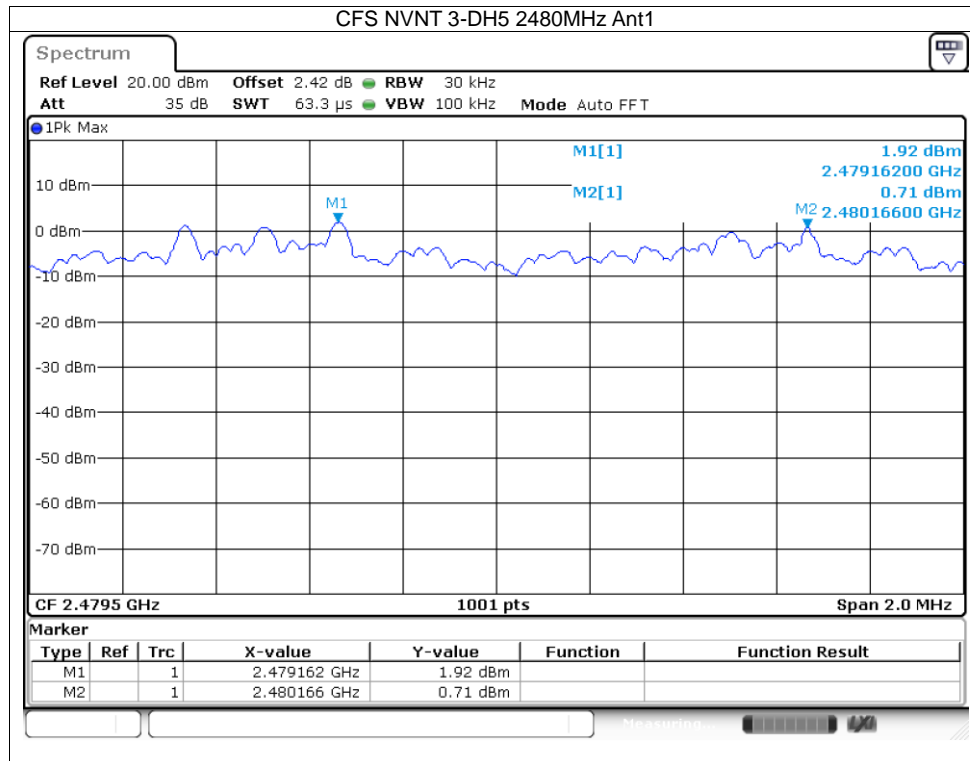

8.6 NUMBER OF HOPPING CHANNEL

| Condition | Mode | Antenna | Hopping Number | Limit | Verdict |
|-----------|-------|---------|----------------|-------|---------|
| NVNT | 1-DH5 | Ant1 | 79 | 15 | Pass |
| NVNT | 2-DH5 | Ant1 | 79 | 15 | Pass |
| NVNT | 3-DH5 | Ant1 | 79 | 15 | Pass |

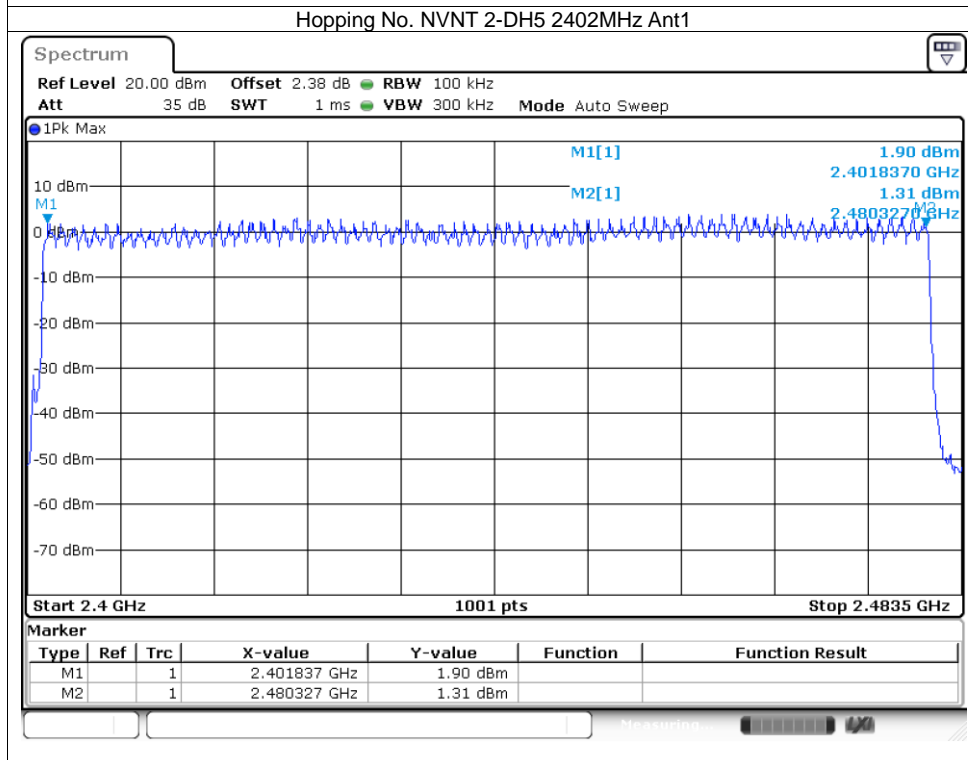
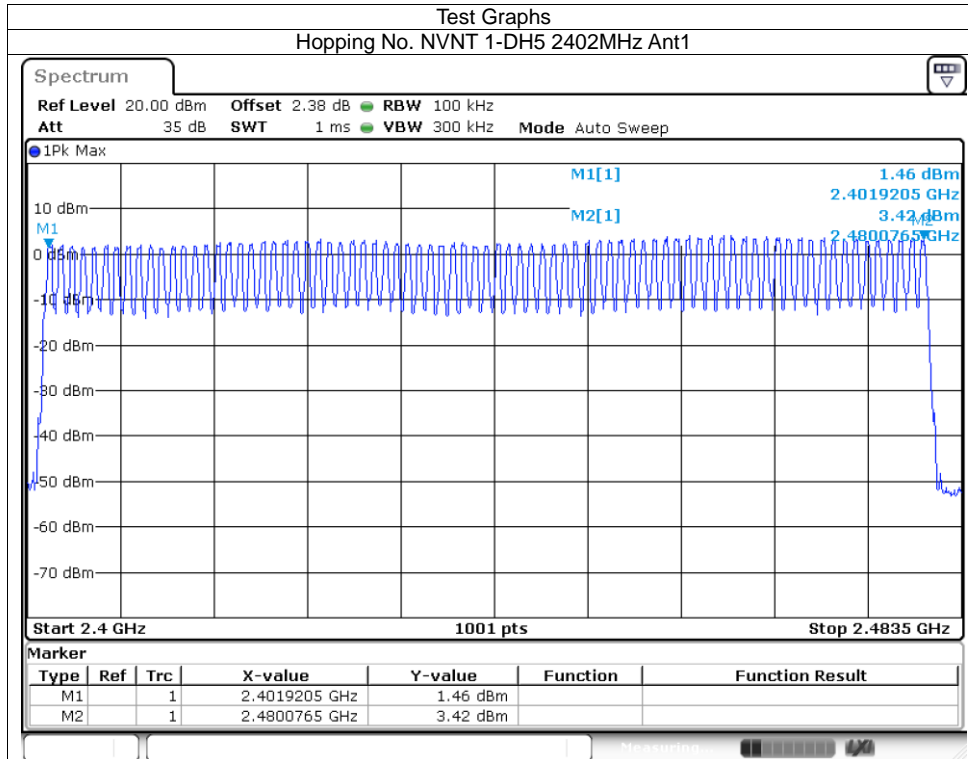

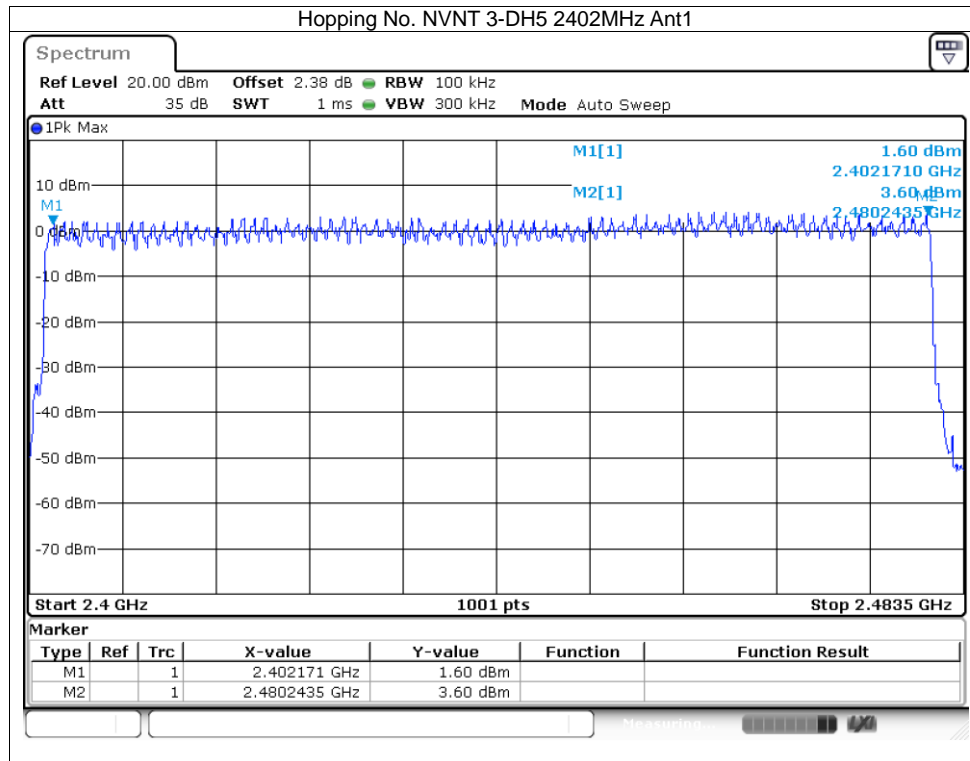

8.7 BAND EDGE

| Condition | Mode | Frequency (MHz) | Antenna | Hopping Mode | Max Value (dBc) | Limit (dBc) | Verdict |
|-----------|-------|-----------------|---------|--------------|-----------------|-------------|---------|
| NVNT | 1-DH5 | 2402 | Ant1 | No-Hopping | -51.67 | -20 | Pass |
| NVNT | 1-DH5 | 2480 | Ant1 | No-Hopping | -56.36 | -20 | Pass |
| NVNT | 2-DH5 | 2402 | Ant1 | No-Hopping | -53.41 | -20 | Pass |
| NVNT | 2-DH5 | 2480 | Ant1 | No-Hopping | -54.01 | -20 | Pass |
| NVNT | 3-DH5 | 2402 | Ant1 | No-Hopping | -53.49 | -20 | Pass |
| NVNT | 3-DH5 | 2480 | Ant1 | No-Hopping | -58.8 | -20 | Pass |

