



Accredited by the Swiss Accreditation Service (SAS)
The Swiss Accreditation Service is one of the signatories to the EA
Multilateral Agreement for the recognition of calibration certificates

Accreditation No.: **SCS 0108**

Client **Eurofins**

Certificate No: **D2450V2-722_Sep15**

CALIBRATION CERTIFICATE

Object **D2450V2 - SN: 722**

Calibration procedure(s) **QA CAL-05.v9**
Calibration procedure for dipole validation kits above 700 MHz

Calibration date: **September 28, 2015**

This calibration certificate documents the traceability to national standards, which realize the physical units of measurements (SI).
The measurements and the uncertainties with confidence probability are given on the following pages and are part of the certificate.

All calibrations have been conducted in the closed laboratory facility: environment temperature (22 ± 3)°C and humidity < 70%.

Calibration Equipment used (M&TE critical for calibration)

Primary Standards	ID #	Cal Date (Certificate No.)	Scheduled Calibration
Power meter EPM-442A	GB37480704	07-Oct-14 (No. 217-02020)	Oct-15
Power sensor HP 8481A	US37292783	07-Oct-14 (No. 217-02020)	Oct-15
Power sensor HP 8481A	MY41092317	07-Oct-14 (No. 217-02021)	Oct-15
Reference 20 dB Attenuator	SN: 5058 (20k)	01-Apr-15 (No. 217-02131)	Mar-16
Type-N mismatch combination	SN: 5047.2 / 06327	01-Apr-15 (No. 217-02134)	Mar-16
Reference Probe EX3DV4	SN: 7349	30-Dec-14 (No. EX3-7349_Dec14)	Dec-15
DAE4	SN: 601	17-Aug-15 (No. DAE4-601_Aug15)	Aug-16
Secondary Standards	ID #	Check Date (in house)	Scheduled Check
RF generator R&S SMT-06	100972	15-Jun-15 (in house check Jun-15)	In house check: Jun-18
Network Analyzer HP 8753E	US37390585 S4206	18-Oct-01 (in house check Oct-14)	In house check: Oct-15

Calibrated by: **Jeton Kastrati** Function: **Laboratory Technician** Signature:

Approved by: **Katja Pokovic** Technical Manager

Issued: September 28, 2015

This calibration certificate shall not be reproduced except in full without written approval of the laboratory.



Accredited by the Swiss Accreditation Service (SAS)

Accreditation No.: SCS 0108

The Swiss Accreditation Service is one of the signatories to the EA
Multilateral Agreement for the recognition of calibration certificates

Glossary:

TSL	tissue simulating liquid
ConvF	sensitivity in TSL / NORM x,y,z
N/A	not applicable or not measured

Calibration is Performed According to the Following Standards:

- IEEE Std 1528-2013, "IEEE Recommended Practice for Determining the Peak Spatial-Averaged Specific Absorption Rate (SAR) in the Human Head from Wireless Communications Devices: Measurement Techniques", June 2013
- IEC 62209-1, "Procedure to measure the Specific Absorption Rate (SAR) for hand-held devices used in close proximity to the ear (frequency range of 300 MHz to 3 GHz)", February 2005
- IEC 62209-2, "Procedure to determine the Specific Absorption Rate (SAR) for wireless communication devices used in close proximity to the human body (frequency range of 30 MHz to 6 GHz)", March 2010
- KDB 865664, "SAR Measurement Requirements for 100 MHz to 6 GHz"

Additional Documentation:

- DASY4/5 System Handbook

Methods Applied and Interpretation of Parameters:

- Measurement Conditions:* Further details are available from the Validation Report at the end of the certificate. All figures stated in the certificate are valid at the frequency indicated.
- Antenna Parameters with TSL:* The dipole is mounted with the spacer to position its feed point exactly below the center marking of the flat phantom section, with the arms oriented parallel to the body axis.
- Feed Point Impedance and Return Loss:* These parameters are measured with the dipole positioned under the liquid filled phantom. The impedance stated is transformed from the measurement at the SMA connector to the feed point. The Return Loss ensures low reflected power. No uncertainty required.
- Electrical Delay:* One-way delay between the SMA connector and the antenna feed point. No uncertainty required.
- SAR measured:* SAR measured at the stated antenna input power.
- SAR normalized:* SAR as measured, normalized to an input power of 1 W at the antenna connector.
- SAR for nominal TSL parameters:* The measured TSL parameters are used to calculate the nominal SAR result.

The reported uncertainty of measurement is stated as the standard uncertainty of measurement multiplied by the coverage factor $k=2$, which for a normal distribution corresponds to a coverage probability of approximately 95%.

Measurement Conditions

DASY system configuration, as far as not given on page 1.

DASY Version	DASY5	V52.8.8
Extrapolation	Advanced Extrapolation	
Phantom	Modular Flat Phantom	
Distance Dipole Center - TSL	10 mm	with Spacer
Zoom Scan Resolution	dx, dy, dz = 5 mm	
Frequency	2450 MHz \pm 1 MHz	

Head TSL parameters

The following parameters and calculations were applied.

	Temperature	Permittivity	Conductivity
Nominal Head TSL parameters	22.0 °C	39.2	1.80 mho/m
Measured Head TSL parameters	(22.0 \pm 0.2) °C	39.2 \pm 6 %	1.86 mho/m \pm 6 %
Head TSL temperature change during test	< 0.5 °C	----	----

SAR result with Head TSL

SAR averaged over 1 cm ³ (1 g) of Head TSL	Condition	
SAR measured	250 mW input power	12.7 W/kg
SAR for nominal Head TSL parameters	normalized to 1W	50.0 W/kg \pm 17.0 % (k=2)

SAR averaged over 10 cm ³ (10 g) of Head TSL	condition	
SAR measured	250 mW input power	5.90 W/kg
SAR for nominal Head TSL parameters	normalized to 1W	23.4 W/kg \pm 16.5 % (k=2)

Body TSL parameters

The following parameters and calculations were applied.

	Temperature	Permittivity	Conductivity
Nominal Body TSL parameters	22.0 °C	52.7	1.95 mho/m
Measured Body TSL parameters	(22.0 \pm 0.2) °C	53.2 \pm 6 %	2.00 mho/m \pm 6 %
Body TSL temperature change during test	< 0.5 °C	----	----

SAR result with Body TSL

SAR averaged over 1 cm ³ (1 g) of Body TSL	Condition	
SAR measured	250 mW input power	12.5 W/kg
SAR for nominal Body TSL parameters	normalized to 1W	49.5 W/kg \pm 17.0 % (k=2)

SAR averaged over 10 cm ³ (10 g) of Body TSL	condition	
SAR measured	250 mW input power	5.88 W/kg
SAR for nominal Body TSL parameters	normalized to 1W	23.4 W/kg \pm 16.5 % (k=2)

Appendix (Additional assessments outside the scope of SCS 0108)

Antenna Parameters with Head TSL

Impedance, transformed to feed point	51.7 Ω + 9.2 j Ω
Return Loss	- 20.8 dB

Antenna Parameters with Body TSL

Impedance, transformed to feed point	46.3 Ω + 8.6 j Ω
Return Loss	- 20.2 dB

General Antenna Parameters and Design

Electrical Delay (one direction)	1.152 ns
----------------------------------	----------

After long term use with 100W radiated power, only a slight warming of the dipole near the feedpoint can be measured.

The dipole is made of standard semirigid coaxial cable. The center conductor of the feeding line is directly connected to the second arm of the dipole. The antenna is therefore short-circuited for DC-signals. On some of the dipoles, small end caps are added to the dipole arms in order to improve matching when loaded according to the position as explained in the "Measurement Conditions" paragraph. The SAR data are not affected by this change. The overall dipole length is still according to the Standard.

No excessive force must be applied to the dipole arms, because they might bend or the soldered connections near the feedpoint may be damaged.

Additional EUT Data

Manufactured by	SPEAG
Manufactured on	October 16, 2002

DASY5 Validation Report for Head TSL

Date: 28.09.2015

Test Laboratory: SPEAG, Zurich, Switzerland

DUT: Dipole 2450 MHz ; Type: D2450V2; Serial: D2450V2 - SN: 722

Communication System: UID 0 - CW; Frequency: 2450 MHz

Medium parameters used: $f = 2450$ MHz; $\sigma = 1.86$ S/m; $\epsilon_r = 39.2$; $\rho = 1000$ kg/m³

Phantom section: Flat Section

Measurement Standard: DASY5 (IEEE/IEC/ANSI C63.19-2011)

DASY52 Configuration:

- Probe: EX3DV4 - SN7349; ConvF(7.67, 7.67, 7.67); Calibrated: 30.12.2014;
- Sensor-Surface: 1.4mm (Mechanical Surface Detection)
- Electronics: DAE4 Sn601; Calibrated: 17.08.2015
- Phantom: Flat Phantom 5.0 (front); Type: QD000P50AA; Serial: 1001
- DASY52 52.8.8(1222); SEMCAD X 14.6.10(7331)

Dipole Calibration for Head Tissue/Pin=250 mW, d=10mm/Zoom Scan (7x7x7)/Cube 0:

Measurement grid: dx=5mm, dy=5mm, dz=5mm

Reference Value = 111.4 V/m; Power Drift = 0.00 dB

Peak SAR (extrapolated) = 26.1 W/kg

SAR(1 g) = 12.7 W/kg; SAR(10 g) = 5.9 W/kg

Maximum value of SAR (measured) = 21.1 W/kg

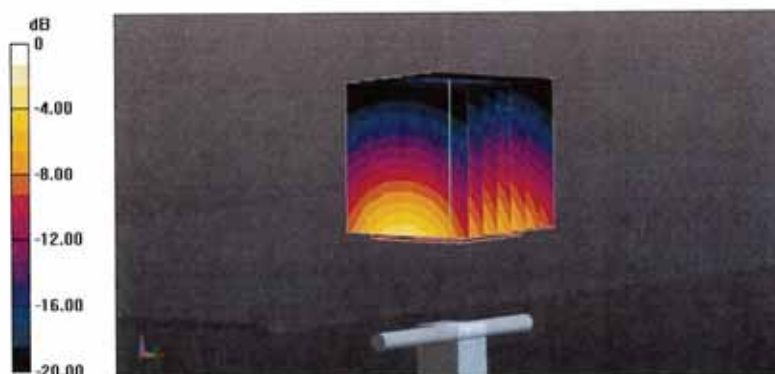

0 dB = 21.1 W/kg = 13.24 dBW/kg

Impedance Measurement Plot for Head TSL

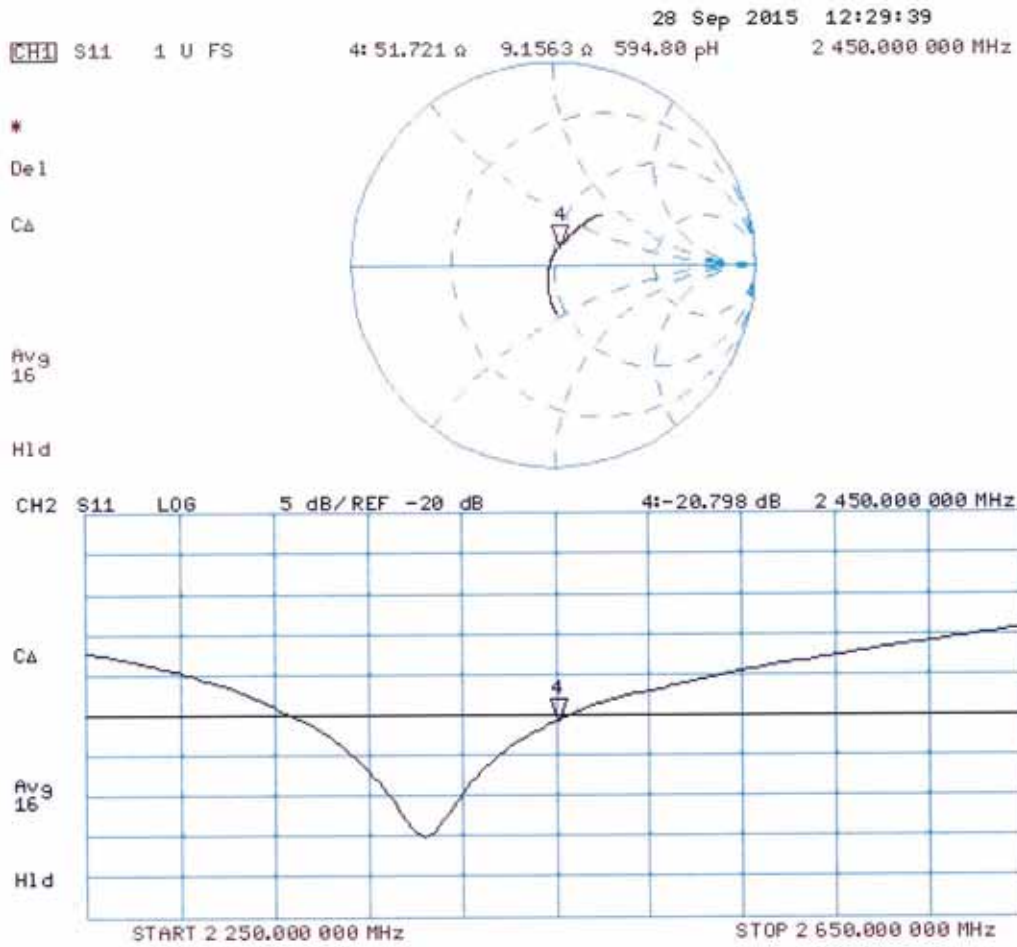

DASY5 Validation Report for Body TSL

Date: 28.09.2015

Test Laboratory: SPEAG, Zurich, Switzerland

DUT: Dipole 2450 MHz ; Type: D2450V2; Serial: D2450V2 - SN: 722

Communication System: UID 0 - CW; Frequency: 2450 MHz

Medium parameters used: $f = 2450$ MHz; $\sigma = 2$ S/m; $\epsilon_r = 53.2$; $\rho = 1000$ kg/m³

Phantom section: Flat Section

Measurement Standard: DASY5 (IEEE/IEC/ANSI C63.19-2011)

DASY52 Configuration:

- Probe: EX3DV4 - SN7349; ConvF(7.53, 7.53, 7.53); Calibrated: 30.12.2014;
- Sensor-Surface: 1.4mm (Mechanical Surface Detection)
- Electronics: DAE4 Sn601; Calibrated: 17.08.2015
- Phantom: Flat Phantom 5.0 (back); Type: QD000P50AA; Serial: 1002
- DASY52 52.8.8(1222); SEMCAD X 14.6.10(7331)

Dipole Calibration for Body Tissue/Pin=250 mW, d=10mm/Zoom Scan (7x7x7)/Cube 0:

Measurement grid: dx=5mm, dy=5mm, dz=5mm

Reference Value = 105.8 V/m; Power Drift = -0.01 dB

Peak SAR (extrapolated) = 24.7 W/kg

SAR(1 g) = 12.5 W/kg; SAR(10 g) = 5.88 W/kg

Maximum value of SAR (measured) = 20.5 W/kg

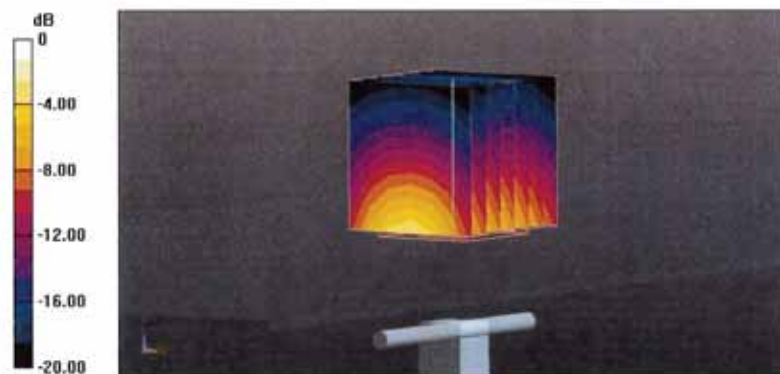

0 dB = 20.5 W/kg = 13.12 dBW/kg

Impedance Measurement Plot for Body TSL

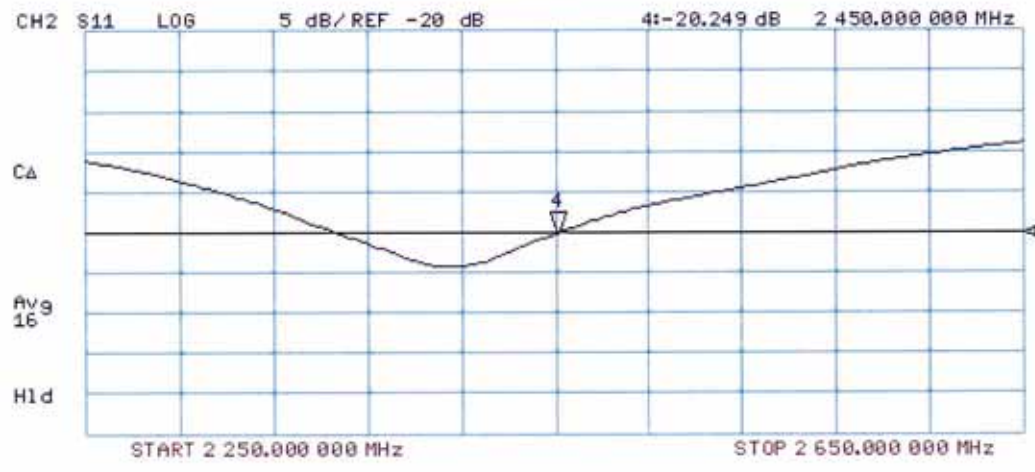
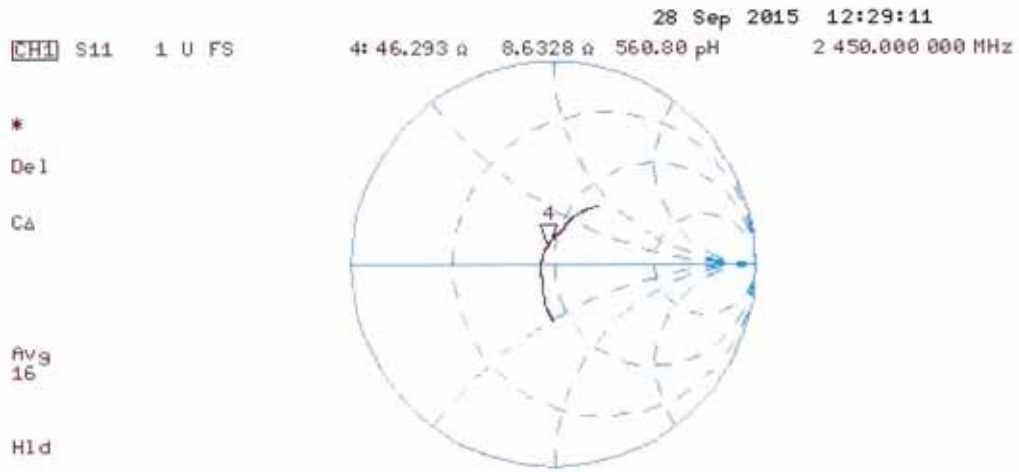



Accredited by the Swiss Accreditation Service (SAS)
The Swiss Accreditation Service is one of the signatories to the EA
Multilateral Agreement for the recognition of calibration certificates

Accreditation No.: SCS 0108

Client Eurofins

Certificate No: DAE3-522_Sep16

CALIBRATION CERTIFICATE

Object DAE3 - SD 000 D03 AA - SN: 522

Calibration procedure(s) QA CAL-06.v29
Calibration procedure for the data acquisition electronics (DAE)

Calibration date: September 28, 2016

This calibration certificate documents the traceability to national standards, which realize the physical units of measurements (SI).
The measurements and the uncertainties with confidence probability are given on the following pages and are part of the certificate.

All calibrations have been conducted in the closed laboratory facility: environment temperature $(22 \pm 3)^\circ\text{C}$ and humidity $< 70\%$.

Calibration Equipment used (M&TE critical for calibration)

Primary Standards	ID #	Cal Date (Certificate No.)	Scheduled Calibration
Keithley Multimeter Type 2001	SN: 0810278	09-Sep-16 (No:19065)	Sep-17
Secondary Standards	ID #	Check Date (in house)	Scheduled Check
Auto DAE Calibration Unit	SE UWS 053 AA 1001	05-Jan-16 (in house check)	In house check: Jan-17
Calibrator Box V2.1	SE UMS 006 AA 1002	05-Jan-16 (in house check)	In house check: Jan-17

Calibrated by:	Name Eric Hainfeld	Function Technician	Signature
Approved by:	Fin Bornholt	Deputy Technical Manager	

Issued: September 28, 2016

This calibration certificate shall not be reproduced except in full without written approval of the laboratory.



Accredited by the Swiss Accreditation Service (SAS)

The Swiss Accreditation Service is one of the signatories to the EA Multilateral Agreement for the recognition of calibration certificates

Accreditation No.: **SCS 0108**

Glossary

DAE	data acquisition electronics
Connector angle	information used in DASY system to align probe sensor X to the robot coordinate system.

Methods Applied and Interpretation of Parameters

- *DC Voltage Measurement:* Calibration Factor assessed for use in DASY system by comparison with a calibrated instrument traceable to national standards. The figure given corresponds to the full scale range of the voltmeter in the respective range.
- *Connector angle:* The angle of the connector is assessed measuring the angle mechanically by a tool inserted. Uncertainty is not required.
- The following parameters as documented in the Appendix contain technical information as a result from the performance test and require no uncertainty.
 - *DC Voltage Measurement Linearity:* Verification of the Linearity at +10% and -10% of the nominal calibration voltage. Influence of offset voltage is included in this measurement.
 - *Common mode sensitivity:* Influence of a positive or negative common mode voltage on the differential measurement.
 - *Channel separation:* Influence of a voltage on the neighbor channels not subject to an input voltage.
 - *AD Converter Values with inputs shorted:* Values on the internal AD converter corresponding to zero input voltage
 - *Input Offset Measurement:* Output voltage and statistical results over a large number of zero voltage measurements.
 - *Input Offset Current:* Typical value for information; Maximum channel input offset current, not considering the input resistance.
 - *Input resistance:* Typical value for information: DAE input resistance at the connector, during internal auto-zeroing and during measurement.
 - *Low Battery Alarm Voltage:* Typical value for information. Below this voltage, a battery alarm signal is generated.
 - *Power consumption:* Typical value for information. Supply currents in various operating modes.

DC Voltage Measurement

A/D - Converter Resolution nominal

High Range: 1LSB = 6.1 μ V, full range = -100...+300 mV
Low Range: 1LSB = 61nV, full range = -1.....+3mV

DASY measurement parameters: Auto Zero Time: 3 sec; Measuring time: 3 sec

Calibration Factors	X	Y	Z
High Range	404.445 \pm 0.02% (k=2)	404.110 \pm 0.02% (k=2)	404.959 \pm 0.02% (k=2)
Low Range	3.95998 \pm 1.50% (k=2)	3.93992 \pm 1.50% (k=2)	3.99728 \pm 1.50% (k=2)

Connector Angle

Connector Angle to be used in DASY system	56.0 $^{\circ}$ \pm 1 $^{\circ}$
---	------------------------------------

Appendix (Additional assessments outside the scope of SCS0108)

1. DC Voltage Linearity

High Range		Reading (μV)	Difference (μV)	Error (%)
Channel X	+ Input	199998.65	1.51	0.00
Channel X	+ Input	20003.67	1.49	0.01
Channel X	- Input	-19998.57	1.81	-0.01
Channel Y	+ Input	199997.59	-0.07	-0.00
Channel Y	+ Input	20000.66	-1.46	-0.01
Channel Y	- Input	-19999.61	0.87	-0.00
Channel Z	+ Input	199997.76	0.55	0.00
Channel Z	+ Input	19999.68	-2.27	-0.01
Channel Z	- Input	-20000.13	0.36	-0.00

Low Range		Reading (μV)	Difference (μV)	Error (%)
Channel X	+ Input	2002.77	0.92	0.05
Channel X	+ Input	202.84	0.66	0.33
Channel X	- Input	-196.58	1.09	-0.55
Channel Y	+ Input	2002.44	0.71	0.04
Channel Y	+ Input	202.20	0.08	0.04
Channel Y	- Input	-198.06	-0.28	0.14
Channel Z	+ Input	2002.08	0.42	0.02
Channel Z	+ Input	200.37	-1.61	-0.80
Channel Z	- Input	-199.14	-1.33	0.67

2. Common mode sensitivity

DASY measurement parameters: Auto Zero Time: 3 sec; Measuring time: 3 sec

	Common mode Input Voltage (mV)	High Range Average Reading (μV)	Low Range Average Reading (μV)
Channel X	200	-3.54	-5.21
	- 200	6.25	4.83
Channel Y	200	-0.35	-0.64
	- 200	-0.21	-0.07
Channel Z	200	15.29	15.53
	- 200	-18.32	-18.03

3. Channel separation

DASY measurement parameters: Auto Zero Time: 3 sec; Measuring time: 3 sec

	Input Voltage (mV)	Channel X (μV)	Channel Y (μV)	Channel Z (μV)
Channel X	200	-	0.24	-4.36
Channel Y	200	7.55	-	0.52
Channel Z	200	9.68	4.92	-

4. AD-Converter Values with inputs shorted

DASY measurement parameters: Auto Zero Time: 3 sec; Measuring time: 3 sec

	High Range (LSB)	Low Range (LSB)
Channel X	15770	16653
Channel Y	15724	15421
Channel Z	16050	15178

5. Input Offset Measurement

DASY measurement parameters: Auto Zero Time: 3 sec; Measuring time: 3 sec

Input 10M Ω

	Average (μ V)	min. Offset (μ V)	max. Offset (μ V)	Std. Deviation (μ V)
Channel X	1.44	-0.31	2.82	0.59
Channel Y	-0.40	-1.67	0.99	0.60
Channel Z	0.67	-1.25	2.04	0.58

6. Input Offset Current

Nominal Input circuitry offset current on all channels: <25fA

7. Input Resistance (Typical values for information)

	Zeroing (kOhm)	Measuring (MOhm)
Channel X	200	200
Channel Y	200	200
Channel Z	200	200

8. Low Battery Alarm Voltage (Typical values for information)

Typical values	Alarm Level (VDC)
Supply (+ Vcc)	+7.9
Supply (- Vcc)	-7.6

9. Power Consumption (Typical values for information)

Typical values	Switched off (mA)	Stand by (mA)	Transmitting (mA)
Supply (+ Vcc)	+0.01	+6	+14
Supply (- Vcc)	-0.01	-8	-9

DAE REPAIR REPORT – SPEAG Production Center

PRODUCT		DAE4 - Data Acquisition Electronics	
SERIAL Nr.:		522	IN DATE: 16-Sep-2016
CUSTOMER: Eurofins			
DAE REPAIR	WORK DESCRIPTION		WORKING TIME (h)
MATERIAL			
Emergency stop:	fixed <input type="radio"/>	exchanged <input type="radio"/>	6 new magnets <input type="radio"/>
DAE Connector:	fixed <input type="radio"/>	exchanged <input type="radio"/> <input type="radio"/>
DAE Battery Cover:	fixed <input type="radio"/>	exchanged <input type="radio"/> <input type="radio"/>
AD Converter Print:	fixed <input type="radio"/>	exchanged <input checked="" type="radio"/> <input type="radio"/>
Battery Connector:	fixed <input type="radio"/>	exchanged <input type="radio"/> <input type="radio"/>
Battery Con. PCB:	fixed <input type="radio"/>	exchanged <input type="radio"/> <input type="radio"/>
DAE 3 - 4 upgrade	fixed <input type="radio"/>	installed <input type="radio"/> <input type="radio"/>
Input PCB:	fixed <input type="radio"/>	exchanged <input type="radio"/> <input type="radio"/>
DAE Bottom Cover	fixed <input type="radio"/>	exchanged <input type="radio"/> <input type="radio"/>
Analysis:			1.50 hours
Final Assembly:			hours
Total hours			2.50 hours
COMMENTS:			
This DAE was returned for calibration. It failed the receiving inspection test. The input range of the Y channel (4.104) is to high (tolerance 3.9 - 4.1). The linearity of the channel wasn't affected. To re-establish full functionality of this DAE the ADC printed circuit board has been replaced. After this repair the DAE will get newly calibrated.			
CONDUCTED BY:		APPROVED BY:	
A. Gu DATE: <u>26-Sep-2016</u>		 DATE: <u>26-Sep-2016</u>	
REPAIR COST:			
MATERIAL COST:	free	USD <input checked="" type="radio"/>	Euro <input type="radio"/>
REPAIR:	free	USD <input checked="" type="radio"/>	Euro <input type="radio"/>
TOTAL COST:		QUOTATION #:	
free		-	
APPROVED BY:			
 DATE: <u>26-Sep-2016</u>			



Accredited by the Swiss Accreditation Service (SAS)
The Swiss Accreditation Service is one of the signatories to the EA
Multilateral Agreement for the recognition of calibration certificates

Accreditation No.: **SCS 0108**

Client **Eurofins**

Certificate No: **EX3-3893_Sep16**

CALIBRATION CERTIFICATE

Object **EX3DV4 - SN:3893**

Calibration procedure(s) **QA CAL-01.v9, QA CAL-12.v9, QA CAL-14.v4, QA CAL-23.v5,
QA CAL-25.v6
Calibration procedure for dosimetric E-field probes**

Calibration date: **September 23, 2016**

This calibration certificate documents the traceability to national standards, which realize the physical units of measurements (SI).
The measurements and the uncertainties with confidence probability are given on the following pages and are part of the certificate.

All calibrations have been conducted in the closed laboratory facility: environment temperature (22 ± 3)°C and humidity < 70%.

Calibration Equipment used (M&TE critical for calibration)

Primary Standards	ID	Cal Date (Certificate No.)	Scheduled Calibration
Power meter NRP	SN: 104778	06-Apr-16 (No. 217-02288/02289)	Apr-17
Power sensor NRP-Z91	SN: 103244	06-Apr-16 (No. 217-02288)	Apr-17
Power sensor NRP-Z91	SN: 103245	06-Apr-16 (No. 217-02289)	Apr-17
Reference 20 dB Attenuator	SN: S5277 (20x)	05-Apr-16 (No. 217-02293)	Apr-17
Reference Probe ES3DV2	SN: 3013	31-Dec-15 (No. ES3-3013_Dec15)	Dec-16
DAE4	SN: 660	23-Dec-15 (No. DAE4-660_Dec15)	Dec-16
Secondary Standards	ID	Check Date (in house)	Scheduled Check
Power meter E4419B	SN: GB41293874	06-Apr-16 (in house check Jun-16)	In house check: Jun-18
Power sensor E4412A	SN: MY41498087	06-Apr-16 (in house check Jun-16)	In house check: Jun-18
Power sensor E4412A	SN: 000110210	06-Apr-16 (in house check Jun-16)	In house check: Jun-18
RF generator HP 8648C	SN: US3642U01700	04-Aug-99 (in house check Jun-16)	In house check: Jun-18
Network Analyzer HP 8753E	SN: US37390585	18-Oct-01 (in house check Oct-15)	In house check: Oct-16

Calibrated by:	Name Michael Weber	Function Laboratory Technician	Signature
Approved by:	Name Katja Pokovic	Function Technical Manager	

Issued: September 28, 2016

This calibration certificate shall not be reproduced except in full without written approval of the laboratory.



Accredited by the Swiss Accreditation Service (SAS)

Accreditation No.: **SCS 0108**

The Swiss Accreditation Service is one of the signatories to the EA
Multilateral Agreement for the recognition of calibration certificates

Glossary:

TSL	tissue simulating liquid
NORM _{x,y,z}	sensitivity in free space
ConvF	sensitivity in TSL / NORM _{x,y,z}
DCP	diode compression point
CF	crest factor (1/duty_cycle) of the RF signal
A, B, C, D	modulation dependent linearization parameters
Polarization φ	φ rotation around probe axis
Polarization ϑ	ϑ rotation around an axis that is in the plane normal to probe axis (at measurement center), i.e., $\vartheta = 0$ is normal to probe axis
Connector Angle	information used in DASY system to align probe sensor X to the robot coordinate system

Calibration is Performed According to the Following Standards:

- a) IEEE Std 1528-2013, "IEEE Recommended Practice for Determining the Peak Spatial-Averaged Specific Absorption Rate (SAR) in the Human Head from Wireless Communications Devices: Measurement Techniques", June 2013
- b) IEC 62209-1, "Procedure to measure the Specific Absorption Rate (SAR) for hand-held devices used in close proximity to the ear (frequency range of 300 MHz to 3 GHz)", February 2005
- c) IEC 62209-2, "Procedure to determine the Specific Absorption Rate (SAR) for wireless communication devices used in close proximity to the human body (frequency range of 30 MHz to 6 GHz)", March 2010
- d) KDB 865664, "SAR Measurement Requirements for 100 MHz to 6 GHz"

Methods Applied and Interpretation of Parameters:

- **NORM_{x,y,z}**: Assessed for E-field polarization $\vartheta = 0$ ($f \leq 900$ MHz in TEM-cell; $f > 1800$ MHz: R22 waveguide). NORM_{x,y,z} are only intermediate values, i.e., the uncertainties of NORM_{x,y,z} does not affect the E²-field uncertainty inside TSL (see below ConvF).
- **NORM(f)_{x,y,z}** = NORM_{x,y,z} * frequency_response (see Frequency Response Chart). This linearization is implemented in DASY4 software versions later than 4.2. The uncertainty of the frequency response is included in the stated uncertainty of ConvF.
- **DCP_{x,y,z}**: DCP are numerical linearization parameters assessed based on the data of power sweep with CW signal (no uncertainty required). DCP does not depend on frequency nor media.
- **PAR**: PAR is the Peak to Average Ratio that is not calibrated but determined based on the signal characteristics
- **A_{x,y,z}; B_{x,y,z}; C_{x,y,z}; D_{x,y,z}; VR_{x,y,z}**: A, B, C, D are numerical linearization parameters assessed based on the data of power sweep for specific modulation signal. The parameters do not depend on frequency nor media. VR is the maximum calibration range expressed in RMS voltage across the diode.
- **ConvF and Boundary Effect Parameters**: Assessed in flat phantom using E-field (or Temperature Transfer Standard for $f \leq 800$ MHz) and inside waveguide using analytical field distributions based on power measurements for $f > 800$ MHz. The same setups are used for assessment of the parameters applied for boundary compensation (alpha, depth) of which typical uncertainty values are given. These parameters are used in DASY4 software to improve probe accuracy close to the boundary. The sensitivity in TSL corresponds to NORM_{x,y,z} * ConvF whereby the uncertainty corresponds to that given for ConvF. A frequency dependent ConvF is used in DASY version 4.4 and higher which allows extending the validity from ± 50 MHz to ± 100 MHz.
- **Spherical isotropy (3D deviation from isotropy)**: in a field of low gradients realized using a flat phantom exposed by a patch antenna.
- **Sensor Offset**: The sensor offset corresponds to the offset of virtual measurement center from the probe tip (on probe axis). No tolerance required.
- **Connector Angle**: The angle is assessed using the information gained by determining the NORM_x (no uncertainty required).

Probe EX3DV4

SN:3893

Manufactured: October 9, 2012
Calibrated: September 23, 2016

Calibrated for DASY/EASY Systems
(Note: non-compatible with DASY2 system!)

DASY/EASY - Parameters of Probe: EX3DV4 - SN:3893

Basic Calibration Parameters

	Sensor X	Sensor Y	Sensor Z	Unc (k=2)
Norm ($\mu\text{V}/(\text{V}/\text{m})^2$) ^A	0.54	0.41	0.32	$\pm 10.1 \%$
DCP (mV) ^B	99.6	99.2	99.2	

Modulation Calibration Parameters

UID	Communication System Name		A dB	B dB $\sqrt{\mu\text{V}}$	C	D dB	VR mV	Unc ^E (k=2)
0	CW	X	0.0	0.0	1.0	0.00	172.7	$\pm 2.5 \%$
		Y	0.0	0.0	1.0		172.1	
		Z	0.0	0.0	1.0		191.4	

The reported uncertainty of measurement is stated as the standard uncertainty of measurement multiplied by the coverage factor $k=2$, which for a normal distribution corresponds to a coverage probability of approximately 95%.

^A The uncertainties of Norm X,Y,Z do not affect the E^2 -field uncertainty inside TSL (see Pages 5 and 6).

^B Numerical linearization parameter: uncertainty not required.

^E Uncertainty is determined using the max. deviation from linear response applying rectangular distribution and is expressed for the square of the field value.

DASY/EASY - Parameters of Probe: EX3DV4 - SN:3893

Calibration Parameter Determined in Head Tissue Simulating Media

f (MHz) ^C	Relative Permittivity ^F	Conductivity (S/m) ^F	ConvF X	ConvF Y	ConvF Z	Alpha ^G	Depth ^G (mm)	Unc (k=2)
450	43.5	0.87	11.48	11.48	11.48	0.17	1.30	± 13.3 %
750	41.9	0.89	11.10	11.10	11.10	0.53	0.80	± 12.0 %
900	41.5	0.97	10.44	10.44	10.44	0.48	0.80	± 12.0 %
1750	40.1	1.37	8.94	8.94	8.94	0.26	0.80	± 12.0 %
1810	40.0	1.40	8.60	8.60	8.60	0.35	0.80	± 12.0 %
1950	40.0	1.40	8.39	8.39	8.39	0.37	0.80	± 12.0 %
2150	39.7	1.53	8.33	8.33	8.33	0.35	0.80	± 12.0 %
2450	39.2	1.80	7.76	7.76	7.76	0.34	0.85	± 12.0 %
2600	39.0	1.96	7.63	7.63	7.63	0.34	0.85	± 12.0 %
5200	36.0	4.66	5.22	5.22	5.22	0.40	1.80	± 13.1 %
5500	35.6	4.96	4.98	4.98	4.98	0.45	1.80	± 13.1 %
5800	35.3	5.27	4.69	4.69	4.69	0.50	1.80	± 13.1 %

^C Frequency validity above 300 MHz of ± 100 MHz only applies for DASY v4.4 and higher (see Page 2), else it is restricted to ± 50 MHz. The uncertainty is the RSS of the ConvF uncertainty at calibration frequency and the uncertainty for the indicated frequency band. Frequency validity below 300 MHz is $\pm 10, 25, 40, 50$ and 70 MHz for ConvF assessments at 30, 64, 128, 150 and 220 MHz respectively. Above 5 GHz frequency validity can be extended to ± 110 MHz.

^F At frequencies below 3 GHz, the validity of tissue parameters (ϵ and σ) can be relaxed to $\pm 10\%$ if liquid compensation formula is applied to measured SAR values. At frequencies above 3 GHz, the validity of tissue parameters (ϵ and σ) is restricted to $\pm 5\%$. The uncertainty is the RSS of the ConvF uncertainty for indicated target tissue parameters.

^G Alpha/Depth are determined during calibration. SPEAG warrants that the remaining deviation due to the boundary effect after compensation is always less than $\pm 1\%$ for frequencies below 3 GHz and below $\pm 2\%$ for frequencies between 3-6 GHz at any distance larger than half the probe tip diameter from the boundary.

DASY/EASY - Parameters of Probe: EX3DV4 - SN:3893

Calibration Parameter Determined in Body Tissue Simulating Media

f (MHz) ^C	Relative Permittivity ^F	Conductivity (S/m) ^F	ConvF X	ConvF Y	ConvF Z	Alpha ^G	Depth ^G (mm)	Unc (k=2)
450	56.7	0.94	11.99	11.99	11.99	0.10	1.20	± 13.3 %
750	55.5	0.96	10.32	10.32	10.32	0.42	0.88	± 12.0 %
900	55.0	1.05	10.35	10.35	10.35	0.43	0.80	± 12.0 %
1750	53.4	1.49	8.52	8.52	8.52	0.41	0.80	± 12.0 %
1810	53.3	1.52	8.34	8.34	8.34	0.35	0.92	± 12.0 %
1950	53.3	1.52	8.48	8.48	8.48	0.34	0.91	± 12.0 %
2150	53.1	1.66	8.30	8.30	8.30	0.34	0.99	± 12.0 %
2450	52.7	1.95	7.90	7.90	7.90	0.37	0.90	± 12.0 %
2600	52.5	2.16	7.59	7.59	7.59	0.36	0.90	± 12.0 %
5200	49.0	5.30	4.55	4.55	4.55	0.50	1.90	± 13.1 %
5500	48.6	5.65	4.17	4.17	4.17	0.50	1.90	± 13.1 %
5800	48.2	6.00	4.03	4.03	4.03	0.60	1.90	± 13.1 %

^C Frequency validity above 300 MHz of ± 100 MHz only applies for DASY v4.4 and higher (see Page 2), else it is restricted to ± 50 MHz. The uncertainty is the RSS of the ConvF uncertainty at calibration frequency and the uncertainty for the indicated frequency band. Frequency validity below 300 MHz is ± 10, 25, 40, 50 and 70 MHz for ConvF assessments at 30, 64, 128, 150 and 220 MHz respectively. Above 5 GHz frequency validity can be extended to ± 110 MHz.

^F At frequencies below 3 GHz, the validity of tissue parameters (ϵ and σ) can be relaxed to ± 10% if liquid compensation formula is applied to measured SAR values. At frequencies above 3 GHz, the validity of tissue parameters (ϵ and σ) is restricted to ± 5%. The uncertainty is the RSS of the ConvF uncertainty for indicated target tissue parameters.

^G Alpha/Depth are determined during calibration. SPEAG warrants that the remaining deviation due to the boundary effect after compensation is always less than ± 1% for frequencies below 3 GHz and below ± 2% for frequencies between 3-6 GHz at any distance larger than half the probe tip diameter from the boundary.

Frequency Response of E-Field (TEM-Cell:ifi110 EXX, Waveguide: R22)

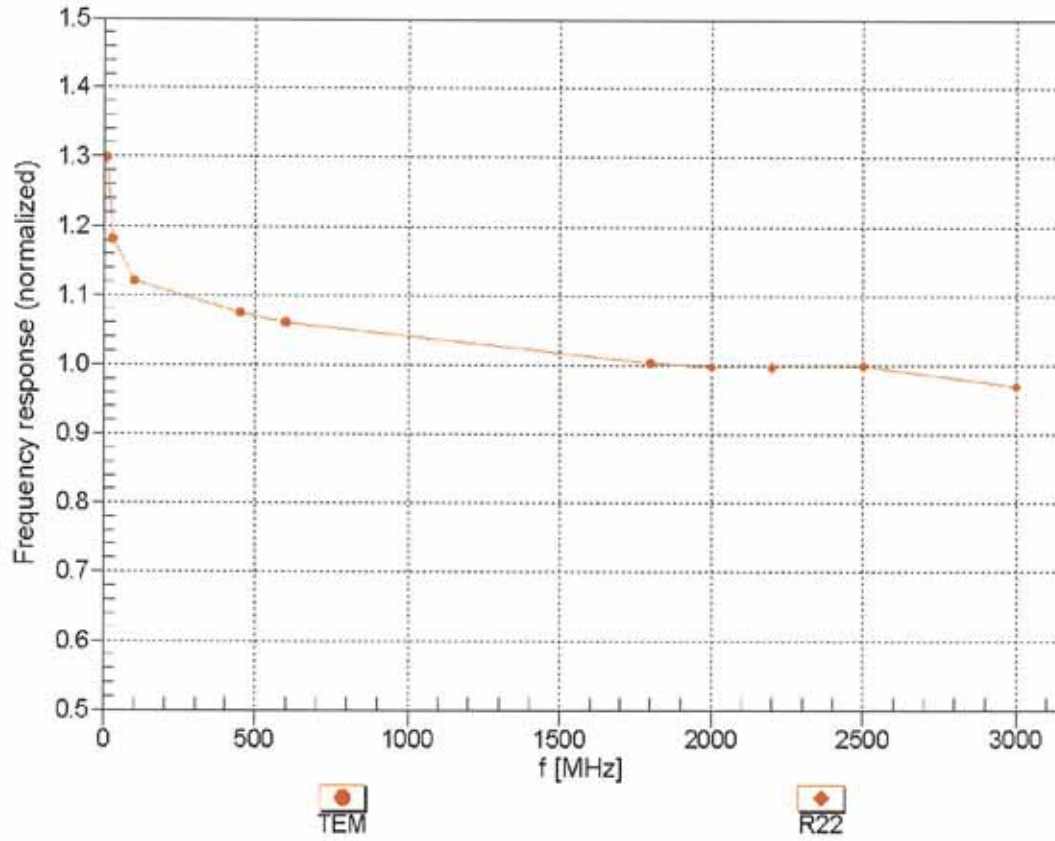

Uncertainty of Frequency Response of E-field: $\pm 6.3\%$ (k=2)

Receiving Pattern (ϕ), $\theta = 0^\circ$

f=600 MHz,TEM

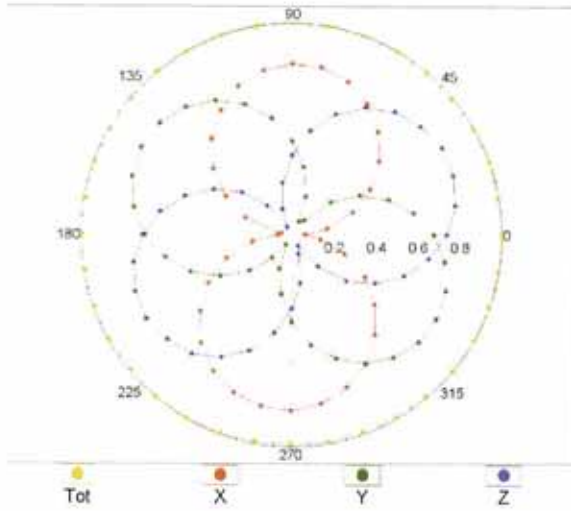

f=1800 MHz,R22

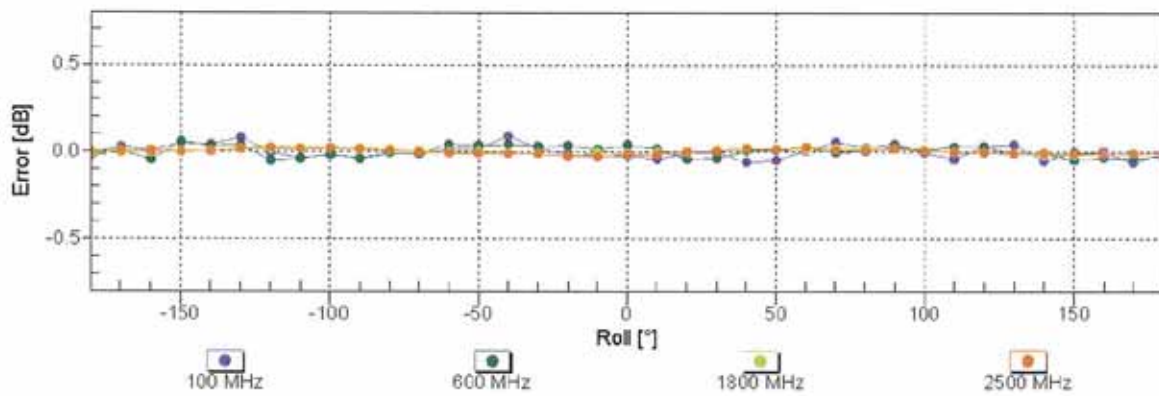
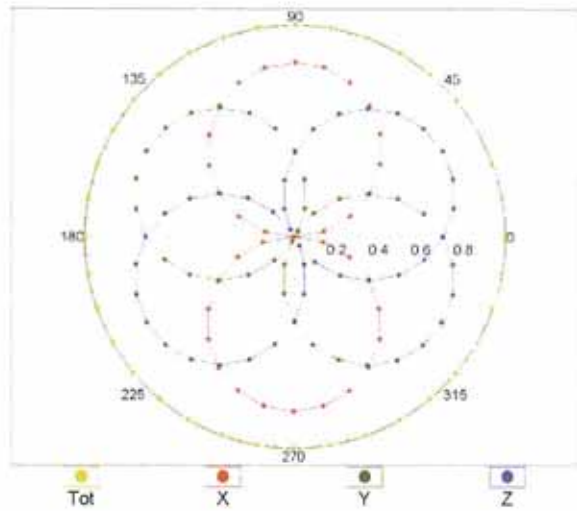

Uncertainty of Axial Isotropy Assessment: $\pm 0.5\%$ (k=2)

Dynamic Range $f(SAR_{head})$ (TEM cell , $f_{eval}= 1900$ MHz)

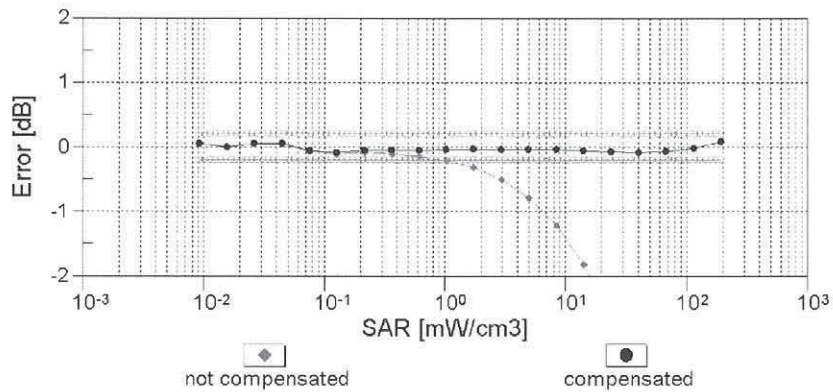
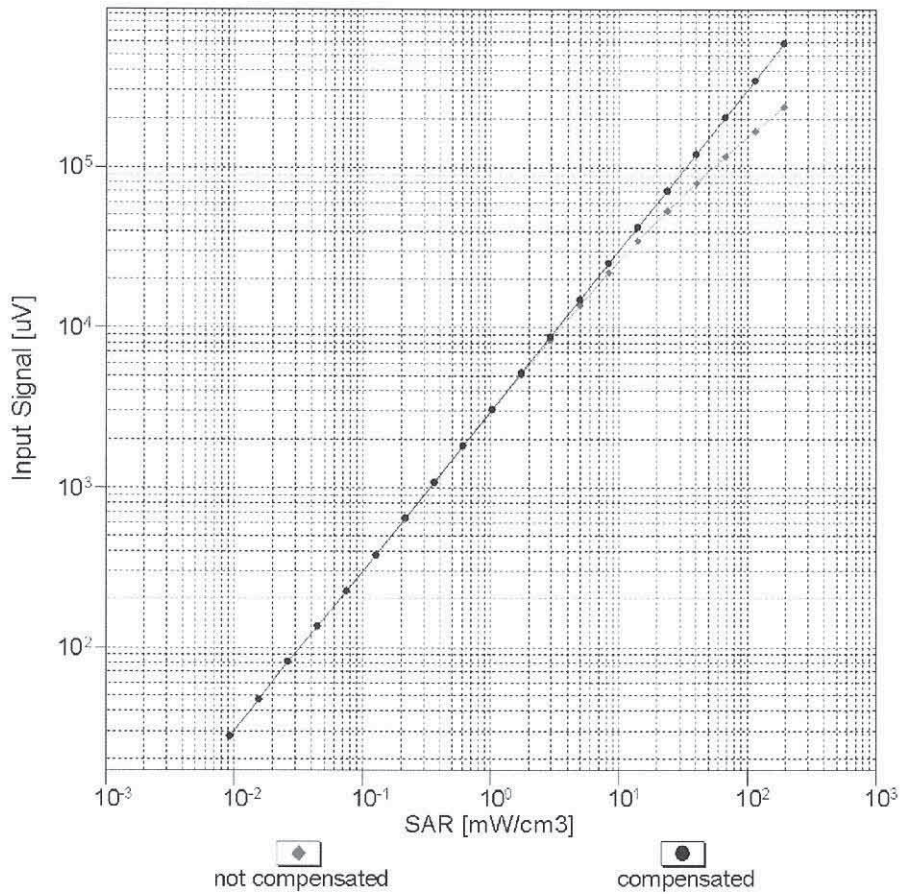

Uncertainty of Linearity Assessment: $\pm 0.6\%$ (k=2)

Conversion Factor Assessment

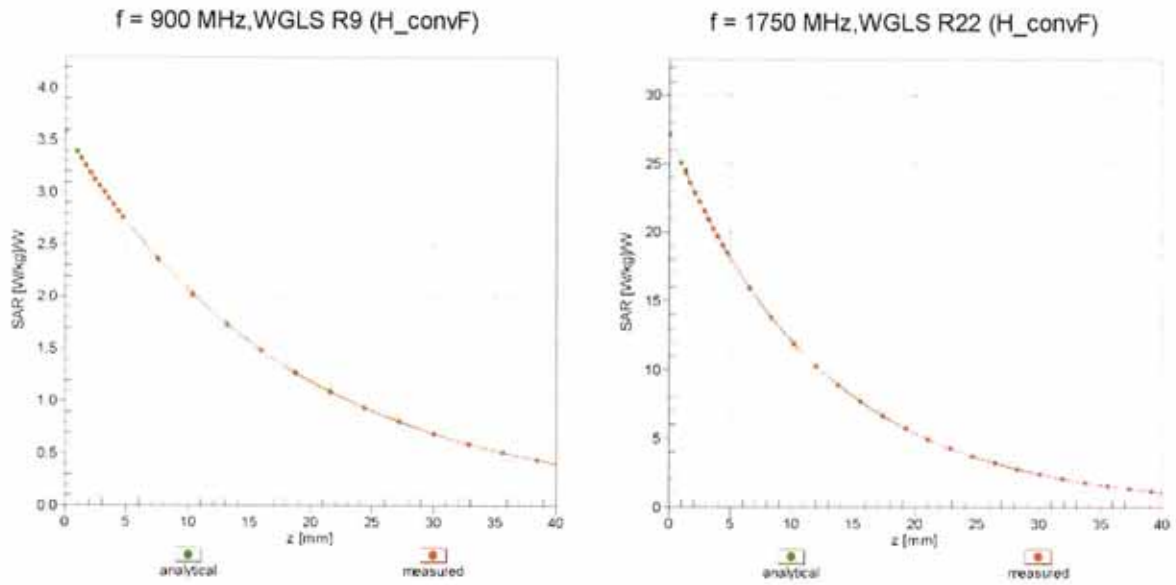

Deviation from Isotropy in Liquid Error (ϕ, ϑ), f = 900 MHz

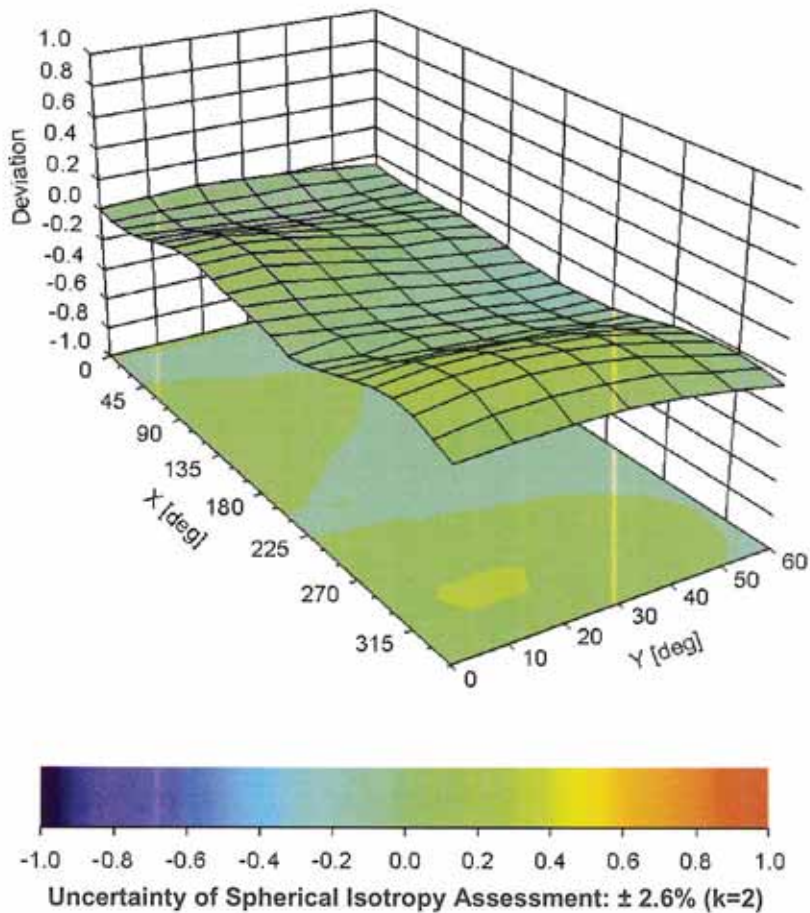

DASY/EASY - Parameters of Probe: EX3DV4 - SN:3893

Other Probe Parameters

Sensor Arrangement	Triangular
Connector Angle (°)	-19.9
Mechanical Surface Detection Mode	enabled
Optical Surface Detection Mode	disabled
Probe Overall Length	337 mm
Probe Body Diameter	10 mm
Tip Length	9 mm
Tip Diameter	2.5 mm
Probe Tip to Sensor X Calibration Point	1 mm
Probe Tip to Sensor Y Calibration Point	1 mm
Probe Tip to Sensor Z Calibration Point	1 mm
Recommended Measurement Distance from Surface	1.4 mm

ANNEX B System Validation Reports

Test Laboratory: Eurofins Product Service GmbH

System Performance Check - ELI Phantom - EX3DV4 - MSL - 900 MHz 12-01-2017

DUT: Dipole 900 MHz; Type: D900V2; Serial: 164

Communication System: UID 0 - n/a, CW; Frequency: 900 MHz; Duty Cycle: 1:1
Medium: Muscle 900 MHz Medium parameters used: $f = 900 \text{ MHz}$; $\sigma = 1.017 \text{ S/m}$; $\epsilon_r = 52.969$; $\rho = 1000 \text{ kg/m}^3$
Phantom section: Flat Section

Measurement Standard: DASY5 (IEEE/IEC/ANSI C63.19-2007)

DASY5.2 Configuration:

- Probe: EX3DV4 - SN3893; ConvF(10.35, 10.35, 10.35); Calibrated: 2016-09-23;
- Sensor-Surface: 1.4mm (Mechanical Surface Detection)
- Electronics: DAE3 Sn522; Calibrated: 2016-09-28
- Phantom: Flat Phantom ELI4.0; Type: QDOVA001BB; Serial: SN:1013
- Measurement SW: DASY52, Version 52.8 (6); SEMCAD X Version 14.6.9 (7117)

System Performance Check at Frequencies below 1 GHz/d=15mm, Pin=250 mW, dist=1.4mm (EX-Probe)/Area Scan (61x81x1): Interpolated grid: dx=1.500 mm, dy=1.500 mm
Maximum value of SAR (interpolated) = 3.68 W/kg

System Performance Check at Frequencies below 1 GHz/d=15mm, Pin=250 mW, dist=1.4mm (EX-Probe)/Zoom Scan (7x7x7) (7x7x7)/Cube 0: Measurement grid: dx=5mm, dy=5mm, dz=5mm
Reference Value = 58.928 V/m; Power Drift = 0.05 dB
Peak SAR (extrapolated) = 4.28 W/kg
SAR(1 g) = 2.77 W/kg; SAR(10 g) = 1.79 W/kg
Maximum value of SAR (measured) = 3.74 W/kg

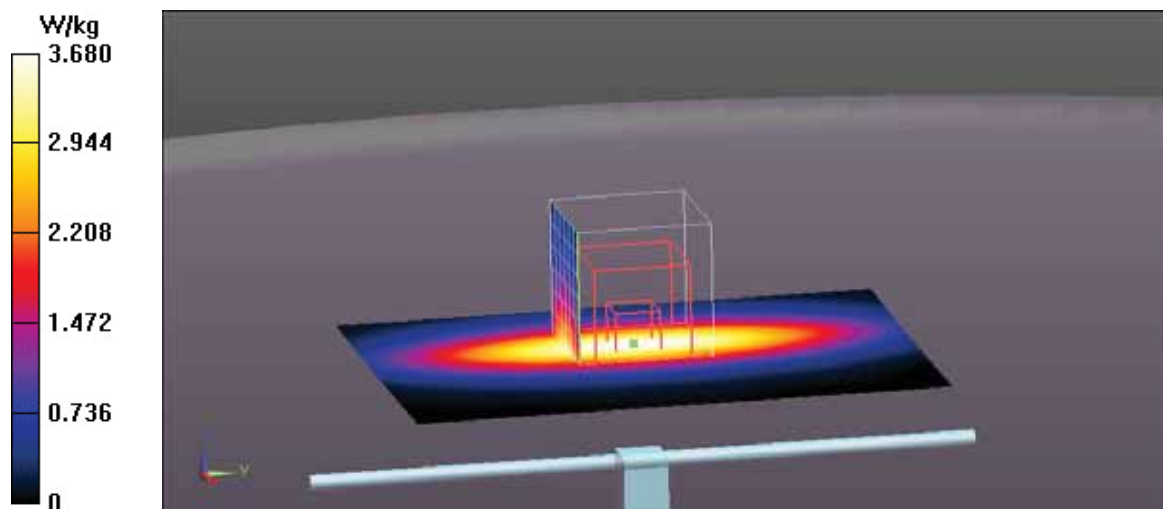

Test Laboratory: Eurofins Product Service GmbH

System Performance Check - ELI Phantom - EX3DV4 - MSL - 900 MHz 13-01-2017

DUT: Dipole 900 MHz; Type: D900V2; Serial: 164

Communication System: UID 0 - n/a, CW; Frequency: 900 MHz; Duty Cycle: 1:1
Medium: Muscle 900 MHz Medium parameters used: $f = 900 \text{ MHz}$; $\sigma = 1.017 \text{ S/m}$; $\epsilon_r = 52.969$; $\rho = 1000 \text{ kg/m}^3$
Phantom section: Flat Section

Measurement Standard: DASYS (IEEE/IEC/ANSI C63.19-2007)

DASY5.2 Configuration:

- Probe: EX3DV4 - SN3893; ConvF(10.35, 10.35, 10.35); Calibrated: 2016-09-23;
- Sensor-Surface: 1.4mm (Mechanical Surface Detection)
- Electronics: DAE3 Sn522; Calibrated: 2016-09-28
- Phantom: Flat Phantom ELI4.0; Type: QDOVA001BB; Serial: SN:1013
- Measurement SW: DASYS2, Version 52.8 (6); SEMCAD X Version 14.6.9 (7117)

System Performance Check at Frequencies below 1 GHz/d=15mm, Pin=250 mW, dist=1.4mm (EX-Probe)/Area Scan (61x81x1): Interpolated grid: $dx=1.500 \text{ mm}$, $dy=1.500 \text{ mm}$
Maximum value of SAR (interpolated) = 3.72 W/kg

System Performance Check at Frequencies below 1 GHz/d=15mm, Pin=250 mW, dist=1.4mm (EX-Probe)/Zoom Scan (7x7x7) (7x7x7)/Cube 0: Measurement grid: $dx=5\text{mm}$, $dy=5\text{mm}$, $dz=5\text{mm}$
Reference Value = 62.431 V/m; Power Drift = -0.01 dB
Peak SAR (extrapolated) = 4.31 W/kg
SAR(1 g) = 2.8 W/kg; SAR(10 g) = 1.82 W/kg
Maximum value of SAR (measured) = 3.77 W/kg

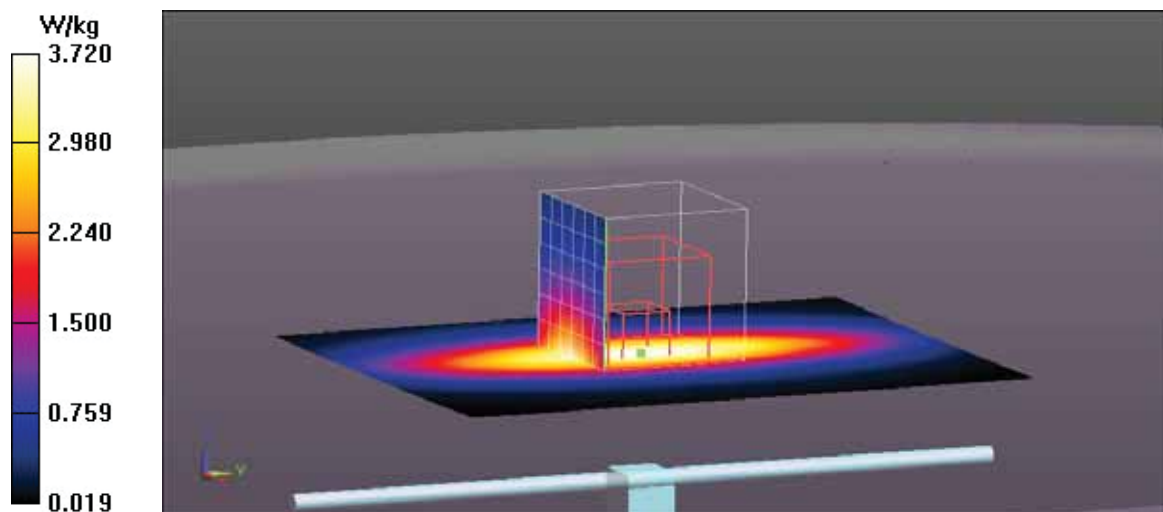

Test Laboratory: Eurofins Product Service GmbH

System Performance Check - ELI Phantom - EX3DV4 - MSL - 900 MHz 17-01-2017

DUT: Dipole 900 MHz; Type: D900V2; Serial: 164

Communication System: UID 0 - n/a, CW; Frequency: 900 MHz; Duty Cycle: 1:1
Medium: Muscle 900 MHz Medium parameters used: $f = 900 \text{ MHz}$; $\sigma = 1.021 \text{ S/m}$; $\epsilon_r = 52.605$; $\rho = 1000 \text{ kg/m}^3$
Phantom section: Flat Section

Measurement Standard: DASYS (IEEE/IEC/ANSI C63.19-2007)

DASY5.2 Configuration:

- Probe: EX3DV4 - SN3893; ConvF(10.35, 10.35, 10.35); Calibrated: 2016-09-23;
- Sensor-Surface: 1.4mm (Mechanical Surface Detection)
- Electronics: DAE3 Sn522; Calibrated: 2016-09-28
- Phantom: Flat Phantom ELI4.0; Type: QDOVA001BB; Serial: SN:1013
- Measurement SW: DASYS2, Version 52.8 (6); SEMCAD X Version 14.6.9 (7117)

System Performance Check at Frequencies below 1 GHz/d=15mm, Pin=250 mW, dist=1.4mm (EX-Probe)/Area Scan (61x81x1): Interpolated grid: dx=1.500 mm, dy=1.500 mm
Maximum value of SAR (interpolated) = 3.71 W/kg

System Performance Check at Frequencies below 1 GHz/d=15mm, Pin=250 mW, dist=1.4mm (EX-Probe)/Zoom Scan (7x7x7) (7x7x7)/Cube 0: Measurement grid: dx=5mm, dy=5mm, dz=5mm
Reference Value = 62.807 V/m; Power Drift = -0.01 dB
Peak SAR (extrapolated) = 4.24 W/kg
SAR(1 g) = 2.76 W/kg; SAR(10 g) = 1.79 W/kg
Maximum value of SAR (measured) = 3.74 W/kg

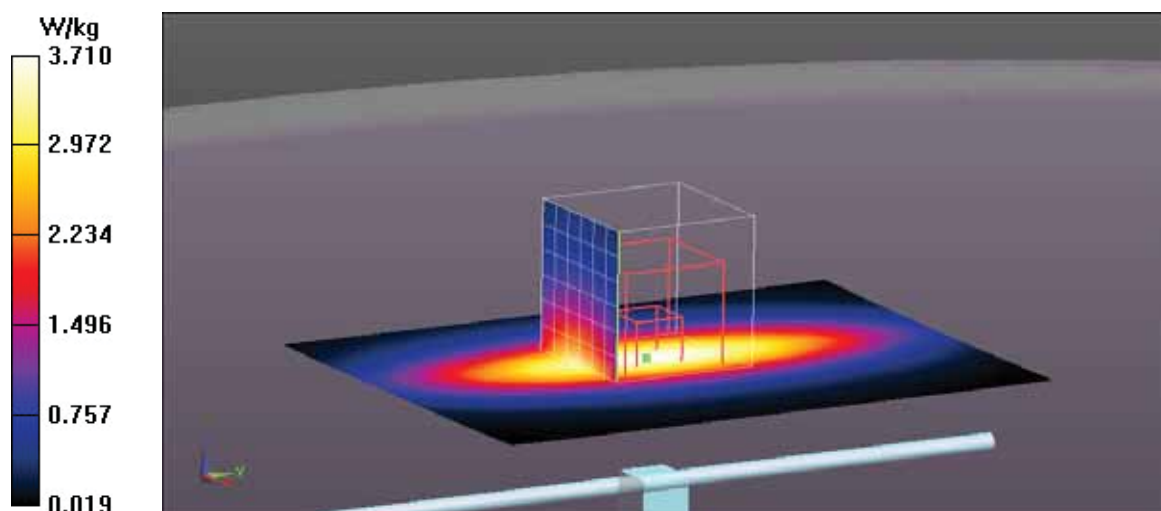

Test Laboratory: Eurofins Product Service GmbH

System Performance Check - ELI Phantom - EX3DV6 - MSL - 1900 MHz 18-01-2017

DUT: Dipole 1900 MHz; Type: D1900V2; Serial: 5d025

Communication System: UID 0 - n/a, CW; Frequency: 1900 MHz; Duty Cycle: 1:1
Medium: Muscle 1900 MHz Medium parameters used (interpolated): $f = 1900$ MHz; $\sigma = 1.495$ S/m; $\epsilon_r = 53.158$; $\rho = 1000$ kg/m³
Phantom section: Flat Section

Measurement Standard: DASYS (IEEE/IEC/ANSI C63.19-2007)

DASY5.2 Configuration:

- Probe: EX3DV4 - SN3893; ConvF(8.34, 8.34, 8.34); Calibrated: 2016-09-23;
- Sensor-Surface: 1.4mm (Mechanical Surface Detection)
- Electronics: DAE3 Sn522; Calibrated: 2016-09-28
- Phantom: Flat Phantom ELI4.0; Type: QDOVA001BB; Serial: SN:1013
- Measurement SW: DASY52, Version 52.8 (6); SEMCAD X Version 14.6.9 (7117)

System Performance Check at Frequencies above 1 GHz/d=10mm, Pin=250 mW, dist=1.4mm (EX-Probe)/Area Scan (61x61x1): Interpolated grid: dx=1.500 mm, dy=1.500 mm
Maximum value of SAR (interpolated) = 16.3 W/kg

System Performance Check at Frequencies above 1 GHz/d=10mm, Pin=250 mW, dist=1.4mm (EX-Probe)/Zoom Scan (7x7x7) (7x7x7)/Cube 0: Measurement grid: dx=5mm, dy=5mm, dz=5mm
Reference Value = 104.2 V/m; Power Drift = 0.09 dB
Peak SAR (extrapolated) = 18.4 W/kg
SAR(1 g) = 10.3 W/kg; SAR(10 g) = 5.5 W/kg
Maximum value of SAR (measured) = 15.5 W/kg

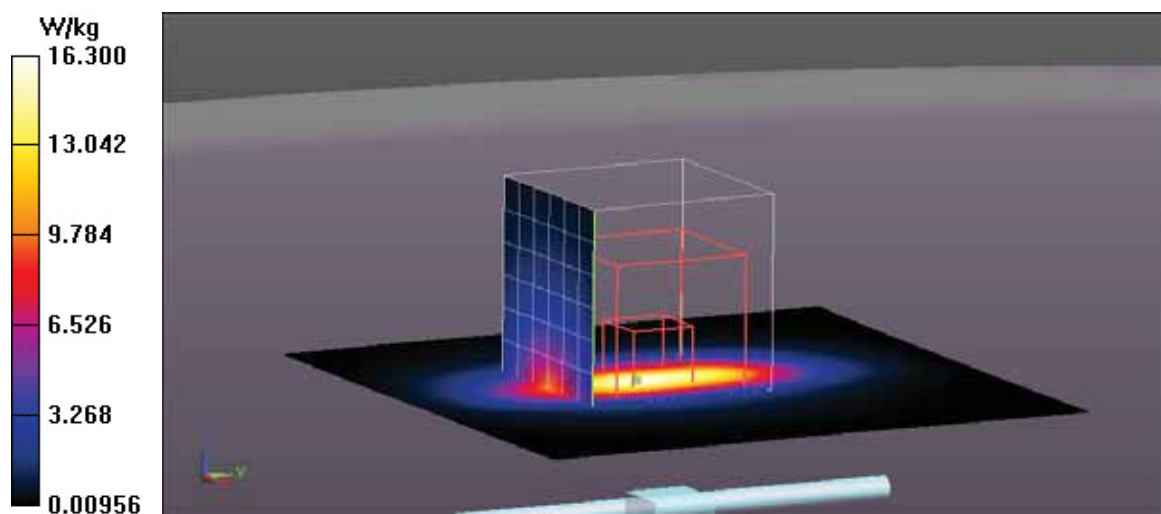

Test Laboratory: Eurofins Product Service GmbH

System Performance Check - ELI Phantom - EX3DV6 - MSL - 1900 MHz 19-01-2017

DUT: Dipole 1900 MHz; Type: D1900V2; Serial: 5d025

Communication System: UID 0 - n/a, CW; Frequency: 1900 MHz; Duty Cycle: 1:1
Medium: Muscle 1900 MHz Medium parameters used (interpolated): $f = 1900$ MHz; $\sigma = 1.495$ S/m; $\epsilon_r = 53.158$; $\rho = 1000$ kg/m³
Phantom section: Flat Section

Measurement Standard: DASYS (IEEE/IEC/ANSI C63.19-2007)

DASY5.2 Configuration:

- Probe: EX3DV4 - SN3893; ConvF(8.34, 8.34, 8.34); Calibrated: 2016-09-23;
- Sensor-Surface: 1.4mm (Mechanical Surface Detection)
- Electronics: DAE3 Sn522; Calibrated: 2016-09-28
- Phantom: Flat Phantom ELI4.0; Type: QDOVA001BB; Serial: SN:1013
- Measurement SW: DASY52, Version 52.8 (6); SEMCAD X Version 14.6.9 (7117)

System Performance Check at Frequencies above 1 GHz/d=10mm, Pin=250 mW, dist=1.4mm (EX-Probe)/Area Scan (61x61x1): Interpolated grid: dx=1.500 mm, dy=1.500 mm
Maximum value of SAR (interpolated) = 16.1 W/kg

System Performance Check at Frequencies above 1 GHz/d=10mm, Pin=250 mW, dist=1.4mm (EX-Probe)/Zoom Scan (7x7x7) (7x7x7)/Cube 0: Measurement grid: dx=5mm, dy=5mm, dz=5mm
Reference Value = 107.1 V/m; Power Drift = 0.04 dB
Peak SAR (extrapolated) = 18.4 W/kg
SAR(1 g) = 10.2 W/kg; SAR(10 g) = 5.35 W/kg
Maximum value of SAR (measured) = 15.5 W/kg

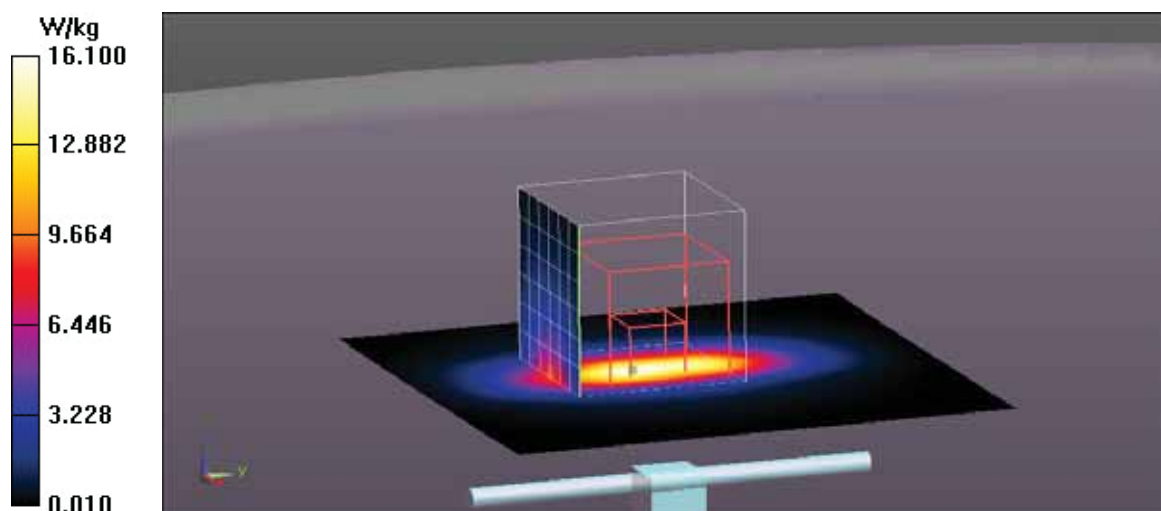

Test Laboratory: Eurofins Product Service GmbH

System Performance Check - ELI Phantom - EX3DV6 - MSL - 2450 MHz 24-01-2017

DUT: Dipole 2450 MHz; Type: D2450V2; Serial: 722

Communication System: UID 0 - n/a, CW; Frequency: 2450 MHz; Duty Cycle: 1:1
Medium: Muscle 2450 MHz Medium parameters used (interpolated): $f = 2450$ MHz; $\sigma = 2.014$ S/m; $\epsilon_r = 50.853$; $\rho = 1000$ kg/m³
Phantom section: Flat Section

Measurement Standard: DASYS (IEEE/IEC/ANSI C63.19-2007)

DASY5.2 Configuration:

- Probe: EX3DV4 - SN3893; ConvF(7.9, 7.9, 7.9); Calibrated: 2016-09-23;
- Sensor-Surface: 1.4mm (Mechanical Surface Detection)
- Electronics: DAE3 Sn522; Calibrated: 2016-09-28
- Phantom: Flat Phantom ELI4.0; Type: QDOVA001BB; Serial: SN:1013
- Measurement SW: DASY52, Version 52.8 (6); SEMCAD X Version 14.6.9 (7117)

System Performance Check at Frequencies above 1 GHz/d=10mm, Pin=250 mW, dist=1.4mm (EX-Probe)/Area Scan (61x61x1): Interpolated grid: dx=1.500 mm, dy=1.500 mm
Maximum value of SAR (interpolated) = 22.1 W/kg

System Performance Check at Frequencies above 1 GHz/d=10mm, Pin=250 mW, dist=1.4mm (EX-Probe)/Zoom Scan (7x7x7) (7x7x7)/Cube 0: Measurement grid: dx=5mm, dy=5mm, dz=5mm
Reference Value = 108.5 V/m; Power Drift = -0.02 dB
Peak SAR (extrapolated) = 27.5 W/kg
SAR(1 g) = 13.3 W/kg; SAR(10 g) = 6.08 W/kg
Maximum value of SAR (measured) = 21.8 W/kg

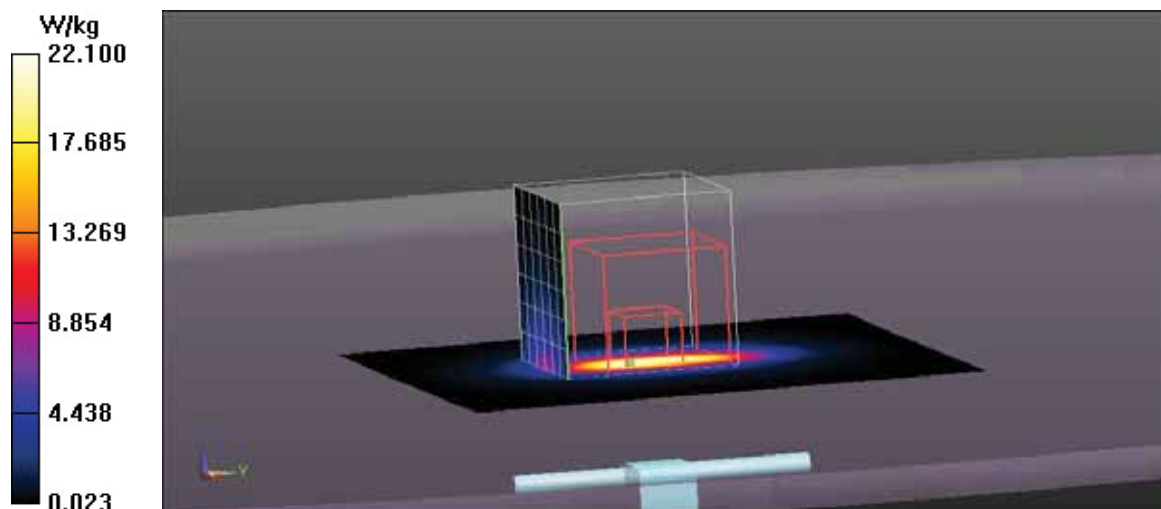

Test Laboratory: Eurofins Product Service GmbH

System Performance Check - SAM Phantom - EX3DV4 - HSL - 900 MHz 10-01-2017

DUT: Dipole 900 MHz; Type: D900V2; Serial: 164

Communication System: UID 0 - n/a, CW; Frequency: 900 MHz; Duty Cycle: 1:1

Medium: Head 900 MHz Medium parameters used: $f = 900 \text{ MHz}$; $\sigma = 0.968 \text{ S/m}$; $\epsilon_r = 41.654$; $\rho = 1000 \text{ kg/m}^3$

Phantom section: Flat Section

Measurement Standard: DASYS (IEEE/IEC/ANSI C63.19-2007)

DASY5.2 Configuration:

- Probe: EX3DV4 - SN3893; ConvF(10.44, 10.44, 10.44); Calibrated: 2016-09-23;
- Sensor-Surface: 1.4mm (Mechanical Surface Detection)
- Electronics: DAE3 Sn522; Calibrated: 2016-09-28
- Phantom: SAM 12; Type: TP-1217; Serial: QD000P40CA
- Measurement SW: DASYS2, Version 52.8 (6); SEMCAD X Version 14.6.9 (7117)

System Performance Check at Frequencies below 1 GHz/d=15mm, Pin=250 mW, dist=1.4mm (EX-Probe)/Area Scan (61x81x1): Interpolated grid: $dx=1.500 \text{ mm}$, $dy=1.500 \text{ mm}$
Maximum value of SAR (interpolated) = 3.71 W/kg

System Performance Check at Frequencies below 1 GHz/d=15mm, Pin=250 mW, dist=1.4mm (EX-Probe)/Zoom Scan (7x7x7) (7x7x7)/Cube 0: Measurement grid: $dx=5\text{mm}$, $dy=5\text{mm}$, $dz=5\text{mm}$
Reference Value = 64.992 V/m; Power Drift = -0.01 dB
Peak SAR (extrapolated) = 4.30 W/kg
SAR(1 g) = 2.77 W/kg; SAR(10 g) = 1.77 W/kg
Maximum value of SAR (measured) = 3.77 W/kg

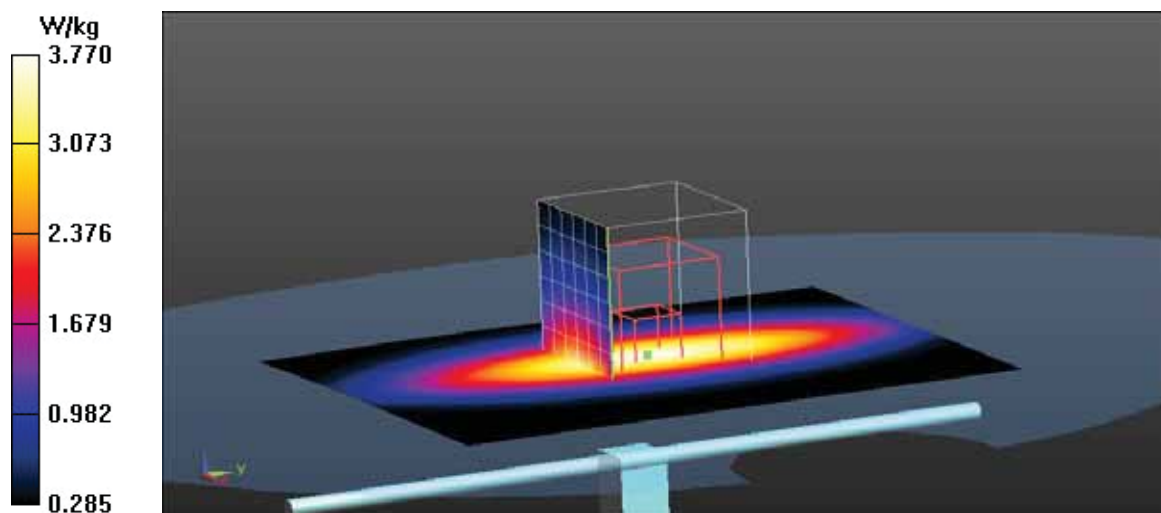

Test Laboratory: Eurofins Product Service GmbH

System Performance Check - SAM Phantom - EX3DV4 - HSL - 900 MHz 11-01-2017

DUT: Dipole 900 MHz; Type: D900V2; Serial: 164

Communication System: UID 0 - n/a, CW; Frequency: 900 MHz; Duty Cycle: 1:1

Medium: Head 900 MHz Medium parameters used: $f = 900 \text{ MHz}$; $\sigma = 0.968 \text{ S/m}$; $\epsilon_r = 41.654$; $\rho = 1000 \text{ kg/m}^3$

Phantom section: Flat Section

Measurement Standard: DASYS (IEEE/IEC/ANSI C63.19-2007)

DASY5.2 Configuration:

- Probe: EX3DV4 - SN3893; ConvF(10.44, 10.44, 10.44); Calibrated: 2016-09-23;
- Sensor-Surface: 1.4mm (Mechanical Surface Detection)
- Electronics: DAE3 Sn522; Calibrated: 2016-09-28
- Phantom: SAM 12; Type: TP-1217; Serial: QD000P40CA
- Measurement SW: DASY52, Version 52.8 (6); SEMCAD X Version 14.6.9 (7117)

System Performance Check at Frequencies below 1 GHz/d=15mm, Pin=250 mW, dist=1.4mm (EX-Probe)/Area Scan (61x81x1): Interpolated grid: $dx=1.500 \text{ mm}$, $dy=1.500 \text{ mm}$
Maximum value of SAR (interpolated) = 3.66 W/kg

System Performance Check at Frequencies below 1 GHz/d=15mm, Pin=250 mW, dist=1.4mm (EX-Probe)/Zoom Scan (7x7x7) (7x7x7)/Cube 0: Measurement grid: $dx=5\text{mm}$, $dy=5\text{mm}$, $dz=5\text{mm}$
Reference Value = 63.649 V/m; Power Drift = 0.01 dB
Peak SAR (extrapolated) = 4.18 W/kg
SAR(1 g) = 2.72 W/kg; SAR(10 g) = 1.75 W/kg
Maximum value of SAR (measured) = 3.67 W/kg

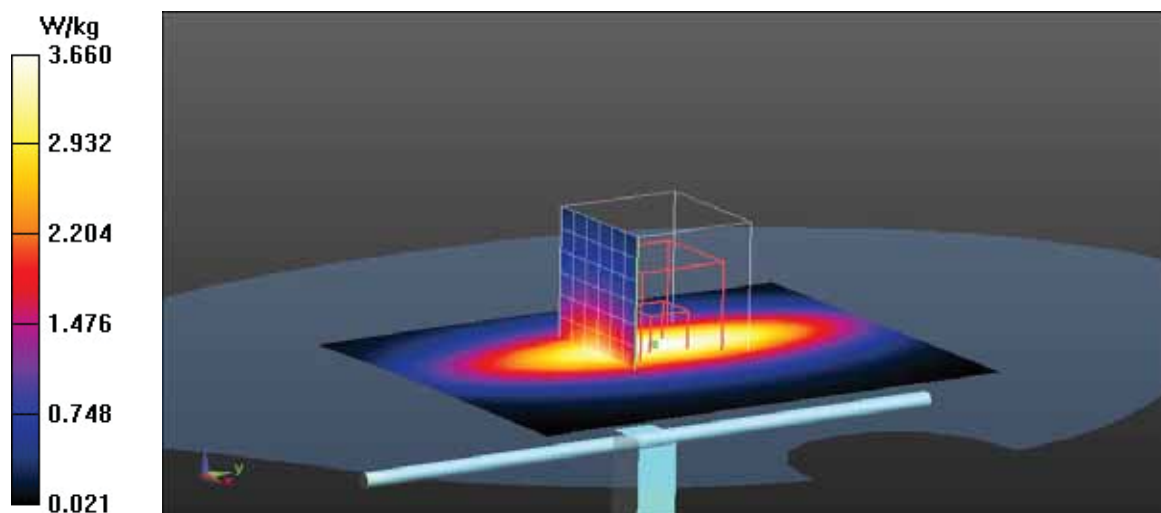

ANNEX C SAR Measurement Reports

Test Laboratory: Eurofins Product Service GmbH

GPRS 850 - Ch. 128 - 2xSlot - BOTTOM 0mm

DUT: Asthma Monitor AM3; Type: AM3 Option G+; Serial: -

Communication System: UID 0 - n/a, GPRS 850 2xSlot; Frequency: 824.2 MHz; Duty Cycle: 1:4.14954
Medium: Muscle 900 MHz Medium parameters used (interpolated): $f = 824.2$ MHz; $\sigma = 0.94$ S/m; $\epsilon_r = 53.408$;
 $\rho = 1000$ kg/m³
Phantom section: Flat Section

Measurement Standard: DASYS (IEEE/IEC/ANSI C63.19-2007)

DASY5.2 Configuration:

- Probe: EX3DV4 - SN3893; ConvF(10.35, 10.35, 10.35); Calibrated: 2016-09-23;
- Sensor-Surface: 1.4mm (Mechanical Surface Detection)
- Electronics: DAE3 Sn522; Calibrated: 2016-09-28
- Phantom: Flat Phantom ELI4.0; Type: QDOVA001BB; Serial: SN:1013
- Measurement SW: DASYS2, Version 52.8 (6); SEMCAD X Version 14.6.9 (7117)

Configuration/Flat BOTTOM 0mm/Area Scan (121x121x1): Interpolated grid: dx=1.000 mm, dy=1.000 mm
Maximum value of SAR (interpolated) = 0.793 W/kg

Configuration/Flat BOTTOM 0mm/Zoom Scan (7x7x7)/Cube 0: Measurement grid: dx=5mm, dy=5mm, dz=5mm
Reference Value = 25.431 V/m; Power Drift = -0.08 dB
Peak SAR (extrapolated) = 0.905 W/kg
SAR(1 g) = 0.532 W/kg; SAR(10 g) = 0.345 W/kg
Maximum value of SAR (measured) = 0.758 W/kg

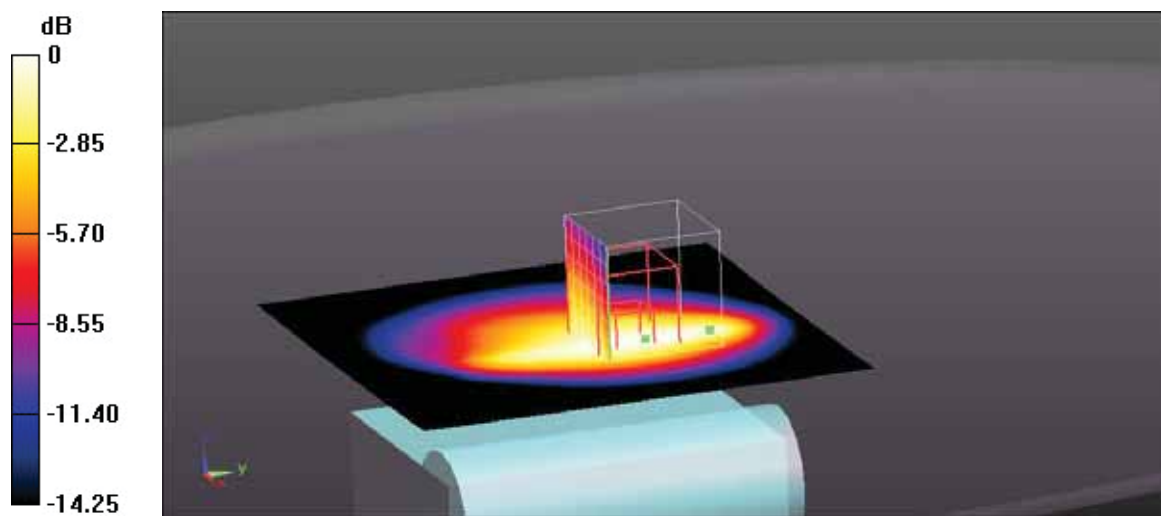

0 dB = 0.758 W/kg = -1.20 dBW/kg

Test Laboratory: Eurofins Product Service GmbH

GSM 1900 - Ch. 661 - 2xSlot - BOTTOM 0mm

DUT: Asthma Monitor AM3; Type: AM3 Option G+; Serial: -

Communication System: UID 0 - n/a, GPRS 1900 2xSlot; Frequency: 1880 MHz; Duty Cycle: 1:4.14954
Medium: Muscle 1900 MHz Medium parameters used: $f = 1880$ MHz; $\sigma = 1.476$ S/m; $\epsilon_r = 53.211$; $\rho = 1000$ kg/m³
Phantom section: Flat Section

Measurement Standard: DASYS (IEEE/IEC/ANSI C63.19-2007)

DASY5.2 Configuration:

- Probe: EX3DV4 - SN3893; ConvF(8.34, 8.34, 8.34); Calibrated: 2016-09-23;
- Sensor-Surface: 1.4mm (Mechanical Surface Detection)
- Electronics: DAE3 Sn522; Calibrated: 2016-09-28
- Phantom: Flat Phantom ELI4.0; Type: QDOVA001BB; Serial: SN:1013
- Measurement SW: DASYS2, Version 52.8 (6); SEMCAD X Version 14.6.9 (7117)

Configuration/Flat BOTTOM 0mm/Area Scan (121x121x1): Interpolated grid: dx=1.000 mm, dy=1.000 mm
Maximum value of SAR (interpolated) = 0.146 W/kg

Configuration/Flat BOTTOM 0mm/Zoom Scan (7x7x7)/Cube 0: Measurement grid: dx=5mm, dy=5mm, dz=5mm
Reference Value = 8.505 V/m; Power Drift = -0.10 dB
Peak SAR (extrapolated) = 0.172 W/kg
SAR(1 g) = 0.093 W/kg; SAR(10 g) = 0.054 W/kg
Maximum value of SAR (measured) = 0.140 W/kg

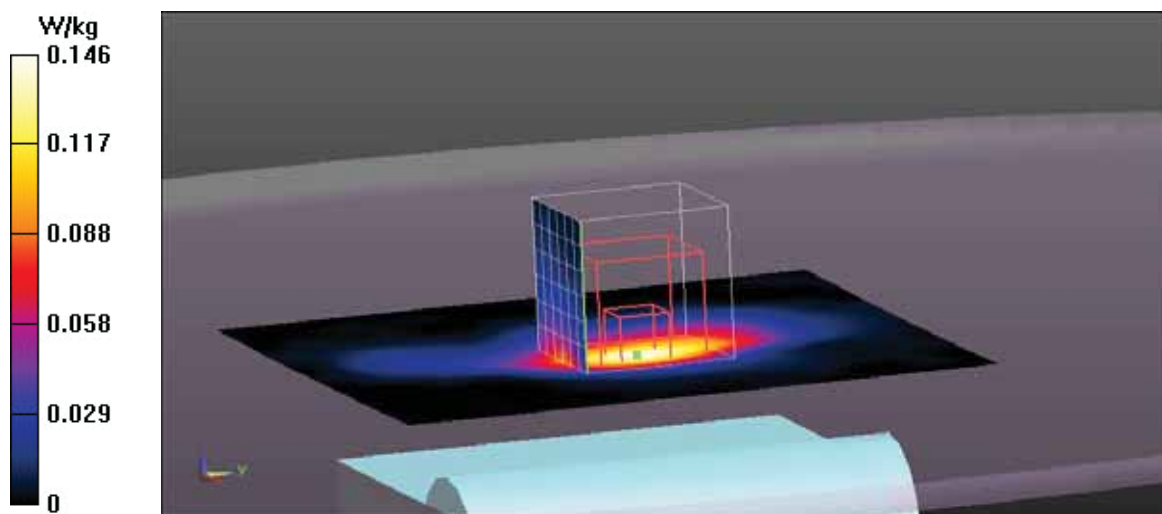

Test Laboratory: Eurofins Product Service GmbH

FDD V - Ch. 4182 - RMC-144kbps - BOTTOM 0mm

DUT: Asthma Monitor AM3; Type: AM3 Option G+; Serial: -

Communication System: UID 0 - n/a, UMTS FDD V; Frequency: 836.6 MHz; Duty Cycle: 1:2.18776
Medium: Muscle 900 MHz Medium parameters used (interpolated): $f = 836.6$ MHz; $\sigma = 0.953$ S/m; $\epsilon_r = 53.613$;
 $\rho = 1000$ kg/m³
Phantom section: Flat Section

Measurement Standard: DASYS (IEEE/IEC/ANSI C63.19-2007)

DASY5.2 Configuration:

- Probe: EX3DV4 - SN3893; ConvF(10.35, 10.35, 10.35); Calibrated: 2016-09-23;
- Sensor-Surface: 1.4mm (Mechanical Surface Detection)
- Electronics: DAE3 Sn522; Calibrated: 2016-09-28
- Phantom: Flat Phantom ELI4.0; Type: QDOVA001BB; Serial: SN:1013
- Measurement SW: DASYS2, Version 52.8 (6); SEMCAD X Version 14.6.9 (7117)

Configuration/Flat BOTTOM 0mm/Area Scan (121x121x1): Interpolated grid: dx=1.000 mm, dy=1.000 mm
Maximum value of SAR (interpolated) = 3.47 W/kg

Configuration/Flat BOTTOM 0mm/Zoom Scan (7x7x7)/Cube 0: Measurement grid: dx=5mm, dy=5mm, dz=5mm
Reference Value = 51.397 V/m; Power Drift = -0.08 dB
Peak SAR (extrapolated) = 4.22 W/kg
SAR(1 g) = 2.14 W/kg; SAR(10 g) = 1.22 W/kg
Maximum value of SAR (measured) = 3.38 W/kg

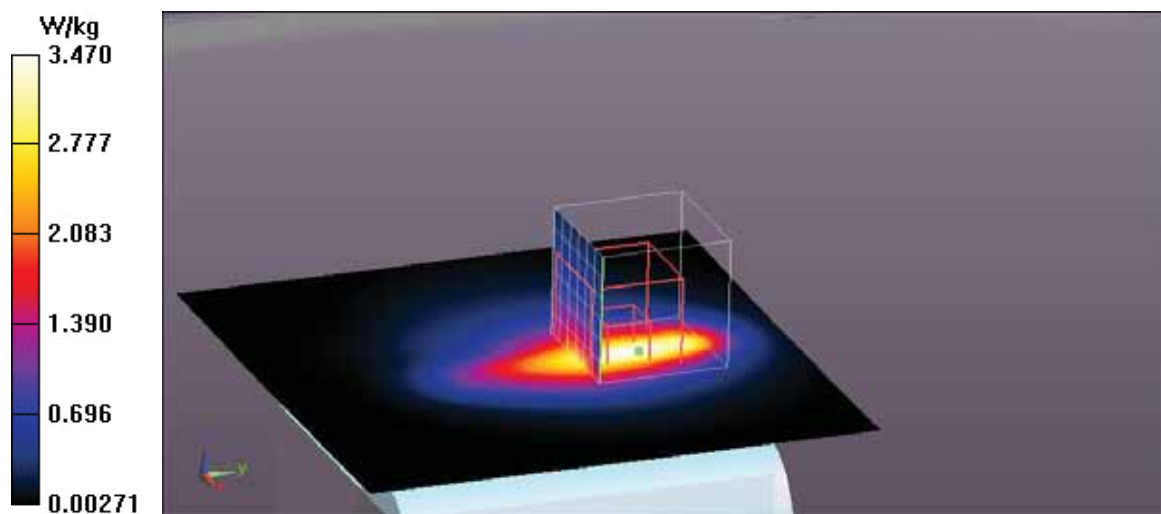

Test Laboratory: Eurofins Product Service GmbH

Bluetooth DH5 2402 MHz - BACK 0mm

DUT: Asthma Monitor AM3; Type: AM3 Option G+; Serial: -

Communication System: UID 0 - n/a, BT 2.4GHz DH5; Frequency: 2402 MHz; Duty Cycle: 1:1.38388
Medium: Muscle 2450 MHz Medium parameters used (interpolated): $f = 2402$ MHz; $\sigma = 1.941$ S/m; $\epsilon_r = 50.951$; $\rho = 1000$ kg/m³
Phantom section: Flat Section

Measurement Standard: DASYS (IEEE/IEC/ANSI C63.19-2007)

DASY5.2 Configuration:

- Probe: EX3DV4 - SN3893; ConvF(7.9, 7.9, 7.9); Calibrated: 2016-09-23;
- Sensor-Surface: 1.4mm (Mechanical Surface Detection)
- Electronics: DAE3 Sn522; Calibrated: 2016-09-28
- Phantom: Flat Phantom ELI4.0; Type: QDOVA001BB; Serial: SN:1013
- Measurement SW: DASYS2, Version 52.8 (6); SEMCAD X Version 14.6.9 (7117)

Configuration/Flat BACK 0mm/Area Scan (121x61x1): Interpolated grid: dx=1.000 mm, dy=1.000 mm

Maximum value of SAR (interpolated) = 0.0616 W/kg

Configuration/Flat BACK 0mm/Zoom Scan (7x7x7)/Cube 0: Measurement grid: dx=5mm, dy=5mm, dz=5mm

Reference Value = 4.965 V/m; Power Drift = -0.00 dB

Peak SAR (extrapolated) = 0.132 W/kg

SAR(1 g) = 0.041 W/kg; SAR(10 g) = 0.013 W/kg

Maximum value of SAR (measured) = 0.0820 W/kg

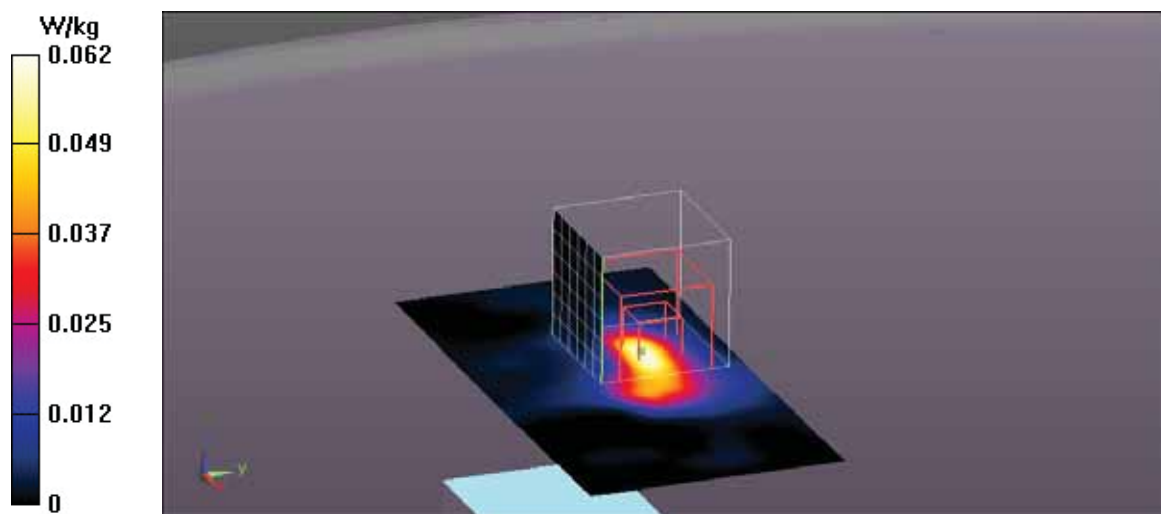

Test Laboratory: Eurofins Product Service GmbH

Bluetooth LE 2480 MHz - BACK 0mm

DUT: Asthma Monitor AM3; Type: AM3 Option G+; Serial: -

Communication System: UID 0 - n/a, Bluetooth Low Energy; Frequency: 2480 MHz; Duty Cycle: 1:3.54813
Medium: Muscle 2450 MHz Medium parameters used: $f = 2480$ MHz; $\sigma = 2.058$ S/m; $\epsilon_r = 50.755$; $\rho = 1000$ kg/m³

Phantom section: Flat Section

Measurement Standard: DASYS (IEEE/IEC/ANSI C63.19-2007)

DASY5.2 Configuration:

- Probe: EX3DV4 - SN3893; ConvF(7.9, 7.9, 7.9); Calibrated: 2016-09-23;
- Sensor-Surface: 1.4mm (Mechanical Surface Detection)
- Electronics: DAE3 Sn522; Calibrated: 2016-09-28
- Phantom: Flat Phantom ELI4.0; Type: QDOVA001BB; Serial: SN:1013
- Measurement SW: DASYS2, Version 52.8 (6); SEMCAD X Version 14.6.9 (7117)

Configuration/Flat BACK 0mm/Area Scan (121x61x1): Interpolated grid: dx=1.000 mm, dy=1.000 mm

Maximum value of SAR (interpolated) = 0.0682 W/kg

Configuration/Flat BACK 0mm/Zoom Scan (7x7x7)/Cube 0: Measurement grid: dx=5mm, dy=5mm, dz=5mm

Reference Value = 2.508 V/m; Power Drift = -0.09 dB

Peak SAR (extrapolated) = 0.0910 W/kg

SAR(1 g) = 0.030 W/kg; SAR(10 g) = 0.00905 W/kg

Maximum value of SAR (measured) = 0.0578 W/kg

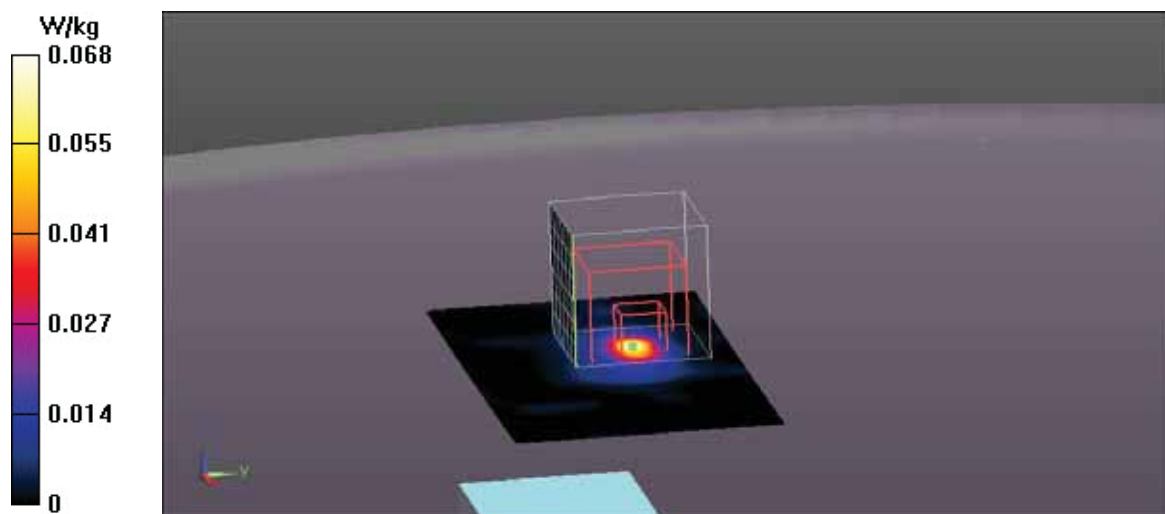

Test Laboratory: Eurofins Product Service GmbH

FDD II - Ch. 9263 - RMC-384kbps - BOTTOM 0mm

DUT: Asthma Monitor AM3; Type: AM3 Option G+; Serial: -

Communication System: UID 0 - n/a, UMTS FDD II; Frequency: 1852.6 MHz; Duty Cycle: 1:2.18776
Medium: Muscle 1900 MHz Medium parameters used (interpolated): $f = 1852.6$ MHz; $\sigma = 1.44$ S/m; $\epsilon_r = 53.329$; $\rho = 1000$ kg/m³
Phantom section: Flat Section

Measurement Standard: DASYS (IEEE/IEC/ANSI C63.19-2007)

DASY5.2 Configuration:

- Probe: EX3DV4 - SN3893; ConvF(8.34, 8.34, 8.34); Calibrated: 2016-09-23;
- Sensor-Surface: 1.4mm (Mechanical Surface Detection)
- Electronics: DAE3 Sn522; Calibrated: 2016-09-28
- Phantom: Flat Phantom ELI4.0; Type: QDOVA001BB; Serial: SN:1013
- Measurement SW: DASYS2, Version 52.8 (6); SEMCAD X Version 14.6.9 (7117)

Configuration/Flat BOTTOM 0mm/Area Scan (121x121x1): Interpolated grid: dx=1.000 mm, dy=1.000 mm
Maximum value of SAR (interpolated) = 3.59 W/kg

Configuration/Flat BOTTOM 0mm/Zoom Scan (7x7x7)/Cube 0: Measurement grid: dx=5mm, dy=5mm, dz=5mm
Reference Value = 47.850 V/m; Power Drift = -0.07 dB
Peak SAR (extrapolated) = 4.06 W/kg
SAR(1 g) = 2.28 W/kg; SAR(10 g) = 1.35 W/kg
Maximum value of SAR (measured) = 3.40 W/kg

