

FCC DoC Test Report

Equipment : Receiver for Level 10M Wireless Mouse
Model No. : MO-LTM-RX
Brand Name : Thermaltake
Applicant : Thermaltake Technology Co., Ltd.
Address : 5F., No.185, Sec. 2, Tiding Blvd., Neihu Dist.,
Taipei City 114, Taiwan
Standard : FCC Part 15, Subpart B, Class B
ICES-003 Issue 5
ANSI C63.4:2009
Received Date : Nov. 04, 2013
Tested Date : Nov. 05 ~ Nov. 07, 2013

We, International Certification Corp., would like to declare that the tested sample has been evaluated and in compliance with the requirement of the above standards. It may be duplicated completely for legal use with the approval of the applicant. It shall not be reproduced except in full without the written approval of our laboratory.

Approved & Reviewed by:



Kent Chen / Assistant Manager



Table of Contents

1	GENERAL DESCRIPTION	5
1.1	Information.....	5
1.2	Accessories	5
1.3	Test Equipment and Calibration Data	6
1.4	Testing Applied Standards	7
1.5	Measurement Uncertainty	7
2	TEST CONFIGURATION.....	8
2.1	Testing Condition	8
2.2	Local Support Equipment List	9
2.3	Test Setup Chart	9
2.4	Test Software and Operating Condition	10
3	EMISSION TESTS RESULTS	11
3.1	Conducted Emissions.....	11
3.2	Radiated Emissions.....	15
4	PHOTOGRAPHS OF THE TEST CONFIGURATION	22
5	TEST LABORATORY INFORMATION	25

Release Record

Report No.	Version	Description	Issued Date
FD3N0402	Rev. 01	Initial issue	Jan. 06, 2014

Summary of Test Results

FCC Part 15, Subpart B Emission Tests				
Ref. Std. Clause	Test Standard	Test Items	Measured	Result
15.107	FCC Part 15, Subpart B, Class B	Conducted Emissions	-9.21dB AV@ 0.164MHz.	Pass
15.109	FCC Part 15, Subpart B, Class B	Radiated Emissions	-4.10dB QP@ 166.27MHz.	Pass

1 General Description

1.1 Information

1.1.1 Feature of Equipment under Test (EUT)

Power Supply Type	5Vdc from Host
Highest Frequency of the Internal Sources	5.85GHz

1.2 Accessories

N/A

1.3 Test Equipment and Calibration Data

Test Item	Conducted Emission				
Test Site	Conduction room 1 / (CO01-WS)				
Instrument	Manufacturer	Model No.	Serial No.	Calibration Date	Calibration Until
EMC Receiver	R&S	ESCS 30	100169	Oct. 15, 2013	Oct. 14, 2014
LISN	SCHWARZBECK MESS-ELEKTRONIK	Schwarzbeck 8127	8127-667	Dec. 04, 2012	Dec. 03, 2013
LISN (Support Unit)	SCHWARZBECK MESS-ELEKTRONIK	Schwarzbeck 8127	8127-666	Dec. 04, 2012	Dec. 03, 2013
ISN	TESEQ	ISN T800	34406	Apr. 08, 2013	Apr. 07, 2014
ISN	TESEQ	ISN T200A	30494	Apr. 09, 2013	Apr. 08, 2014
ISN	TESEQ	ISN ST08	22589	Jan. 24, 2013	Jan. 23, 2014
RF Current Probe	FCC	F-33-4	121630	Dec. 04, 2012	Dec. 03, 2013
RF Cable-CON	Woken	CFD200-NL	CFD200-NL-001	Dec. 25, 2012	Dec. 24, 2013
ESH3-Z6 V-Network(+)	R&S	ESH3-Z6	100920	Nov. 21, 2012	Nov. 20, 2013
ESH3-Z6 V-Network(-)	R&S	ESH3-Z6	100951	Jan. 30, 2013	Jan. 29, 2014
Two-Line V-Network	R&S	ENV216	101579	Jan. 07, 2013	Jan. 06, 2014
50 ohm terminal	NA	50	01	Apr. 22, 2013	Apr. 21, 2014
50 ohm terminal	NA	50	02	Apr. 22, 2013	Apr. 21, 2014
50 ohm terminal	NA	50	03	Apr. 22, 2013	Apr. 21, 2014
50 ohm terminal (Support Unit)	NA	50	04	Apr. 22, 2013	Apr. 21, 2014
Note: Calibration Interval of instruments listed above is one year.					

Test Item	Radiated Emission below 1GHz				
Test Site	Open Area Test Site 1 / (OS01-LK)				
Instrument	Manufacturer	Model No.	Serial No.	Calibration Date	Calibration Until
Open Area Test Site	SPORTON	OATS-10	OS01-LK	Oct. 19, 2013	Oct. 18, 2014
Amplifier	HP	8447D	2944A07523	Jun. 10, 2013	Jun. 09, 2014
EMI Test Receiver	R&S	ESR3	101659	Feb. 04, 2013	Feb. 03, 2014
Bilog Antenna	Schaffner	CBL6112B	2687	Oct. 14, 2013	Oct. 13, 2014
RF Cable-R03m	BELDEN	RG8/U	CB015	Dec. 25, 2012	Dec. 24, 2013
RF Cable-R10m	BELDEN	RG8/U	CB016	Dec. 25, 2012	Dec. 24, 2013
Note: Calibration Interval of instruments listed above is one year.					

Test Item	Radiated Emission above 1GHz				
Test Site	966 chamber1 / (03CH01-WS)				
Instrument	Manufacturer	Model No.	Serial No.	Calibration Date	Calibration Until
3m semi-anechoic chamber	CHAMPRO	SAC-03	03CH01-WS	Jan. 04, 2013	Jan. 03, 2014
Spectrum Analyzer	R&S	FSV40	101498	Jan. 24, 2013	Jan. 23, 2014
Receiver	ROHDE&SCHWARZ	ESR3	101658	Jan. 28, 2013	Jan. 27, 2014
Bilog Antenna	SCHWARZBECK	VULB9168	VULB9168-522	Jan. 11, 2013	Jan. 10, 2014
Horn Antenna 1G-18G	SCHWARZBECK	BBHA 9120 D	BBHA 9120 D 1096	Feb. 18, 2013	Feb. 17, 2014
Horn Antenna 18G-40G	SCHWARZBECK	BBHA 9170	BBHA 9170517	Jan. 14, 2013	Jan. 13, 2014
Amplifier	Burgeon	BPA-530	100219	Nov. 28, 2012	Nov. 27, 2013
Amplifier	Agilent	83017A	MY39501308	Dec. 18, 2012	Dec. 17, 2013
RF Cable	HUBER+SUHNER	SUCOFLEX104	MY16014/4	Dec. 25, 2012	Dec. 24, 2013
RF Cable	HUBER+SUHNER	SUCOFLEX104	MY16019/4	Dec. 25, 2012	Dec. 24, 2013
RF Cable	HUBER+SUHNER	SUCOFLEX104	MY16139/4	Dec. 25, 2012	Dec. 24, 2013
RF Cable-R03m	Woken	CFD400NL-LW	CFD400NL-001	Dec. 25, 2012	Dec. 24, 2013
RF Cable-R10m	Woken	CFD400NL-LW	CFD400NL-002	Dec. 25, 2012	Dec. 24, 2013
control	EM Electronics	EM1000	60612	N/A	N/A
Note: Calibration Interval of instruments listed above is one year.					

1.4 Testing Applied Standards

According to the specifications of the manufacturer, the EUT must comply with the requirements of the following standards:

FCC Part 15, Subpart B, Class B
ICES-003 Issue 5
ANSI C63.4:2009

1.5 Measurement Uncertainty

ISO/IEC 17025 requires that an estimate of the measurement uncertainties associated with the emissions test results be included in the report. The measurement uncertainties given below are based on a 95% confidence level (based on a coverage factor (k=2))

Measurement Uncertainty		
Test Item	Frequency	Uncertainty
Conducted Emissions	150kHz ~ 30MHz	2.8 dB
	30MHz ~ 1GHz	3.9 dB
Radiated Emissions	Above 1GHz	4.2 dB

2 Test Configuration

2.1 Testing Condition

Test Item	Test Site	Ambient Condition	Tested By
AC Conduction	CO01-WS	21°C/58%	Skys Huang
Radiated Emissions below 1GHz	OS01-LK	21°C/81%	Alex Tsai
Radiated Emissions above 1GHz	03CH01-WS	22°C/69%	Anderson Hong

The EUT consumes power from host (notebook) 100~240Vac, 50/60Hz.

For radiated emission evaluation, 120Vac/60Hz (for FCC Part 15), and 110Vac/60Hz (for CNS13438) had been covered during the pretest. The worst radiated emission below 1GHz data was found at 110Vac/60Hz and recorded in the applied test report.

2.2 Local Support Equipment List

Support Equipment List					
No.	Equipment	Brand	Model	S/N	Signal cable / Length (m)
1	Notebook	DELL	Latitude E5430	6R4RWW1	---
2	Printer	EPSON	XP-30	QSDK0024 10	USB, 1.8m shielded w/o core.
3	Monitor	DELL	U2410f	A5WL	VGA, 1.8m shielded with 2 cores.
4	HDD	WD	WDBKXH 5000ABK	WX31AB21 0213	USB, 0.5m shielded w/o core.
5	Mouse	Thermaltake	MO-LTM-H YLO	---	---

No.5 was supplied by applicant.

2.3 Test Setup Chart

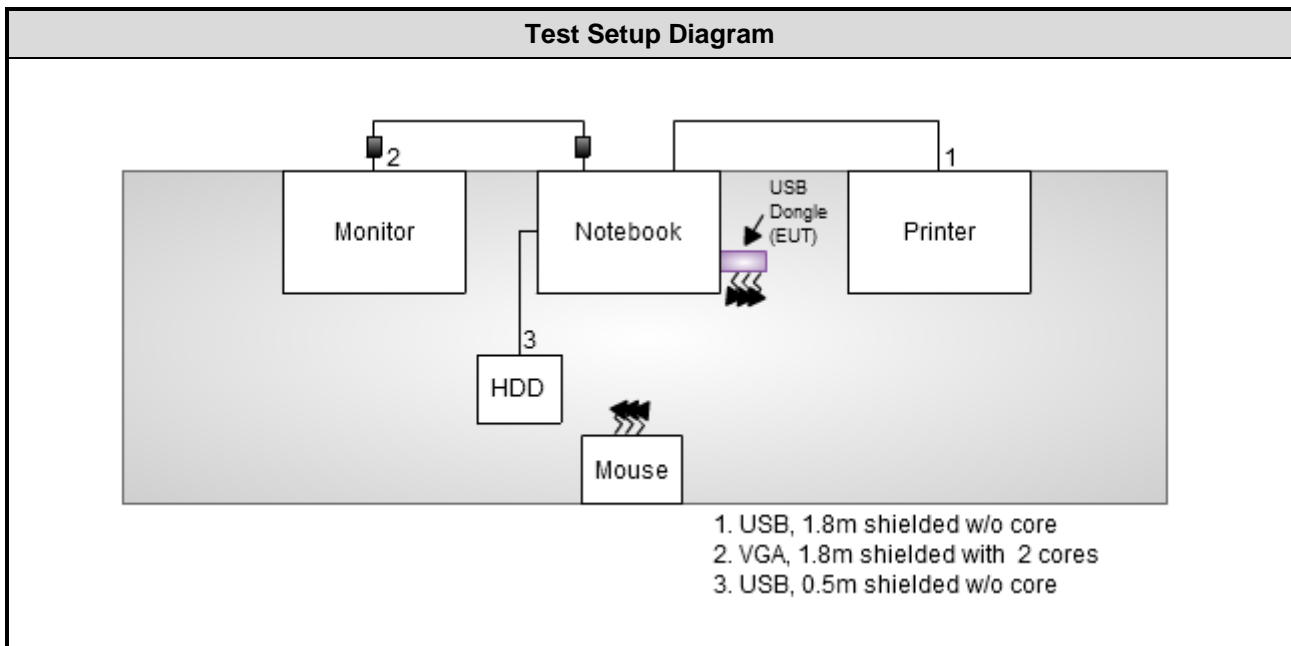

2.4 Test Software and Operating Condition

- a. The notebook ran "EMCTest.exe" to enable all functions of test system.
- b. The notebook sent "H" patterns to its monitor and the monitor displayed them.
- c. The notebook sent "H" patterns to the monitor and the monitor displayed them.
- d. The notebook sent "H" patterns to the printer.
- e. The notebook read and wrote data with the external HDD.
- f. The EUT linked with its receiver by WLAN.
- g. The notebook executes "mspaint.exe", and moved the EUT over the Paint and checks function.

3 Emission Tests Results

3.1 Conducted Emissions

3.1.1 Limit of Conducted Emissions

Applicable Standard: FCC Part 15, Subpart B §15.107, ICES-003 §5.2 for class A, §5.3 for class B				
Frequency Range (MHz)	Class A (dB μ V)		Class B (dB μ V)	
	Limits			
	Quasi-peak	Average	Quasi-peak	Average
0.15 to 0.50	79	66	66 to 56	56 to 46
0.50 to 5	73	60	56	46
5 to 30	73	60	60	50

Note 1: The lower limit shall apply at the transition frequencies.
 Note 2: The limit decreases linearly with the logarithm of the frequency in the range 0.15 MHz to 0.50 MHz.

3.1.2 Test Procedures

- The EUT was placed on a table with a height of 0.8 meters from the metal ground plane and 0.4 meters from the conducting wall of the shielding room and it was kept at least 0.8 meters from any other grounded conducting surface.
- The test equipment EUT installed received DC power through a Line Impedance Stabilization Network (LISN), which supplied power source and was grounded to the ground plane.
- All the support units were connected to the other LISN.
- The LISN provides 50 ohm coupling impedance for the measuring instrument.
- The CISPR states that a 50 ohm, 50 microhenry LISN should be used.
- Both sides of AC line were checked for maximum conducted interference.
- The measurement frequency range extends from 150 kHz to 30 MHz.
- Set the test-receiver system to Peak Detect Function and Specified Bandwidth with Maximum Hold Mode.

3.1.3 Test Setup

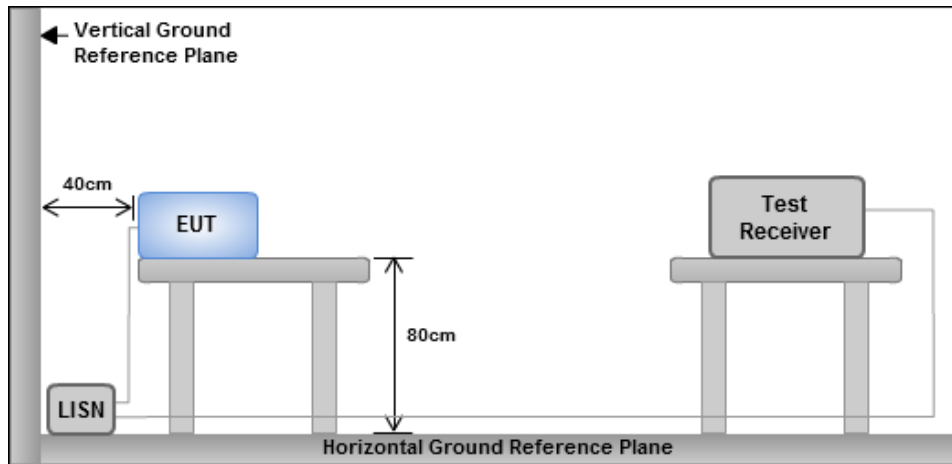

- Note: 1. Support units were connected to second LISN.
2. Both of LISNs (AMN) are 80 cm from EUT and at least 80 cm from other units and other metal planes

3.1.4 Test Result of Conducted Emissions

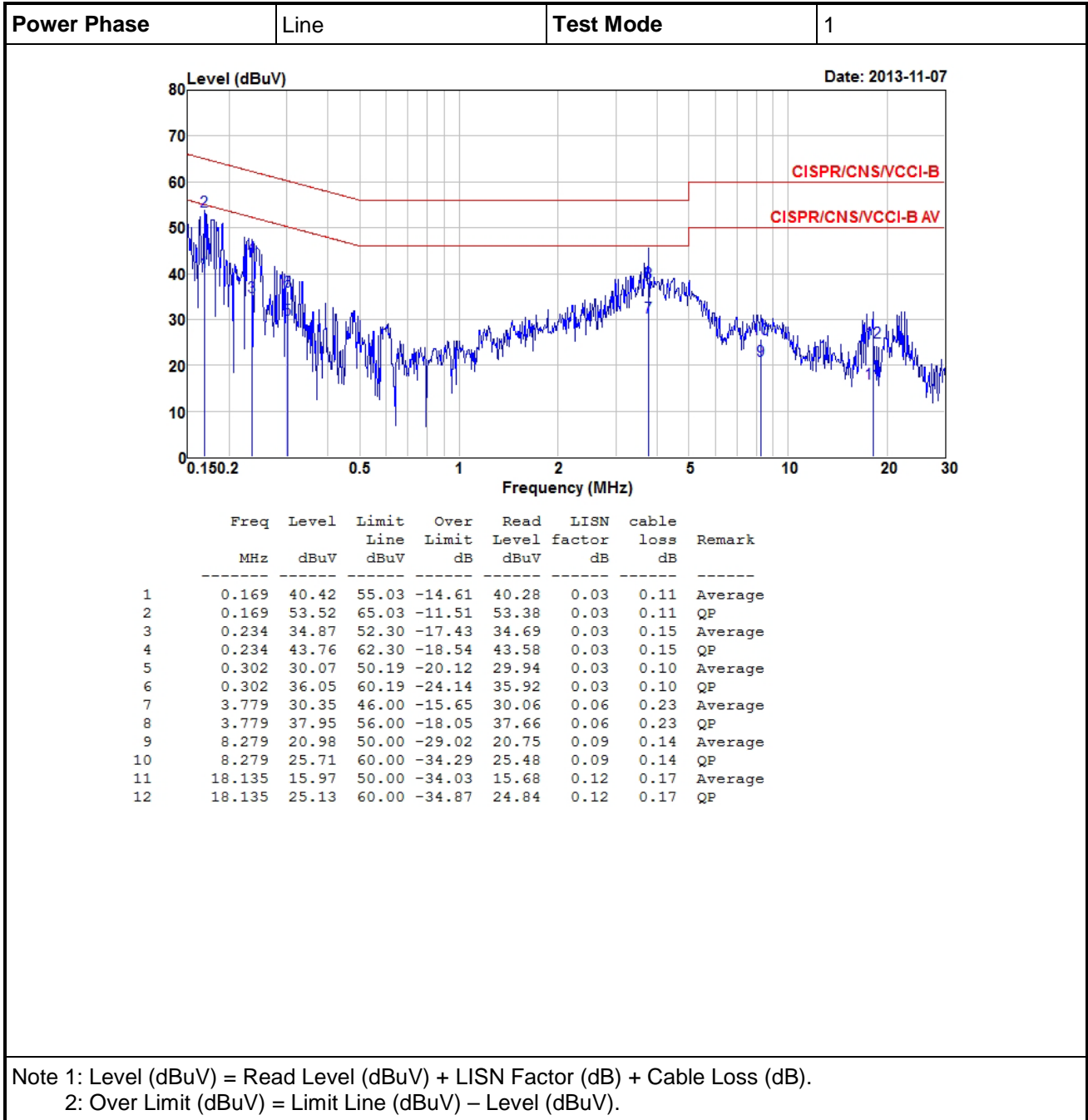

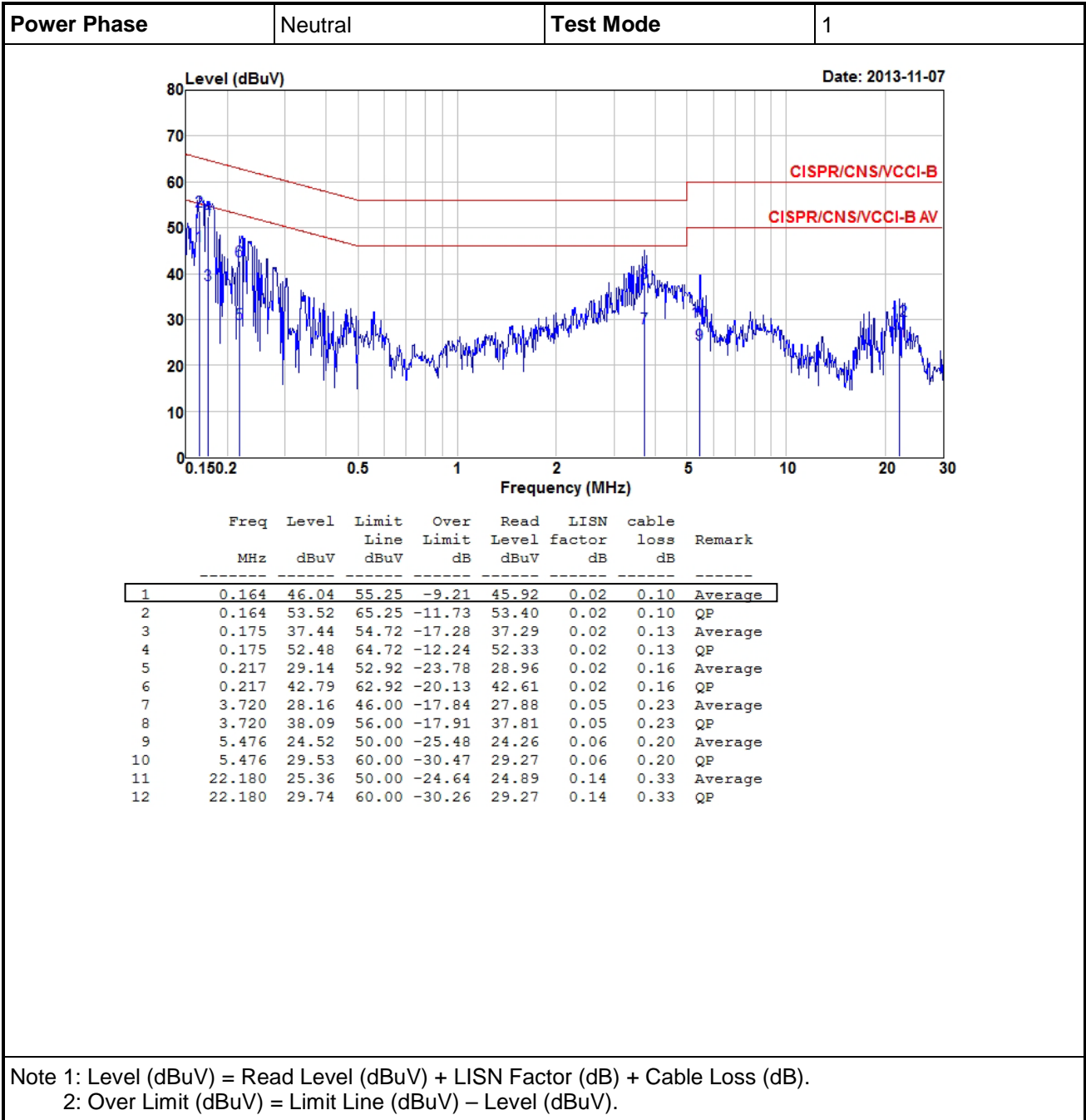

3.2 Radiated Emissions

3.2.1 Limit of Radiated Emissions

Applicable Standard: FCC Part 15, Subpart B §15.109, ICES-003 §5.4 for class A, §5.5 for class B		
Frequency Range (MHz)	Class A (10 m)	Class B (10 m)
	Quasi-peak limits (dB μ V/m)	
30 to 230	40	30
230 to 1000	47	37

Note 1: The lower limit shall apply at the transition frequency.
Note 2: Additional provisions may be required for cases where interference occurs.

Note:

- 1) According to FCC Part 15, Subpart B §15.109(g): As an alternative to the radiated emission limits shown in paragraphs (a) and (b) of this section, digital devices may be shown to comply with the standards contained in Third Edition of the International Special Committee on Radio Interference (CISPR), Pub. 22, "Information Technology Equipment – Radio Disturbance Characteristics – Limits and Methods of Measurement."
- 2) The CISPR 22 §6 standard limits are applied to the test data hereinafter.

Frequency range (GHz)	Class A (3 m)		Class B (3 m)	
	Average limit (dB μ V/m)	Peak limit (dB μ V/m)	Average limit (dB μ V/m)	Peak limit (dB μ V/m)
Above 1000	60	80	54	74

Note 1: The lower limit shall apply at the transition frequency.
Note 2: Additional provisions may be required for cases where interference occurs.

Highest frequency generated or used in the device or on which the device operates or tunes (MHz)	Upper frequency of measurement range (MHz)
Below 1.705	30
1.705-108	1000
108-500	2000
500-1000	5000
Above 1000	5th harmonic of the highest frequency or 40 GHz, whichever is lower

Note: According to FCC Part 15, Subpart B §15.33: For an unintentional radiator is shown in the table above.

3.2.2 Test Procedures

Measuring below 1 GHz:

- a. The EUT was placed on a rotatable table top with a height of 0.8 meters which is placed on the ground plane.
- b. The EUT received DC power source from the outlet socket under the turntable. All support equipment power received from another socket under the turntable.
- c. The EUT was set 10 meters from the interference receiving antenna which was mounted on the top of a variable height antenna tower.
- d. The table was rotated 360 degrees to determine the position of the highest radiation.
- e. The antenna is a half wave dipole and its height is varied between one meter and four meters above ground to find the maximum value of the field strength both horizontal polarization and vertical polarization of the antenna are set to make the measurement.
- f. For each suspected emission the EUT was arranged to its worst case and then tune the antenna tower (from 1 to 4 meters) and turn table (from 0 to 360 degrees) to find the maximum reading.
- g. Set the test-receiver system to Peak Detect Function and specified bandwidth with Maximum Hold Mode.
- h. If the emission level of the EUT in peak mode was 2 dB lower than the limit specified, then testing will be stopped and peak values of EUT will be reported, otherwise, the emissions which do not have 2 dB margin will be repeated one by one using the quasi-peak method and reported.

Measuring above 1 GHz:

- a. Same test set up as below 1GHz radiated testing.
- b. The EUT was set 3 meters from the interference-receiving antenna which was mounted on the top of a variable height antenna tower.
- c. There should be absorber placed between the EUT and Antenna and its located size should let the test site meet CISPR16-1-4 requirement.
- d. The table was rotated 360 degrees to determine the position of the highest radiation.
- e. Set the test-receiver system to Peak Detect Function and specified bandwidth with Maximum Hold Mode.
- f. Set the Horn Antenna at 1m height, then run the turn table to get the maximum noise reading from Horizontal and Vertical polarity separately.
- g. When EUT locating on the turn-table, the Horn Antenna must be raised up and descended down, then turning around the turn-table to get the maximum noise reading of the Horizontal and Vertical polarity separately. Note the maximum raise up height is same as the top of EUT.
- h. If emission level of the EUT in peak mode was 20dB lower than average limit (that means the emission level in peak mode also complies with the limit in average mode), then testing will be stopped and peak values of EUT will be reported, otherwise, the emissions will be measured in average mode again and reported.

3.2.3 Test Setup

Radiated Emissions below 1 GHz

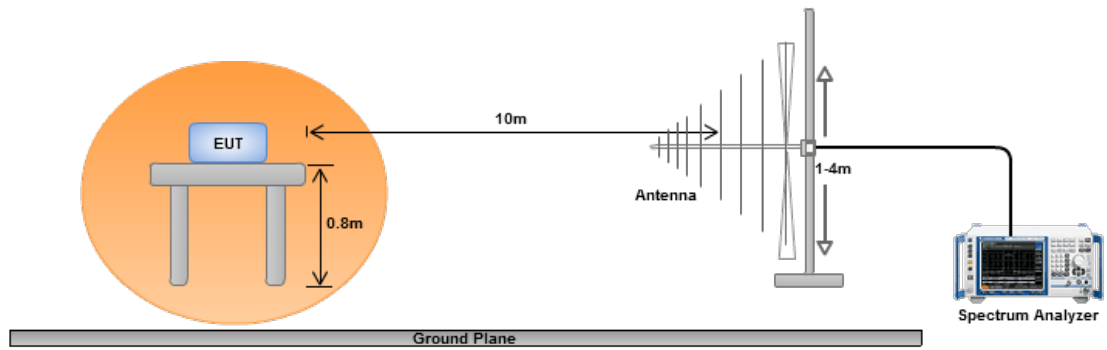

Radiated Emissions above 1 GHz

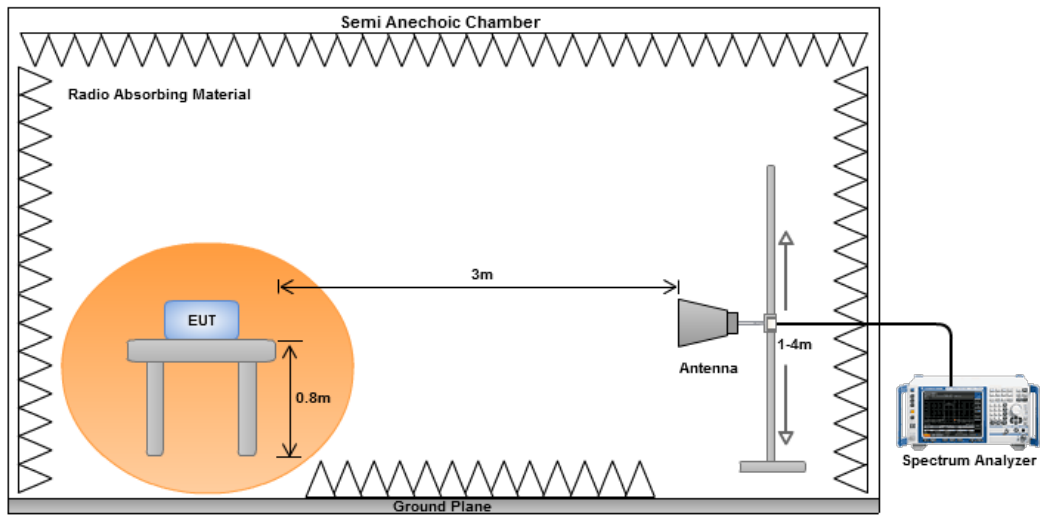

3.2.4 Radiated Emissions (Below 1GHz)

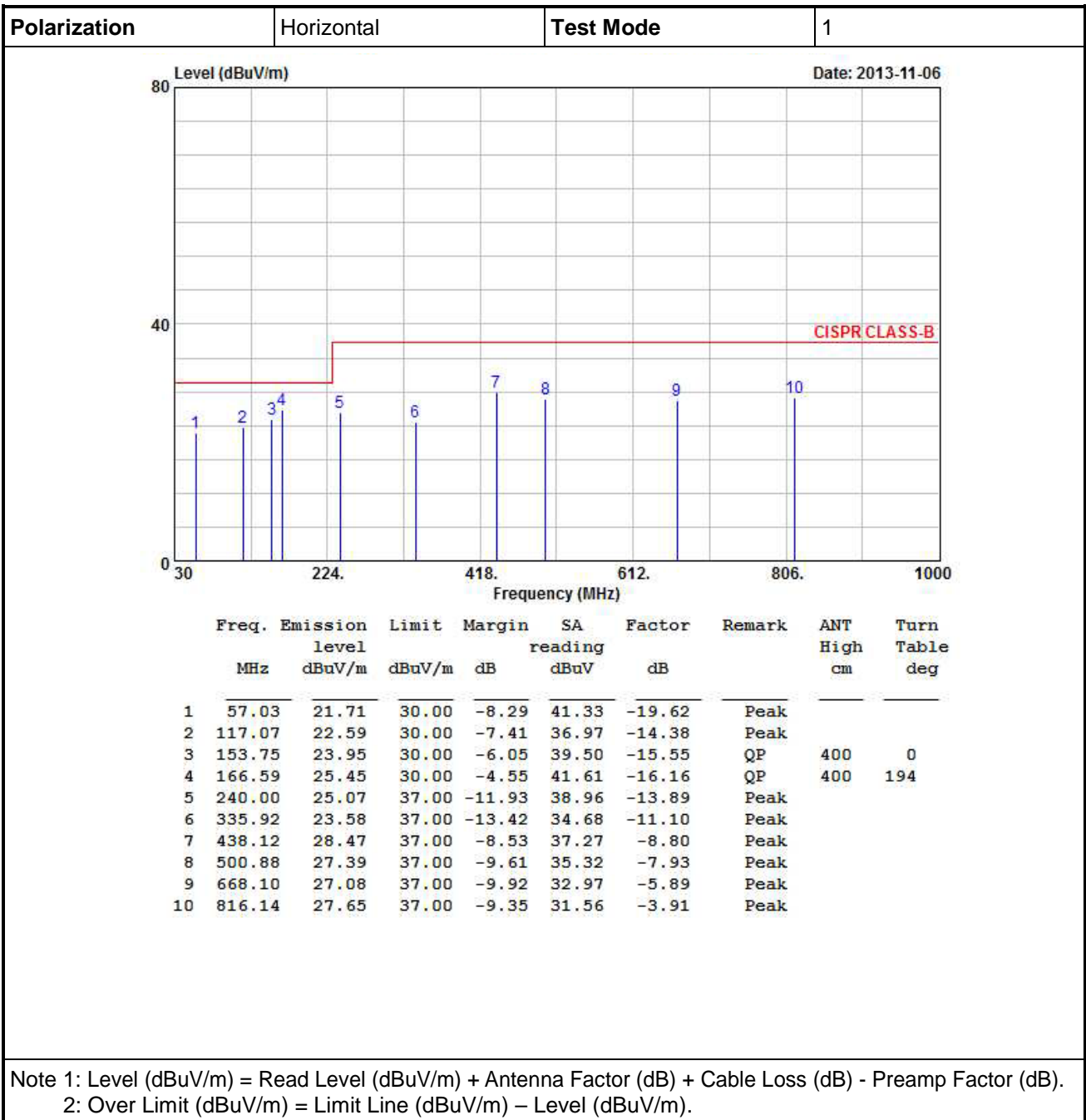

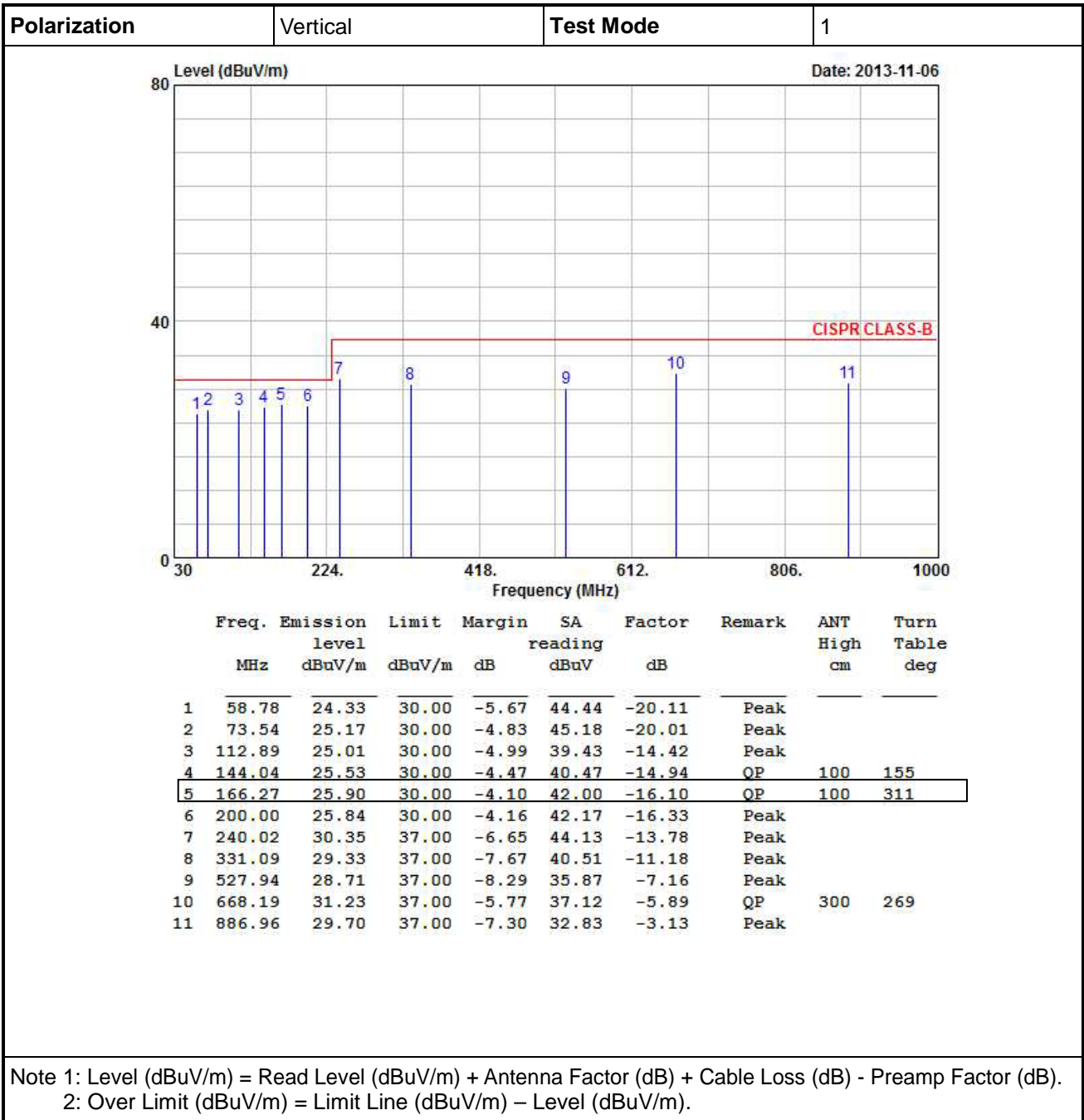

3.2.5 Radiated Emissions (Above 1GHz)

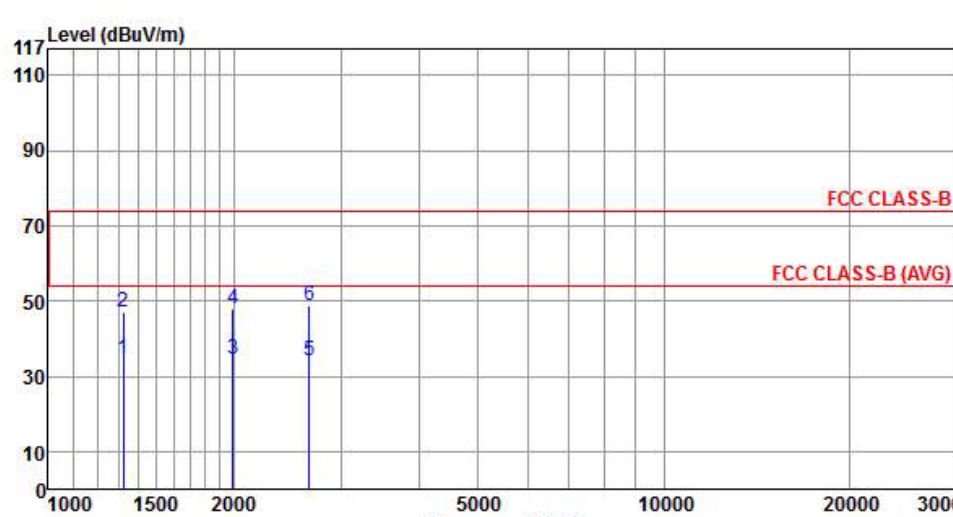
Polarization	Horizontal	Test Mode	1																																																																												
																																																																															
	<table border="1"> <thead> <tr> <th>Freq.</th> <th>Emission level</th> <th>Limit</th> <th>Margin</th> <th>SA reading</th> <th>Factor</th> <th>Remark</th> <th>ANT High</th> <th>Turn Table</th> </tr> <tr> <th>MHz</th> <th>dBuV/m</th> <th>dBuV/m</th> <th>dB</th> <th>dBuV</th> <th>dB</th> <th></th> <th>cm</th> <th>deg</th> </tr> </thead> <tbody> <tr> <td>1</td> <td>1325.00</td> <td>34.48</td> <td>54.00</td> <td>-19.52</td> <td>42.04</td> <td>-7.56</td> <td>Average</td> <td>108</td> <td>206</td> </tr> <tr> <td>2</td> <td>1325.00</td> <td>47.10</td> <td>74.00</td> <td>-26.90</td> <td>54.66</td> <td>-7.56</td> <td>Peak</td> <td>108</td> <td>206</td> </tr> <tr> <td>3</td> <td>1996.00</td> <td>34.66</td> <td>54.00</td> <td>-19.34</td> <td>39.62</td> <td>-4.96</td> <td>Average</td> <td>100</td> <td>185</td> </tr> <tr> <td>4</td> <td>1996.00</td> <td>47.93</td> <td>74.00</td> <td>-26.07</td> <td>52.89</td> <td>-4.96</td> <td>Peak</td> <td>100</td> <td>185</td> </tr> <tr> <td>5</td> <td>2651.00</td> <td>34.27</td> <td>54.00</td> <td>-19.73</td> <td>36.44</td> <td>-2.17</td> <td>Average</td> <td>102</td> <td>293</td> </tr> <tr> <td>6</td> <td>2651.00</td> <td>49.00</td> <td>74.00</td> <td>-25.00</td> <td>51.17</td> <td>-2.17</td> <td>Peak</td> <td>102</td> <td>293</td> </tr> </tbody> </table>	Freq.	Emission level	Limit	Margin	SA reading	Factor	Remark	ANT High	Turn Table	MHz	dBuV/m	dBuV/m	dB	dBuV	dB		cm	deg	1	1325.00	34.48	54.00	-19.52	42.04	-7.56	Average	108	206	2	1325.00	47.10	74.00	-26.90	54.66	-7.56	Peak	108	206	3	1996.00	34.66	54.00	-19.34	39.62	-4.96	Average	100	185	4	1996.00	47.93	74.00	-26.07	52.89	-4.96	Peak	100	185	5	2651.00	34.27	54.00	-19.73	36.44	-2.17	Average	102	293	6	2651.00	49.00	74.00	-25.00	51.17	-2.17	Peak	102	293
Freq.	Emission level	Limit	Margin	SA reading	Factor	Remark	ANT High	Turn Table																																																																							
MHz	dBuV/m	dBuV/m	dB	dBuV	dB		cm	deg																																																																							
1	1325.00	34.48	54.00	-19.52	42.04	-7.56	Average	108	206																																																																						
2	1325.00	47.10	74.00	-26.90	54.66	-7.56	Peak	108	206																																																																						
3	1996.00	34.66	54.00	-19.34	39.62	-4.96	Average	100	185																																																																						
4	1996.00	47.93	74.00	-26.07	52.89	-4.96	Peak	100	185																																																																						
5	2651.00	34.27	54.00	-19.73	36.44	-2.17	Average	102	293																																																																						
6	2651.00	49.00	74.00	-25.00	51.17	-2.17	Peak	102	293																																																																						
<p>Note 1: Level (dBuV/m) = Read Level (dBuV/m) + Antenna Factor (dB) + Cable Loss (dB) - Preamp Factor (dB). 2: Over Limit (dBuV/m) = Limit Line (dBuV/m) – Level (dBuV/m).</p>																																																																															

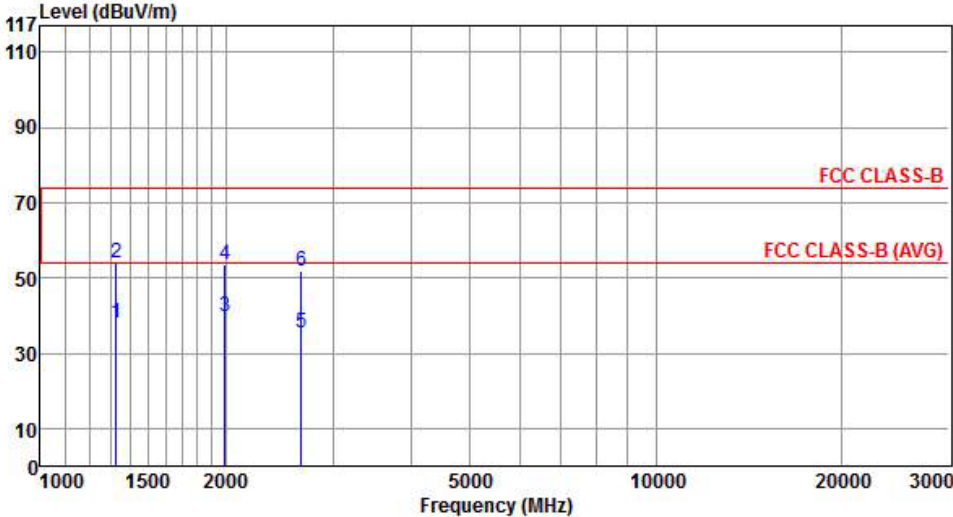
Polarization	Vertical	Test Mode	1																																																																													
																																																																																
	<table border="1"> <thead> <tr> <th>Freq.</th> <th>Emission level</th> <th>Limit</th> <th>Margin</th> <th>SA reading</th> <th>Factor</th> <th>Remark</th> <th>ANT High</th> <th>Turn Table</th> </tr> <tr> <th>MHz</th> <th>dBuV/m</th> <th>dBuV/m</th> <th>dB</th> <th>dBuV</th> <th>dB</th> <th></th> <th>cm</th> <th>deg</th> </tr> </thead> <tbody> <tr> <td>1</td> <td>1327.00</td> <td>37.88</td> <td>54.00</td> <td>-16.12</td> <td>45.43</td> <td>-7.55</td> <td>105</td> <td>329</td> </tr> <tr> <td>2</td> <td>1327.00</td> <td>53.84</td> <td>74.00</td> <td>-20.16</td> <td>61.39</td> <td>-7.55</td> <td>105</td> <td>329</td> </tr> <tr> <td>3</td> <td>1995.00</td> <td>39.62</td> <td>54.00</td> <td>-14.38</td> <td>44.58</td> <td>-4.96</td> <td>123</td> <td>31</td> </tr> <tr> <td>4</td> <td>1995.00</td> <td>53.43</td> <td>74.00</td> <td>-20.57</td> <td>58.39</td> <td>-4.96</td> <td>123</td> <td>31</td> </tr> <tr> <td>5</td> <td>2658.00</td> <td>35.51</td> <td>54.00</td> <td>-18.49</td> <td>37.65</td> <td>-2.14</td> <td>109</td> <td>308</td> </tr> <tr> <td>6</td> <td>2658.00</td> <td>51.94</td> <td>74.00</td> <td>-22.06</td> <td>54.08</td> <td>-2.14</td> <td>109</td> <td>308</td> </tr> </tbody> </table>	Freq.	Emission level	Limit	Margin	SA reading	Factor	Remark	ANT High	Turn Table	MHz	dBuV/m	dBuV/m	dB	dBuV	dB		cm	deg	1	1327.00	37.88	54.00	-16.12	45.43	-7.55	105	329	2	1327.00	53.84	74.00	-20.16	61.39	-7.55	105	329	3	1995.00	39.62	54.00	-14.38	44.58	-4.96	123	31	4	1995.00	53.43	74.00	-20.57	58.39	-4.96	123	31	5	2658.00	35.51	54.00	-18.49	37.65	-2.14	109	308	6	2658.00	51.94	74.00	-22.06	54.08	-2.14	109	308							
Freq.	Emission level	Limit	Margin	SA reading	Factor	Remark	ANT High	Turn Table																																																																								
MHz	dBuV/m	dBuV/m	dB	dBuV	dB		cm	deg																																																																								
1	1327.00	37.88	54.00	-16.12	45.43	-7.55	105	329																																																																								
2	1327.00	53.84	74.00	-20.16	61.39	-7.55	105	329																																																																								
3	1995.00	39.62	54.00	-14.38	44.58	-4.96	123	31																																																																								
4	1995.00	53.43	74.00	-20.57	58.39	-4.96	123	31																																																																								
5	2658.00	35.51	54.00	-18.49	37.65	-2.14	109	308																																																																								
6	2658.00	51.94	74.00	-22.06	54.08	-2.14	109	308																																																																								
<p>Note 1: Level (dBuV/m) = Read Level (dBuV/m) + Antenna Factor (dB) + Cable Loss (dB) - Preamp Factor (dB). 2: Over Limit (dBuV/m) = Limit Line (dBuV/m) – Level (dBuV/m).</p>																																																																																

4 Photographs of the Test Configuration

Conducted Emission Test

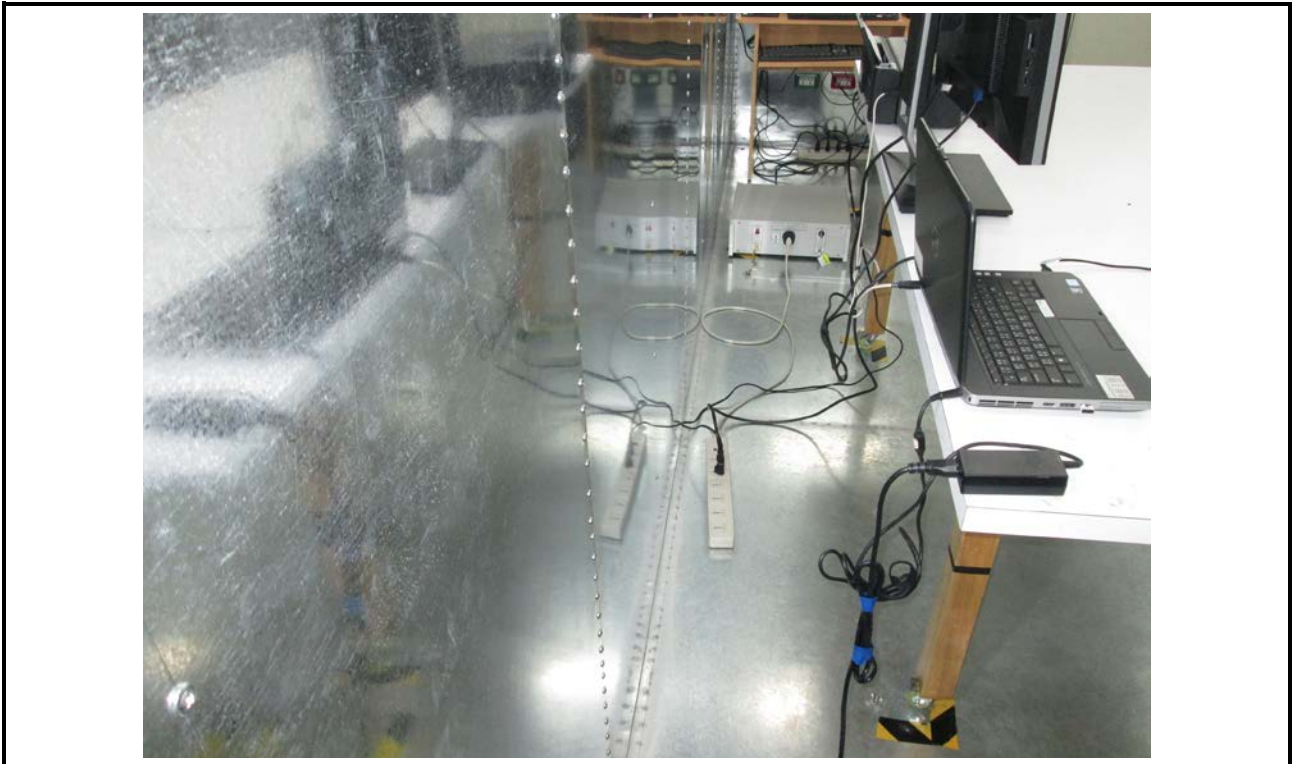

Radiated Emission Below 1GHz Test



Radiated Emission Above 1GHz Test

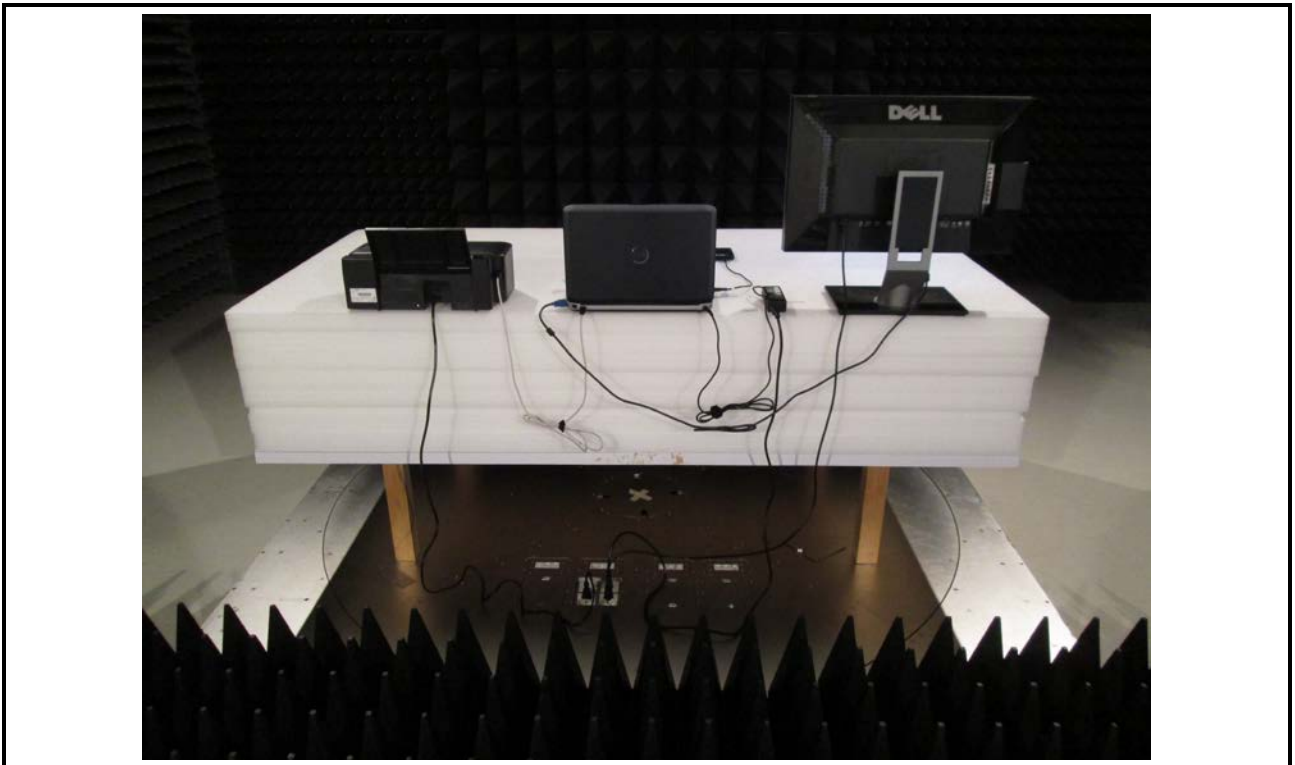
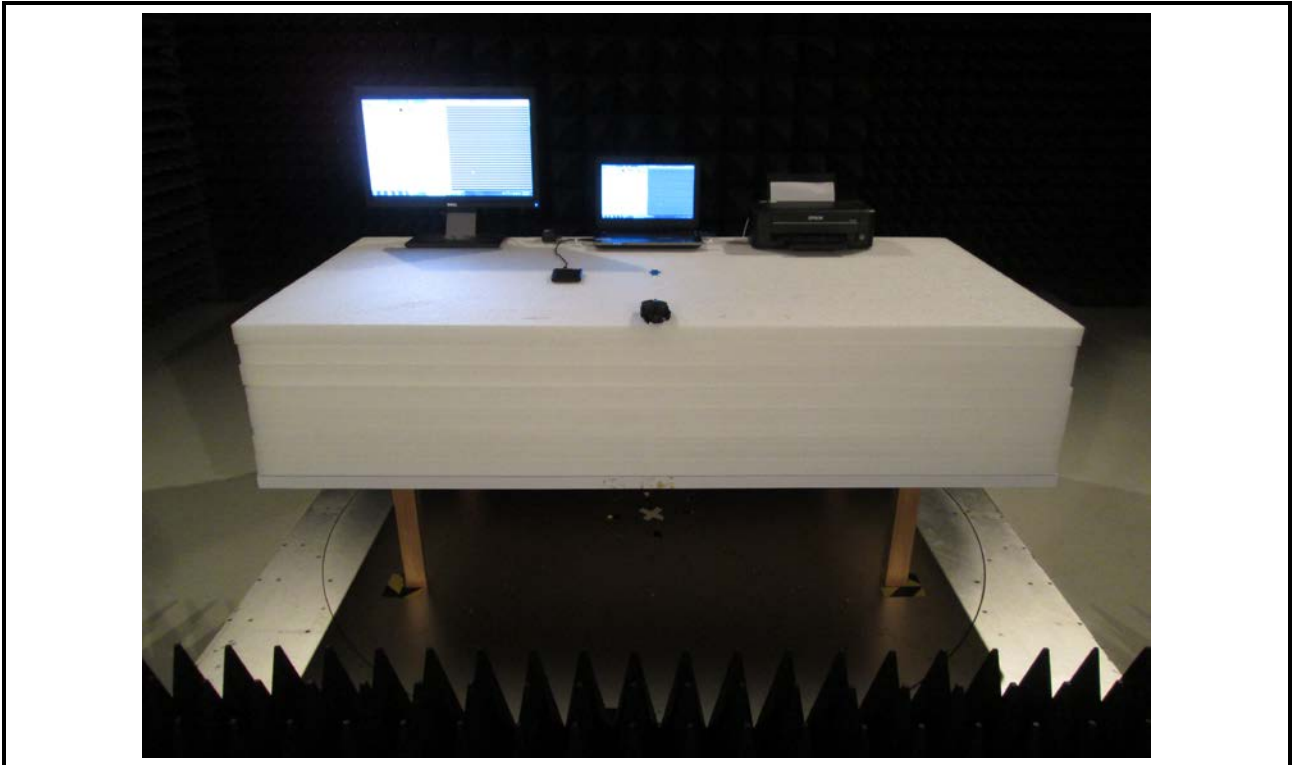

5 Test laboratory information

Established in 2012, ICC provides foremost EMC & RF Testing and advisory consultation services by our skilled engineers and technicians. Our services employ a wide variety of advanced edge test equipment and one of the widest certification extents in the business.

International Certification Corp, it is our definitive objective is to institute long term, trust-based associations with our clients. The expectation we set up with our clients is based on outstanding service, practical expertise and devotion to a certified value structure. Our passion is to grant our clients with best EMC / RF services by oriented knowledgeable and accommodating staff.

Our Test sites are located at Linkou District and Kwei Shan Hsiang. Location map can be found on our website <http://www.icertifi.com.tw>.

Linkou

Tel: 886-2-2601-1640

No. 30-2, Ding Fwu Tsuen, Lin Kou District, New Taipei City, Taiwan, R.O.C.

Kwei Shan

Tel: 886-3-271-8666

No. 3-1, Lane 6, Wen San 3rd St., Kwei Shan Hsiang, Tao Yuan Hsien 333, Taiwan, R.O.C.

If you have any suggestion, please feel free to contact us as below information

Tel: 886-3-271-8666

Fax: 886-3-318-0155

Email: ICC_Service@icertifi.com.tw

==END==