

FCC Radio Test Report

FCC ID: 2AAUCGMOTMFRX

Report No. : BTL-FCCP-1-2005T130
Equipment : Argent M5 Wireless Dongle
Model Name : GMO-TMF-RX, GMO-TMF-RXBK-01
Brand Name : Thermaltake Technology Co., Ltd.
Applicant : Thermaltake Technology Co., Ltd.
Address : 5F.,No.185,Sec.2,Tiding Blvd.,Neihu Dist., Taipei City 114, Taiwan (R.O.C.)

Radio Function : Short Range Devices

FCC Rule Part(s) : FCC Part15, Subpart C (15.249)
Measurement Procedure(s) : ANSI C63.10-2013

Date of Receipt : 2020/5/27
Date of Test : 2020/5/27 ~ 2020/7/9
Issued Date : 2020/7/9

The above equipment has been tested and found in compliance with the requirement of the above standards by BTL Inc.

Prepared by :

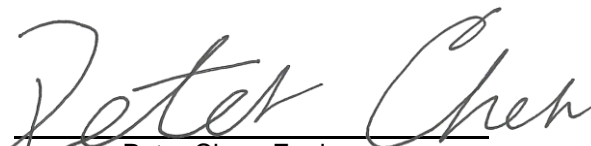
Peter Chen, Engineer



Approved by :

Scott Hsu, Manager

BTL Inc.

No.18, Ln. 171, Sec. 2, Jiuzong Rd., Neihu Dist., Taipei City 114, Taiwan

Tel: +886-2-2657-3299

Fax: +886-2-2657-3331

Web: www.newbtl.com

Declaration

BTL represents to the client that testing is done in accordance with standard procedures as applicable and that test instruments used has been calibrated with standards traceable to international standard(s) and/or national standard(s).

BTL's reports apply only to the specific samples tested under conditions. It is manufacture's responsibility to ensure that additional production units of this model are manufactured with the identical electrical and mechanical components. **BTL** shall have no liability for any declarations, inferences or generalizations drawn by the client or others from **BTL** issued reports.

The report must not be used by the client to claim product certification, approval, or endorsement by NIST, A2LA, or any agency of the U.S. Government.

This report is the confidential property of the client. As a mutual protection to the clients, the public and ourselves, the test report shall not be reproduced, except in full, without our written approval.

BTL's laboratory quality assurance procedures are in compliance with the **ISO/IEC 17025** requirements, and accredited by the conformity assessment authorities listed in this test report.

BTL is not responsible for the sampling stage, so the results only apply to the sample as received.

The information, data and test plan are provided by manufacturer which may affect the validity of results, so it is manufacturer's responsibility to ensure that the apparatus meets the essential requirements of applied standards and in all the possible configurations as representative of its intended use.

Limitation

For the use of the authority's logo is limited unless the Test Standard(s)/Scope(s)/Item(s) mentioned in this test report is (are) included in the conformity assessment authorities acceptance respective.

Please note that the measurement uncertainty is provided for informational purpose only and are not use in determining the Pass/Fail results.

CONTENTS

REPORT ISSUED HISTORY	4
1 SUMMARY OF TEST RESULTS	5
1.1 TEST FACILITY	6
1.2 MEASUREMENT UNCERTAINTY	6
1.3 TEST ENVIRONMENT CONDITIONS	7
1.4 TABLE OF PARAMETERS OF TEXT SOFTWARE SETTING	7
1.5 DUTY CYCLE	7
2 GENERAL INFORMATION	8
2.1 DESCRIPTION OF EUT	8
2.2 TEST MODES	9
2.3 BLOCK DIAGRAM SHOWING THE CONFIGURATION OF SYSTEM TESTED	10
2.4 SUPPORT UNITS	11
3 AC POWER LINE CONDUCTED EMISSIONS TEST	12
3.1 LIMIT	12
3.2 TEST PROCEDURE	12
3.3 DEVIATION FROM TEST STANDARD	12
3.4 TEST SETUP	13
3.5 TEST RESULT	13
4 RADIATED EMISSIONS TEST	14
4.1 LIMIT	14
4.2 TEST PROCEDURE	15
4.3 DEVIATION FROM TEST STANDARD	15
4.4 TEST SETUP	15
4.5 EUT OPERATING CONDITIONS	16
4.6 TEST RESULT – 30 MHZ TO 1 GHZ	17
4.7 TEST RESULT – ABOVE 1 GHZ	17
5 BANDWIDTH TEST	18
5.1 APPLIED PROCEDURES / LIMIT	18
5.2 TEST PROCEDURE	18
5.3 DEVIATION FROM STANDARD	18
5.4 TEST SETUP	18
5.5 EUT OPERATION CONDITIONS	18
5.6 TEST RESULTS	18
6 LIST OF MEASURING EQUIPMENTS	19
7 EUT TEST PHOTO	20
8 EUT PHOTOS	20
APPENDIX A AC POWER LINE CONDUCTED EMISSIONS	21
APPENDIX B RADIATED EMISSIONS - 30 MHZ TO 1 GHZ	26
APPENDIX C RADIATED EMISSIONS - ABOVE 1 GHZ	29
APPENDIX D BANDWIDTH	39

REPORT ISSUED HISTORY

Report Version	Description	Issued Date
R00	Original Issue.	2020/6/17
R01	Revised Typo	2020/6/19
R02	Revised Typo	2020/6/20
R03	Revised report to address TCB's comments.	2020/7/8
R04	Revised Typo	2020/7/9
R05	Revised report to address TCB's comments.	2020/7/9

1 SUMMARY OF TEST RESULTS

Test procedures according to the technical standards.

FCC Part 15, Subpart C (15.249)				
Standard(s) Section	Description	Test Result	Judgement	Remark
15.207	AC Power Line Conducted Emissions	APPENDIX A	Pass	-----
15.205 15.209 15.249(a)(d)	Radiated Emissions	APPENDIX B APPENDIX C	Pass	-----
15.215(c)	Bandwidth	APPENDIX D	Pass	-----

NOTE:

- (1) "N/A" denotes test is not applicable in this Test Report.
- (2) The report format version is TP.1.1.1.

1.1 TEST FACILITY

The test facilities used to collect the test data in this report:

No. 68-1, Ln. 169, Sec. 2, Datong Rd., Xizhi Dist., New Taipei City 221, Taiwan

The test sites and facilities are covered under FCC RN: 674415 and DN: TW0659.

- C05 CB08 CB11 CB15 CB16
 SR06

No.18, Ln. 171, Sec. 2, Jiuzong Rd., Neihu Dist., Taipei City 114, Taiwan

The test sites and facilities are covered under FCC RN: 325517 and DN: TW1115.

- C03 CB18 CB19

1.2 MEASUREMENT UNCERTAINTY

The reported uncertainty of measurement $y \pm U$, where expanded uncertainty U is based on a standard uncertainty multiplied by a coverage factor of $k = 2$, providing a level of confidence of approximately **95 %**. The measurement instrumentation uncertainty considerations contained in CISPR 16-4-2. The BTL measurement uncertainty is less than the CISPR 16-4-2 U_{cispr} requirement.

A. AC power line conducted emissions test:

Test Site	Method	Measurement Frequency Range	U (dB)
C05	CISPR	150 kHz ~ 30MHz	3.44

B. Radiated emissions test :

Test Site	Measurement Frequency Range	U,(dB)
CB15	0.03 GHz ~ 0.2 GHz	4.17
	0.2 GHz ~ 1 GHz	4.72
	1 GHz ~ 6 GHz	5.21
	6 GHz ~ 18 GHz	5.51
	18 GHz ~ 26 GHz	3.69
	26 GHz ~ 40 GHz	4.23

C. Conducted test :

Test Item	U,(dB)
Bandwidth	1.13

NOTE:

Unless specifically mentioned, the uncertainty of measurement has not been taken into account to declare the compliance or non-compliance to the specification.

1.3 TEST ENVIRONMENT CONDITIONS

Test Item	Environment Condition	Test Voltage	Tested by
AC Power Line Conducted Emissions	24 °C, 57 %	AC 120V	William Wei
Radiated emissions below 1 GHz	22 °C, 65 %	AC 120V	Hunter Chiang
Radiated emissions above 1 GHz	22 °C, 65 %	AC 120V	Hunter Chiang
Bandwidth	24.3 °C, 53 %	AC 120V	Jay Kao

1.4 TABLE OF PARAMETERS OF TEXT SOFTWARE SETTING

Test Software	DP449-PXG RF Lab Test V1.0.0.4			
Modulation Mode	2402 MHz	2440 MHz	2480 MHz	Data Rate
GFSK	4	4	4	2 Mbps

1.5 DUTY CYCLE

If duty cycle is $\geq 98\%$, duty factor is not required.
 If duty cycle is $< 98\%$, duty factor shall be considered.

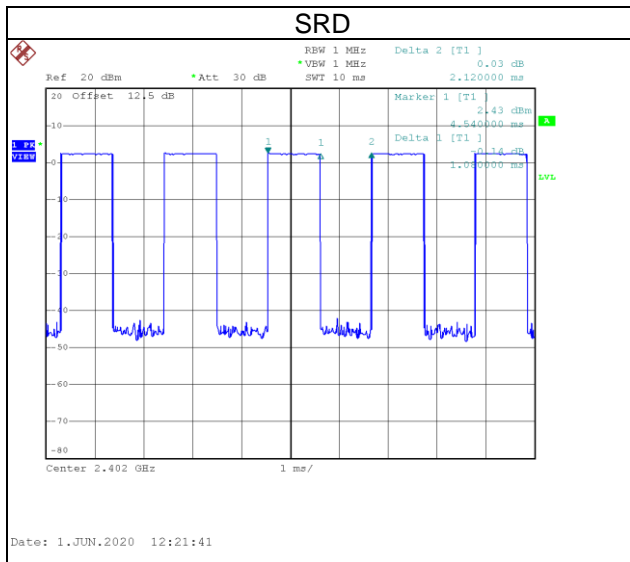

Remark	Delta 1	Delta 2	On Time/Period
Mode	ON (ms)	Period (ON+OFF) (ms)	Duty Cycle (%)
SRD	1.080	2.120	50.94%

2 GENERAL INFORMATION

2.1 DESCRIPTION OF EUT

Equipment	Argent M5 Wireless Dongle
Model Name	GMO-TMF-RX, GMO-TMF-RXBK-01
Brand Name	Thermaltake Technology Co., Ltd.
Model Difference	Marketing differentiation.
Power Source	DC voltage supplied from host system.
Power Rating	DC 5V, 100mA
Products Covered	1 * USB Cable Adapter
S/N Number	pvt0001
SW version	V0307
Frequency Range	2400 MHz ~ 2483.5 MHz
Operation Frequency	2402 MHz ~ 2480 MHz
Modulation Technology	GFSK
Transfer Rate	2Mbps
Field Strength	91.68dBuV/m
Test Model	GMO-TMF-RX
Sample Status	DVT sample
EUT Modification(s)	N/A

NOTE:

(1) For a more detailed features description, please refer to the manufacturer's specifications or the user's manual.

(2) Channel List:

Channel	Frequency (MHz)	Channel	Frequency (MHz)
00	2402	20	2442
01	2404	21	2444
02	2406	22	2446
03	2408	23	2448
04	2410	24	2450
05	2412	25	2452
06	2414	26	2454
07	2416	27	2456
08	2418	28	2458
09	2420	29	2460
10	2422	30	2462
11	2424	31	2464
12	2426	32	2466
13	2428	33	2468
14	2430	34	2470
15	2432	35	2472
16	2434	36	2474
17	2436	37	2476
18	2438	38	2478
19	2440	39	2480

(3) Table for Filed Antenna:

Ant.	Brand	Test Model	Antenna Type	Connector	Gain (dBi)
1	N/A	mouse_Ant_#1	PCB	N/A	-1.93

2.2 TEST MODES

Test Items	Test mode	Channel	Note
AC power line conducted emissions	Normal/Idle	-	-
Transmitter Radiated Emissions (below 1GHz)	2 Mbps	39	-
Transmitter Radiated Emissions (above 1GHz)	2 Mbps	00/19/39	Fundamental
	2 Mbps	00/19/39	Harmonic
Bandwidth	2 Mbps	00/19/39	-

NOTE:

- (1) The Radiated emissions test was verified based on the worst conducted power and Bandwidth test results reported in the original report.
- (2) For radiated emission band edge test, both Vertical and Horizontal are evaluated, but only the worst case (Horizontal) is recorded.
- (3) All X, Y and Z axes are evaluated, but only the worst case (X axis) is recorded.
- (4) There were no emissions found below 30 MHz within 20 dB of the limit.

2.3 BLOCK DIAGRAM SHOWING THE CONFIGURATION OF SYSTEM TESTED

Equipment letters and Cable numbers refer to item numbers described in the tables of clause 2.4.

AC power line conducted emissions

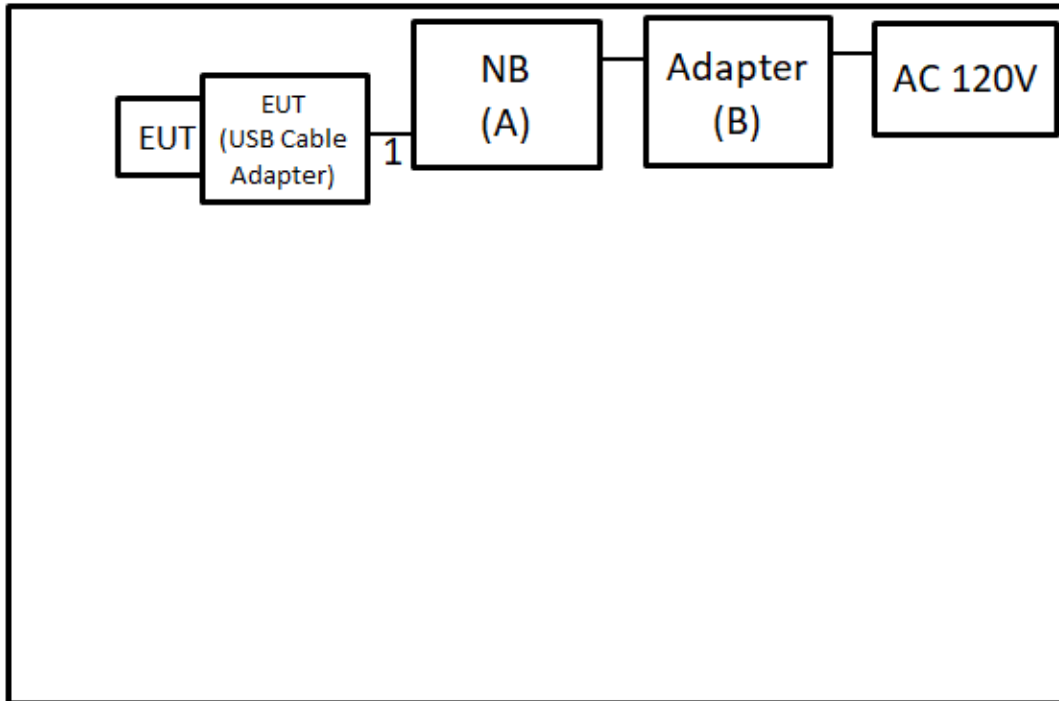

Radiated Emissions

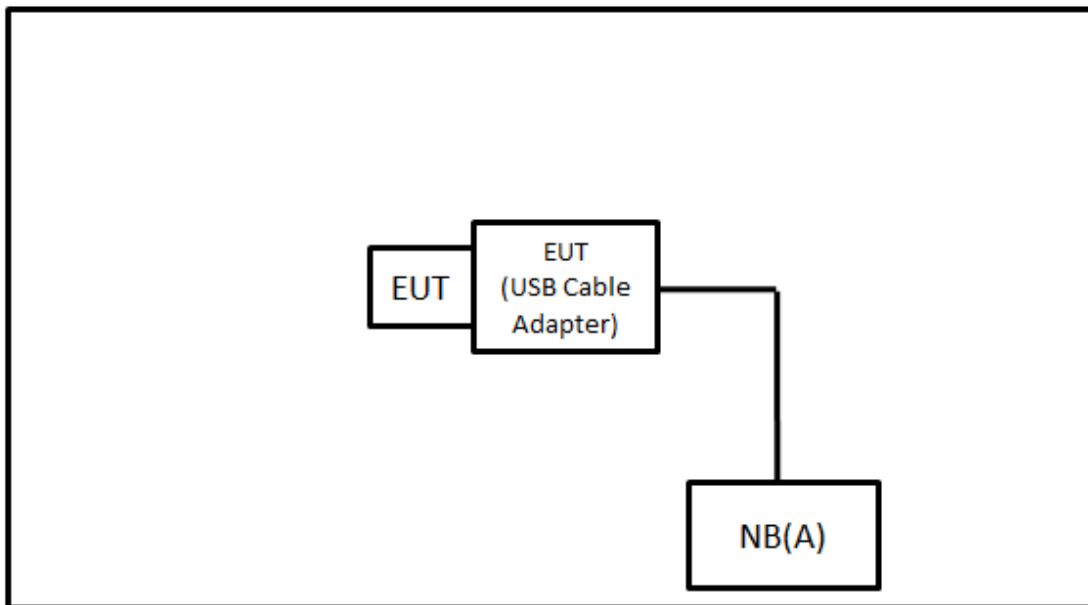

2.4 SUPPORT UNITS

Item	Equipment	Brand	Model No.	Series No.	Remarks
A	NB	HP	TPN-11I9	N/A	Furnished by test lab.
B	ADP for NB	HP	HSTNN-CA40	N/A	Furnished by test lab.

Item	Shielded	Ferrite Core	Length	Cable Type	Remarks
1	YES	NO	3m	USB Cable	Supplied by test requester.

3 AC POWER LINE CONDUCTED EMISSIONS TEST

3.1 LIMIT

Frequency (MHz)	Limit (dB μ V)	
	Quasi-peak	Average
0.15 - 0.5	66 - 56 *	56 - 46 *
0.50 - 5.0	56	46
5.0 - 30.0	60	50

NOTE:

- (1) The tighter limit applies at the band edges.
- (2) The limit of " * " marked band means the limitation decreases linearly with the logarithm of the frequency in the range.
- (3) The test result calculated as following:
 Measurement Value = Reading Level + Correct Factor
 Correct Factor = Insertion Loss + Cable Loss + Attenuator Factor (if use)
 Margin Level = Measurement Value – Limit Value
 Calculation example:

Reading Level		Correct Factor		Measurement Value
38.22	+	3.45	=	41.67

Measurement Value		Limit Value		Margin Level
41.67	-	60	=	-18.33

The following table is the setting of the receiver.

Receiver Parameter	Setting
Attenuation	10 dB
Start Frequency	0.15 MHz
Stop Frequency	30 MHz
IF Bandwidth	9 KHz

3.2 TEST PROCEDURE

- a. The EUT was placed 0.8 m above the horizontal ground plane with the EUT being connected to the power mains through a line impedance stabilization network (LISN).
 All other support equipment were powered from an additional LISN(s).
 The LISN provides 50 Ohm/50uH of impedance for the measuring instrument.
- b. Interconnecting cables that hang closer than 40 cm to the ground plane shall be folded back and forth in the center forming a bundle to keep the cable above 40 cm.
- c. Excess I/O cables that are not connected to a peripheral shall be bundled in the center.
 The end of the cable will be terminated, using the correct terminating impedance.
 The overall length shall not exceed 1 m.
- d. The LISN is spaced at least 80 cm from the nearest part of the EUT chassis.
- e. For the actual test configuration, please refer to the related Item – EUT TEST PHOTO.

NOTE:

- (1) In the results, each reading is marked as Peak, QP or AVG per the detector used.
 BW=9 kHz (6 dB Bandwidth)
- (2) All readings are Peak unless otherwise stated QP or AVG in column of Note. Both the QP and the AVG readings must be less than the limit for compliance.

3.3 DEVIATION FROM TEST STANDARD

No deviation.

3.4 TEST SETUP

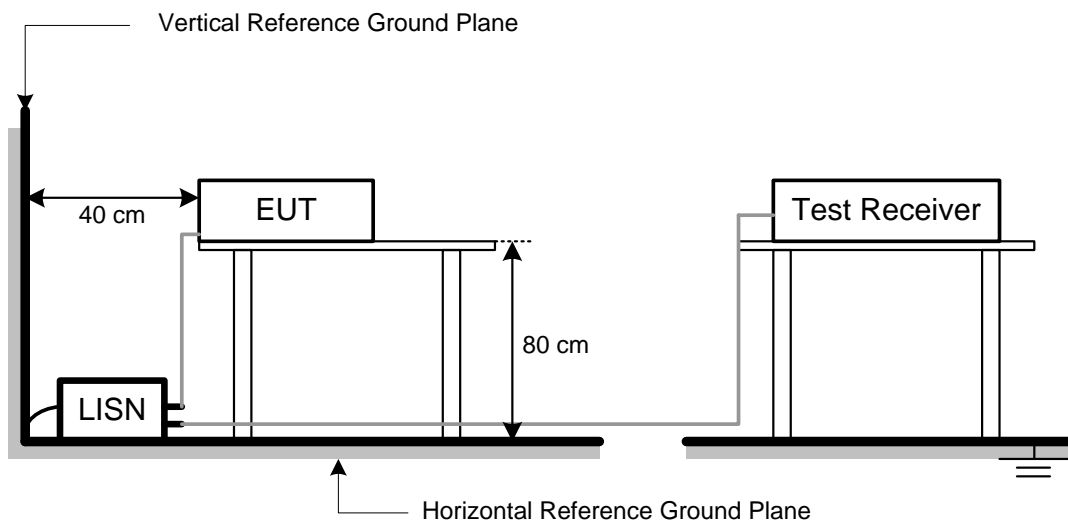

3.5 TEST RESULT

Please refer to the APPENDIX A.

4 RADIATED EMISSIONS TEST

4.1 LIMIT

In case the emission fall within the restricted band specified on 15.205, then the 15.209 limit in the table below has to be followed.

LIMITS OF RADIATED EMISSIONS MEASUREMENT (9 kHz to 1000 MHz)

Frequency (MHz)	Field Strength (microvolts/meter)	Measurement Distance (meters)
0.009~0.490	2400/F(KHz)	300
0.490~1.705	24000/F(KHz)	30
1.705~30.0	30	30
30~88	100	3
88~216	150	3
216~960	200	3
960~1000	500	3

LIMITS OF RADIATED EMISSIONS MEASUREMENT (Above 1000 MHz)

Frequency (MHz)	Radiated Emissions (dBuV/m)		Measurement Distance (meters)
	Peak	Average	
Above 1000	74	54	3

NOTE:

- (1) The limit for radiated test was performed according to FCC Part 15, Subpart C.
- (2) The tighter limit applies at the band edges.
- (3) Emission level (dBuV/m)=20log Emission level (uV/m).
- (4) The test result calculated as following:

Measurement Value = Reading Level + Correct Factor

Correct Factor = Antenna Factor + Cable Loss - Amplifier Gain(if use)

Margin Level = Measurement Value - Limit Value

Calculation example:

Reading Level		Correct Factor		Measurement Value
19.11	+	2.11	=	21.22

Measurement Value		Limit Value		Margin Level
21.22	-	54	=	-32.78

Spectrum Parameter	Setting
Attenuation	Auto
Start Frequency	1000 MHz
Stop Frequency	10th carrier harmonic
RBW / VBW (Emission in restricted band)	1MHz / 3MHz for Peak, 1MHz / 1/T for Average

Spectrum Parameter	Setting
Attenuation	Auto
Start ~ Stop Frequency	9KHz~90KHz for PK/AVG detector
Start ~ Stop Frequency	90KHz~110KHz for QP detector
Start ~ Stop Frequency	110KHz~490KHz for PK/AVG detector
Start ~ Stop Frequency	490KHz~30MHz for QP detector
Start ~ Stop Frequency	30MHz~1000MHz for QP detector

4.2 TEST PROCEDURE

- a. The measuring distance of 3 m shall be used for measurements. The EUT was placed on the top of a rotating table 0.8 meter above the ground at a 3 meter semi-anechoic chamber. The table was rotated 360 degrees to determine the position of the highest radiation.(below 1GHz)
- b. The measuring distance of 3 m shall be used for measurements. The EUT was placed on the top of a rotating table 1.5 meter above the ground at a 3 meter semi-anechoic chamber. The table was rotated 360 degrees to determine the position of the highest radiation.(above 1GHz)
- c. The height of the equipment or of the substitution antenna shall be 0.8 m or 1.5 m, the height of the test antenna shall vary between 1 m to 4 m. Both horizontal and vertical polarizations of the antenna are set to make the measurement.
- d. For each suspected emission, the EUT was arranged to its worst case and then the antenna was tuned to heights find the maximum reading (used Bore sight function).
- e. The receiver system was set to peak and average detect function and specified bandwidth with maximum hold mode when the test frequency is above 1GHz.
- f. The initial step in collecting radiated emission data is a receiver peak detector mode pre-scanning the measurement frequency range. Significant peaks are then marked and then Quasi Peak detector mode re-measured.
- g. All readings are Peak unless otherwise stated QP in column of Note. Peak denotes that the Peak reading compliance with the QP Limits and then QP Mode measurement didn't perform. (below 1GHz)
- h. All readings are Peak Mode value unless otherwise stated AVG in column of Note. If the Peak Mode Measured value compliance with the Peak Limits and lower than AVG Limits, the EUT shall be deemed to meet both Peak & AVG Limits and then only Peak Mode was measured, but AVG Mode didn't perform. (above 1GHz)
- i. For the actual test configuration, please refer to the related Item – EUT TEST PHOTO.

4.3 DEVIATION FROM TEST STANDARD

No deviation.

4.4 TEST SETUP

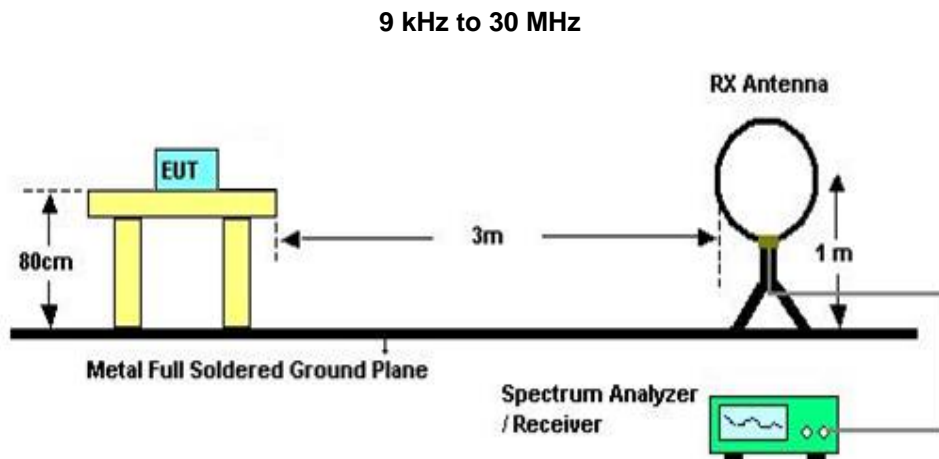

30 MHz to 1 GHz

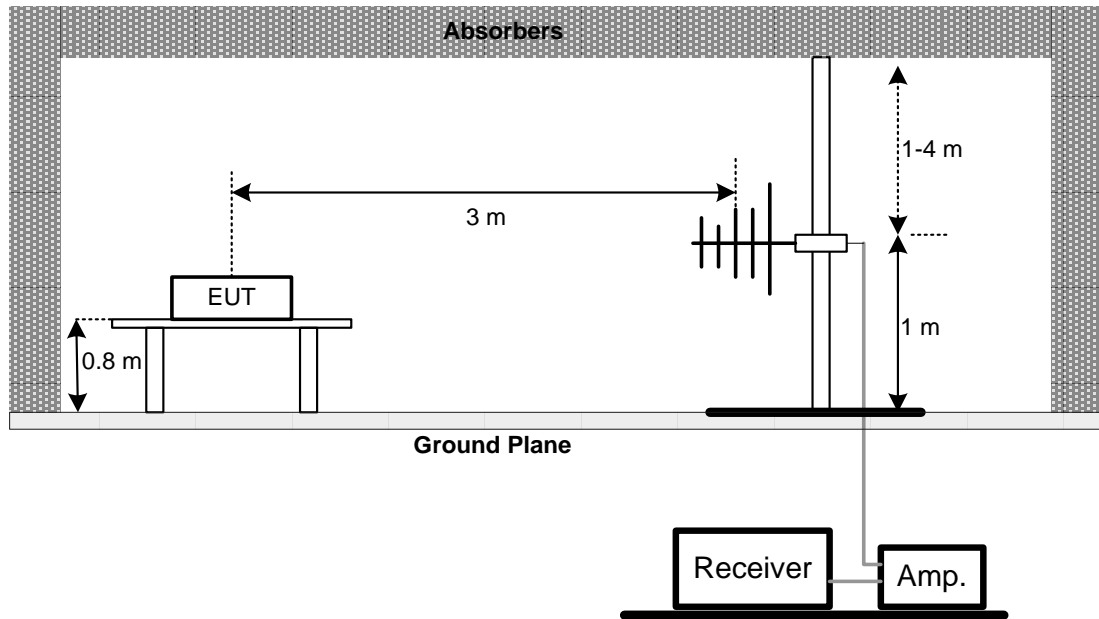

Above 1 GHz

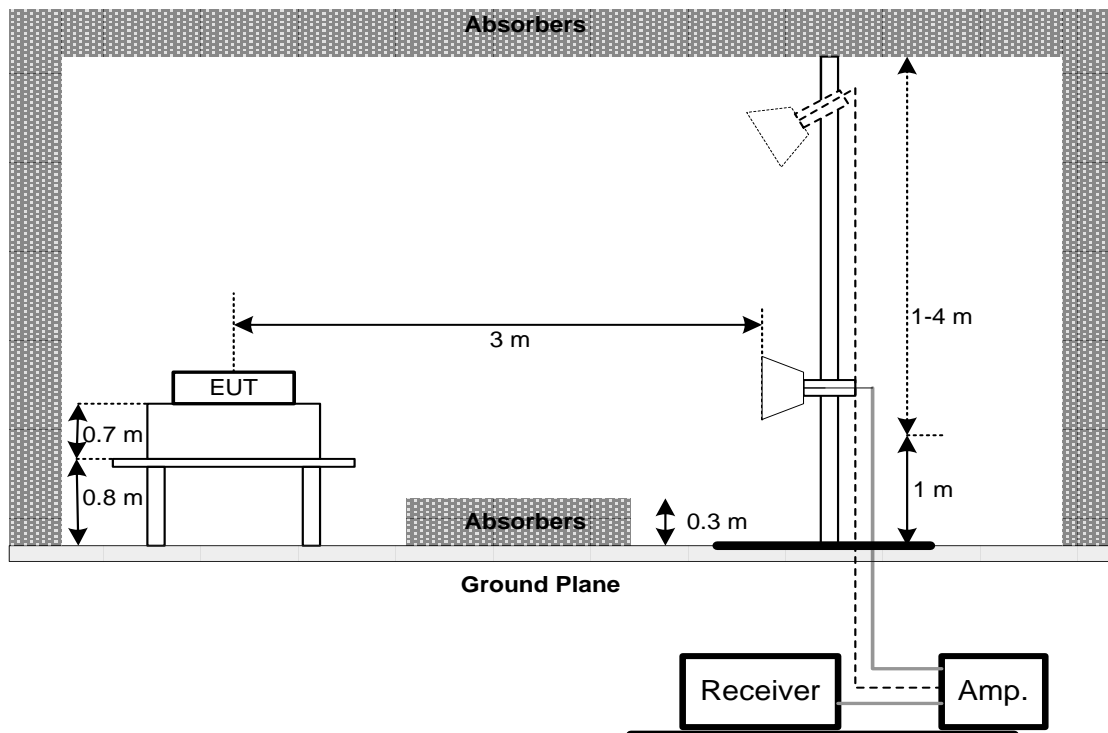

4.5 EUT OPERATING CONDITIONS

The EUT was programmed to be in continuously transmitting mode.

4.6 TEST RESULT – 30 MHZ TO 1 GHZ

Please refer to the APPENDIX B.

4.7 TEST RESULT – ABOVE 1 GHZ

Please refer to the APPENDIX C.

NOTE:

- (1) No limit: This is fundamental signal, the judgment is not applicable.
For fundamental signal judgment was referred to Peak output test.

5 BANDWIDTH TEST

5.1 APPLIED PROCEDURES / LIMIT

Intentional radiators operating under the alternative provisions to the general emission limits, as contained in §§15.217 through 15.257 and in subpart E of this part, must be designed to ensure that the 20 dB bandwidth of the emission, or whatever bandwidth may otherwise be specified in the specific rule section under which the equipment operates, is contained within the frequency band designated in the rule section under which the equipment is operated. In the case of intentional radiators operating under the provisions of subpart E, the emission bandwidth may span across multiple contiguous frequency bands identified in that subpart. The requirement to contain the designated bandwidth of the emission within the specified frequency band includes the effects from frequency sweeping, frequency hopping and other modulation techniques that may be employed as well as the frequency stability of the transmitter over expected variations in temperature and supply voltage. If a frequency stability is not specified in the regulations, it is recommended that the fundamental emission be kept within at least the central 80% of the permitted band in order to minimize the possibility of out-of-band operation.

5.2 TEST PROCEDURE

- a. The EUT was directly connected to the spectrum analyzer and antenna output port as show in the block diagram below,
- b. Spectrum Setting : RBW= 100KHz, VBW=300KHz, Sweep time = 2.5 ms.

5.3 DEVIATION FROM STANDARD

No deviation.

5.4 TEST SETUP

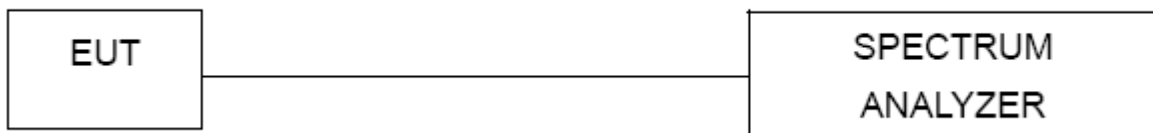

5.5 EUT OPERATION CONDITIONS

The EUT tested system was configured as the statements of 4.1.5 unless otherwise a special operating condition is specified in the follows during the testing.

5.6 TEST RESULTS

Please refer to the APPENDIX D.

6 LIST OF MEASURING EQUIPMENTS

AC Power Line Conducted Emissions						
Item	Kind of Equipment	Manufacturer	Type No.	Serial No.	Calibrated Date	Calibrated Until
1	TWO-LINE V-NETWORK	R&S	ENV216	101050	2019/6/21	2020/6/20
2	Test Cable	EMCI	EMCCFD300-BM-BMR-6000	170715	2019/8/7	2020/8/6
3	EMI Test Receiver	R&S	ESR7	101433	2019/12/11	2020/12/9
4	Measurement Software	EZ	EZ_EMCI (Version NB-03A)	N/A	N/A	N/A

Radiated Emissions						
Item	Kind of Equipment	Manufacturer	Type No.	Serial No.	Calibrated Date	Calibrated Until
1	Preamplifier	EMCI	EMC02325B	980217	2020/4/10	2021/4/9
2	Preamplifier	EMCI	EMC012645B	980267	2020/4/10	2021/4/9
3	Test Cable	EMCI	EMC104-SM-SM-800	150207	2020/4/10	2021/4/9
4	Test Cable	EMCI	EMC104-SM-SM-3000	151205	2020/4/10	2021/4/9
5	Test Cable	EMCI	EMC-SM-SM-7000	180408	2020/4/10	2021/4/9
6	MXE EMI Receiver	Agilent	N9038A	MY55420127	2020/3/24	2021/3/23
7	Signal Analyzer	Agilent	N9010A	MY56480554	2020/6/3	2021/6/2
8	Horn Ant	SCHWARZBECK	BBHA 9120D	9120D-01783	2019/8/14	2020/8/13
9	Trilog-Broadband Antenna	Schwarzbeck	VULB 9168	000352	2019/7/31	2020/7/30
10	5dB Attenuator	EMCI	EMCI-N-6-05	AT-N0625	2019/7/31	2020/7/30

Bandwidth						
Item	Kind of Equipment	Manufacturer	Type No.	Serial No.	Calibrated Date	Calibrated Until
1	Spectrum Analyzer	R&S	FSP38	101139	2020/5/30	2021/5/30

Remark: "N/A" denotes no model name, no serial no. or no calibration specified.
All calibration period of equipment list is one year.

7 EUT TEST PHOTO

Please refer to document Appendix No.: TP-2005T130-FCCP-1 (APPENDIX-TEST PHOTOS).

8 EUT PHOTOS

Please refer to document Appendix No.: EP-2005T130-1 (APPENDIX-EUT PHOTOS).

APPENDIX A AC POWER LINE CONDUCTED EMISSIONS

Test Mode	Normal	Tested Date	2020/6/19
Test Frequency	-	Phase	Line

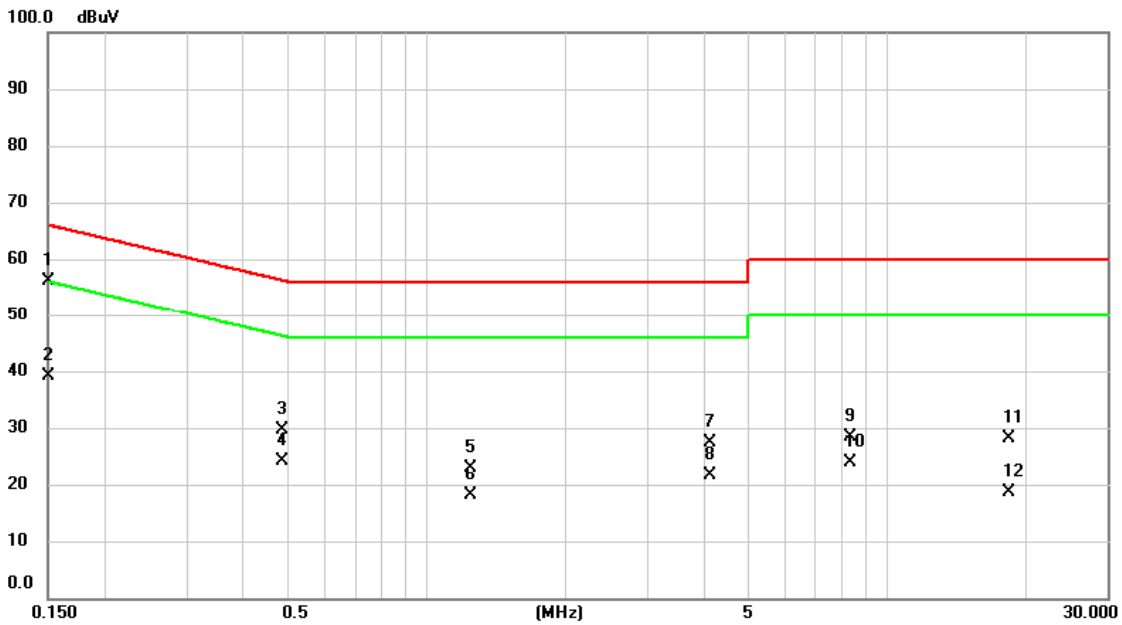

No.	Mk.	Freq.	Reading Level	Correct Factor	Measurement	Limit	Over	Detector	Comment
		MHz	dBuV	dB	dBuV	dBuV	dB		
1	*	0.1500	46.67	9.57	56.24	66.00	-9.76	QP	
2		0.1500	29.60	9.57	39.17	56.00	-16.83	AVG	
3		0.4875	20.12	9.62	29.74	56.21	-26.47	QP	
4		0.4875	14.40	9.62	24.02	46.21	-22.19	AVG	
5		1.2435	13.25	9.65	22.90	56.00	-33.10	QP	
6		1.2435	8.54	9.65	18.19	46.00	-27.81	AVG	
7		4.1100	17.62	9.73	27.35	56.00	-28.65	QP	
8		4.1100	11.94	9.73	21.67	46.00	-24.33	AVG	
9		8.3423	18.61	9.83	28.44	60.00	-31.56	QP	
10		8.3423	14.17	9.83	24.00	50.00	-26.00	AVG	
11		18.3255	18.16	9.95	28.11	60.00	-31.89	QP	
12		18.3255	8.70	9.95	18.65	50.00	-31.35	AVG	

REMARKS:

- (1) Measurement Value = Reading Level + Correct Factor.
- (2) Margin Level = Measurement Value - Limit Value.

Test Mode	Normal	Tested Date	2020/6/19
Test Frequency	-	Phase	Neutral

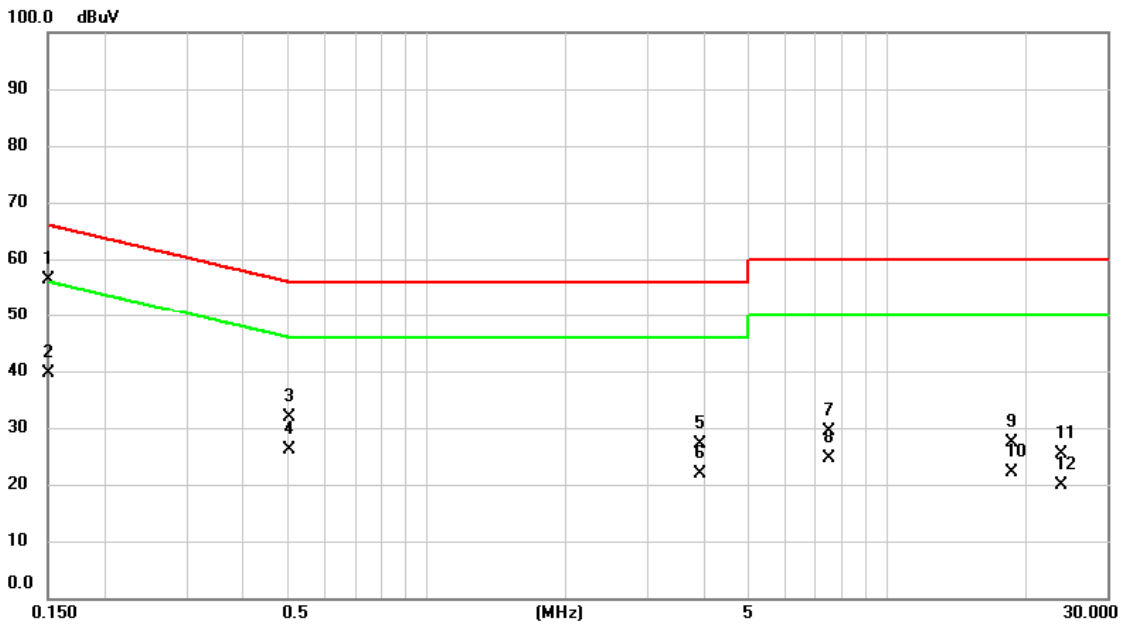

No.	Mk.	Freq. MHz	Reading Level dBuV	Correct Factor dB	Measure- ment dBuV	Limit dBuV	Over dB	Detector	Comment
1	*	0.1500	46.88	9.61	56.49	66.00	-9.51	QP	
2		0.1500	30.08	9.61	39.69	56.00	-16.31	AVG	
3		0.5032	22.32	9.67	31.99	56.00	-24.01	QP	
4		0.5032	16.52	9.67	26.19	46.00	-19.81	AVG	
5		3.9143	17.36	9.77	27.13	56.00	-28.87	QP	
6		3.9143	12.05	9.77	21.82	46.00	-24.18	AVG	
7		7.4760	19.61	9.86	29.47	60.00	-30.53	QP	
8		7.4760	14.76	9.86	24.62	50.00	-25.38	AVG	
9		18.6248	17.33	10.02	27.35	60.00	-32.65	QP	
10		18.6248	12.15	10.02	22.17	50.00	-27.83	AVG	
11		23.7638	15.21	10.07	25.28	60.00	-34.72	QP	
12		23.7638	9.83	10.07	19.90	50.00	-30.10	AVG	

REMARKS:

- (1) Measurement Value = Reading Level + Correct Factor.
- (2) Margin Level = Measurement Value - Limit Value.

Test Mode	Idle	Tested Date	2020/6/19
Test Frequency	-	Phase	Line

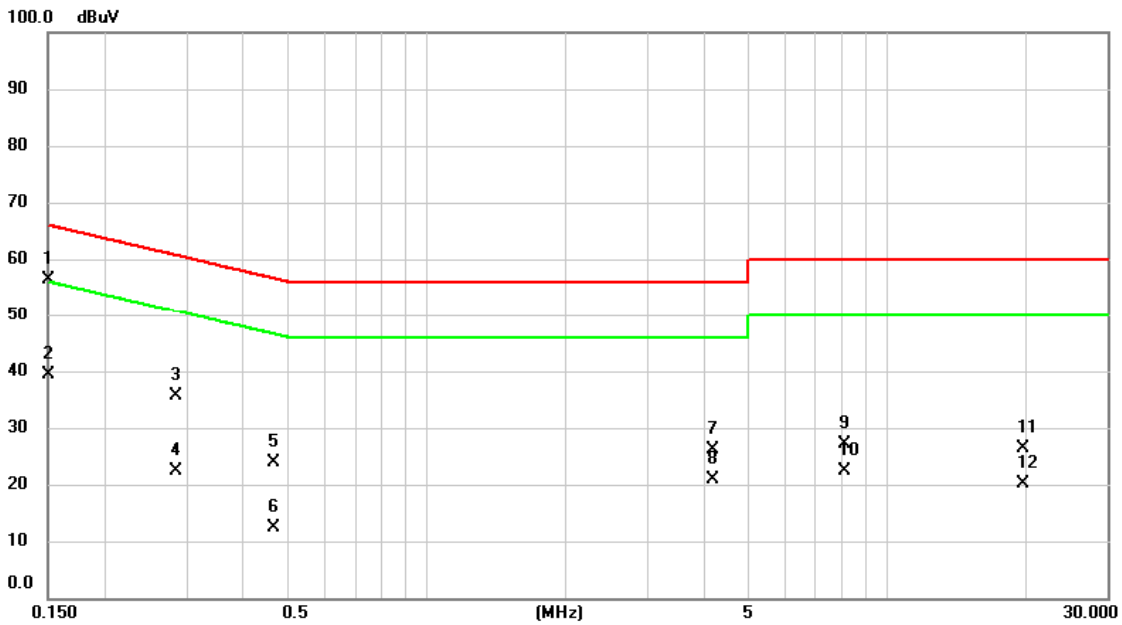

No.	Mk.	Freq. MHz	Reading Level dBuV	Correct Factor dB	Measure- ment dBuV	Limit dBuV	Over dB	Detector	Comment
1	*	0.1500	46.89	9.61	56.50	66.00	-9.50	QP	
2		0.1500	29.86	9.61	39.47	56.00	-16.53	AVG	
3		0.2850	26.08	9.61	35.69	60.67	-24.98	QP	
4		0.2850	12.70	9.61	22.31	50.67	-28.36	AVG	
5		0.4650	14.13	9.67	23.80	56.60	-32.80	QP	
6		0.4650	2.81	9.67	12.48	46.60	-34.12	AVG	
7		4.1774	16.42	9.77	26.19	56.00	-29.81	QP	
8		4.1774	11.19	9.77	20.96	46.00	-25.04	AVG	
9		8.0970	17.17	9.88	27.05	60.00	-32.95	QP	
10		8.0970	12.39	9.88	22.27	50.00	-27.73	AVG	
11		19.6913	16.28	10.04	26.32	60.00	-33.68	QP	
12		19.6913	10.09	10.04	20.13	50.00	-29.87	AVG	

REMARKS:

- (1) Measurement Value = Reading Level + Correct Factor.
- (2) Margin Level = Measurement Value - Limit Value.

Test Mode	Idle	Tested Date	2020/6/19
Test Frequency	-	Phase	Neutral

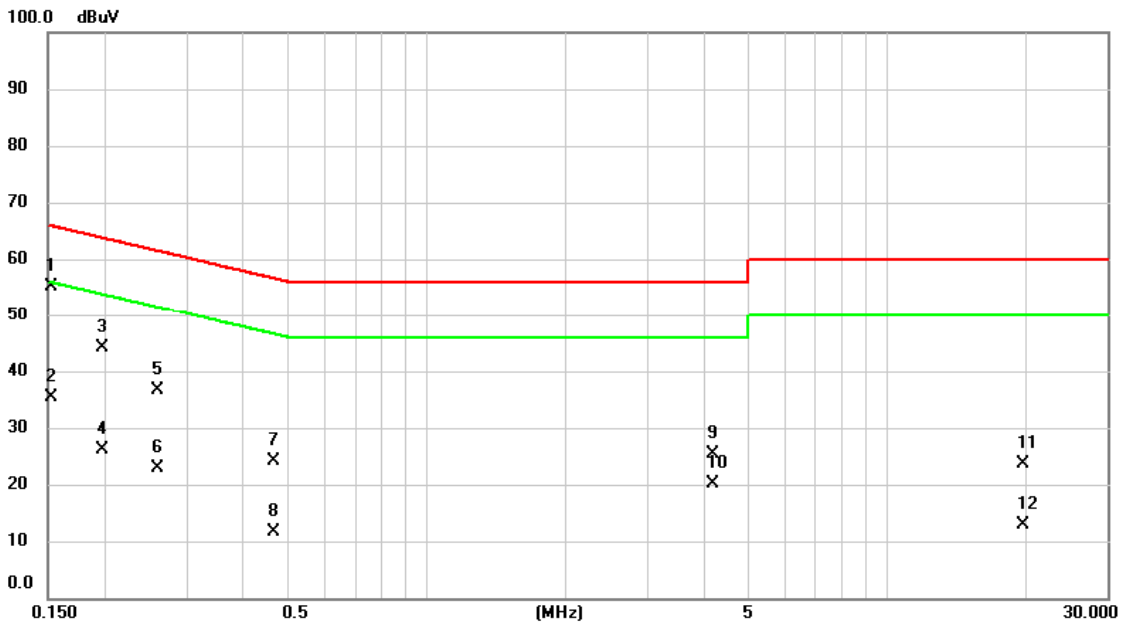

No.	Mk.	Freq. (MHz)	Reading Level (dBuV)	Correct Factor (dB)	Measurement (dBuV)	Limit (dBuV)	Over (dB)	Detector	Comment
1	*	0.1522	45.66	9.57	55.23	65.88	-10.65	QP	
2		0.1522	25.80	9.57	35.37	55.88	-20.51	AVG	
3		0.1973	34.48	9.56	44.04	63.72	-19.68	QP	
4		0.1973	16.50	9.56	26.06	53.72	-27.66	AVG	
5		0.2602	27.16	9.56	36.72	61.43	-24.71	QP	
6		0.2602	13.37	9.56	22.93	51.43	-28.50	AVG	
7		0.4650	14.48	9.62	24.10	56.60	-32.50	QP	
8		0.4650	1.92	9.62	11.54	46.60	-35.06	AVG	
9		4.1774	15.66	9.73	25.39	56.00	-30.61	QP	
10		4.1774	10.40	9.73	20.13	46.00	-25.87	AVG	
11		19.6913	13.77	9.97	23.74	60.00	-36.26	QP	
12		19.6913	2.84	9.97	12.81	50.00	-37.19	AVG	

REMARKS:

- (1) Measurement Value = Reading Level + Correct Factor.
- (2) Margin Level = Measurement Value - Limit Value.

APPENDIX B RADIATED EMISSIONS - 30 MHZ TO 1 GHZ

Test Mode	SRD	Test Date	2020/6/2
Test Frequency	CH39: 2480 MHz	Polarization	Vertical

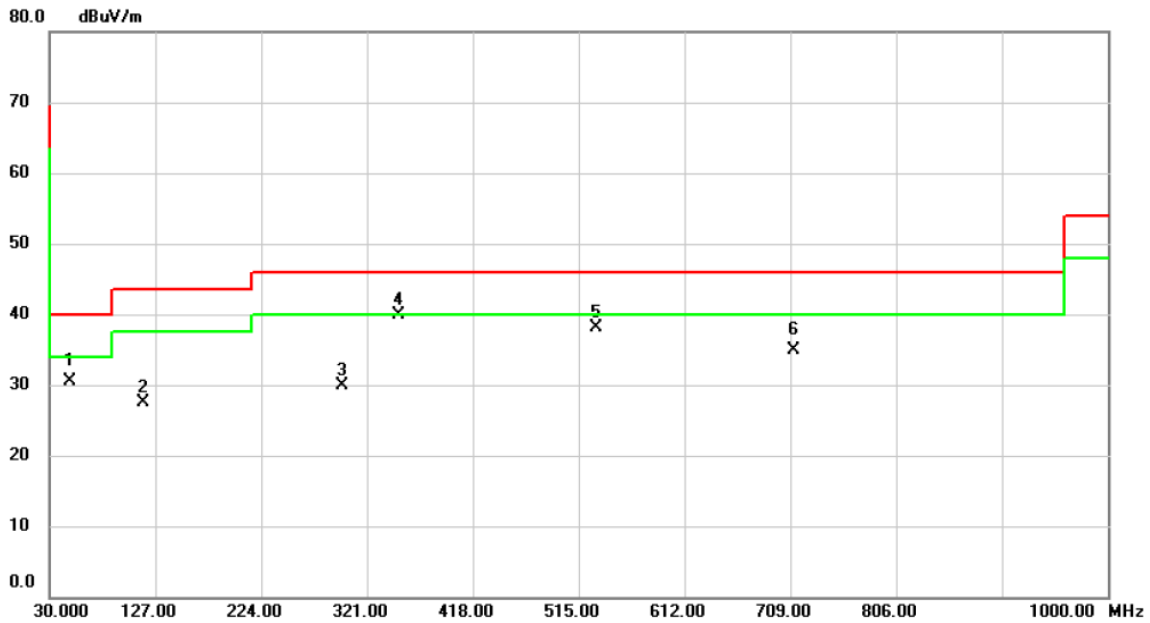

No.	Mk.	Freq. MHz	Reading Level dBuV	Correct Factor dB	Measure- ment dBuV/m	Limit dBuV/m	Over dB	Detector	Comment
1		48.4300	38.61	-8.10	30.51	40.00	-9.49	QP	
2		116.3300	38.93	-11.46	27.47	43.50	-16.03	peak	
3		297.7200	37.23	-7.28	29.95	46.00	-16.05	peak	
4	*	350.1000	45.95	-6.04	39.91	46.00	-6.09	peak	
5		531.4900	39.84	-1.83	38.01	46.00	-7.99	peak	
6		711.9100	33.03	1.85	34.88	46.00	-11.12	QP	

REMARKS:

- (1) Measurement Value = Reading Level + Correct Factor.
- (2) Margin Level = Measurement Value - Limit Value.

Test Mode	SRD	Test Date	2020/6/2
Test Frequency	CH39: 2480 MHz	Polarization	Horizontal

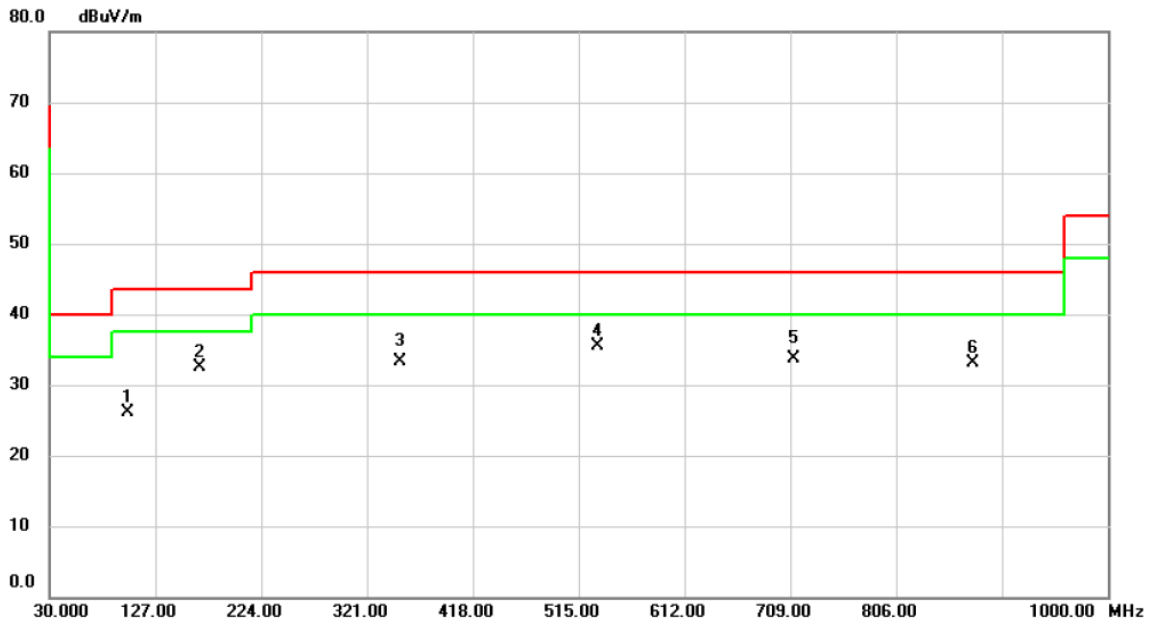

No.	Mk.	Freq. MHz	Reading Level dBuV	Correct Factor dB	Measure- ment dBuV/m	Limit dBuV/m	Over dB	Detector	Comment
1		101.7800	39.03	-12.94	26.09	43.50	-17.41	peak	
2		167.7400	40.92	-8.34	32.58	43.50	-10.92	peak	
3		351.0700	39.38	-6.01	33.37	46.00	-12.63	QP	
4	*	532.4600	37.25	-1.80	35.45	46.00	-10.55	peak	
5		711.9100	31.86	1.85	33.71	46.00	-12.29	QP	
6		875.8400	28.99	4.09	33.08	46.00	-12.92	peak	

REMARKS:

- (1) Measurement Value = Reading Level + Correct Factor.
- (2) Margin Level = Measurement Value - Limit Value.

APPENDIX C RADIATED EMISSIONS - ABOVE 1 GHZ

Test Mode	SRD	Test Date	2020/7/8
Test Frequency	CH00: 2402 MHz	Polarization	Horizontal

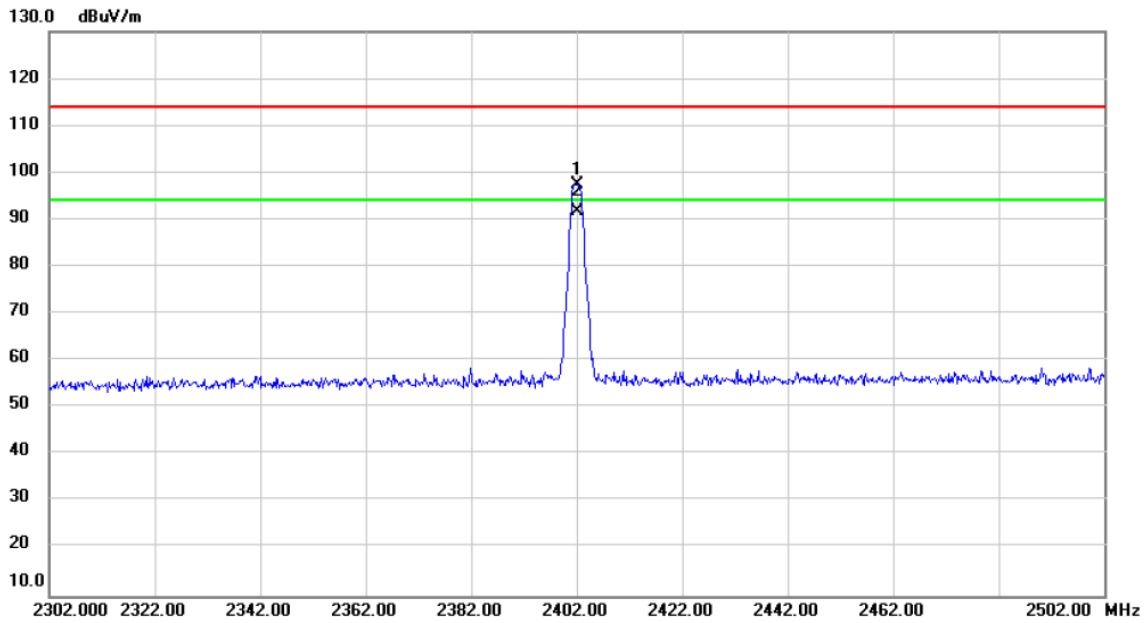

No.	Mk.	Freq.	Reading Level	Correct Factor	Measurement	Limit	Over	Detector	Comment
		MHz	dBuV	dB	dBuV/m	dBuV/m	dB		
1		2402.000	66.38	31.16	97.54	114.00	-16.46	peak	
2	*	2402.000	60.52	-5.86	91.68	94.00	-2.32	AVG	

REMARKS:

- (1) Measurement Value = Reading Level + Correct Factor.
- (2) Margin Level = Measurement Value - Limit Value.
- (3) Average Correct Factor = $20\text{Log}(\text{duty cycle}) = 5.86$

Test Mode	SRD	Test Date	2020/7/8
Test Frequency	CH19: 2440 MHz	Polarization	Horizontal

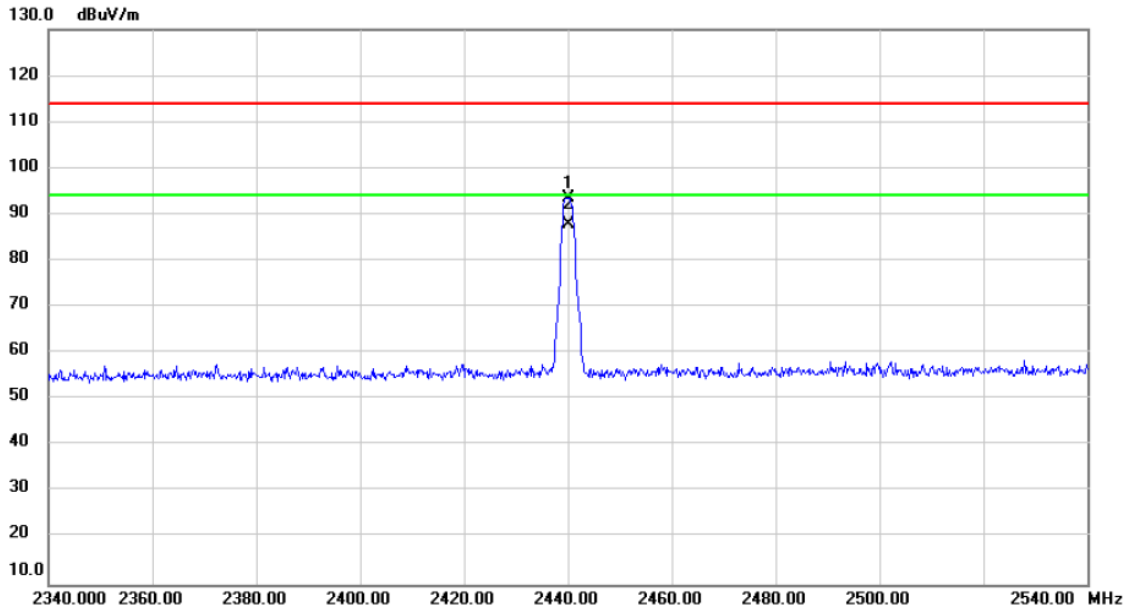

No.	Mk.	Freq.	Reading Level	Correct Factor	Measurement	Limit	Over	Detector	Comment
		MHz	dBuV	dB	dBuV/m	dBuV/m	dB		
1		2440.000	62.31	31.30	93.61	114.00	-20.39	peak	
2	*	2440.000	56.45	-5.86	87.75	94.00	-6.25	AVG	

REMARKS:

- (1) Measurement Value = Reading Level + Correct Factor.
- (2) Margin Level = Measurement Value - Limit Value.
- (3) Average Correct Factor = $20\text{Log}(\text{duty cycle}) = 5.86$

Test Mode	SRD	Test Date	2020/7/8
Test Frequency	CH39: 2480 MHz	Polarization	Horizontal

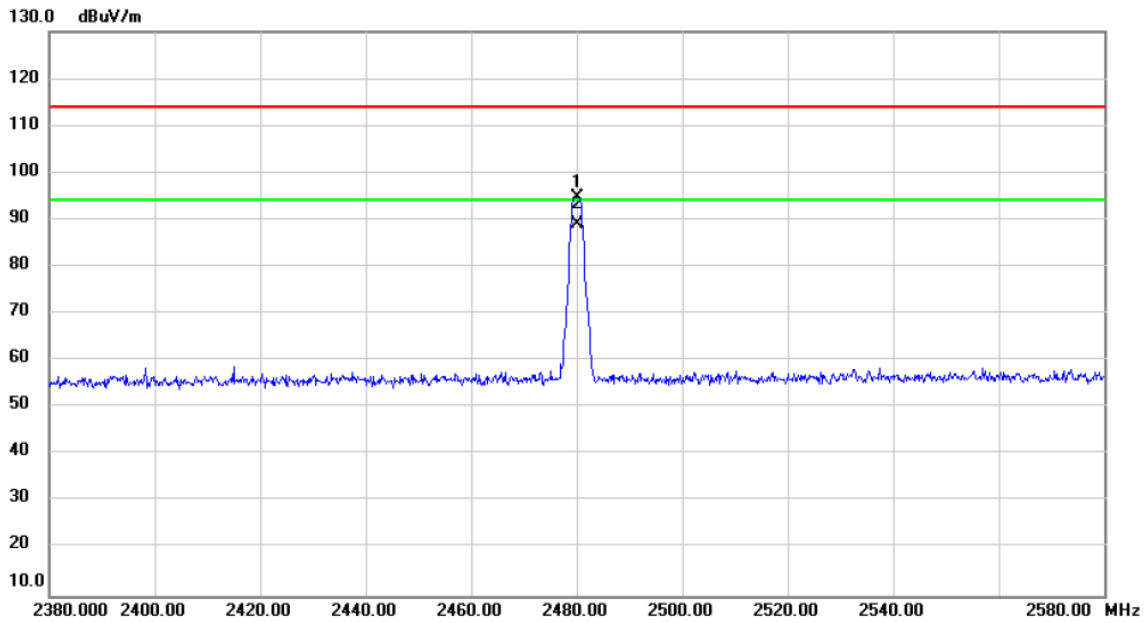

No.	Mk.	Freq.	Reading Level	Correct Factor	Measurement	Limit	Over	Detector	Comment
		MHz	dBuV	dB	dBuV/m	dBuV/m	dB		
1		2480.000	63.40	31.46	94.86	114.00	-19.14	peak	
2	*	2480.000	57.54	-5.86	89.00	94.00	-5.00	AVG	

REMARKS:

- (1) Measurement Value = Reading Level + Correct Factor.
- (2) Margin Level = Measurement Value - Limit Value.
- (3) Average Correct Factor = $20\text{Log}(\text{duty cycle}) = 5.86$

Test Mode	SRD	Test Date	2020/6/2
Test Frequency	CH00: 2402 MHz	Polarization	Vertical

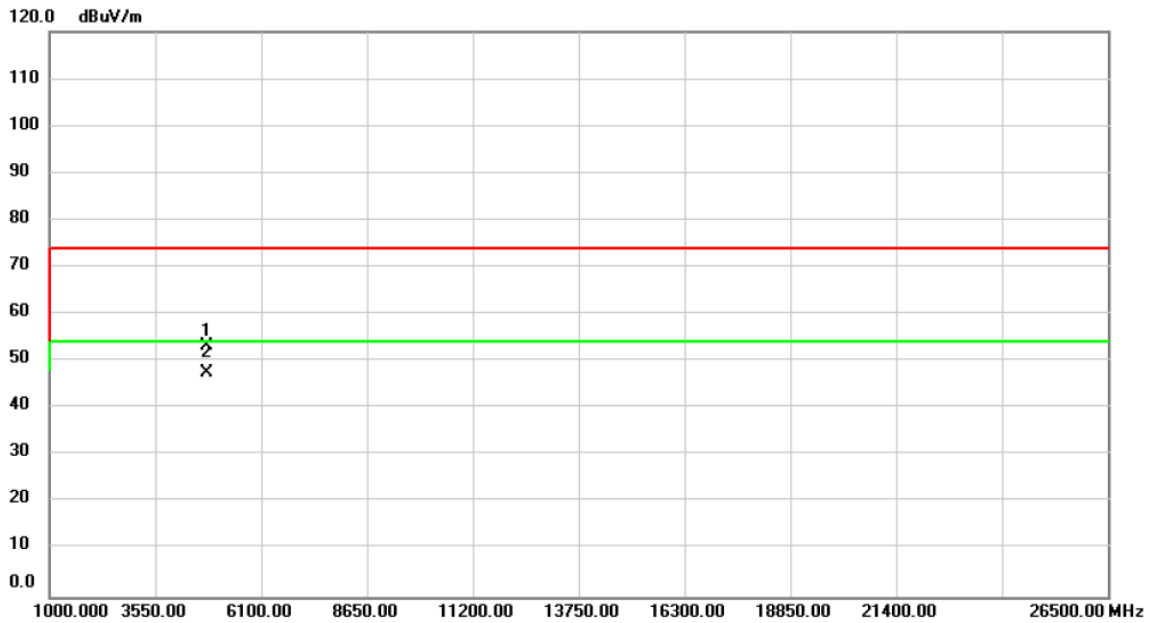

No.	Mk.	Freq.	Reading Level	Correct Factor	Measurement	Limit	Over	Detector	Comment
		MHz	dBuV	dB	dBuV/m	dBuV/m	dB		
1		4804.000	63.98	-10.69	53.29	74.00	-20.71	peak	
2	*	4804.000	58.12	-5.86	47.43	54.00	-6.57	AVG	

REMARKS:

- (1) Measurement Value = Reading Level + Correct Factor.
- (2) Margin Level = Measurement Value - Limit Value.
- (3) Average Correct Factor = $20\text{Log}(\text{duty cycle}) = 5.86$

Test Mode	SRD	Test Date	2020/6/2
Test Frequency	CH00: 2402 MHz	Polarization	Horizontal

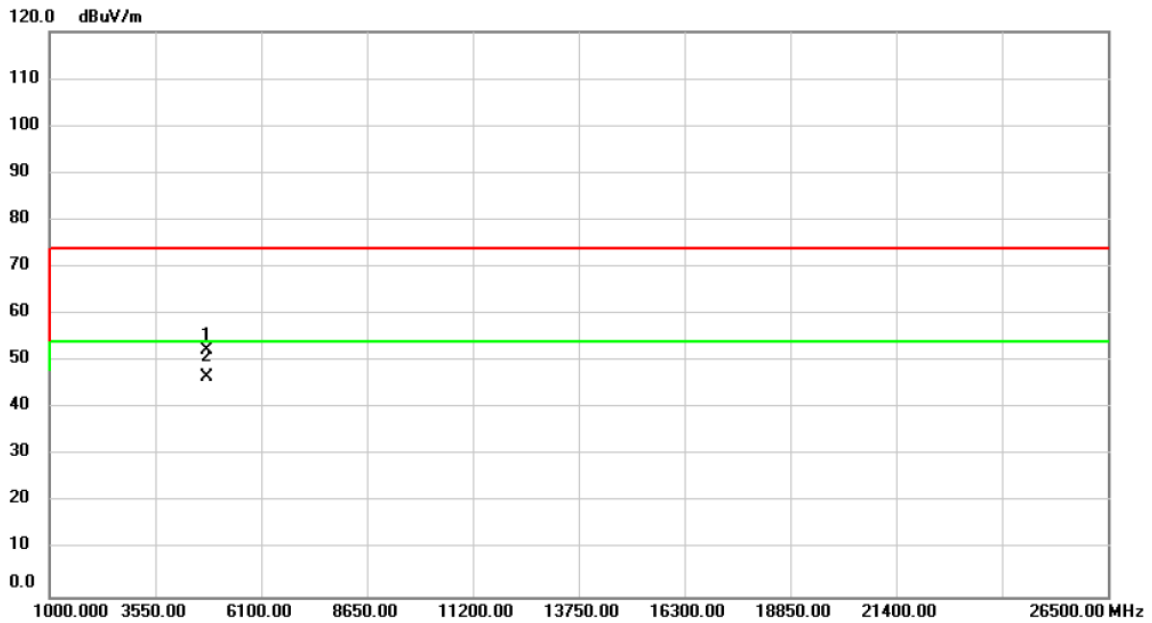

No.	Mk.	Freq.	Reading Level	Correct Factor	Measurement	Limit	Over	Detector	Comment
		MHz	dBuV	dB	dBuV/m	dBuV/m	dB		
1		4804.000	63.09	-10.69	52.40	74.00	-21.60	peak	
2	*	4804.000	57.23	-5.86	46.54	54.00	-7.46	AVG	

REMARKS:
 (1) Measurement Value = Reading Level + Correct Factor.
 (2) Margin Level = Measurement Value - Limit Value.
 (3) Average Correct Factor = $20\text{Log}(\text{duty cycle}) = 5.86$

Test Mode	SRD	Test Date	2020/6/2
Test Frequency	CH19: 2440 MHz	Polarization	Vertical

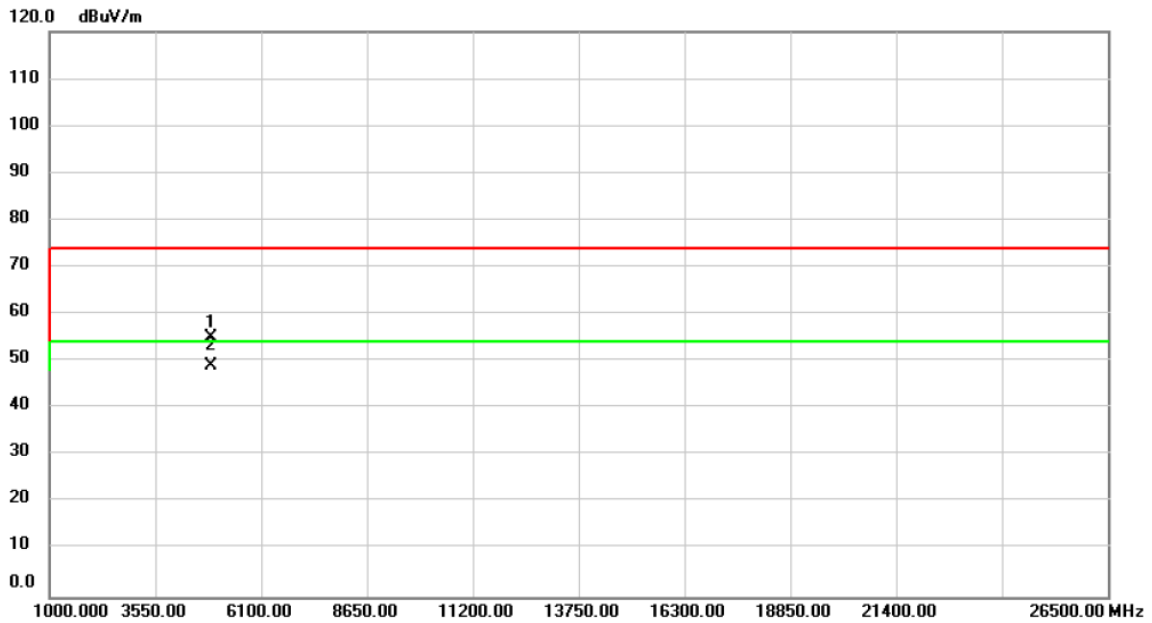

No.	Mk.	Freq.	Reading Level	Correct Factor	Measurement	Limit	Over	Detector	Comment
		MHz	dBuV	dB	dBuV/m	dBuV/m	dB		
1		4880.000	65.44	-10.53	54.91	74.00	-19.09	peak	
2	*	4880.000	59.58	-5.86	49.05	54.00	-4.95	AVG	

REMARKS:

- (1) Measurement Value = Reading Level + Correct Factor.
- (2) Margin Level = Measurement Value - Limit Value.
- (3) Average Correct Factor = $20\text{Log}(\text{duty cycle}) = 5.86$

Test Mode	SRD	Test Date	2020/6/2
Test Frequency	CH19: 2440 MHz	Polarization	Horizontal

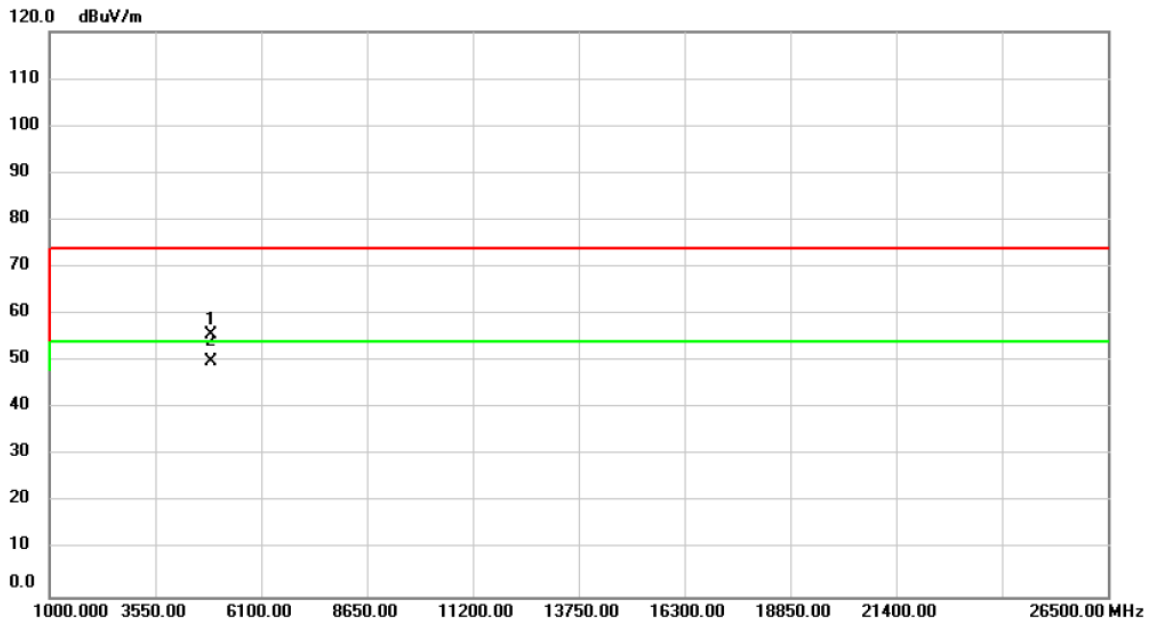

No.	Mk.	Freq.	Reading Level	Correct Factor	Measurement	Limit	Over	Detector	Comment
		MHz	dBuV	dB	dBuV/m	dBuV/m	dB		
1		4880.000	66.33	-10.53	55.80	74.00	-18.20	peak	
2	*	4880.000	60.47	-5.86	49.94	54.00	-4.06	AVG	

REMARKS:

- (1) Measurement Value = Reading Level + Correct Factor.
- (2) Margin Level = Measurement Value - Limit Value.
- (3) Average Correct Factor = $20\text{Log}(\text{duty cycle}) = 5.86$

Test Mode	SRD	Test Date	2020/6/2
Test Frequency	CH39: 2480 MHz	Polarization	Vertical

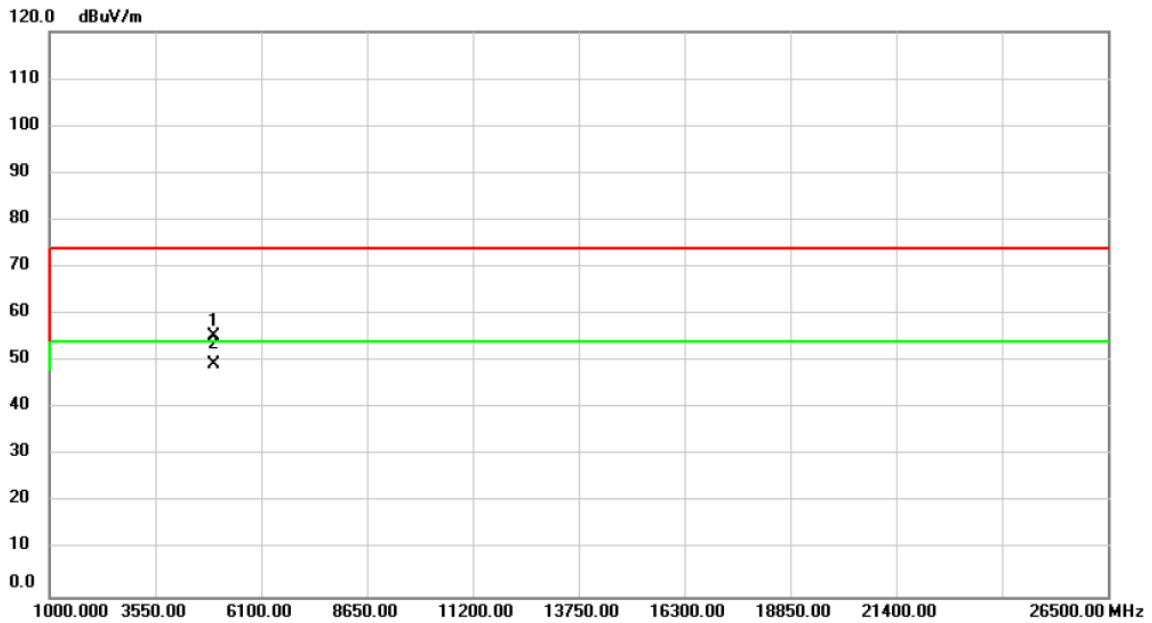

No.	Mk.	Freq.	Reading Level	Correct Factor	Measurement	Limit	Over	Detector	Comment
		MHz	dBuV	dB	dBuV/m	dBuV/m	dB		
1		4960.000	65.62	-10.35	55.27	74.00	-18.73	peak	
2	*	4960.000	59.76	-5.86	49.41	54.00	-4.59	AVG	

REMARKS:

- (1) Measurement Value = Reading Level + Correct Factor.
- (2) Margin Level = Measurement Value - Limit Value.
- (3) Average Correct Factor = $20\text{Log}(\text{duty cycle}) = 5.86$

Test Mode	SRD	Test Date	2020/6/2
Test Frequency	CH39: 2480 MHz	Polarization	Horizontal

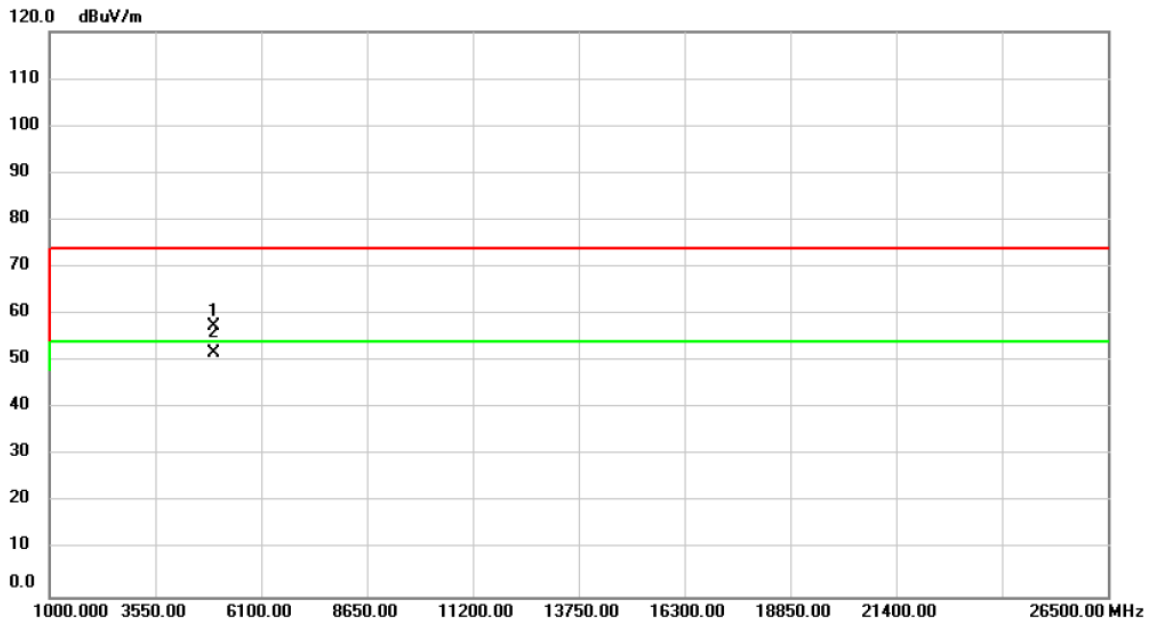

No.	Mk.	Freq.	Reading Level	Correct Factor	Measurement	Limit	Over	Detector	Comment
		MHz	dBuV	dB	dBuV/m	dBuV/m	dB		
1		4960.000	67.86	-10.35	57.51	74.00	-16.49	peak	
2	*	4960.000	62.00	-5.86	51.65	54.00	-2.35	AVG	

REMARKS:

- (1) Measurement Value = Reading Level + Correct Factor.
- (2) Margin Level = Measurement Value - Limit Value.
- (3) Average Correct Factor = $20\text{Log}(\text{duty cycle}) = 5.86$

APPENDIX D BANDWIDTH

Test Mode: TX Mode _1Mbps

Frequency (MHz)	20dB Bandwidth (MHz)	99% Occupied BW (MHz)	Min. Limit (kHz)	Test Result
2402	1.65	1.62	500	Pass
2440	1.77	1.76	500	Pass
2480	2.04	1.84	500	Pass

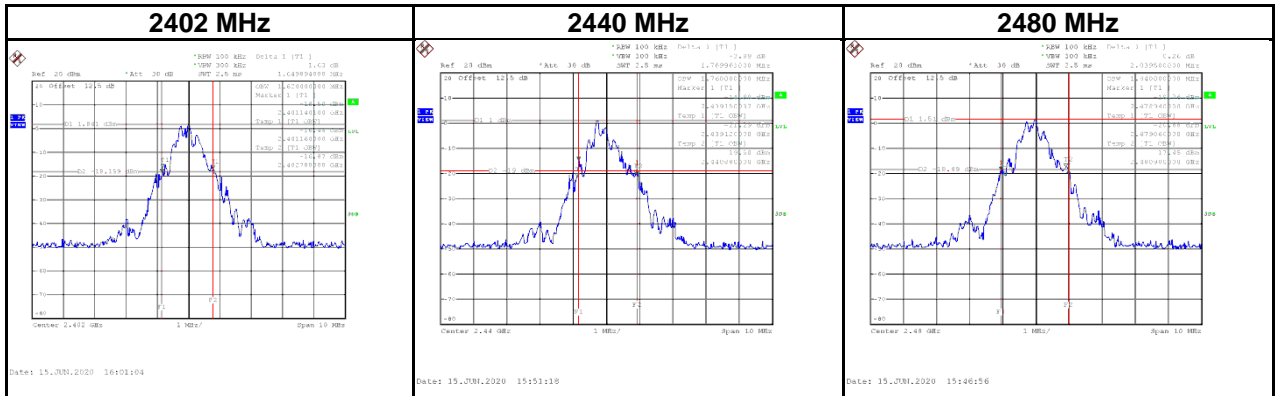

End of Test Report