

TEST REPORT

CERTIFICATE OF CONFORMITY

Standard: 47 CFR FCC Part 15, Subpart C (Section 15.247)
Report No.: RFBDBO-WTW-P21110499
FCC ID: 2AAUCGMODMS
Model No.: GMO-DMS-HYOGBK-01
Received Date: 2021/11/15
Test Date: 2022/1/13 ~ 2022/5/6
Issued Date: 2022/8/22

Applicant: Thermaltake Technology Co., Ltd.
Address: 5F.,No.185,Sec.2,Tiding Blvd.,Neihu Dist., Taipei City 114, Taiwan
Issued By: Bureau Veritas Consumer Products Services (H.K.) Ltd., Taoyuan Branch
Lin Kou Laboratories
Lab Address: No. 47-2, 14th Ling, Chia Pau Vil., Lin Kou Dist., New Taipei City, Taiwan
Test Location: No. 47-2, 14th Ling, Chia Pau Vil., Lin Kou Dist., New Taipei City, Taiwan
FCC Registration / 198487 / TW2021
Designation Number:

Approved by: Jeremy Lin , **Date:** 2022/8/22
Jeremy Lin / Project Engineer

This test report consists of 42 pages in total. It may be duplicated completely for legal use with the approval of the applicant. It should not be reproduced except in full, without the written approval of our laboratory. The test results in the report only apply to the tested sample. The test results in this report are traceable to the national or international standards.

Prepared by : Jessica Cheng / Senior Specialist



Table of Contents

Release Control Record	4
1 Certificate.....	5
2 Summary of Test Results	6
2.1 Measurement Uncertainty	6
2.2 Supplementary Information	6
3 General Information	7
3.1 General Description	7
3.2 Antenna Description of EUT	8
3.3 Channel List.....	9
3.4 Test Mode Applicability and Tested Channel Detail.....	10
3.5 Duty Cycle of Test Signal.....	11
3.6 Test Program Used and Operation Descriptions	12
3.7 Connection Diagram of EUT and Peripheral Devices	12
3.8 Configuration of Peripheral Devices and Cable Connections	13
4 Test Instruments	14
4.1 RF Output Power.....	14
4.2 Power Spectral Density	14
4.3 6 dB Bandwidth	14
4.4 Conducted Out of Band Emissions	14
4.5 AC Power Conducted Emissions	15
4.6 Unwanted Emissions below 1 GHz	16
4.7 Unwanted Emissions above 1 GHz.....	17
5 Limits of Test Items.....	18
5.1 RF Output Power.....	18
5.2 Power Spectral Density	18
5.3 6 dB Bandwidth	18
5.4 Conducted Out of Band Emissions	18
5.5 AC Power Conducted Emissions	18
5.6 Unwanted Emissions below 1 GHz	18
5.7 Unwanted Emissions above 1 GHz.....	19
6 Test Arrangements.....	20
6.1 RF Output Power.....	20
6.1.1 Test Setup	20
6.1.2 Test Procedure.....	20
6.2 Power Spectral Density	20
6.2.1 Test Setup	20
6.2.2 Test Procedure.....	20
6.3 6 dB Bandwidth	21
6.3.1 Test Setup	21
6.3.2 Test Procedure.....	21
6.4 Conducted Out of Band Emissions	21
6.4.1 Test Setup	21
6.4.2 Test Procedure.....	21
6.5 AC Power Conducted Emissions	22
6.5.1 Test Setup	22
6.5.2 Test Procedure.....	22
6.6 Unwanted Emissions below 1 GHz	23
6.6.1 Test Setup	23
6.6.2 Test Procedure.....	24
6.7 Unwanted Emissions above 1 GHz.....	25
6.7.1 Test Setup	25
6.7.2 Test Procedure.....	25
7 Test Results of Test Item	26



7.1	RF Output Power	26
7.2	Power Spectral Density	27
7.3	6 dB Bandwidth	28
7.4	Conducted Out of Band Emissions	29
7.5	AC Power Conducted Emissions	30
7.6	Unwanted Emissions below 1 GHz	32
7.7	Unwanted Emissions above 1 GHz	34
8	Pictures of Test Arrangements	41
9	Information of the Testing Laboratories	42



Release Control Record

Issue No.	Description	Date Issued
RFBDBO-WTW-P21110499	Original release.	2022/8/22

1 Certificate

Product: DAMYSUS Wireless RGB Ergonomic Gaming Mouse

Brand: Thermaltake

Test Model: GMO-DMS-HYOOBK-01

Sample Status: Engineering sample

Applicant: Thermaltake Technology Co., Ltd.

Test Date: 2022/1/13 ~ 2022/5/6

Standard: 47 CFR FCC Part 15, Subpart C (Section 15.247)

Measurement ANSI C63.10-2013

procedure: KDB 558074 D01 15.247 Meas Guidance v05r02

The above equipment has been tested by **Bureau Veritas Consumer Products Services (H.K.) Ltd., Taoyuan Branch**, and found compliance with the requirement of the above standards. The test record, data evaluation & Equipment Under Test (EUT) configurations represented herein are true and accurate accounts of the measurements of the sample's RF characteristics under the conditions specified in this report.

2 Summary of Test Results

47 CFR FCC Part 15, Subpart C (Section 15.247)			
Standard / Clause	Test Item	Result	Remark
15.247(b)	RF Output Power	Pass	Meet the requirement of limit.
15.247(e)	Power Spectral Density	Pass	Meet the requirement of limit.
15.247(a)(2)	6 dB Bandwidth	Pass	Meet the requirement of limit.
15.247(d)	Conducted Out of Band Emissions	Pass	Meet the requirement of limit.
15.207	AC Power Conducted Emissions	Pass	Minimum passing margin is -13.78 dB at 0.15000 MHz
15.205 / 15.209 / 15.247(d)	Unwanted Emissions below 1 GHz	Pass	Minimum passing margin is -7.08 dB at 38.73 MHz
15.205 / 15.209 / 15.247(d)	Unwanted Emissions above 1 GHz	Pass	Minimum passing margin is -0.3 dB at 7320.00, 7440.00 MHz
15.203	Antenna Requirement	Pass	No antenna connector is used.

Note: Determining compliance based on the results of the compliance measurement, not taking into account measurement instrumentation uncertainty.

2.1 Measurement Uncertainty

Where relevant, the following measurement uncertainty levels have been estimated for tests performed on the EUT as specified in CISPR 16-4-2:

Measurement	Specification	Expanded Uncertainty (k=2) (±)
Conducted Out of Band Emissions	9 kHz ~ 40 GHz	2.63 dB
AC Power Conducted Emissions	150 kHz ~ 30 MHz	3.00 dB
Unwanted Emissions below 1 GHz	9 kHz ~ 30 MHz	2.38 dB
	30 MHz ~ 1 GHz	5.62 dB
Unwanted Emissions above 1 GHz	1 GHz ~ 6 GHz	4.61 dB
	6 GHz ~ 18 GHz	5.41 dB
	18 GHz ~ 40 GHz	5.14 dB

The other instruments specified are routine verified to remain within the calibrated levels, no measurement uncertainty is required to be calculated.

2.2 Supplementary Information

There is not any deviation from the test standards for the test method, and no modifications required for compliance.

3 General Information

3.1 General Description

Product	DAMYSUS Wireless RGB Ergonomic Gaming Mouse
Brand	Thermaltake
Test Model	GMO-DMS-HYOOBK-01
Status of EUT	Engineering sample
Power Supply Rating	3.7Vdc from battery or 5Vdc from host equipment
Modulation Type	GFSK
Modulation Technology	DTS
Transfer Rate	Up to 1 Mbps
Operating Frequency	2402 ~ 2480 MHz
Number of Channel	40
Output Power	1.183 mW (0.73 dBm)
Data Cable Supplied	Shielded USB type C cable (1.8m)

Note:

1. Bluetooth & SRD technologies can not transmit at same time.
2. The EUT uses following rechargeable battery.

Manufacturer	Shenzhen DongHui Energy Co., Ltd.
Model	802036
Rating	3.7Vdc, 500mAh

3. The above EUT information is declared by manufacturer and for more detailed features description, please refer to the manufacturer's specifications or User's Manual.

3.2 Antenna Description of EUT

1. The antenna information is listed as below.

Gain (dBi)	Antenna Type	Connector Type
3.73	PCB	N/A

* Detail antenna specification please refer to antenna datasheet and/or antenna measurement report.

3.3 Channel List

40 channels are provided for BT-LE:

Channel	Frequency (MHz)	Channel	Frequency (MHz)	Channel	Frequency (MHz)	Channel	Frequency (MHz)
0	2402	10	2422	20	2442	30	2462
1	2404	11	2424	21	2444	31	2464
2	2406	12	2426	22	2446	32	2466
3	2408	13	2428	23	2448	33	2468
4	2410	14	2430	24	2450	34	2470
5	2412	15	2432	25	2452	35	2472
6	2414	16	2434	26	2454	36	2474
7	2416	17	2436	27	2456	37	2476
8	2418	18	2438	28	2458	38	2478
9	2420	19	2440	29	2460	39	2480

3.4 Test Mode Applicability and Tested Channel Detail

Pre-Scan:	1. For Unwanted Emission below 1 GHz has Battery / Laptop / AC Adapter mode of power supply. Pre-scan these modes and find the worst case as a representative test condition. 2. For AC Power Conducted Emission items: Laptop / AC Adapter mode of power supply. Pre-scan these modes and find the worst case as a representative test condition.
Worst Case:	1. For Unwanted Emission below 1 GHz Laptop mode is the worst case of power supply. 2. For AC Power Conducted Emission Laptop mode is the worst case of power supply.
Final test:	Mode A. Operating Mode (Powered from Battery) Mode B. Charging Mode (Powered from Laptop)

Following channel(s) was (were) selected for the final test as listed below:

Test Item	Mode		Tested Channel	Modulation	Data Rate Parameter
AC Power Conducted Emissions	Mode B	BT-LE 1M	-	-	-
Unwanted Emissions below 1 GHz	Mode B	BT-LE 1M	-	-	-
Unwanted Emissions above 1 GHz	Mode A	BT-LE 1M	0, 19, 39	GFSK	1Mb/s
RF Output Power / Power Spectral Density	Mode A	BT-LE 1M	0, 19, 39	GFSK	1Mb/s
6 dB Bandwidth / Conducted Out of Band Emissions	Mode A	BT-LE 1M	0, 19, 39	GFSK	1Mb/s

3.5 Duty Cycle of Test Signal

Duty cycle of test signal is < 98 %, duty factor shall be considered.

BT-LE 1M: Duty cycle = $0.394 \text{ ms} / 0.624 \text{ ms} \times 100\% = 63.1\%$, duty factor = $10 * \log (1/\text{Duty cycle}) = 2.00 \text{ dB}$

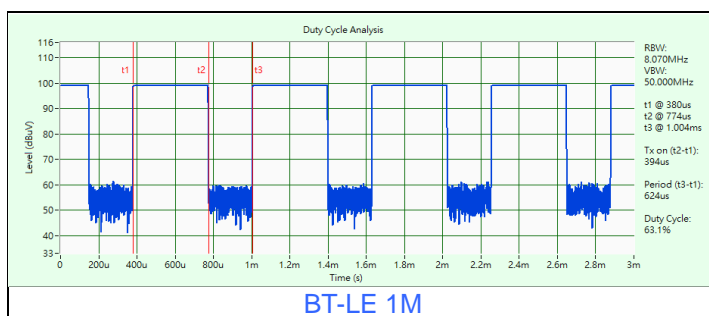

3.6 Test Program Used and Operation Descriptions

Controlling software (8852) has been activated to set the EUT under transmission condition continuously at specific channel frequency.

3.7 Connection Diagram of EUT and Peripheral Devices

Mode A- Operating Mode (Powered from Battery)

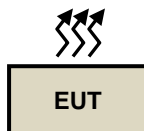

Mode B - Charging Mode (Powered from Laptop)

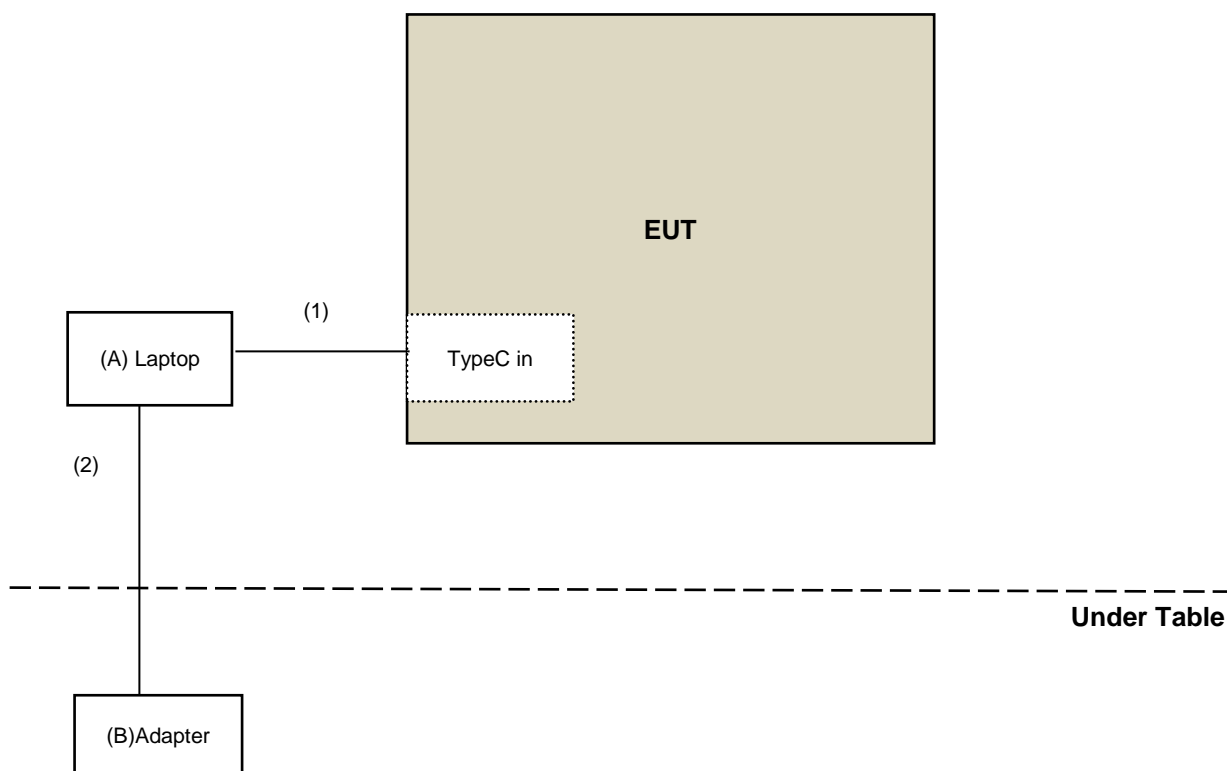

3.8 Configuration of Peripheral Devices and Cable Connections

ID	Product	Brand	Model No.	Serial No.	FCC ID	Remarks
A	Laptop	Lenove	81LG	PHNGBDP	DoC	Provided by Lab
B	Adapter	Lenovo	PA-1450-55LL	N/A	N/A	Provided by Lab

ID	Cable Descriptions	Qty.	Length (m)	Shielding (Yes/No)	Cores (Qty.)	Remarks
1	Type-A to C cable	1	1.8	Y	N	Supplied by applicant
2	DC Cable	1	1.8	Y	N	Provided by Lab

4 Test Instruments

The calibration interval of the all test instruments are 12 months and the calibrations are traceable to NML/ROC and NIST/USA.

4.1 RF Output Power

Description Manufacturer	Model No.	Serial No.	Calibrated Date	Calibrated Until
MIMO Powermeasurement Test set (4X4) KEYSIGHT	U2021XA	U2021XA_001	2021/6/16	2022/6/15
MXG Vector Signal Generator KEYSIGHT	N5182B	MY53052658	2021/5/19	2022/5/18
Power Meter Anritsu	ML2495A	1232003	2022/1/9	2023/1/8
Power Sensor Anritsu	MA2411B	1207333	2022/1/9	2023/1/8
Spectrum Analyzer R&S	FSV40	101544	2021/5/24	2022/5/23
		101042	2021/9/9	2022/9/8
Spectrum Analyzer KEYSIGHT	N9030A	MY54490260	2021/7/23	2022/7/22
Temperature & Humidity Chamber TERCHY	MHU-225AU	920409	2021/7/2	2022/7/1
True RMS Clamp Meter Fluke	325	31130711WS	2021/6/2	2022/6/1

Notes:

1. The test was performed in LK - Oven
2. Tested Date: 2022/5/6

4.2 Power Spectral Density

Refer to section 4.1 to get information of the instruments.

4.3 6 dB Bandwidth

Refer to section 4.1 to get information of the instruments.

4.4 Conducted Out of Band Emissions

Refer to section 4.1 to get information of the instruments.

4.5 AC Power Conducted Emissions

Description Manufacturer	Model No.	Serial No.	Calibrated Date	Calibrated Until
50 Ohms Terminator LYNICS	0900510	E1-01-305	2022/2/9	2023/2/8
Attenuator STI	STI02-2200-10	NO.4	2021/9/3	2022/9/2
DC LISN R&S	ESH3-Z6	844950/018	2021/7/25	2022/7/24
		100219	2021/7/25	2022/7/24
High Voltage Probe Schwarzbeck	TK9420	00982	2021/12/24	2022/12/23
Isolation Transformer Erika Fiedler	D-65396	017	2021/9/9	2022/9/8
LISN Schwarzbeck	NSLK 8128	8128-244	2021/11/11	2022/11/10
	NNLK8129	8129229	2021/5/20	2022/5/19
	NNLK 8121	8121-731	2021/4/28	2022/4/27
LISN R&S	ENV216	101196	2021/4/26	2022/4/25
	ESH3-Z5	100220	2021/11/25	2022/11/24
RF Coaxial Cable Commate	5D-FB	Cable-CO5-01	2022/1/28	2023/1/27
Software BVADT	Cond_V7.3.7.4	N/A	N/A	N/A
Test Receiver R&S	ESR3	102412	2022/1/22	2023/1/21

Notes:

1. The test was performed in Linkou Conduction 5.
2. Tested Date: 2022/4/19

4.6 Unwanted Emissions below 1 GHz

Description Manufacturer	Model No.	Serial No.	Calibrated Date	Calibrated Until
* LOOP ANTENNA EMCI	LPA600	270	2021/9/2	2023/9/1
Bi_Log Antenna Schwarzbeck	VULB 9168	137	2021/10/27	2022/10/26
Coupling/Dcoupling Network Schwarzbeck	CDNE-M2	00097	2021/5/6	2022/5/5
	CDNE-M3	00091	2021/5/6	2022/5/5
Pre_Amplifier EMCI	EMC001340	980269	2021/6/29	2022/6/28
Pre_Amplifier HP	8447D	2432A03504	2021/2/18	2022/2/17
RF Coaxial Cable Pacific	8D-FB	Cable-CH6-02	2021/7/13	2022/7/12
Software BVADT	Radiated_V8.7.08	N/A	N/A	N/A
Spectrum Analyzer R&S	FSV40	101544	2021/5/24	2022/5/23
Test Receiver Agilent	N9038A	MY51210129	2021/3/12	2022/3/11
		MY51210137	2021/6/16	2022/6/15
Tower ADT	AT100	0306	N/A	N/A
Turn Table ADT	TT100	0306	N/A	N/A

Notes:

1. * The calibration interval of the above test instruments is 24 months and the calibrations are traceable to NML/ROC and NIST/USA
2. The test was performed in Linkou 966 Chamber 6 (CH 6).
3. Tested Date: 2022/1/13

4.7 Unwanted Emissions above 1 GHz

Description Manufacturer	Model No.	Serial No.	Calibrated Date	Calibrated Until
BandPass Filter MICRO-TRONICS	BRM17690	005	2021/5/28	2022/5/27
Boresight antenna tower fixture BV	BAF-02	6	N/A	N/A
Highpass filter Wainwright Instruments	WHK 3.1/18G-10SS	SN 8	2021/5/28	2022/5/27
Horn Antenna ETS-Lindgren	3117-PA	00215857	2021/11/14	2022/11/13
Horn Antenna EMCO	3115	00028257	2021/11/14	2022/11/13
		00027024	2021/11/14	2022/11/13
Horn Antenna Schwarzbeck	BBHA 9170	212	2021/10/13	2022/10/12
Notch filter MICRO-TRONICS	BRC50703-01	010	2021/5/28	2022/5/27
Pre_Amplifier EMCI	EMC0126545	980076	2022/2/17	2023/2/16
	EMC184045B	980235	2022/2/17	2023/2/16
Pre-amplifier HP	8449B	3008A01201	2022/2/17	2023/2/16
Pre-amplifier (18GHz-40GHz) EMCI	EMC184045B	980175	2021/9/4	2022/9/3
RF Coaxial Cable HUBER SUHNER	SF-102	Cable-CH6-01	2021/7/8	2022/7/7
RF Coaxial Cable EM	EM102-KMKM-3.5+1M	EM102-KMKM-3.5+1M-01	2021/7/8	2022/7/7
RF Coaxial Cable WOKEN	WC01	Cable-CH10-03	2021/7/8	2022/7/7
RF Coaxial Cable Rosnol	K1K50-UP0279-K1K50-3000	Cable-CH10(3m)-04	2021/7/8	2022/7/7
Software BVADT	Radiated_V8.7.08	N/A	N/A	N/A
Spectrum Analyzer Agilent	E4446A	MY51100009	2021/6/29	2022/6/28
Spectrum Analyzer KEYSIGHT	N9030A	MY54490260	2021/7/23	2022/7/22
Spectrum Analyzer R&S	FSV40	101544	2021/5/24	2022/5/23
		101042	2021/9/9	2022/9/8
Test Receiver Agilent	N9038A	MY51210129	2022/4/8	2023/4/7
		MY51210137	2021/6/16	2022/6/15
Tower ADT	AT100	0306	N/A	N/A
Turn Table ADT	TT100	0306	N/A	N/A

Notes:

1. The test was performed in Linkou 966 Chamber 6 (CH 6).
2. Tested Date: 2022/4/29

5 Limits of Test Items

5.1 RF Output Power

For systems using digital modulation in the 2400–2483.5 MHz bands: 1 Watt (30 dBm)

5.2 Power Spectral Density

The Maximum of Power Spectral Density Measurement is 8 dBm in any 3 kHz.

5.3 6 dB Bandwidth

The minimum of 6 dB Bandwidth Measurement is 0.5 MHz.

5.4 Conducted Out of Band Emissions

Below 20 dB of the highest emission level of operating band (in 100 kHz Resolution Bandwidth).

5.5 AC Power Conducted Emissions

Frequency (MHz)	Conducted Limit (dBuV)	
	Quasi-peak	Average
0.15 - 0.5	66 - 56	56 - 46
0.50 - 5.0	56	46
5.0 - 30.0	60	50

Notes:

1. The lower limit shall apply at the transition frequencies.
2. The limit decreases in line with the logarithm of the frequency in the range of 0.15 to 0.50 MHz.

5.6 Unwanted Emissions below 1 GHz

Radiated emissions up to 1 GHz which fall in the restricted bands must comply with the radiated emission limits specified as below table. Other emissions shall be at least 20 dB below the highest level of the desired power:

Frequencies (MHz)	Field Strength (microvolts/meter)	Measurement Distance (meters)
0.009 ~ 0.490	2400/F(kHz)	300
0.490 ~ 1.705	24000/F(kHz)	30
1.705 ~ 30.0	30	30
30 ~ 88	100	3
88 ~ 216	150	3
216 ~ 960	200	3
Above 960	500	3

Notes:

1. The lower limit shall apply at the transition frequencies.
2. Emission level (dBuV/m) = 20 log Emission level (uV/m).

5.7 Unwanted Emissions above 1 GHz

Radiated emissions above 1 GHz which fall in the restricted bands must comply with the radiated emission limits specified as below table. Other emissions shall be at least 20 dB below the highest level of the desired power:

Frequencies (MHz)	Field Strength (microvolts/meter)	Measurement Distance (meters)
Above 960	500	3

Notes:

1. The lower limit shall apply at the transition frequencies.
2. Emission level (dBuV/m) = 20 log Emission level (uV/m).
3. For frequencies above 1000 MHz, the field strength limits are based on average detector, however, the peak field strength of any emission shall not exceed the maximum permitted average limits, specified above by more than 20 dB under any condition of modulation.

6 Test Arrangements

6.1 RF Output Power

6.1.1 Test Setup

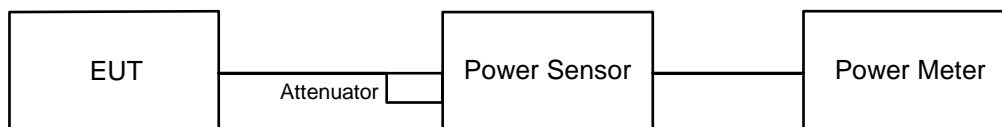

6.1.2 Test Procedure

Peak Power:

A peak power sensor was used on the output port of the EUT. A power meter was used to read the response of the peak power sensor. Record the power level.

Average Power:

Average power sensor was used to perform output power measurement, trigger and gating function of wide band power meter is enabled to measure max output power of TX on burst. Duty factor is not added to measured value.

6.2 Power Spectral Density

6.2.1 Test Setup

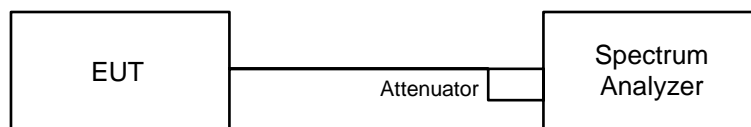

6.2.2 Test Procedure

- a. Set analyzer center frequency to DTS channel center frequency.
- b. Set the span to 1.5 times the DTS bandwidth.
- c. Set the RBW to: 3 kHz.
- d. Set the VBW $\geq 3 \times$ RBW.
- e. Detector = peak.
- f. Sweep time = auto couple.
- g. Trace mode = max hold.
- h. Allow trace to fully stabilize.
- i. Use the peak marker function to determine the maximum amplitude level within the RBW.

6.3 6 dB Bandwidth

6.3.1 Test Setup

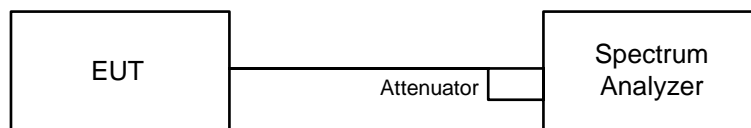

6.3.2 Test Procedure

- Set resolution bandwidth (RBW) = 100 kHz.
- Set the video bandwidth (VBW) $\geq 3 \times$ RBW, Detector = Peak.
- Trace mode = max hold.
- Sweep = auto couple.
- Measure the maximum width of the emission that is constrained by the frequencies associated with the two amplitude points (upper and lower) that are attenuated by 6 dB relative to the maximum level measured in the fundamental emission.

6.4 Conducted Out of Band Emissions

6.4.1 Test Setup

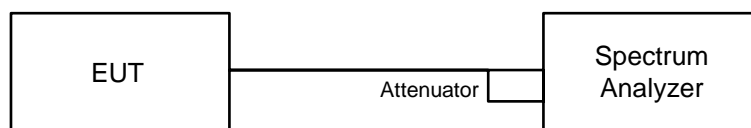

6.4.2 Test Procedure

MEASUREMENT PROCEDURE REF

- Set the RBW = 100 kHz.
- Set the VBW ≥ 300 kHz.
- Detector = peak.
- Sweep time = auto couple.
- Trace mode = max hold.
- Allow trace to fully stabilize.
- Use the peak marker function to determine the maximum power level in any 100 kHz band segment within the fundamental EBW.

MEASUREMENT PROCEDURE OOB

- Set RBW = 100 kHz.
- Set VBW ≥ 300 kHz.
- Detector = peak.
- Sweep = auto couple.
- Trace Mode = max hold.
- Allow trace to fully stabilize.
- Use the peak marker function to determine the maximum amplitude level.

6.5 AC Power Conducted Emissions

6.5.1 Test Setup

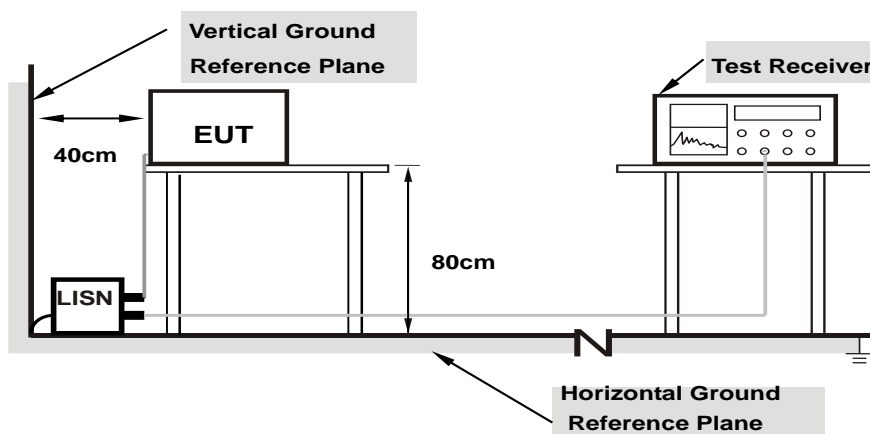

Note: 1.Support units were connected to second LISN.

For the actual test configuration, please refer to the attached file (Test Setup Photo).

6.5.2 Test Procedure

- The EUT was placed 0.4 meters from the conducting wall of the shielded room with EUT being connected to the power mains through a line impedance stabilization network (LISN). Other support units were connected to the power mains through another LISN. The two LISNs provide 50 ohm/ 50 uH of coupling impedance for the measuring instrument.
- Both lines of the power mains connected to the EUT were checked for maximum conducted interference.
- The frequency range from 150 kHz to 30 MHz was searched. Emission levels under (Limit – 20 dB) was not recorded.

Note:

The resolution bandwidth and video bandwidth of test receiver is 9 kHz for quasi-peak detection (QP) and average detection (AV) at frequency 0.15 MHz-30 MHz.

6.6 Unwanted Emissions below 1 GHz

6.6.1 Test Setup

For Radiated emission below 30 MHz

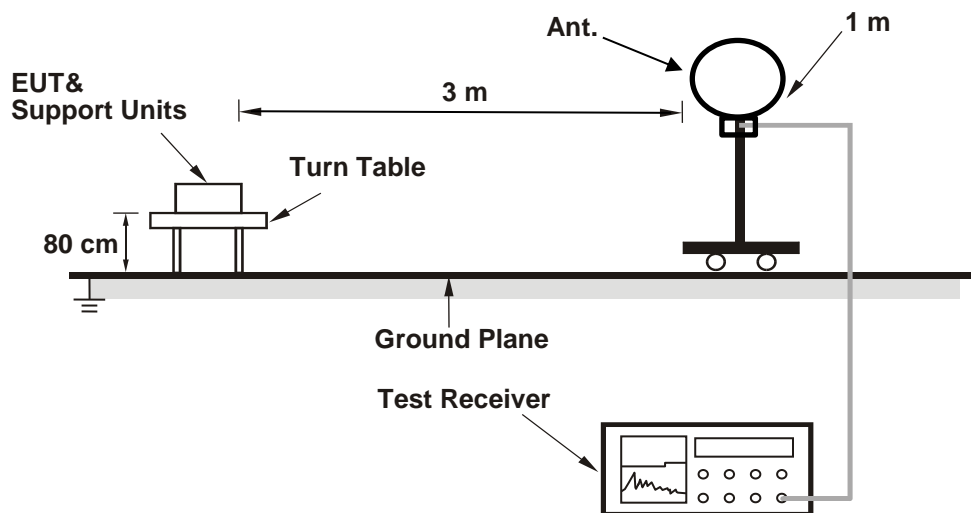

For Radiated emission above 30 MHz

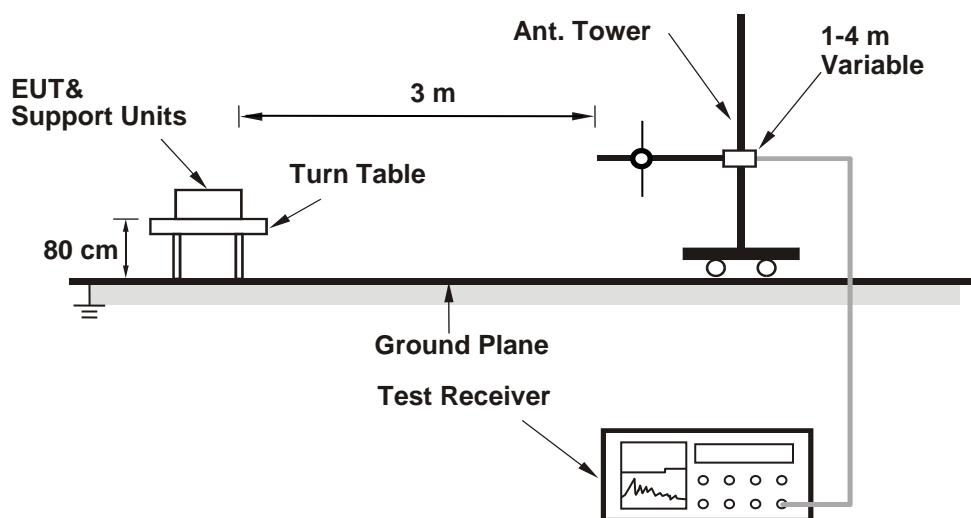

6.6.2 Test Procedure

For Radiated emission below 30 MHz

- a. The EUT was placed on the top of a rotating table 0.8 meters above the ground at 3 meter chamber room for test. The table was rotated 360 degrees to determine the position of the highest radiation.
- b. The EUT was set 3 meters away from the interference-receiving antenna, which was mounted on the top of a variable-height antenna tower.
- c. Parallel, perpendicular, and ground-parallel orientations of the antenna are set to make the measurement.
- d. For each suspected emission, the EUT was arranged to its worst case and the rotatable table was turned from 0 degrees to 360 degrees to find the maximum reading.
- e. The test-receiver system was set to Quasi-Peak Detect Function and Specified Bandwidth with Maximum Hold Mode.

Notes:

1. The resolution bandwidth and video bandwidth of test receiver/spectrum analyzer is 9 kHz at frequency below 30 MHz.
2. All modes of operation were investigated and the worst-case emissions are reported.

For Radiated emission above 30 MHz

- a. The EUT was placed on the top of a rotating table 0.8 meters above the ground at 3 meter chamber room for test. The table was rotated 360 degrees to determine the position of the highest radiation.
- b. The EUT was set 3 meters away from the interference-receiving antenna, which was mounted on the top of a variable-height antenna tower.
- c. The height of antenna is varied from one meter to four meters above the ground to determine the maximum value of the field strength. Both horizontal and vertical polarizations of the antenna are set to make the measurement.
- d. For each suspected emission, the EUT was arranged to its worst case and then the antenna was tuned to heights from 1 meter to 4 meters and the rotatable table was turned from 0 degrees to 360 degrees to find the maximum reading.
- e. The test-receiver system was set to quasi-peak detect function and specified bandwidth with maximum hold mode when the test frequency is below 1 GHz.

Notes:

1. The resolution bandwidth and video bandwidth of test receiver/spectrum analyzer is 120 kHz for Quasi-peak detection (QP) at frequency below 1 GHz.
2. All modes of operation were investigated and the worst-case emissions are reported.

6.7 Unwanted Emissions above 1 GHz

6.7.1 Test Setup

For Radiated emission above 1 GHz

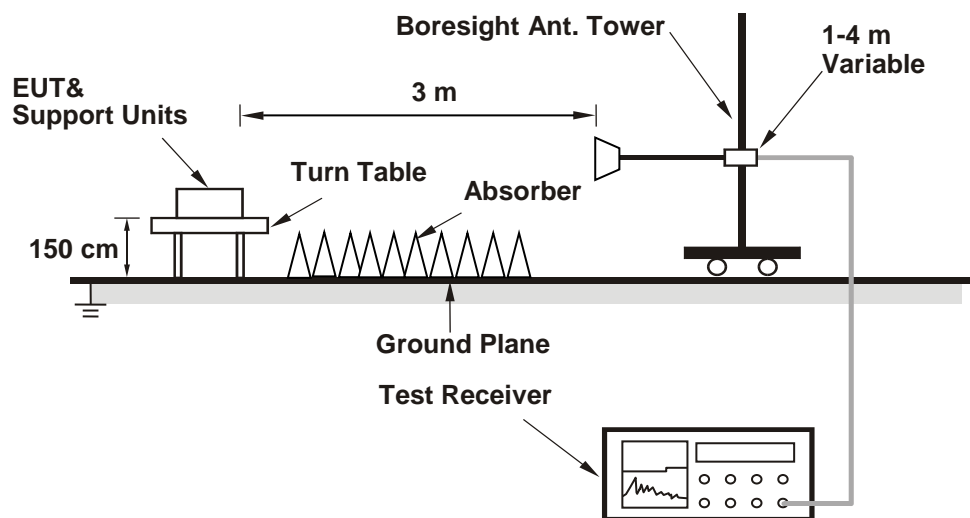

For the actual test configuration, please refer to the attached file (Test Setup Photo).

6.7.2 Test Procedure

- The EUT was placed on the top of a rotating table 1.5 meters above the ground at 3 meter chamber room for test. The table was rotated 360 degrees to determine the position of the highest radiation.
- The EUT was set 3 meters away from the interference-receiving antenna, which was mounted on the top of a variable-height antenna tower.
- The height of antenna is varied from one meter to four meters above the ground to determine the maximum value of the field strength. Both horizontal and vertical polarizations of the antenna are set to make the measurement.
- For each suspected emission, the EUT was arranged to its worst case and then the antenna was tuned to heights from 1 meter to 4 meters and the rotatable table was turned from 0 degrees to 360 degrees to find the maximum reading.
- The test-receiver system was set to peak and average detects function and specified bandwidth with maximum hold mode when the test frequency is above 1 GHz. If the peak reading value also meets average limit, measurement with the average detector is unnecessary.

Notes:

- The resolution bandwidth of test receiver/spectrum analyzer is 1 MHz and the video bandwidth is 3 MHz for Peak detection (PK) at frequency above 1 GHz.
- The resolution bandwidth of test receiver/spectrum analyzer is 1 MHz and the video bandwidth is $\geq 1/T$ (Duty cycle $< 98\%$) or 10 Hz (Duty cycle $\geq 98\%$) for Average detection (AV) at frequency above 1 GHz.
- All modes of operation were investigated and the worst-case emissions are reported.

7 Test Results of Test Item

7.1 RF Output Power

Mode A

Input Power:	3.7Vdc	Environmental Conditions:	25°C, 76% RH	Tested By:	Dalen Dai
--------------	--------	---------------------------	--------------	------------	-----------

For Peak Power

BT-LE 1M

Chan.	Chan. Freq. (MHz)	Peak Power (mW)	Peak Power (dBm)	Power Limit (dBm)	Test Result
0	2402	1.059	0.25	30	Pass
19	2440	1.042	0.18	30	Pass
39	2480	1.183	0.73	30	Pass

Note: The antenna gain is 3.73 dBi < 6 dBi, so the output power limit shall not be reduced.

For Average Power

BT-LE 1M

Chan.	Chan. Freq. (MHz)	Average Power (mW)	Average Power (dBm)
0	2402	0.9397	-0.27
19	2440	0.9183	-0.37
39	2480	1.062	0.26

7.2 Power Spectral Density

Mode A

Input Power:	3.7Vdc	Environmental Conditions:	25°C, 76% RH	Tested By:	Dalen Dai
--------------	--------	---------------------------	--------------	------------	-----------

BT-LE 1M

Chan.	Chan. Freq. (MHz)	PSD (dBm/3kHz)	PSD Limit (dBm/3kHz)	Test Result
0	2402	-15.63	8.00	Pass
19	2440	-15.49	8.00	Pass
39	2480	-15.15	8.00	Pass

Note: The antenna gain is 3.73 dBi < 6 dBi, so the power density limit shall not be reduced.

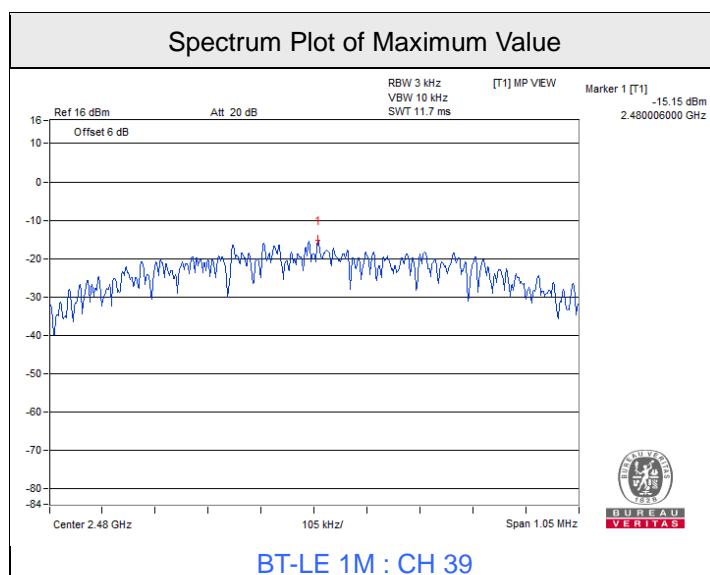

7.3 6 dB Bandwidth

Mode A

Input Power:	3.7Vdc	Environmental Conditions:	25°C, 76% RH	Tested By:	Dalen Dai
--------------	--------	---------------------------	--------------	------------	-----------

BT-LE 1M

Channel	Frequency (MHz)	6dB Bandwidth (MHz)	Minimum Limit (MHz)	Test Result
0	2402	0.7	0.5	Pass
19	2440	0.7	0.5	Pass
39	2480	0.7	0.5	Pass

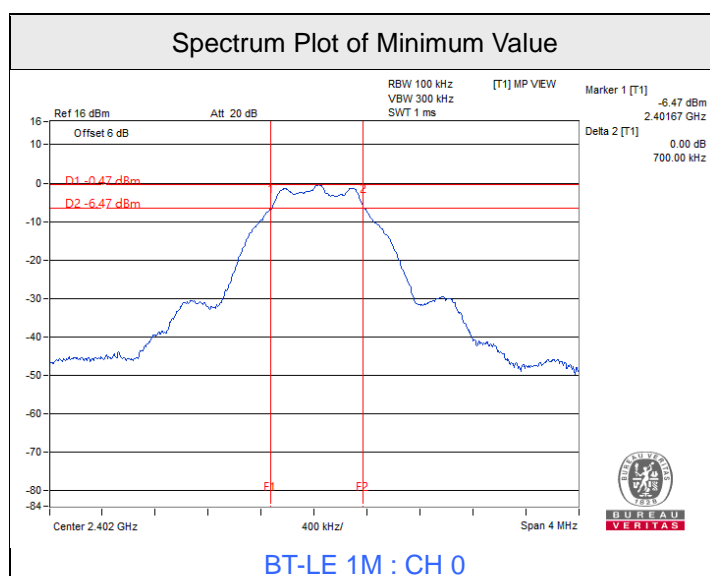

7.4 Conducted Out of Band Emissions

Mode A

Input Power:	3.7Vdc	Environmental Conditions:	25°C, 76% RH	Tested By:	Dalen Dai
--------------	--------	---------------------------	--------------	------------	-----------

BT-LE 1M

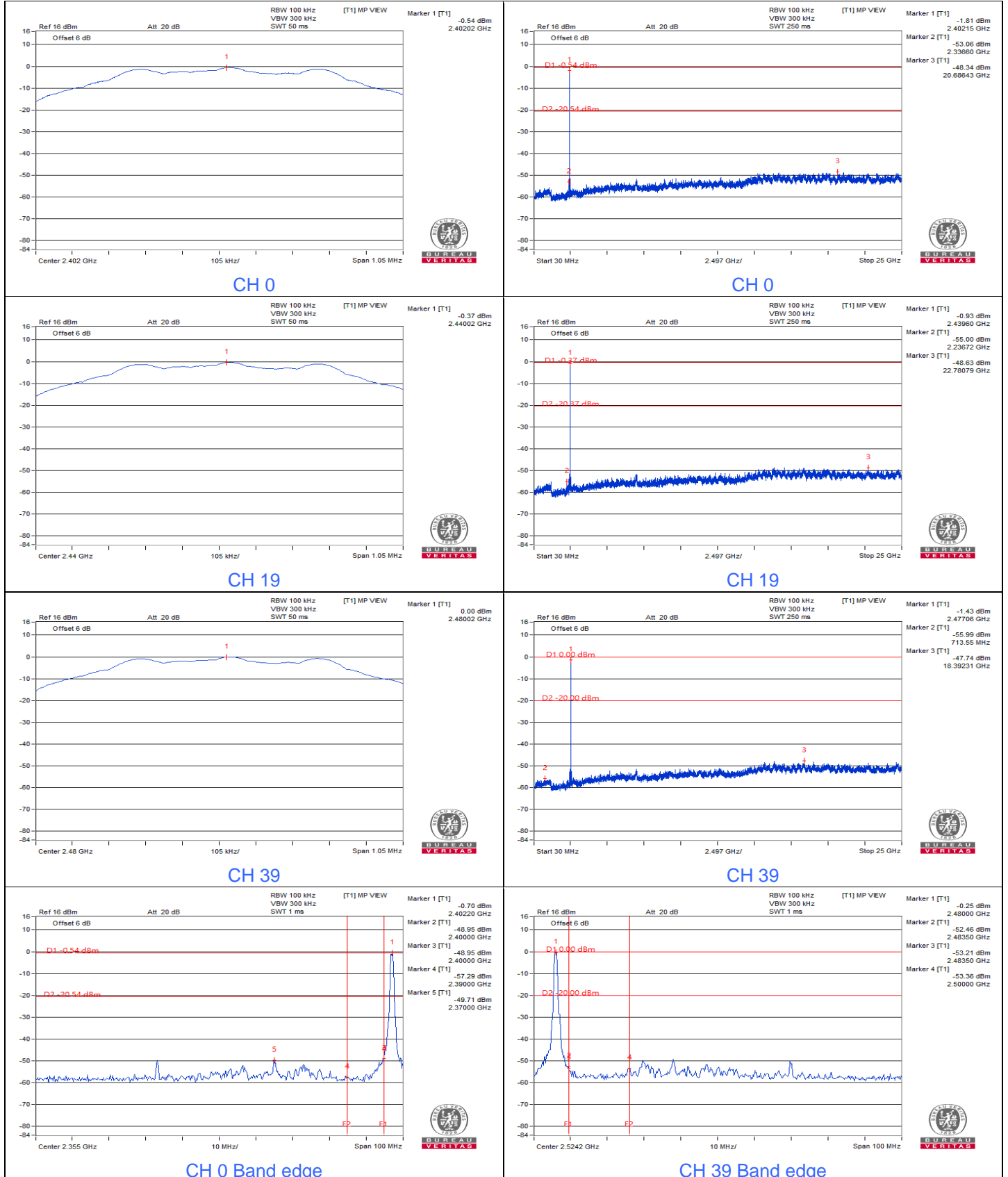

7.5 AC Power Conducted Emissions

Mode B

Frequency Range	150 kHz ~ 30 MHz	Detector Function & Resolution Bandwidth	Quasi-Peak (QP) / Average (AV), 9 kHz
Input Power	120 Vac, 60 Hz	Environmental Conditions	25°C, 75% RH
Tested By	Ian Chang		

Phase Of Power : Line (L)										
No	Frequency (MHz)	Correction Factor (dB)	Reading Value (dBuV)		Emission Level (dBuV)		Limit (dBuV)		Margin (dB)	
			Q.P.	AV.	Q.P.	AV.	Q.P.	AV.	Q.P.	AV.
1	0.15391	9.91	40.32	24.02	50.23	33.93	65.79	55.79	-15.56	-21.86
2	0.18516	9.91	35.31	20.00	45.22	29.91	64.25	54.25	-19.03	-24.34
3	0.44297	9.93	23.23	18.36	33.16	28.29	57.01	47.01	-23.85	-18.72
4	2.35156	10.04	12.13	2.76	22.17	12.80	56.00	46.00	-33.83	-33.20
5	3.74219	10.12	25.25	16.38	35.37	26.50	56.00	46.00	-20.63	-19.50
6	7.67969	10.28	25.50	18.82	35.78	29.10	60.00	50.00	-24.22	-20.90

Remarks:

1. Q.P. and AV. are abbreviations of quasi-peak and average individually.
2. The emission levels of other frequencies were very low against the limit.
3. Margin value = Emission level – Limit value
4. Correction factor = Insertion loss + Cable loss
5. Emission Level = Correction Factor + Reading Value

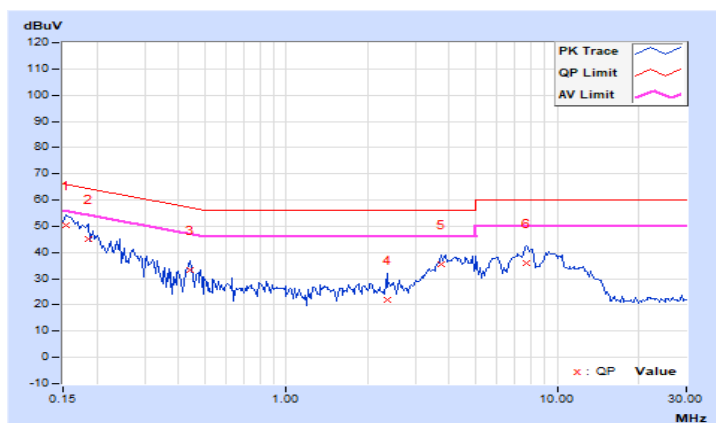

Frequency Range	150 kHz ~ 30 MHz	Detector Function & Resolution Bandwidth	Quasi-Peak (QP) / Average (AV), 9 kHz
Input Power	120 Vac, 60 Hz	Environmental Conditions	25°C, 75% RH
Tested By	Ian Chang		

Phase Of Power : Neutral (N)										
No	Frequency (MHz)	Correction Factor (dB)	Reading Value (dBuV)		Emission Level (dBuV)		Limit (dBuV)		Margin (dB)	
			Q.P.	AV.	Q.P.	AV.	Q.P.	AV.	Q.P.	AV.
1	0.15000	9.92	42.30	25.12	52.22	35.04	66.00	56.00	-13.78	-20.96
2	0.22422	9.93	30.85	15.69	40.78	25.62	62.66	52.66	-21.88	-27.04
3	0.36484	9.95	18.71	5.68	28.66	15.63	58.62	48.62	-29.96	-32.99
4	2.05859	10.05	13.31	5.73	23.36	15.78	56.00	46.00	-32.64	-30.22
5	3.80859	10.13	25.06	15.90	35.19	26.03	56.00	46.00	-20.81	-19.97
6	8.70313	10.33	26.01	20.08	36.34	30.41	60.00	50.00	-23.66	-19.59

Remarks:

1. Q.P. and AV. are abbreviations of quasi-peak and average individually.
2. The emission levels of other frequencies were very low against the limit.
3. Margin value = Emission level – Limit value
4. Correction factor = Insertion loss + Cable loss
5. Emission Level = Correction Factor + Reading Value

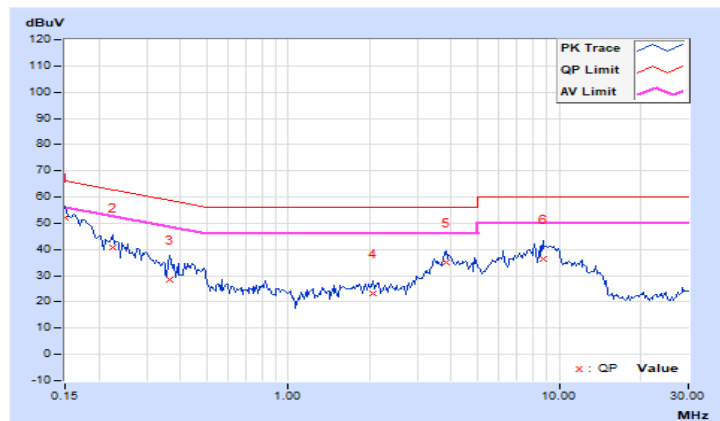

7.6 Unwanted Emissions below 1 GHz

Mode B

Frequency Range	9 kHz ~ 1 GHz	Detector Function & Bandwidth	(QP) RB = 120kHz
Input Power	120 Vac, 60 Hz	Environmental Conditions	23°C, 66% RH
Tested By	Ian Chang		

Antenna Polarity & Test Distance : Horizontal at 3 m								
No	Frequency (MHz)	Emission Level (dBUV/m)	Limit (dBUV/m)	Margin (dB)	Antenna Height (m)	Table Angle (Degree)	Raw Value (dBUV)	Correction Factor (dB/m)
1	43.58	27.14 QP	40.00	-12.86	1.83 H	165	34.27	-7.13
2	143.49	27.09 QP	43.50	-16.41	1.35 H	118	33.65	-6.56
3	180.35	25.74 QP	43.50	-17.76	2.48 H	228	33.24	-7.50
4	263.77	27.48 QP	46.00	-18.52	2.16 H	198	33.08	-5.60
5	359.80	30.71 QP	46.00	-15.29	2.90 H	270	33.78	-3.07
6	478.14	28.37 QP	46.00	-17.63	3.32 H	312	28.74	-0.37

Remarks:

1. Emission Level(dBUV/m) = Raw Value(dBUV) + Correction Factor(dB/m)
2. Correction Factor(dB/m) = Antenna Factor(dB/m) + Cable Factor(dB) – Pre-Amplifier Factor(dB)
3. Margin value = Emission Level – Limit value
4. The other emission levels were very low against the limit of frequency range 30 MHz ~ 1 GHz.
5. The emission levels were very low against the limit of frequency range 9 kHz ~ 30 MHz: the amplitude of spurious emissions attenuated more than 20 dB below the permissible value to be report.

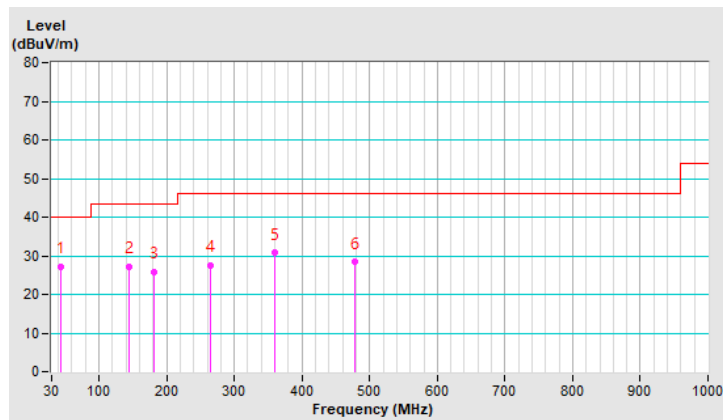

Frequency Range	9 kHz ~ 1 GHz	Detector Function & Bandwidth	(QP) RB = 120kHz
Input Power	120 Vac, 60 Hz	Environmental Conditions	23°C, 66% RH
Tested By	Ian Chang		

Antenna Polarity & Test Distance : Vertical at 3 m								
No	Frequency (MHz)	Emission Level (dBuV/m)	Limit (dBuV/m)	Margin (dB)	Antenna Height (m)	Table Angle (Degree)	Raw Value (dBuV)	Correction Factor (dB/m)
1	38.73	32.92 QP	40.00	-7.08	3.21 V	224	40.63	-7.71
2	54.25	32.76 QP	40.00	-7.24	3.44 V	246	39.77	-7.01
3	82.38	27.07 QP	40.00	-12.93	3.77 V	278	38.77	-11.70
4	263.77	26.32 QP	46.00	-19.68	3.99 V	307	31.92	-5.60
5	359.80	33.68 QP	46.00	-12.32	4.00 V	329	36.75	-3.07
6	455.83	30.38 QP	46.00	-15.62	4.00 V	360	31.08	-0.70

Remarks:

1. Emission Level(dBuV/m) = Raw Value(dBuV) + Correction Factor(dB/m)
2. Correction Factor(dB/m) = Antenna Factor(dB/m) + Cable Factor(dB) – Pre-Amplifier Factor(dB)
3. Margin value = Emission Level – Limit value
4. The other emission levels were very low against the limit of frequency range 30 MHz ~ 1 GHz.
5. The emission levels were very low against the limit of frequency range 9 kHz ~ 30 MHz: the amplitude of spurious emissions attenuated more than 20 dB below the permissible value to be report.

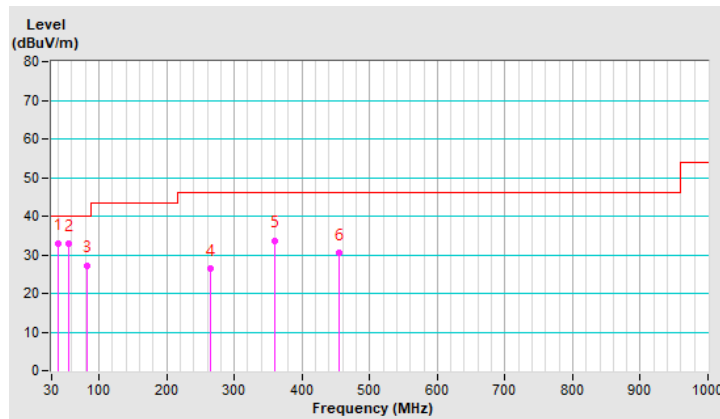

7.7 Unwanted Emissions above 1 GHz

Mode A

RF Mode	TX BT-LE 1M	Channel	CH 0 : 2402 MHz
Frequency Range	1 GHz ~ 25 GHz	Detector Function & Bandwidth	(PK) RB = 1 MHz, VB = 3 MHz (AV) RB = 1 MHz, VB = 3 kHz
Input Power	3.7Vdc	Environmental Conditions	22°C, 65% RH
Tested By	Ian Chang		

Antenna Polarity & Test Distance : Horizontal at 3 m

No	Frequency (MHz)	Emission Level (dBuV/m)	Limit (dBuV/m)	Margin (dB)	Antenna Height (m)	Table Angle (Degree)	Raw Value (dBuV)	Correction Factor (dB/m)
1	2390.00	53.3 PK	74.0	-20.7	1.31 H	108	55.6	-2.3
2	2390.00	45.4 AV	54.0	-8.6	1.31 H	108	47.7	-2.3
3	*2402.00	96.0 PK			1.31 H	108	98.3	-2.3
4	*2402.00	94.1 AV			1.31 H	108	96.4	-2.3
5	4804.00	46.8 PK	74.0	-27.2	1.59 H	203	41.3	5.5
6	4804.00	35.9 AV	54.0	-18.1	1.59 H	203	30.4	5.5
7	#7206.00	57.7 PK	74.0	-16.3	1.41 H	178	47.4	10.3
8	#7206.00	53.5 AV	54.0	-0.5	1.41 H	178	43.2	10.3

Remarks:

1. Emission Level(dBuV/m) = Raw Value(dBuV) + Correction Factor(dB/m)
2. Correction Factor(dB/m) = Antenna Factor(dB/m) + Cable Factor(dB) – Pre-Amplifier Factor(dB)
3. Margin value = Emission Level – Limit value
4. The other emission levels were very low against the limit.
5. " * " : Fundamental frequency.
6. " # " : The radiated frequency is out of the restricted band.

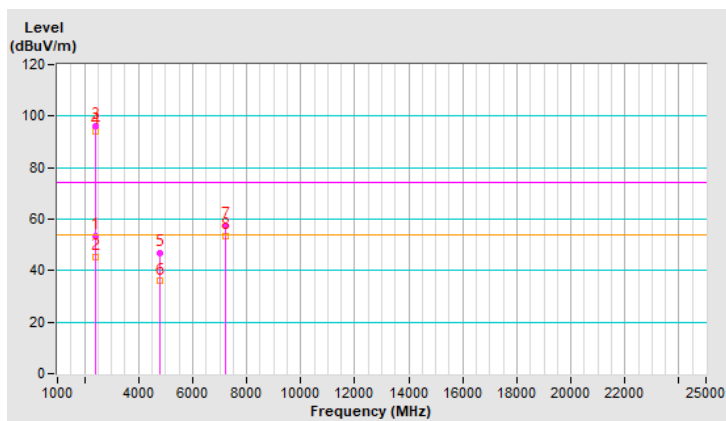

RF Mode	TX BT-LE 1M	Channel	CH 0 : 2402 MHz
Frequency Range	1 GHz ~ 25 GHz	Detector Function & Bandwidth	(PK) RB = 1 MHz, VB = 3 MHz (AV) RB = 1 MHz, VB = 3 kHz
Input Power	3.7Vdc	Environmental Conditions	22°C, 65% RH
Tested By	Ian Chang		

Antenna Polarity & Test Distance : Vertical at 3 m								
No	Frequency (MHz)	Emission Level (dBuV/m)	Limit (dBuV/m)	Margin (dB)	Antenna Height (m)	Table Angle (Degree)	Raw Value (dBuV)	Correction Factor (dB/m)
1	2390.00	51.0 PK	74.0	-23.0	1.59 V	336	53.3	-2.3
2	2390.00	43.0 AV	54.0	-11.0	1.59 V	336	45.3	-2.3
3	*2402.00	93.7 PK			1.58 V	336	96.0	-2.3
4	*2402.00	92.4 AV			1.58 V	336	94.7	-2.3
5	4804.00	45.7 PK	74.0	-28.3	3.66 V	261	40.2	5.5
6	4804.00	34.8 AV	54.0	-19.2	3.66 V	261	29.3	5.5
7	#7206.00	56.9 PK	74.0	-17.1	1.71 V	136	46.6	10.3
8	#7206.00	52.9 AV	54.0	-1.1	1.71 V	136	42.6	10.3

Remarks:

1. Emission Level(dBuV/m) = Raw Value(dBuV) + Correction Factor(dB/m)
2. Correction Factor(dB/m) = Antenna Factor(dB/m) + Cable Factor(dB) – Pre-Amplifier Factor(dB)
3. Margin value = Emission Level – Limit value
4. The other emission levels were very low against the limit.
5. " * ": Fundamental frequency.
6. " # ": The radiated frequency is out of the restricted band.

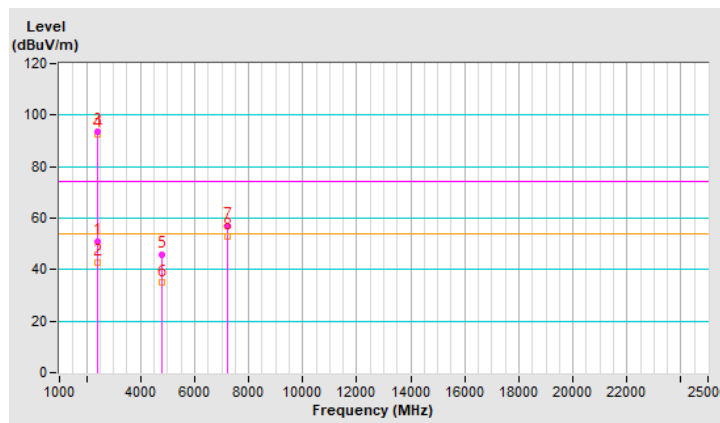

RF Mode	TX BT-LE 1M	Channel	CH 19 : 2440 MHz
Frequency Range	1 GHz ~ 25 GHz	Detector Function & Bandwidth	(PK) RB = 1 MHz, VB = 3 MHz (AV) RB = 1 MHz, VB = 3 kHz
Input Power	3.7Vdc	Environmental Conditions	22°C, 69% RH
Tested By	Ian Chang		

Antenna Polarity & Test Distance : Horizontal at 3 m

No	Frequency (MHz)	Emission Level (dBuV/m)	Limit (dBuV/m)	Margin (dB)	Antenna Height (m)	Table Angle (Degree)	Raw Value (dBuV)	Correction Factor (dB/m)
1	*2440.00	95.4 PK			1.44 H	163	97.6	-2.2
2	*2440.00	93.8 AV			1.44 H	163	96.0	-2.2
3	4880.00	47.0 PK	74.0	-27.0	1.64 H	214	41.4	5.6
4	4880.00	36.1 AV	54.0	-17.9	1.64 H	214	30.5	5.6
5	7320.00	58.1 PK	74.0	-15.9	1.39 H	188	46.9	11.2
6	7320.00	53.7 AV	54.0	-0.3	1.39 H	188	42.5	11.2

Remarks:

1. Emission Level(dBuV/m) = Raw Value(dBuV) + Correction Factor(dB/m)
2. Correction Factor(dB/m) = Antenna Factor(dB/m) + Cable Factor(dB) – Pre-Amplifier Factor(dB)
3. Margin value = Emission Level – Limit value
4. The other emission levels were very low against the limit.
5. " * " : Fundamental frequency.

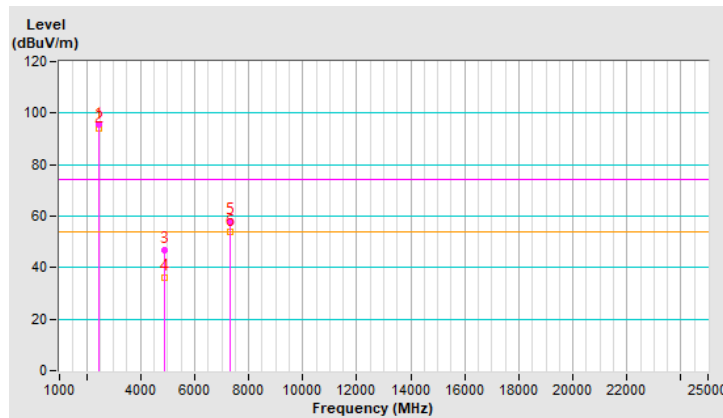

RF Mode	TX BT-LE 1M	Channel	CH 19 : 2440 MHz
Frequency Range	1 GHz ~ 25 GHz	Detector Function & Bandwidth	(PK) RB = 1 MHz, VB = 3 MHz (AV) RB = 1 MHz, VB = 3 kHz
Input Power	3.7Vdc	Environmental Conditions	22°C, 69% RH
Tested By	Ian Chang		

Antenna Polarity & Test Distance : Vertical at 3 m

No	Frequency (MHz)	Emission Level (dBuV/m)	Limit (dBuV/m)	Margin (dB)	Antenna Height (m)	Table Angle (Degree)	Raw Value (dBuV)	Correction Factor (dB/m)
1	*2440.00	93.6 PK			1.61 V	329	95.8	-2.2
2	*2440.00	91.9 AV			1.61 V	329	94.1	-2.2
3	4880.00	45.7 PK	74.0	-28.3	3.52 V	252	40.1	5.6
4	4880.00	34.9 AV	54.0	-19.1	3.52 V	252	29.3	5.6
5	7320.00	56.6 PK	74.0	-17.4	1.68 V	144	45.4	11.2
6	7320.00	53.1 AV	54.0	-0.9	1.68 V	144	41.9	11.2

Remarks:

1. Emission Level(dBuV/m) = Raw Value(dBuV) + Correction Factor(dB/m)
2. Correction Factor(dB/m) = Antenna Factor(dB/m) + Cable Factor(dB) – Pre-Amplifier Factor(dB)
3. Margin value = Emission Level – Limit value
4. The other emission levels were very low against the limit.
5. " * " : Fundamental frequency.

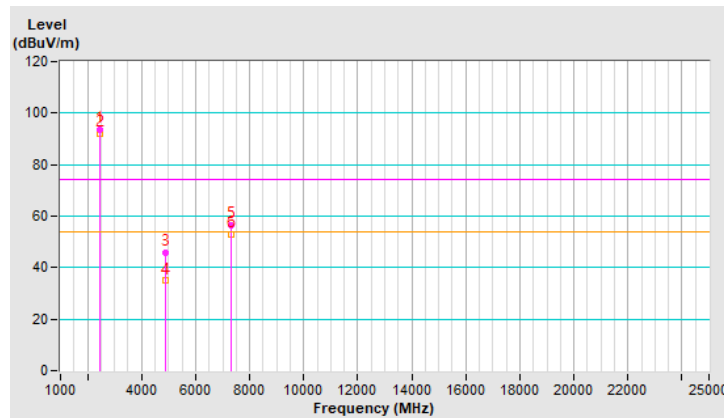

RF Mode	TX BT-LE 1M	Channel	CH 39 : 2480 MHz
Frequency Range	1 GHz ~ 25 GHz	Detector Function & Bandwidth	(PK) RB = 1 MHz, VB = 3 MHz (AV) RB = 1 MHz, VB = 3 kHz
Input Power	3.7Vdc	Environmental Conditions	22°C, 69% RH
Tested By	Ian Chang		

Antenna Polarity & Test Distance : Horizontal at 3 m								
No	Frequency (MHz)	Emission Level (dBuV/m)	Limit (dBuV/m)	Margin (dB)	Antenna Height (m)	Table Angle (Degree)	Raw Value (dBuV)	Correction Factor (dB/m)
1	*2480.00	95.6 PK			1.28 H	111	97.7	-2.1
2	*2480.00	94.2 AV			1.28 H	111	96.3	-2.1
3	2483.50	56.2 PK	74.0	-17.8	1.28 H	111	58.3	-2.1
4	2483.50	42.6 AV	54.0	-11.4	1.28 H	111	44.7	-2.1
5	4960.00	46.8 PK	74.0	-27.2	1.48 H	211	41.1	5.7
6	4960.00	35.9 AV	54.0	-18.1	1.48 H	211	30.2	5.7
7	7440.00	58.5 PK	74.0	-15.5	1.56 H	189	47.0	11.5
8	7440.00	53.7 AV	54.0	-0.3	1.56 H	189	42.2	11.5

Remarks:

1. Emission Level(dBuV/m) = Raw Value(dBuV) + Correction Factor(dB/m)
2. Correction Factor(dB/m) = Antenna Factor(dB/m) + Cable Factor(dB) – Pre-Amplifier Factor(dB)
3. Margin value = Emission Level – Limit value
4. The other emission levels were very low against the limit.
5. " * ": Fundamental frequency.

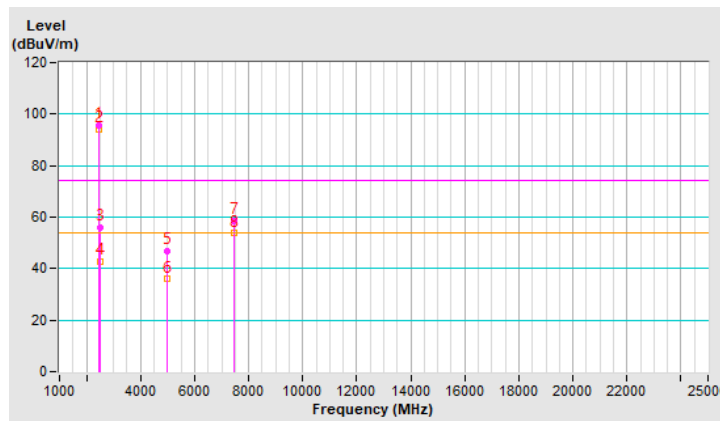

RF Mode	TX BT-LE 1M	Channel	CH 39 : 2480 MHz
Frequency Range	1 GHz ~ 25 GHz	Detector Function & Bandwidth	(PK) RB = 1 MHz, VB = 3 MHz (AV) RB = 1 MHz, VB = 3 kHz
Input Power	3.7Vdc	Environmental Conditions	22°C, 69% RH
Tested By	Ian Chang		

Antenna Polarity & Test Distance : Vertical at 3 m								
No	Frequency (MHz)	Emission Level (dBuV/m)	Limit (dBuV/m)	Margin (dB)	Antenna Height (m)	Table Angle (Degree)	Raw Value (dBuV)	Correction Factor (dB/m)
1	*2480.00	93.8 PK			1.63 V	345	95.9	-2.1
2	*2480.00	91.9 AV			1.63 V	345	94.0	-2.1
3	2483.50	54.0 PK	74.0	-20.0	1.63 V	345	56.1	-2.1
4	2483.50	40.1 AV	54.0	-13.9	1.63 V	345	42.2	-2.1
5	4960.00	45.9 PK	74.0	-28.1	3.55 V	242	40.2	5.7
6	4960.00	35.0 AV	54.0	-19.0	3.55 V	242	29.3	5.7
7	7440.00	57.5 PK	74.0	-16.5	1.64 V	152	46.0	11.5
8	7440.00	53.5 AV	54.0	-0.5	1.64 V	152	42.0	11.5

Remarks:

1. Emission Level(dBuV/m) = Raw Value(dBuV) + Correction Factor(dB/m)
2. Correction Factor(dB/m) = Antenna Factor(dB/m) + Cable Factor(dB) – Pre-Amplifier Factor(dB)
3. Margin value = Emission Level – Limit value
4. The other emission levels were very low against the limit.
5. " * ": Fundamental frequency.

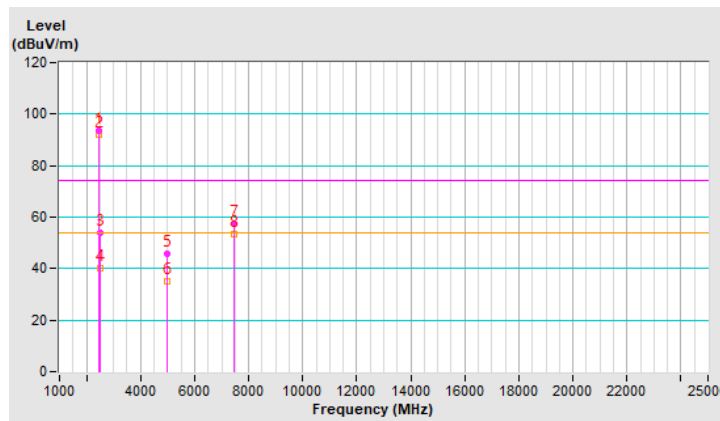

Mode A

Plot of Band Edge

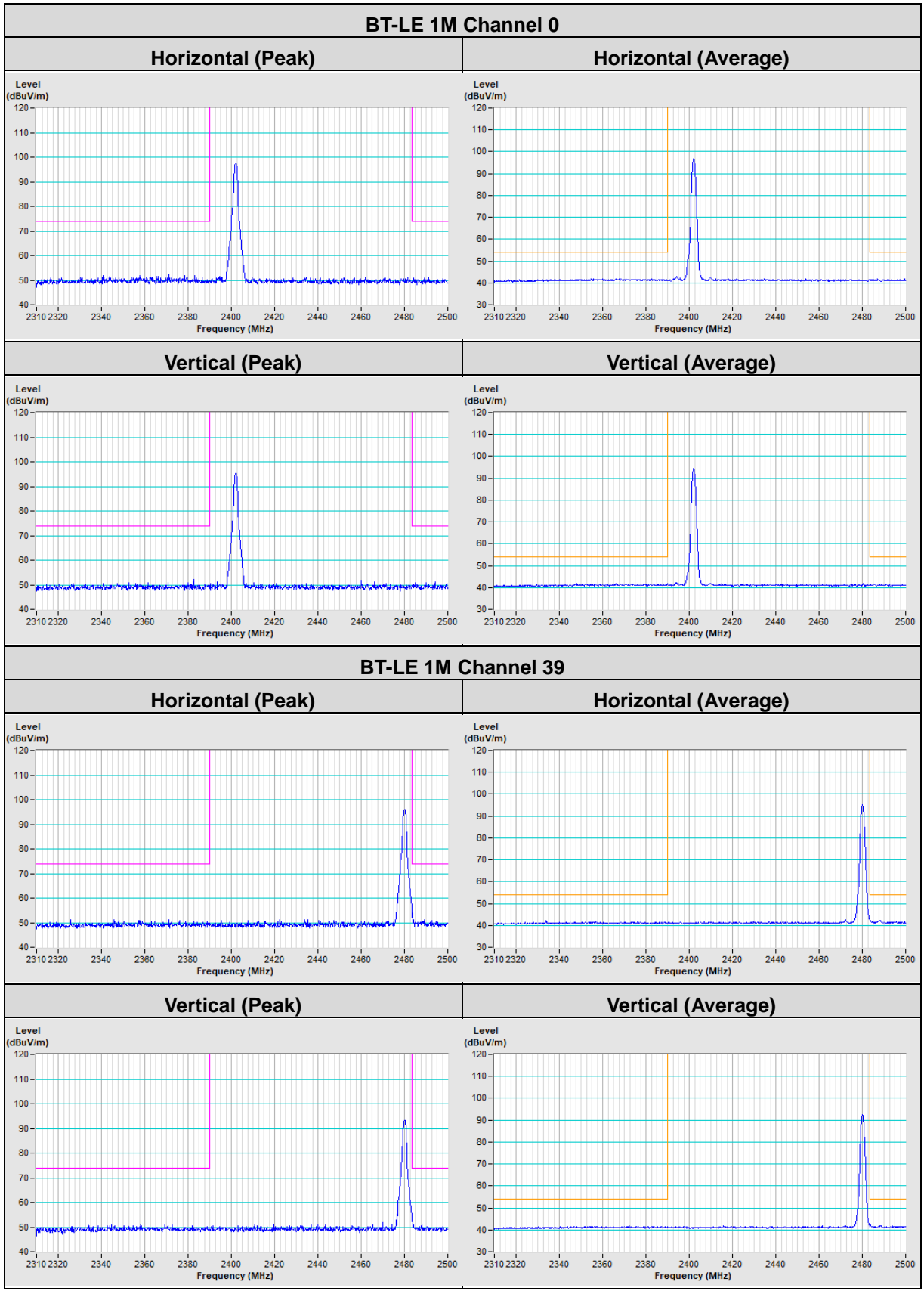

8 Pictures of Test Arrangements

Please refer to the attached file (Test Setup Photo).

9 Information of the Testing Laboratories

We, Bureau Veritas Consumer Products Services (H.K.) Ltd., Taoyuan Branch, were founded in 1988 to provide our best service in EMC, Radio, Telecom and Safety consultation. Our laboratories are FCC recognized accredited test firms and accredited according to ISO/IEC 17025.

If you have any comments, please feel free to contact us at the following:

Lin Kou EMC/RF Lab

Tel: 886-2-26052180

Fax: 886-2-26051924

Hsin Chu EMC/RF/Telecom Lab

Tel: 886-3-6668565

Fax: 886-3-6668323

Hwa Ya EMC/RF/Safety Lab

Tel: 886-3-3183232

Fax: 886-3-3270892

Email: service.adt@bureauveritas.com

Web Site: <http://ee.bureauveritas.com.tw>

The address and road map of all our labs can be found in our web site also.

--- END ---