

TEST REPORT

Report No.: BCTC2109384077E

Applicant: SHENZHEN ECARE ELECTRONICS CO., LTD

Product Name: Indoor/Outdoor humidity&Temperature Monitor

Model/Type Ref.: TX-6B

Tested Date: 2021-09-07 to 2021-10-29

Issued Date: 2021-10-29

Shenzhen BCTC Testing Co., Ltd.

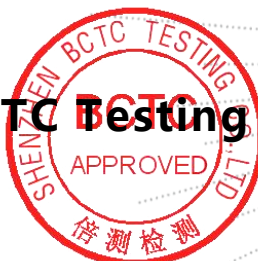

FCC ID: 2AATP-TX-6B

Product Name: Indoor/Outdoor humidity&Temperature Monitor
Trademark: N/A
TX-6B
Model/Type Ref.: TP260B, B60B, TP260BW, TP280B, B80B, TP280BW, TP360B, C60B, TP360BW, TP394B, C94B, TP394BW
Prepared For: SHENZHEN ECARE ELECTRONICS CO., LTD
Address: 5-6/F., Block B, Huali Industrial Building District 28, BaoAn, Shenzhen, Guang Dong, China. P.C: 518133
Manufacturer: SHENZHEN ECARE ELECTRONICS CO., LTD
Address: 5-6/F., Block B, Huali Industrial Building District 28, BaoAn, Shenzhen, Guang Dong, China. P.C: 518133
Prepared By: Shenzhen BCTC Testing Co., Ltd.
Address: 1-2/F., Building SB, Pengzhou Industrial Park, No.158, Fuyuan 1st Road, Tangwei, Fuhai Subdistrict, Bao'an District, Shenzhen, Guangdong, China
Sample Received Date: 2021-09-07
Sample tested Date: 2021-09-07 to 2021-10-29
Issue Date: 2021-10-29
Report No.: BCTC2109384077E
Test Standards: FCC Part15.249
ANSI C63.10-2013
Test Results: PASS

Tested by:



Lei Chen/Project Handler

Approved by:



Zero Zhou/Reviewer

The test report is effective only with both signature and specialized stamp. This result(s) shown in this report refer only to the sample(s) tested. Without written approval of Shenzhen BCTC Testing Co., Ltd, this report can't be reproduced except in full. The tested sample(s) and the sample information are provided by the client.

Table Of Content

	Page
Test Report Declaration	
1. Version	5
2. Test Summary	6
3. Measurement Uncertainty	7
4. Product Information And Test Setup	8
4.1 Product Information	8
4.2 Test Setup Configuration	8
4.3 Support Equipment	9
4.4 Channel List	9
4.5 Test Mode	9
5. Test Facility And Test Instrument Used	10
5.1 Test Facility	10
5.2 Test Instrument Used	10
6. Conducted Emissions	12
6.1 Block Diagram Of Test Setup	12
6.2 Limit	12
6.3 Test Procedure	12
6.4 EUT Operating Conditions	12
6.5 Test Result	13
7. Radiated Emissions	15
7.1 Block Diagram Of Test Setup	15
7.2 Limit	16
7.3 Test Procedure	17
7.4 EUT Operating Conditions	18
7.5 Test Result	19
7.6 Field Strength Calculation	23
8. Band Edge Emission	24
8.1 Block Diagram Of Test Setup	24
8.2 Applicable Standard	24
8.3 Test Procedure	24
8.4 EUT Operating Conditions	24
8.5 Test Result	25
9. 20 DB Bandwidth	27
9.1 Block Diagram Of Test Setup	27
9.2 Limit	27
9.3 Test Procedure	27
9.4 EUT Operation Conditions	27
9.5 Test Result	28
10. Antenna Requirement	29

10.1	Limit	29
10.2	Test Result	29
11.	EUT Photographs	30
12.	EUT Test Setup Photographs	31

(Note: N/A Means Not Applicable)

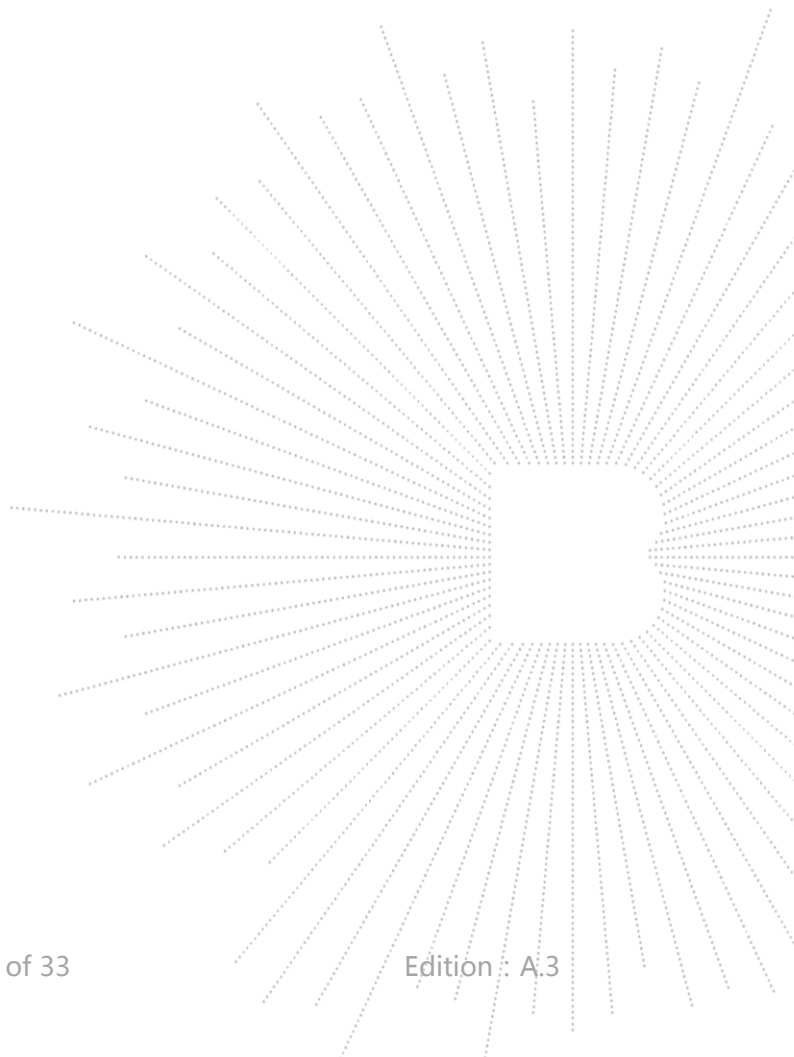

1. Version

Report No.	Issue Date	Description	Approved
BCTC2109384077E	2021-10-29	Original	Valid

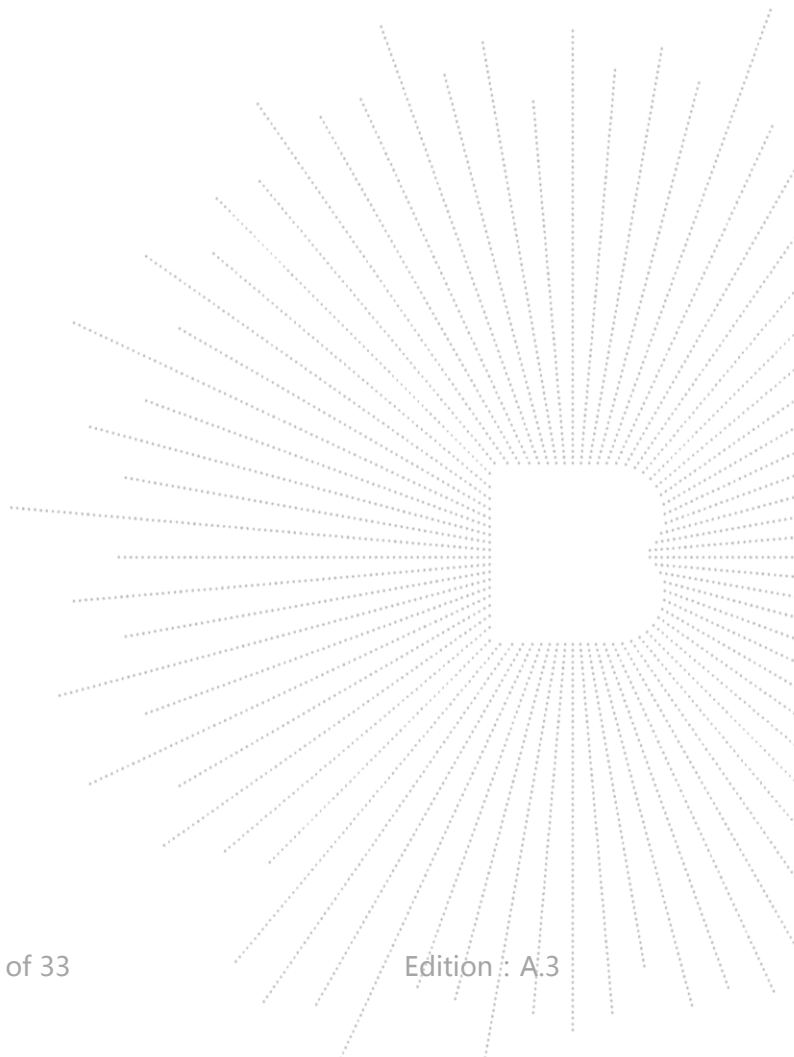

2. Test Summary

The Product has been tested according to the following specifications:

No.	Test Parameter	Clause No	Results
1	Conducted Emission	15.207	N/A
2	20dB Bandwidth	15.215	PASS
3	Fundamental & Radiated Spurious Emission Measurement	15.249	PASS
4	Band Edge Emission	15.205	PASS
5	Antenna Requirement	15.203	PASS

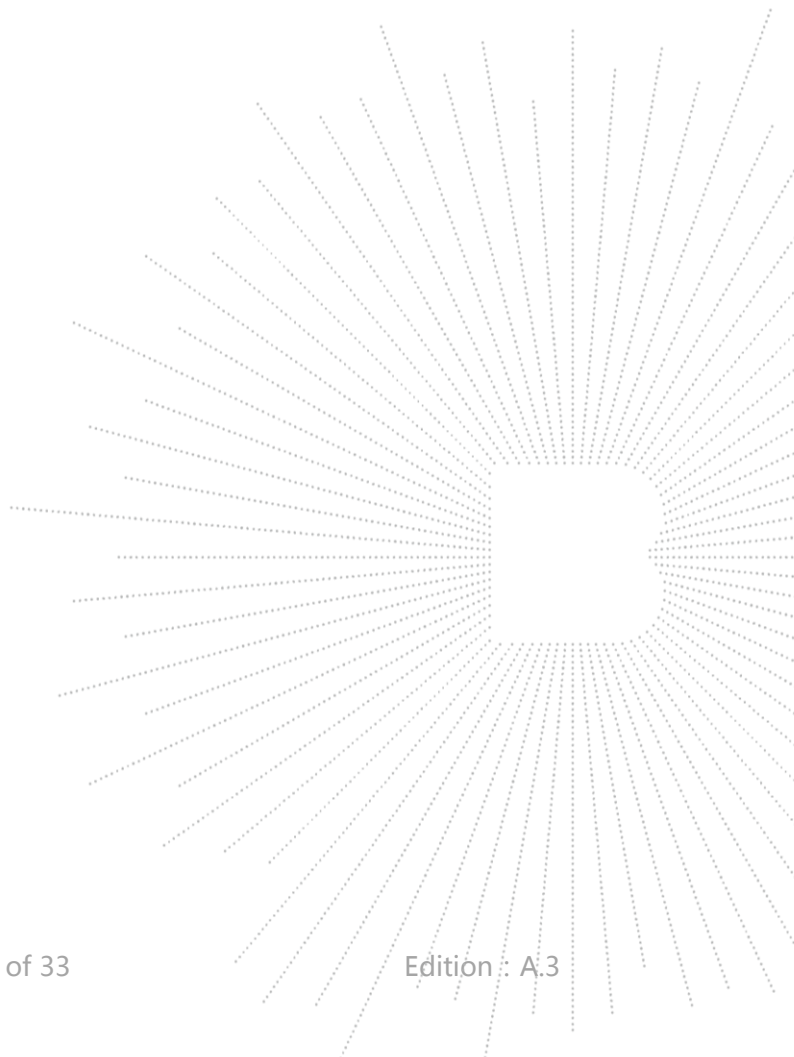

3. Measurement Uncertainty

Where relevant, the following measurement uncertainty levels have been estimated for tests performed on the Product as specified in CISPR 16-4-2. This uncertainty represents an expanded uncertainty expressed at approximately the 95% confidence level using a coverage factor of k=2.

No.	Item	Uncertainty
1	3m chamber Radiated spurious emission(9kHz-30MHz)	U=3.7dB
2	3m chamber Radiated spurious emission(30MHz-1GHz)	U=4.3dB
3	3m chamber Radiated spurious emission(1GHz-18GHz)	U=4.5dB
4	3m chamber Radiated spurious emission(18GHz-40GHz)	U=3.34dB
5	Conducted Emission(150kHz-30MHz)	U=3.20dB
6	Conducted Adjacent channel power	U=1.38dB
7	Conducted output power uncertainty Above 1G	U=1.576dB
8	Conducted output power uncertainty below 1G	U=1.28dB
9	humidity uncertainty	U=5.3%
10	Temperature uncertainty	U=0.59°C

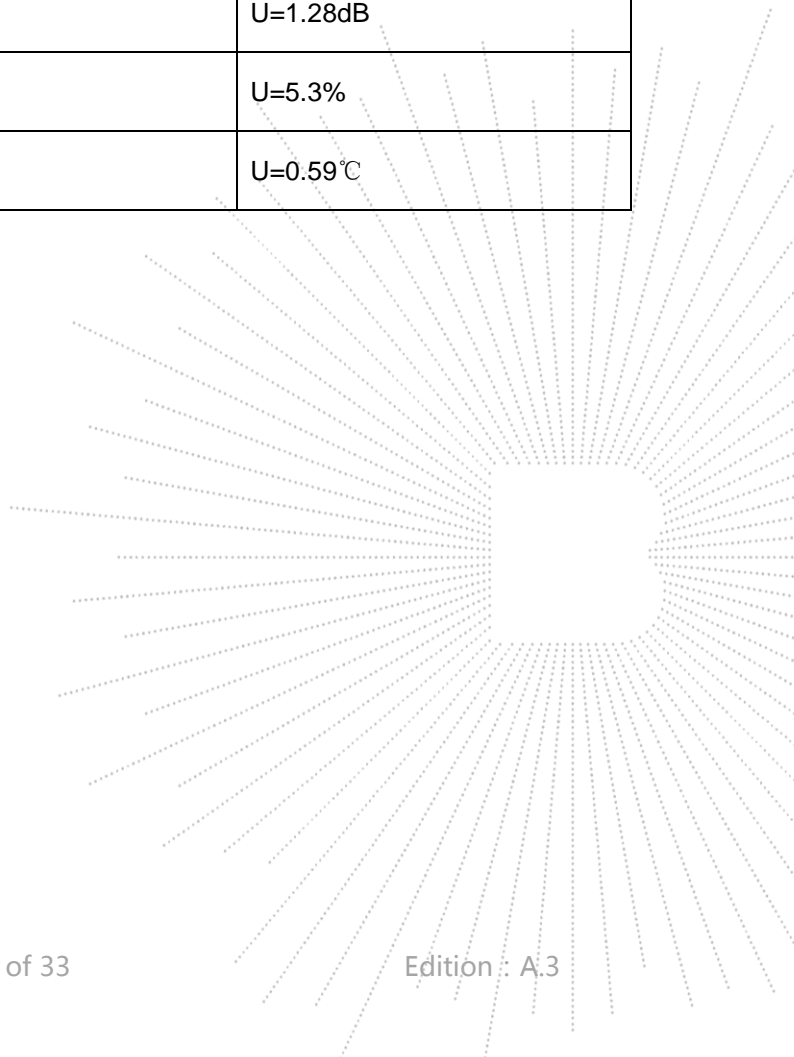

4. Product Information And Test Setup

4.1 Product Information

Model/Type Ref.:	TX-6B TP260B, B60B, TP260BW, TP280B, B80B, TP280BW, TP360B, C60B, TP360BW, TP394B, C94B, TP394BW
Model differences:	All the model are the same circuit and RF module, except model names and color.
Hardware Version:	N/A
Software Version:	N/A
Operation Frequency:	915MHz
Type of Modulation:	FSK
Number Of Channel	1CH
Antenna installation:	Spring antenna
Antenna Gain:	0dBi
Ratings:	DC 3.7V from battery, DC 5V from USB

4.2 Test Setup Configuration

See test photographs attached in *EUT TEST SETUP PHOTOGRAPHS* for the actual connections between Product and support equipment.

Conducted Emission:

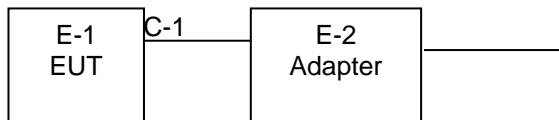

Radiated Spurious Emission

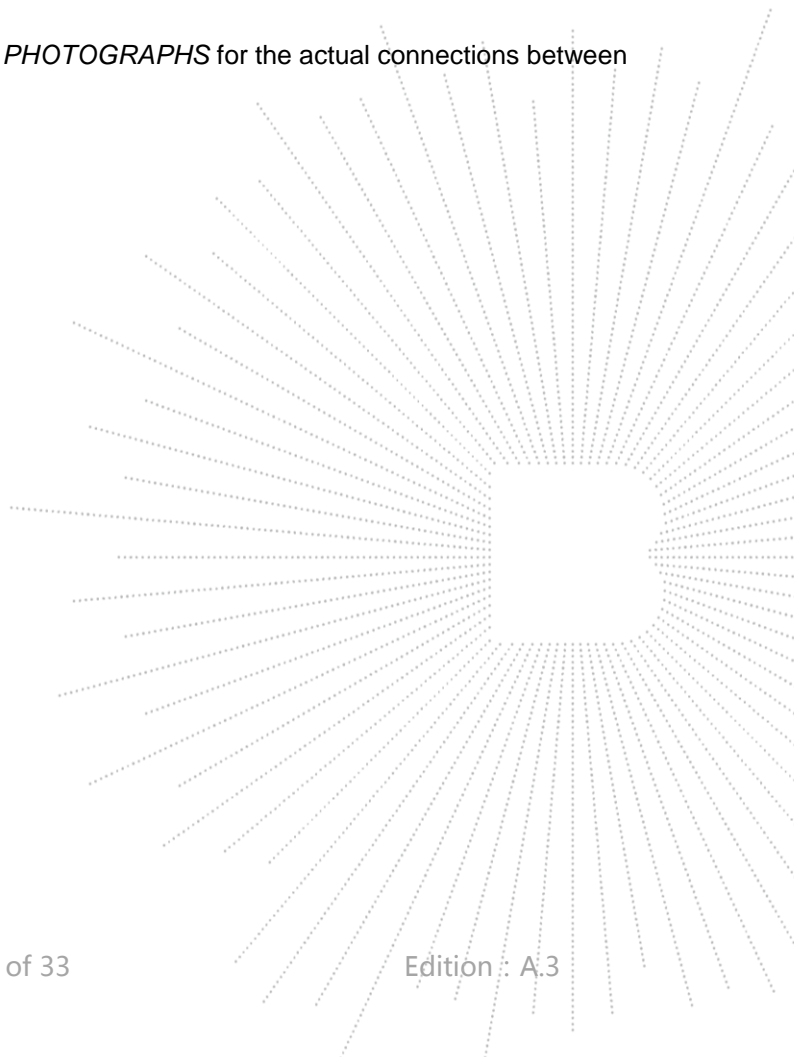
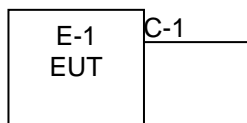

4.3 Support Equipment

No.	Device Type	Brand	Model	Series No.	Note
E-1	Indoor/Outdoor humidity&Temperature Monitor	N/A	TX-6B	N/A	EUT
E-2	Adapter	N/A	BCTC001	N/A	Auxiliary

Item	Shielded Type	Ferrite Core	Length	Note
C-1	NO	NO	0.5M	USB cable unshielded

Notes:

1. All the equipment/cables were placed in the worst-case configuration to maximize the emission during the test.
2. Grounding was established in accordance with the manufacturer's requirements and conditions for the intended use.

4.4 Channel List

CH	Frequency (MHz)
1	915

4.5 Test Mode

To investigate the maximum EMI emission characteristics generated from EUT, the test system was pre-scanning tested based on the consideration of following EUT operation mode or test configuration mode which possibly have effect on EMI emission level. Each of these EUT operation mode(s) or test configuration mode(s) mentioned above was evaluated respectively.

Test Mode	Test mode
1	Transmitting

Note:

- (1) The measurements are performed at the highest, middle, lowest available channels.
- (2) Fully-charged battery is used during the test

5. Test Facility And Test Instrument Used

5.1 Test Facility

All measurement facilities used to collect the measurement data are located at Shenzhen BCTC Testing Co., Ltd. Address: 1-2/F., Building B, Pengzhou Industrial Park, No.158, Fuyuan 1st Road, Tangwei, Fuhai Subdistrict, Bao'an District, Shenzhen, Guangdong, China. The site and apparatus are constructed in conformance with the requirements of ANSI C63.4 and CISPR 16-1-1 other equivalent standards.

FCC Test Firm Registration Number: 712850

IC Registered No.: 23583

5.2 Test Instrument Used

Conducted emissions Test					
Equipment	Manufacturer	Model#	Serial#	Last Cal.	Next Cal.
Receiver	R&S	ESR3	102075	May 28, 2021	May 27, 2022
LISN	R&S	ENV216	101375	May 28, 2021	May 27, 2022
ISN	HPX	ISN T800	S1509001	May 28, 2021	May 27, 2022
Software	Frad	EZ-EMC	EMC-CON 3A1	\	\

Radiated emissions Test (966 chamber)					
Equipment	Manufacturer	Model#	Serial#	Last Cal.	Next Cal.
966 chamber	ChengYu	966 Room	966	Jun. 06. 2020	Jun. 05, 2023
Receiver	R&S	ESR3	102075	May 28, 2021	May 27, 2022
Receiver	R&S	ESRP	101154	May 28, 2021	May 27, 2022
Amplifier	SKET	LAPA_01G18 G-45dB	\	May 28, 2021	May 27, 2022
Amplifier	Schwarzbeck	BBV9744	9744-0037	May 28, 2021	May 27, 2022
TRILOG Broadband Antenna	schwarzbeck	VULB 9163	VULB9163-9 42	Jun. 01, 2021	May 31, 2022
Horn Antenna	SCHWARZBECK	BBHA9120D	1541	Jun. 02, 2021	Jun. 01, 2022
Horn Antenna (18GHz-40GHz)	SCHWARZBECK	BBHA9170	822	Jun. 15, 2021	Jun. 14, 2022
Amplifier (18GHz-40GHz)	MITEQ	TTA1840-35- HG	2034381	May 28, 2021	May 27, 2022
Loop Antenna (9kHz-30MHz)	SCHWARZBECK	FMZB1519B	014	Jun. 02, 2021	Jun. 01, 2022
RF cables1 (9kHz-30MHz)	Huber+Suhnar	9kHz-30MHz	B1702988-00 08	May 28, 2021	May 27, 2022
RF cables2 (30MHz-1GHz)	Huber+Suhnar	30MHz-1GHz	1486150	May 28, 2021	May 27, 2022
RF cables3 (1GHz-40GHz)	Huber+Suhnar	1GHz-40GHz	1607106	May 28, 2021	May 27, 2022
Power Metter	Keysight	E4419B	\	May 28, 2021	May 27, 2022
Power Sensor (AV)	Keysight	E9 300A	\	May 28, 2021	May 27, 2022
Signal Analyzer 20kHz-26.5GHz	KEYSIGHT	N9020A	MY49100060	May 28, 2021	May 27, 2022
Spectrum Analyzer 9kHz-40GHz	R&S	FSP40	100363	May 28, 2021	May 27, 2022
Software	Frad	EZ-EMC	FA-03A2 RE	\	\

6. Conducted Emissions

6.1 Block Diagram Of Test Setup

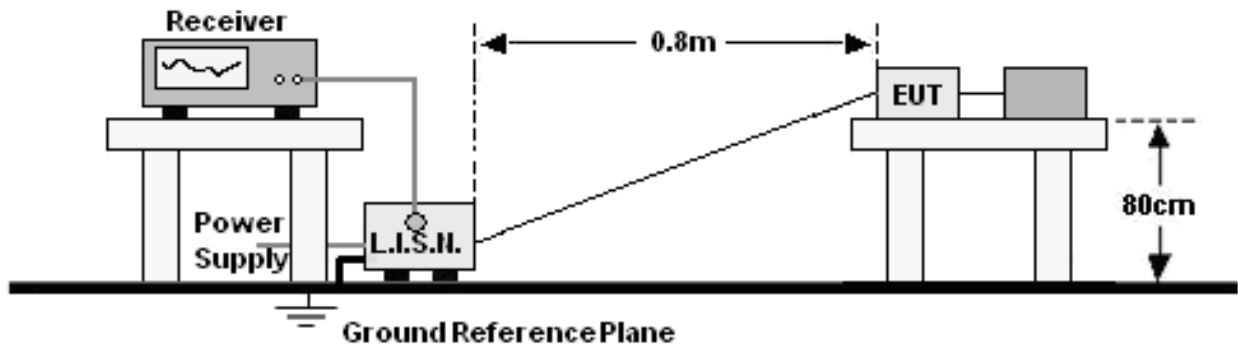

6.2 Limit

FREQUENCY (MHz)	Limit (dBuV)	
	Quas-peak	Average
0.15 -0.5	66 - 56 *	56 - 46 *
0.50 -5.0	56.00	46.00
5.0 -30.0	60.00	50.00

Notes:

- *Decreasing linearly with logarithm of frequency.
- The lower limit shall apply at the transition frequencies.

6.3 Test Procedure

Receiver Parameters	Setting
Attenuation	10 dB
Start Frequency	0.15 MHz
Stop Frequency	30 MHz
IF Bandwidth	9 kHz

a. The Product was placed on a nonconductive table 0.8 m above the horizontal ground reference plane, and 0.4 m from the vertical ground reference plane, and connected to the main through Line Impedance Stability Network (L.I.S.N).

b. The RBW of the receiver was set at 9 kHz in 150 kHz ~ 30MHz with Peak and AVG detector in Max Hold mode. Run the receiver's pre-scan to record the maximum disturbance generated from Product in all power lines in the full band.

c. For each frequency whose maximum record was higher or close to limit, measure its QP and AVG values and record.

6.4 EUT Operating Conditions

The EUT was configured for testing in a typical fashion (as a customer would normally use it). The EUT has been programmed to continuously transmit during test. This operating condition was tested and used to collect the included data.

6.5 Test Result

Temperature:	26 °C	Relative Humidity:	54%
Pressure:	101kPa	Phase :	Line
Test Voltage :	AC 120V/60Hz	Test Mode:	Mode 1

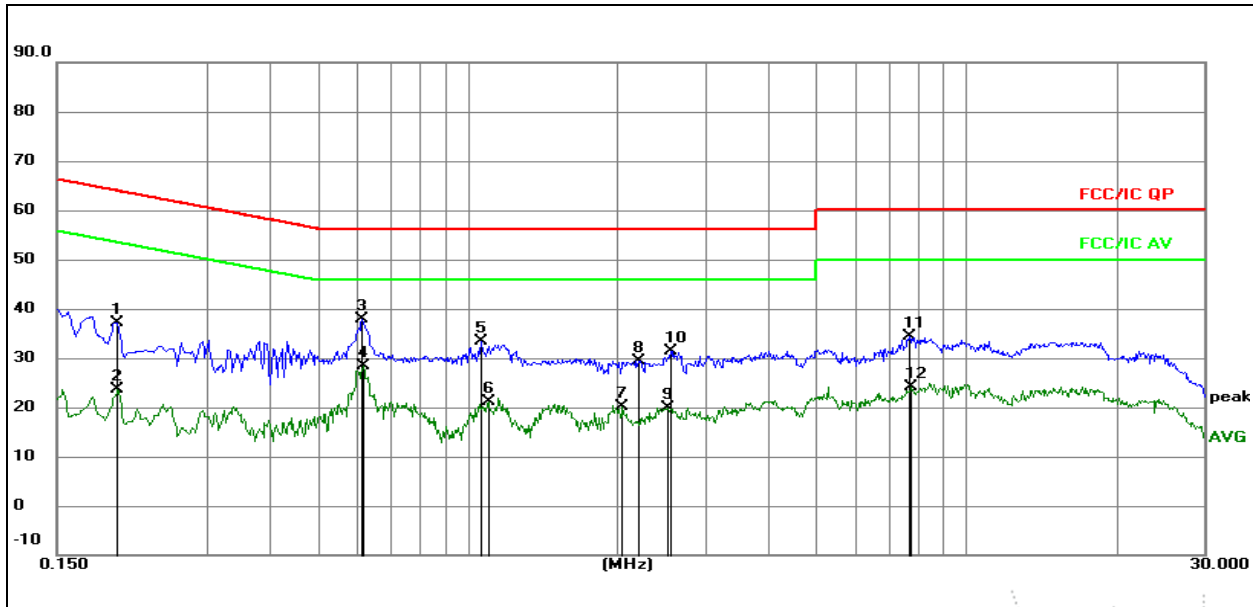

Remark:

1. All readings are Quasi-Peak and Average values.
2. Factor = Insertion Loss + Cable Loss.

No.	Mk.	Freq. MHz	Reading Level	Correct Factor dB	Measure- ment dBuV	Limit dBuV	Over dB	Detector
1		0.1986	27.53	9.61	37.14	63.67	-26.53	QP
2		0.1986	14.05	9.61	23.66	53.67	-30.01	AVG
3		0.6139	28.21	9.62	37.83	56.00	-18.17	QP
4	*	0.6172	18.71	9.62	28.33	46.00	-17.67	AVG
5		1.0653	23.65	9.63	33.28	56.00	-22.72	QP
6		1.0997	11.53	9.63	21.16	46.00	-24.84	AVG
7		2.0440	10.51	9.63	20.14	46.00	-25.86	AVG
8		2.2014	19.75	9.64	29.39	56.00	-26.61	QP
9		2.5266	10.32	9.64	19.96	46.00	-26.04	AVG
10		2.5535	21.76	9.64	31.40	56.00	-24.60	QP
11		7.6869	24.66	9.75	34.41	60.00	-25.59	QP
12		7.7688	14.25	9.76	24.01	50.00	-25.99	AVG

Temperature:	26 °C	Relative Humidity:	54%
Pressure:	101kPa	Phase :	Neutral
Test Voltage :	AC 120V/60Hz	Test Mode:	Mode 1

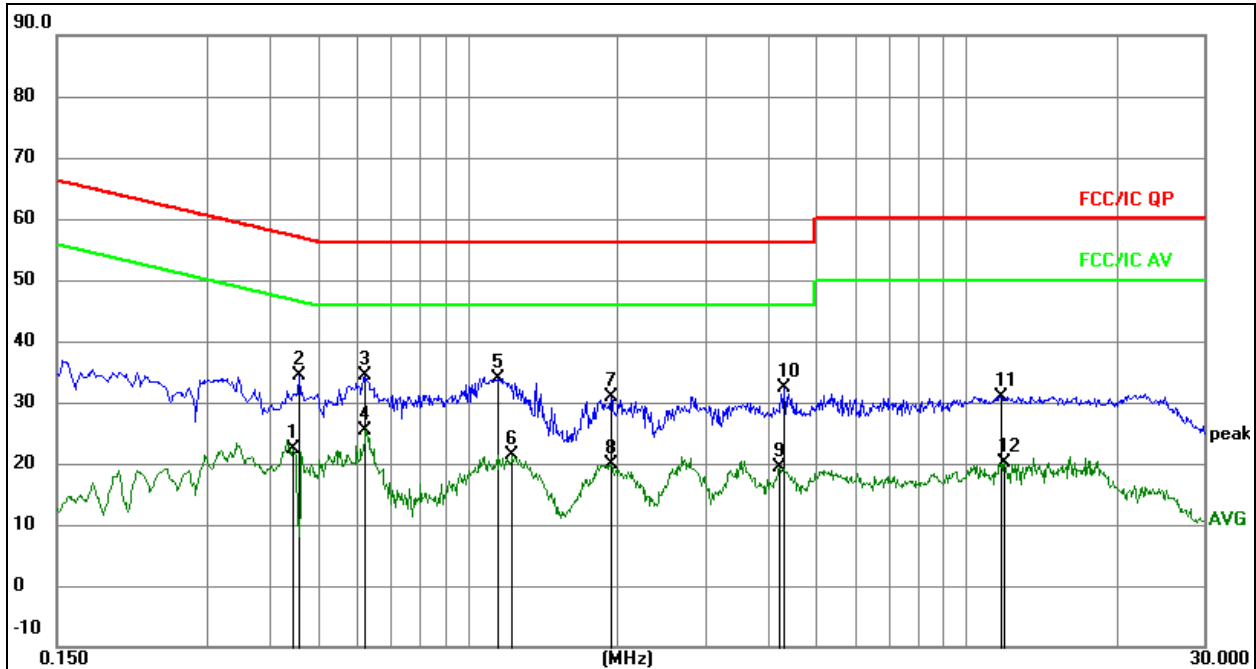
Remark:

1. All readings are Quasi-Peak and Average values.
2. Factor = Insertion Loss + Cable Loss.

No.	Mk.	Freq. MHz	Reading Level	Correct Factor dB	Measure- ment dBuV	Limit dBuV	Over dB	Detector
1		0.4466	12.82	9.62	22.44	46.94	-24.50	AVG
2		0.4586	24.82	9.62	34.44	56.72	-22.28	QP
3		0.6238	24.83	9.62	34.45	56.00	-21.55	QP
4	*	0.6238	15.73	9.62	25.35	46.00	-20.65	AVG
5		1.1533	24.36	9.63	33.99	56.00	-22.01	QP
6		1.2291	11.85	9.63	21.48	46.00	-24.52	AVG
7		1.9386	21.36	9.63	30.99	56.00	-25.01	QP
8		1.9386	10.18	9.63	19.81	46.00	-26.19	AVG
9		4.2240	9.73	9.69	19.42	46.00	-26.58	AVG
10		4.3146	22.60	9.69	32.29	56.00	-23.71	QP
11		11.7446	21.13	9.79	30.92	60.00	-29.08	QP
12		11.9327	10.30	9.79	20.09	50.00	-29.91	AVG

7. Radiated Emissions

7.1 Block Diagram Of Test Setup

(A) Radiated Emission Test-Up Frequency Below 30MHz

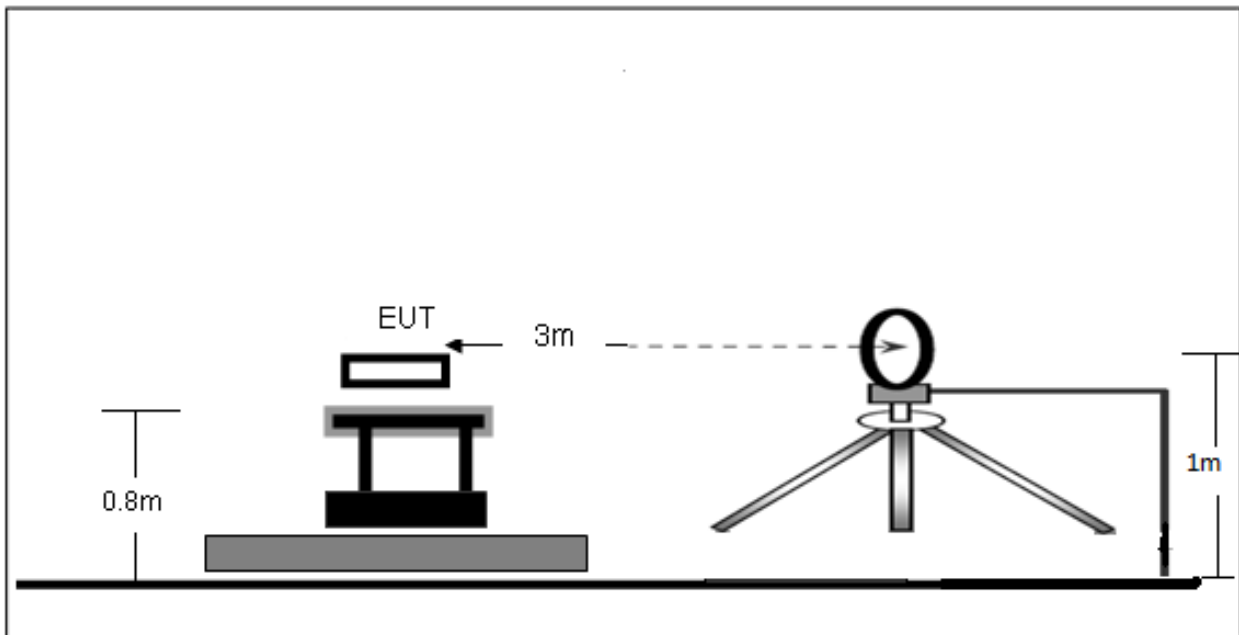

(B) Radiated Emission Test-Up Frequency 30MHz~1GHz

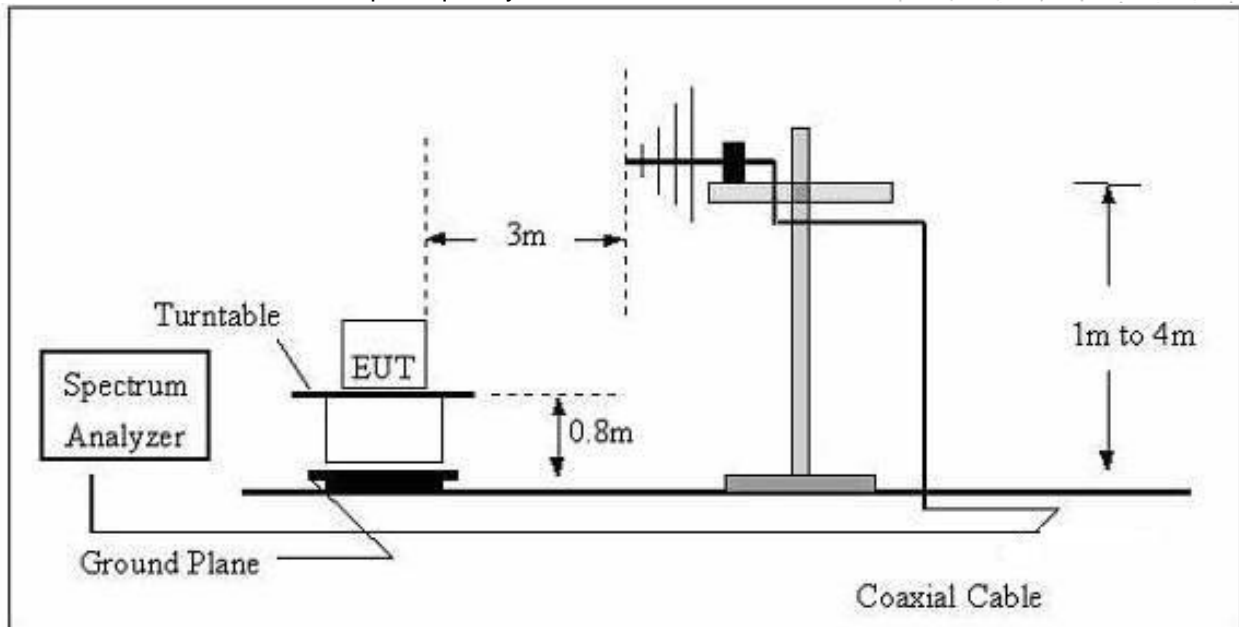

(C) Radiated Emission Test-Up Frequency Above 1GHz

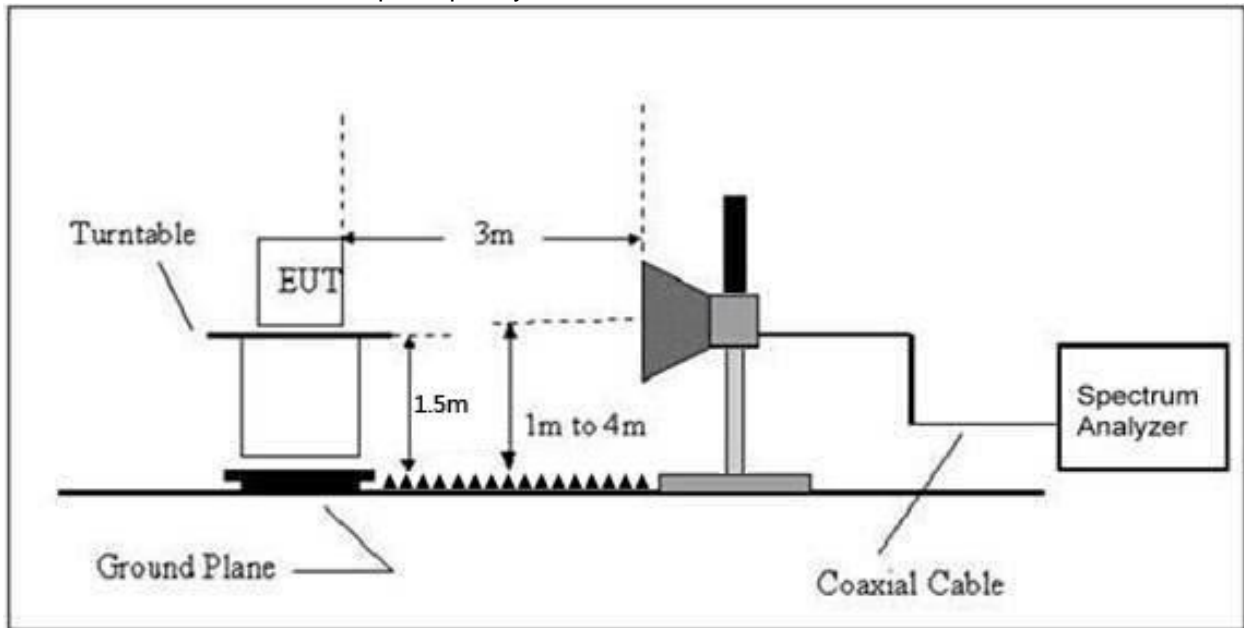

7.2 Limit

20dBc in any 100 kHz bandwidth outside the operating frequency band. In case the emission fall within the restricted band specified on 15.205(a), then the 15.209(a) limit in the table below has to be followed.

Frequency (MHz)	Field Strength uV/m	Distance (m)	Field Strength Limit at 3m Distance	
			uV/m	dBuV/m
0.009 ~ 0.490	2400/F(kHz)	300	10000 * 2400/F(kHz)	20log ^{(2400/F(kHz))} + 80
0.490 ~ 1.705	24000/F(kHz)	30	100 * 24000/F(kHz)	20log ^{(24000/F(kHz))} + 40
1.705 ~ 30	30	30	100 * 30	20log ⁽³⁰⁾ + 40
30 ~ 88	100	3	100	20log ⁽¹⁰⁰⁾
88 ~ 216	150	3	150	20log ⁽¹⁵⁰⁾
216 ~ 960	200	3	200	20log ⁽²⁰⁰⁾
Above 960	500	3	500	20log ⁽⁵⁰⁰⁾

The field strength of emissions from intentional radiators operated within these frequency bands shall comply with the following:

Fundamental frequency	Field strength of fundamental (millivolts/meter)	Field strength of harmonics (microvolts/meter)
902-928 MHz	50	500
2400-2483.5 MHz	50	500
5725-5875 MHz	50	500
24.0-24.25 GHz	250	2500

LIMITS OF RADIATED EMISSION MEASUREMENT (Above 1000MHz)

FREQUENCY (MHz)	Limit (dBuV/m) (at 3M)	
	PEAK	AVERAGE
Above 1000	74	54

Notes:

- (1) The limit for radiated test was performed according to FCC PART 15C.
- (2) The tighter limit applies at the band edges.
- (3) Emission level (dBuV/m)=20log Emission level (uV/m).

FREQUENCY RANGE OF RADIATED MEASUREMENT (For unintentional radiators)

Highest frequency generated or Upper frequency of measurement used in the device or on which the device operates or tunes (MHz)	Range (MHz)
Below 1.705	30
1.705 – 108	1000
108 – 500	2000
500 – 1000	5000
Above 1000	5 th harmonic of the highest frequency or 40 GHz, whichever is lower

7.3 Test Procedure

Spectrum Parameter	Setting
Attenuation	Auto
Start Frequency	1000 MHz
Stop Frequency	10th carrier harmonic
RB / VB (emission in restricted band)	1 MHz / 1 MHz for Peak, 1 MHz / 10Hz for Average

Receiver Parameter	Setting
Attenuation	Auto
Start ~ Stop Frequency	9kHz~150kHz / RB 200Hz for QP
Start ~ Stop Frequency	150kHz~30MHz / RB 9kHz for QP
Start ~ Stop Frequency	30MHz~1000MHz / RB 120kHz for QP

Below 1GHz test procedure as below:

- a. The EUT was placed on the top of a rotating table 0.8 meters above the ground at a 3 meter semi-anechoic chamber. The table was rotated 360 degrees to determine the position of the highest radiation.
- b. The EUT was set 3 meters away from the interference-receiving antenna, which was mounted on the top of a variable-height antenna tower.
- c. The antenna height is varied from one meter to four meters above the ground to determine the maximum value of the field strength. Both horizontal and vertical polarizations of the antenna are set to make the measurement.

d. For each suspected emission, the EUT was arranged to its worst case and then the antenna was tuned to heights from 1 meter to 4 meters (for the test frequency of below 30MHz, the antenna was tuned to heights 1 meter) and the rotatable table was turned from 0 degrees to 360 degrees to find the maximum reading.

e. The test-receiver system was set to Peak Detect Function and Specified Bandwidth with Maximum Hold Mode.

f. If the emission level of the EUT in peak mode was 10dB lower than the limit specified, then testing could be stopped and the peak values of the EUT would be reported. Otherwise the emissions that did not have 10dB margin would be re-tested one by one using peak, quasi-peak or average method as specified and then reported in a data sheet.

Above 1GHz test procedure as below:

g. Different between above is the test site, change from Semi- Anechoic Chamber to fully Anechoic Chamber and change form table 0.8 metre to 1.5 metre(Above 18GHz the distance is 1 meter and table is 1.5 metre).

h. Test the EUT in the lowest channel ,the middle channel ,the Highest channel.

Note:

Both horizontal and vertical antenna polarities were tested and performed pretest to three orthogonal axis. The worst case emissions were reported.

Above 1GHz test procedure as below:

a.The EUT was placed on the top of a rotating table 1.5 meters above the ground at a 3 meter camber. The table was rotated 360 degrees to determine the position of the highest radiation.

b.The EUT was set 3 meters away from the interference-receiving antenna, which was mounted on the top of a variable-height antenna tower.

c.The antenna height is varied from one meter to four meters above the ground to determine the maximum value of the field strength. Both horizontal and vertical polarizations of the antenna are set to make the measurement.

d.For each suspected emission, the EUT was arranged to its worst case and then the antenna was tuned to heights from 1 meter to 4 meters and the rota table was turned from 0 degrees to 360 degrees to find the maximum reading.

e.The test-receiver system was set to Peak Detect Function and Specified Bandwidth with Maximum Hold Mode.

f. If the emission level of the EUT in peak mode was 10dB lower than the limit specified, then testing could be stopped and the peak values of the EUT would be reported. Otherwise the emissions that did not have 10dB margin would be re-tested one by one using peak, quasi-peak or average method as specified and then reported in a data sheet.

g.Test the EUT in the lowest channel,the Highest channel.

Note:

Both horizontal and vertical antenna polarities were tested and performed pretest to three orthogonal axis. The worst case emissions were reported.

7.4 EUT Operating Conditions

The EUT was configured for testing in a typical fashion (as a customer would normally use it). The EUT has been programmed to continuously transmit during test. This operating condition was tested and used to collect the included data.

7.5 Test Result

Below 30MHz

Temperature:	26°C	Relative Humidity:	24%
Pressure:	101 kPa	Test Voltage :	DC 3.7V
Test Mode :	Mode 1	Polarization :	--

Freq. (MHz)	Reading (dBuV/m)	Limit (dBuV/m)	Margin (dB)	State P/F
--	--	--	--	PASS
--	--	--	--	PASS

Note:

The amplitude of spurious emissions which are attenuated by more than 20dB below the permissible value has no need to be reported.

Distance extrapolation factor = $40 \log(\text{specific distance/test distance})$ (dB);

Limit line = specific limits(dBuV) + distance extrapolation factor.

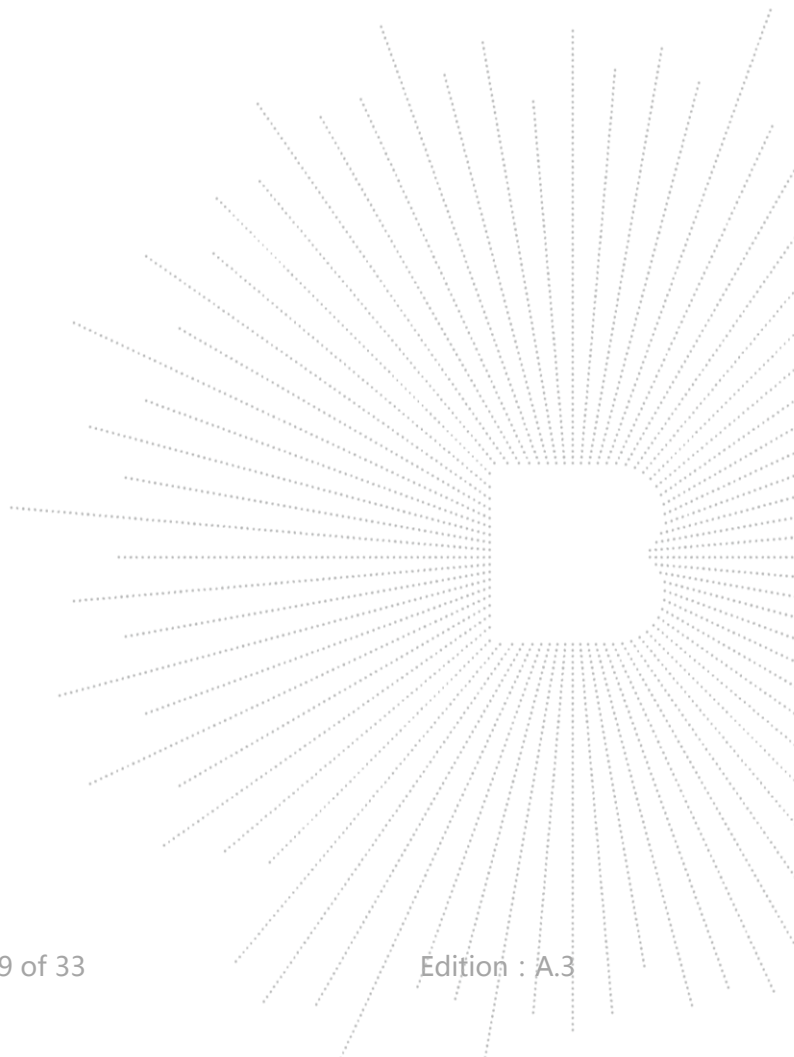

Between 30MHz – 1GHz

Temperature:	26 °C	Relative Humidity:	54%
Pressure:	101KPa	Phase :	Horizontal
Test Mode:	Mode 1	Remark:	N/A

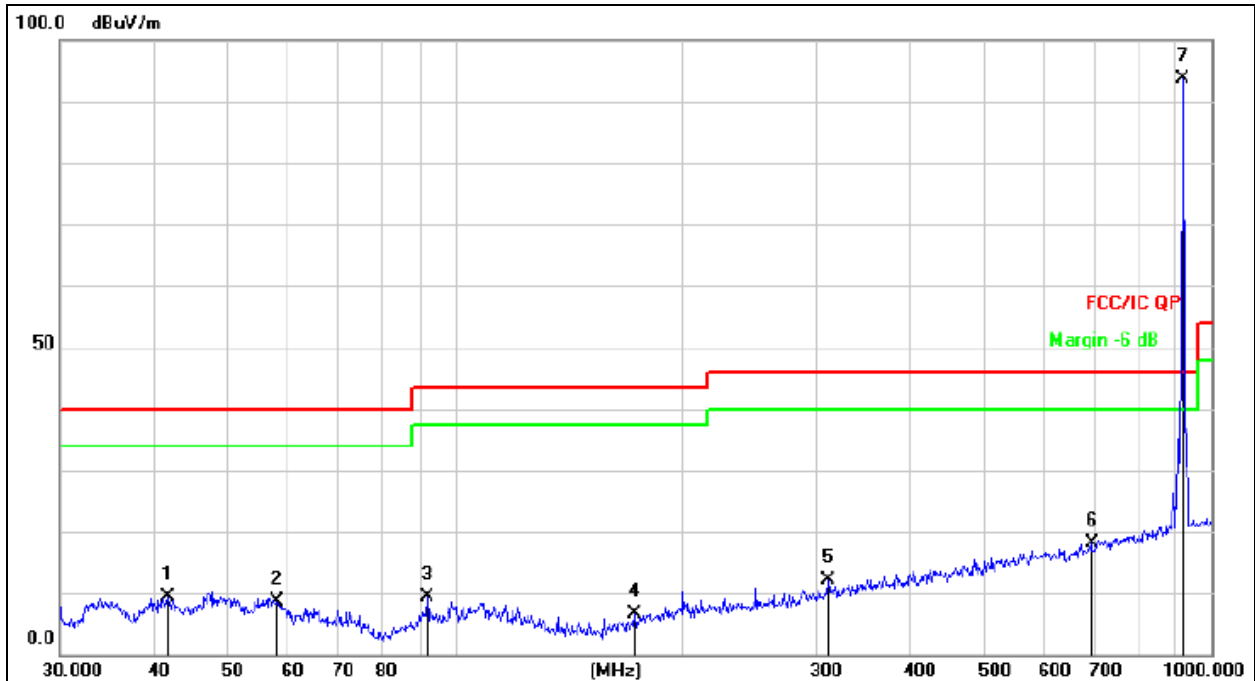

Remark:

Factor = Antenna Factor + Cable Loss – Pre-amplifier.

No. Mk.	Freq. MHz	Reading Level dBuV	Correct Factor dB	Measure- ment dBuV/m	Limit dB/m	Over dB	Detector
1	41.7129	24.67	-15.31	9.36	40.00	-30.64	QP
2	58.2030	24.47	-15.72	8.75	40.00	-31.25	QP
3	91.8163	27.07	-17.77	9.30	43.50	-34.20	QP
4	172.5988	24.62	-18.05	6.57	43.50	-36.93	QP
5	311.0867	25.34	-13.30	12.04	46.00	-33.96	QP
6	694.4174	23.55	-5.33	18.22	46.00	-27.78	QP
7 *	916.0687	94.93	-1.37	93.56	114.00	-20.44	peak

Temperature:	26 °C	Relative Humidity:	54%
Pressure:	101KPa	Phase :	Vertical
Test Mode:	Mode 1	Remark:	N/A

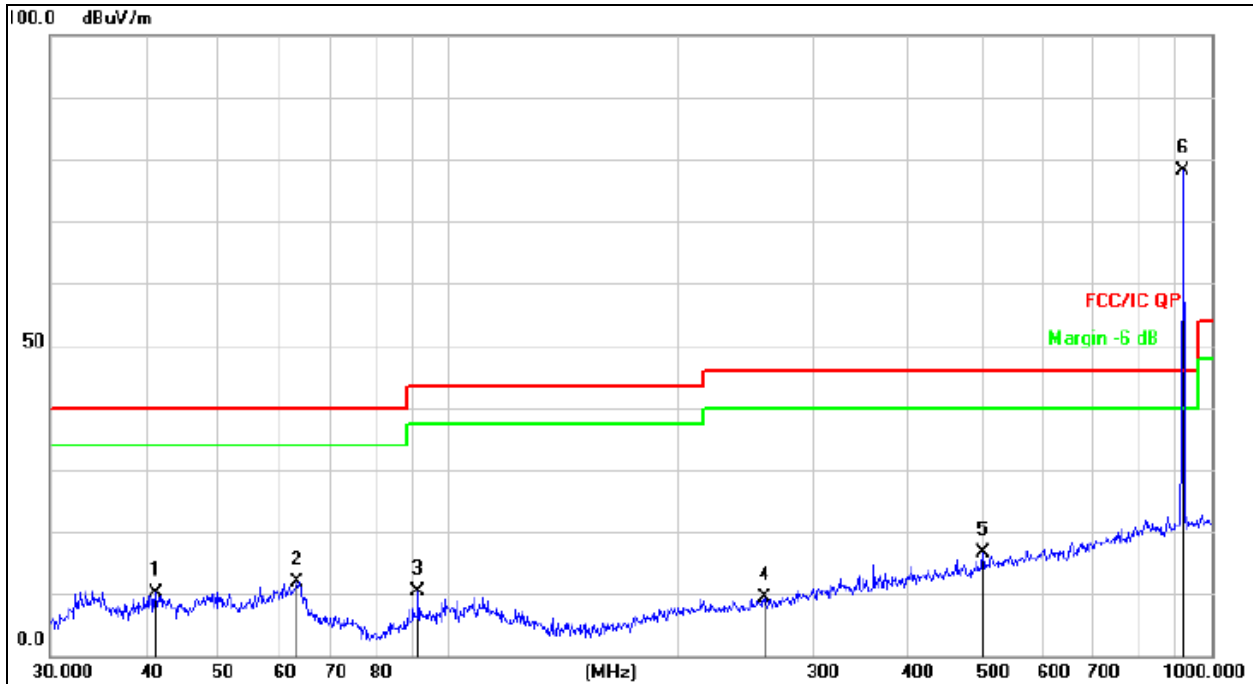

Remark:
Factor = Antenna Factor + Cable Loss – Pre-amplifier.

No.	Mk.	Freq. MHz	Reading Level dBuV	Correct Factor dB	Measure- ment dBuV/m	Limit dB/m	Over dB	Detector
1		41.2765	25.43	-15.34	10.09	40.00	-29.91	QP
2		63.0916	28.50	-16.61	11.89	40.00	-28.11	QP
3		91.1746	28.32	-17.89	10.43	43.50	-33.07	QP
4		259.2338	24.22	-14.86	9.36	46.00	-36.64	QP
5		501.1790	25.44	-8.91	16.53	46.00	-29.47	QP
6	*	916.0687	79.51	-1.37	78.14	114.00	-35.86	peak

(Above 1000 MHz)
Normal Voltage 915MHz

Polar (H/V)	Frequency	Meter Reading	Factor	Emission Level	Limits	Margin	Detector Type
	(MHz)	(dBuV)	(dB)	(dBuV/m)	(dBuV/m)	(dB)	
V	1830.00	52.86	1.25	54.11	74.00	-19.89	PK
V	1830.00	42.26	1.25	43.51	54.00	-10.49	AV
V	2745.00	42.59	1.59	44.18	74.00	-29.82	PK
V	2745.00	42.14	1.59	43.73	54.00	-10.27	AV
V	3660.00	50.42	2.36	52.78	74.00	-21.22	PK
V	3660.00	47.21	2.36	49.57	54.00	-4.43	AV
H	1830.00	50.38	1.25	51.63	74.00	-22.37	PK
H	1830.00	39.71	1.25	40.96	54.00	-13.04	AV
H	2745.00	40.46	1.59	42.05	74.00	-31.95	PK
H	2745.00	42.71	1.59	44.30	54.00	-9.70	AV
H	3660.00	48.55	2.36	50.91	74.00	-23.09	PK
H	3660.00	46.26	2.36	48.62	54.00	-5.38	AV

Remark:
 Absolute Level= ReadingLevel+ Factor, Margin= Limit- Absolute Level
 Other harmonics emissions are lower than 20dB below the allowable limit.

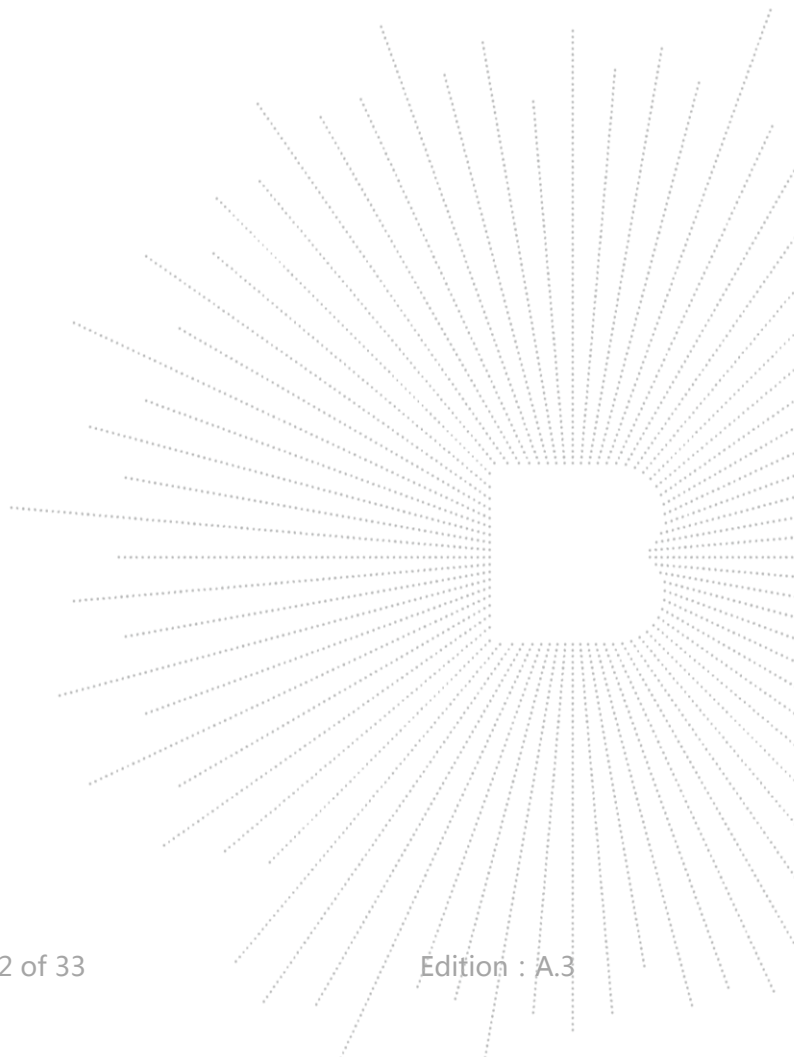

7.6 Field Strength Calculation

The field strength is calculated by adding the Antenna Factor and Cable Factor and subtracting the Amplifier Gain and Duty Cycle Correction Factor (if any) from the measured reading. The basic equation with a sample calculation is as follows:

$$FS=RA+AF+CL-AG$$

FS=Field Strength	CL=Cable Attenuation Factor (Cable Loss)
RA=Reading Amplitude	AG=Amplifier Gain
AF=Antenna Factor	

Test Result:

Temperature:	26°C	Relative Humidity:	54%
Pressure:	101kPa	Polarization :	Horizontal
Test Voltage :	DC 3.7V		
Test Mode :	Mode 1		

Frequency (MHz)	Meter Reading (dBμV)	Factor (dB)	Emission Level (dBμV/m)	Limits (dBμV/m)	Margin (dB)	Detector Type
915.00	94.93	-1.37	93.56	114.00	-20.44	Peak
915.00	88.57	-1.37	87.2	94.00	-6.80	Average

Remark:
Factor = Antenna Factor + Cable Loss – Pre-amplifier.
All interfaces was connected, and TX mode

Temperature:	26°C	Relative Humidity:	54%
Pressure:	101kPa	Polarization :	Vertical
Test Voltage :	DC 3.7V		
Test Mode :	Mode 1		

Frequency (MHz)	Meter Reading (dBμV)	Factor (dB)	Emission Level (dBμV/m)	Limits (dBμV/m)	Margin (dB)	Detector Type
915.00	79.51	-1.37	78.14	114.00	-35.86	Peak
915.00	73.24	-1.37	71.87	94.00	-22.13	Average

Remark:
Factor = Antenna Factor + Cable Loss – Pre-amplifier.
All interfaces was connected, and TX mode

8. Band Edge Emission

8.1 Block Diagram Of Test Setup

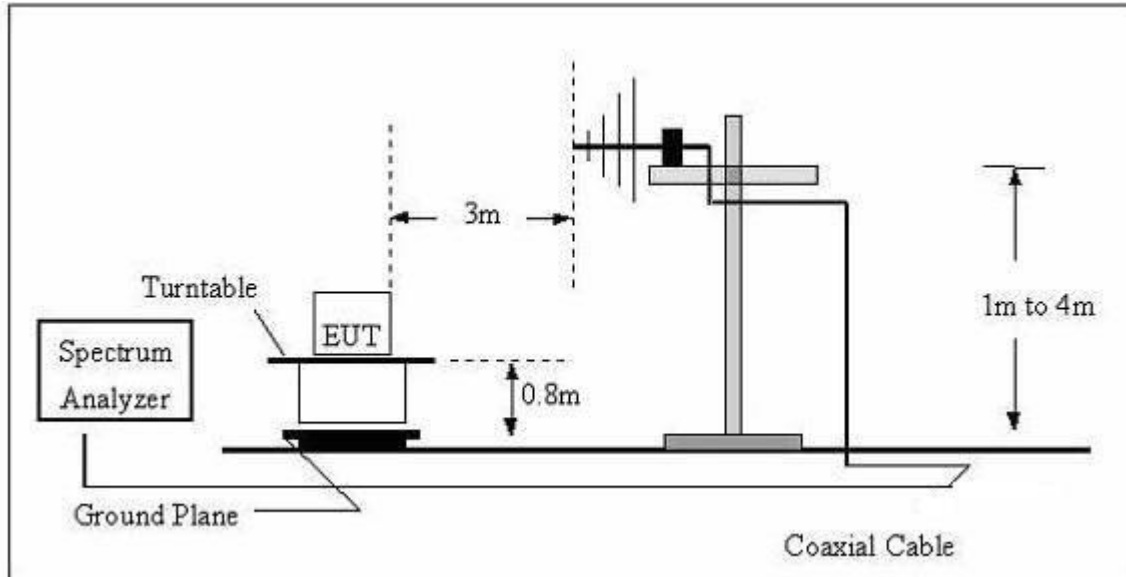

8.2 Applicable Standard

Emissions radiated outside of the specified frequency bands, except for harmonics, shall be attenuated by at least 50 dB below the level of the fundamental or to the general radiated emission limits in § 15.209, whichever is the lesser attenuation

8.3 Test Procedure

- a. Check the calibration of the measuring instrument using either an internal calibrator or a known signal from an external generator.
- b. Position the EUT without connection to measurement instrument. Turn on the EUT and connect its antenna terminal to measurement instrument via a low loss cable. Then set it to any one measured frequency within its operating range, and make sure the instrument is operated in its linear range.
- c. VBW for Peak, Quasi-peak, or Average Detector Function: $3 \times \text{RBW}$
- d. Repeat above procedures until all measured frequencies were complete.

Note:

Both horizontal and vertical antenna polarities were tested and performed pretest to three orthogonal axis. The worst case emissions were reported.

8.4 EUT Operating Conditions

The EUT tested system was configured as the statements of 2.4 Unless otherwise a special operating condition is specified in the follows during the testing.

8.5 Test Result

Temperature:	26 °C	Relative Humidity:	54%
Pressure:	101 kPa	Test Voltage :	DC 3.7V
Test Mode :	Transmitting		

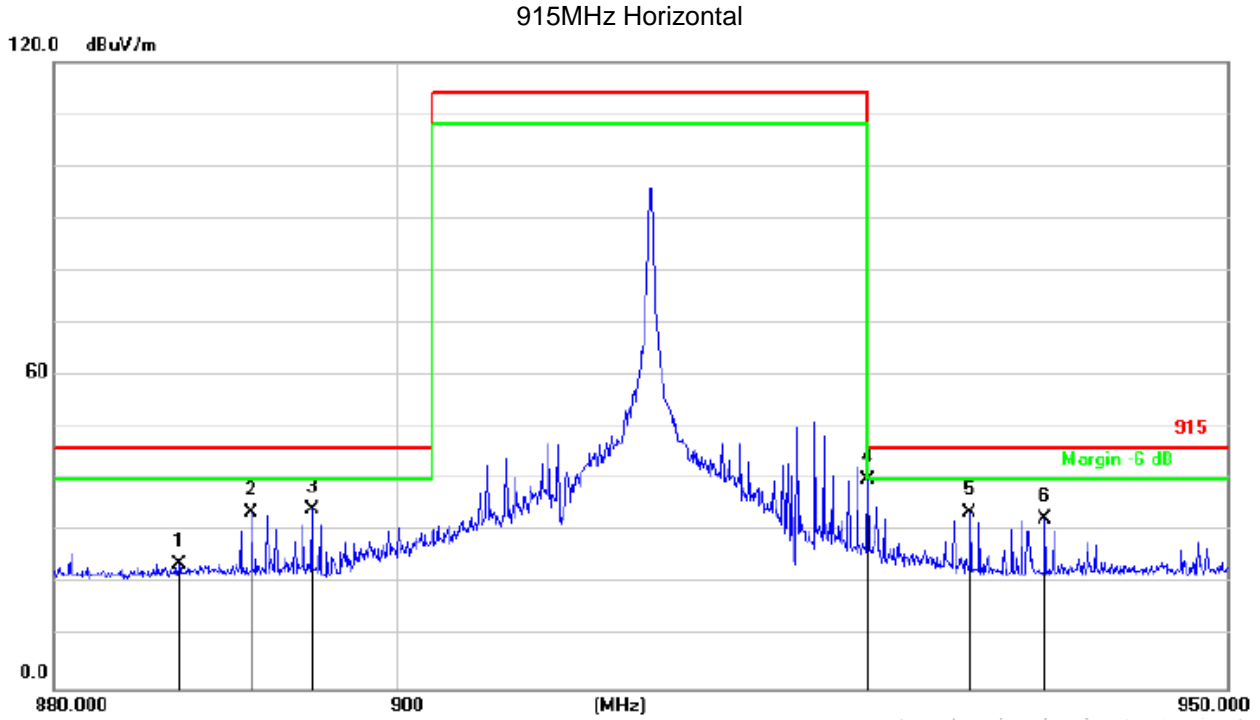

No.	Mk.	Freq.	Reading Level	Correct Factor	Measurement	Limit	Over	Detector
		MHz	dBuV	dB	dBuV/m	dB/m	dB	
1		887.2799	23.85	0.14	23.99	46.00	-22.01	QP
2		891.4800	33.59	0.25	33.84	46.00	-12.16	QP
3		894.9800	34.17	0.33	34.50	46.00	-11.50	QP
4	*	928.0199	39.74	0.44	40.18	46.00	-5.82	QP
5		934.2500	33.32	0.44	33.76	46.00	-12.24	QP
6		938.7998	32.21	0.44	32.65	46.00	-13.35	QP

915MHz Vertical

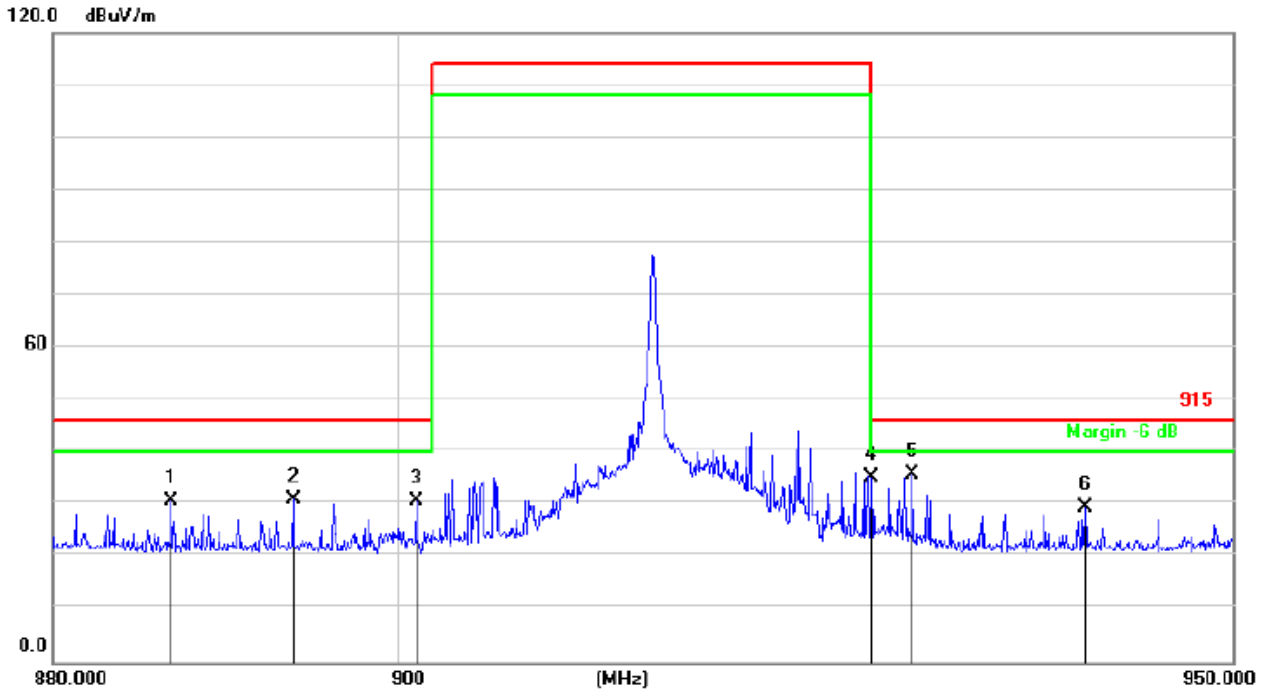

No.	Mk.	Freq. MHz	Reading Level dBuV	Correct Factor dB	Measure- ment dBuV/m	Limit dB/m	Over dB	Detector
1		886.8600	30.63	0.13	30.76	46.00	-15.24	QP
2		893.8600	30.71	0.31	31.02	46.00	-14.98	QP
3		901.0000	30.19	0.46	30.65	46.00	-15.35	QP
4		928.0199	34.86	0.44	35.30	46.00	-10.70	QP
5	*	930.5400	35.40	0.44	35.84	46.00	-10.16	QP
6		940.9700	29.21	0.44	29.65	46.00	-16.35	QP

9. 20 DB Bandwidth

9.1 Block Diagram Of Test Setup

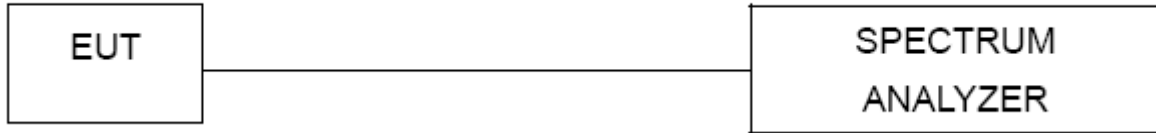

9.2 Limit

FCC Part15 (15.249) , Subpart C			
Section	Test Item	Frequency Range (MHz)	Result
15.249	Bandwidth	902~928	PASS

9.3 Test Procedure

1. Set resolution bandwidth (RBW) = 1-5% or DTS BW, not to exceed 100 kHz.
2. Set the video bandwidth (VBW) $\geq 3 \times$ RBW.
3. Detector = Peak.
4. Trace mode = max hold.
5. Sweep = auto couple.
6. Allow the trace to stabilize.
7. Measure the maximum width of the emission that is constrained by the frequencies associated with the two outermost amplitude points (upper and lower) that are attenuated by 20 dB relative to the maximum level measured in the fundamental emission.

9.4 EUT Operation Conditions

The EUT tested system was configured as the statements of 2.4 Unless otherwise a special operating condition is specified in the follows during the testing.

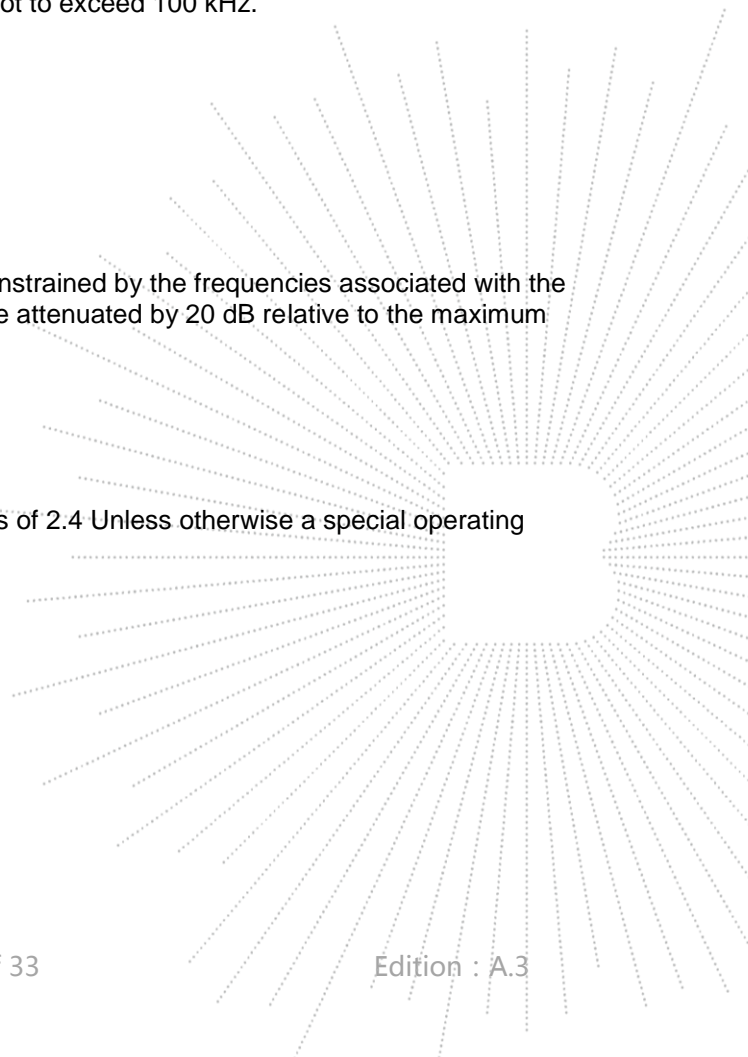

9.5 Test Result

Temperature :	26°C	Relative Humidity :	54%
Test Voltage :	DC 3.7V	Remark	N/A

Channel	Frequency (MHz)	20dB bandwidth (KHz)
01	915	76.58

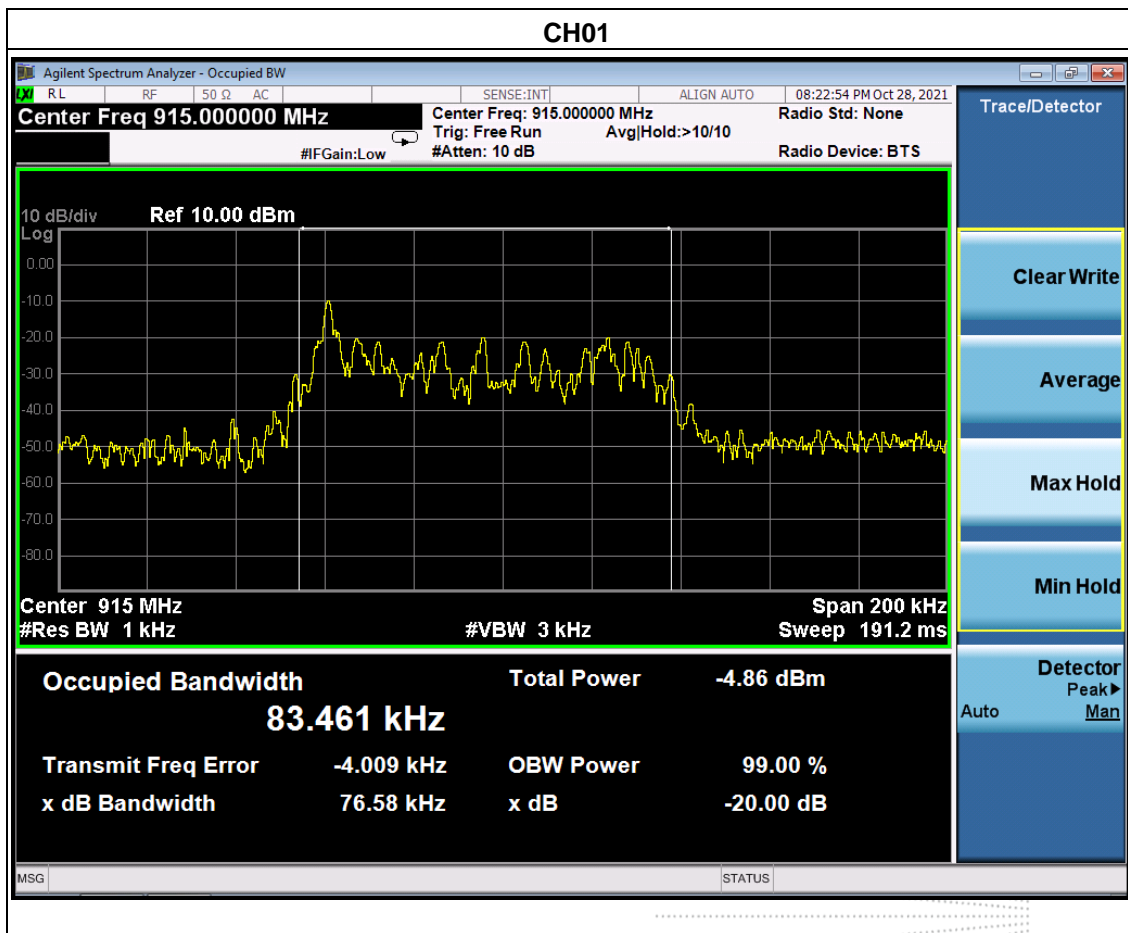

10. Antenna Requirement

10.1 Limit

15.203 requirement: For intentional device, according to 15.203: an intentional radiator shall be designed to ensure that no antenna other than that furnished by the responsible party shall be used with the device.

10.2 Test Result

The EUT antenna is Spring antenna, The antenna gain is 0dBi, fulfill the requirement of this section.

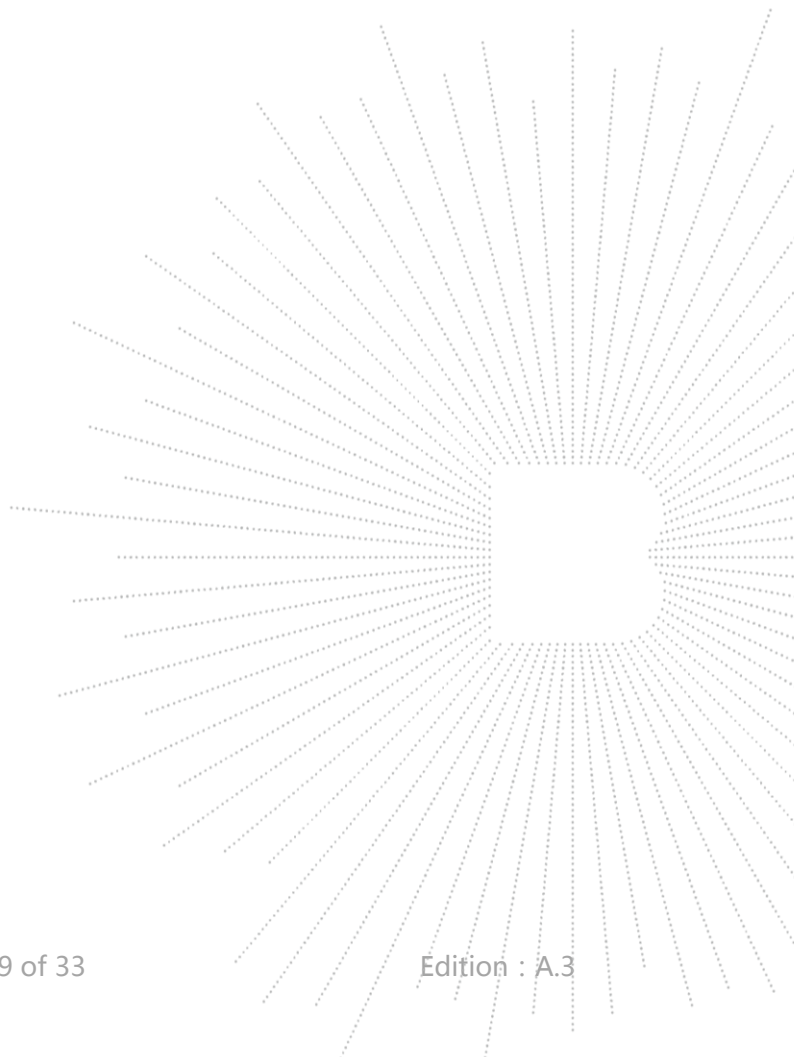

11. EUT Photographs

EUT Photo 1

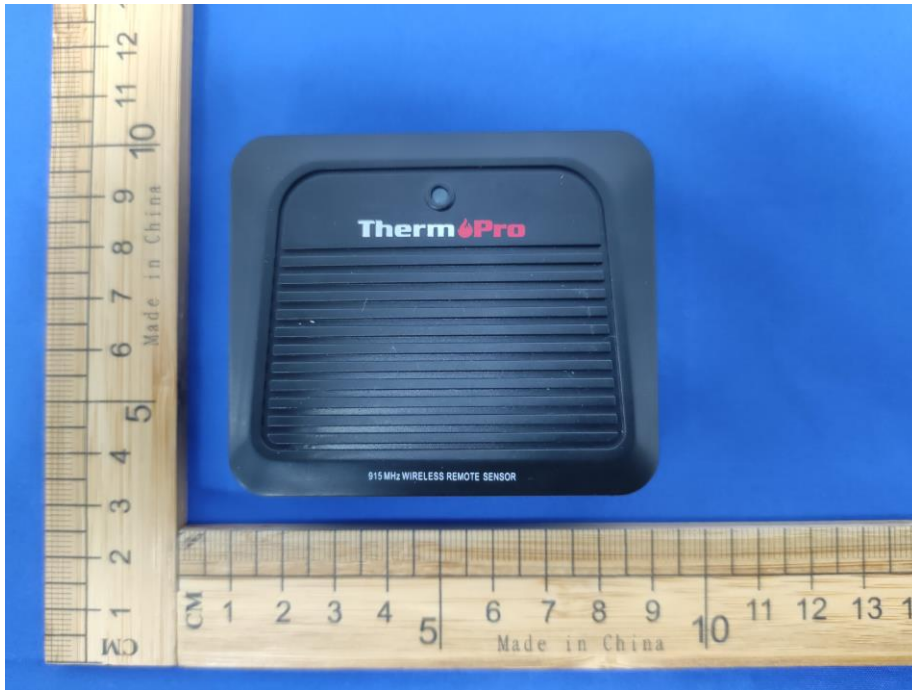

EUT Photo 2



12. EUT Test Setup Photographs

Conducted Measurement Photos



Radiated Measurement Photos



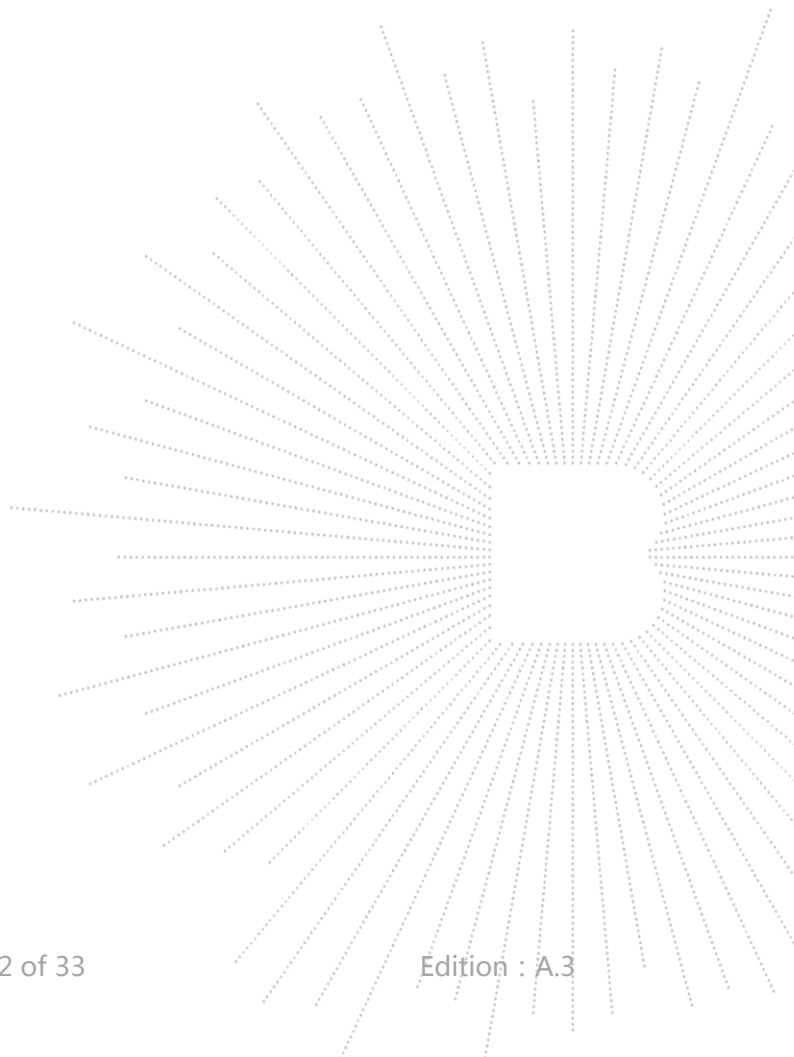

STATEMENT

- 1.The equipment lists are traceable to the national reference standards.
- 2.The test report can not be partially copied unless prior written approval is issued from our lab.
- 3.The test report is invalid without stamp of laboratory.
- 4.The test report is invalid without signature of person(s) testing and authorizing.
- 5.The test process and test result is only related to the Unit Under Test.
- 6.The quality system of our laboratory is in accordance with ISO/IEC17025.
- 7.If there is any objection to report, the client should inform issuing laboratory within 15 days from the date of receiving test report.

Address:

1-2/F., Building B, Pengzhou Industrial Park, No.158, Fuyuan 1st Road, Tangwei, Fuhai Subdistrict, Bao'an District, Shenzhen, Guangdong, China

TEL : 400-788-9558

P.C.: 518103

FAX : 0755-33229357

Website : <http://www.chnbctc.com>

E-Mail : bctc@bctc-lab.com.cn

***** END *****

