

RADIO TEST REPORT

The device described below is tested by Dongguan Nore Testing Center Co., Ltd. to determine the maximum emission levels emanating from the device, the severe levels which the device can endure and E.U.T.'s performance criterion. The test results, data evaluation, test procedures, and equipment of configurations shown in this report were made in accordance with the procedures in ANSI C63.10(2013).

Applicant / Manufacturer : FN-LINK TECHNOLOGY LIMITED

Address : No. 8, Litong Road, Liuyang Economic Development Zone, Liuyang City, Hunan Province, China

Factory : FN-LINK TECHNOLOGY LIMITED

Address : No. 8, Litong Road, Liuyang Economic Development Zone, Liuyang City, Hunan Province, China

E.U.T. : WIFI Module

Brand Name : FN-LINK

Model No. : F11AMIM13-B1

FCC ID : 2AATL-F11AMIM13-B1

Measurement Standard : FCC PART 15.247: 2016

Date of Receiver : November 30, 2016

Date of Test : November 30, 2016 to December 13, 2016

Date of Report : December 13, 2016

This Test Report is Issued Under the Authority of :

Prepared by



Rose Hu / Engineer

Approved by / Authorized Signer



Iori Fan / Authorized Signatory

This test report is for the customer shown above and their specific product only. This report applies to above tested sample only and shall not be reproduced in part without written approval of Dongguan Nore Testing Center Co., Ltd.

Table of Contents

1. GENERAL INFORMATION	5
1.1 PRODUCT DESCRIPTION FOR EQUIPMENT UNDER TEST	5
1.2 RELATED SUBMITTAL(S) / GRANT (S).....	5
1.3 TEST METHODOLOGY.....	7
1.4 EQUIPMENT MODIFICATIONS	7
1.5 SUPPORT DEVICE	7
1.6 TEST FACILITY AND LOCATION.....	8
1.7 SUMMARY OF TEST RESULTS.....	9
2. SYSTEM TEST CONFIGURATION.....	10
2.1 EUT CONFIGURATION	10
2.2 SPECIAL ACCESSORIES.....	10
2.3 DESCRIPTION OF TEST MODES	10
2.4 EUT EXERCISE	10
3. CONDUCTED EMISSIONS TEST	11
3.1 TEST SET-UP (BLOCK DIAGRAM OF CONFIGURATION).....	11
3.2 TEST CONDITION	11
3.3 MEASUREMENT RESULTS.....	11
4. MAX. CONDUCTED OUTPUT POWER.....	14
4.1 MEASUREMENT PROCEDURE	14
4.2 TEST SET-UP (BLOCK DIAGRAM OF CONFIGURATION).....	14
4.3 MEASUREMENT RESULTS.....	14
5. 6DB&20DB BANDWIDTH.....	16
5.1 MEASUREMENT PROCEDURE	16
5.2 TEST SET-UP (BLOCK DIAGRAM OF CONFIGURATION).....	16
5.3 MEASUREMENT RESULTS.....	16
6. POWER SPECTRAL DENSITY	24
6.1 MEASUREMENT PROCEDURE	24
6.2 TEST SET-UP (BLOCK DIAGRAM OF CONFIGURATION).....	24
6.3 MEASUREMENT RESULTS.....	24
7. BAND EDGE AND CONDUCTED SPURIOUS EMISSIONS	32
7.1 REQUIREMENT AND MEASUREMENT PROCEDURE.....	32
7.2 TEST SET-UP (BLOCK DIAGRAM OF CONFIGURATION).....	32
7.3 MEASUREMENT RESULTS.....	32
8. RADIATED SPURIOUS EMISSIONS AND RESTRICTED BANDS	40
8.1 TEST SET-UP (BLOCK DIAGRAM OF CONFIGURATION).....	40



8.2 MEASUREMENT PROCEDURE	41
8.3 LIMIT.....	42
8.4 MEASUREMENT RESULTS	42
9. ANTENNA APPLICATION	46
9.1 ANTENNA REQUIREMENT	46
9.2 MEASUREMENT RESULTS.....	46
10. TEST EQUIPMENT LIST.....	47

1. GENERAL INFORMATION

1.1 Product Description for Equipment under Test

This device is a WIFI Module, it's powered by DC 3.3V come from external power source. For more details features, please refer to User's Manual.

Power Supply	: DC 3.3V
Adapter	: None
Test voltage	: AC 120V 60Hz PC input
Model name	: F11AMIM13-B1
Model difference	: None
Hardware version	: V1.0
Software version	: V1.0
Serial number	: N/A
Note	: None

Technical parameters For WIFI Function

Frequency Range	: 2412-2462MHz for 802.11b/g/n(HT20) 2422-2452MHz for 802.11n(HT40)
Modulation	: DSSS for 802.11b OFDM for 802.11g/n(HT20)/n(HT40)
Number of Channel	: 11 for 802.11b/g/n(HT20) 7 for 802.11n(HT40)
Channel space	: 5MHz
Date Rate	: 802.11b:1~11Mbps, 802.11g:6~54Mbps 802.11n: 6.5~135Mbps
Antenna Type	: PCB
Antenna Gain	: 0 dBi

WIFI Channel List

802.11 b/g/n(HT20)		802.11 n(HT40)	
Channel	Frequency MHz	Channel	Frequency MHz
1	2412	---	---
2	2417	---	---
3	2422	3	2422
4	2427	4	2427
5	2432	5	2432
6	2437	6	2437
7	2442	7	2442
8	2447	8	2447
9	2452	9	2452
10	2457	---	---
11	2462	---	---

Note: According to section 15.31(m), regards to the operating frequency range over 10MHz, the Lowest, middle, and the Highest frequency of channel were selected to perform the test. The selected frequency see below:

802.11b/g/n(HT20)		802.11 n(HT40)	
Channel	Frequency MHz	Channel	Frequency MHz
1	2412	3	2422
6	2437	6	2437
11	2462	9	2452

Test SW version	UI_mptool
-----------------	-----------

1.2 Related Submittal(s) / Grant (s)

This submittal(s) (test report) is intended for FCC ID: **2AATL-F11AMIM13-B1** filing to comply with Section 15.247 of the FCC Part 15(2016), Subpart C Rule.

1.3 Test Methodology

Both AC mains line-conducted and radiated emission measurements were performed according to the procedures in ANSI C63.10 (2013). Radiated emission measurement was performed in semi-anechoic chamber and conducted emission measurement was performed in shield room. For radiated emission measurement, preliminary scans were performed in the semi-anechoic chamber only to determine the worst case modes. All radiated tests were performed at an antenna to EUT distance of 3 meters. All other measurements were made in accordance with the procedures in 47 CFR part 2.

1.4 Equipment Modifications

Not available for this EUT intended for grant.

1.5 Support Device

Notebook PC	: Manufacturer: IBM Corporation M/N: R50e S/N: L3-HZNGO P/N: 1834KDC
Adapter	: Manufacturer: IBM Corporation M/N: 08K8210 Input: AC100-240V 50/60Hz 0.5-1.0A Output: DC 16V 4.5A

1.6 Test Facility and Location

Listed by FCC, July 03, 2014
The Certificate Registration Number is 665078.
Listed by Industry Canada, June 18, 2014
The Certificate Registration Number is 9743A.

Dongguan NTC Co., Ltd.
(Full Name: Dongguan Nore Testing Center Co., Ltd.)

Building D, Gaosheng Science and Technology Park, Hongtu Road,
Nancheng District, Dongguan City, Guangdong, China
(Full Name: Building D, Gaosheng Science & Technology Park,
Zhouxi Longxi Road, Nancheng District, Dongguan, Guangdong, China.

1.7 Summary of Test Results

FCC Rules	Description Of Test	Uncertainty	Result
§15.207 (a)	AC Power Conducted Emission	±1.06dB	Compliant
§15.247(b)(3)	Max. Conducted Output Power	±1.06dB	Compliant
§15.247(a)(2)	6dB Bandwidth	±1.42 x10 ⁻⁴ %	Compliant
§15.247(e)	Power Spectral Density	±1.06dB	Compliance
§15.247(d)	Band Edge and Conducted Spurious Emissions	±1.70dB & ±2.51dB	Compliance
§15.247(d),§15.209, §15.205	Radiated Spurious Emissions and Restricted Bands	±3.70dB	Compliance
§15.203	Antenna Requirement	±0.60dB	Compliance

Note: The EUT is a modular device, so the EUT shall be performed three orthogonal planes. **The worst plane is Z.**

Example:

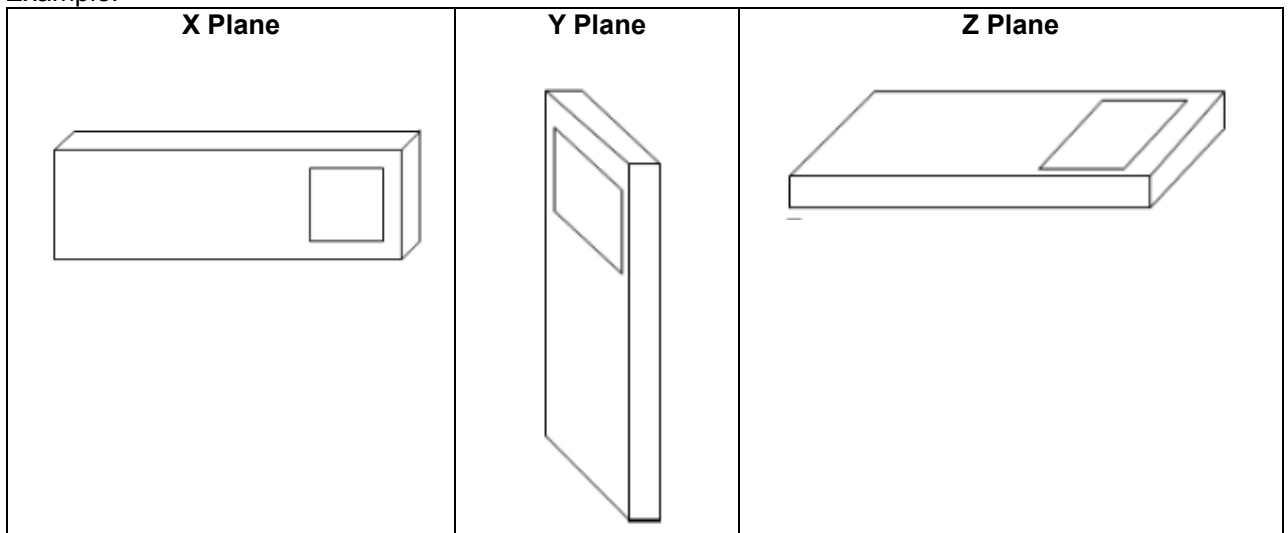

2. System Test Configuration

2.1 EUT Configuration

The EUT configuration for testing is installed on RF field strength measurement to meet the Commissions requirement and operating in a manner which intends to maximize its emission characteristics in a continuous normal application.

2.2 Special Accessories

Not available for this EUT intended for grant.

2.3 Description of test modes

The EUT has been tested under continuous operating condition. Test program used to control the EUT staying in continuous transmitting mode. The Lowest, middle and highest channel were chosen for testing, and modulation type CCK, DQPSK, DBPSK, OFDM and all data rate were tested. But only the worst case data is shown in this report.

2.4 EUT Exercise

The EUT was operated in the engineering mode to fix the Tx frequency that was for the purpose of the measurements.

3. Conducted Emissions Test

3.1 Test SET-UP (Block Diagram of Configuration)

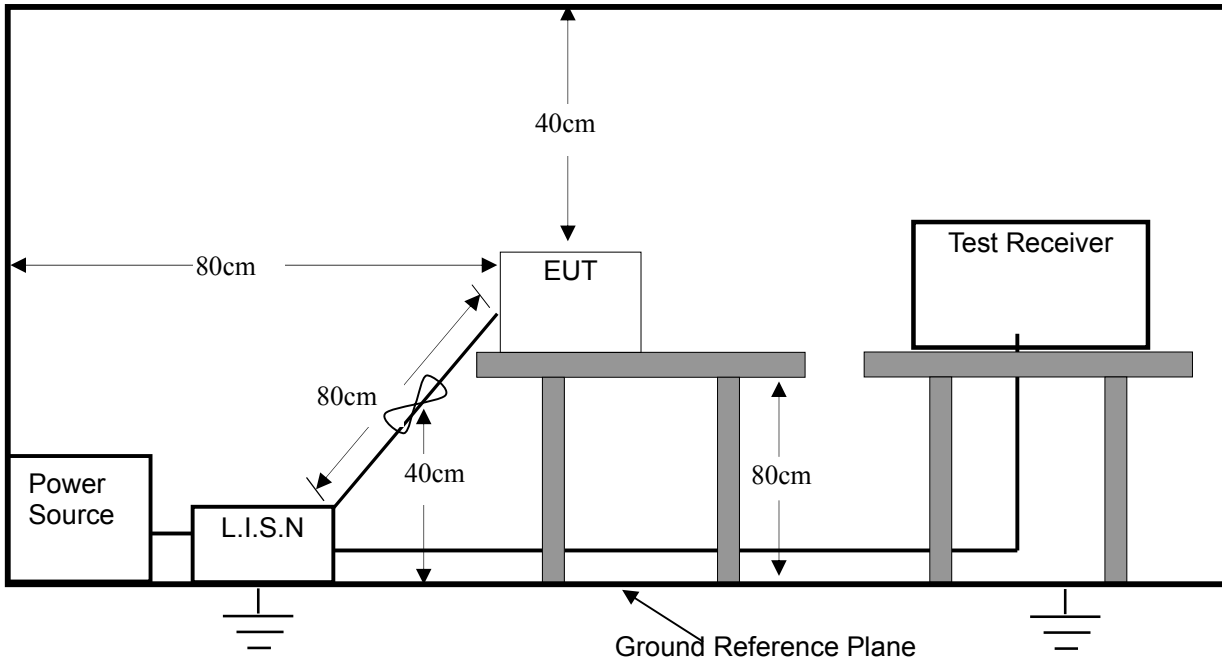

3.2 Test Condition

Test Requirement: FCC Part 15.207

Frequency Range: 150KHz ~ 30MHz

Detector: RBW 9KHz, VBW 30KHz

Operation Mode: WIFI Mode

3.3 Measurement Results

Please refer to following plots of the worst case: 802.11b High channel.

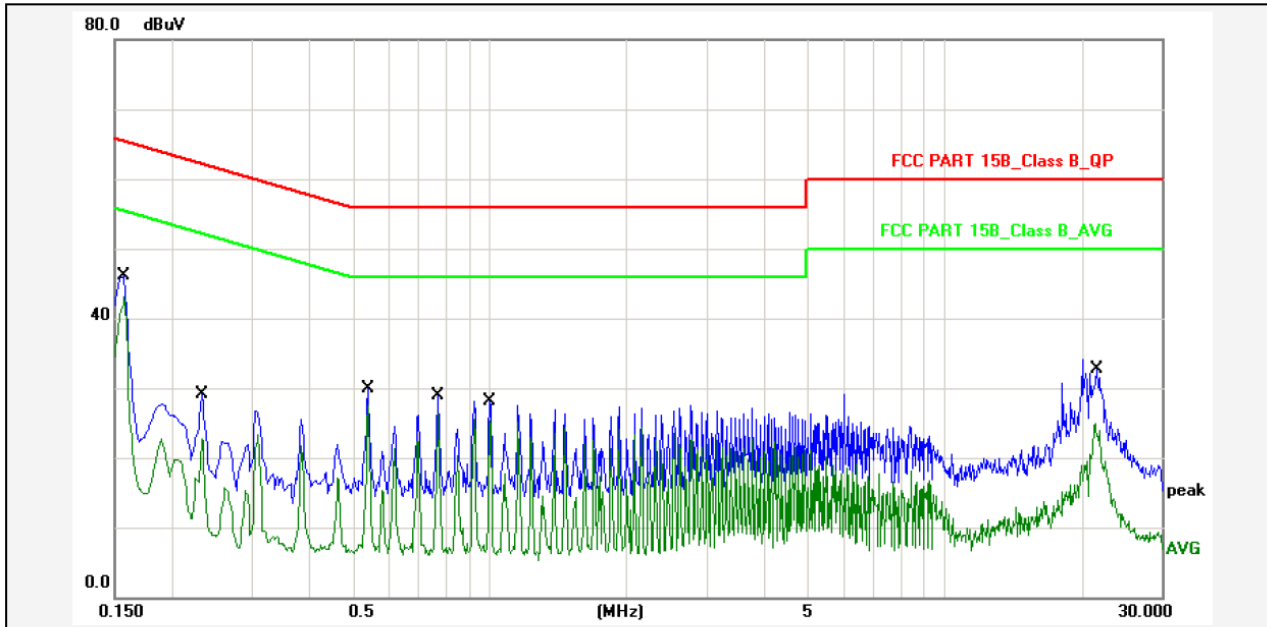

Report No.:	F11AMIM13-B1	Phase:	L1
Test Standard:	FCC PART 15B_Class B_QP	Temp.()/Hum.(%):	22(C) / 52 %
Test item:	Conducted Emission	Power Rating:	AC 230V/50Hz
Applicant:	FN-LINK	Test Engineer:	Ryan
Product:	WIFI Module		
Model No.:	F11AMIM13-B1		
Test Mode:	WIFI Mode		
Remark:			

No.	Frequency (MHz)	Factor (dBuV)	Reading (dBuV)	Level (dBuV)	Limit (dBuV)	Margin (dB)	Detector	P/F	Remark
1	0.1580	10.80	33.30	44.10	65.56	-21.46	QP	P	
2	0.1580	10.80	30.30	41.10	55.56	-14.46	AVG	P	
3	0.2340	10.80	16.40	27.20	62.30	-35.10	QP	P	
4	0.2340	10.80	10.00	20.80	52.30	-31.50	AVG	P	
5	0.5420	10.80	17.10	27.90	56.00	-28.10	QP	P	
6	0.5420	10.80	14.80	25.60	46.00	-20.40	AVG	P	
7	0.7740	10.80	16.10	26.90	56.00	-29.10	QP	P	
8	0.7740	10.80	13.50	24.30	46.00	-21.70	AVG	P	
9	1.0020	10.80	15.30	26.10	56.00	-29.90	QP	P	
10	1.0020	10.80	12.50	23.30	46.00	-22.70	AVG	P	
11	21.4700	10.80	21.30	32.10	60.00	-27.90	QP	P	
12	21.4700	10.80	12.10	22.90	50.00	-27.10	AVG	P	

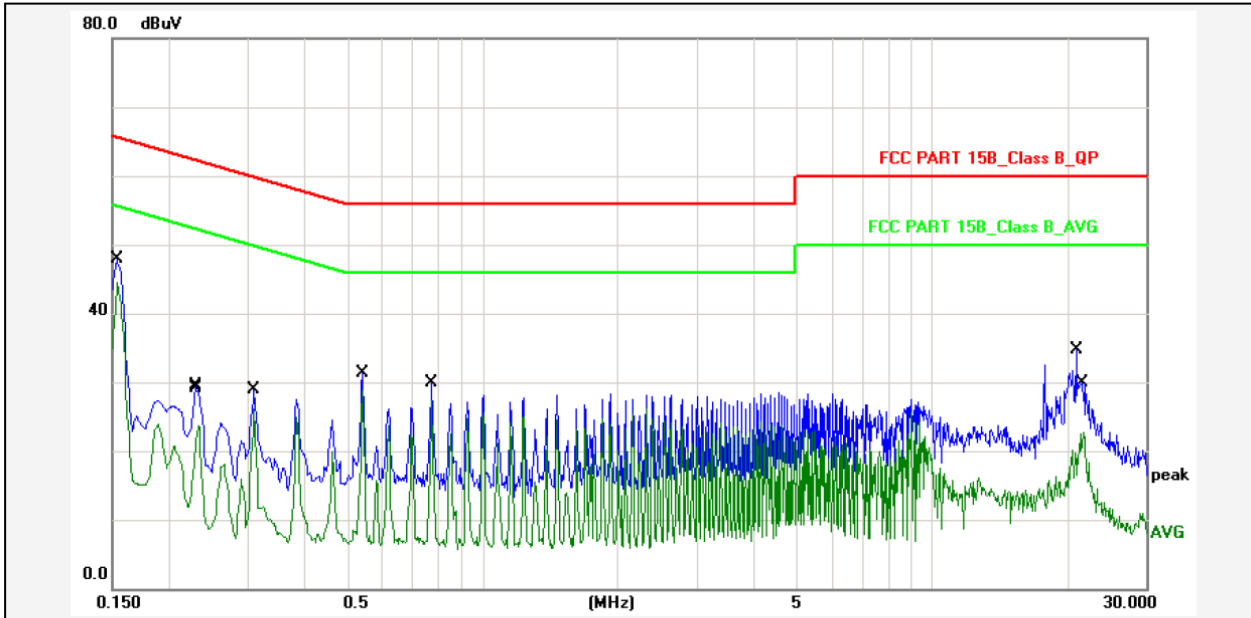

Report No.:	F11AMIM13-B1	Phase:	N
Test Standard:	FCC PART 15B_Class B_QP	Temp.()/Hum.(%):	22(C) / 52 %
Test item:	Conducted Emission	Power Rating:	AC 230V/50Hz
Applicant:	FN-LINK	Test Engineer:	Ryan
Product:	WIFI Module		
Model No.:	F11AMIM13-B1		
Test Mode:	WIFI Mode		
Remark:			

No.	Frequency (MHz)	Factor (dBuV)	Reading (dBuV)	Level (dBuV)	Limit (dBuV)	Margin (dB)	Detector	P/F	Remark
1	0.1539	10.80	35.10	45.90	65.78	-19.88	QP	P	
2	0.1539	10.80	31.60	42.40	55.78	-13.38	AVG	P	
3	0.2300	10.80	16.50	27.30	62.45	-35.15	QP	P	
4	0.2340	10.80	10.90	21.70	52.30	-30.60	AVG	P	
5	0.3100	10.80	16.10	26.90	59.97	-33.07	QP	P	
6	0.3100	10.80	13.30	24.10	49.97	-25.87	AVG	P	
7	0.5420	10.80	18.40	29.20	56.00	-26.80	QP	P	
8	0.5420	10.80	16.00	26.80	46.00	-19.20	AVG	P	
9	0.7740	10.80	17.10	27.90	56.00	-28.10	QP	P	
10	0.7740	10.80	14.40	25.20	46.00	-20.80	AVG	P	
11	20.9300	10.80	22.00	32.80	60.00	-27.20	QP	P	
12	21.7820	10.80	9.90	20.70	50.00	-29.30	AVG	P	

4. Max. Conducted Output Power

4.1 Measurement Procedure

Maximum Conducted Output power at Antenna Terminals, FCC Rules 15.247(b)(3):

One of the following procedures may be used to determine the maximum peak conducted output power of a DTS EUT.

The maximum peak conducted output power may be measured using a broadband peak RF power meter. The power meter shall have a video bandwidth that is greater than or equal to the DTS bandwidth and shall utilize a fast-responding diode detector.

4.2 Test SET-UP (Block Diagram of Configuration)

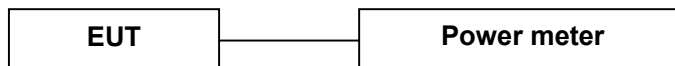

4.3 Measurement Results

Pass

Please refer to following table.



Temperature :	24 °C	Humidity :	50%
Test By:	Sance	Test Date :	December 07, 2016
Test Result:	PASS		
Frequency MHz	Data Rate Mbps	Peak Output Power dBm	Limit dBm
IEEE 802.11b Mode (CCK, Antenna Gain=0dBi)			
Low Channel: 2412	1	13.31	30
Middle Channel: 2437	1	13.44	30
High Channel: 2462	1	13.63	30
IEEE 802.11g Mode (OFDM, Antenna Gain=0dBi)			
Low Channel: 2412	6	9.15	30
Middle Channel: 2437	6	10.04	30
High Channel: 2462	6	10.63	30
IEEE 802.11n(HT20) Mode (OFDM, Antenna Gain=0dBi)			
Low Channel: 2412	6.5	9.36	30
Middle Channel: 2437	6.5	10.32	30
High Channel: 2462	6.5	11.05	30
IEEE 802.11n(HT40) Mode (OFDM, Antenna Gain=0dBi)			
Low Channel: 2422	13	9.46	30
Middle Channel: 2437	13	10.10	30
High Channel: 2452	13	10.52	30

5. 6dB Bandwidth

5.1 Measurement Procedure

DTS 6dB Channel Bandwidth, FCC Rule 15.247(a)(2):

The antenna port of the EUT was connected to the input of a spectrum analyzer. Analyzer was set as below according to FCC KDB558074(v03r03):

1. For 6dB bandwidth, Set the RBW = 100KHz.
2. Set the VBW $\geq 3 \times$ RBW
3. Detector = peak.
4. Sweep time = auto couple.
5. Trace mode = max hold.
6. Allow trace to fully stabilize.
7. Measure the maximum width of the emission that is constrained by the frequencies associated with the two outermost amplitude points (upper and lower frequencies) that are attenuated by 6 dB relative to the maximum level measured in the fundamental emission.

5.2 Test SET-UP (Block Diagram of Configuration)

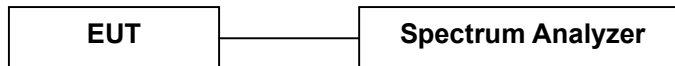

5.3 Measurement Results

Pass

Please refer to following table and plots.

Temperature :	24 °C	Humidity : 50 %	
Test By:	Sance	Test Date : December 07, 2016	
Test Result:	PASS		
Frequency MHz	Data Rate Mbps	6dB Bandwidth MHz	Limit
IEEE 802.11b Mode (CCK)			
Low Channel: 2412	1	10.06	>500KHz
Middle Channel: 2437	1	10.06	>500KHz
High Channel: 2462	1	10.06	>500KHz
IEEE 802.11g Mode (OFDM)			
Low Channel: 2412	6	16.47	>500KHz
Middle Channel: 2437	6	16.54	>500KHz
High Channel: 2462	6	16.54	>500KHz
IEEE 802.11n(HT20) Mode (OFDM)			
Low Channel: 2412	6.5	17.69	>500KHz
Middle Channel: 2437	6.5	17.63	>500KHz
High Channel: 2462	6.5	17.56	>500KHz
IEEE 802.11n(HT40) Mode (OFDM)			
Low Channel: 2422	13	35.90	>500KHz
Middle Channel: 2437	13	36.03	>500KHz
High Channel: 2452	13	36.03	>500KHz

802.11b Low Channel

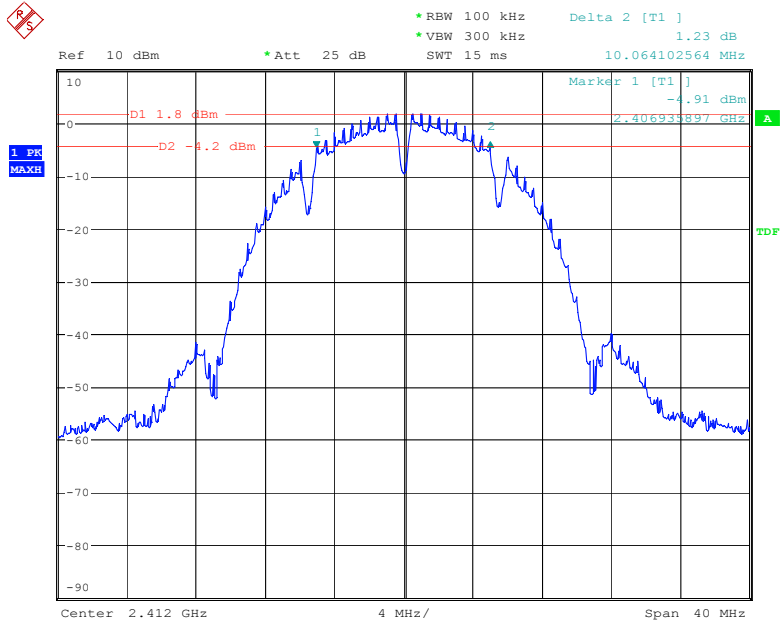

Date: 7.DEC.2016 10:57:06

802.11b Middle Channel

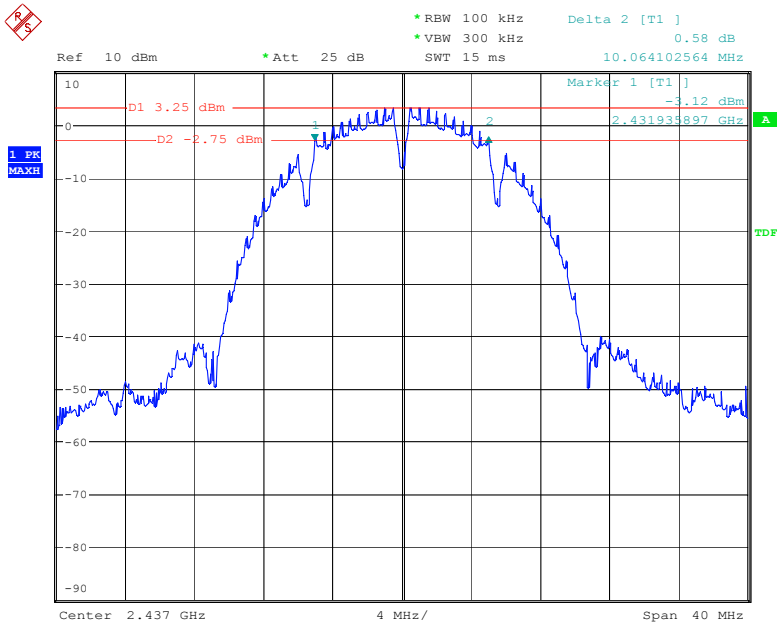

Date: 7.DEC.2016 13:51:53

802.11b High Channel

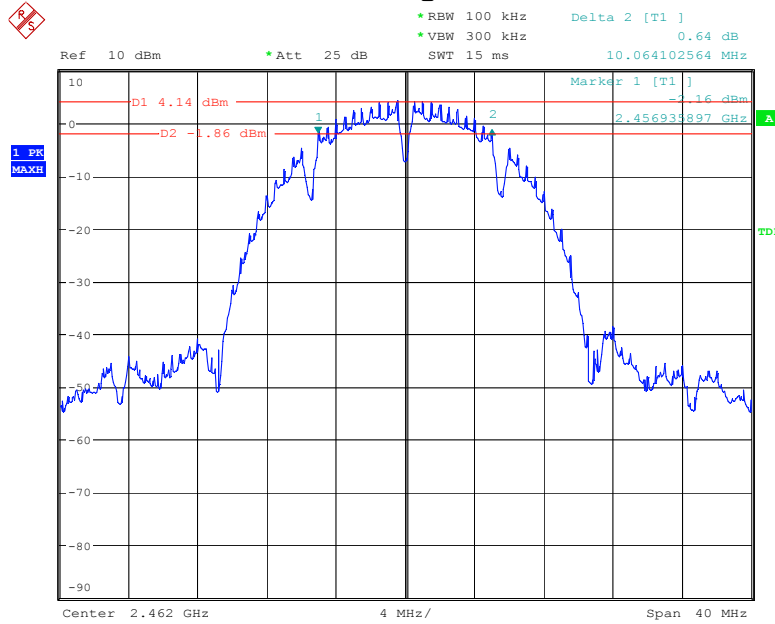

Date: 7.DEC.2016 13:53:30

802.11g Low Channel

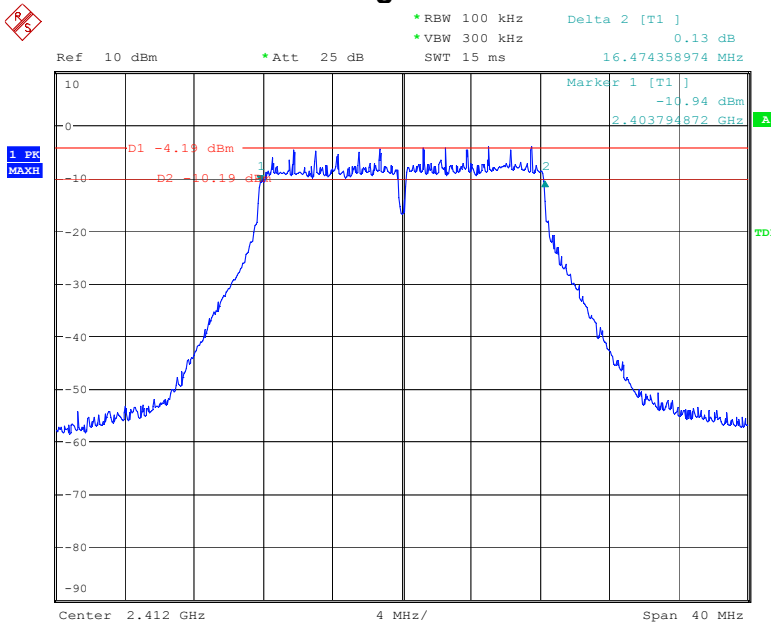

Date: 7.DEC.2016 13:55:10

802.11g Middle Channel

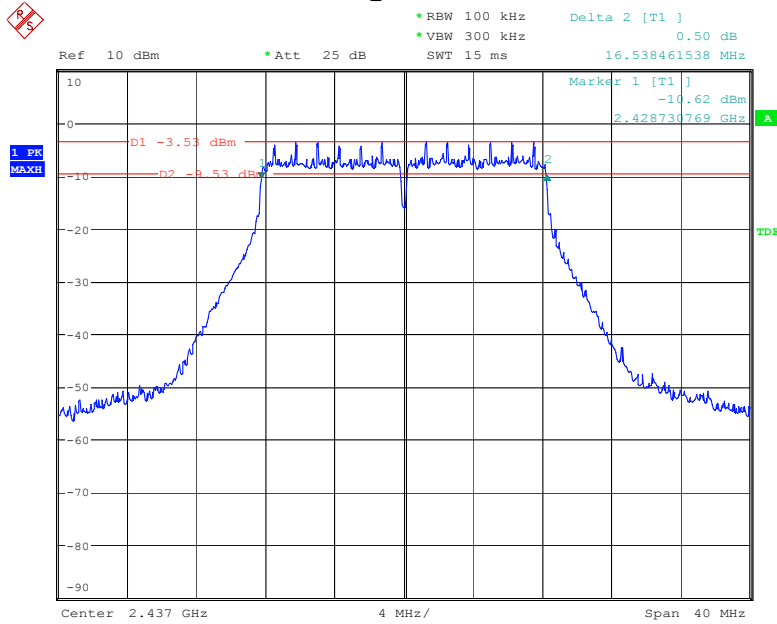

Date: 7.DEC.2016 13:57:43

802.11g High Channel

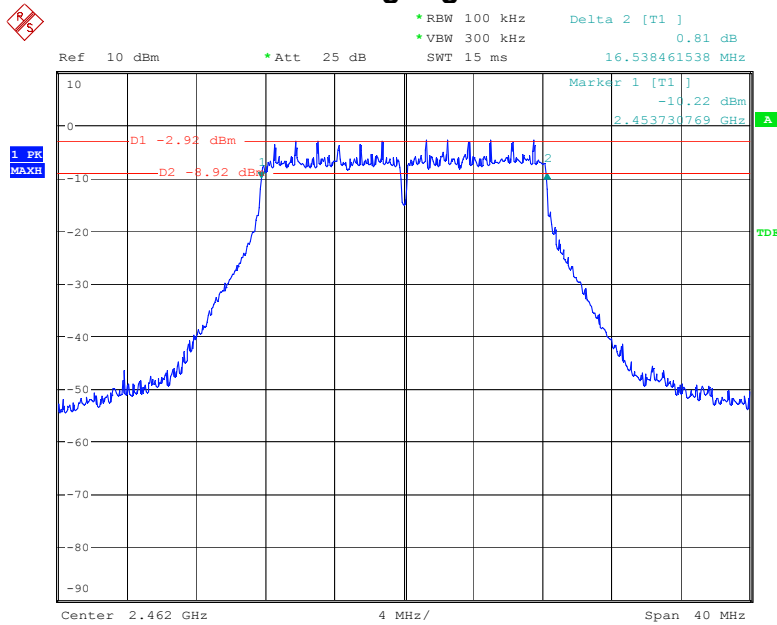

Date: 7.DEC.2016 13:59:18

802.11n(HT20) Low Channel

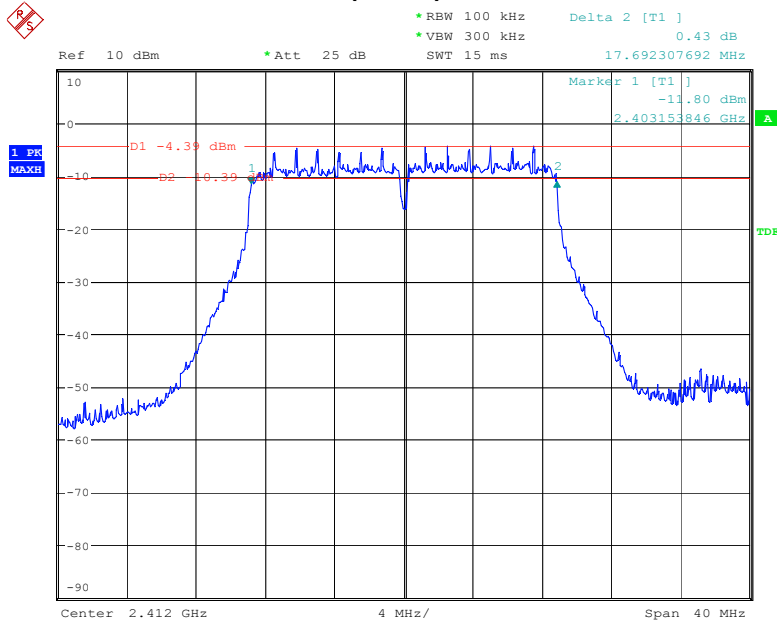

Date: 7.DEC.2016 14:00:59

802.11n(HT20) Middle Channel

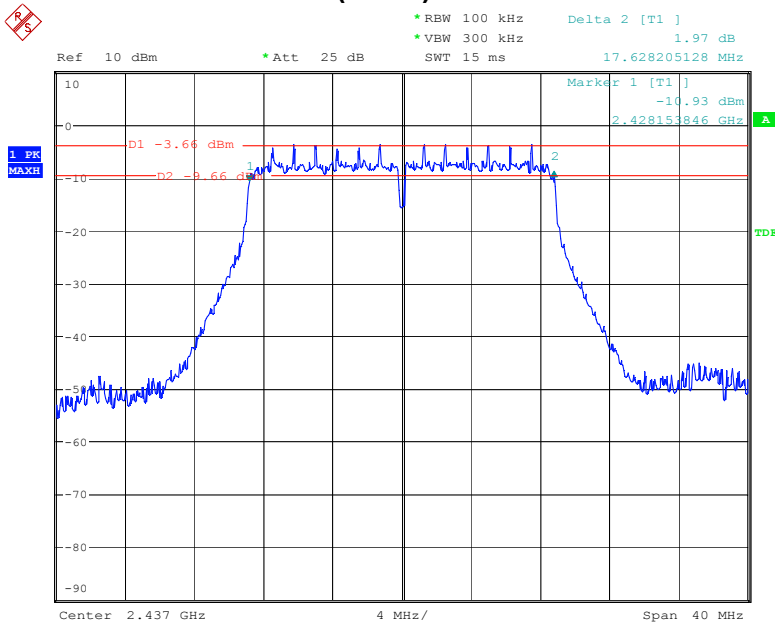

Date: 7.DEC.2016 14:03:09

802.11n(HT20) High Channel

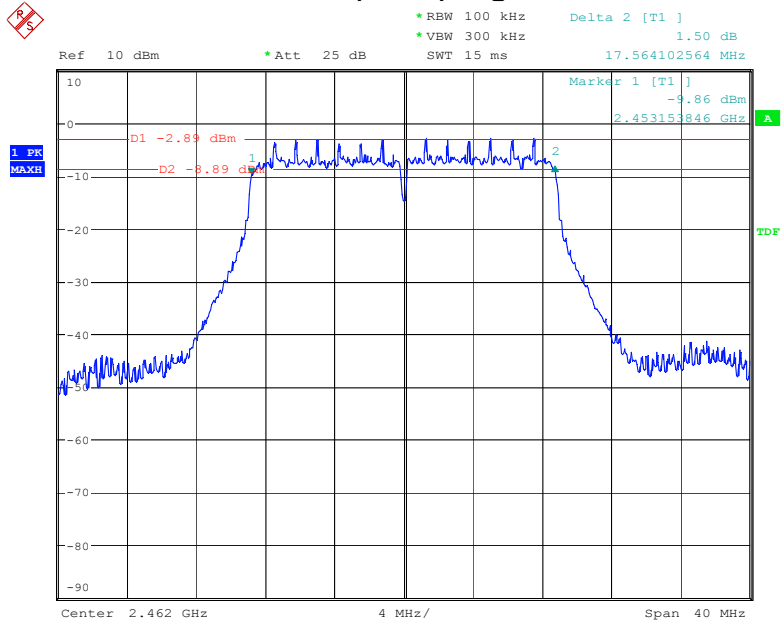

Date: 7.DEC.2016 14:05:24

802.11n(HT40) Low Channel

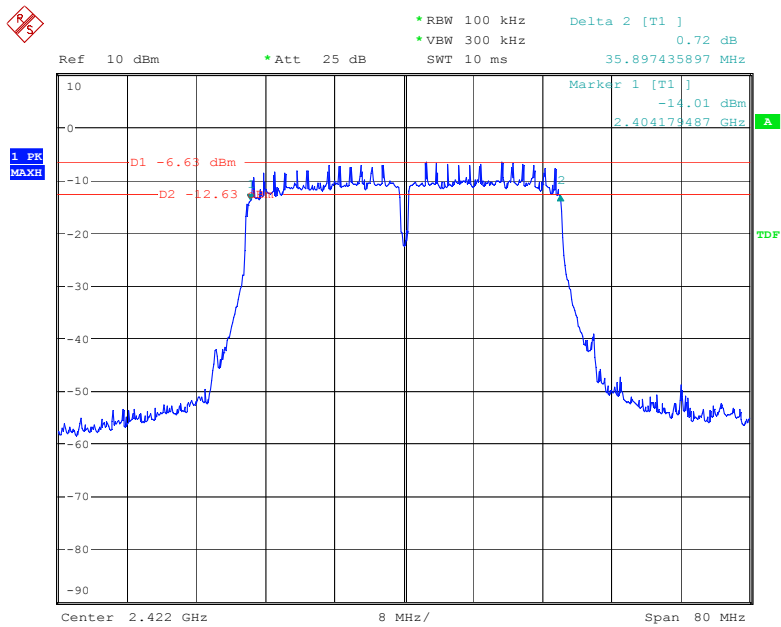

Date: 7.DEC.2016 14:09:33

802.11n(HT40) Middle Channel

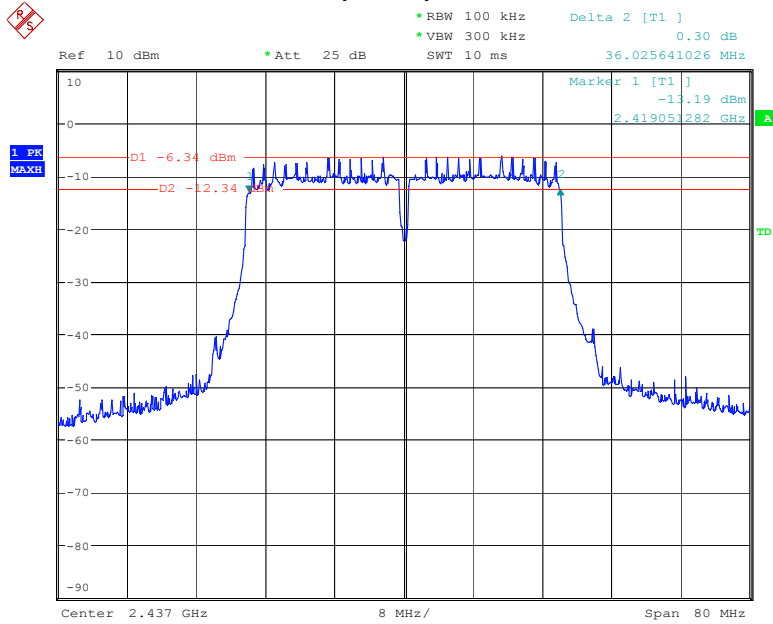

Date: 7.DEC.2016 14:12:04

802.11n(HT40) High Channel

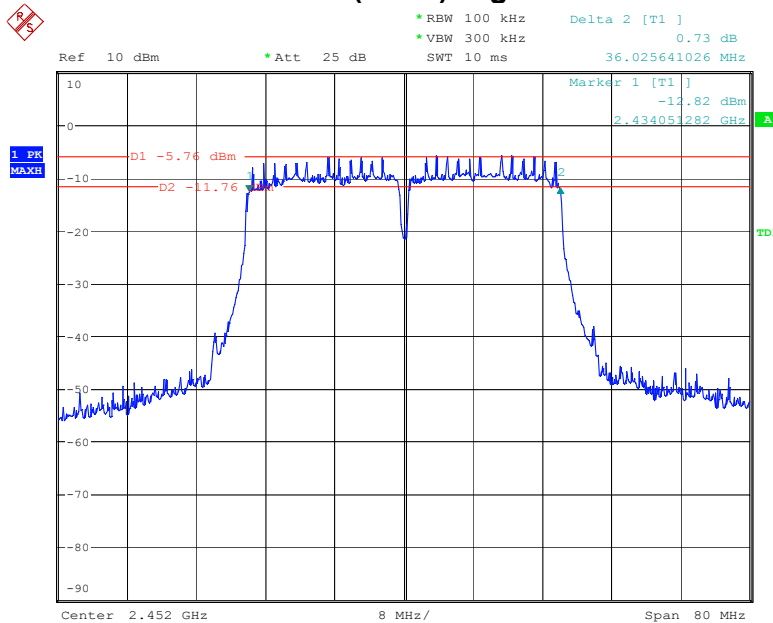

Date: 7.DEC.2016 14:13:56

6. Power Spectral Density

6.1 Measurement Procedure

DTS 6dB Channel Bandwidth, FCC Rule 15.247(a)(2):

The antenna port of the EUT was connected to the input of a spectrum analyzer. Analyzer was set as below according to FCC KDB558074 (v03r03):

1. Set analyzer center frequency to DTS channel center frequency.
2. Set the span to 1.5 times the DTS bandwidth.
3. Set the RBW to: $3 \text{ kHz} \leq \text{RBW} \leq 100 \text{ kHz}$
4. Set the VBW $\geq 3 \times \text{RBW}$.
5. Detector = peak.
6. Sweep time = auto couple.
7. Trace mode = max hold.
8. Allow trace to fully stabilize.
9. Use the peak marker function to determine the maximum amplitude level within the RBW.
10. If measured value exceeds limit, reduce RBW (no less than 3 kHz) and repeat.

6.2 Test SET-UP (Block Diagram of Configuration)

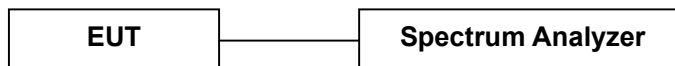

6.3 Measurement Results

Pass

Please refer to following table and plots.

Temperature :	24 °C	Humidity :	50 %
Test By:	Sance	Test Date :	December 07, 2016
Test Result:	PASS		
Frequency MHz	Data Rate Mbps	PSD dBm/3kHz	Limit dBm/3kHz
IEEE 802.11b Mode (CCK)			
Low Channel: 2412	1	-14.59	8
Middle Channel: 2437	1	-14.12	8
High Channel: 2462	1	-12.46	8
IEEE 802.11g Mode (OFDM)			
Low Channel: 2412	6	-20.14	8
Middle Channel: 2437	6	-19.82	8
High Channel: 2462	6	-18.78	8
IEEE 802.11n(HT20) Mode (OFDM)			
Low Channel: 2412	6.5	-20.08	8
Middle Channel: 2437	6.5	-19.20	8
High Channel: 2462	6.5	-18.94	8
IEEE 802.11n(HT40) Mode (OFDM)			
Low Channel: 2422	13	-22.40	8
Middle Channel: 2437	13	-21.77	8
High Channel: 2452	13	-21.38	8

802.11b Low Channel

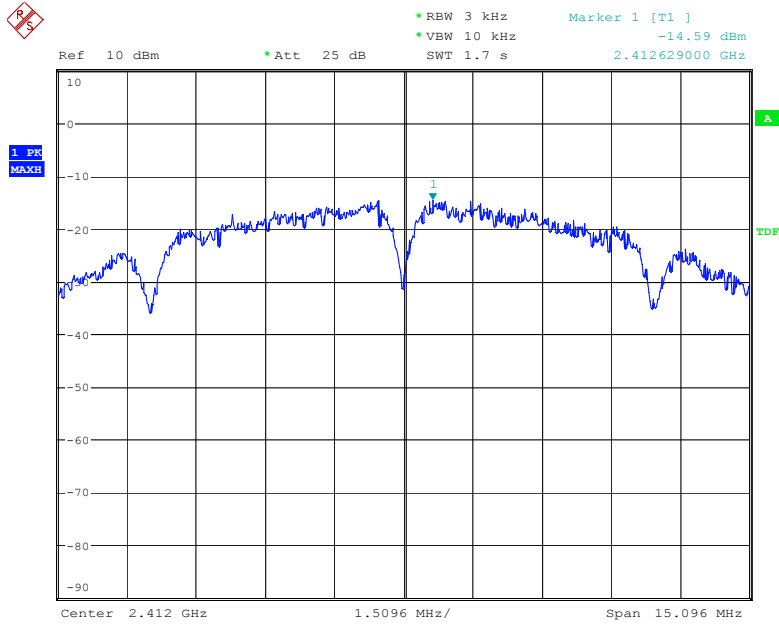

Date: 7.DEC.2016 14:20:41

802.11b Middle Channel

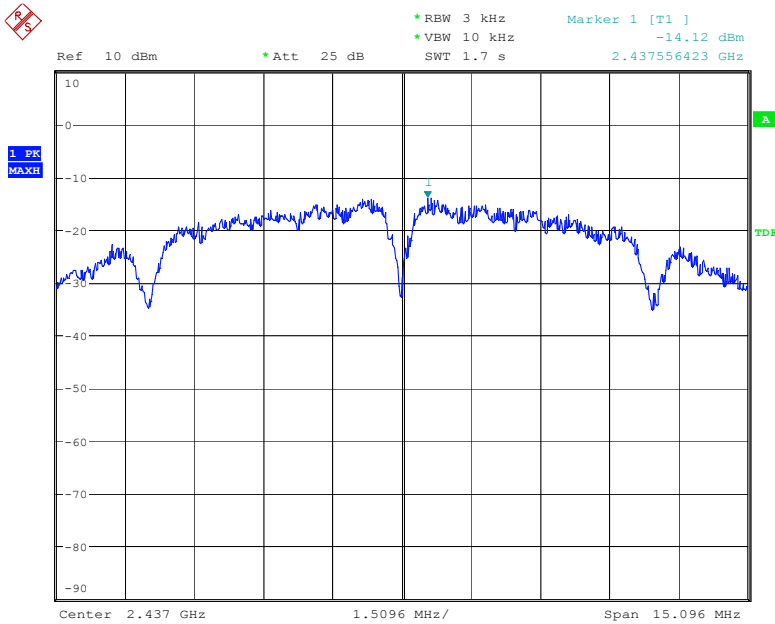

Date: 7.DEC.2016 14:21:50

802.11b High Channel

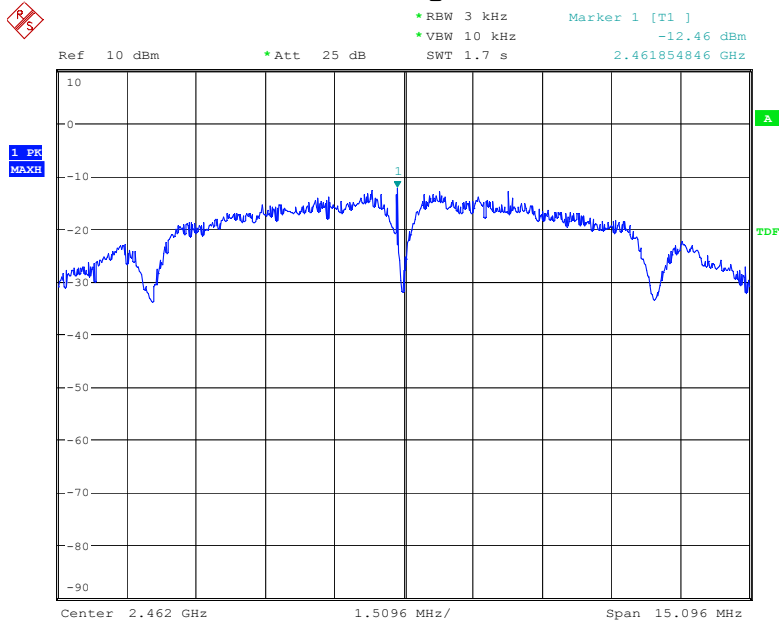

Date: 7.DEC.2016 14:24:37

802.11g Low Channel

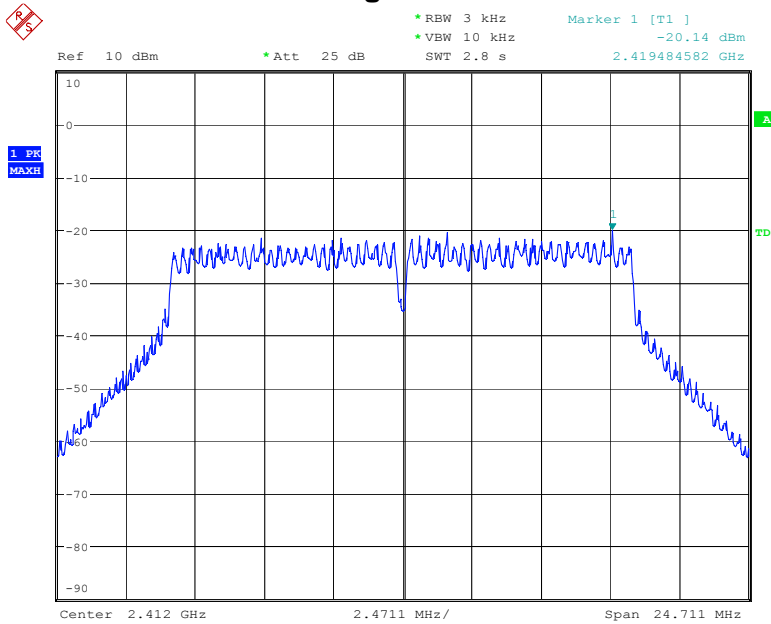

Date: 7.DEC.2016 14:25:28

802.11g Middle Channel

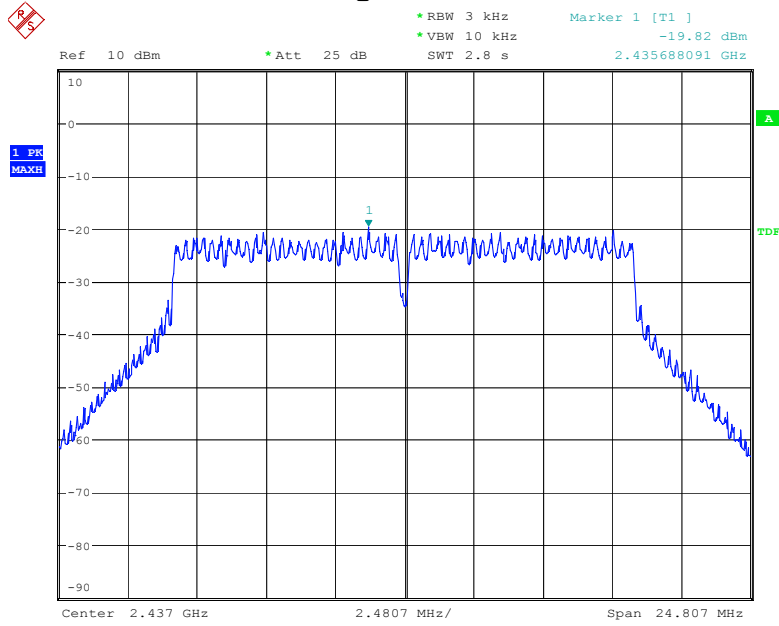

Date: 7.DEC.2016 14:26:21

802.11g High Channel

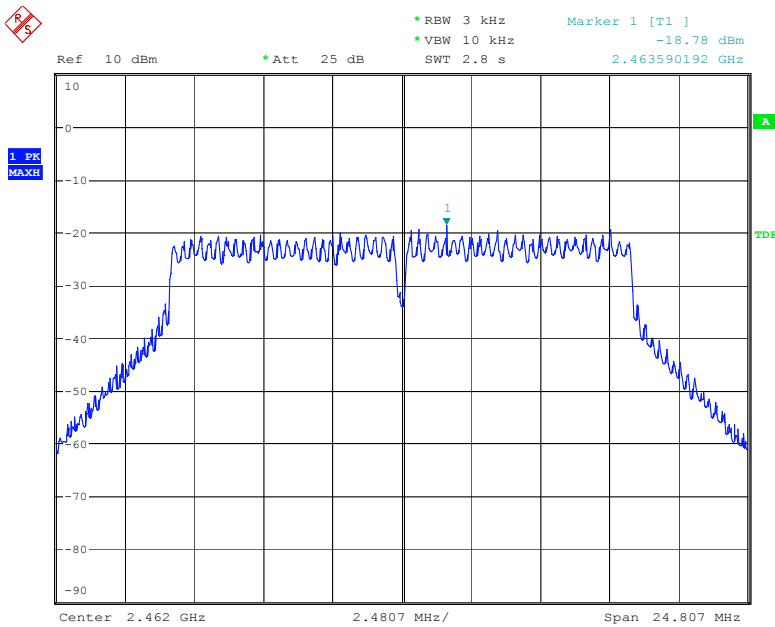

Date: 7.DEC.2016 14:26:59

802.11n(HT20) Low Channel

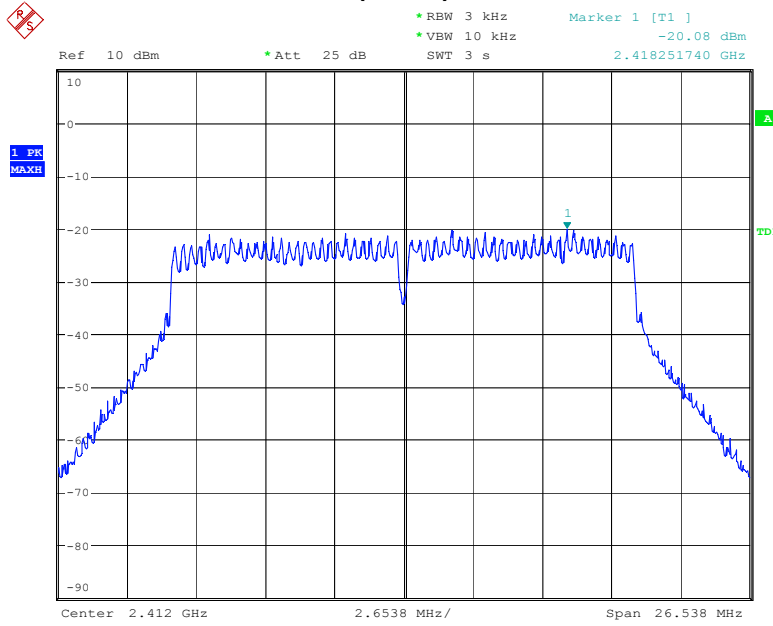

Date: 7.DEC.2016 14:28:31

802.11n(HT20) Middle Channel

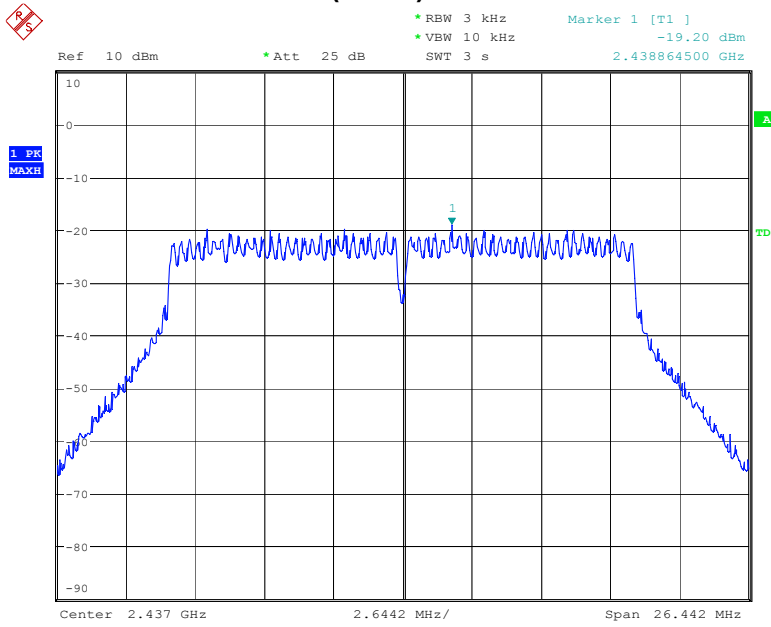

Date: 7.DEC.2016 14:29:28

802.11n(HT20) High Channel

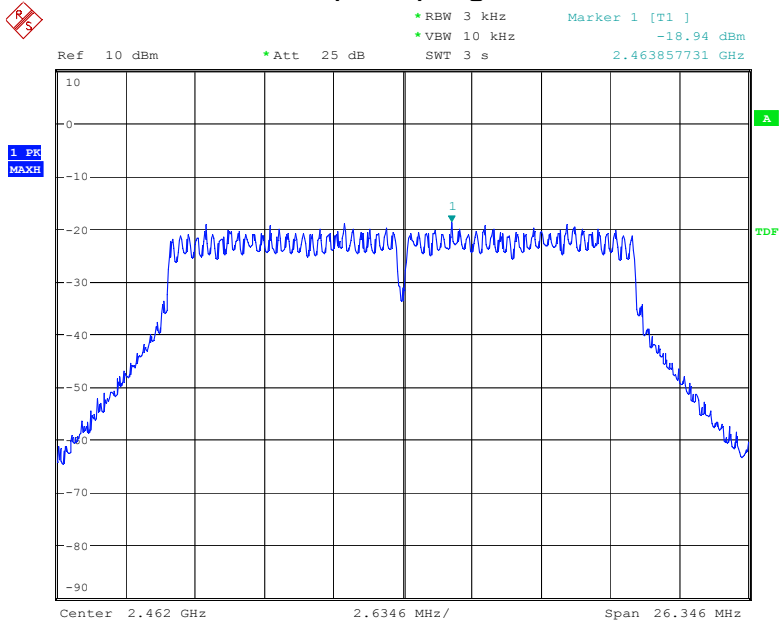

Date: 7.DEC.2016 14:32:07

802.11n(HT40) Low Channel

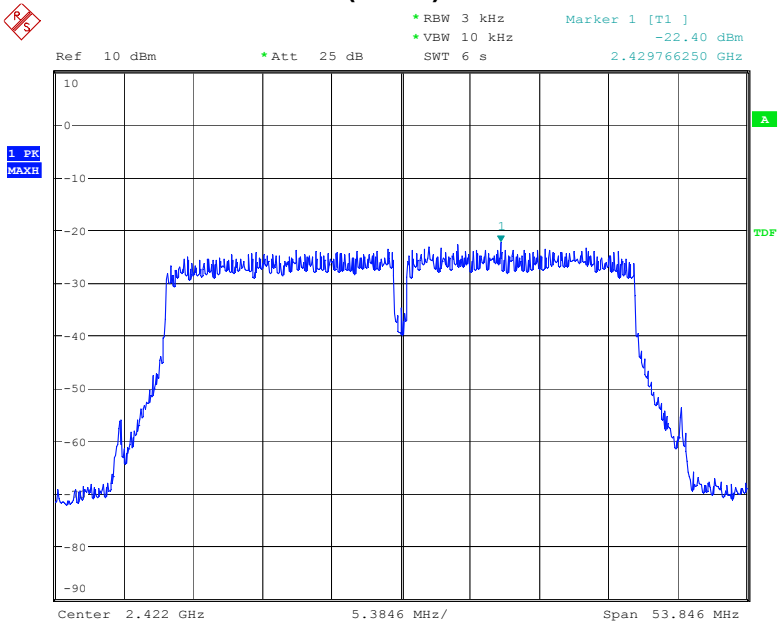

Date: 7.DEC.2016 14:33:25

802.11n(HT40) Middle Channel

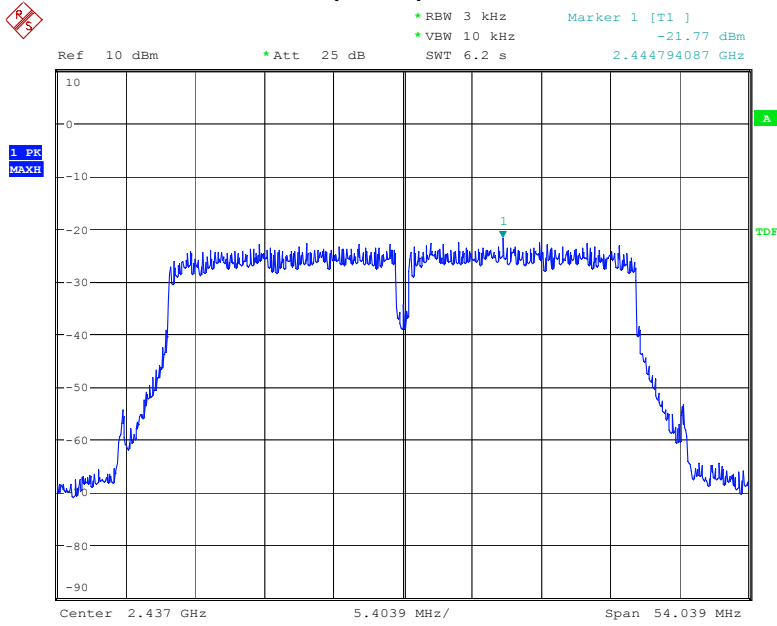

Date: 7.DEC.2016 14:34:29

802.11n(HT40) High Channel

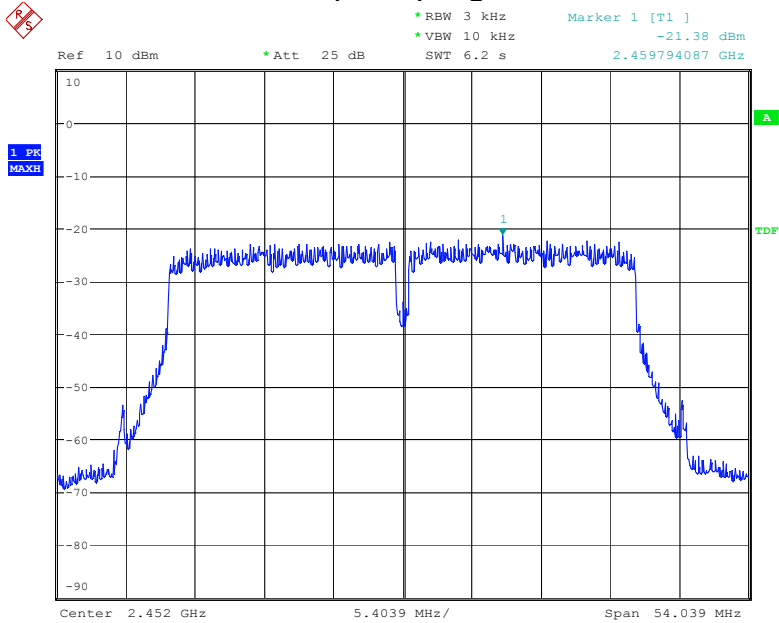

Date: 7.DEC.2016 14:35:58

7. Band Edge and Conducted Spurious Emissions

7.1 Requirement and Measurement Procedure

In any 100KHz bandwidth outside the frequency band in which the spread spectrum intentional radiator is operating, the radio frequency power that is produced by the intentional radiator shall be at least 20dB below that in the 100KHz bandwidth within the band that contains the highest level of the desired power, based on either an RF conducted or a radiated measurement.

The antenna port of the EUT was connected to the input of a spectrum analyzer. Analyzer was set as below.

A Quasi-peak measurement was then made for that frequency point for below 1GHz test. PK and AV for above 1GHz emission test.

During the radiated emission test, the spectrum analyzer was set with the following configurations:

Frequency Band (MHz)	Level	Resolution Bandwidth	Video Bandwidth
30 to 1000	QP	120 kHz	300 kHz
Above 1000	Peak	1 MHz	3 MHz
	Average	1 MHz	10 Hz

7.2 Test SET-UP (Block Diagram of Configuration)



7.3 Measurement Results

The test plots and table showed all spurious emission and up to the tenth harmonic was measured and they were found to be at least 20dB below the highest level of the desired power in the passband. Please refer to below plots.



Spurious Emission in restricted band:

Operation Mode: TX Test Date : December 08, 2016
 Frequency Range: Above 1GHz Temperature : 24 °C
 Test Result: PASS Humidity : 50 %
 Measured Distance: 3m Test By: Sance

Freq. (MHz)	Ant.Pol. (H/V)	Reading Level(dBuV)		Factor (dB/m)	Emission Level (dBuV)		Limit 3m (dBuV/m)		Margin (dB)	
		PK	AV		PK	AV	PK	AV	PK	AV
The worst case:										
Test Mode: 802.11b										
2390.000	H	35.55	23.31	8.06	43.61	31.37	74.00	54.00	-30.39	-22.63
2390.000	V	35.33	23.22	8.06	43.39	31.28	74.00	54.00	-30.61	-22.72
2483.500	H	40.07	28.19	8.36	48.43	36.55	74.00	54.00	-25.57	-17.45
2483.500	V	36.32	24.30	8.36	44.68	32.66	74.00	54.00	-29.32	-21.34

- Note:**
- (1) All Readings are Peak Value and AV.
 - (2) Emission Level= Reading Level+Probe Factor +Cable Loss
 - (3) Measurement uncertainty : ±3.7dB

Band Edge 802.11b Low Channel

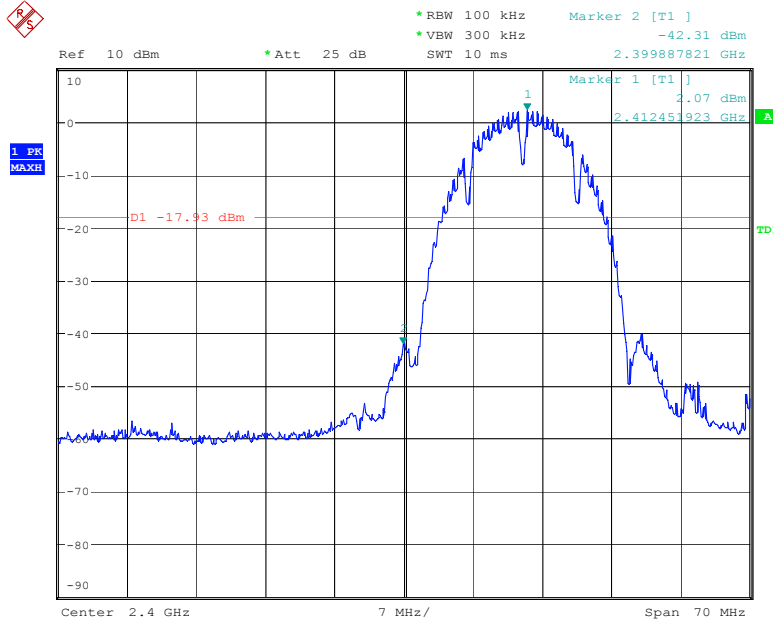

Date: 7.DEC.2016 14:38:10

802.11b High Channel

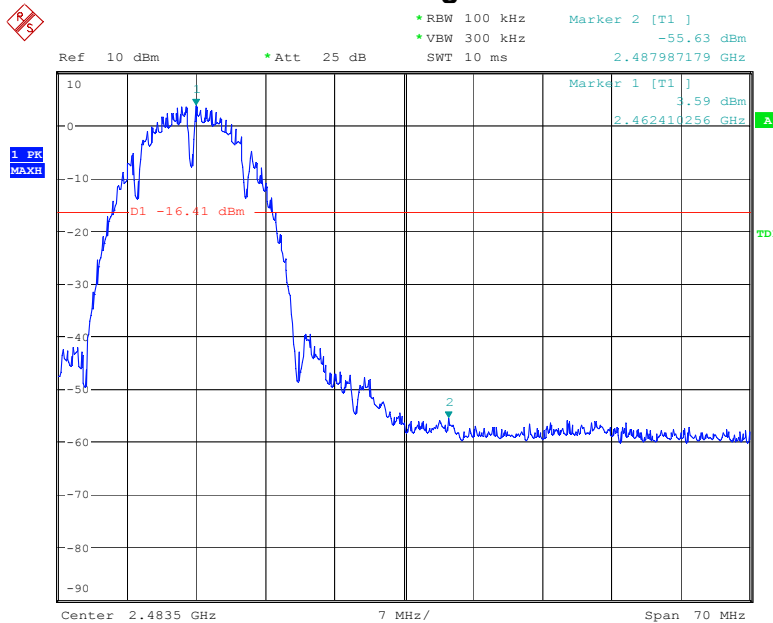

Date: 7.DEC.2016 14:39:27

802.11g Low Channel

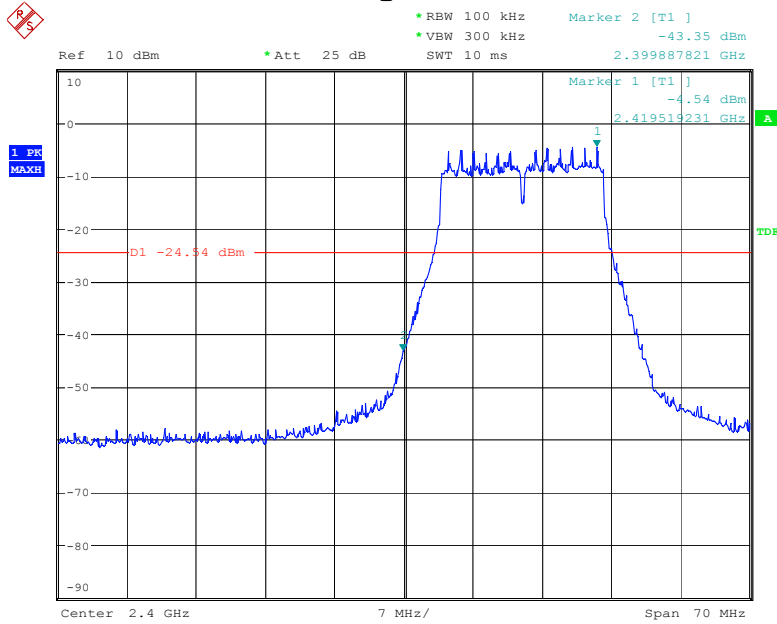

Date: 7.DEC.2016 14:41:24

802.11g High Channel

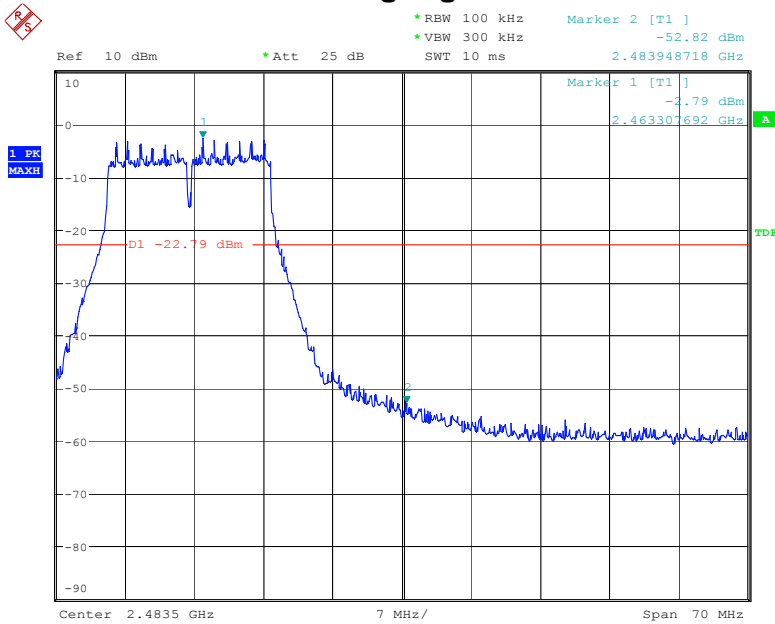

Date: 7.DEC.2016 14:43:23

802.11n(HT20) Low Channel

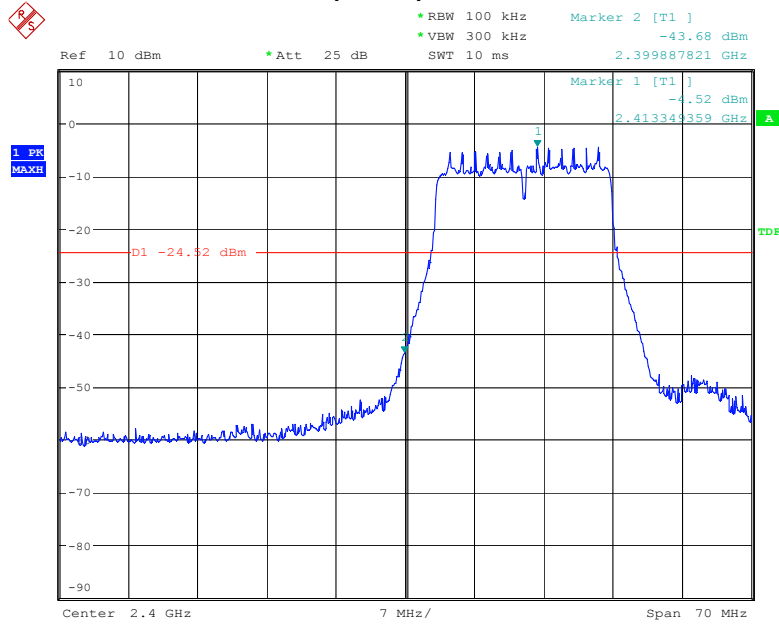

Date: 7.DEC.2016 14:45:00

802.11n(HT20) High Channel

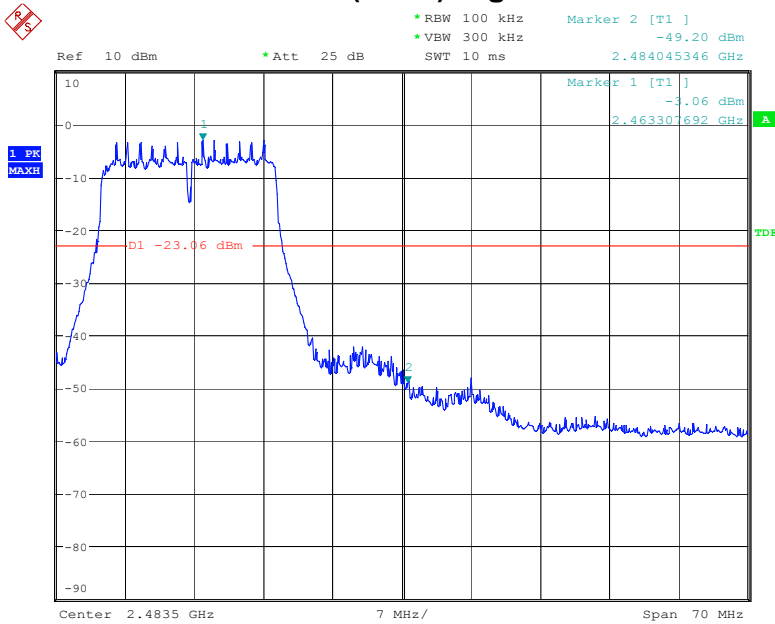

Date: 7.DEC.2016 14:48:49

802.11n(HT40) Low Channel

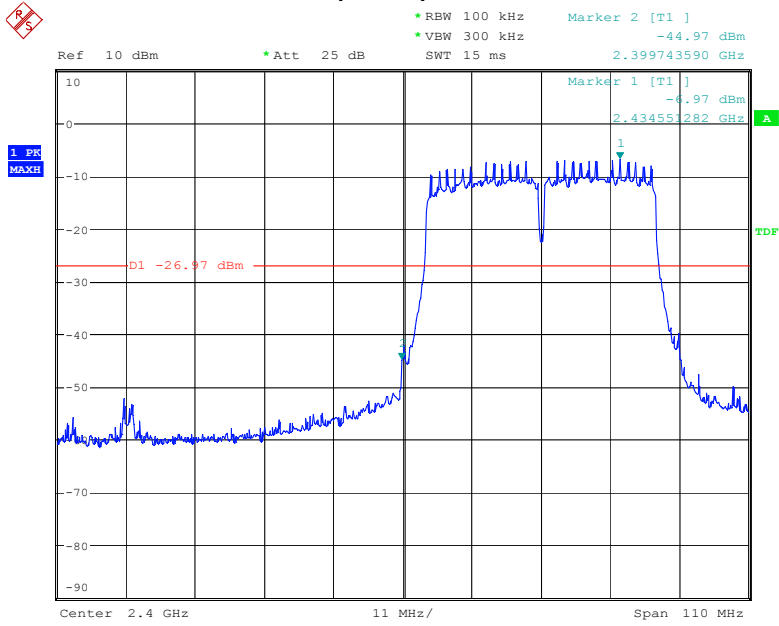

Date: 7.DEC.2016 14:50:21

802.11n(HT40) High Channel

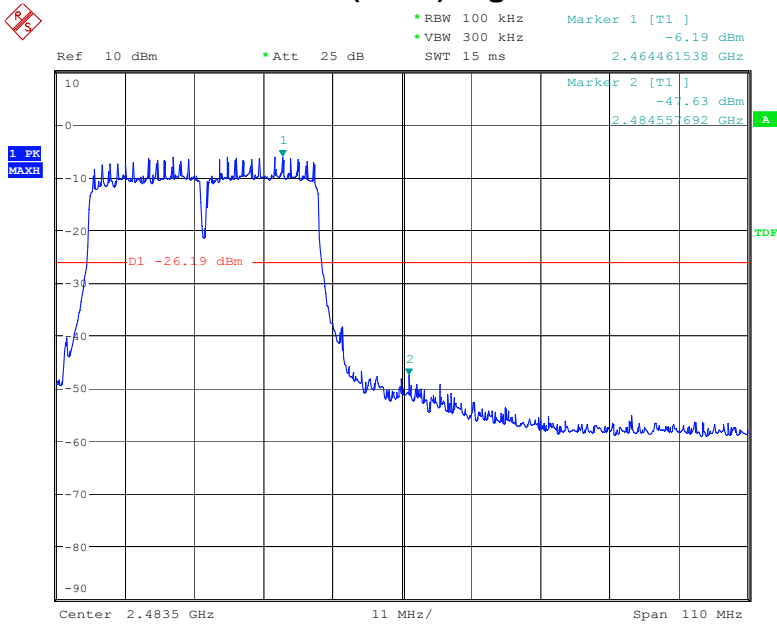

Date: 7.DEC.2016 14:54:37

Conducted Spurious Emissions The worst case: 802.11b Low Channel

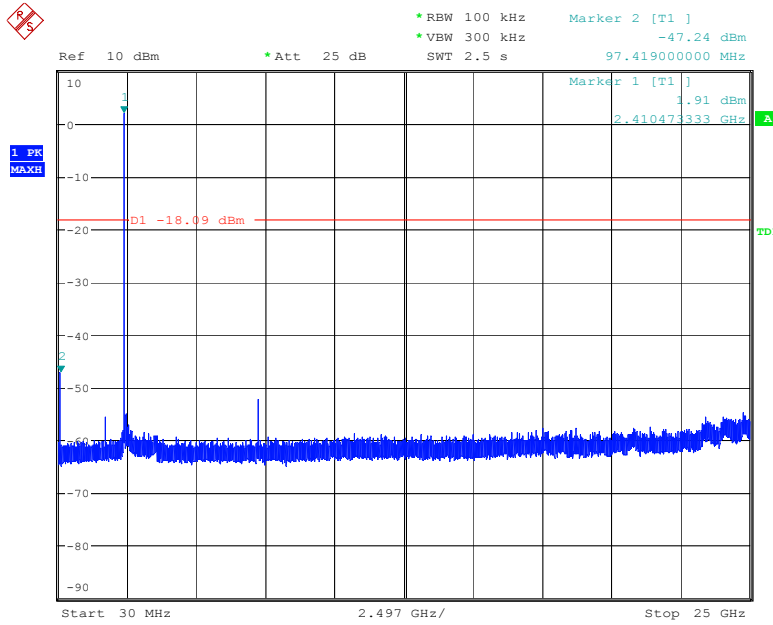

Date: 7.DEC.2016 14:58:21

Middle Channel

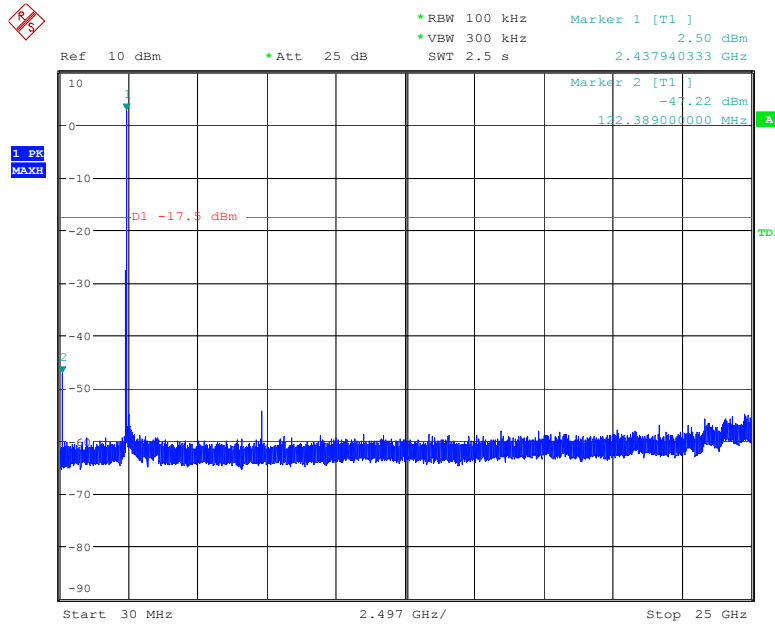

Date: 7.DEC.2016 15:00:20

High Channel

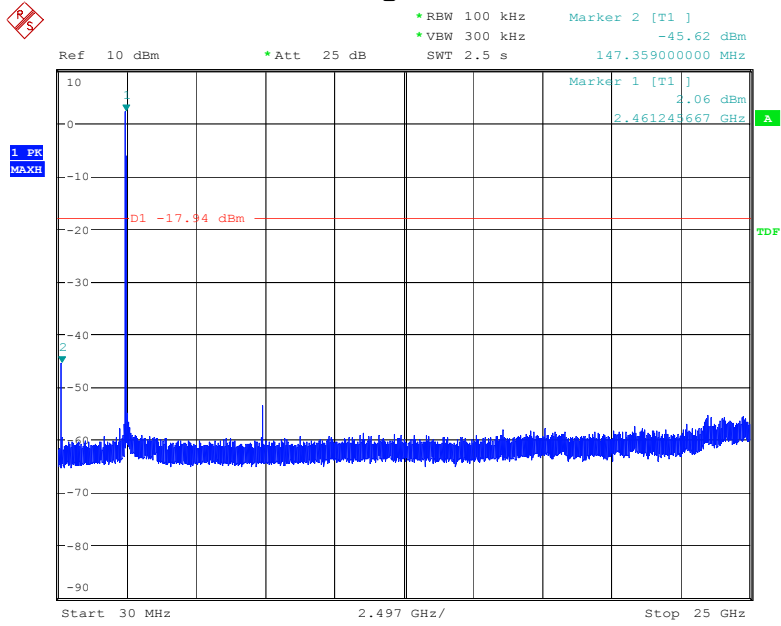

Date: 7.DEC.2016 15:02:02

Note: Sweep points=30001pts

8. Radiated Spurious Emissions and Restricted Bands

8.1 Test SET-UP (Block Diagram of Configuration)

8.1.1 Radiated Emission Test Set-Up, Frequency Below 30MHz

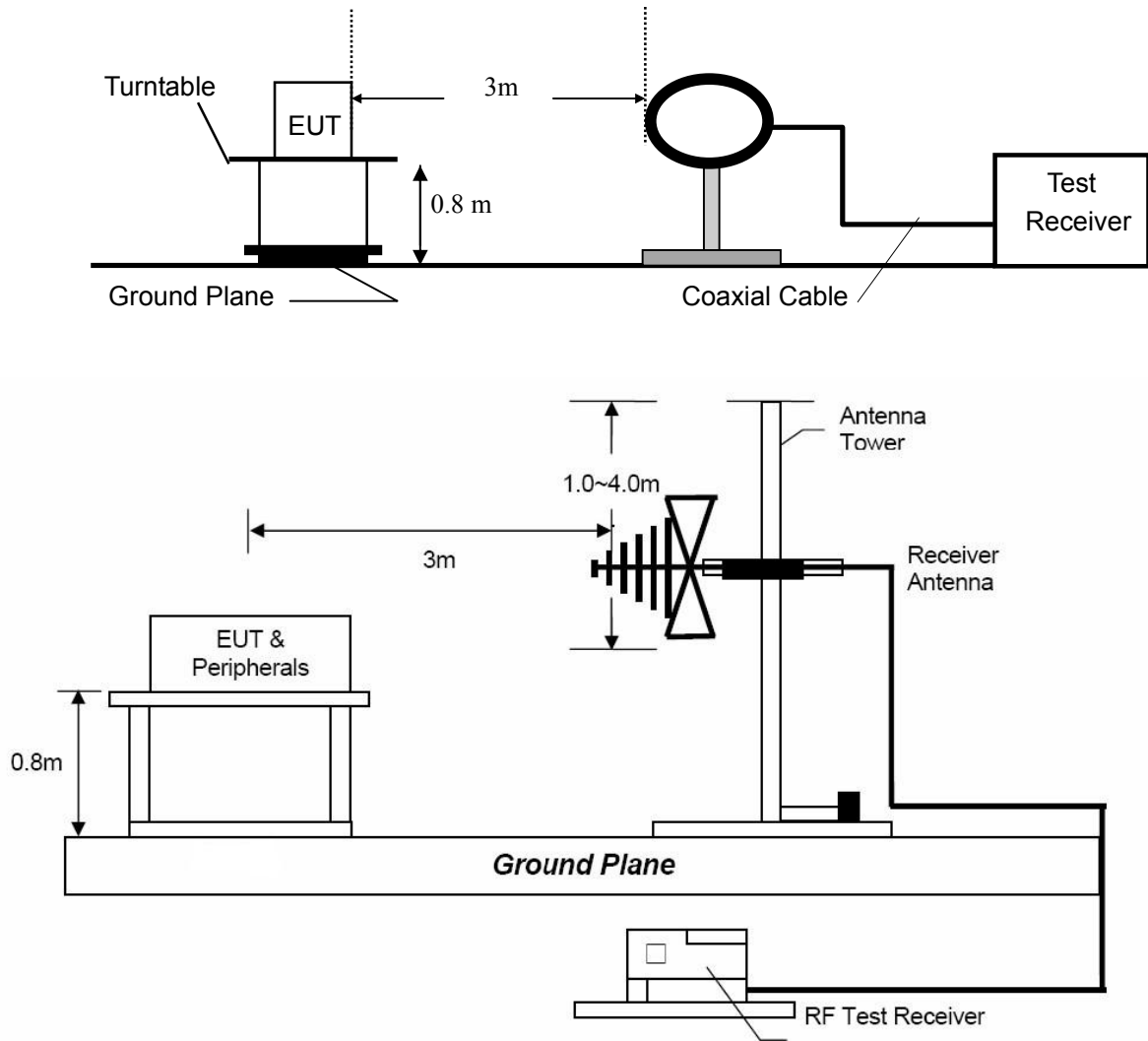

8.1.2 Radiated Emission Test Set-Up, Frequency above 1GHz

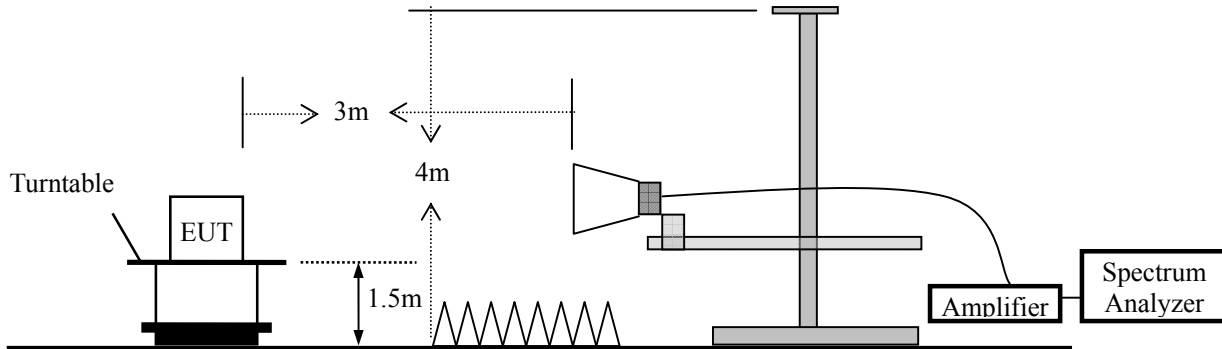

8.2 Measurement Procedure

- Blow 1GHz, the EUT was placed on the top of a rotating table 0.8 meters above the ground at a 3 meter semi- anechoic chamber room.
- For the radiated emission test above 1GHz:
The EUT was placed on the top of a rotating table 1.5 meters above the ground at a 3 meter full anechoic chamber room. The table was rotated 360 degrees to determine the position of the highest radiation. Place the measurement antenna away from each area of the EUT determined to be a source of emissions at the specified measurement distance, while keeping the measurement antenna aimed at the source of emissions at each frequency of significant emissions, with polarization oriented for maximum response. The measurement antenna may have to be higher or lower than the EUT, depending on the radiation pattern of the emission and staying aimed at the emission source for receiving the maximum signal. The final measurement antenna elevation shall be that which maximizes the emissions. The measurement antenna elevation for maximum emissions shall be restricted to a range of heights of from 1 m to 4 m above the ground or reference ground plane.
- The EUT was set 3 meters away from the interference-receiving antenna, which was mounted on the top of a variable-height antenna tower.
- The height of antenna is varied from one meter to four meters above the ground to determine the maximum value of the field strength. Both horizontal and vertical polarizations of the antenna are set to make the measurement.
- For each suspected emission, the EUT was arranged to its worst case and then the antenna was tuned to heights from 1 meter to 4 meters and the rotatable table was turned from 0 degrees to 360 degrees to find the maximum reading. The test-receiver system was set to peak detect function and specified bandwidth with maximum hold mode.
- A Quasi-peak measurement was then made for that frequency point for below 1GHz test. PK and AV for above 1GHz emission test.

During the radiated emission test, the spectrum analyzer was set with the following configurations:

Frequency Band (MHz)	Level	Resolution Bandwidth	Video Bandwidth
30 to 1000	QP	120 kHz	300 kHz
Above 1000	Peak	1 MHz	3 MHz
	Average	1 MHz	10 Hz

8.3 Limit

Frequency range MHz	Distance Meters	Field Strengths Limit (15.209)
		$\mu\text{V/m}$
0.009 ~ 0.490	300	$2400/F(\text{kHz})$
0.490 ~ 1.705	30	$24000/F(\text{kHz})$
1.705 ~ 30	30	30
30 ~ 88	3	100
88 ~ 216	3	150
216 ~ 960	3	200
Above 960	3	500

- Remark :
- (1) Emission level (dB) $\mu\text{V} = 20 \log$ Emission level $\mu\text{V/m}$
 - (2) The smaller limit shall apply at the cross point between two frequency bands.
 - (3) As shown in 15.35(b), for frequencies above 1000MHz, the field strength limits are based on average detector, however, the peak field strength of any emission shall not exceed the maximum permitted average limits, specified above by more than 20dB under any condition of modulation.
 - (4) The frequency range scanned is from the lowest radio frequency signal generated in the device which is greater than 9 kHz to the tenth harmonic of the highest fundamental frequency or 40 GHz, whichever is lower.
 - (5) §15.247(d) specifies that emissions which fall in the restricted bands, as defined in §15.205 comply with radiated emission limits specified in §15.209.

8.4 Measurement Results

Please refer to following plots of the worst case: 802.11b High channel.

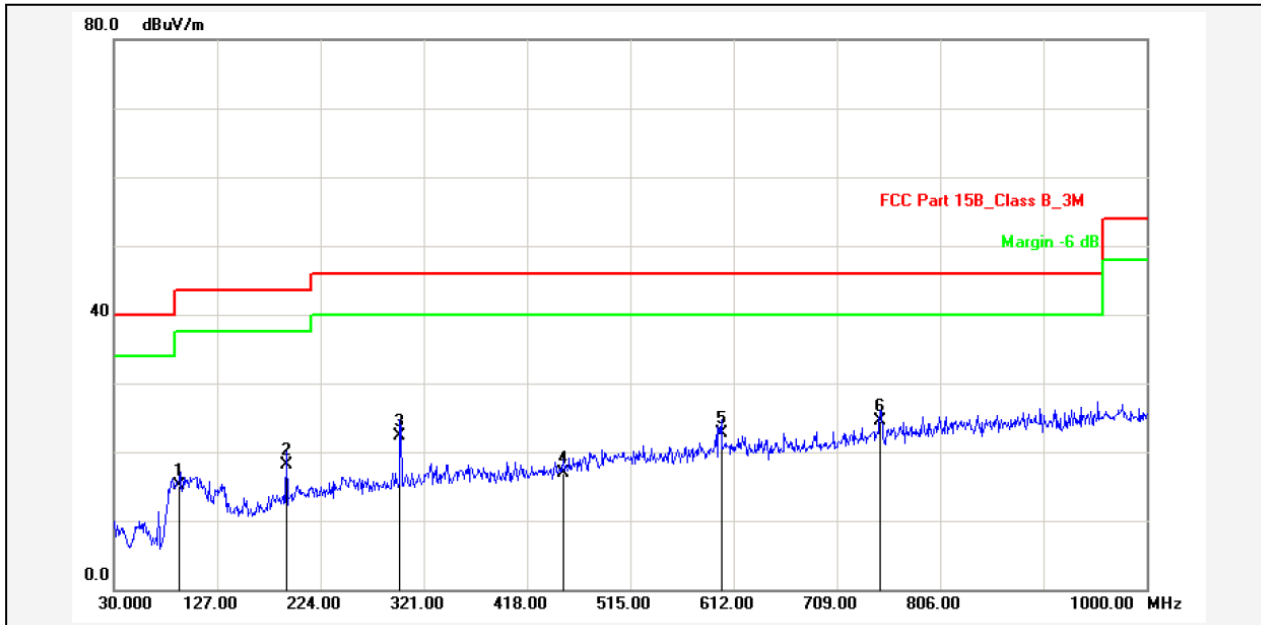

Report No.:	F11AMIM13-B1	Test Distance:	3m
Test Standard:	FCC Part 15B_Class B_3M	Ant. Polarization:	Horizontal
Test item:	Radiation Emission	Temp.(C)/Hum.(%):	22(C) / 54 %
Applicant:	FN-LINK	Power Rating:	AC 120V/60Hz
Product:	WIFI Module	Test Engineer:	Chilam
Model No.:	F11AMIM13-B1		
Test Mode:	WiFi Mode		
Remark:			

No.	Frequency (MHz)	Factor (dB/m)	Reading (dBuV)	Level (dBuV/m)	Limit (dBuV/m)	Margin (dB)	Detector	Height (cm)	Azimuth (deg.)	P/F	Remark
1	92.0799	-13.45	28.55	15.10	43.50	-28.40	QP			P	
2	191.9900	-13.51	31.71	18.20	43.50	-25.30	QP			P	
3	298.6899	-10.50	32.80	22.30	46.00	-23.70	QP			P	
4	451.9499	-7.92	24.82	16.90	46.00	-29.10	QP			P	
5	600.3600	-5.00	27.70	22.70	46.00	-23.30	QP			P	
6	749.7400	-2.59	27.09	24.50	46.00	-21.50	QP			P	

Note: Below 30MHz, the emissions are lower than 20dB below the allowable limit.

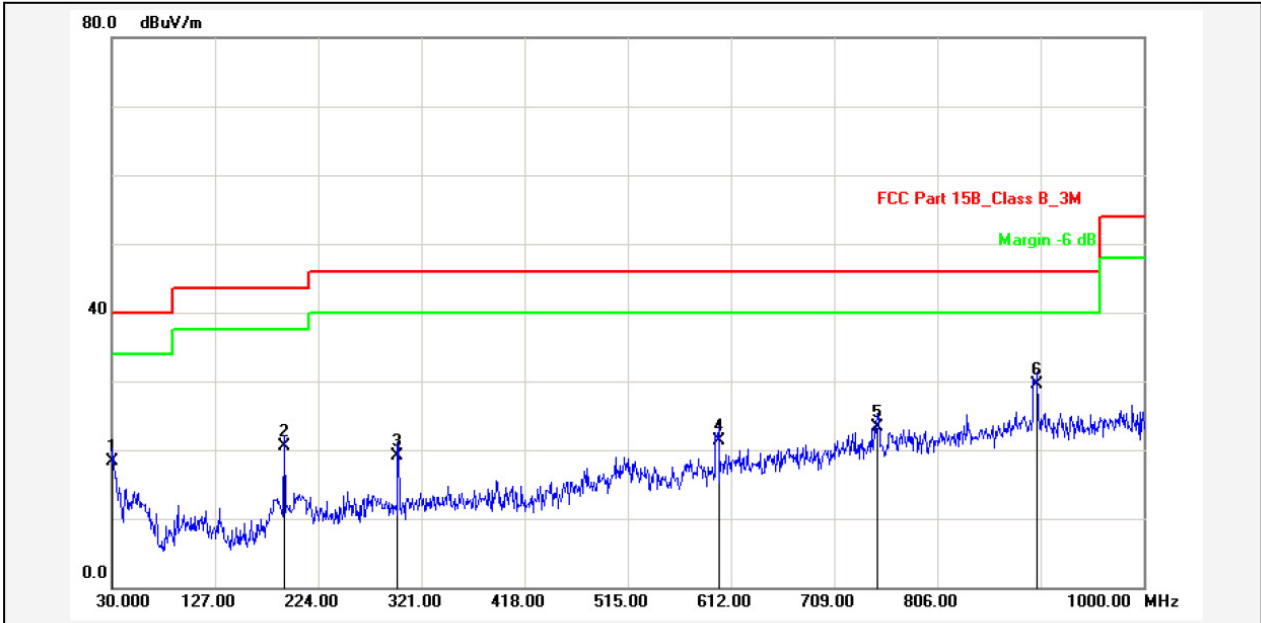

Report No.:	F11AMIM13-B1	Test Standard:	FCC Part 15B_Class B_3M	Test Distance:	3m
Test item:	Radiation Emission	Ant. Polarization:	Vertical	Temp.(C)/Hum.(%):	22(C) / 54 %
Applicant:	FN-LINK	Power Rating:	AC 120V/60Hz	Test Engineer:	Chilam
Product:	WIFI Module	Test Mode: WiFi Mode			
Model No.:	F11AMIM13-B1	Remark:			

No.	Frequency (MHz)	Factor (dB/m)	Reading (dBuV)	Level (dBuV/m)	Limit (dBuV/m)	Margin (dB)	Detector	Height (cm)	Azimuth (deg.)	P/F	Remark
1	30.9699	-15.83	34.13	18.30	40.00	-21.70	QP			P	
2	191.9900	-16.51	37.11	20.60	43.50	-22.90	QP			P	
3	298.6899	-12.50	31.70	19.20	46.00	-26.80	QP			P	
4	600.3600	-7.00	28.40	21.40	46.00	-24.60	QP			P	
5	749.7400	-2.59	25.89	23.30	46.00	-22.70	QP			P	
6	900.0900	-1.23	30.73	29.50	46.00	-16.50	QP			P	

Note: Below 30MHz, the emissions are lower than 20dB below the allowable limit.



Test Mode: The worst case: Test Date : December 08, 2016
 802.11b
 Frequency Range: Above 1GHz Temperature : 24°C
 Test Result: PASS Humidity : 50 %
 Measured Distance: 3m Test By: Sance

Freq. (MHz)	Ant.Pol. (H/V)	Reading Level(dBuV)		Factor (dB/m)	Emission Level (dBuV)		Limit 3m (dBuV/m)		Margin (dB)	
		PK	AV		PK	AV	PK	AV	PK	AV
Operation Mode: TX Mode (Low)										
4824	V	38.36	26.49	14.72	53.08	41.21	74.00	54.00	-20.92	-12.79
7236	V	35.37	23.81	20.74	56.11	44.55	74.00	54.00	-17.89	-9.45

4824	H	37.64	26.46	14.72	52.36	41.18	74.00	54.00	-21.64	-12.82
7236	H	35.79	23.38	20.74	56.53	44.12	74.00	54.00	-17.47	-9.88

Operation Mode: TX Mode (Mid)										
4874	V	38.22	27.25	14.93	53.15	42.18	74.00	54.00	-20.85	-11.82
7311	V	35.68	24.71	20.88	56.56	45.59	74.00	54.00	-17.44	-8.41

4874	H	37.93	27.04	14.93	52.86	41.97	74.00	54.00	-21.14	-12.03
7311	H	34.94	23.92	20.88	55.82	44.80	74.00	54.00	-18.18	-9.20

Operation Mode: TX Mode (High)										
4924	V	38.26	28.44	15.15	53.41	43.59	74.00	54.00	-20.59	-10.41
7386	V	35.64	23.54	21.04	56.68	44.58	74.00	54.00	-17.32	-9.42

4924	H	38.31	26.41	15.15	53.46	41.56	74.00	54.00	-20.54	-12.44
7386	H	36.19	24.09	21.04	57.23	45.13	74.00	54.00	-16.77	-8.87

- Note:**
- (1) All Readings are Peak Value and AV.
 - (2) Emission Level= Reading Level + Factor
 - (3) Factor= Antenna Gain + Cable Loss – Amplifier Gain
 - (4) Data of measurement within this frequency range shown “ ---” in the table above means the reading of emissions are attenuated more than 10dB below the permissible limits.
 - (5) Measurement uncertainty : ±3.7dB.
 - (6) Horn antenna used for the emission over 1000MHz.

9. Antenna Application

9.1 Antenna requirement

According to of FCC part 15C section 15.203 and 15.240:

An intentional radiator shall be designed to ensure that no antenna other than that furnished by the responsible party shall be used with the device. The use of a permanently attached antenna or of an antenna that uses a unique coupling to the intentional radiator, the manufacturer may design the unit so that a broken antenna can be replaced by the user, but the use of a standard antenna jack or electrical connector is prohibited.

Systems operating in the 2400-2483.5MHz band that are used exclusively for fixed, point-to-point operations may employ transmitting antennas with directional gain greater than 6dBi provided the maximum peak output power of the intentional radiator is reduced by 1dB for every 3dB that the directional gain of the antenna exceeds 6dBi.

9.2 Measurement Results

The antenna is PCB antenna and no consideration of replacement, and the best case gain of the antenna is 0dBi. So, the antenna is consider meet the requirement.

10. Test Equipment List

Description	Manufacturer	Model Number	Serial Number	Characteristics	Calibration Date	Calibration Due Date
Test Receiver	Rohde & Schwarz	ESCI7	100837	9KHz~7GHz	Nov. 22, 2016	Nov. 21, 2017
Antenna	Schwarzbeck	VULB9162	9162-010	30MHz~7GHz	Nov. 25, 2016	Nov. 24, 2017
Positioning Controller	UC	UC 3000	N/A	0~360° , 1-4m	N/A	N/A
Color Monitor	SUNSP0	SP-140A	N/A	N/A	N/A	N/A
Single Phase Power Line Filter	SAEMC	PF201A-32	110210	32A	N/A	N/A
3 Phase Power Line Filter	SAEMC	PF401A-200	110318	200A	N/A	N/A
DC Power Filter	SAEMC	PF301A-200	110245	200A	N/A	N/A
Cable	Huber+Suhner	CBL2-NN-1M	22390001	9KHz~7GHz	Nov. 06, 2016	Nov. 05, 2017
Cable	Huber+Suhner	CIL02	N/A	9KHz~7GHz	Nov. 06, 2016	Nov. 05, 2017
RF Cable	Huber+Suhner	SF-104	MY16559/4	9KHz~25GHz	Mar. 06, 2016	Mar. 05, 2017
Power Amplifier	HP	HP 8447D	1145A00203	100KHz~1.3GHz	Nov. 06, 2016	Nov. 05, 2017
Horn Antenna	Schwarzbeck	BBHA9170	9170-372	15GHz~26.5GHz	Oct.22, 2016	Oct.21, 2017
Horn Antenna	Com-Power	AH-118	071078	1GHz~18GHz	Nov. 04, 2016	Nov. 03, 2017
Loop antenna	Daze	ZA30900A	0708	9KHz~30MHz	Oct.09, 2016	Oct.08, 2017
Spectrum Analyzer	Rohde & Schwarz	FSU26	200409/026	20Hz~26.5GHz	Aug. 31, 2016	Aug. 30, 2017
Pre-Amplifier	Agilent	8449B	3008A02964	1GHz~26.5GHz	Nov. 02, 2016	Nov. 01, 2017
L.I.S.N.	Rohde & Schwarz	ENV 216	101317	9KHz~30MHz	Nov. 06, 2016	Nov. 07, 2017
Temporary antenna connector	TESCOM	SS402	N/A	9KHz-25GHz	N/A	N/A
Power Meter	Anritsu	ML2495A	1139001	100k-65GHz	Nov. 04, 2016	Nov. 03, 2017
Power Sensor	Anritsu	MA2411B	100345	300M-40GHz	Nov. 04, 2016	Nov. 03, 2017

Note: The temporary antenna connector is soldered on the PCB board in order to perform conducted tests and this temporary antenna connector is listed in the equipment list.

---End---