

Conducted RF Spurious Emission

Tx. Spurious NVNT 1-DH1 2402MHz Ant1 Ref

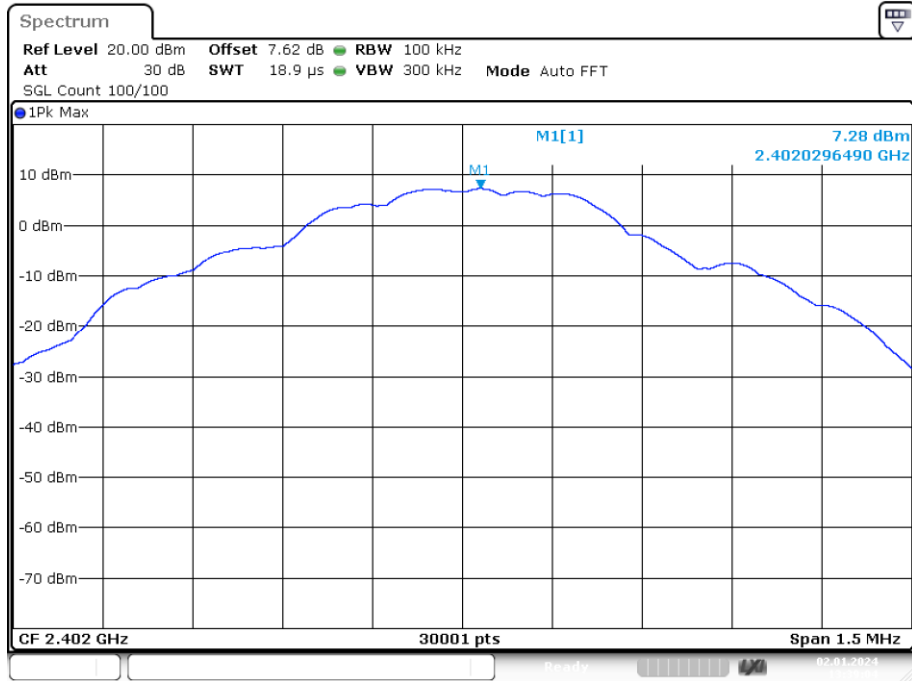

Date: 2.JAN.2024 13:39:04

Tx. Spurious NVNT 1-DH1 2402MHz Ant1 Emission

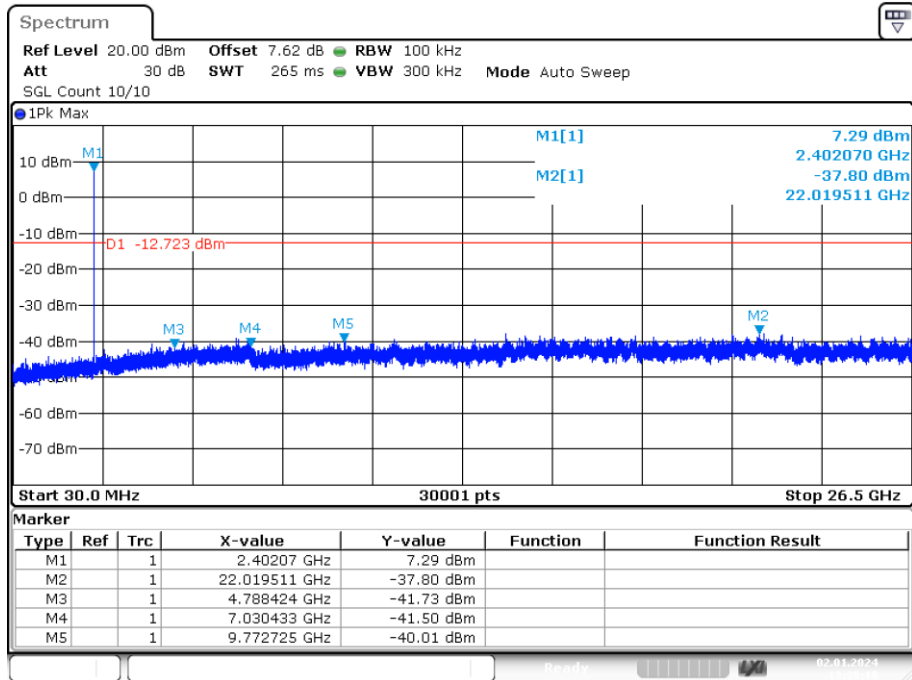

Date: 2.JAN.2024 13:39:18

Tx. Spurious NVNT 1-DH1 2441MHz Ant1 Ref

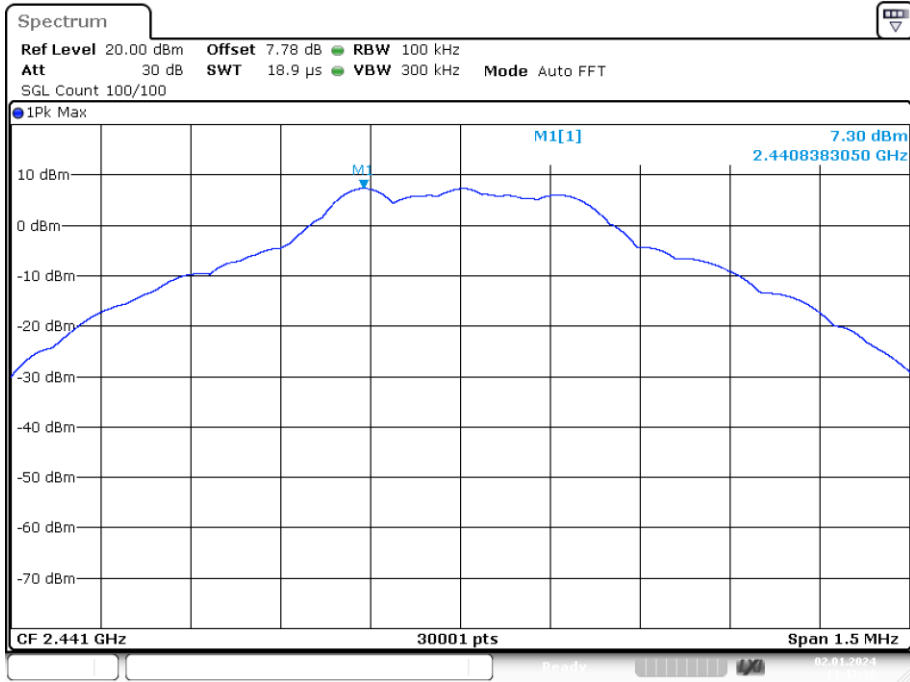

Date: 2.JAN.2024 13:43:38

Tx. Spurious NVNT 1-DH1 2441MHz Ant1 Emission

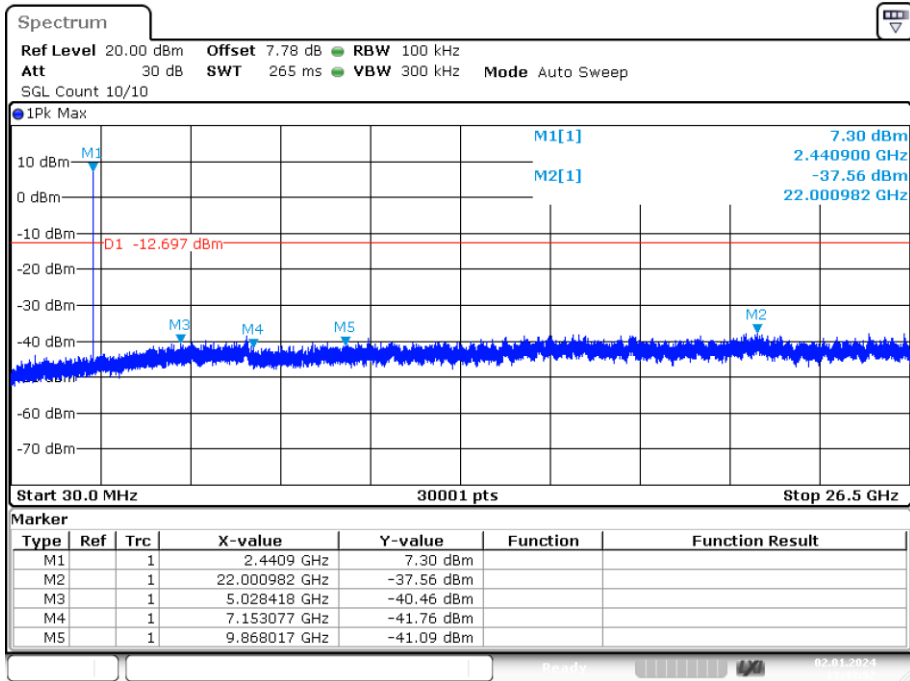

Date: 2.JAN.2024 13:43:51

Tx. Spurious NVNT 1-DH1 2480MHz Ant1 Ref

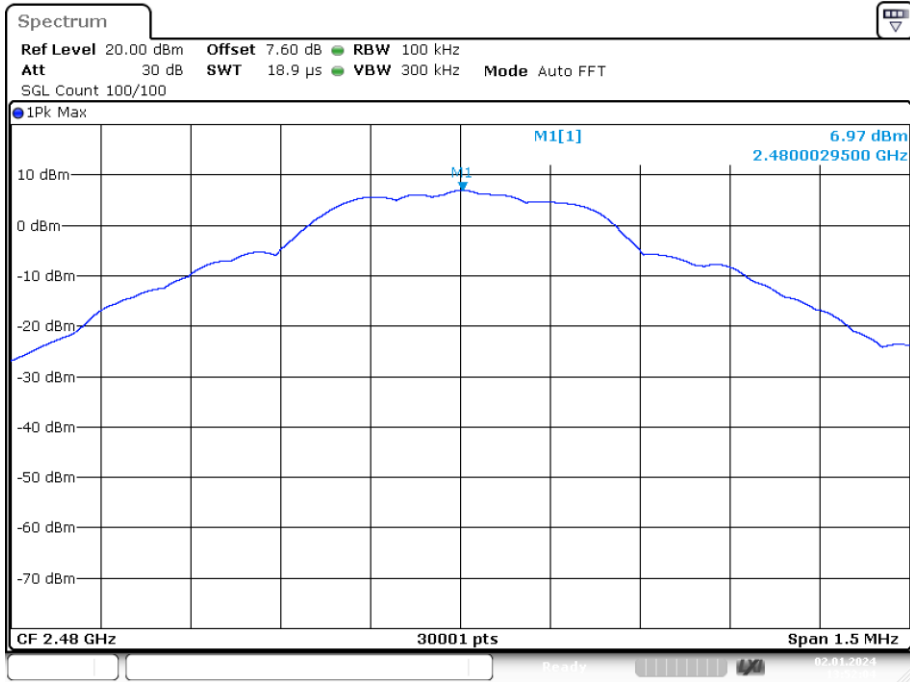

Date: 2.JAN.2024 13:52:04

Tx. Spurious NVNT 1-DH1 2480MHz Ant1 Emission

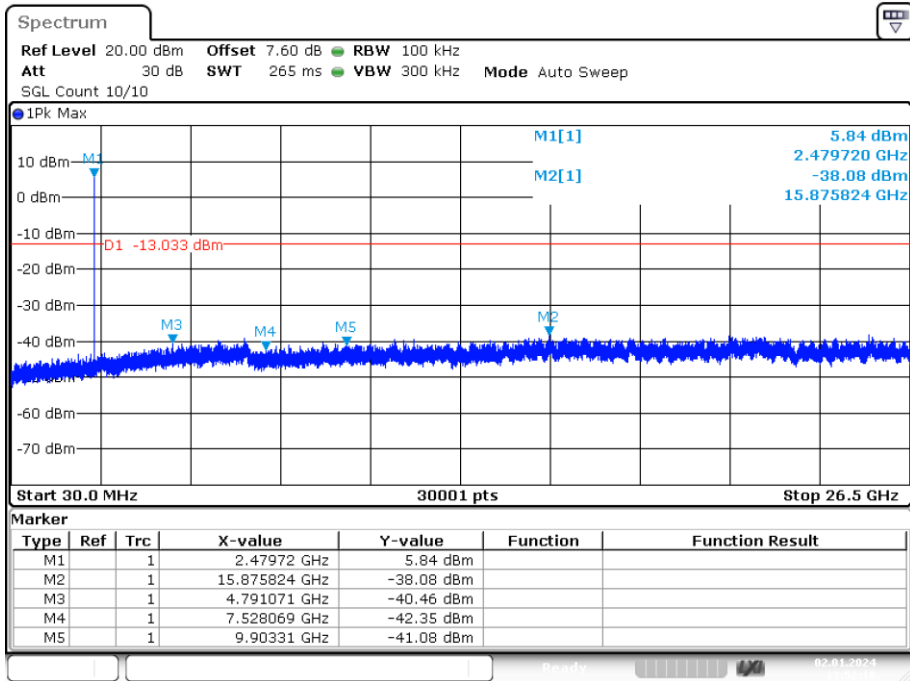

Date: 2.JAN.2024 13:52:18

Tx. Spurious NVNT 2-DH1 2402MHz Ant1 Ref

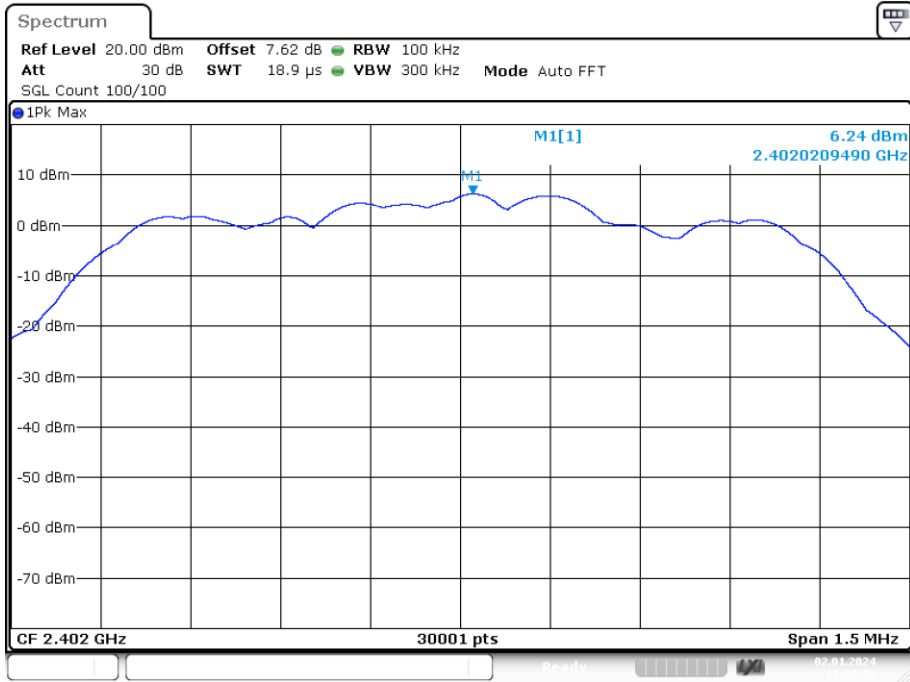

Date: 2.JAN.2024 11:28:06

Tx. Spurious NVNT 2-DH1 2402MHz Ant1 Emission

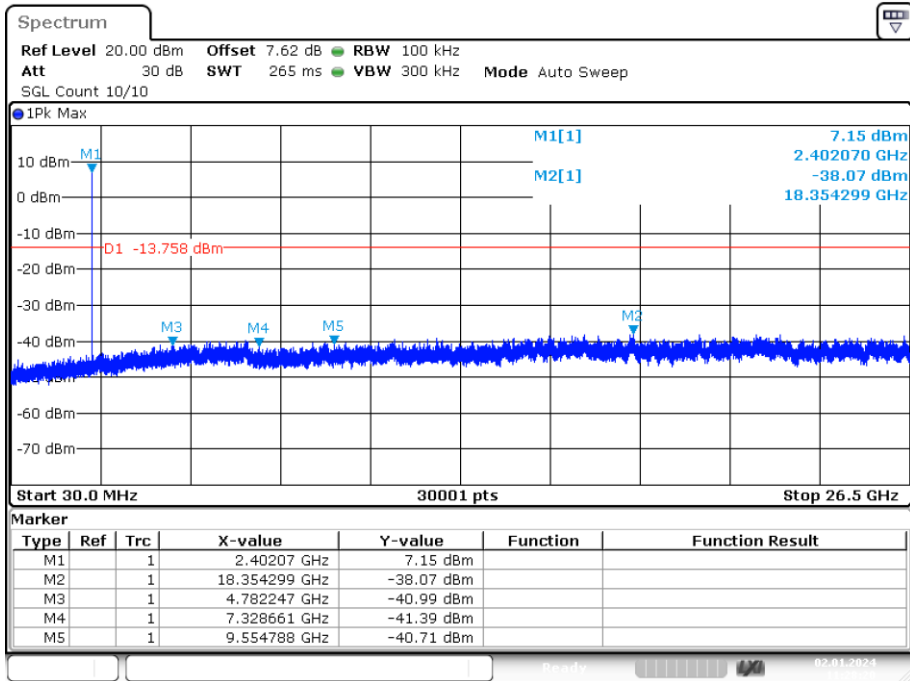

Date: 2.JAN.2024 11:28:20

Tx. Spurious NVNT 2-DH1 2441MHz Ant1 Ref

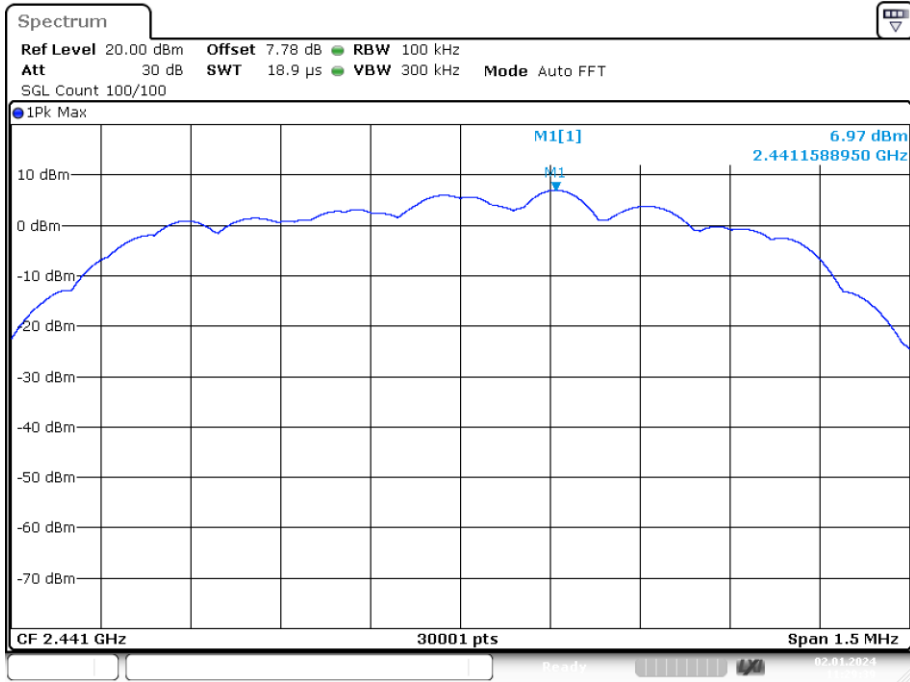

Date: 2.JAN.2024 11:29:39

Tx. Spurious NVNT 2-DH1 2441MHz Ant1 Emission

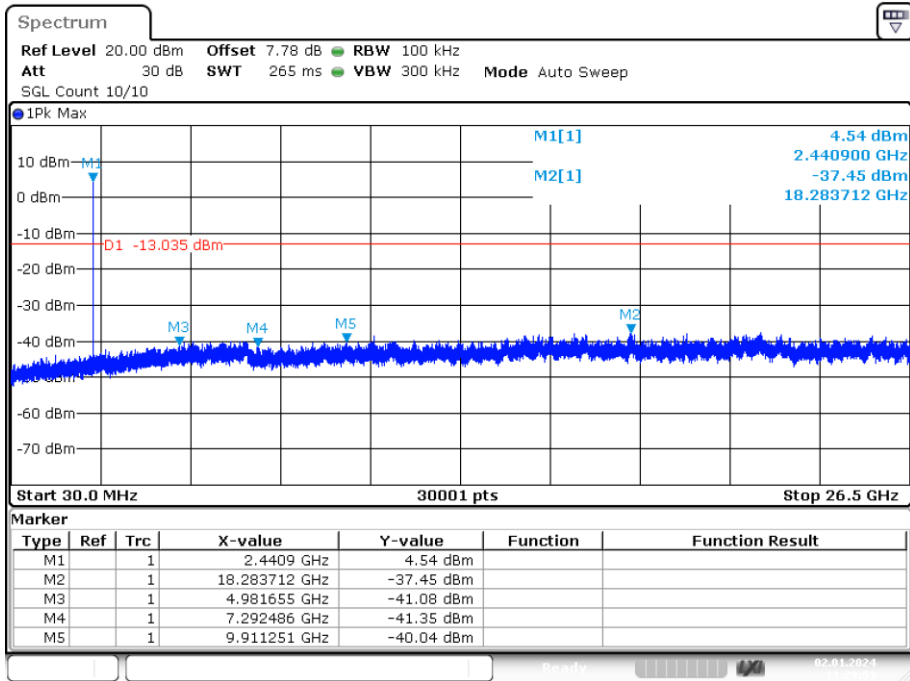

Date: 2.JAN.2024 11:29:53

Tx. Spurious NVNT 2-DH1 2480MHz Ant1 Ref

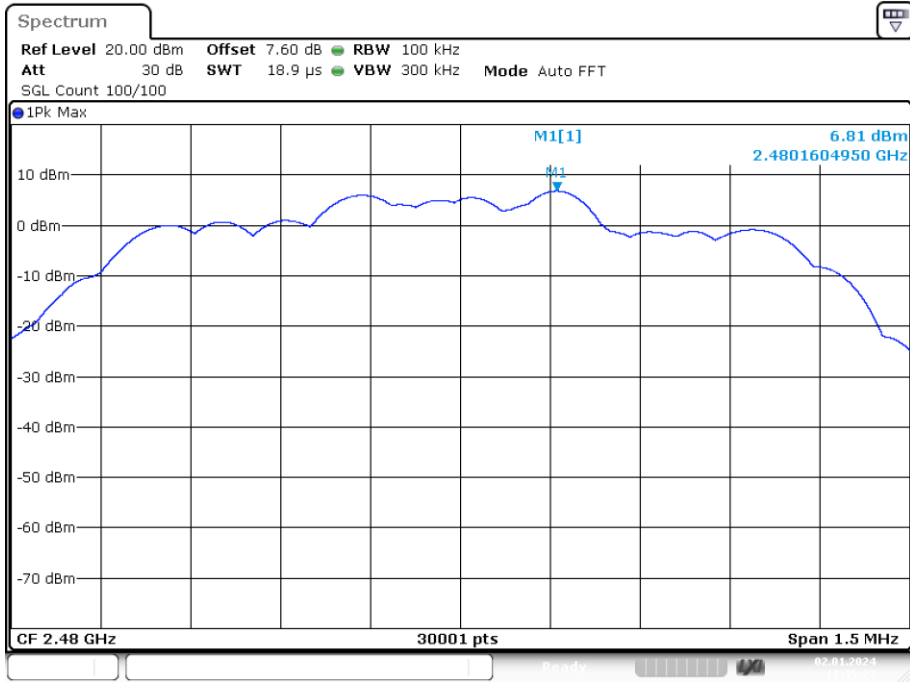

Date: 2.JAN.2024 11:35:23

Tx. Spurious NVNT 2-DH1 2480MHz Ant1 Emission

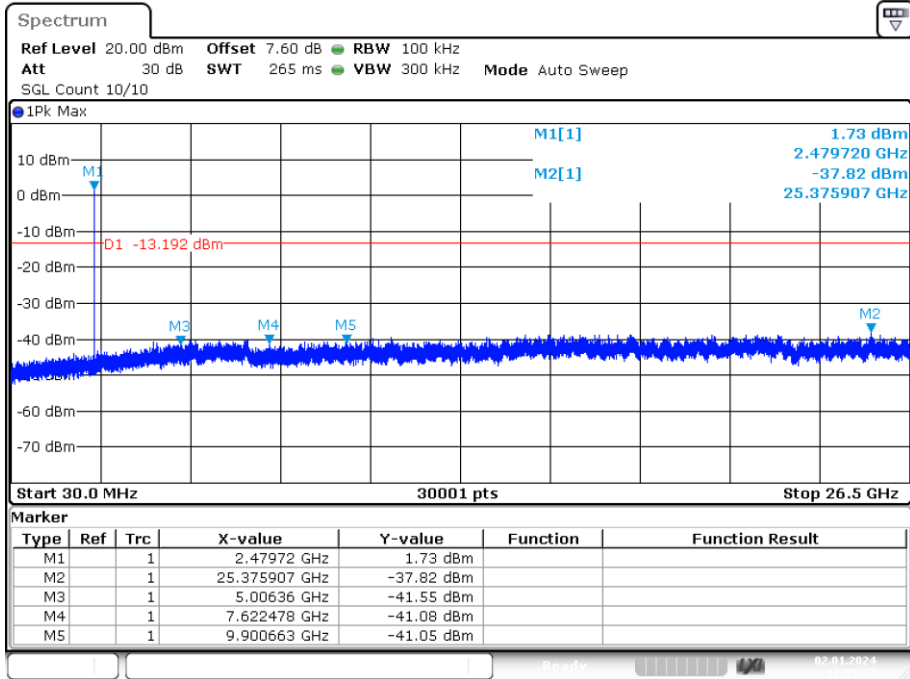

Date: 2.JAN.2024 11:35:36

Tx. Spurious NVNT 3-DH1 2402MHz Ant1 Ref

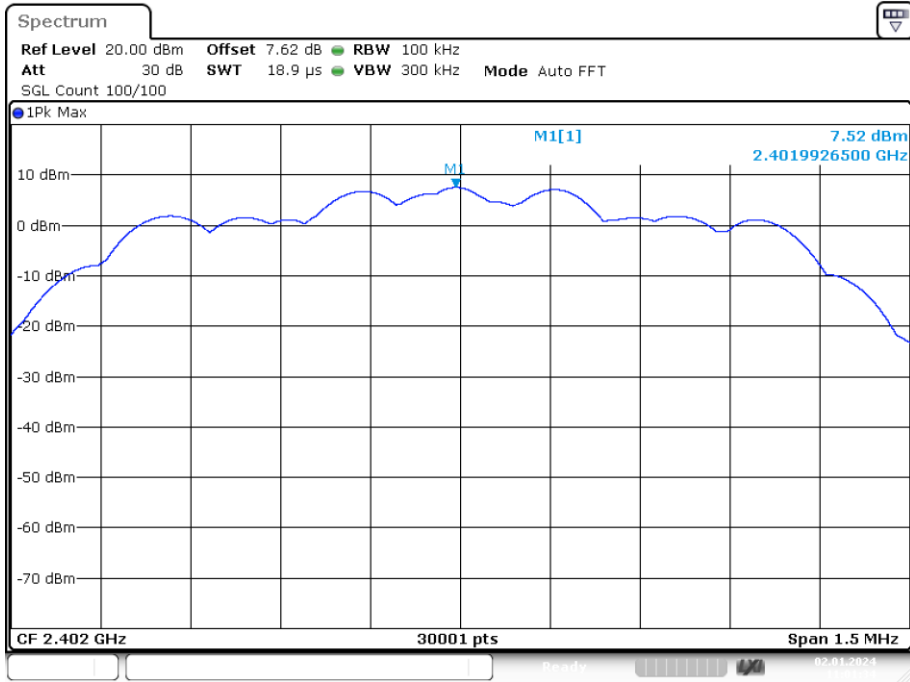

Date: 2.JAN.2024 11:01:33

Tx. Spurious NVNT 3-DH1 2402MHz Ant1 Emission

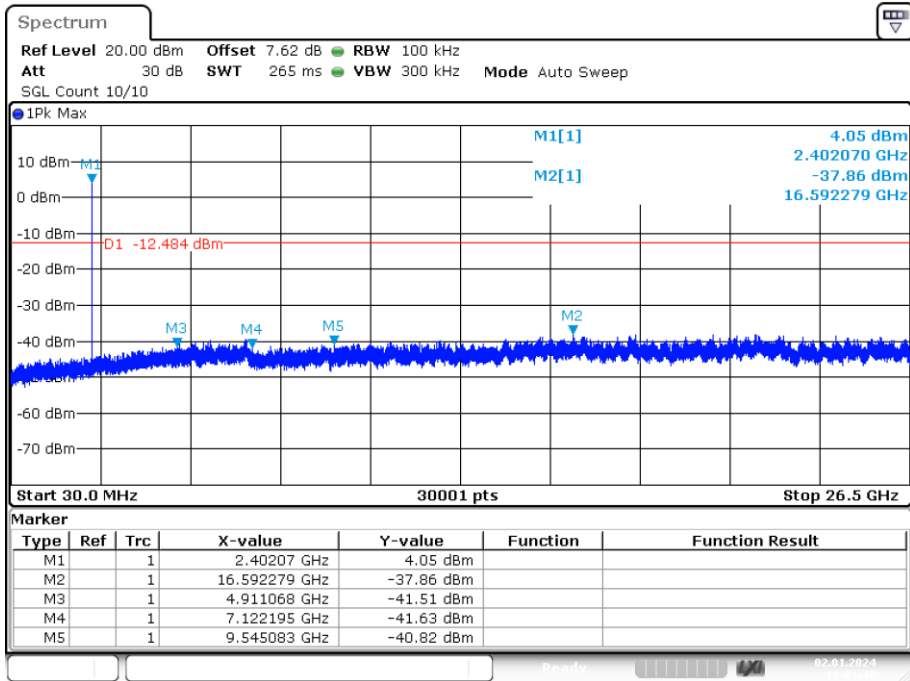

Date: 2.JAN.2024 11:01:47

Tx. Spurious NVNT 3-DH1 2441MHz Ant1 Ref

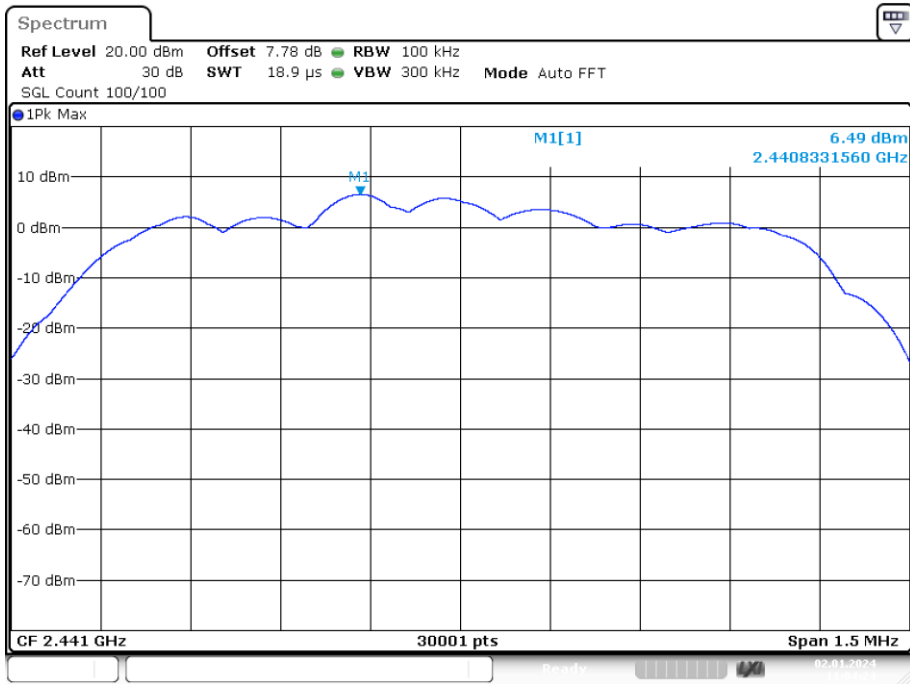

Date: 2.JAN.2024 11:04:25

Tx. Spurious NVNT 3-DH1 2441MHz Ant1 Emission

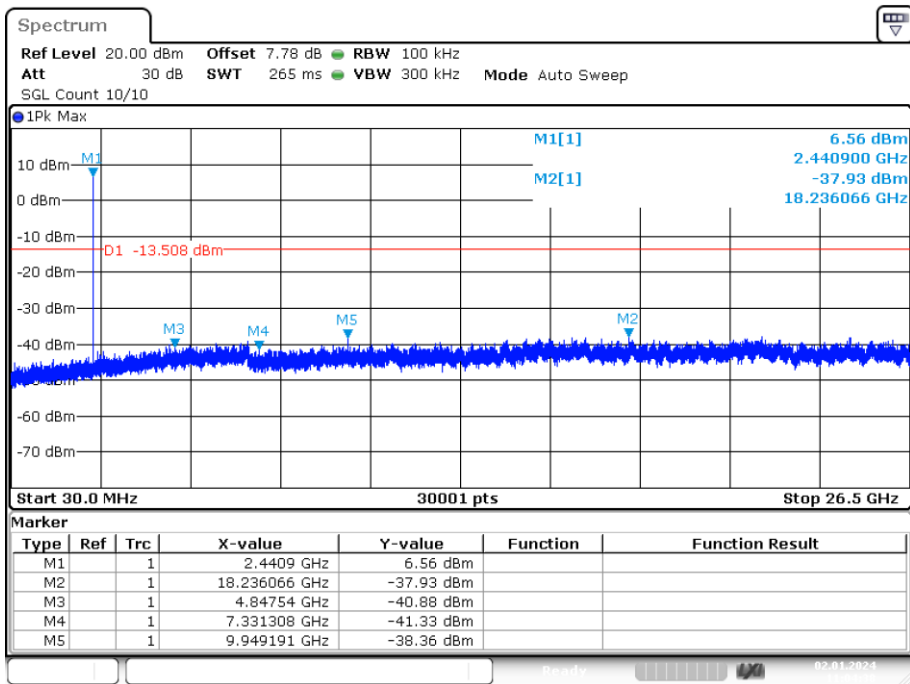

Date: 2.JAN.2024 11:04:38

Tx. Spurious NVNT 3-DH1 2480MHz Ant1 Ref

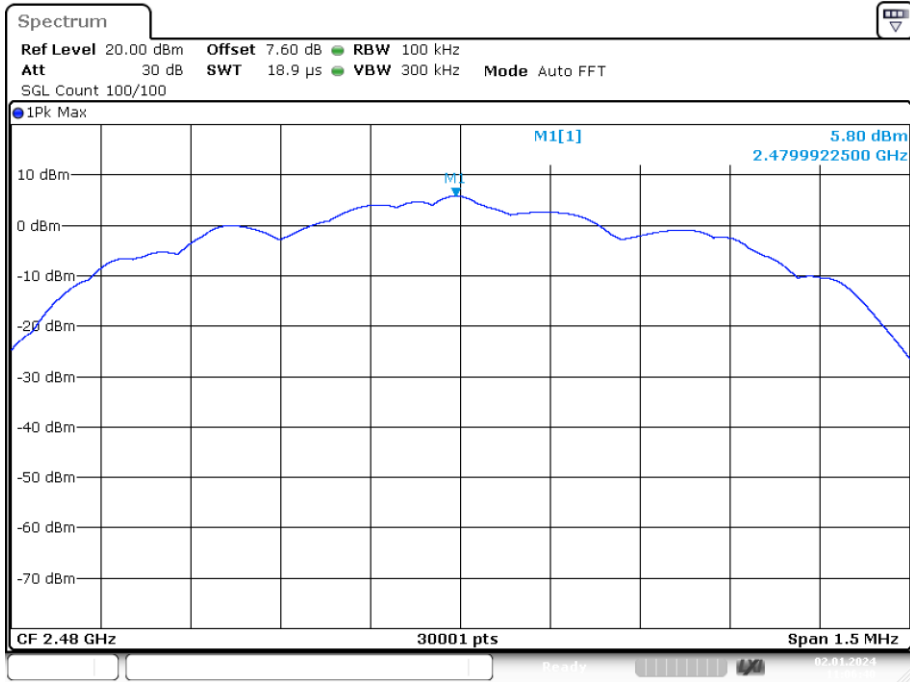

Date: 2.JAN.2024 11:06:40

Tx. Spurious NVNT 3-DH1 2480MHz Ant1 Emission

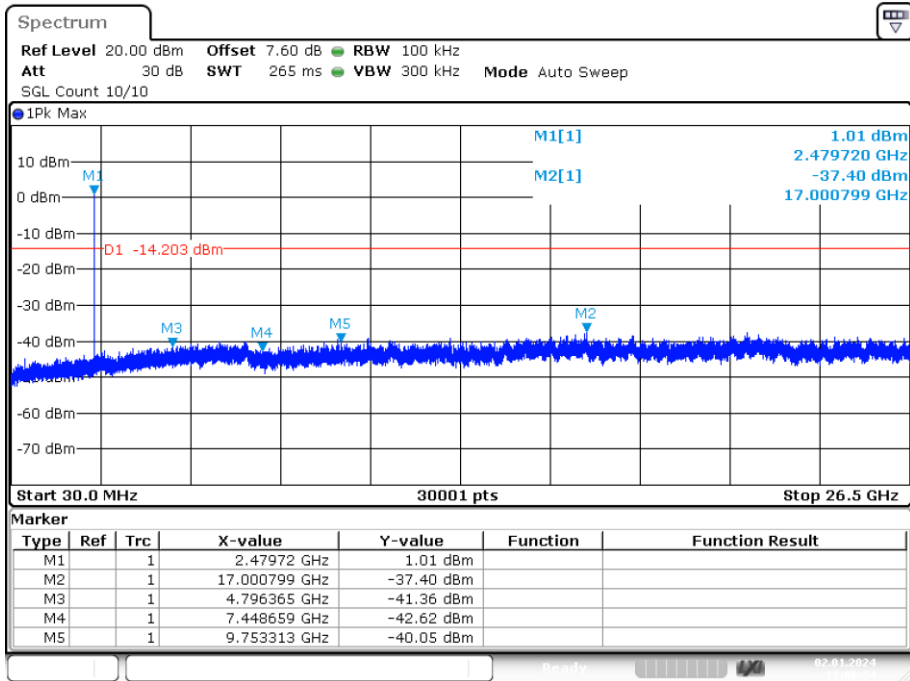

Date: 2.JAN.2024 11:06:54

9. Band Edge Compliance

9.1. Block Diagram of Test Setup

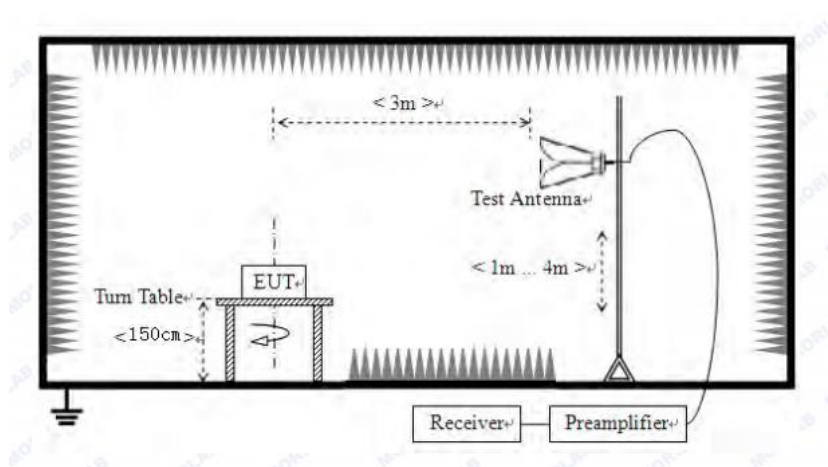

9.2. Limit

All the lower and upper band-edges emissions appearing within restricted frequency bands shall not exceed the limits shown in FCC part 15.209 and RSS-GEN, all the other emissions outside operation shall be at least 20dB below the fundamental emissions, or comply with FCC part 15.209 and RSS-GEN limits.

9.3. Test Procedure

Refer to ANSI C 63.10, Clause 6.10.

All restriction band and non- restriction band have been tested, only worse case is reported.

9.4. Test Result

PASS. (See below detailed test data)

Radiated Method:

Test Mode: GFSK-Low Hopping-off

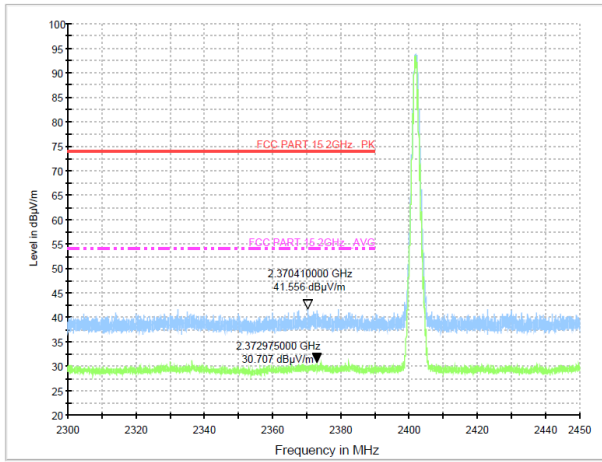

Test Mode: GFSK-High Hopping-off

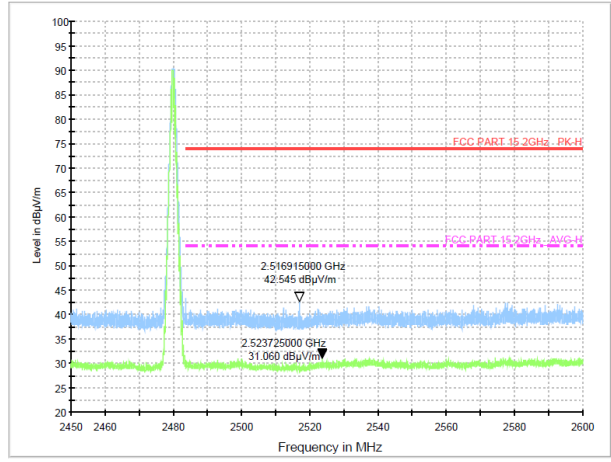

Test Mode: GFSK-Low Hopping-on

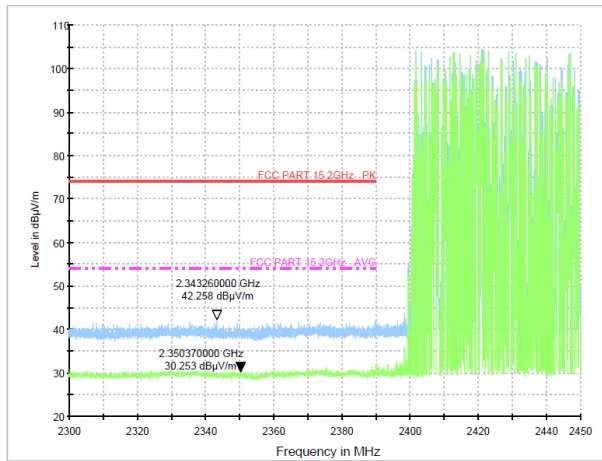

Test Mode: GFSK-High Hopping-on

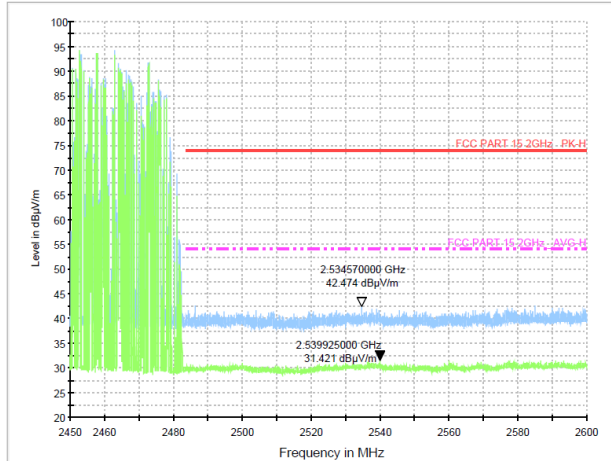

Test Mode: $\pi/4$ DQPSK-Low Hopping-off

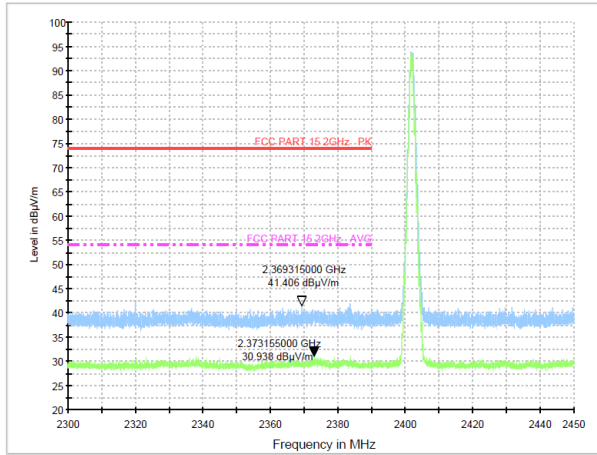

Test Mode: $\pi/4$ DQPSK-High Hopping-off

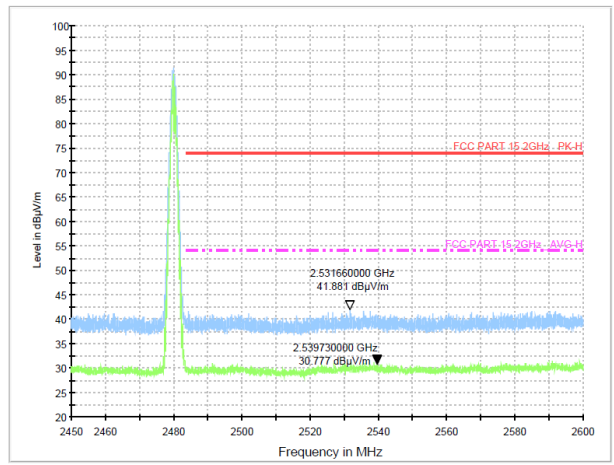

Test Mode: $\pi/4$ DQPSK-Low Hopping-on

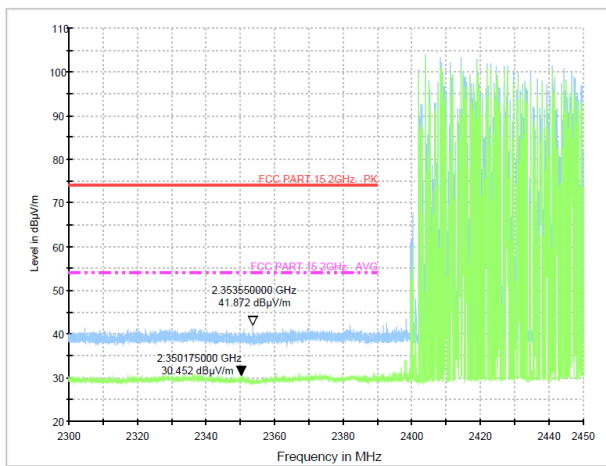

Test Mode: $\pi/4$ DQPSK-High Hopping-on

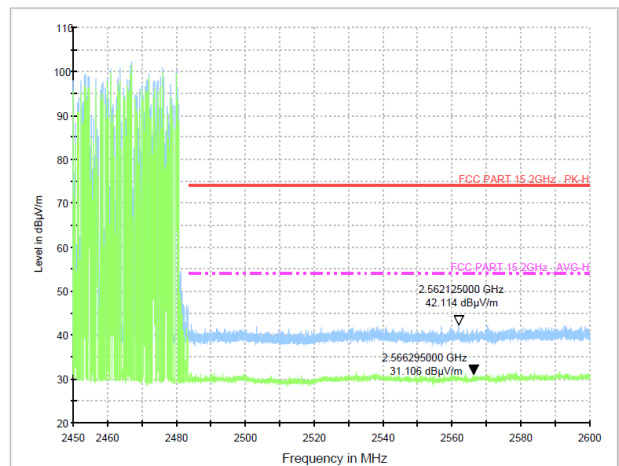

Test Mode: 8DPSK-Low Hopping-off

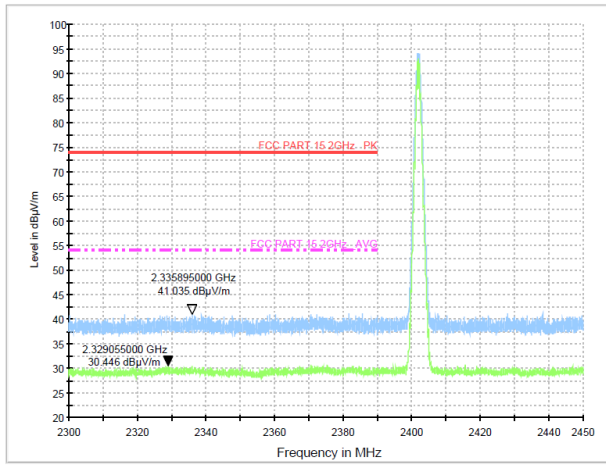

Test Mode: 8DPSK-High Hopping-off

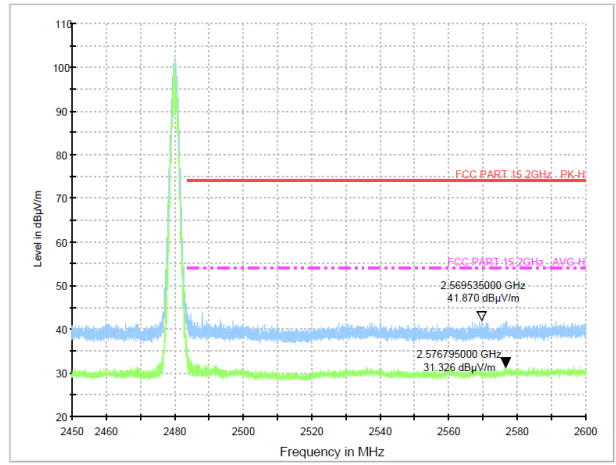

Test Mode: 8DPSK-Low Hopping-on

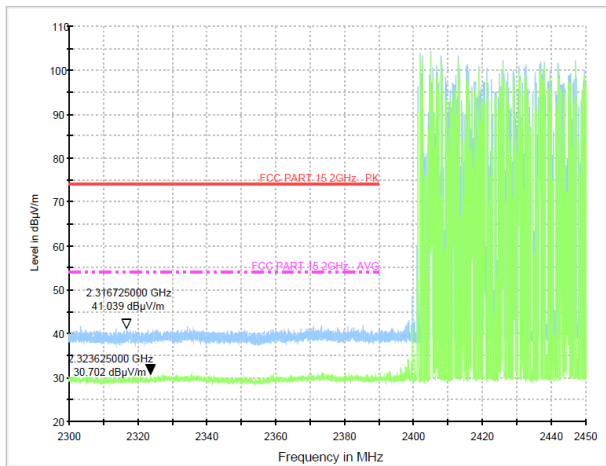

Test Mode: 8DPSK-High Hopping-on

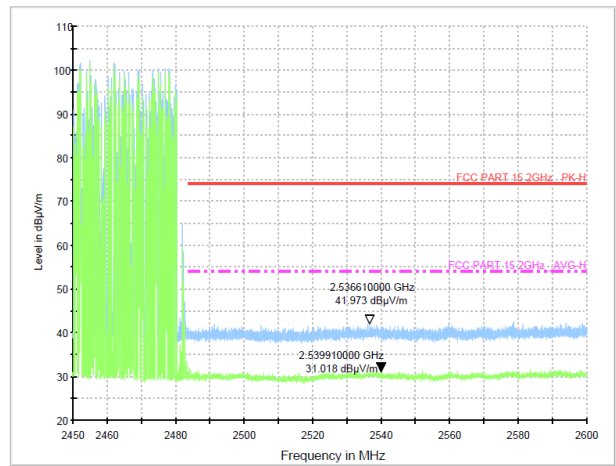

Conducted Method

Band Edge NVNT 1-DH1 2402MHz Ant1 No-Hopping Ref

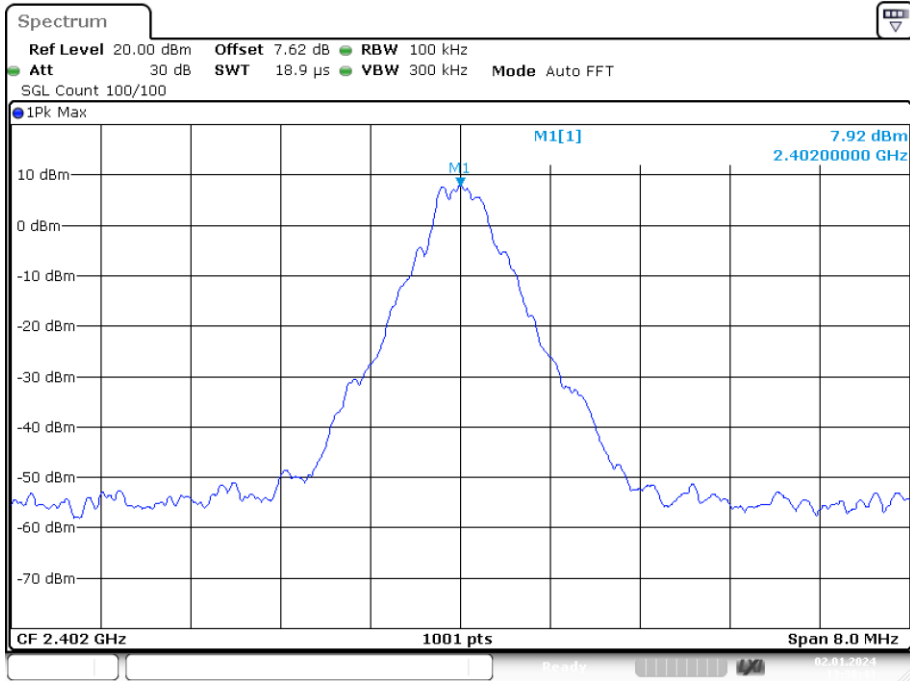

Date: 2.JAN.2024 13:38:43

Band Edge NVNT 1-DH1 2402MHz Ant1 No-Hopping Emission

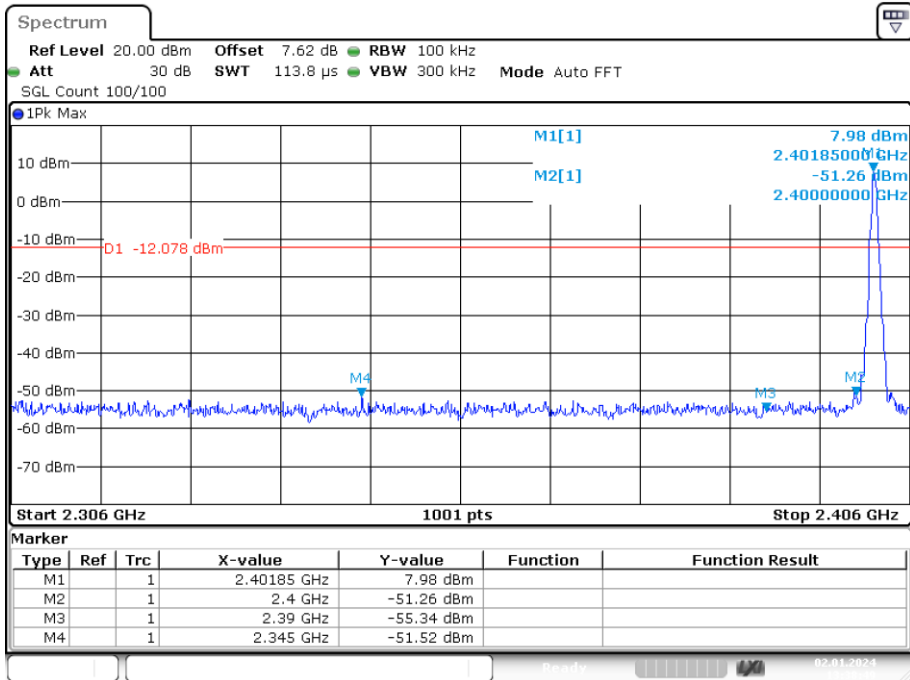

Date: 2.JAN.2024 13:38:49

Band Edge NVNT 1-DH1 2480MHz Ant1 No-Hopping Ref

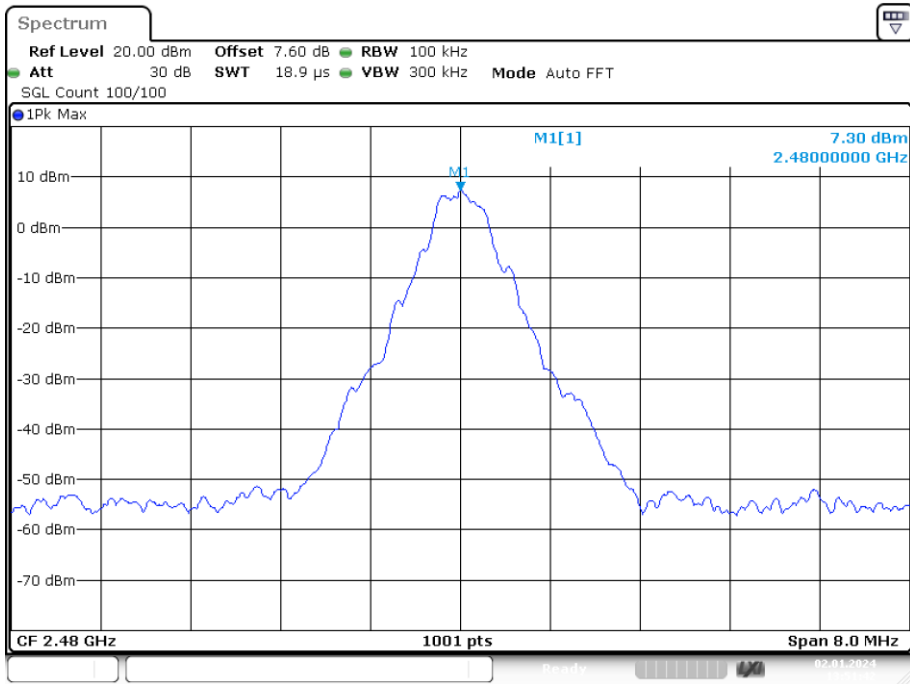

Date: 2.JAN.2024 13:51:42

Band Edge NVNT 1-DH1 2480MHz Ant1 No-Hopping Emission

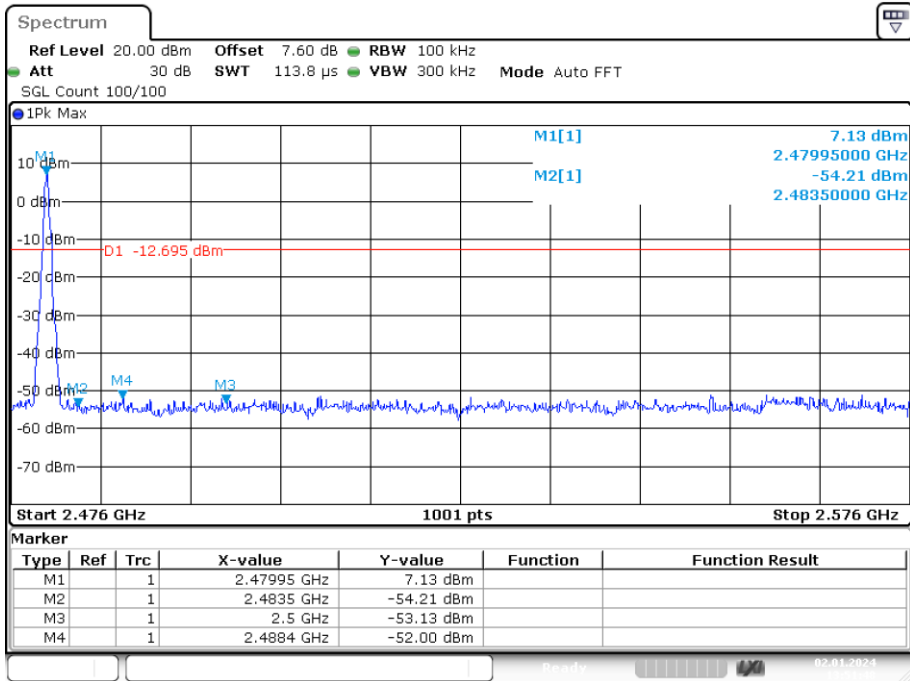

Date: 2.JAN.2024 13:51:47

Band Edge NVNT 2-DH1 2402MHz Ant1 No-Hopping Ref

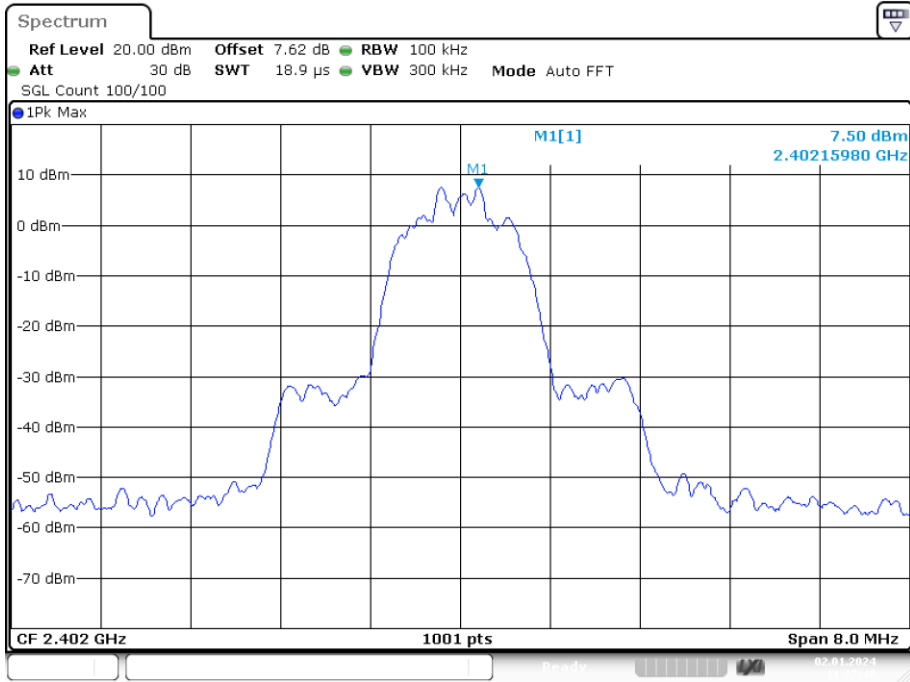

Date: 2.JAN.2024 11:27:48

Band Edge NVNT 2-DH1 2402MHz Ant1 No-Hopping Emission

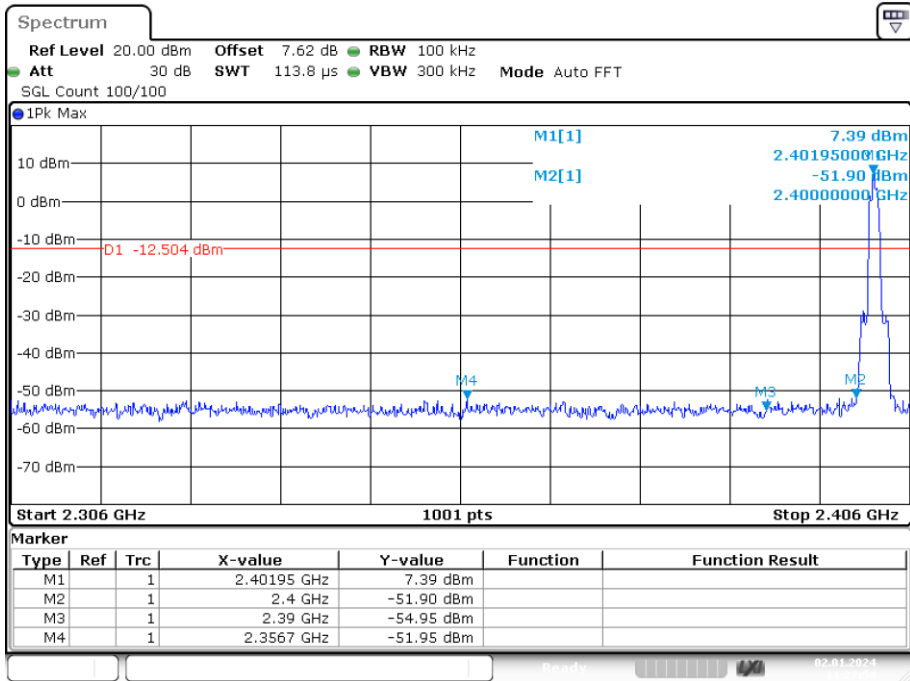

Date: 2.JAN.2024 11:27:54

Band Edge NVNT 2-DH1 2480MHz Ant1 No-Hopping Ref

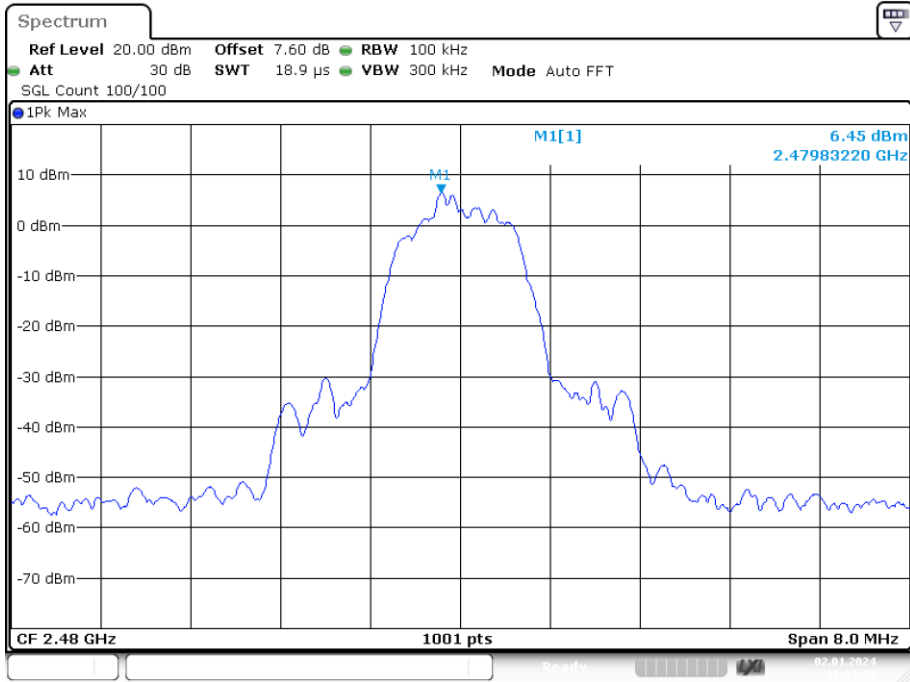

Date: 2.JAN.2024 11:35:03

Band Edge NVNT 2-DH1 2480MHz Ant1 No-Hopping Emission

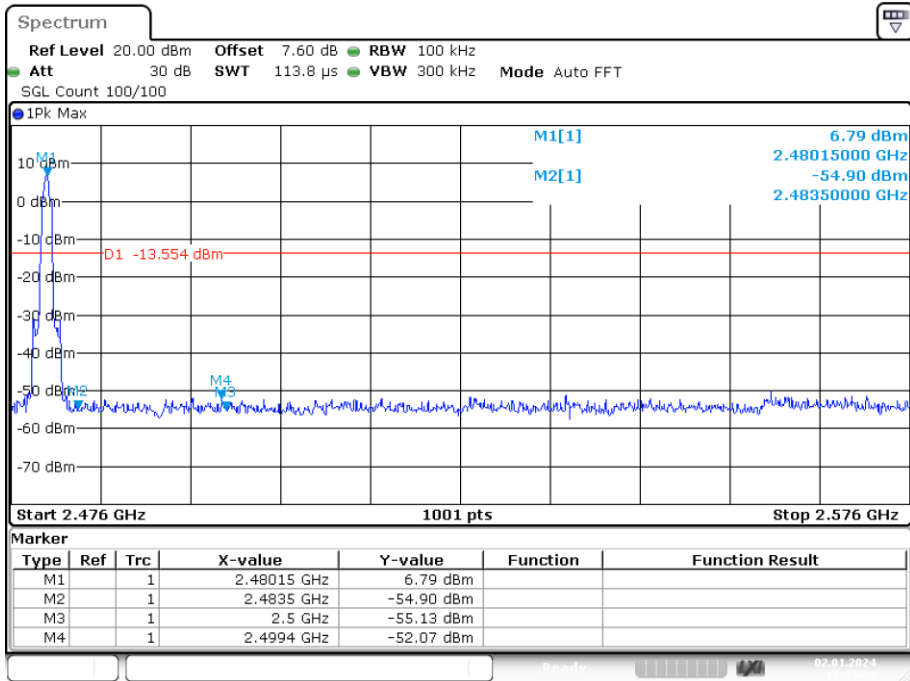

Date: 2.JAN.2024 11:35:09

Band Edge NVNT 3-DH1 2402MHz Ant1 No-Hopping Ref

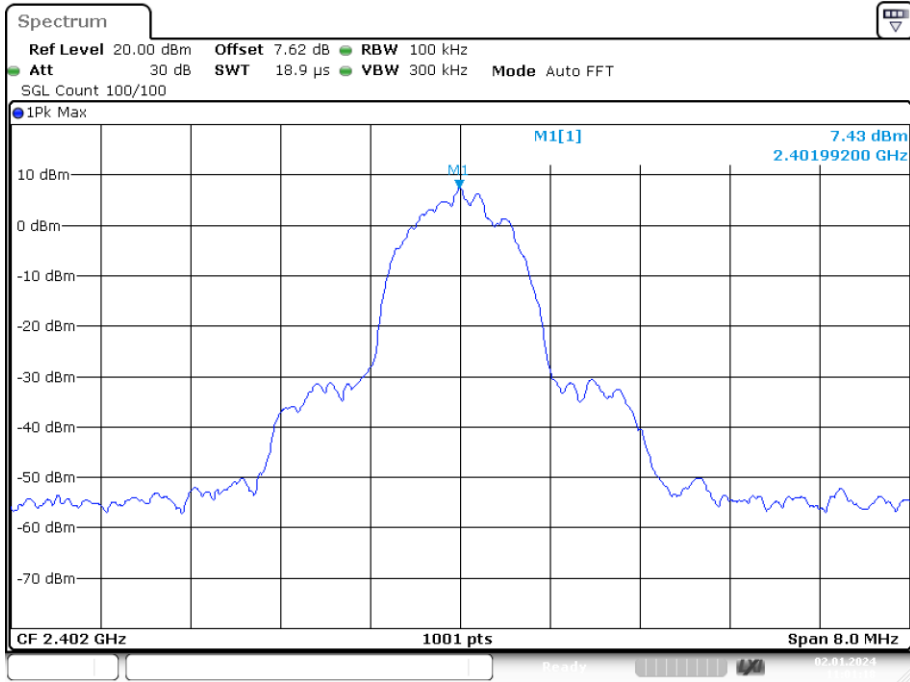

Date: 2.JAN.2024 11:01:18

Band Edge NVNT 3-DH1 2402MHz Ant1 No-Hopping Emission

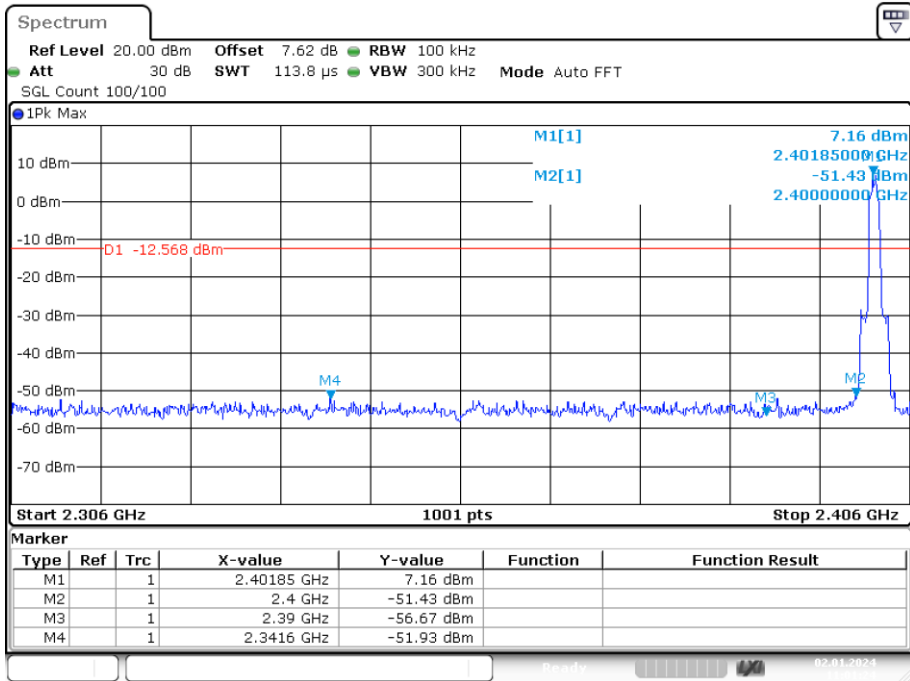

Date: 2.JAN.2024 11:01:24

Band Edge NVNT 3-DH1 2480MHz Ant1 No-Hopping Ref

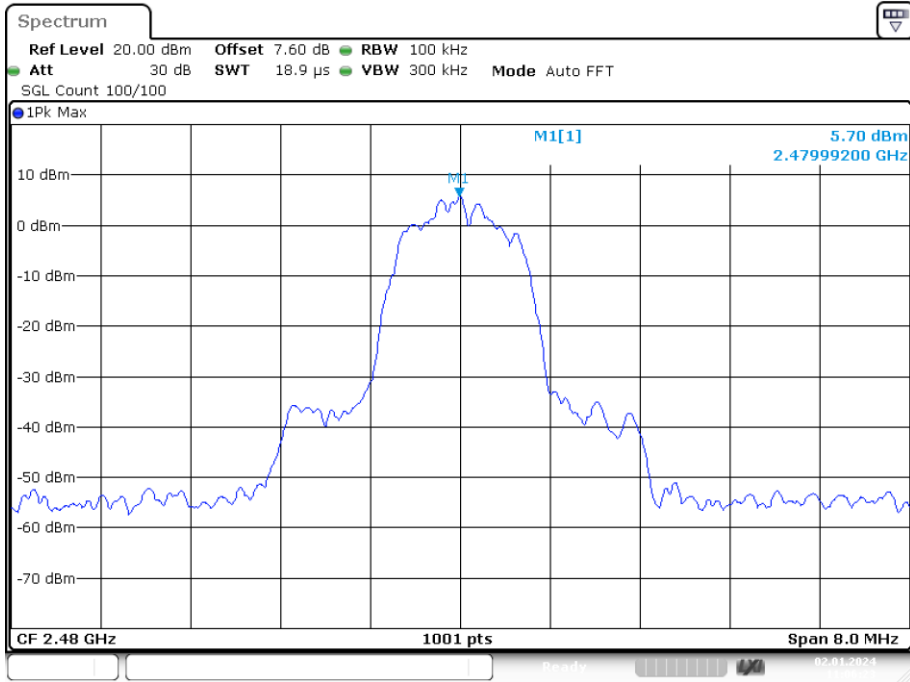

Date: 2.JAN.2024 11:06:23

Band Edge NVNT 3-DH1 2480MHz Ant1 No-Hopping Emission

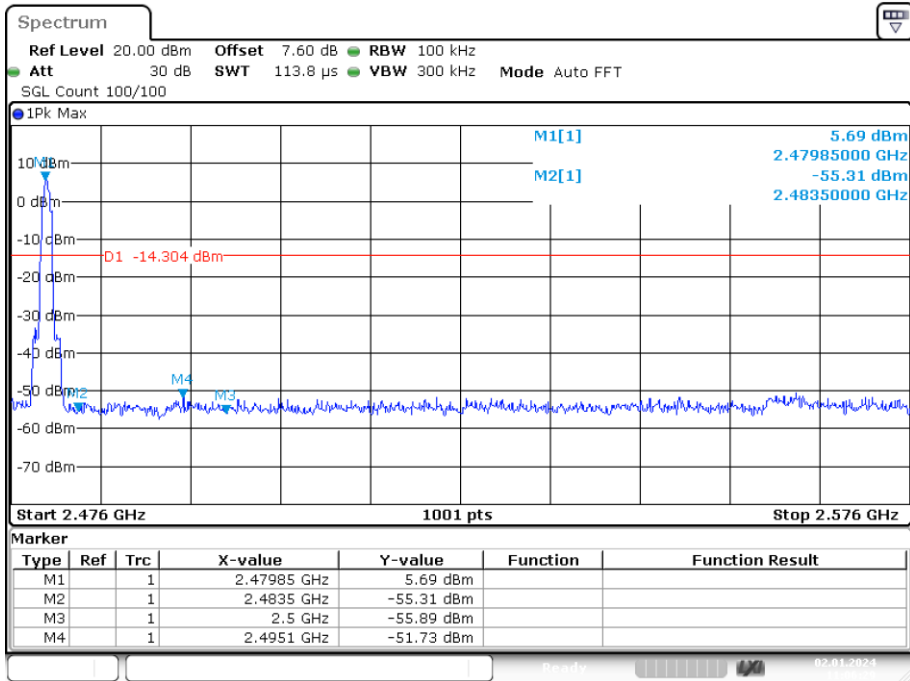

Date: 2.JAN.2024 11:06:29

Band Edge(Hopping) NVNT 1-DH1 2402MHz Ant1 Hopping Ref

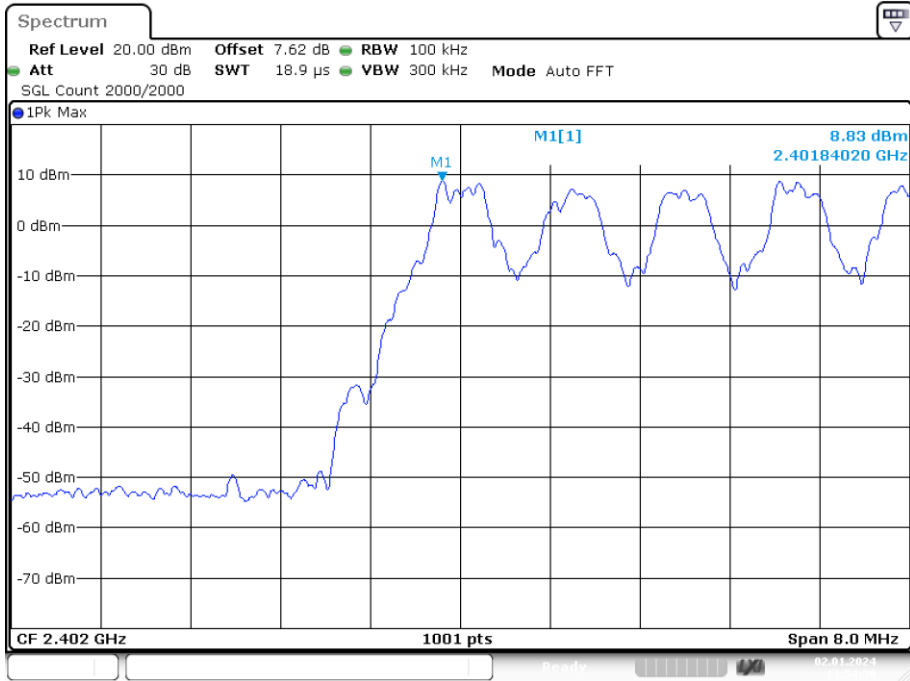

Date: 2.JAN.2024 13:54:30

Band Edge(Hopping) NVNT 1-DH1 2402MHz Ant1 Hopping Emission

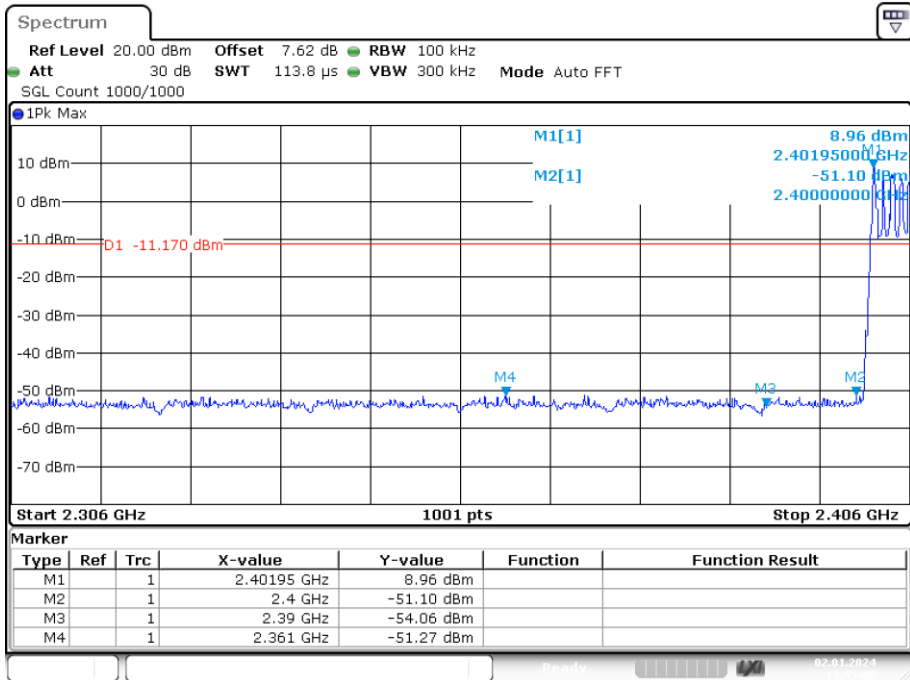

Date: 2.JAN.2024 13:55:00

Band Edge(Hopping) NVNT 1-DH1 2480MHz Ant1 Hopping Ref

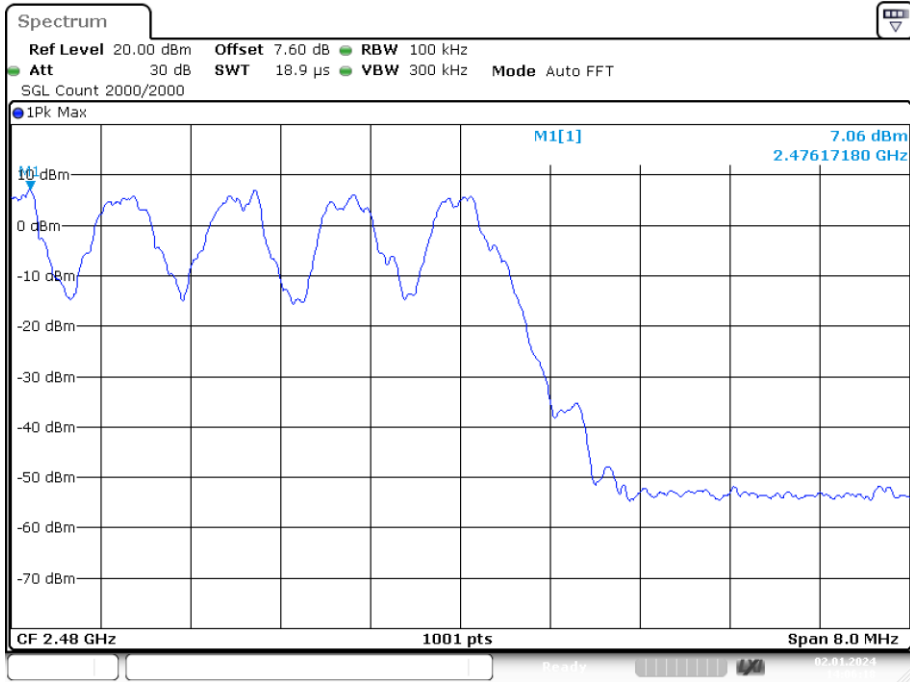

Date: 2.JAN.2024 14:06:18

Band Edge(Hopping) NVNT 1-DH1 2480MHz Ant1 Hopping Emission

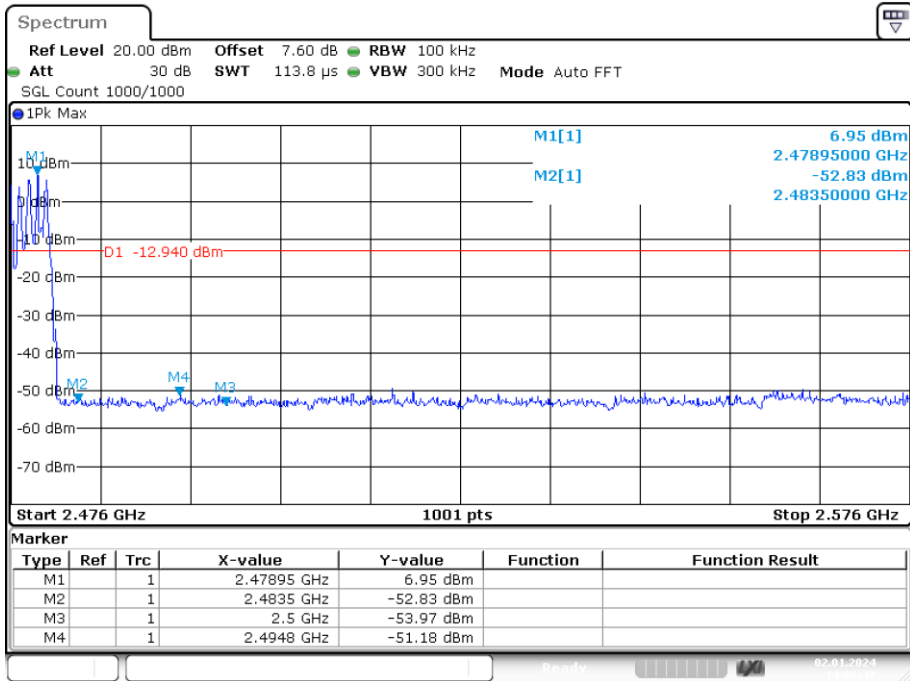

Date: 2.JAN.2024 14:06:47

Band Edge(Hopping) NVNT 2-DH1 2402MHz Ant1 Hopping Ref

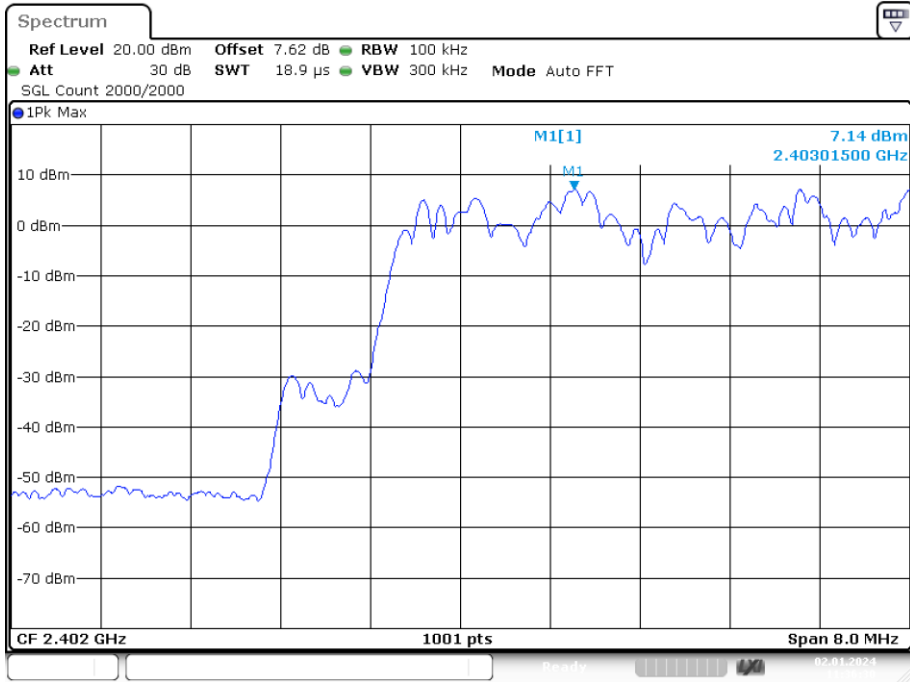

Date: 2.JAN.2024 11:36:30

Band Edge(Hopping) NVNT 2-DH1 2402MHz Ant1 Hopping Emission

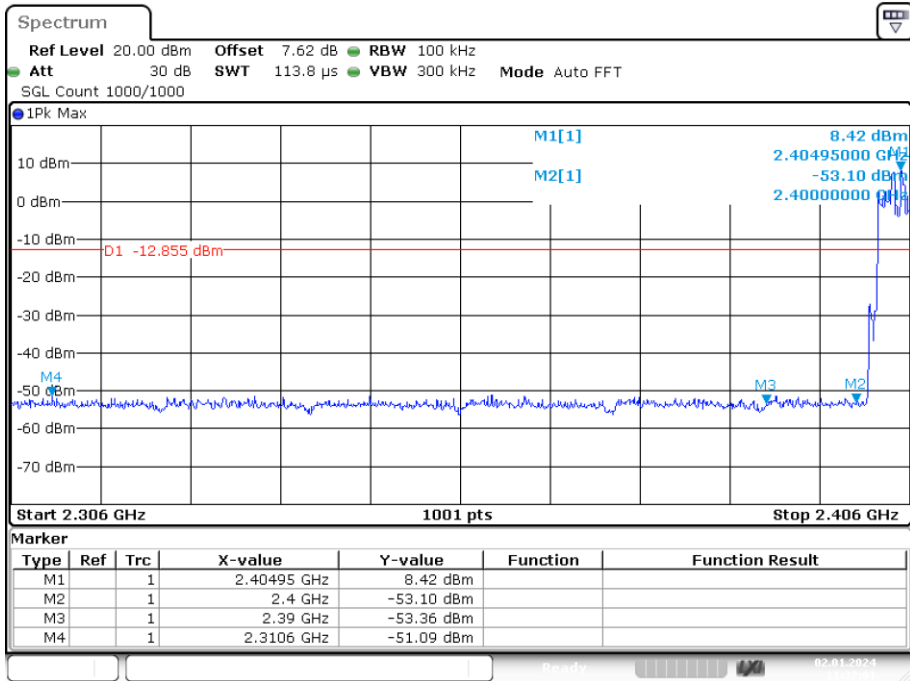

Date: 2.JAN.2024 11:37:00

Band Edge(Hopping) NVNT 2-DH1 2480MHz Ant1 Hopping Ref

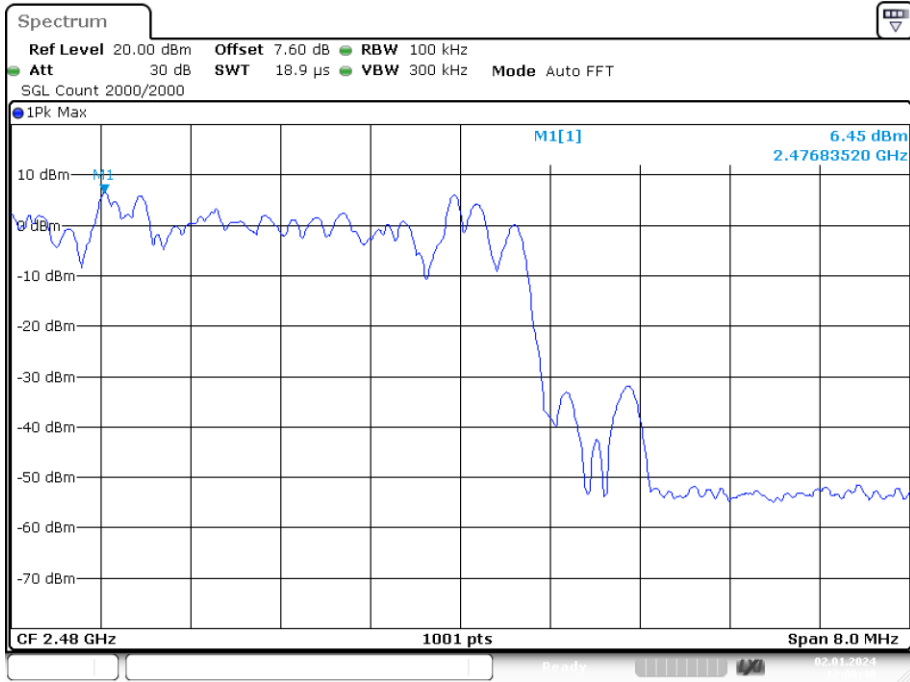

Date: 2.JAN.2024 12:06:40

Band Edge(Hopping) NVNT 2-DH1 2480MHz Ant1 Hopping Emission

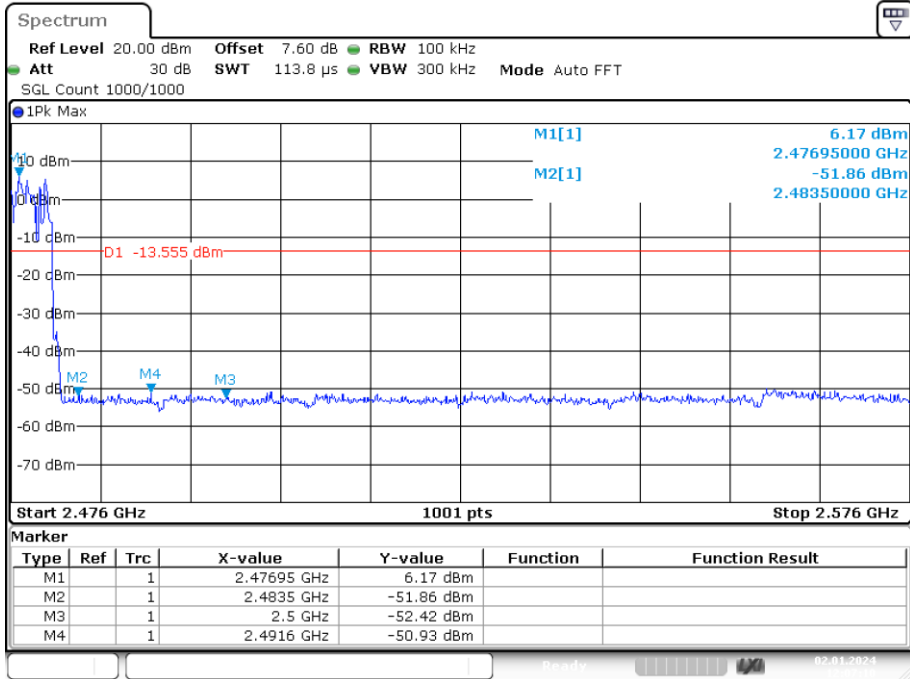

Date: 2.JAN.2024 12:07:09

Band Edge(Hopping) NVNT 3-DH1 2402MHz Ant1 Hopping Ref

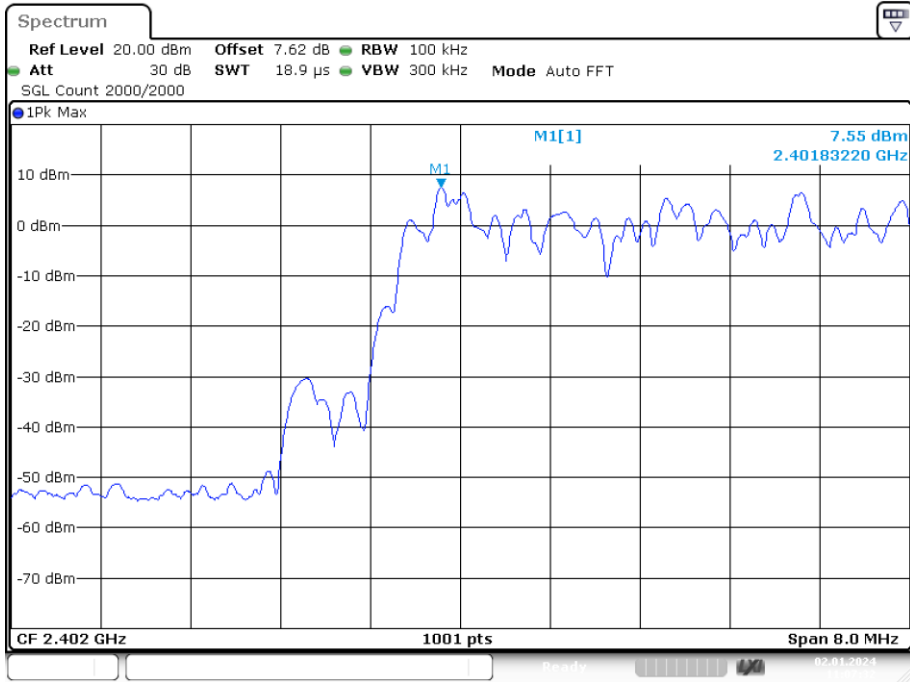

Date: 2.JAN.2024 11:07:33

Band Edge(Hopping) NVNT 3-DH1 2402MHz Ant1 Hopping Emission

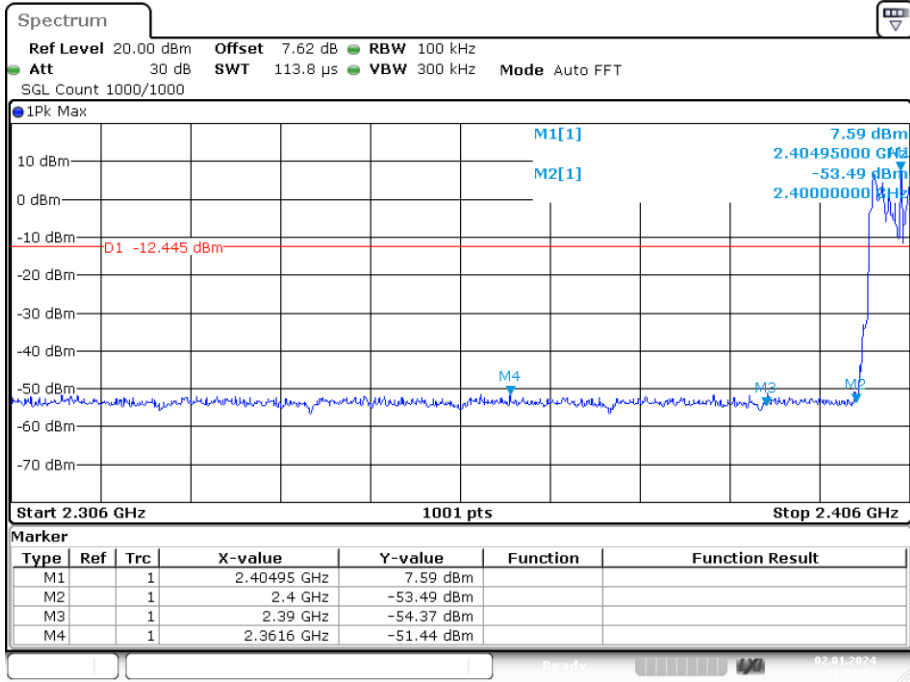

Date: 2.JAN.2024 11:08:04

Band Edge(Hopping) NVNT 3-DH1 2480MHz Ant1 Hopping Ref



Date: 2.JAN.2024 11:18:59

Band Edge(Hopping) NVNT 3-DH1 2480MHz Ant1 Hopping Emission

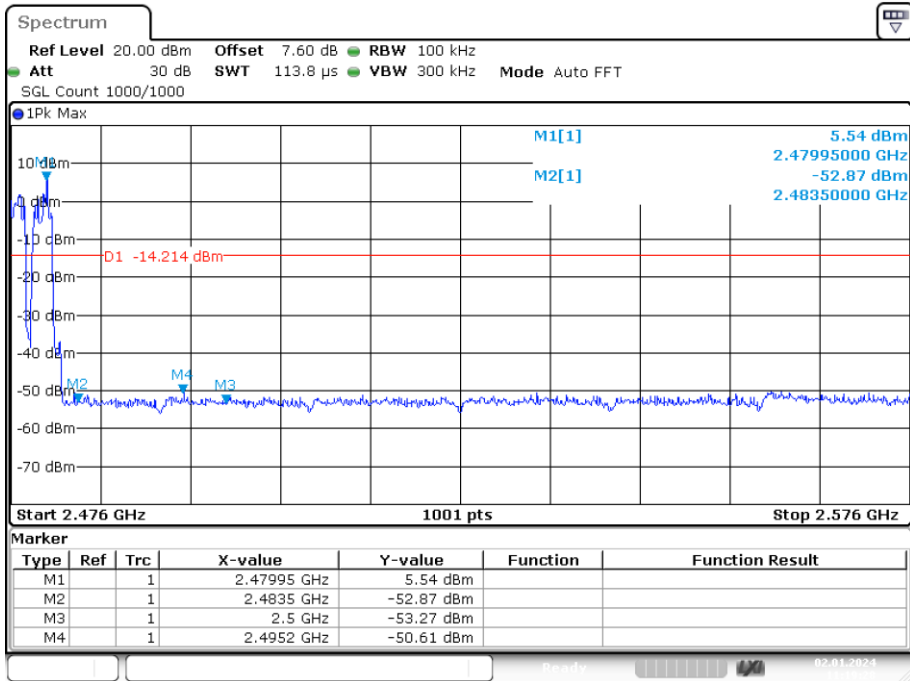

Date: 2.JAN.2024 11:19:28

10. Power Line Conducted Emissions

10.1. Block Diagram of Test Setup

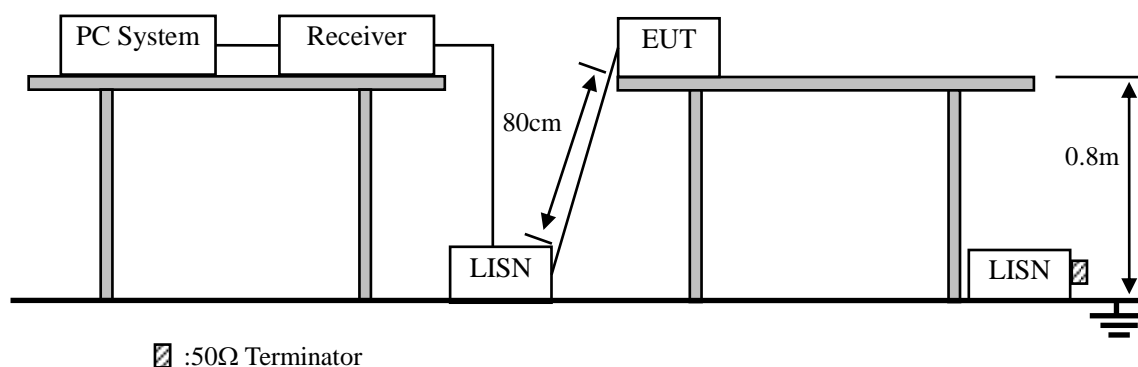

10.2. Limit

Frequency	Maximum RF Line Voltage	
	Quasi-Peak Level dB(μV)	Average Level dB(μV)
150kHz ~ 500kHz	66 ~ 56*	56 ~ 46*
500kHz ~ 5MHz	56	46
5MHz ~ 30MHz	60	50

- Notes: 1. * Decreasing linearly with logarithm of frequency.
2. The lower limit shall apply at the transition frequencies.

10.3. Test Procedure

- (1) The EUT was placed on a non-metallic table, 80cm above the ground plane.
- (2) Setup the EUT and simulator as shown in 10.1
- (3) The EUT Power connected to the power mains through a power adapter and a line impedance stabilization network (L.I.S.N1). The other peripheral devices power cord connected to the power mains through a line impedance stabilization network (L.I.S.N2), this provided a 50-ohm coupling impedance for the EUT (Please refer to the block diagram of the test setup and photographs). Both sides of power line were checked for maximum conducted interference. In order to find the maximum emission, the relative positions of equipments and all of the interface cables were changed according to ANSI C63.10:2013on conducted Emission test.
- (4) The bandwidth of test receiver is set at 10KHz.
- (5) The frequency range from 150 KHz to 30MHz is checked.

10.4. Test Result

PASS. (See below detailed test data)

Note: If peak Result comply with AV limit, QP and AV Result is deemed to comply with AV limit

Line:

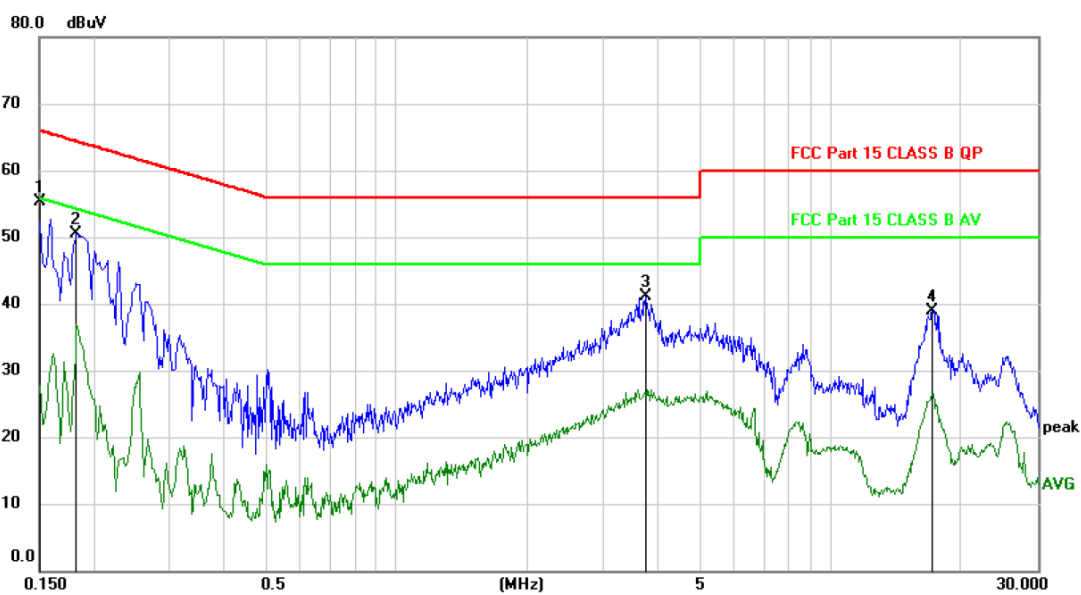

No.	Mk.	Freq. MHz	Reading Level dBuV	Correct Factor dB	Measure- ment dBuV	Limit dBuV	Margin dB	Detector	Comment
1	*	0.1500	55.38	0.00	55.38	66.00	-10.62	peak	
2		0.1830	50.47	0.00	50.47	64.35	-13.88	peak	
3		3.7470	41.19	0.00	41.19	56.00	-14.81	peak	
4		17.1480	38.96	0.00	38.96	60.00	-21.04	peak	

*:Maximum data x:Over limit !:over margin

(Reference Only)

Note: Measurement=Reading Level+Correc Factor. Factor=(LISN or ISN or PLC or Current Probe)Factor+Cable

Neutral:

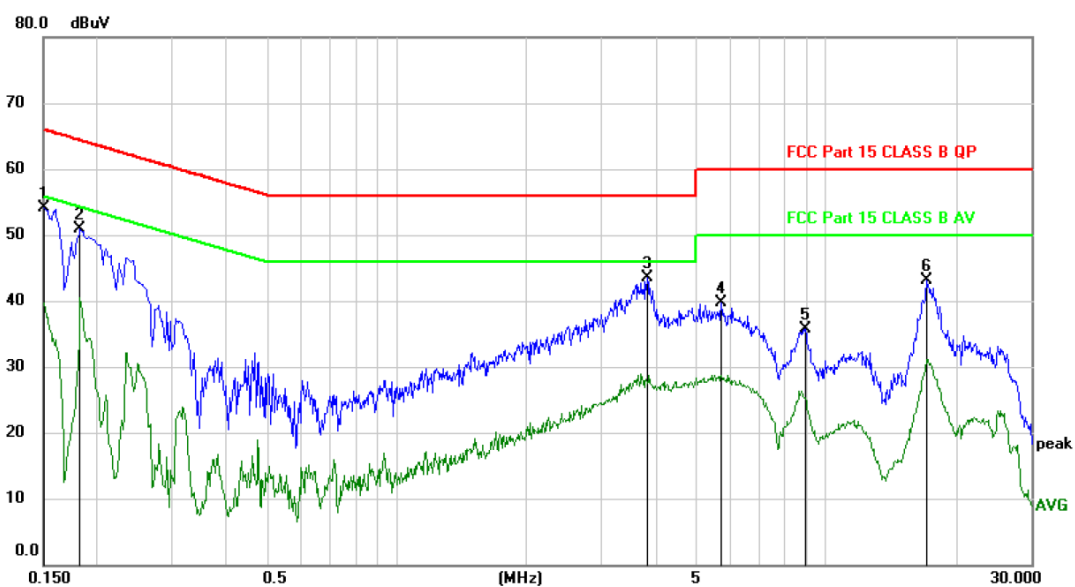

No.	Mk.	Freq. MHz	Reading Level dBuV	Correct Factor dB	Measure- ment dBuV	Limit dBuV	Margin dB	Detector	Comment
1	*	0.1500	54.20	0.00	54.20	66.00	-11.80	peak	
2		0.1830	50.89	0.00	50.89	64.35	-13.46	peak	
3		3.8310	43.44	0.00	43.44	56.00	-12.56	peak	
4		5.7000	39.78	0.00	39.78	60.00	-20.22	peak	
5		8.9550	35.72	0.00	35.72	60.00	-24.28	peak	
6		17.1840	43.13	0.00	43.13	60.00	-16.87	peak	

*:Maximum data x:Over limit !:over margin <Reference Only
 Note: Measurement=Reading Level+Correc Factor. Factor=(LISN or ISN or PLC or Current Probe)Factor+Cable

Remark: This report only shall the worst case mode for GFSK 2402MHz.

11. FREQUENCY STABILITY

11.1. Test limit

Please refer section RSS-Gen.

Regulation RSS-Gen If the frequency stability of the licence-exempt radio apparatus is not specified in the applicable RSS, the fundamental emissions of the radio apparatus should be kept within at least the central 80% of its permitted operating frequency band in order to minimize the possibility of out-of-band operation. In addition, its occupied bandwidth shall be entirely outside the restricted bands and the prohibited TV bands of 54-72 MHz, 76-88 MHz, 174-216 MHz, and 470-602 MHz, unless otherwise indicated.

11.2. Test Procedure

The following equipment are installed on the emission measurement to meet the commission requirements and operating regulations in a manner which tends to maximize its emission characteristics in normal application.

11.3. Test Setup

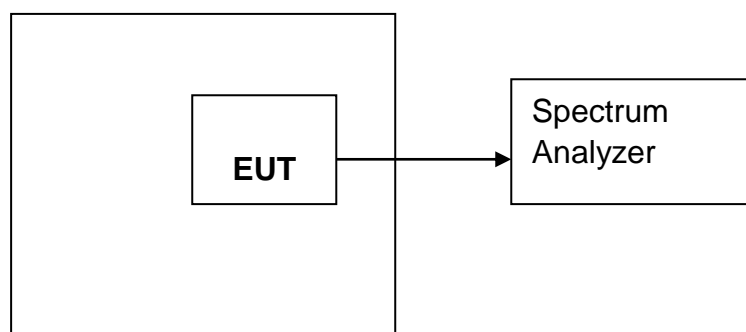

Temperature controller

11.4. Test Results

Pass.

Detailed information please see the following page.

Assigned Frequency(MHz): 2402MHz(GFSK)				
Voltage	Temperature	Measured Frequency (MHz)	Frequency stability(MHz)	Limit(MHz)
Low DC 3.30V	+20°C	2402.006	0.006	±0.020
Normal DC 3.3V	-10°C	2401.990	-0.010	±0.020
	-5°C	2401.986	-0.014	±0.020
	0°C	2401.992	-0.008	±0.020
	+10°C	2402.009	0.009	±0.020
	+20°C	2402.001	0.001	±0.020
	+30°C	2402.002	0.002	±0.020
	+40°C	2401.983	-0.017	±0.020
	+50°C	2401.997	-0.003	±0.020
	+60°C	2401.995	-0.005	±0.020
High DC 3.6V	+20°C	2402.003	0.003	±0.020

12. Antenna Requirements

12.1. Limit

For intentional device, according to FCC 47 CFR Section 15.203 and RSS-GEN, an intentional radiator shall be designed to ensure that no antenna other than that furnished by the responsible party shall be used with the device. And according to FCC 47 CFR Section 15.247 (b), if transmitting antennas of directional gain greater than 6dBi are used, the power shall be reduced by the amount in dB that the directional gain of the antenna exceeds 6dBi.

12.2. Result

The EUT antenna is internal antenna. It complies with the standard requirement.

13. Test Setup Photo

13.1. Photos of Radiated emission

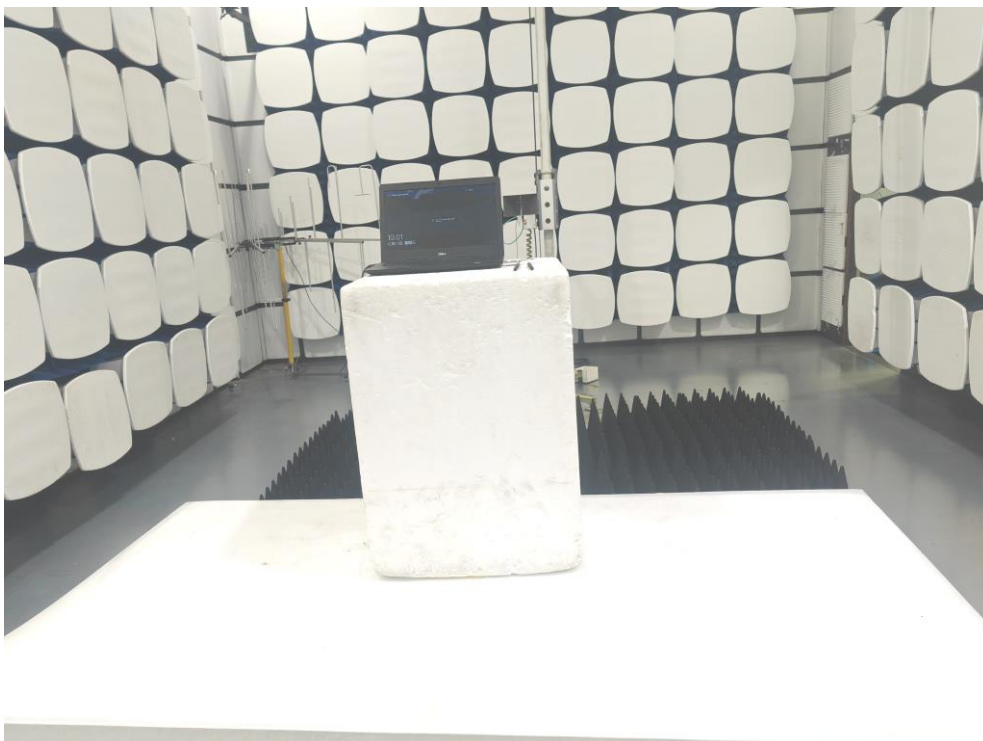
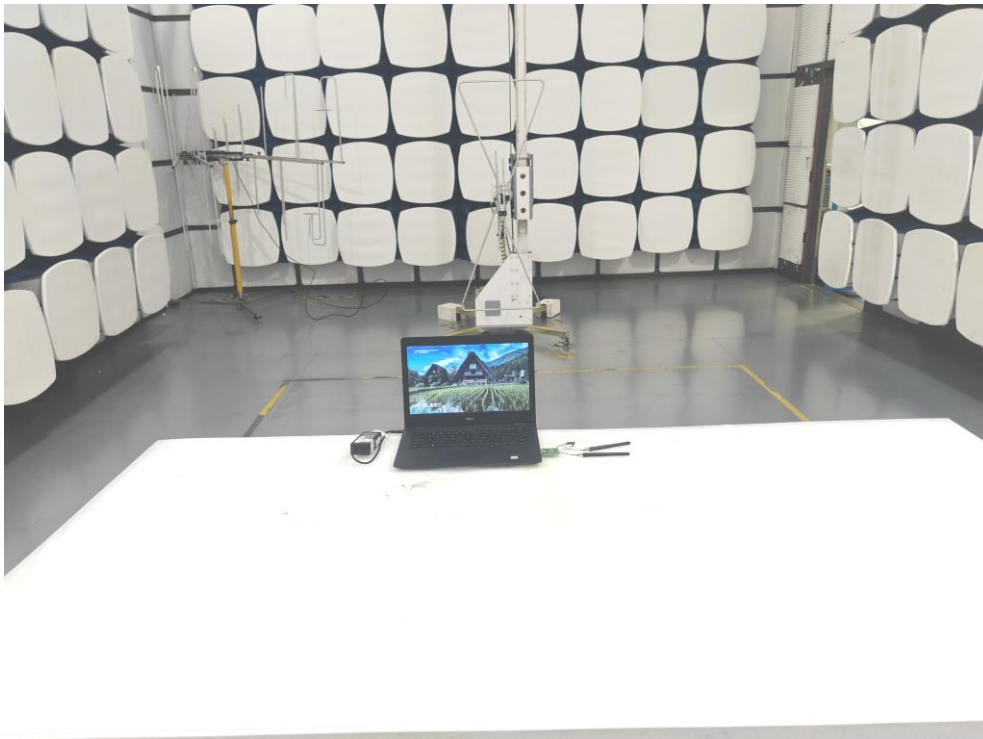

13.2.Photos of Conducted Emission test



-----END OF REPORT-----