

RF Test Report

Applicant : FN-LINK TECHNOLOGY LIMITED

Product Name : WiFi/bt module

Trade Name : FN-LINK

Model Number : 6233E-UUB

Applicable Standard : FCC 47 CFR PART 15 SUBPART C
ANSI C63.10:2013

Received Date : Nov. 07, 2022

Test Period : Mar. 27 ~ Apr. 18, 2023

Issued Date : May 12, 2023

Issued by

Eurofins E&E Wireless Taiwan Co., Ltd.
No. 140-1, Changan Street, Bade District,
Taoyuan City 334025, Taiwan (R.O.C.)
Tel : +886-3-2710188 / Fax : +886-3-2710190



Taiwan Accreditation Foundation accreditation number: 1330
Frequency Range: 9 kHz to 325 GHz (Bade test site)
Test Firm MRA designation number: TW0010
Frequency Range: 9 kHz to 40 GHz (Wugu test site)
Test Firm MRA designation number: TW0034

Note:

1. The test results are valid only for samples provided by customers and under the test conditions described in this report.
2. This report shall not be reproduced except in full, without the written approval of Eurofins E&E Wireless Taiwan Co., Ltd.
3. The relevant information is provided by customers in this test report. According to the correctness, appropriateness or completeness of the information provided by the customer, if there is any doubt or error in the information which affects the validity of the test results, the laboratory does not take the responsibility.

Revision History

Version	Issued Date	Revisions	Revised By
00	May 12, 2023	Initial Issue	Snow Wang

Verification of Compliance

Applicant : FN-LINK TECHNOLOGY LIMITED

Product Name : WiFi/bt module

Trade Name : FN-LINK

Model Number : 6233E-UUB

FCC ID : 2AATL-6233E-UUB

Applicable Standard : FCC 47 CFR PART 15 SUBPART C
ANSI C63.10:2013

Test Result : Complied

Performing Lab. : Eurofins E&E Wireless Taiwan Co., Ltd.
No. 140-1, Changan Street, Bade District,
Taoyuan City 334025, Taiwan (R.O.C.)



Tel : +886-3-2710188 / Fax : +886-3-2710190

Taiwan Accreditation Foundation accreditation number: 1330

Eurofins E&E Wireless Taiwan Co., Ltd. tested the above equipment in accordance with the requirements set forth in the above standards. All indications of Pass/Fail in this report are opinions expressed by Eurofins E&E Wireless Taiwan Co., Ltd. based on interpretations and/or observations of test results. The test results show that the equipment tested is capable of demonstrating compliance with the requirements as documented in this report.

Approved By : _____

TABLE OF CONTENTS

1	General Information	5
1.1.	Summary of Test Result	5
1.2.	Testing Location	6
1.3.	Measurement Uncertainty	6
2	EUT Description.....	7
3	Test Methodology.....	8
3.1.	Mode of Operation.....	8
3.2.	EUT Test Step	9
3.3.	Configuration of Test System Details.....	9
3.4.	Test Instruments	10
3.5.	Test Site Environment.....	11
4	Measurement Procedure.....	12
4.1.	AC Power Line Conducted Emission Measurement.....	12
4.2.	Radiated Emission Measurement.....	14
4.3.	Maximum Conducted Output Power Measurement.....	17
4.4.	6 dB RF Bandwidth Measurement.....	18
4.5.	Maximum Power Density Measurement.....	19
4.6.	Out of Band Conducted Emissions Measurement.....	20
4.7.	Antenna Measurement	20
5	Test Results	21
5.1.	Conducted Emission.....	21
5.2.	Conducted Test Results.....	27
5.3.	Radiated Emission Measurement.....	28

Appendix A. Test Data

Appendix B. Test Plots

Appendix C. Test Setup Photographs

1 General Information

1.1. Summary of Test Result

Standard	Item	Result	Remark
15.207	AC Power Conducted Emission	PASS	-----
15.247(d)	Transmitter Radiated Emissions	PASS	-----
15.247(b)(3)	Max. Output Power	PASS	-----
15.247(a)(2)	6 dB RF Bandwidth	PASS	-----
15.247(e)	Maximum Power Spectral Density	PASS	-----
15.247(d)	Out of Band Conducted Spurious Emission	PASS	-----
15.203	Antenna Requirement	PASS	-----

Decision Rule

- Uncertainty is not included.
- Uncertainty is included.

Standard	Description
CFR47, Part 15, Subpart C	Intentional Radiators
ANSI C63. 10: 2013	American National Standard of Procedures for Compliance Testing of Unlicensed Wireless Devices
KDB 558074 D01 15.247 Meas Guidance v05r02	GUIDANCE FOR COMPLIANCE MEASUREMENTS ON DIGITAL TRANSMISSION SYSTEM, FREQUENCY HOPPING SPREAD SPECTRUM SYSTEM, AND HYBRID SYSTEM DEVICES OPERATING UNDER SECTION 15.247 OF THE FCC RULES

1.2. Testing Location

Lab Name: Eurofins E&E Wireless Taiwan Co., Ltd.
 Site Address: No. 140-1, Changan Street, Bade District, Taoyuan City 334025, Taiwan (R.O.C.)
 Site Address: No. 2, Wuquan 5th Rd. Wugu Dist., New Taipei City, Taiwan (R.O.C.)

1.3. Measurement Uncertainty

Test Item	Frequency Range	Uncertainty
Conducted Emission	150 kHz ~ 30 MHz	2.7 dB
Radiated Emission	9 kHz ~ 30 MHz	1.9 dB
	30 MHz ~ 1000 MHz	4.9 dB
	1000 MHz ~ 18000 MHz	5.0 dB
	18000 MHz ~ 26500 MHz	4.4 dB
	26500 MHz ~ 40000 MHz	4.4 dB
Conducted Output Power	1.1 dB	
RF Bandwidth	4.7 %	
Power Spectral Density	1.1 dB	

2 EUT Description

Applicant	FN-LINK TECHNOLOGY LIMITED No.8,Litong Road,Liuyang Economic & Technical Development Zone,Changsha,Hunan,China				
Product Name	WiFi/bt module				
Trade Name	FN-LINK				
Model Number	6233E-UUB				
FCC ID	2AATL-6233E-UUB				
Frequency Range	2402 ~ 2480 MHz				
Modulation Type	GFSK				
Operate Temp. Range	-20 ~ +70 °C				
EUT Power Rating	DC 3.3 V				
Antenna information	ANT	Trade Name	Model Number	Type	Max. Gain (dBi)
	Ant 0	ABRACON	AFB4714A	FPC Antenna	2.76
		PSA	RFPCA381425IMLB301	PCB Antenna	2.21
		Laird	EMN2449A2S-25UFL	PCB Antenna	3.50
		iRobot	4802062	PCB Antenna	3.44
RF Output Power	LE, GFSK:		0.00220 W		
	2LE, GFSK:		0.00243 W		
	BLR C2, GFSK:		0.00223 W		
	BLR C8, GFSK:		0.00224 W		

3 Test Methodology

3.1. Mode of Operation

Decision of Test Eurofins has verified the construction and function in typical operation. All the test modes were carried out with the EUT in normal operation, which was shown in this test report and defined as:

Pre-Test Mode	Final-Test Mode
Transmit Mode	V
BLE 1M	
BLE 2M	V
BLR C2	
BLR C8	V

Software used to control the EUT for staying in continuous transmitting mode was programmed.

After verification, all tests were carried out with the worst case test modes.

By preliminary testing and verifying three axis (X, Y and Z) position of EUT transmitted status, it was found that “Y axis” position was the worst, then the final test was executed the worst condition and test data were recorded in this report.

3.2. EUT Test Step

1	Setup the EUT shown on "Configuration of Test System Details".
2	Turn on the power of all equipment.
3	Turn on TX function.
4	EUT run test program.

Note : This module is placed on the control PCB board for tested.

3.3. Configuration of Test System Details

Conduction Emission / Radiated Emission

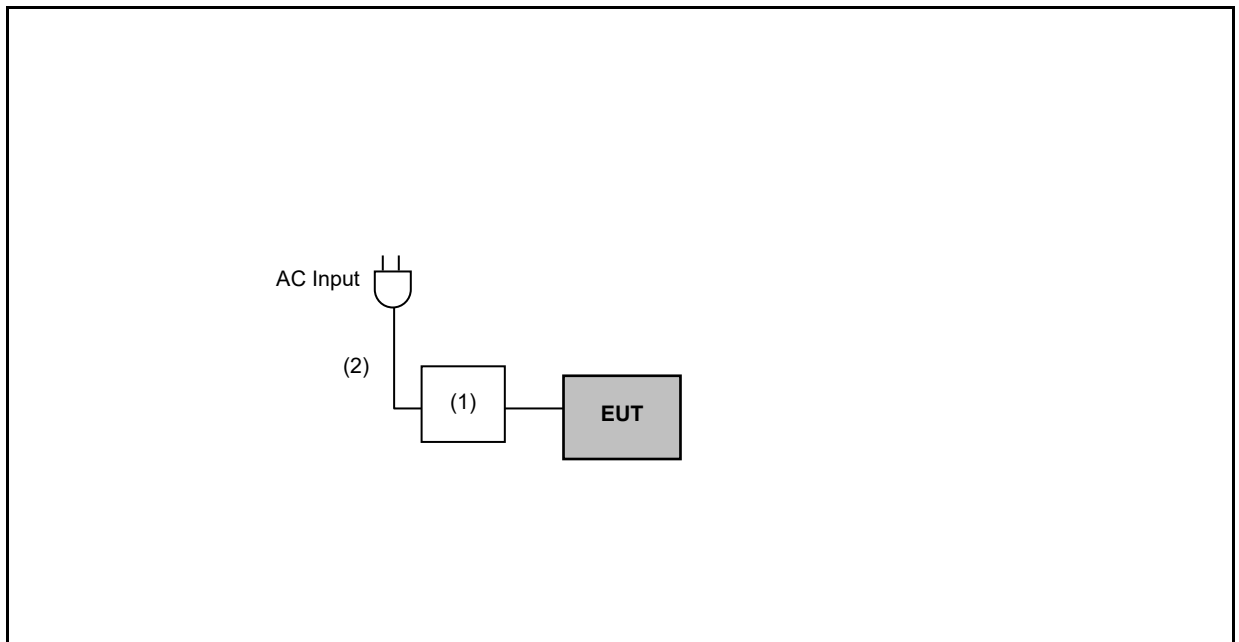

Devices Description					
	Product	Manufacturer	Model Number	Serial Number	Power Cord
(1)	Notebook	lenovo	T430	---	
(2)	Adapter	lenovo	92P1160	---	

3.4. Test Instruments

For Conducted Emission

Test Period: Apr. 11 ~ Apr. 14, 2023

Testing Engineer: Jayson Hsieh

Test Site		Conduction01-BD				
Use	Equipment	Manufacturer	Model Number	Serial Number	Cal. Date	Cal. Period
<input checked="" type="checkbox"/>	Test Receiver	R&S	ESCI	100367	May 19, 2022	1 year
<input checked="" type="checkbox"/>	LISN	R&S	ENV216	101040	Mar. 21, 2023	1 year
<input checked="" type="checkbox"/>	LISN	R&S	ENV216	101140	Jan. 12, 2023	1 year
<input checked="" type="checkbox"/>	RF Cable	Woken	00100D1380194M	TE-02-03	May 27, 2022	1 year
<input checked="" type="checkbox"/>	Software	EZ EMC	1.1.4.3	N/A	N.C.R.	---

For Conducted

Test Period: Mar. 29, 2023

Testing Engineer: Peter Shui

Test Site		RF01-BD				
Use	Equipment	Manufacturer	Model Number	Serial Number	Cal. Date	Cal. Period
<input checked="" type="checkbox"/>	Power Sensor	Agilent	N1921A	MY45241957	Nov. 30, 2022	1 year
<input checked="" type="checkbox"/>	Power Meter	Agilent	N1911A	MY45101619	Nov. 30, 2022	1 year
<input checked="" type="checkbox"/>	Spectrum Analyzer (20 Hz~26.5 GHz)	Agilent	N9020A	US47520902	Sep. 01, 2022	1 year
<input checked="" type="checkbox"/>	Bluetooth Tester	R&S	CBT	100350	Mar. 20, 2023	2 years

Note: N.C.R. = No Calibration Request.

For Radiated Emissions

Test Period: Mar. 27 ~ Apr. 18, 2023

Testing Engineer: Kerry Xu, Marc Yeh, Hung Chou

Test Site		96603-BD				
Radiation test sites		Semi Anechoic Room				
Use	Equipment	Manufacturer	Model Number	Serial Number	Cal. Date	Cal. Period
<input checked="" type="checkbox"/>	Spectrum Analyzer (10 Hz~44 GHz)	Keysight	N9020B	MY60112363	Jan. 13, 2023	1 year
<input checked="" type="checkbox"/>	Amplifier (100 kHz~1.3 GHz)	Agilent	8447D	2944A11119	Jan. 07, 2023	1 year
<input checked="" type="checkbox"/>	Broadband Amplifier (1 GHz~26.5 GHz)	Titan	T0912E01263025 A1F	002	Jul. 21, 2022	1 year
<input checked="" type="checkbox"/>	Trilog Broadband Antenna (30 MHz~1 GHz)	Schwarzbeck Mess-Elektronik	VULB9168	01146	Jul. 22, 2022	1 year
<input checked="" type="checkbox"/>	Broadband Horn Antenna (1 GHz~18 GHz)	Schwarzbeck Mess-Elektronik	9120D	02207	Jul. 13, 2022	1 year
<input checked="" type="checkbox"/>	Broadband Horn Antenna (18 GHz~40 GHz)	Schwarzbeck Mess-Elektronik	9170	9170-320	Aug. 25, 2022	1 year
<input checked="" type="checkbox"/>	Coaxial Cable	Titan	T0710AT327A10A 100	J11005	Aug. 04, 2022	1 year
<input checked="" type="checkbox"/>	Coaxial Cable	Titan	T0710AT327A10A 900	J11004	Aug. 04, 2022	1 year
<input checked="" type="checkbox"/>	Coaxial Cable	Titan	CFD400NL-LW	001	Aug. 04, 2022	1 year
<input checked="" type="checkbox"/>	Software	EZ EMC	1.1.4.4	N/A	N.C.R.	---

Note: N.C.R. = No Calibration Request.

3.5. Test Site Environment

Items	Required (IEC 60068-1)	Actual
Temperature (°C)	15-35	20-30
Humidity (%RH)	25-75	45-75

4 Measurement Procedure

4.1. AC Power Line Conducted Emission Measurement

■ Limit

Frequency (MHz)	Quasi-peak	Average
0.15 - 0.5	66 to 56	56 to 46
0.50 - 5.0	56	46
5.0 - 30.0	60	50

■ Test Setup

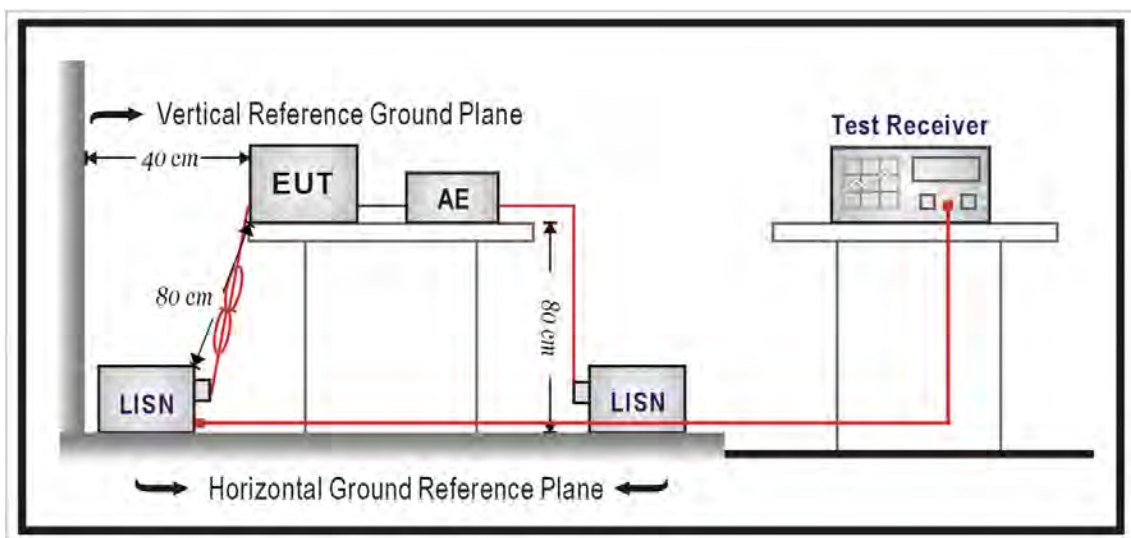

■ Test Procedure

The EUT and simulators are connected to the main power through a line impedance stabilization network (L.I.S.N.). This provides a $50 \Omega // 50 \mu\text{H}$ coupling impedance for the measuring equipment. The peripheral devices are also connected to the main power through a LISN that provides a $50 \Omega // 50 \mu\text{H}$ coupling impedance with 50 ohm termination.

Tabletop device shall be placed on a non-conducting platform, of nominal size 1 m by 1.5 m, raised 80 cm above the reference ground plane. The wall of screened room shall be located 40 cm to the rear of the EUT. Other surfaces of tabletop or floor standing EUT shall be at least 80 cm from any other ground conducting surface including one or more LISNs. For floor-standing device shall be placed under the EUT with a 12 mm insulating material.

Conducted emissions were investigated over the frequency range from 0.15 MHz to 30 MHz using a resolution bandwidth of 9 kHz. The equipment under test (EUT) shall be meet the limits in section 4.1, as applicable, including the average limit and the quasi-peak limit when using respectively, an average detector and quasi-peak detector measured in accordance with the methods described of related standard. When all of peak value were complied with quasi-peak and average limit from 150 kHz to 30 MHz then quasi-peak and average measurement was unnecessary.

The AMN shall be placed 0.8 m from the boundary of the unit under test and bonded to a ground reference plane for AMNs mounted on top of the ground reference plane. This distance is between the closest points of the AMN and the EUT. All other units of the EUT and associated equipment shall be at least 0.8 m from the AMN. If the mains power cable is longer than 1 m then the cable shall be folded back and forth at the centre of the lead to form a bundle no longer than 0.4 m. All of interconnecting cables that hang closer than 40 cm to the ground plane shall be folded back and forth in the center forming a bundle 30 cm to 40 cm long. All of EUT and AE shall be separate place more than 0.1 m. All 50Ω ports of the LISN shall be resistively terminated into 50Ω loads when not connected to the measuring instrument.

If the reading of the measuring receiver shows fluctuations close to the limit, the reading shall be observed for at least 15 s at each measurement frequency; the higher reading shall be recorded with the exception of any brief isolated high reading which shall be ignored.

4.2. Radiated Emission Measurement

■ Limit

According to §15.209(a), except as provided elsewhere in this subpart, the emissions from an intentional radiator shall not exceed the field strength levels specified in the following table:

Frequency (MHz)	Field Strength ($\mu\text{V}/\text{m}$ at meter)	Measurement Distance (meters)
0.009 – 0.490	$2400 / F$ (kHz)	300
0.490 – 1.705	$24000 / F$ (kHz)	30
1.705 – 30.0	30	30
30 - 88	100**	3
88-216	150**	3
216-960	200**	3
Above 960	500	3

** Except as provided in paragraph (g), fundamental emissions from intentional radiators operating under this Section shall not be located in the frequency bands 54-72 MHz, 76-88 MHz, 174-216 MHz or 470-806 MHz. However, operation within these frequency bands is permitted under other sections of this Part, e.g., Sections 15.231 and 15.241.

■ Setup

9 kHz ~ 30 MHz

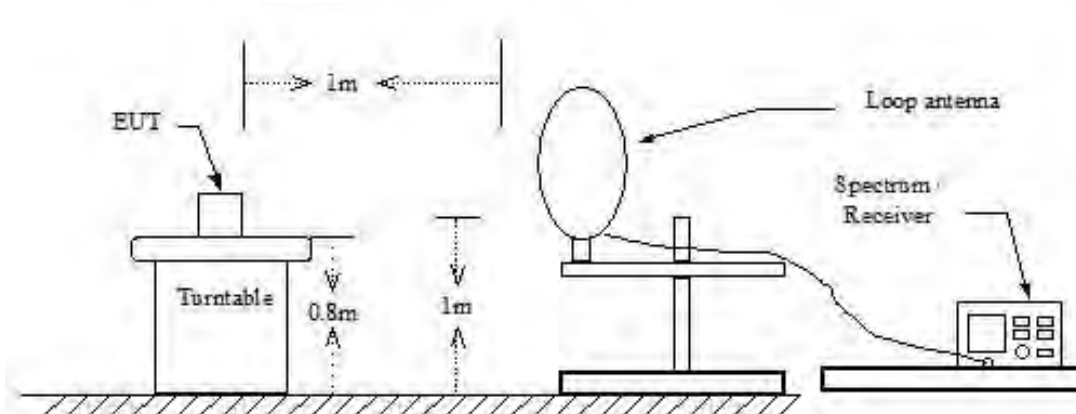

Below 1 GHz

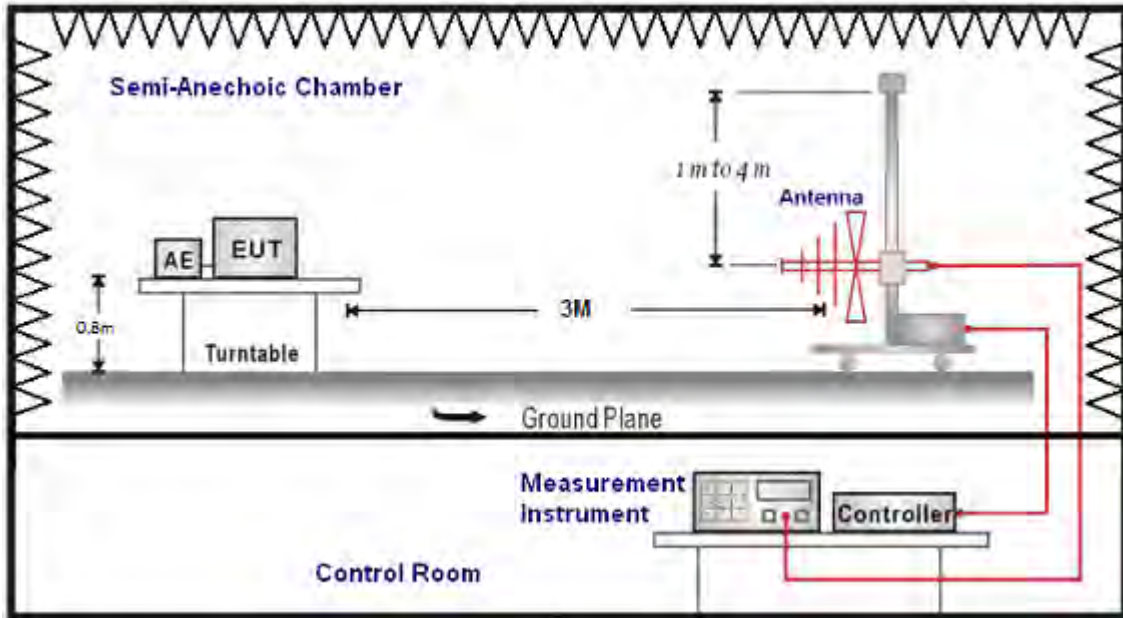

Above 1 GHz

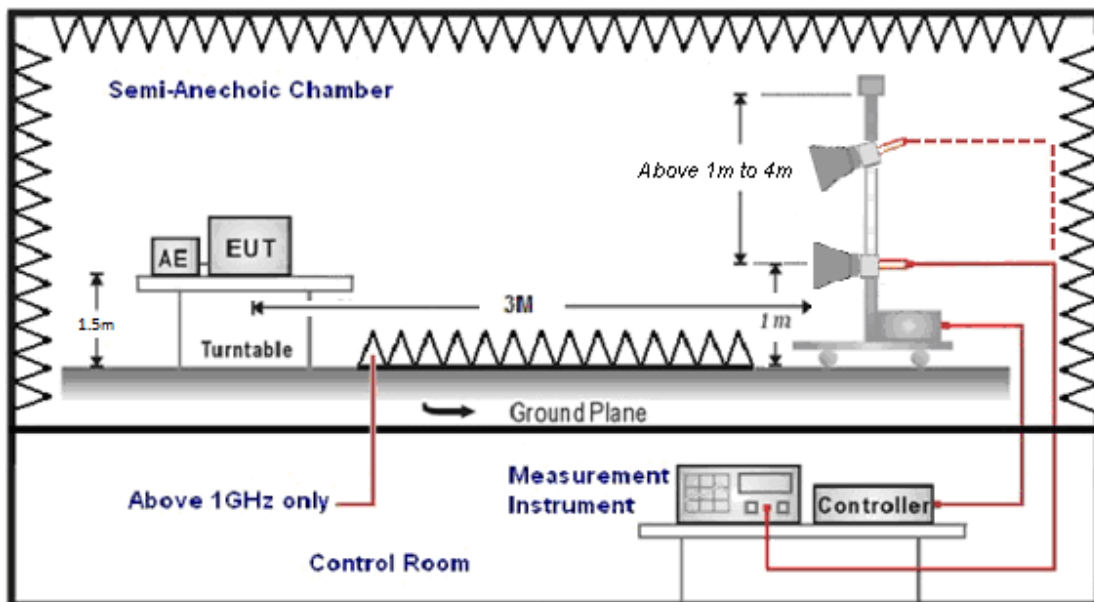

■ Test Procedure

Final radiation measurements were made on a three-meter, Semi Anechoic Chamber. The EUT system was placed on a nonconductive turntable which is 0.8 or 1.5 meters height, top surface 1.0 x 1.5 meter. The spectrum was examined from 250 MHz to 2.5 GHz in order to cover the whole spectrum below 10th harmonic which could generate from the EUT. During the test, EUT was set to transmit continuously & Measurements spectrum range from 9 kHz to 26.5 GHz is investigated.

For measurements below 30 MHz the resolution bandwidth is set to 10 kHz for peak detection measurements or 9 kHz for quasi-peak detection measurements. The video bandwidth is 3 times of the resolution bandwidth.

For measurements below 1 GHz the resolution bandwidth is set to 100 kHz for peak detection measurements or 120 kHz for quasi-peak detection measurements. Peak detection is used unless otherwise noted as quasi-peak.

For measurements above 1 GHz the resolution bandwidth is set to 1 MHz, and then the video bandwidth is set to 3 MHz for peak measurements and 10 Hz for average measurements when Duty cycle >0.98 / 1/T for average measurements when Duty cycle <0.98. A nonconductive material surrounded the EUT to supporting the EUT for standing on three orthogonal planes. At each condition, the EUT was rotated 360 degrees, and the antenna was raised and lowered from one to four meters to find the maximum emission levels. Measurements were taken using both horizontal and vertical antenna polarization.

SCHWARZBECK MESS-ELEKTRONIK Biconilog Antenna at 3 Meter and the SCHWARZBECK Double Ridged Guide Antenna was used in frequencies 1 –26.5 GHz at a distance of 3 meter. The antenna at an angle toward the source of the emission. All test results were extrapolated to equivalent signal at 3 meters utilizing an inverse linear distance extrapolation Factor (20 dB/decade).

For testing above 1 GHz, the emission level of the EUT in peak mode was 20 dB lower than average limit (that means the emission level in peak mode also complies with the limit in average mode), then testing will be stopped and peak values of EUT will be reported, otherwise, the emissions will be measured in average mode again and reported.

Appropriate preamplifiers were used for improving sensitivity and precautions were taken to avoid overloading or desensitizing the spectrum analyzer. No post – detector video filters were used in the test.

The spectrum analyzer's 6 dB bandwidth was set to 1 MHz, and the analyzer was operated in the peak detection mode, for frequencies both below and up 1 GHz. The average levels were obtained by subtracting the duty cycle correction factor from the peak readings.

The following procedures were used to convert the emission levels measured in decibels referenced to 1 microvolt (dBuV) into field intensity in micro volts pre meter (uV/m).

The actual field intensity in decibels referenced to 1 microvolt in to field intensity in micro volts per meter (dBuV/m).

The actual field intensity in decibels referenced to 1 microvolt per meter (dBuV/m) is determined by algebraically adding the measured reading in dBuV, the antenna factor (dB), and cable loss (dB) and Subtracting the gain of preamplifier (dB) is auto calculate in spectrum analyzer.

$$(1) \text{ Amplitude (dBuV/m) = FI (dBuV) +AF (dBuV) +CL (dBuV)-Gain (dB)}$$

FI= Reading of the field intensity.

AF= Antenna factor.

CL= Cable loss.

P.S Amplitude is auto calculate in spectrum analyzer.

$$(2) \text{ Actual Amplitude (dBuV/m) = Amplitude (dBuV)-Dis(dB)}$$

The FCC specified emission limits were calculated according the EUT operating frequency and by following linear interpolation equations:

(a) For fundamental frequency : Transmitter Output < +30 dBm

(b) For spurious frequency : Spurious emission limits = fundamental emission limit /10

Data of measurement within this frequency range without mark in the table above means the reading of emissions are attenuated more than 20 dB below the permissible limits or the field strength is too small to be measured.

4.3. Maximum Conducted Output Power Measurement

■ **Limit**

For systems using digital modulation in the 2400-2483.5 MHz, the limit for peak output power is 30 dBm.

■ **Test Setup**

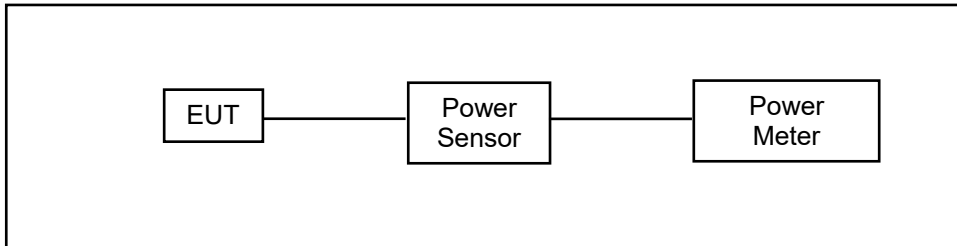

■ **Test Procedure**

The testing follows the Measurement Procedure of ANSI C63.10:2013 section 11.9.2.3.2 Method AVGPM.

The tests below are run with the EUT's transmitter set at high power in TX mode. The EUT is needed to force selection of output power level and channel number. While testing, EUT was set to transmit continuously. Remove the Subjective device's antenna and connect the RF output port to power sensor..

4.4. 6 dB RF Bandwidth Measurement

■ **Limit**

6 dB RF Bandwidth: Systems using digital modulation techniques may operate in the 2400–2483.5 MHz bands. The minimum 6 dB band-width shall be at least 500 kHz.

99 % Occupied Bandwidth: N/A

■ **Test Setup**

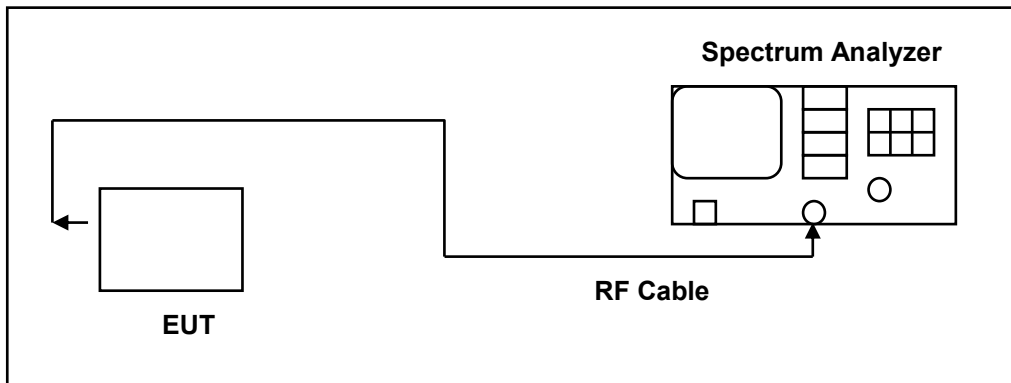

■ **Test Procedure**

The EUT tested to DTS test procedure of ANSI C63.10:2013 section 11.8.2 option2 for compliance to FCC 47CFR 15.247 requirements.

6 dB RF Bandwidth: The antenna port of the EUT was connected to the input of a spectrum analyzer. Analyzer RBW was set to 100 kHz. For each RF output channel investigated, the spectrum analyzer center frequency was set to the channel carrier. A peak output reading was taken, a DISPLAY line was drawn 6 dB lower than peak level. The 6 dB bandwidth was determined from where the channel output spectrum intersected the display line.

The test was performed at 3 channels (Channel low, middle, high)

4.5. Maximum Power Density Measurement

■ Limit

For digitally modulated systems, the power spectral density conducted from the intentional radiator to the antenna shall not be greater than 8 dBm in any 3 kHz band during any time interval of continuous transmission.

■ Test Setup

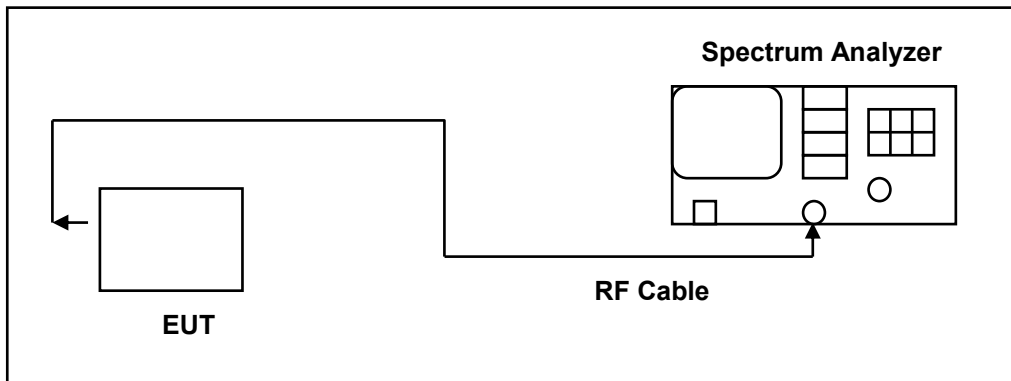

■ Test Procedure

The EUT tested to DTS test procedure of ANSI C63.10:2013 section 11.10.2 Method PKPSD.

1. Set analyzer center frequency to DTS channel center frequency.
2. Set the span to 1.5 times the DTS bandwidth.
3. Set the RBW to: $3 \text{ kHz} \leq \text{RBW} \leq 100 \text{ kHz}$.
4. Set the VBW $\geq 3 \times \text{RBW}$.
5. Detector = peak.
6. Sweep time = auto couple.
7. Trace mode = max hold.
8. Allow trace to fully stabilize.
9. Use the peak marker function to determine the maximum amplitude level within the RBW.
10. If measured value exceeds limit, reduce RBW (no less than 3 kHz) and repeat.

4.6. Out of Band Conducted Emissions Measurement

■ Limit

In any 100 kHz bandwidth outside the frequency band in which the spread spectrum or digitally modulated intentional radiator is operating, the radio frequency power that is produced by the intentional radiator shall be at least 20 dB below that in the 100 kHz bandwidth within the band that contains the highest level of the desired power

■ Test Setup

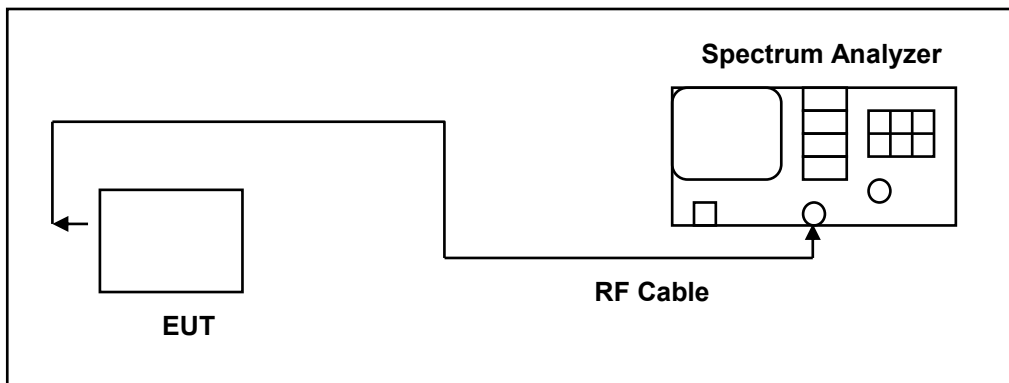

■ Test Procedure

In any 100 kHz bandwidth outside the EUT pass band, the RF power produced by the modulation products of the spreading sequence, the information sequence, and the carrier frequency shall be at least 20 dB below that of the maximum in-band 100 kHz emission, antenna output of the EUT was coupled directly to spectrum analyzer; if an external attenuator and/or cable was used, these losses are compensated for with the analyzer OFFSET function.

All other types of emissions from the EUT shall meet the general limits for radiated frequencies outside the pass band. The test was performed at 3 channels.

4.7. Antenna Measurement

■ Limit

For intentional device, according to 15.203, an intentional radiator shall be designed to ensure that no antenna other than that furnished by the responsible party shall be used with the device.

And According to 15.247 (b), if transmitting antennas of directional gain greater than 6 dBi are used, the power shall be reduced by the amount in dB that the directional gain of the antenna exceeds 6 dBi.

■ Antenna Connector Construction

See section 2 – antenna information.

5 Test Results

5.1. Conducted Emission

Standard:	FCC Part 15.247	Line:	L1
Test item:	Conducted Emission	Power:	AC 120 V/60 Hz
Mode:	Transmit Mode		
Description:	Antenna brand: iRobot		

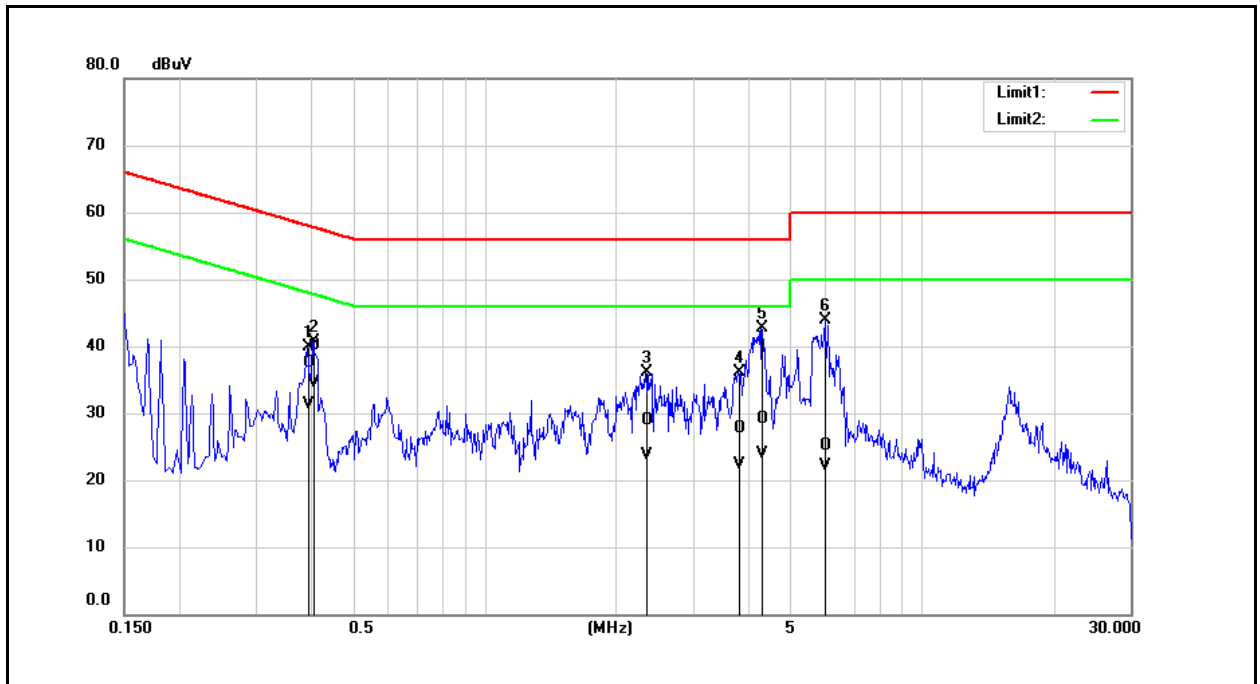

No.	Frequency (MHz)	QP reading (dBuV)	AVG reading (dBuV)	Correction factor (dB)	QP result (dBuV)	AVG result (dBuV)	QP limit (dBuV)	AVG limit (dBuV)	QP margin (dB)	AVG margin (dB)	Remark
1	0.3940	27.99	21.80	9.60	37.59	31.40	57.98	47.98	-20.39	-16.58	Pass
2	0.4060	30.55	24.88	9.60	40.15	34.48	57.73	47.73	-17.58	-13.25	Pass
3	2.3420	19.27	14.08	9.67	28.94	23.75	56.00	46.00	-27.06	-22.25	Pass
4	3.8060	17.90	12.66	9.72	27.62	22.38	56.00	46.00	-28.38	-23.62	Pass
5	4.3060	19.45	14.17	9.73	29.18	23.90	56.00	46.00	-26.82	-22.10	Pass
6	6.0020	15.37	12.43	9.77	25.14	22.20	60.00	50.00	-34.86	-27.80	Pass

Note: 1. Result (dBuV) = Correction factor (dB) + Reading(dBuV).

2. Correction factor (dB) = Cable loss (dB) + L.I.S.N. factor (dB).

Standard:	FCC Part 15.247	Line:	N
Test item:	Conducted Emission	Power:	AC 120 V/60 Hz
Mode:	Transmit Mode		
Description:	Antenna brand: iRobot		

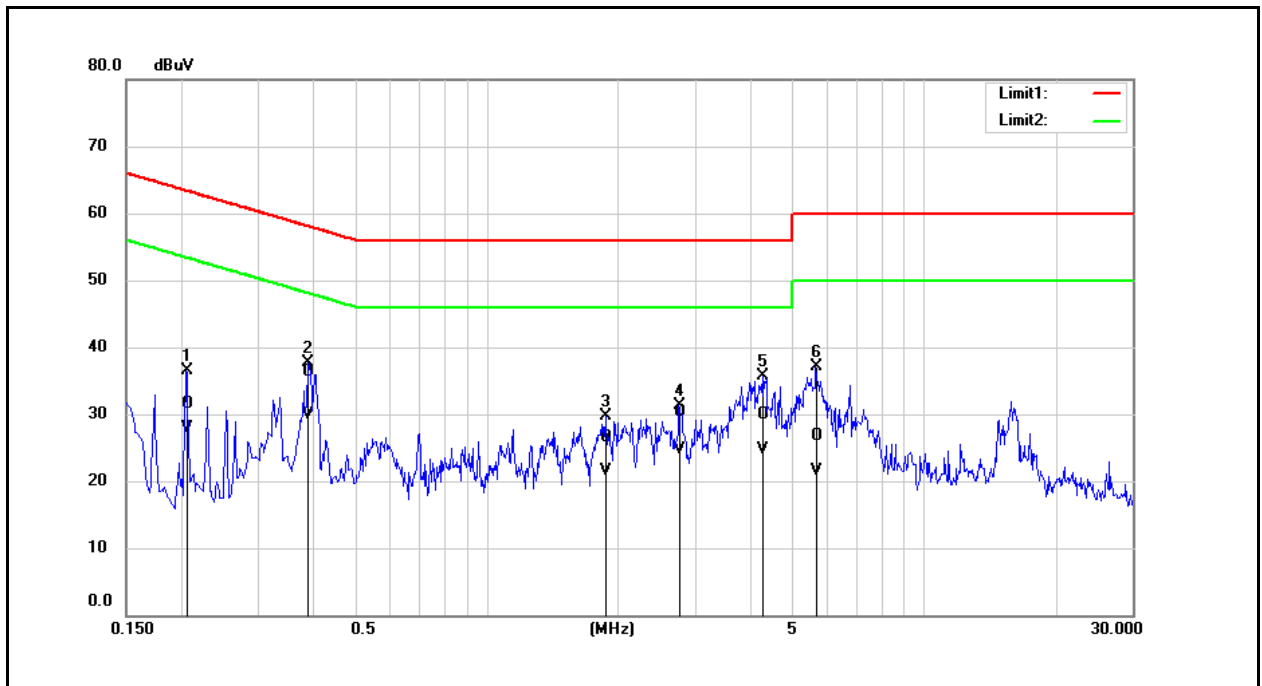

No.	Frequency (MHz)	QP reading (dBuV)	AVG reading (dBuV)	Correction factor (dB)	QP result (dBuV)	AVG result (dBuV)	QP limit (dBuV)	AVG limit (dBuV)	QP margin (dB)	AVG margin (dB)	Remark
1	0.2060	22.02	18.24	9.58	31.60	27.82	63.37	53.37	-31.77	-25.55	Pass
2	0.3914	26.76	20.26	9.59	36.35	29.85	58.03	48.03	-21.68	-18.18	Pass
3	1.8740	16.87	11.78	9.66	26.53	21.44	56.00	46.00	-29.47	-24.56	Pass
4	2.7620	20.55	15.03	9.69	30.24	24.72	56.00	46.00	-25.76	-21.28	Pass
5	4.2860	20.27	14.91	9.73	30.00	24.64	56.00	46.00	-26.00	-21.36	Pass
6	5.6660	16.88	11.69	9.77	26.65	21.46	60.00	50.00	-33.35	-28.54	Pass

Note: 1. Result (dBuV) = Correction factor (dB) + Reading(dBuV).

2. Correction factor (dB) = Cable loss (dB) + L.I.S.N. factor (dB).

Standard:	FCC Part 15.247	Line:	L1
Test item:	Conducted Emission	Power:	AC 120 V/60 Hz
Mode:	Transmit Mode		
Description:	Antenna brand: ABRACON		

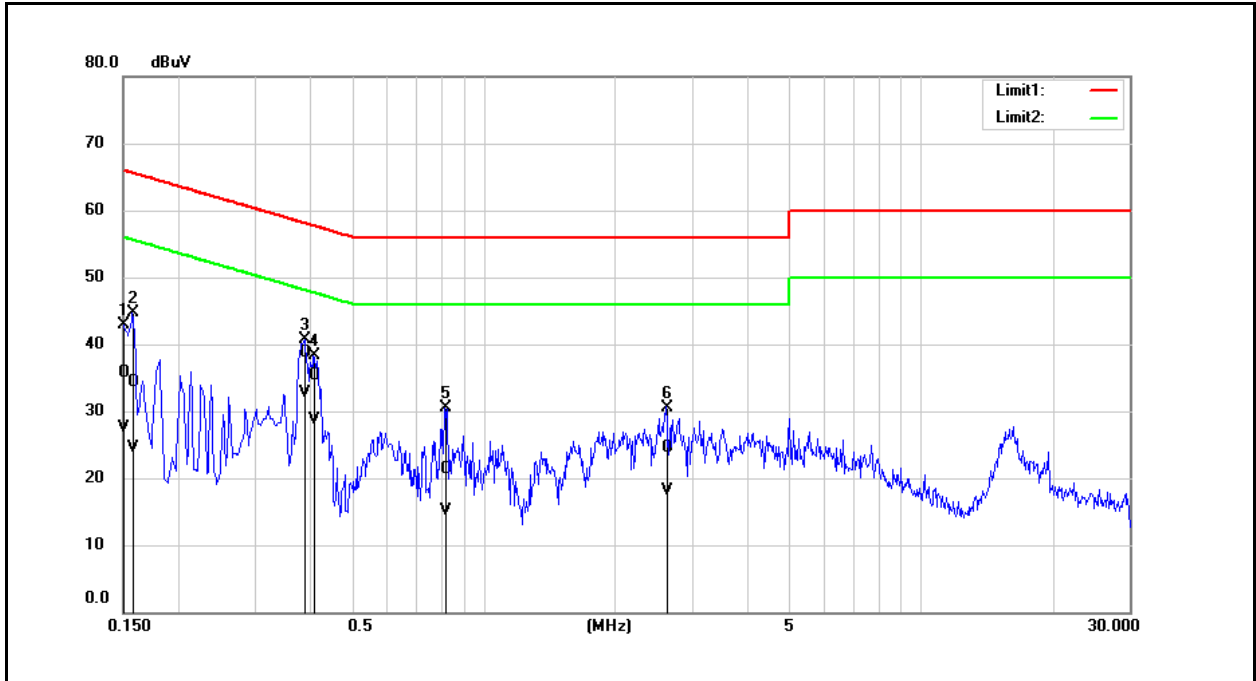

No.	Frequency (MHz)	QP reading (dBuV)	AVG reading (dBuV)	Correction factor (dB)	QP result (dBuV)	AVG result (dBuV)	QP limit (dBuV)	AVG limit (dBuV)	QP margin (dB)	AVG margin (dB)	Remark
1	0.1500	26.17	17.88	9.59	35.76	27.47	66.00	56.00	-30.24	-28.53	Pass
2	0.1580	24.70	14.84	9.59	34.29	24.43	65.57	55.57	-31.28	-31.14	Pass
3	0.3900	29.05	23.09	9.60	38.65	32.69	58.06	48.06	-19.41	-15.37	Pass
4	0.4100	25.78	19.05	9.60	35.38	28.65	57.65	47.65	-22.27	-19.00	Pass
5	0.8140	11.71	5.57	9.62	21.33	15.19	56.00	46.00	-34.67	-30.81	Pass
6	2.6220	14.83	8.37	9.68	24.51	18.05	56.00	46.00	-31.49	-27.95	Pass

Note: 1. Result (dBuV) = Correction factor (dB) + Reading(dBuV).

2. Correction factor (dB) = Cable loss (dB) + L.I.S.N. factor (dB).

Standard:	FCC Part 15.247	Line:	N
Test item:	Conducted Emission	Power:	AC 120 V/60 Hz
Mode:	Transmit Mode		
Description:	Antenna brand: ABRACON		

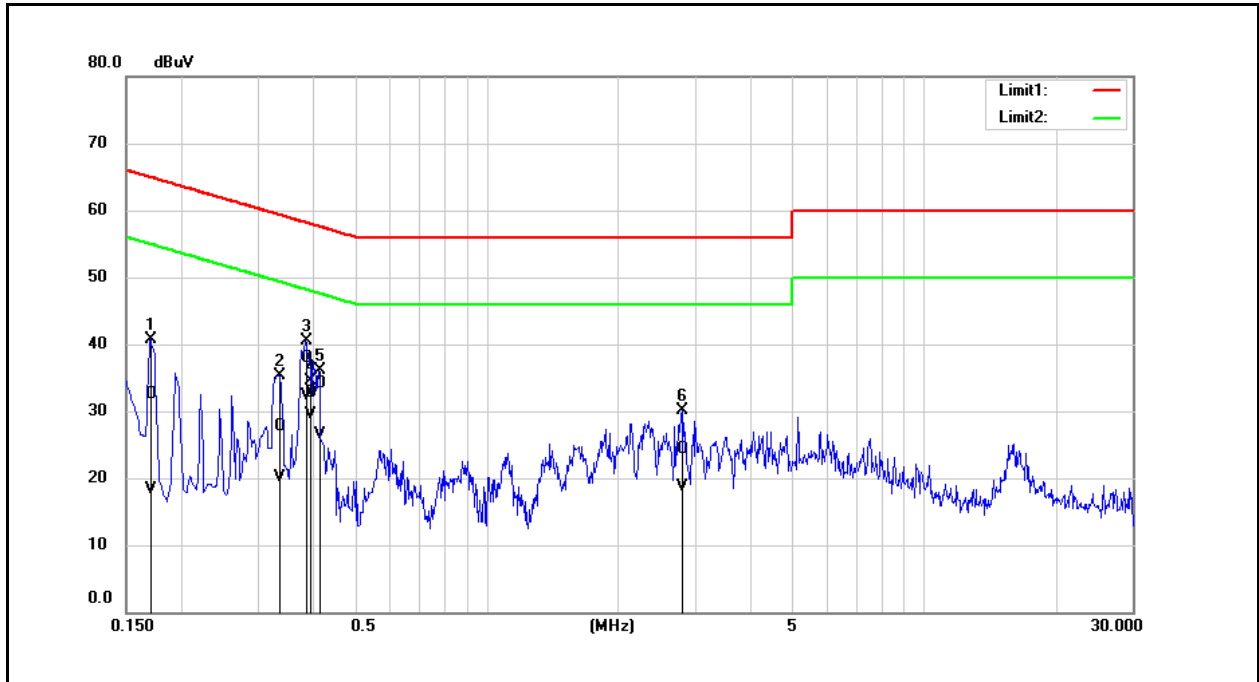

No.	Frequency (MHz)	QP reading (dBuV)	AVG reading (dBuV)	Correction factor (dB)	QP result (dBuV)	AVG result (dBuV)	QP limit (dBuV)	AVG limit (dBuV)	QP margin (dB)	AVG margin (dB)	Remark
1	0.1700	22.96	8.71	9.59	32.55	18.30	64.96	54.96	-32.41	-36.66	Pass
2	0.3340	18.15	10.55	9.59	27.74	20.14	59.35	49.35	-31.61	-29.21	Pass
3	0.3860	28.24	22.77	9.60	37.84	32.37	58.15	48.15	-20.31	-15.78	Pass
4	0.3940	23.04	20.00	9.60	32.64	29.60	57.98	47.98	-25.34	-18.38	Pass
5	0.4140	24.55	16.95	9.60	34.15	26.55	57.57	47.57	-23.42	-21.02	Pass
6	2.8020	14.71	8.93	9.69	24.40	18.62	56.00	46.00	-31.60	-27.38	Pass

Note: 1. Result (dBuV) = Correction factor (dB) + Reading(dBuV).

2. Correction factor (dB) = Cable loss (dB) + L.I.S.N. factor (dB).

Standard:	FCC Part 15.247	Line:	L1
Test item:	Conducted Emission	Power:	AC 120 V/60 Hz
Mode:	Transmit Mode		
Description:	Antenna brand: Laird		

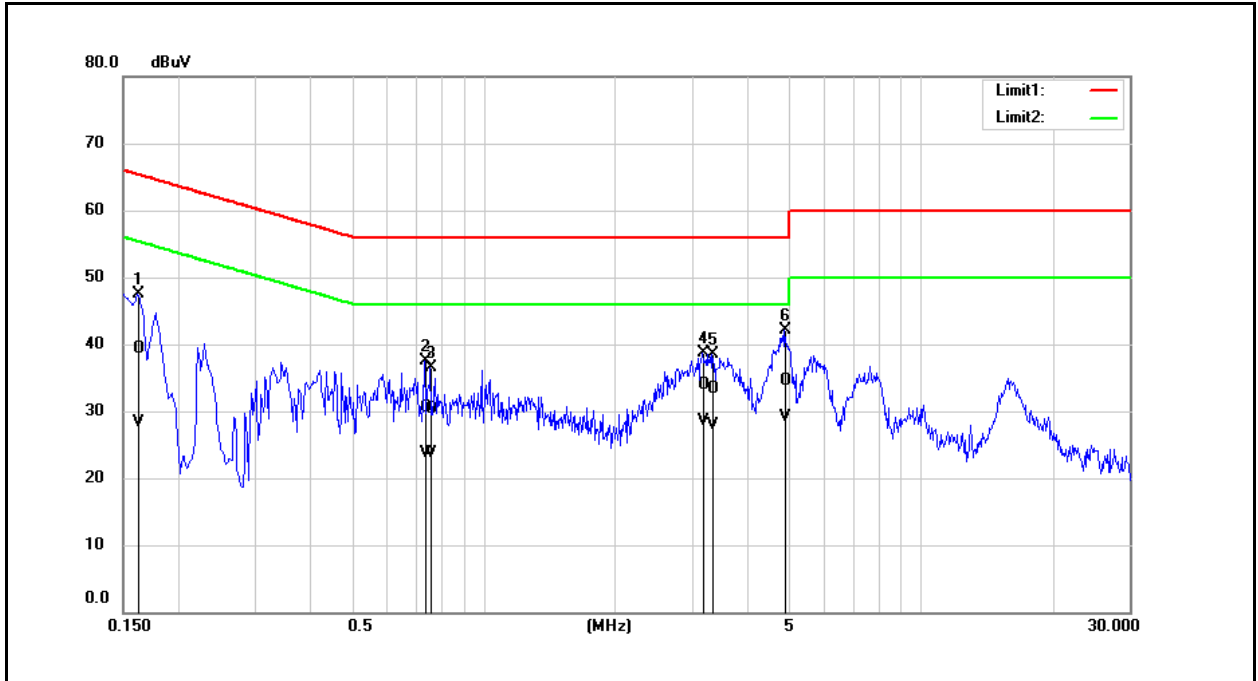

No.	Frequency (MHz)	QP reading (dBuV)	AVG reading (dBuV)	Correction factor (dB)	QP result (dBuV)	AVG result (dBuV)	QP limit (dBuV)	AVG limit (dBuV)	QP margin (dB)	AVG margin (dB)	Remark
1	0.1620	29.71	18.81	9.59	39.30	28.40	65.36	55.36	-26.06	-26.96	Pass
2	0.7340	20.86	14.08	9.62	30.48	23.70	56.00	46.00	-25.52	-22.30	Pass
3	0.7580	20.73	14.11	9.62	30.35	23.73	56.00	46.00	-25.65	-22.27	Pass
4	3.1620	24.28	18.87	9.69	33.97	28.56	56.00	46.00	-22.03	-17.44	Pass
5	3.3300	23.66	18.22	9.70	33.36	27.92	56.00	46.00	-22.64	-18.08	Pass
6	4.8940	24.80	19.32	9.75	34.55	29.07	56.00	46.00	-21.45	-16.93	Pass

Note: 1. Result (dBuV) = Correction factor (dB) + Reading(dBuV).

2. Correction factor (dB) = Cable loss (dB) + L.I.S.N. factor (dB).

Standard:	FCC Part 15.247	Line:	N
Test item:	Conducted Emission	Power:	AC 120 V/60 Hz
Mode:	Transmit Mode		
Description:	Antenna brand: Laird		

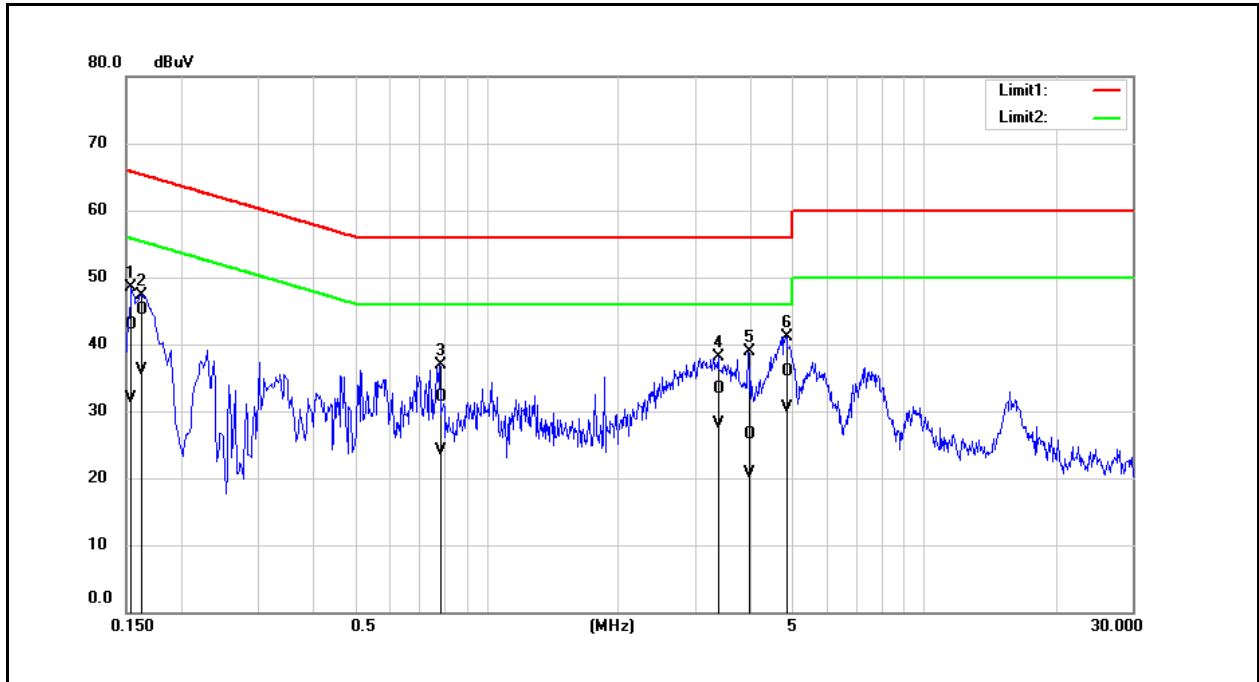

No.	Frequency (MHz)	QP reading (dBuV)	AVG reading (dBuV)	Correction factor (dB)	QP result (dBuV)	AVG result (dBuV)	QP limit (dBuV)	AVG limit (dBuV)	QP margin (dB)	AVG margin (dB)	Remark
1	0.1540	33.42	22.26	9.58	43.00	31.84	65.78	55.78	-22.78	-23.94	Pass
2	0.1620	35.62	26.58	9.58	45.20	36.16	65.36	55.36	-20.16	-19.20	Pass
3	0.7820	22.50	14.41	9.61	32.11	24.02	56.00	46.00	-23.89	-21.98	Pass
4	3.3900	23.70	18.44	9.70	33.40	28.14	56.00	46.00	-22.60	-17.86	Pass
5	3.9740	16.87	11.04	9.72	26.59	20.76	56.00	46.00	-29.41	-25.24	Pass
6	4.8620	26.25	20.76	9.75	36.00	30.51	56.00	46.00	-20.00	-15.49	Pass

Note: 1. Result (dBuV) = Correction factor (dB) + Reading(dBuV).

2. Correction factor (dB) = Cable loss (dB) + L.I.S.N. factor (dB).

5.2. Conducted Test Results

Duty cycle

Reference Appendix A / Appendix B

Maximum Conducted Output Power Measurement

Reference Appendix A

6 dB RF Bandwidth Measurement

Reference Appendix A / Appendix B

Maximum Power Density Measurement

Reference Appendix A / Appendix B

Out of Band Conducted Emissions Measurement

Reference level

Reference Appendix B

Out of Band Conducted Emissions

Reference Appendix B

Conducted Band Edge

Reference Appendix B

5.3. Radiated Emission Measurement

Antenna brand: iRobot

Below 1 GHz

Standard:	Part 15C	Test Site:	966 Chamber
Polarization:	Horizontal		
Test Mode:	BLE 2M 2402 MHz		
Remark:			

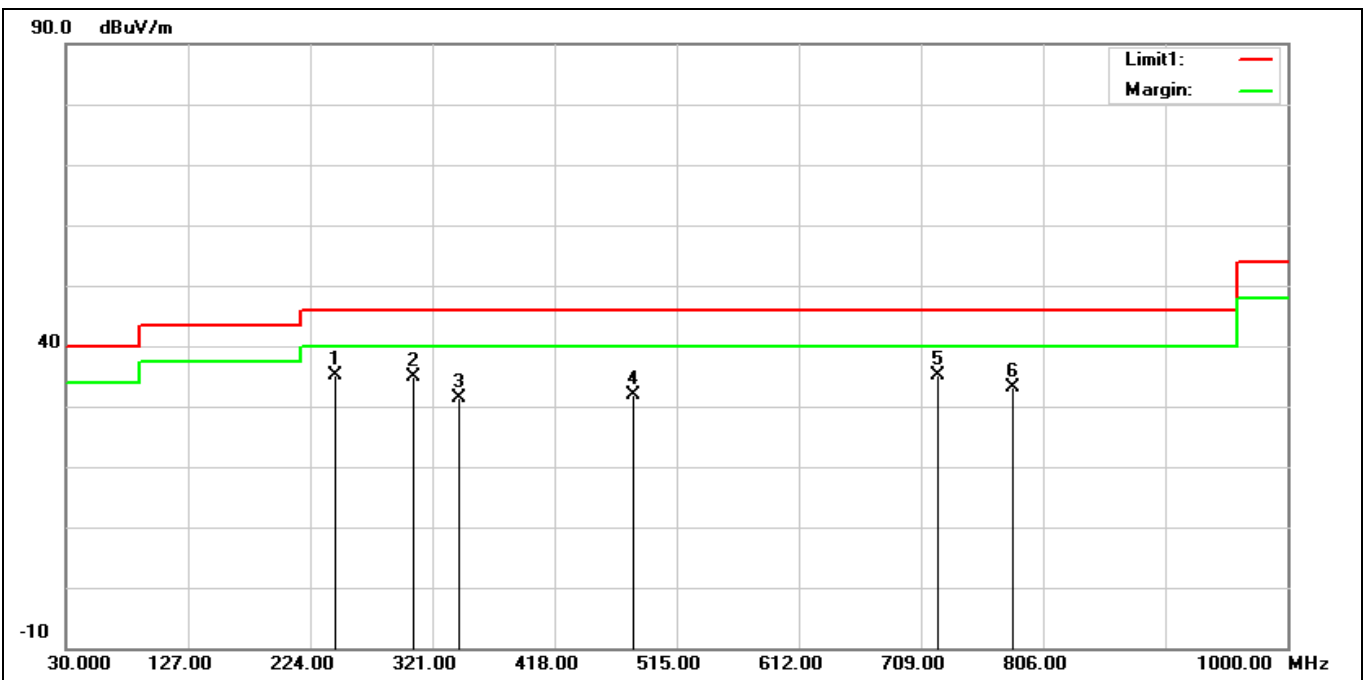

No.	Frequency (MHz)	Reading (dBuV)	Correction (dB/m)	Result (dBuV/m)	Limit (dBuV/m)	Margin (dB)	Remark
1*	243.4000	42.77	-7.55	35.22	46.00	-10.78	QP
2	306.4500	40.60	-5.67	34.93	46.00	-11.07	QP
3	342.3400	36.26	-4.90	31.36	46.00	-14.64	QP
4	480.0800	34.03	-2.20	31.83	46.00	-14.17	QP
5	722.5800	32.85	2.17	35.02	46.00	-10.98	QP
6	781.7500	29.68	3.41	33.09	46.00	-12.91	QP

Standard:	Part 15C	Test Site:	966 Chamber
Polarization:	Vertical		
Test Mode:	BLE 2M 2402 MHz		
Remark:			

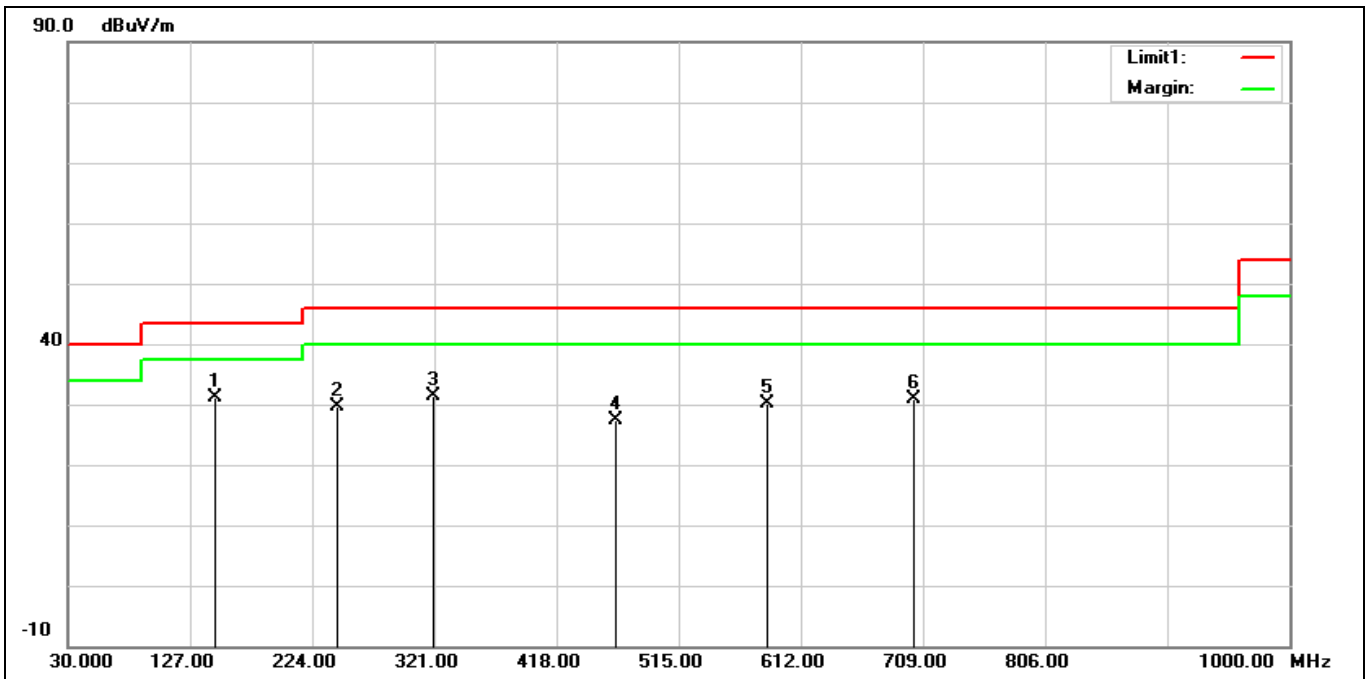

No.	Frequency (MHz)	Reading (dBuV)	Correction (dB/m)	Result (dBuV/m)	Limit (dBuV/m)	Margin (dB)	Remark
1*	147.3700	38.33	-7.24	31.09	43.50	-12.41	QP
2	244.3700	37.20	-7.52	29.68	46.00	-16.32	QP
3	320.0300	36.79	-5.38	31.41	46.00	-14.59	QP
4	465.5300	29.74	-2.38	27.36	46.00	-18.64	QP
5	585.8100	30.32	-0.13	30.19	46.00	-15.81	QP
6	701.2400	29.28	1.64	30.92	46.00	-15.08	QP

Harmonic

Above 1 GHz

Standard:	Part 15C	Test Site:	966 Chamber
Polarization:	Horizontal		
Test Mode:	BLE 2M 2402 MHz		
Remark:			

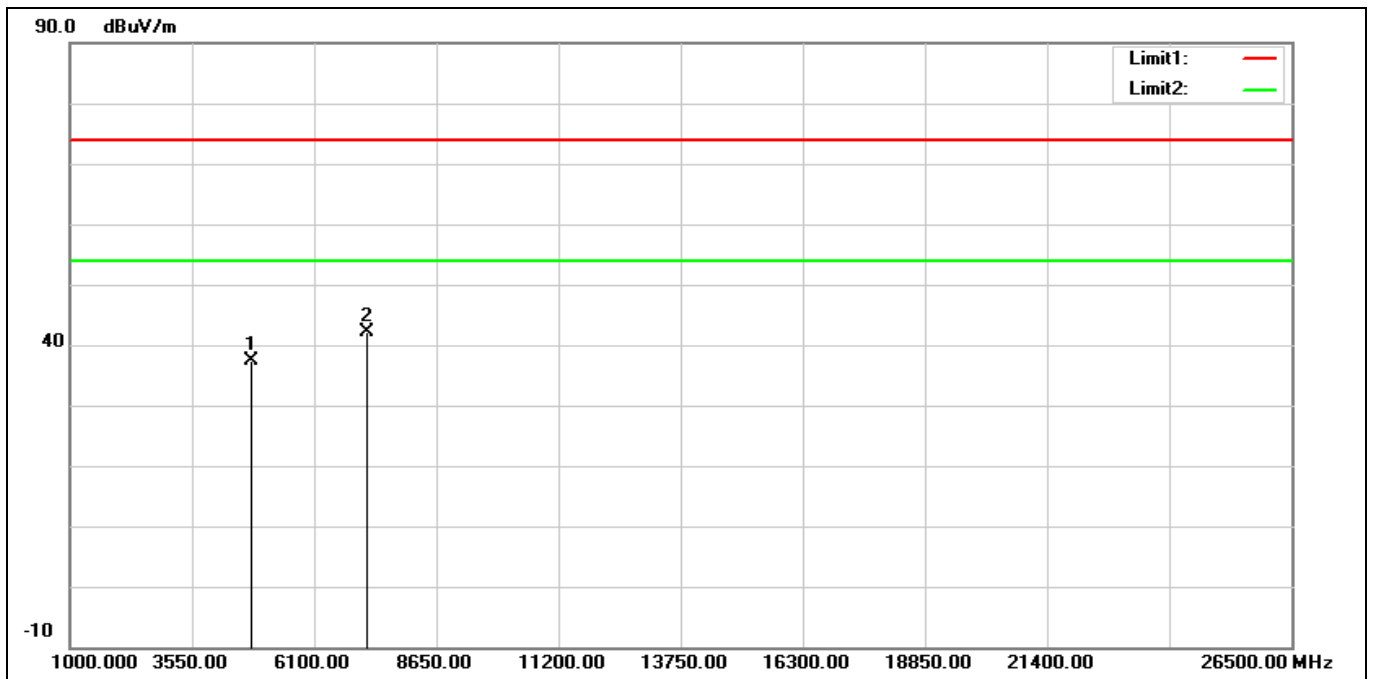

No.	Frequency (MHz)	Reading (dBuV)	Correction (dB/m)	Result (dBuV/m)	Limit (dBuV/m)	Margin (dB)	Remark
1	4804.000	37.10	0.29	37.39	74.00	-36.61	peak
2*	7206.000	34.20	7.82	42.02	74.00	-31.98	peak

Standard:	Part 15C	Test Site:	966 Chamber
Polarization:	Vertical		
Test Mode:	BLE 2M 2402 MHz		
Remark:			

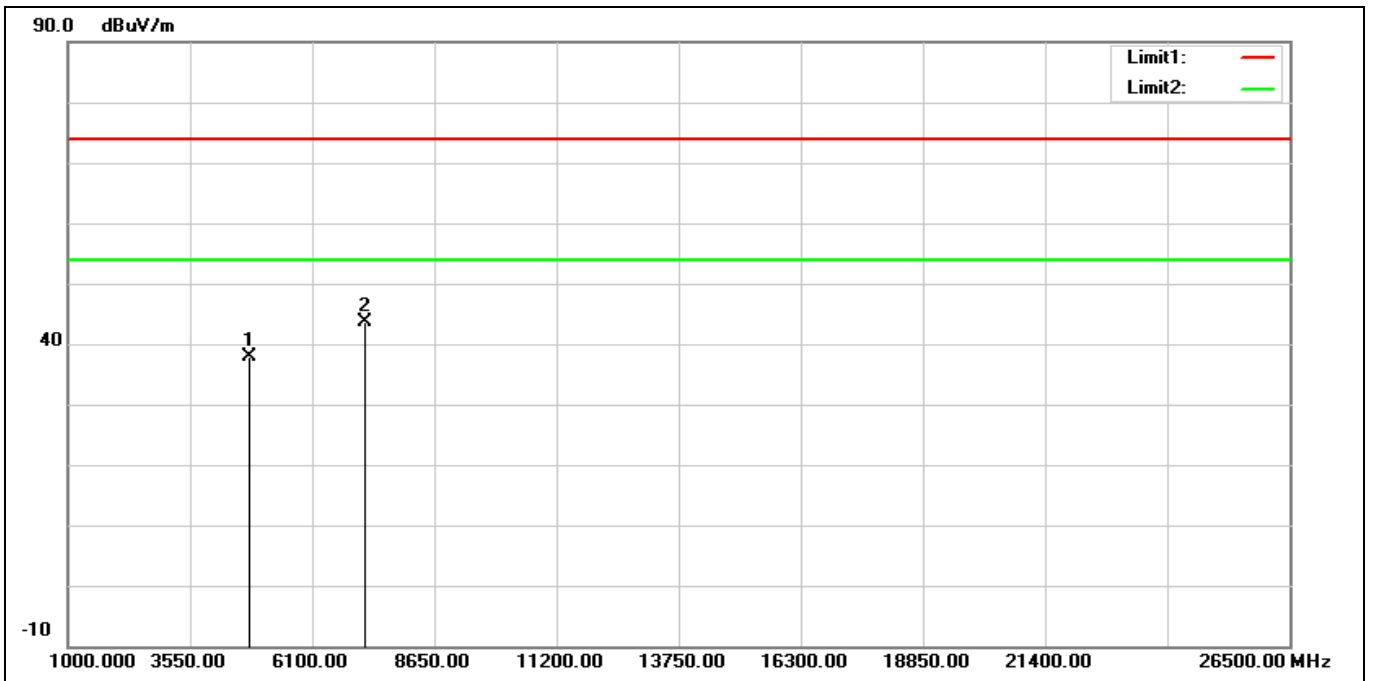

No.	Frequency (MHz)	Reading (dBuV)	Correction (dB/m)	Result (dBuV/m)	Limit (dBuV/m)	Margin (dB)	Remark
1	4804.000	37.57	0.29	37.86	74.00	-36.14	peak
2*	7206.000	35.89	7.82	43.71	74.00	-30.29	peak

Standard:	Part 15C	Test Site:	966 Chamber
Polarization:	Horizontal		
Test Mode:	BLE 2M 2440 MHz		
Remark:			

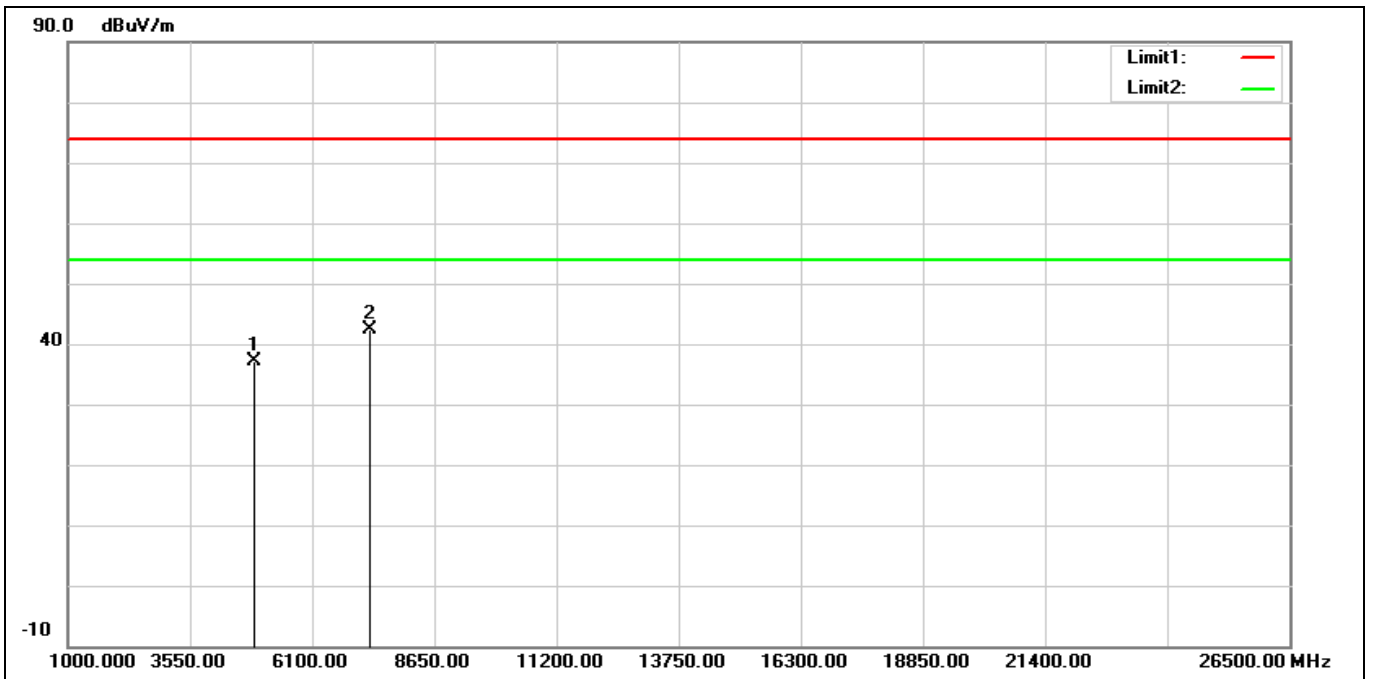

No.	Frequency (MHz)	Reading (dBuV)	Correction (dB/m)	Result (dBuV/m)	Limit (dBuV/m)	Margin (dB)	Remark
1	4880.000	36.75	0.38	37.13	74.00	-36.87	peak
2*	7320.000	34.35	7.99	42.34	74.00	-31.66	peak

Standard:	Part 15C	Test Site:	966 Chamber
Polarization:	Vertical		
Test Mode:	BLE 2M 2440 MHz		
Remark:			

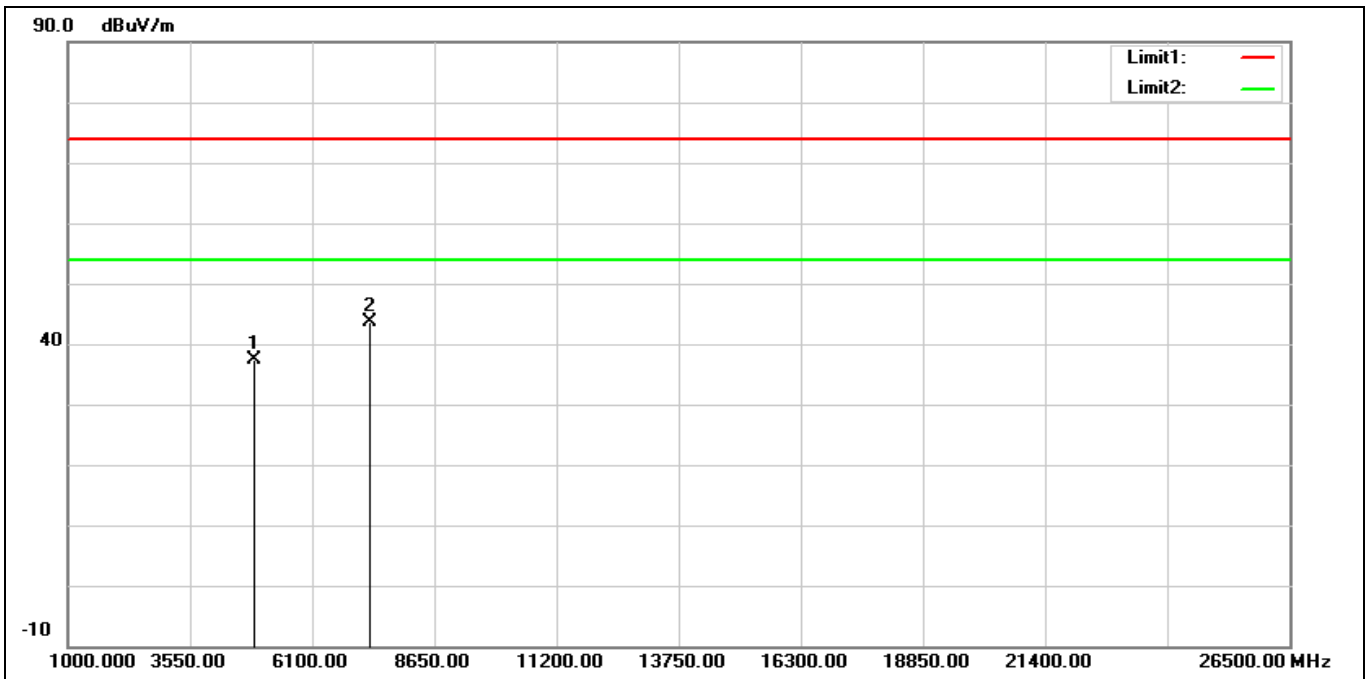

No.	Frequency (MHz)	Reading (dBuV)	Correction (dB/m)	Result (dBuV/m)	Limit (dBuV/m)	Margin (dB)	Remark
1	4880.000	36.97	0.38	37.35	74.00	-36.65	peak
2*	7320.000	35.52	7.99	43.51	74.00	-30.49	peak

Standard:	Part 15C	Test Site:	966 Chamber
Polarization:	Horizontal		
Test Mode:	BLE 2M 2480 MHz		
Remark:			

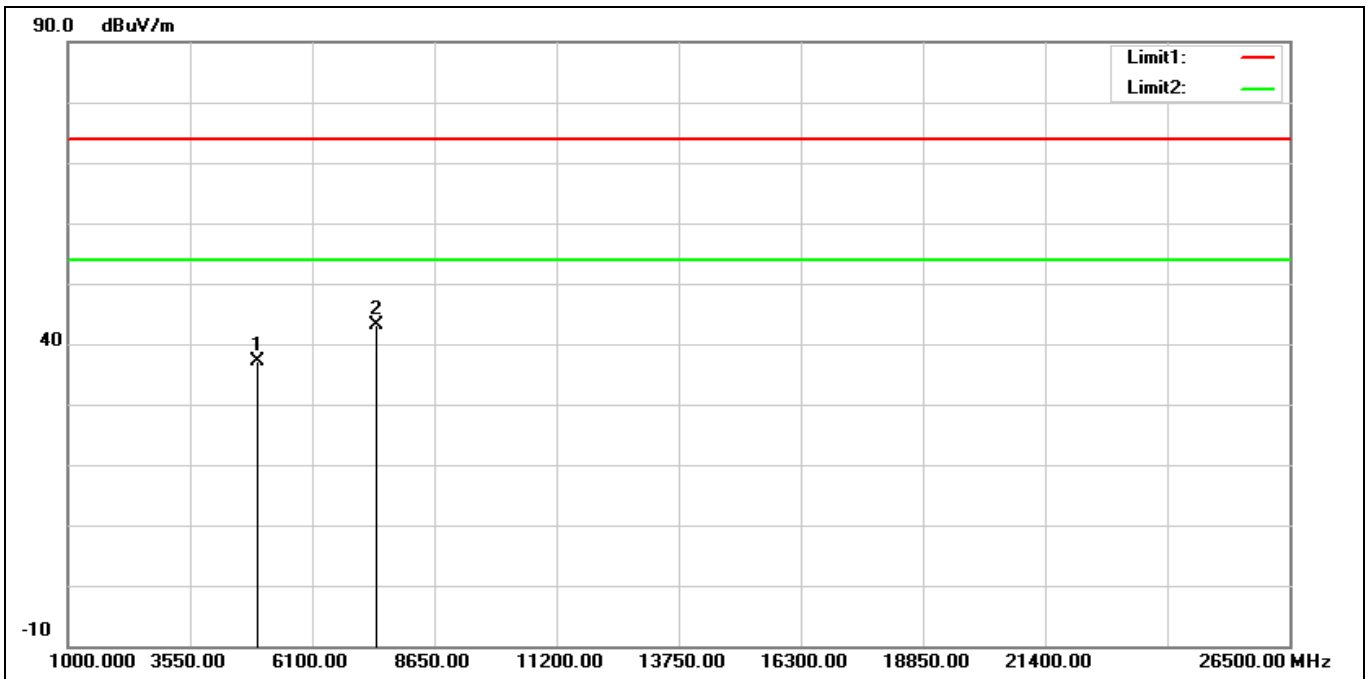

No.	Frequency (MHz)	Reading (dBuV)	Correction (dB/m)	Result (dBuV/m)	Limit (dBuV/m)	Margin (dB)	Remark
1	4960.000	36.48	0.57	37.05	74.00	-36.95	peak
2*	7440.000	34.77	8.34	43.11	74.00	-30.89	peak

Standard:	Part 15C	Test Site:	966 Chamber
Polarization:	Vertical		
Test Mode:	BLE 2M 2480 MHz		
Remark:			

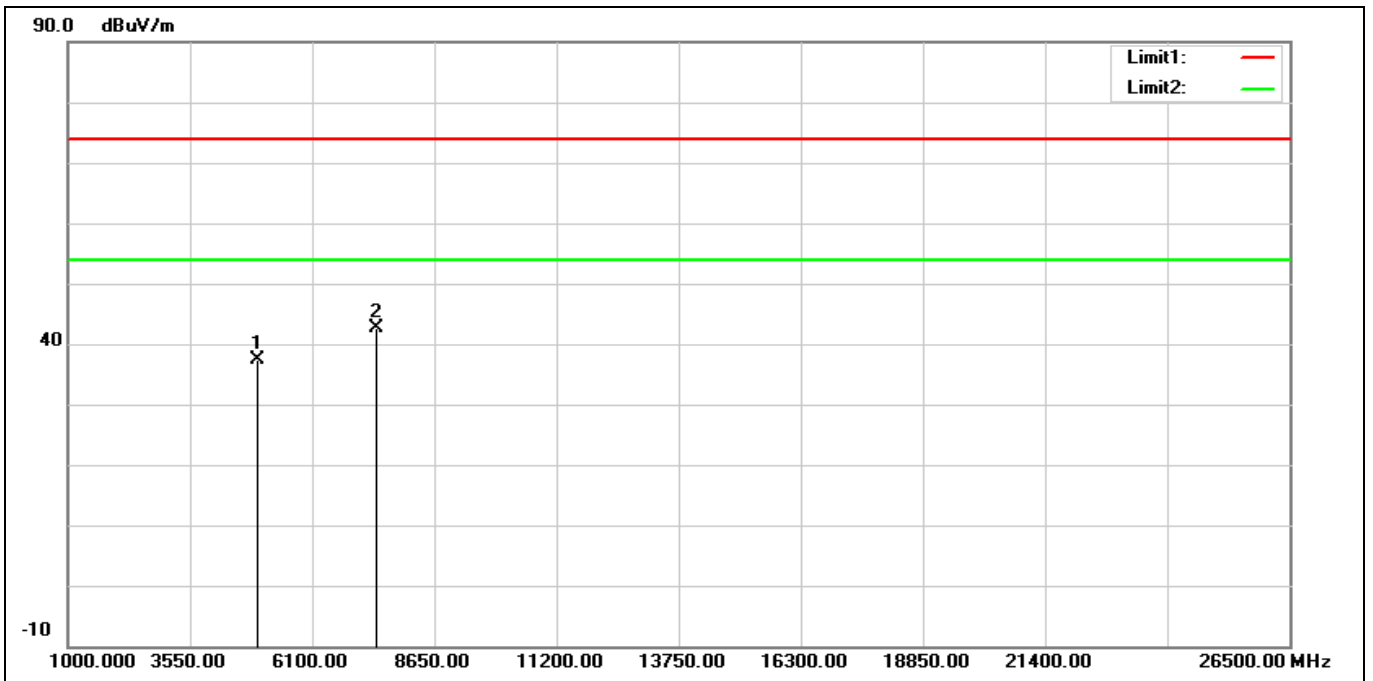

No.	Frequency (MHz)	Reading (dBuV)	Correction (dB/m)	Result (dBuV/m)	Limit (dBuV/m)	Margin (dB)	Remark
1	4960.000	36.84	0.57	37.41	74.00	-36.59	peak
2*	7440.000	34.32	8.34	42.66	74.00	-31.34	peak

Standard:	Part 15C	Test Site:	966 Chamber
Polarization:	Horizontal		
Test Mode:	BLR C8 2402 MHz		
Remark:			

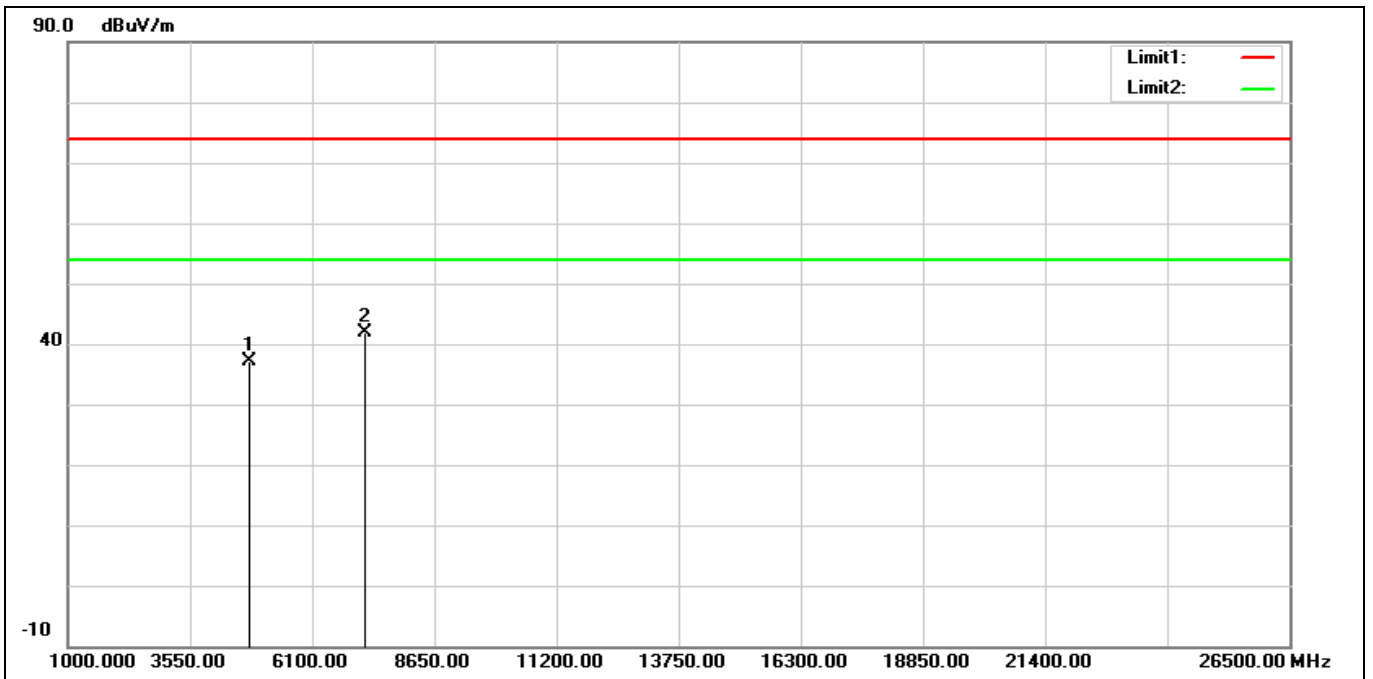

No.	Frequency (MHz)	Reading (dBuV)	Correction (dB/m)	Result (dBuV/m)	Limit (dBuV/m)	Margin (dB)	Remark
1	4804.000	36.83	0.29	37.12	74.00	-36.88	peak
2*	7206.000	34.04	7.82	41.86	74.00	-32.14	peak

Standard:	Part 15C	Test Site:	966 Chamber
Polarization:	Vertical		
Test Mode:	BLR C8 2402 MHz		
Remark:			

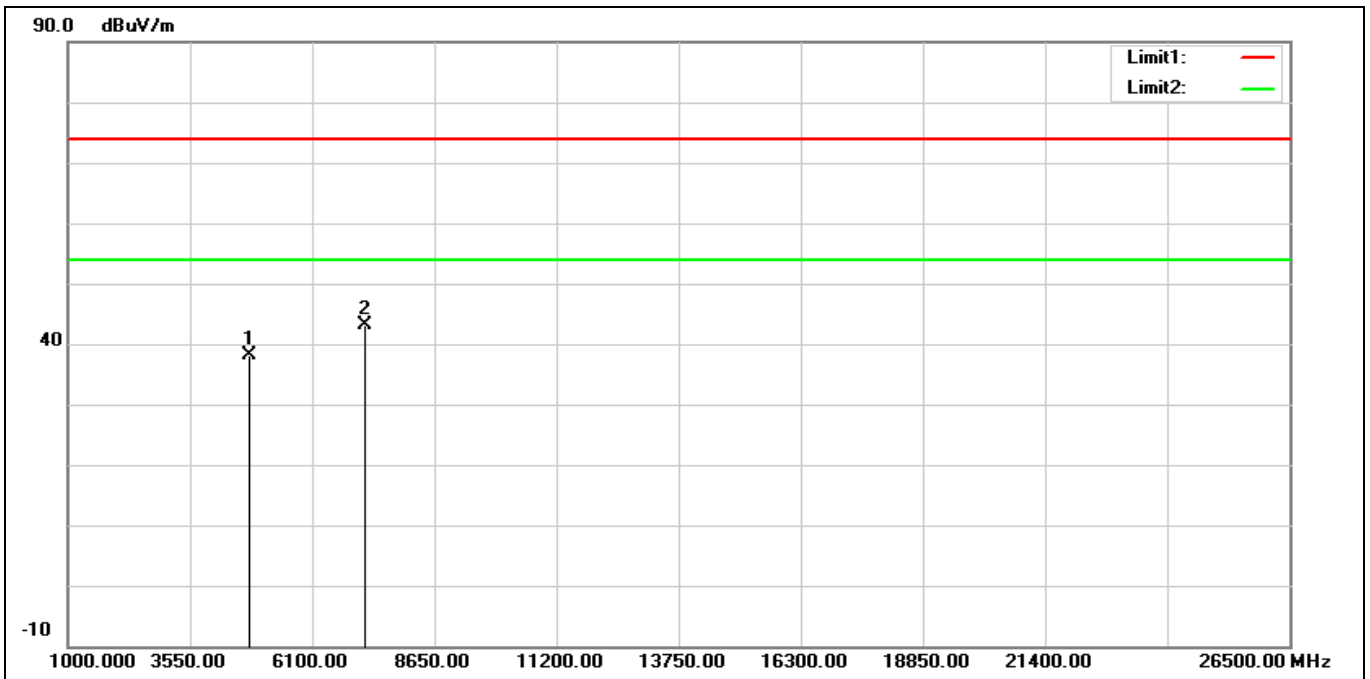

No.	Frequency (MHz)	Reading (dBuV)	Correction (dB/m)	Result (dBuV/m)	Limit (dBuV/m)	Margin (dB)	Remark
1	4804.000	37.92	0.29	38.21	74.00	-35.79	peak
2*	7206.000	35.23	7.82	43.05	74.00	-30.95	peak

Standard:	Part 15C	Test Site:	966 Chamber
Polarization:	Horizontal		
Test Mode:	BLR C8 2440 MHz		
Remark:			

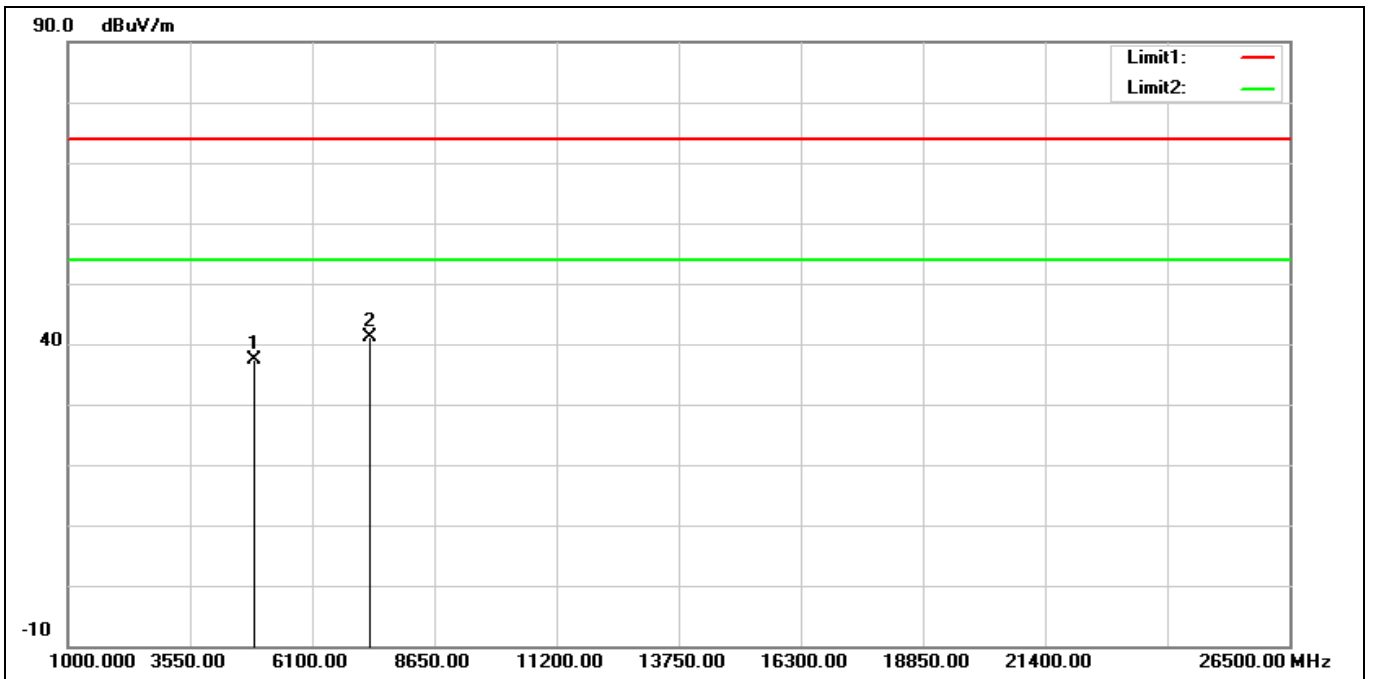

No.	Frequency (MHz)	Reading (dBuV)	Correction (dB/m)	Result (dBuV/m)	Limit (dBuV/m)	Margin (dB)	Remark
1	4880.000	37.02	0.38	37.40	74.00	-36.60	peak
2*	7320.000	33.16	7.99	41.15	74.00	-32.85	peak

Standard:	Part 15C	Test Site:	966 Chamber
Polarization:	Vertical		
Test Mode:	BLR C8 2440 MHz		
Remark:			

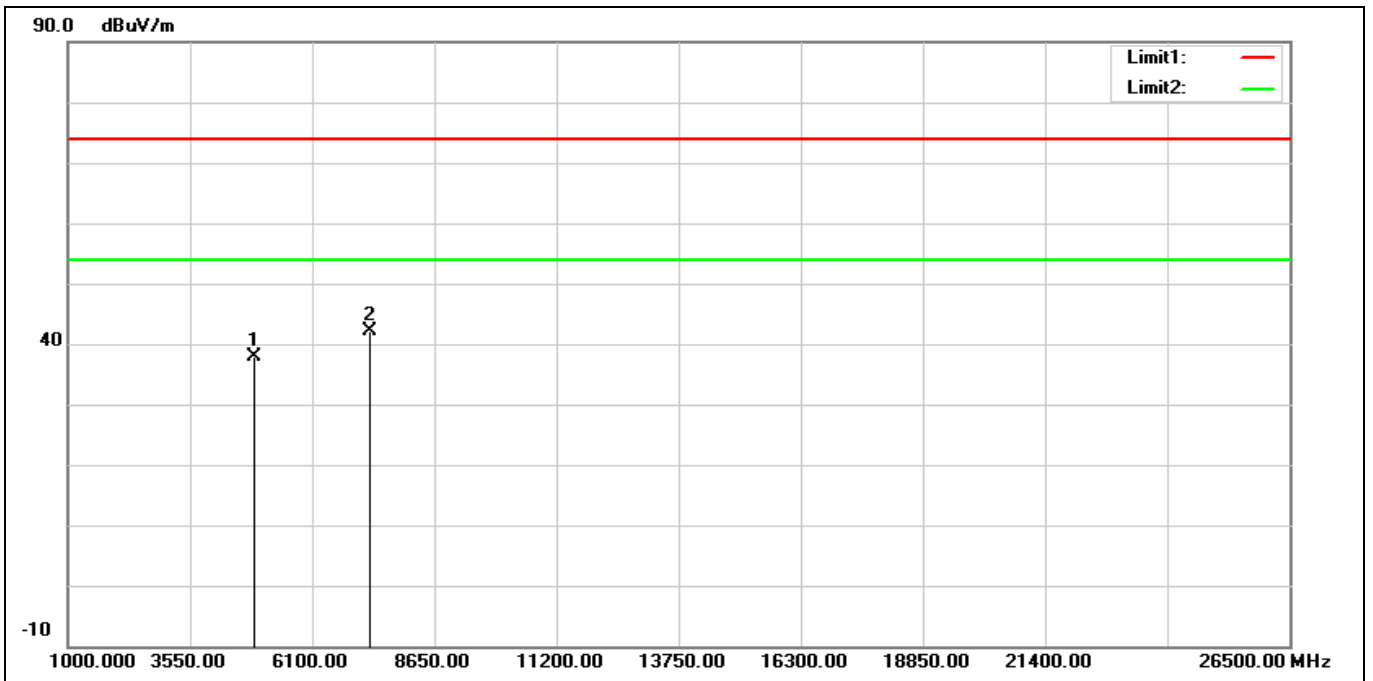

No.	Frequency (MHz)	Reading (dBuV)	Correction (dB/m)	Result (dBuV/m)	Limit (dBuV/m)	Margin (dB)	Remark
1	4880.000	37.55	0.38	37.93	74.00	-36.07	peak
2*	7320.000	34.02	7.99	42.01	74.00	-31.99	peak

Standard:	Part 15C	Test Site:	966 Chamber
Polarization:	Horizontal		
Test Mode:	BLR C8 2480 MHz		
Remark:			

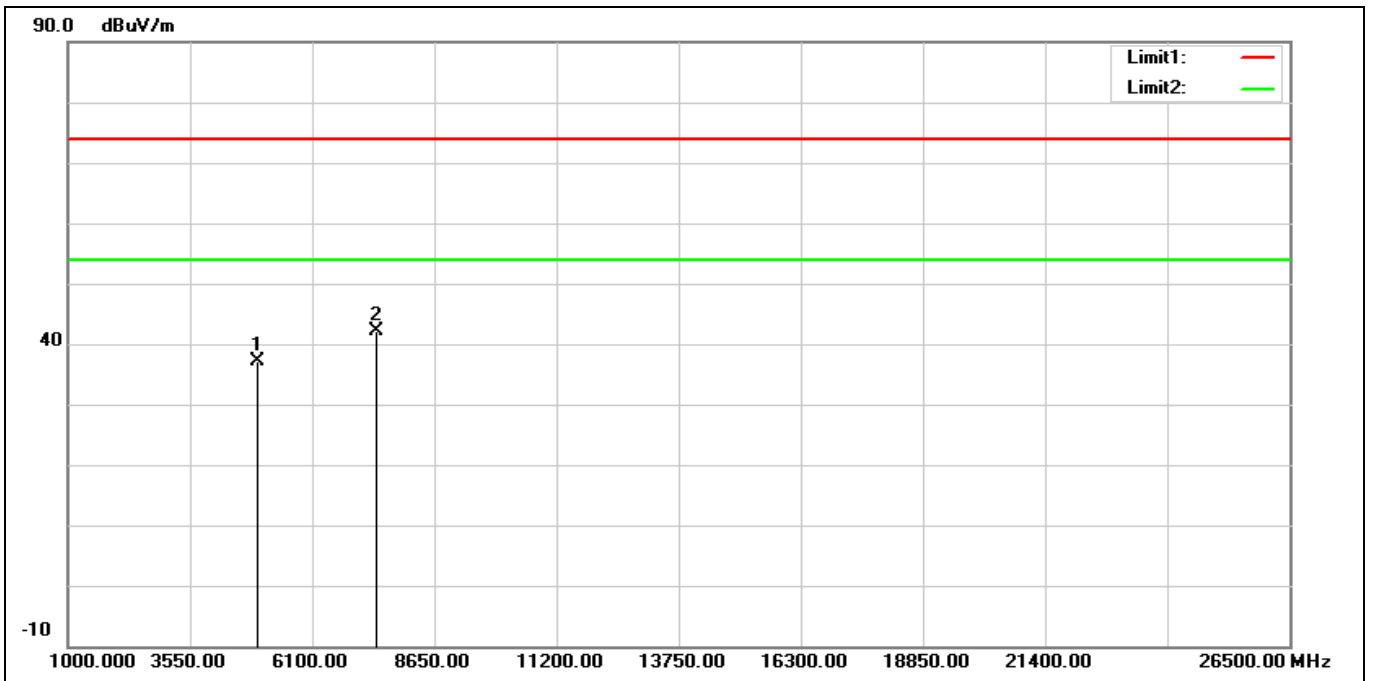

No.	Frequency (MHz)	Reading (dBuV)	Correction (dB/m)	Result (dBuV/m)	Limit (dBuV/m)	Margin (dB)	Remark
1	4960.000	36.58	0.57	37.15	74.00	-36.85	peak
2*	7440.000	33.85	8.34	42.19	74.00	-31.81	peak

Standard:	Part 15C	Test Site:	966 Chamber
Polarization:	Vertical		
Test Mode:	BLR C8 2480 MHz		
Remark:			

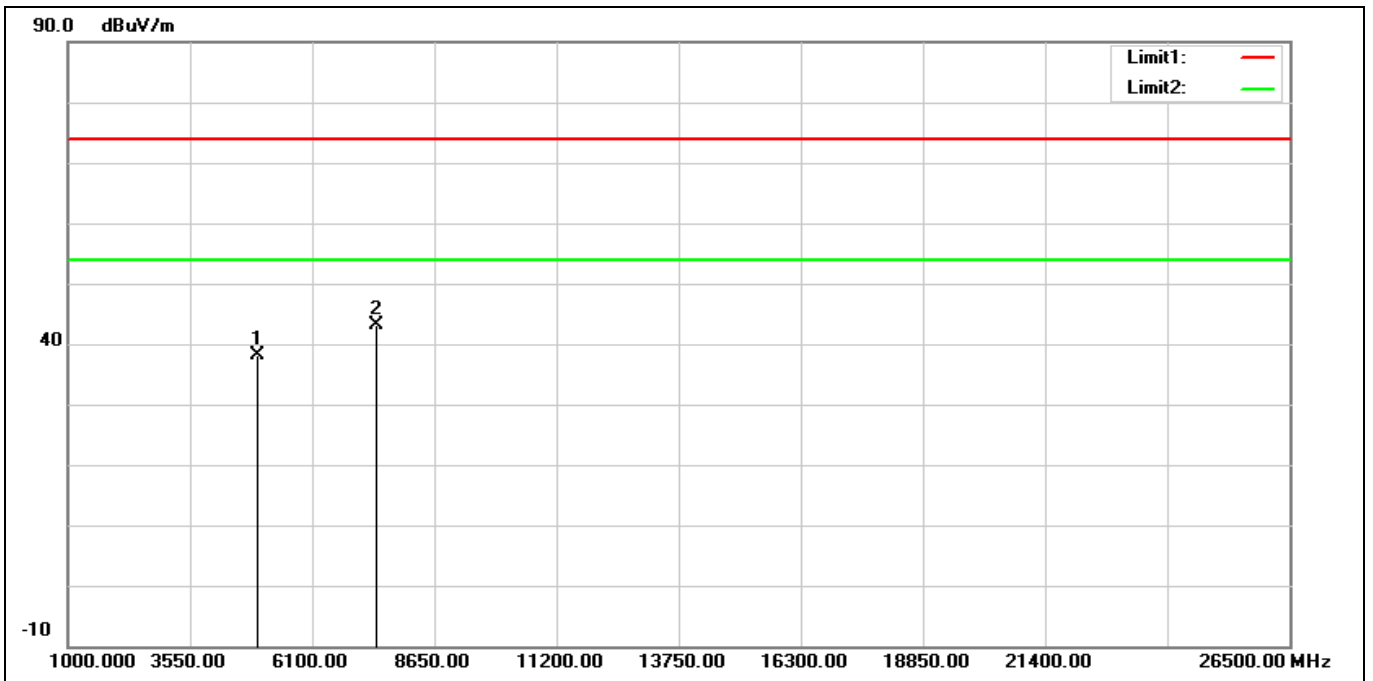

No.	Frequency (MHz)	Reading (dBuV)	Correction (dB/m)	Result (dBuV/m)	Limit (dBuV/m)	Margin (dB)	Remark
1	4960.000	37.55	0.57	38.12	74.00	-35.88	peak
2*	7440.000	34.86	8.34	43.20	74.00	-30.80	peak

Band Edge

Standard:	Part 15C	Test Site:	966 Chamber
Polarization:	Horizontal		
Test Mode:	BLE 2M 2402 MHz		
Remark:			

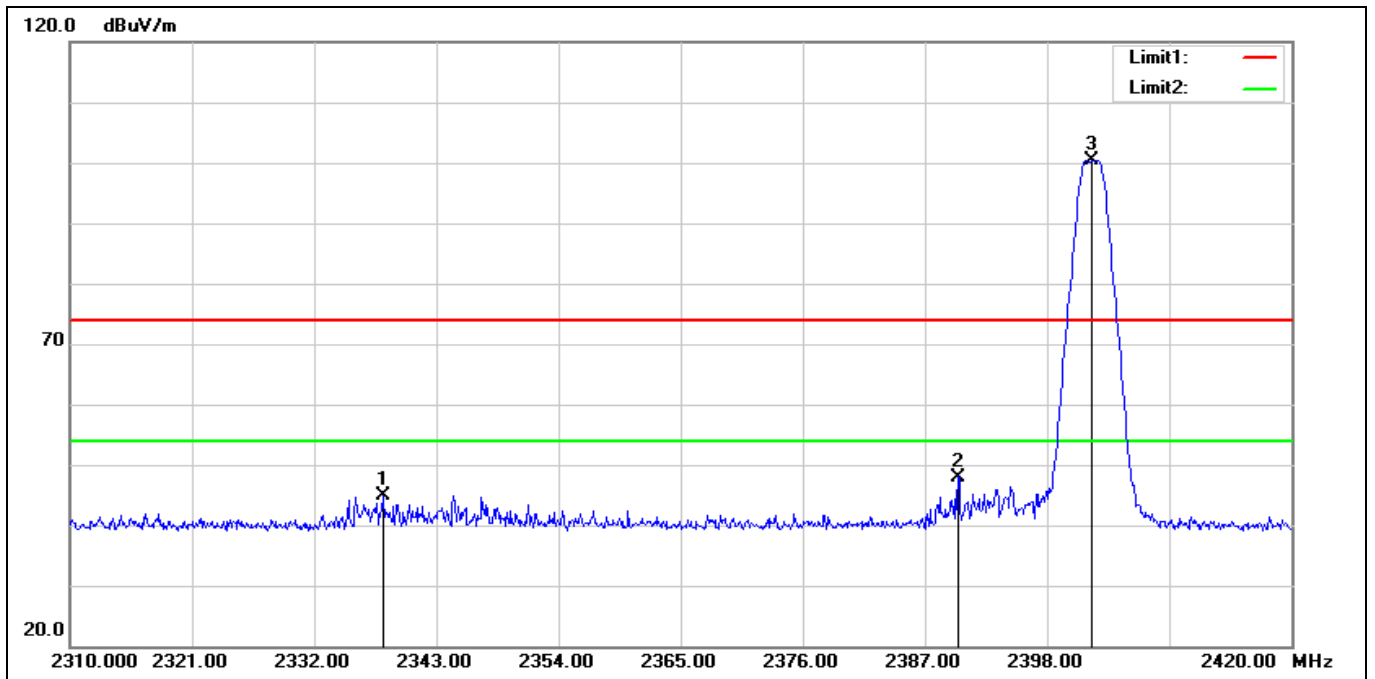

No.	Frequency (MHz)	Reading (dBuV)	Correction (dB/m)	Result (dBuV/m)	Limit (dBuV/m)	Margin (dB)	Remark
1	2338.160	51.01	-6.03	44.98	74.00	-29.02	peak
2	2390.000	53.97	-6.19	47.78	74.00	-26.22	peak
3*	2402.070	106.73	-6.25	100.48	74.00	26.48	peak

Standard:	Part 15C	Test Site:	966 Chamber
Polarization:	Vertical		
Test Mode:	BLE 2M 2402 MHz		
Remark:			

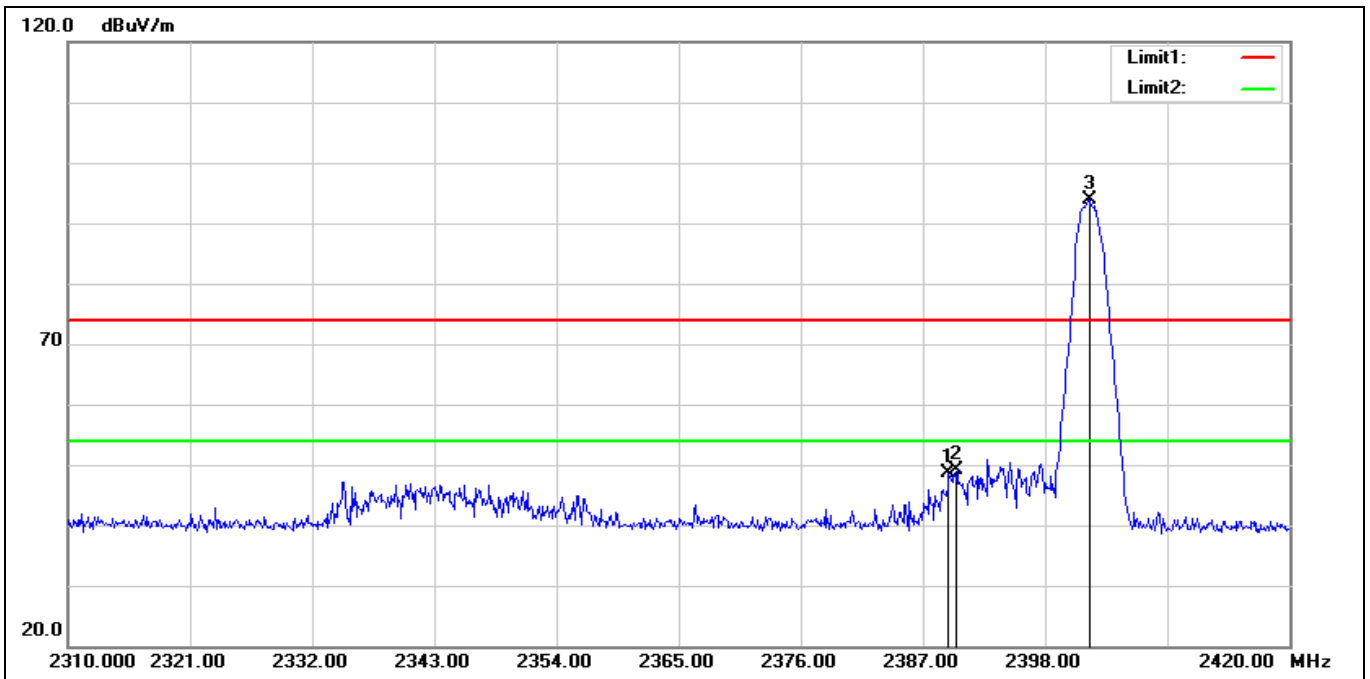

No.	Frequency (MHz)	Reading (dBuV)	Correction (dB/m)	Result (dBuV/m)	Limit (dBuV/m)	Margin (dB)	Remark
1	2389.310	54.89	-6.19	48.70	74.00	-25.30	peak
2	2390.000	55.24	-6.19	49.05	74.00	-24.95	peak
3*	2401.960	100.22	-6.25	93.97	74.00	19.97	peak

Standard:	Part 15C	Test Site:	966 Chamber
Polarization:	Horizontal		
Test Mode:	BLE 2M 2480 MHz		
Remark:			

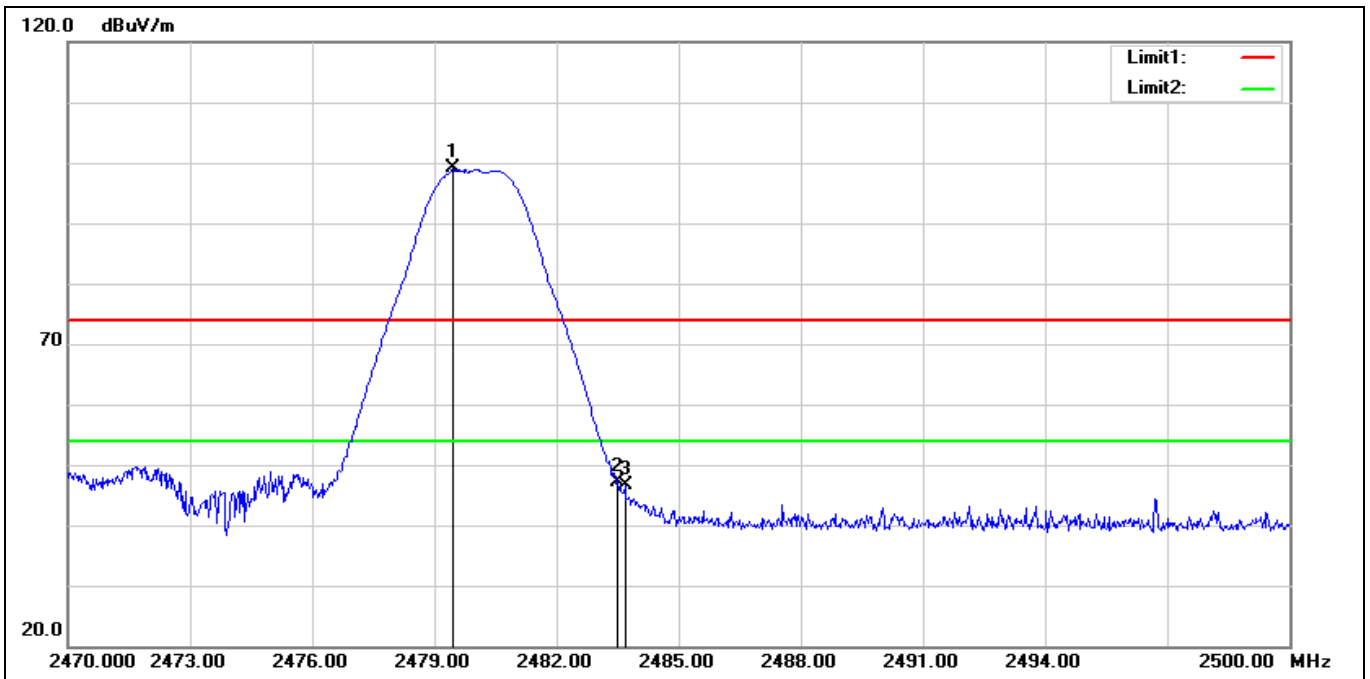

No.	Frequency (MHz)	Reading (dBuV)	Correction (dB/m)	Result (dBuV/m)	Limit (dBuV/m)	Margin (dB)	Remark
1*	2479.450	105.51	-6.46	99.05	74.00	25.05	peak
2	2483.500	53.61	-6.46	47.15	74.00	-26.85	peak
3	2483.680	53.18	-6.46	46.72	74.00	-27.28	peak

Standard:	Part 15C	Test Site:	966 Chamber
Polarization:	Vertical		
Test Mode:	BLE 2M 2480 MHz		
Remark:			

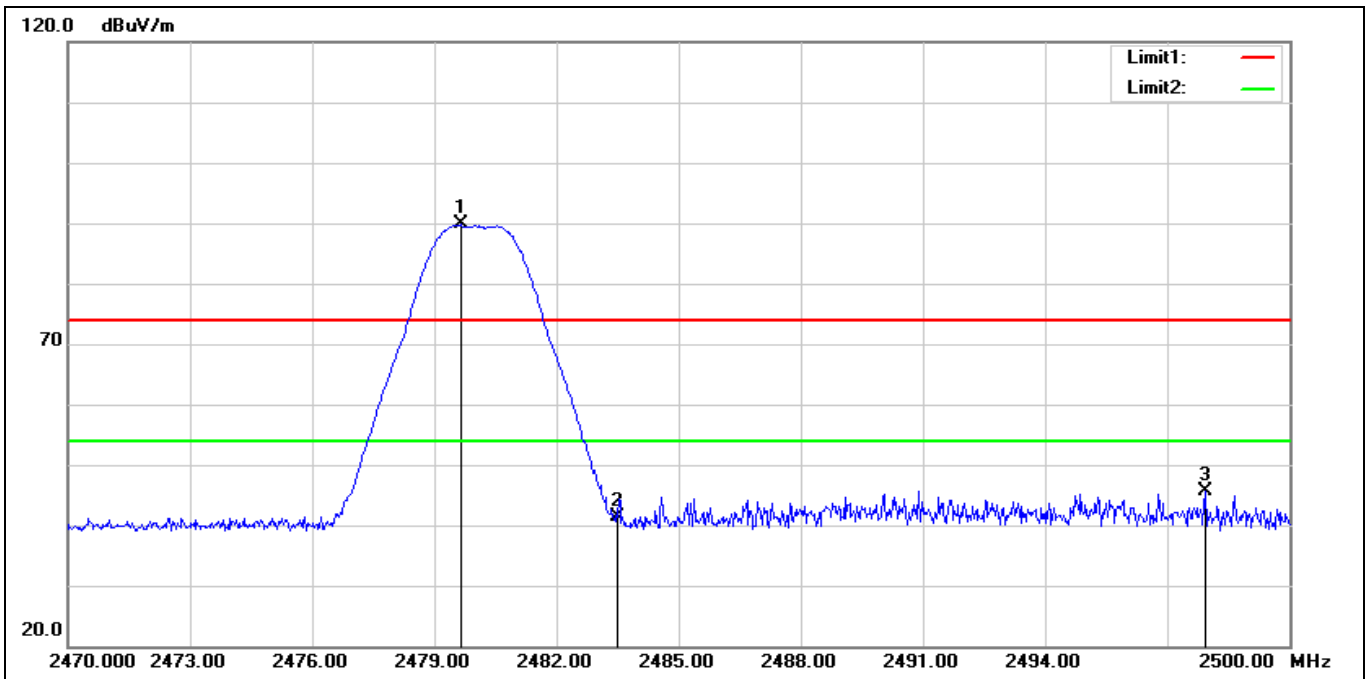

No.	Frequency (MHz)	Reading (dBuV)	Correction (dB/m)	Result (dBuV/m)	Limit (dBuV/m)	Margin (dB)	Remark
1*	2479.660	96.32	-6.46	89.86	74.00	15.86	peak
2	2483.500	47.88	-6.46	41.42	74.00	-32.58	peak
3	2497.930	52.07	-6.50	45.57	74.00	-28.43	peak

Standard:	Part 15C	Test Site:	966 Chamber
Polarization:	Horizontal		
Test Mode:	BLR C8 2402 MHz		
Remark:			

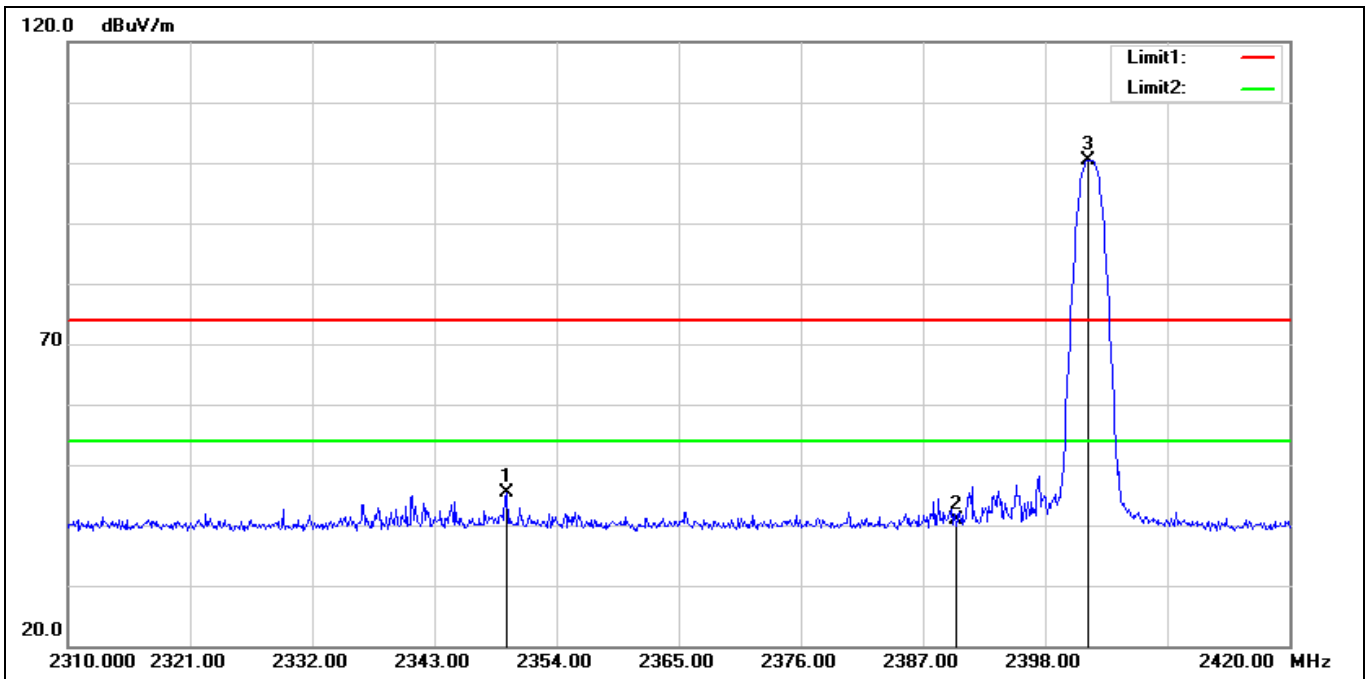

No.	Frequency (MHz)	Reading (dBuV)	Correction (dB/m)	Result (dBuV/m)	Limit (dBuV/m)	Margin (dB)	Remark
1	2349.490	51.34	-6.00	45.34	74.00	-28.66	peak
2	2390.000	47.15	-6.19	40.96	74.00	-33.04	peak
3*	2401.850	106.60	-6.25	100.35	74.00	26.35	peak

Standard:	Part 15C	Test Site:	966 Chamber
Polarization:	Vertical		
Test Mode:	BLR C8 2402 MHz		
Remark:			

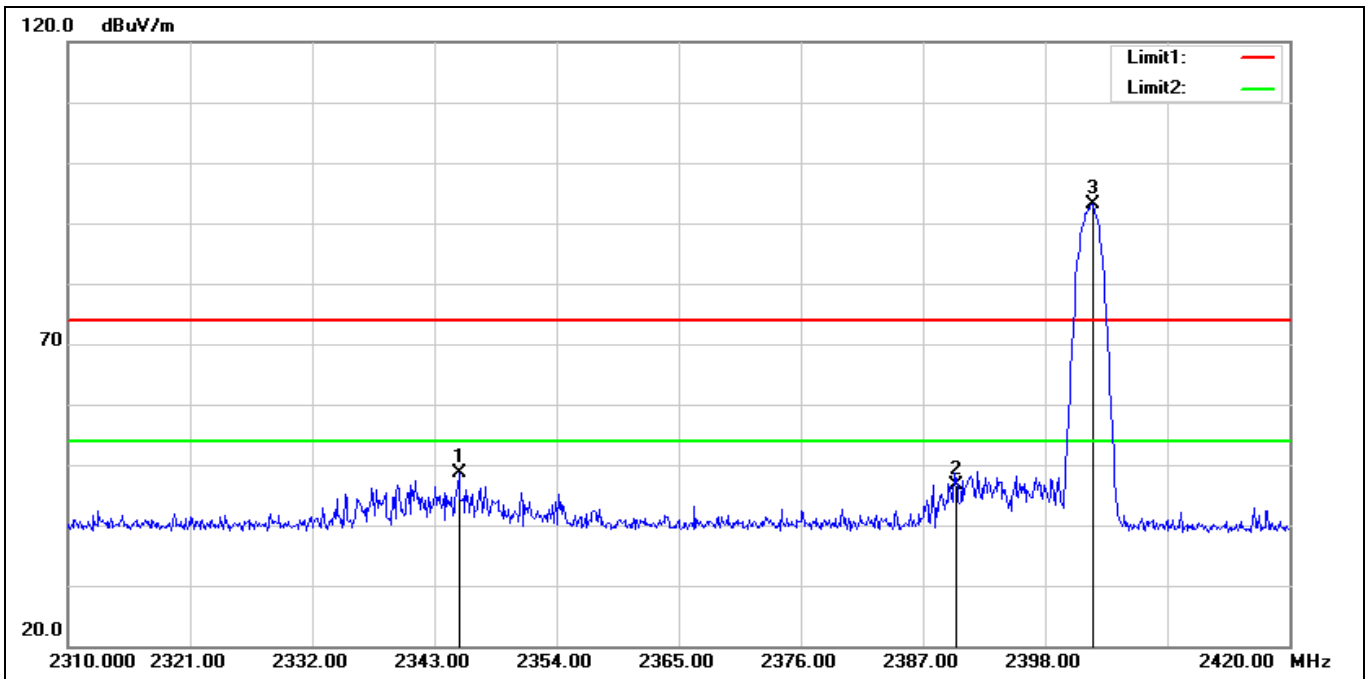

No.	Frequency (MHz)	Reading (dBuV)	Correction (dB/m)	Result (dBuV/m)	Limit (dBuV/m)	Margin (dB)	Remark
1	2345.200	54.64	-6.01	48.63	74.00	-25.37	peak
2	2390.000	52.70	-6.19	46.51	74.00	-27.49	peak
3*	2402.290	99.45	-6.25	93.20	74.00	19.20	peak

Standard:	Part 15C	Test Site:	966 Chamber
Polarization:	Horizontal		
Test Mode:	BLR C8 2480 MHz		
Remark:			

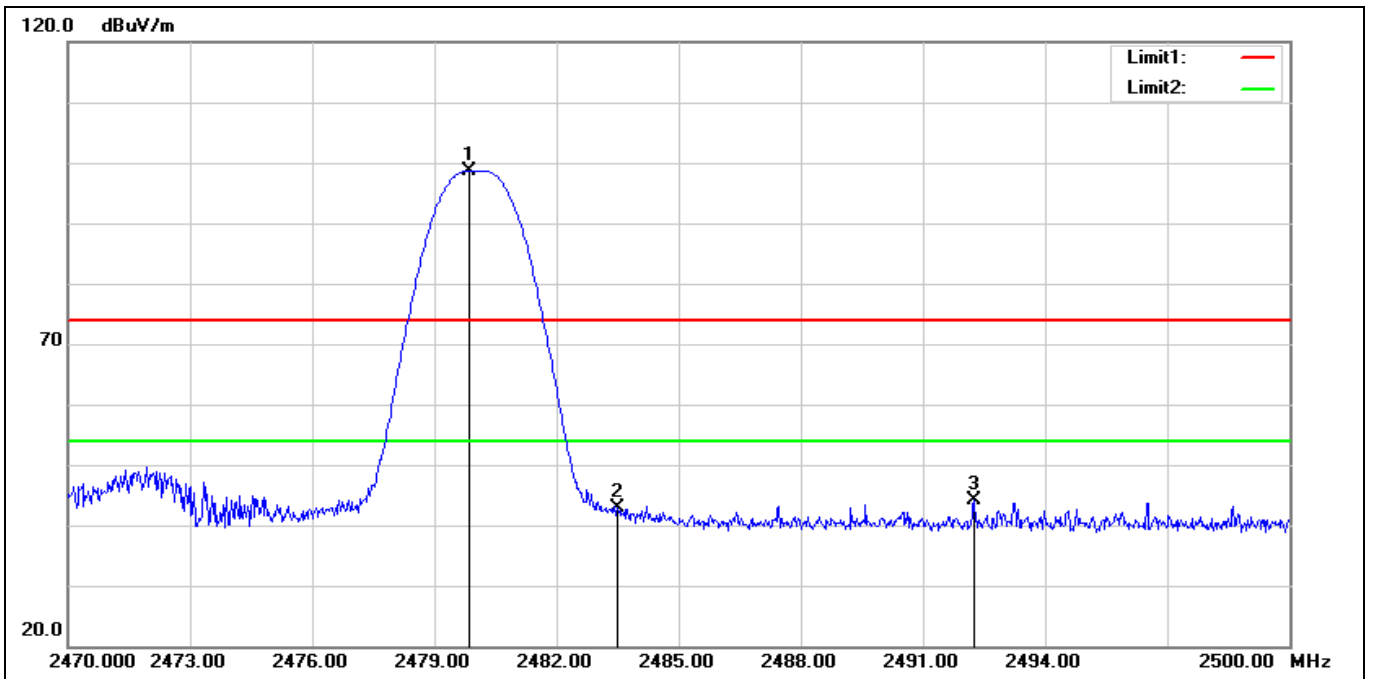

No.	Frequency (MHz)	Reading (dBuV)	Correction (dB/m)	Result (dBuV/m)	Limit (dBuV/m)	Margin (dB)	Remark
1*	2479.870	105.12	-6.46	98.66	74.00	24.66	peak
2	2483.500	49.34	-6.46	42.88	74.00	-31.12	peak
3	2492.260	50.64	-6.49	44.15	74.00	-29.85	peak

Standard:	Part 15C	Test Site:	966 Chamber
Polarization:	Vertical		
Test Mode:	BLR C8 2480 MHz		
Remark:			

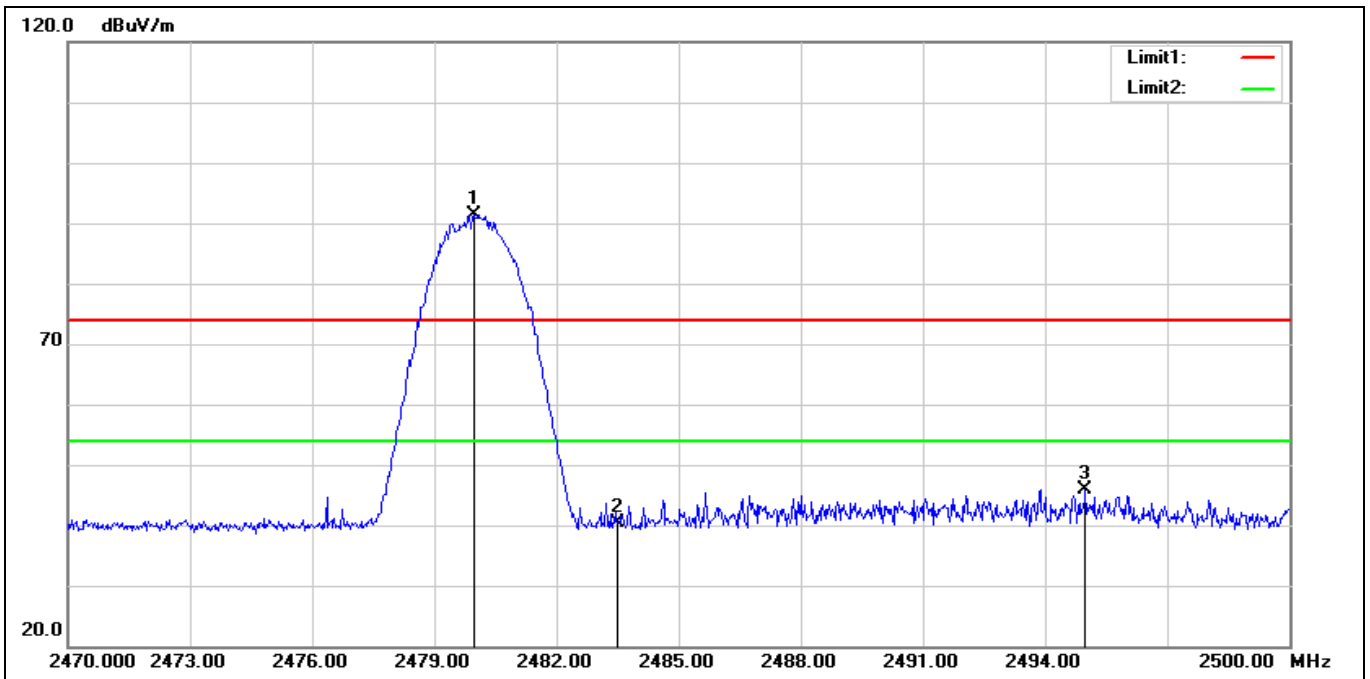

No.	Frequency (MHz)	Reading (dBuV)	Correction (dB/m)	Result (dBuV/m)	Limit (dBuV/m)	Margin (dB)	Remark
1*	2479.960	97.96	-6.46	91.50	74.00	17.50	peak
2	2483.500	46.80	-6.46	40.34	74.00	-33.66	peak
3	2494.990	52.42	-6.50	45.92	74.00	-28.08	peak

Antenna brand: ABRACON

Below 1 GHz

Standard:	Part 15C	Test Site:	966 Chamber
Polarization:	Horizontal		
Test Mode:	BLE 2M 2402 MHz		
Remark:			

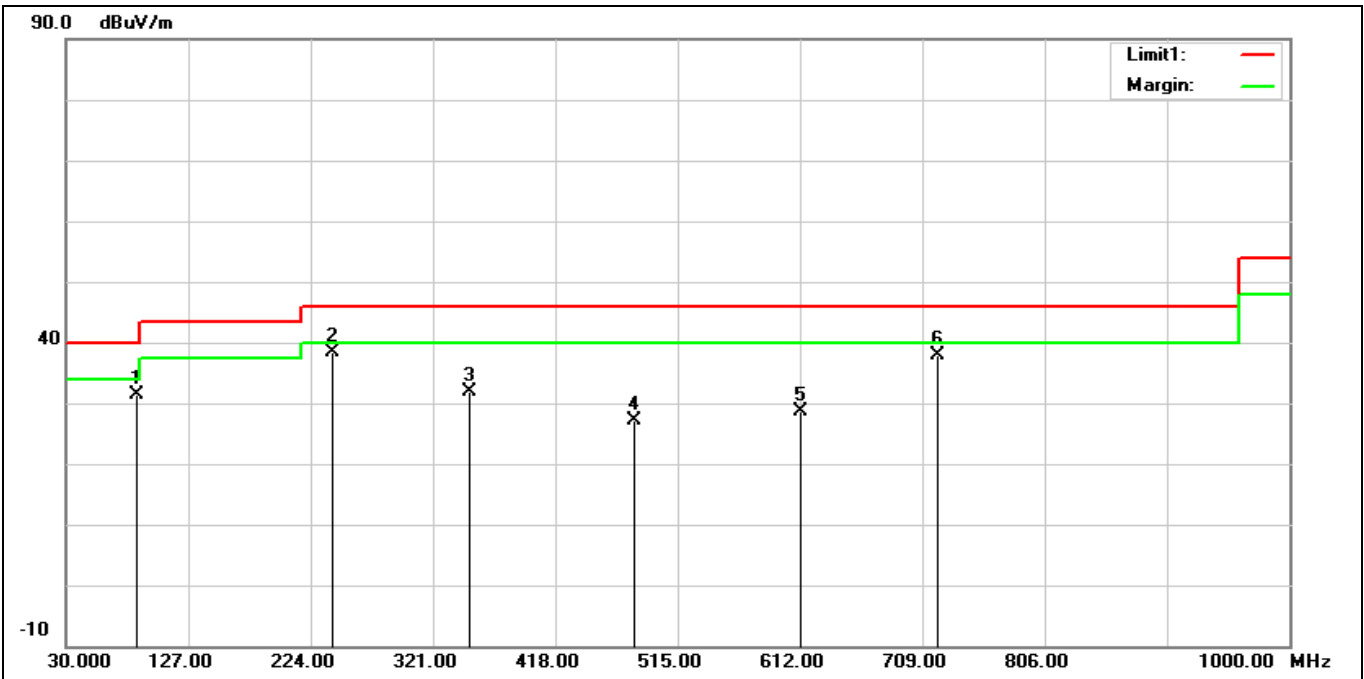

No.	Frequency (MHz)	Reading (dBuV)	Correction (dB/m)	Result (dBuV/m)	Limit (dBuV/m)	Margin (dB)	Remark
1	86.2600	44.38	-13.01	31.37	40.00	-8.63	QP
2*	241.4600	46.08	-7.62	38.46	46.00	-7.54	QP
3	350.1000	36.65	-4.75	31.90	46.00	-14.10	QP
4	480.0800	29.26	-2.20	27.06	46.00	-18.94	QP
5	612.9700	28.31	0.28	28.59	46.00	-17.41	QP
6	720.6400	35.72	2.11	37.83	46.00	-8.17	QP

Standard:	Part 15C	Test Site:	966 Chamber
Polarization:	Vertical		
Test Mode:	BLE 2M 2402 MHz		
Remark:			

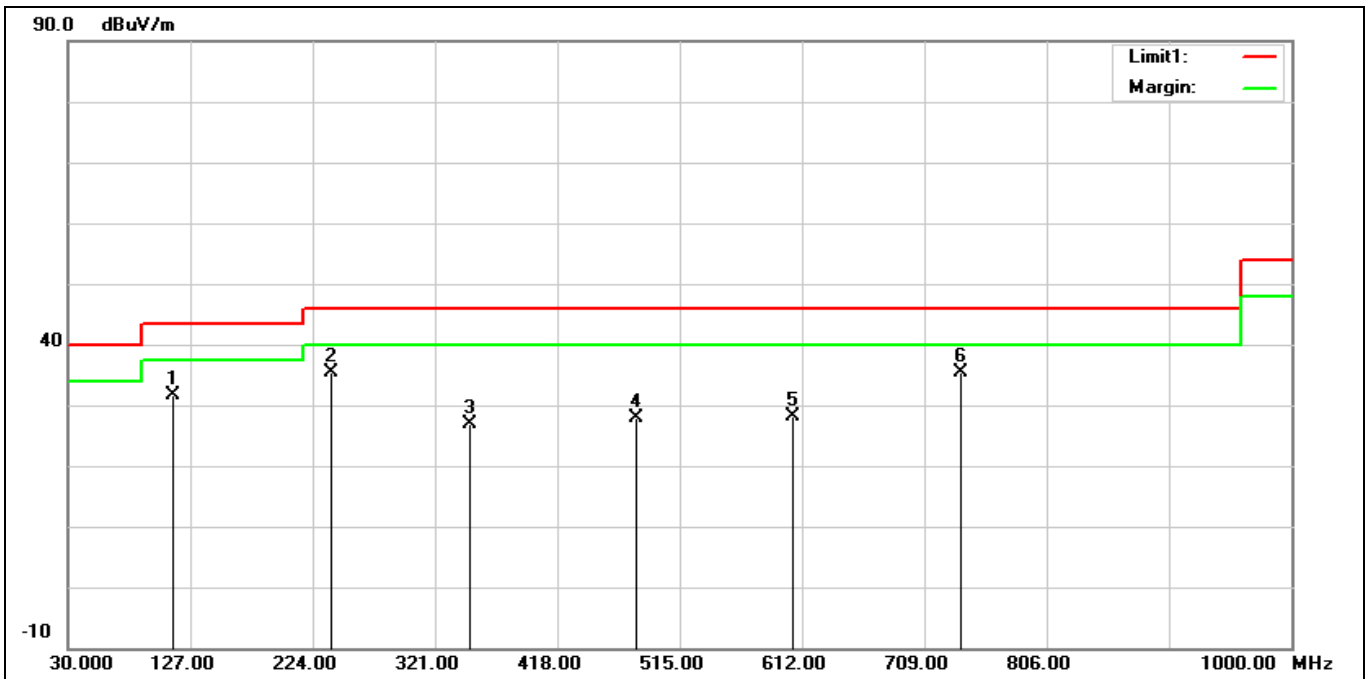

No.	Frequency (MHz)	Reading (dBuV)	Correction (dB/m)	Result (dBuV/m)	Limit (dBuV/m)	Margin (dB)	Remark
1	113.4200	42.25	-10.52	31.73	43.50	-11.77	QP
2	238.5500	43.21	-7.77	35.44	46.00	-10.56	QP
3	349.1300	31.55	-4.76	26.79	46.00	-19.21	QP
4	481.0500	30.14	-2.18	27.96	46.00	-18.04	QP
5	604.2400	27.89	0.25	28.14	46.00	-17.86	QP
6*	738.1000	32.95	2.53	35.48	46.00	-10.52	QP

Harmonic

Above 1 GHz

Standard:	Part 15C	Test Site:	966 Chamber
Polarization:	Horizontal		
Test Mode:	BLE 2M 2402 MHz		
Remark:			

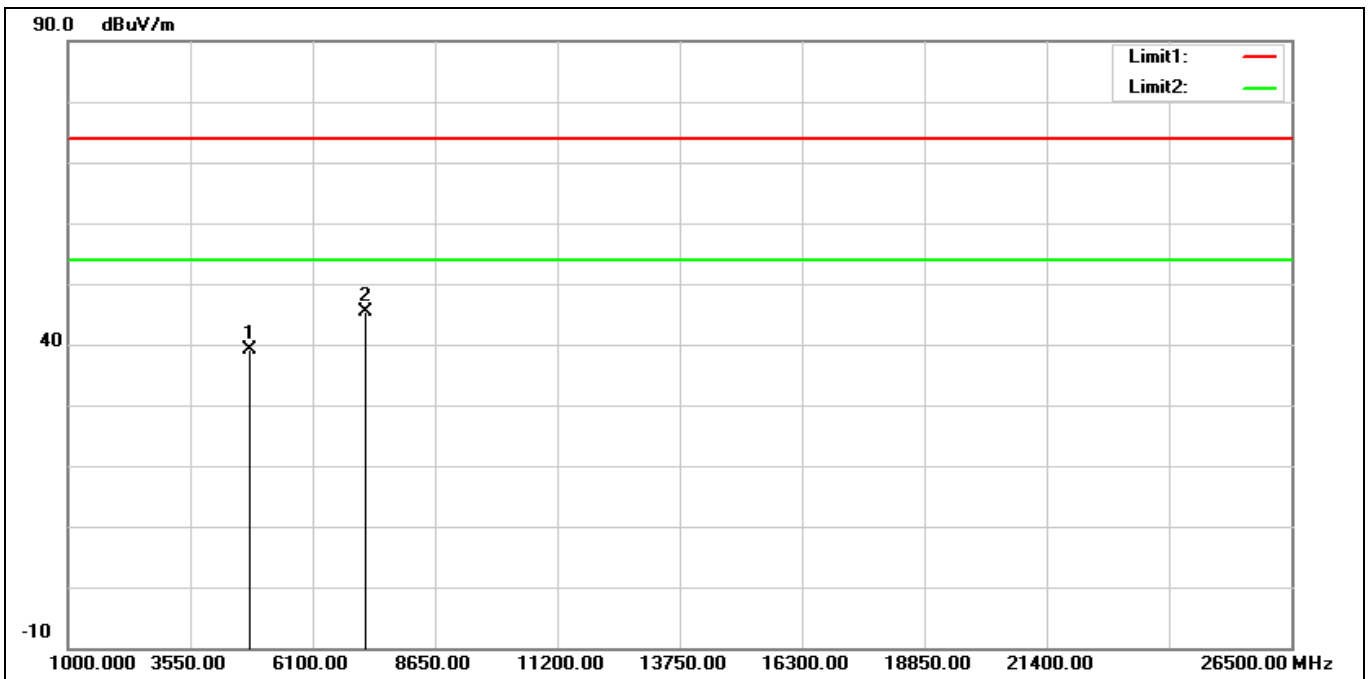

No.	Frequency (MHz)	Reading (dBuV)	Correction (dB/m)	Result (dBuV/m)	Limit (dBuV/m)	Margin (dB)	Remark
1	4804.000	38.73	0.29	39.02	74.00	-34.98	peak
2*	7206.000	37.67	7.82	45.49	74.00	-28.51	peak

Standard:	Part 15C	Test Site:	966 Chamber
Polarization:	Vertical		
Test Mode:	BLE 2M 2402 MHz		
Remark:			

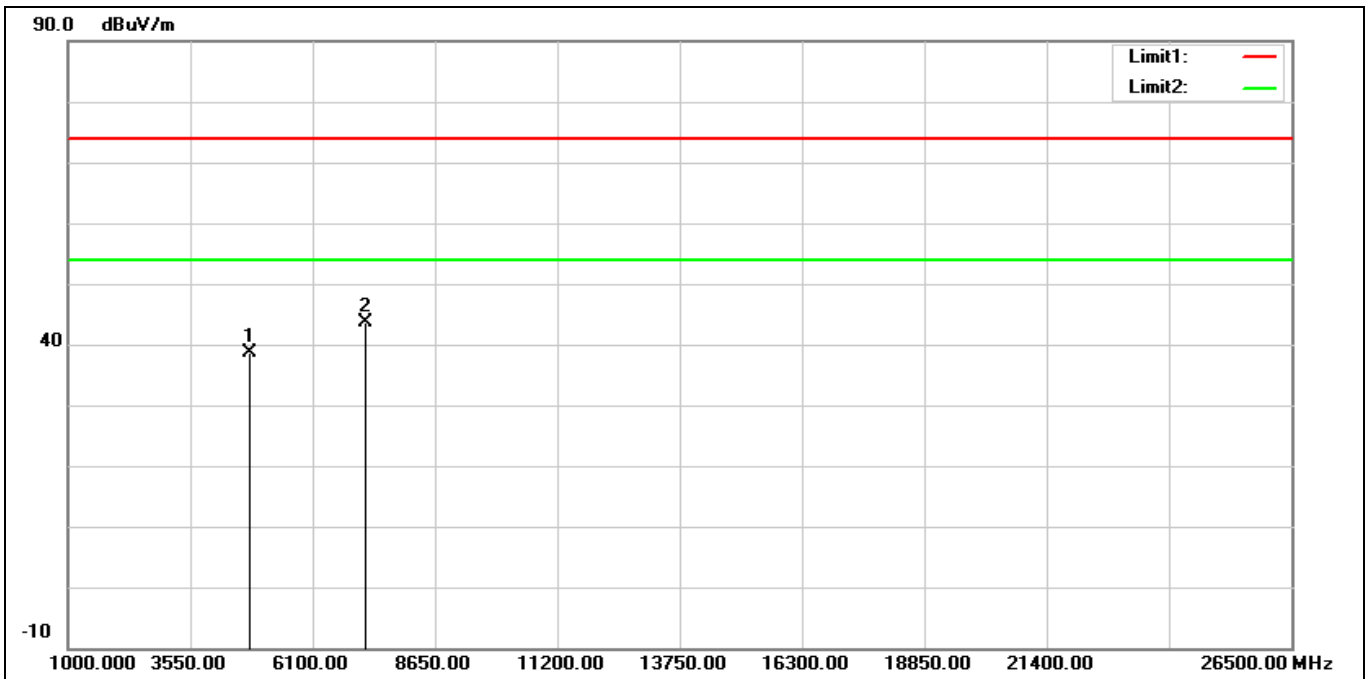

No.	Frequency (MHz)	Reading (dBuV)	Correction (dB/m)	Result (dBuV/m)	Limit (dBuV/m)	Margin (dB)	Remark
1	4804.000	38.36	0.29	38.65	74.00	-35.35	peak
2*	7206.000	35.69	7.82	43.51	74.00	-30.49	peak

Standard:	Part 15C	Test Site:	966 Chamber
Polarization:	Horizontal		
Test Mode:	BLE 2M 2440 MHz		
Remark:			

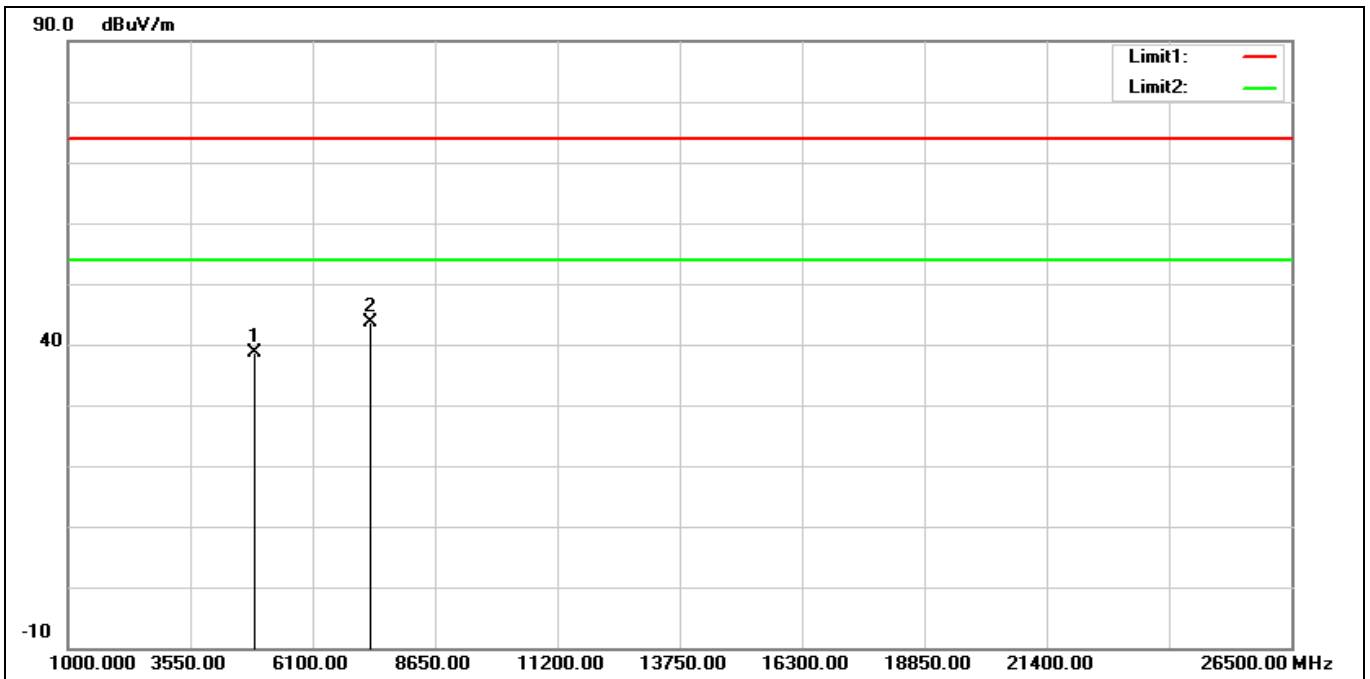

No.	Frequency (MHz)	Reading (dBuV)	Correction (dB/m)	Result (dBuV/m)	Limit (dBuV/m)	Margin (dB)	Remark
1	4880.000	38.18	0.38	38.56	74.00	-35.44	peak
2*	7320.000	35.75	7.99	43.74	74.00	-30.26	peak

Standard:	Part 15C	Test Site:	966 Chamber
Polarization:	Vertical		
Test Mode:	BLE 2M 2440 MHz		
Remark:			

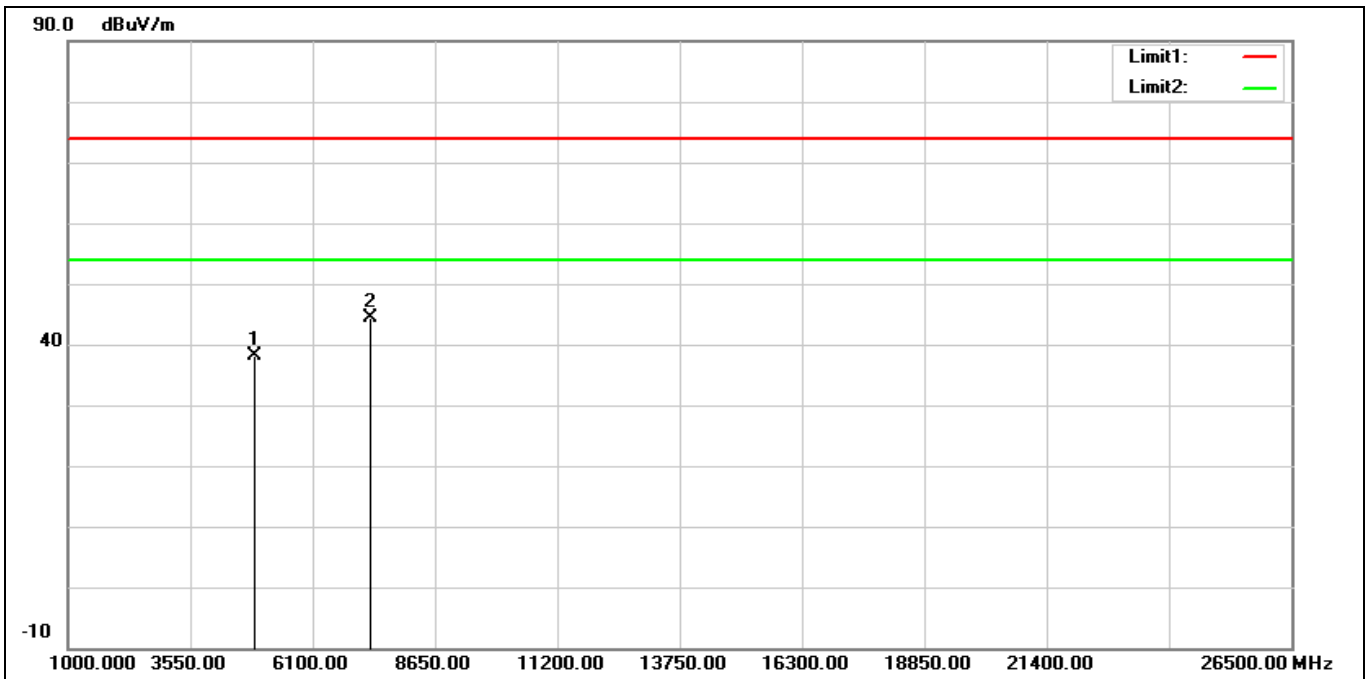

No.	Frequency (MHz)	Reading (dBuV)	Correction (dB/m)	Result (dBuV/m)	Limit (dBuV/m)	Margin (dB)	Remark
1	4880.000	37.69	0.38	38.07	74.00	-35.93	peak
2*	7320.000	36.30	7.99	44.29	74.00	-29.71	peak

Standard:	Part 15C	Test Site:	966 Chamber
Polarization:	Horizontal		
Test Mode:	BLE 2M 2480 MHz		
Remark:			

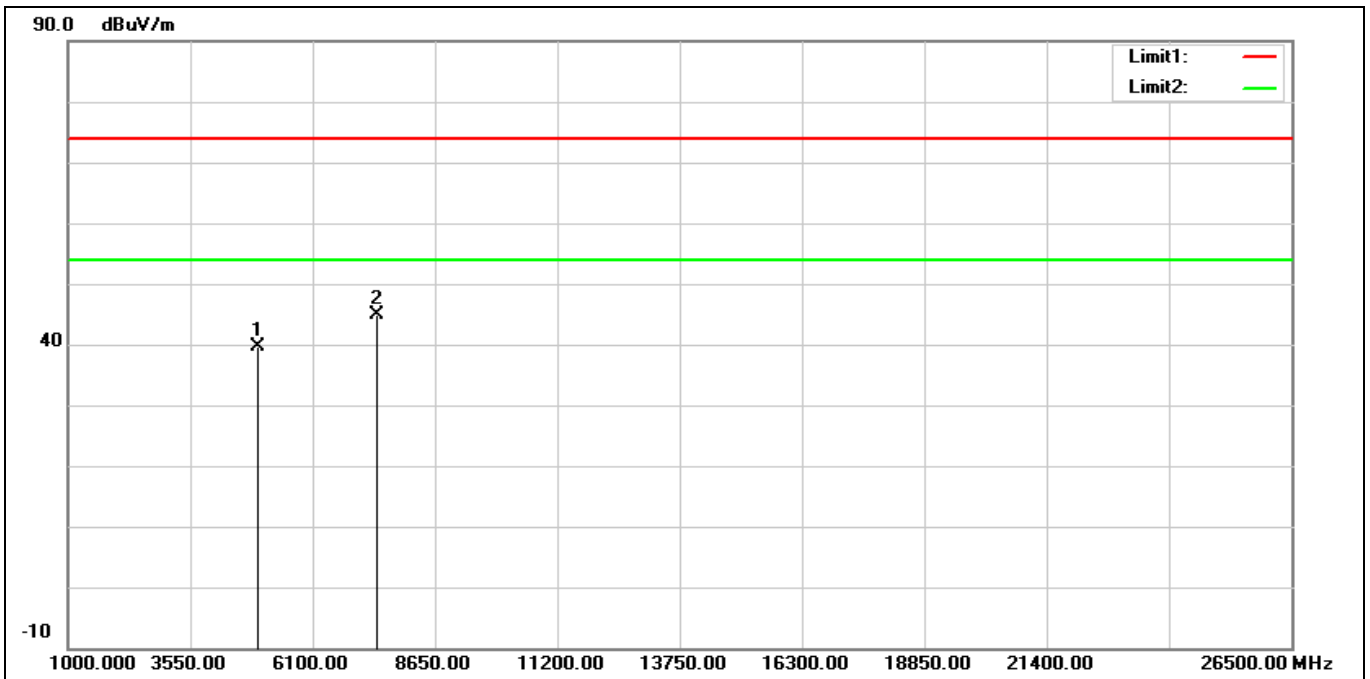

No.	Frequency (MHz)	Reading (dBuV)	Correction (dB/m)	Result (dBuV/m)	Limit (dBuV/m)	Margin (dB)	Remark
1	4960.000	39.09	0.57	39.66	74.00	-34.34	peak
2*	7440.000	36.47	8.34	44.81	74.00	-29.19	peak

Standard:	Part 15C	Test Site:	966 Chamber
Polarization:	Vertical		
Test Mode:	BLE 2M 2480 MHz		
Remark:			

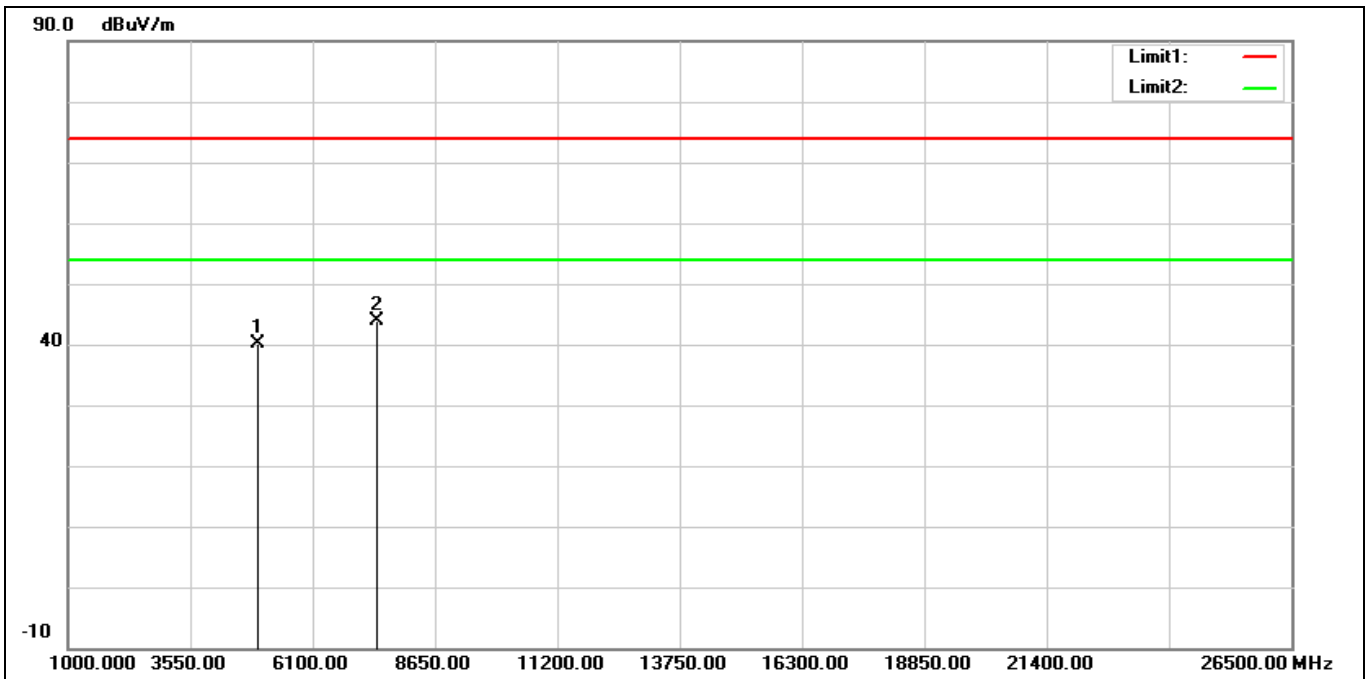

No.	Frequency (MHz)	Reading (dBuV)	Correction (dB/m)	Result (dBuV/m)	Limit (dBuV/m)	Margin (dB)	Remark
1	4960.000	39.55	0.57	40.12	74.00	-33.88	peak
2*	7440.000	35.51	8.34	43.85	74.00	-30.15	peak

Standard:	Part 15C	Test Site:	966 Chamber
Polarization:	Horizontal		
Test Mode:	BLR C8 2402 MHz		
Remark:			

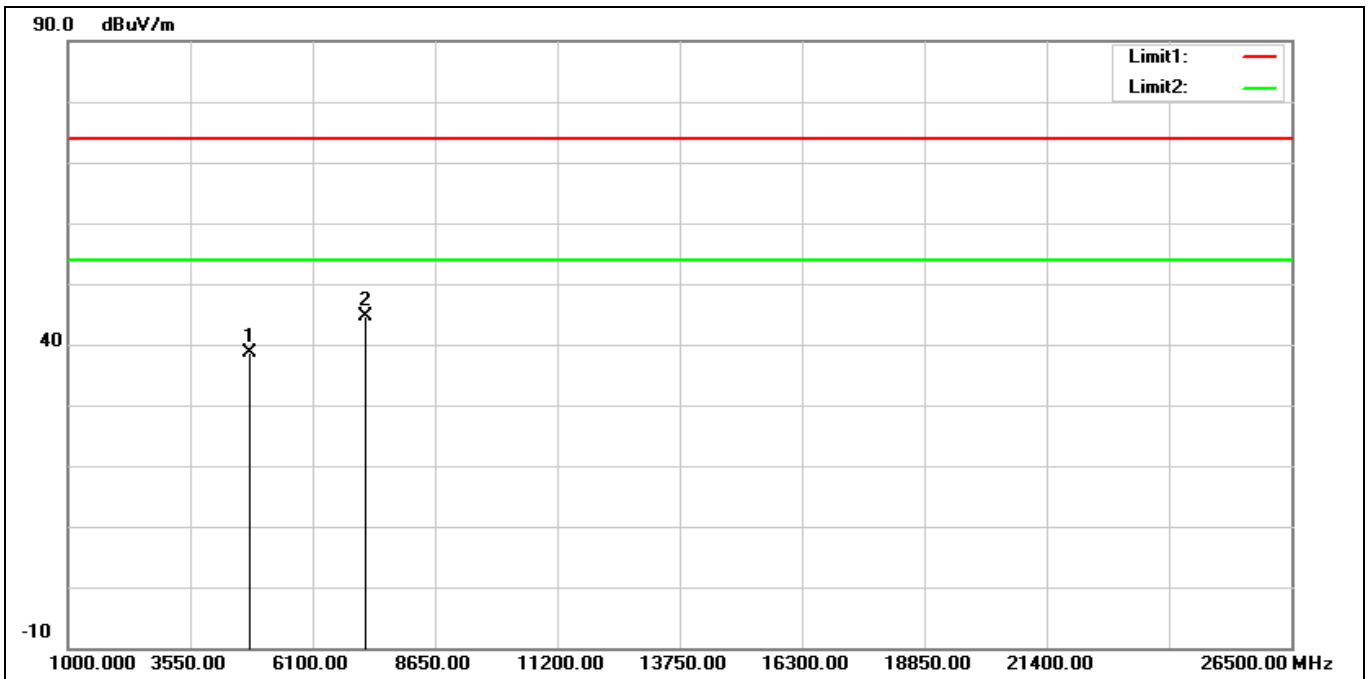

No.	Frequency (MHz)	Reading (dBuV)	Correction (dB/m)	Result (dBuV/m)	Limit (dBuV/m)	Margin (dB)	Remark
1	4804.000	38.31	0.29	38.60	74.00	-35.40	peak
2*	7206.000	36.70	7.82	44.52	74.00	-29.48	peak

Standard:	Part 15C	Test Site:	966 Chamber
Polarization:	Vertical		
Test Mode:	BLR C8 2402 MHz		
Remark:			

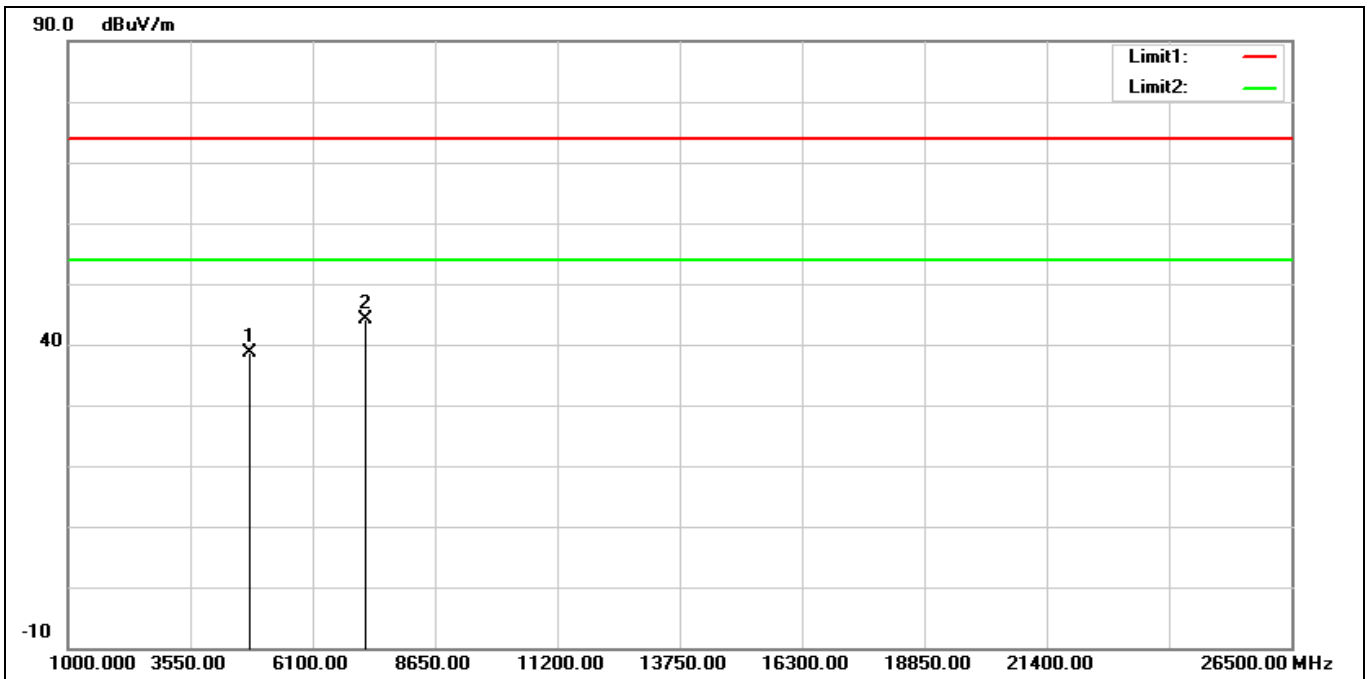

No.	Frequency (MHz)	Reading (dBuV)	Correction (dB/m)	Result (dBuV/m)	Limit (dBuV/m)	Margin (dB)	Remark
1	4804.000	38.26	0.29	38.55	74.00	-35.45	peak
2*	7206.000	36.38	7.82	44.20	74.00	-29.80	peak

Standard:	Part 15C	Test Site:	966 Chamber
Polarization:	Horizontal		
Test Mode:	BLR C8 2440 MHz		
Remark:			

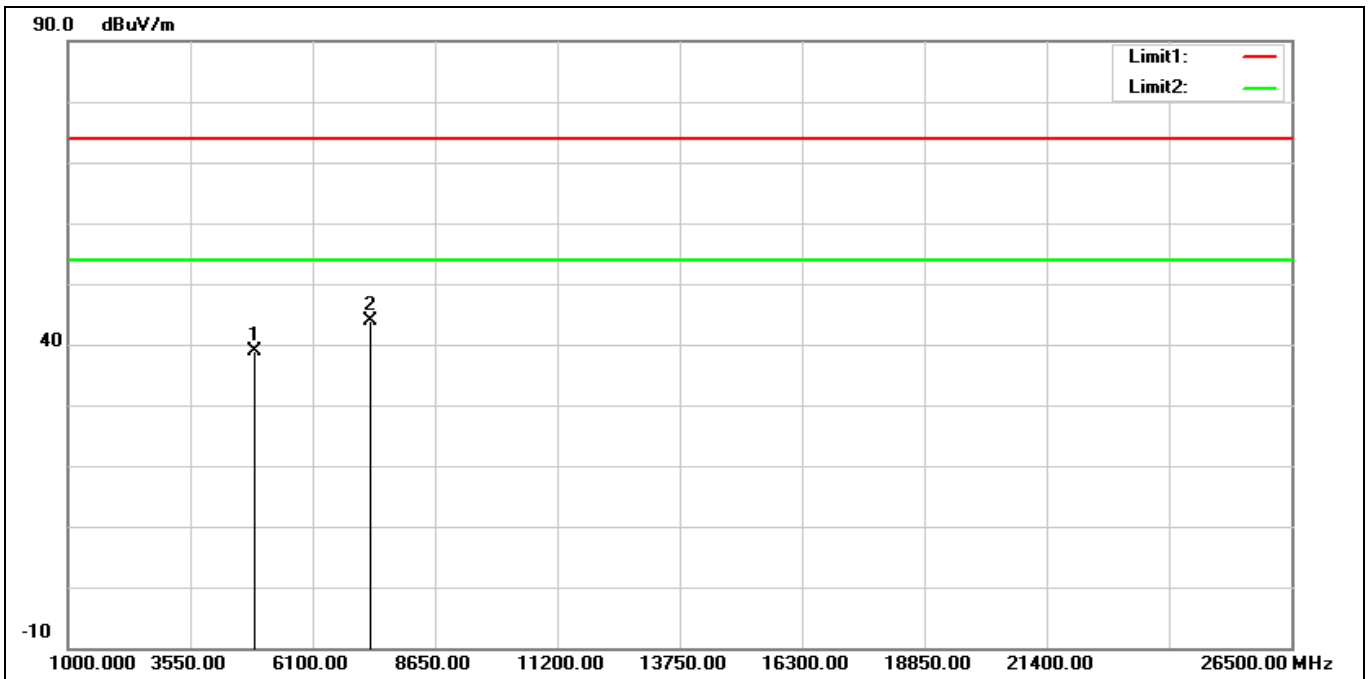

No.	Frequency (MHz)	Reading (dBuV)	Correction (dB/m)	Result (dBuV/m)	Limit (dBuV/m)	Margin (dB)	Remark
1	4880.000	38.62	0.38	39.00	74.00	-35.00	peak
2*	7320.000	35.91	7.99	43.90	74.00	-30.10	peak

Standard:	Part 15C	Test Site:	966 Chamber
Polarization:	Vertical		
Test Mode:	BLR C8 2440 MHz		
Remark:			

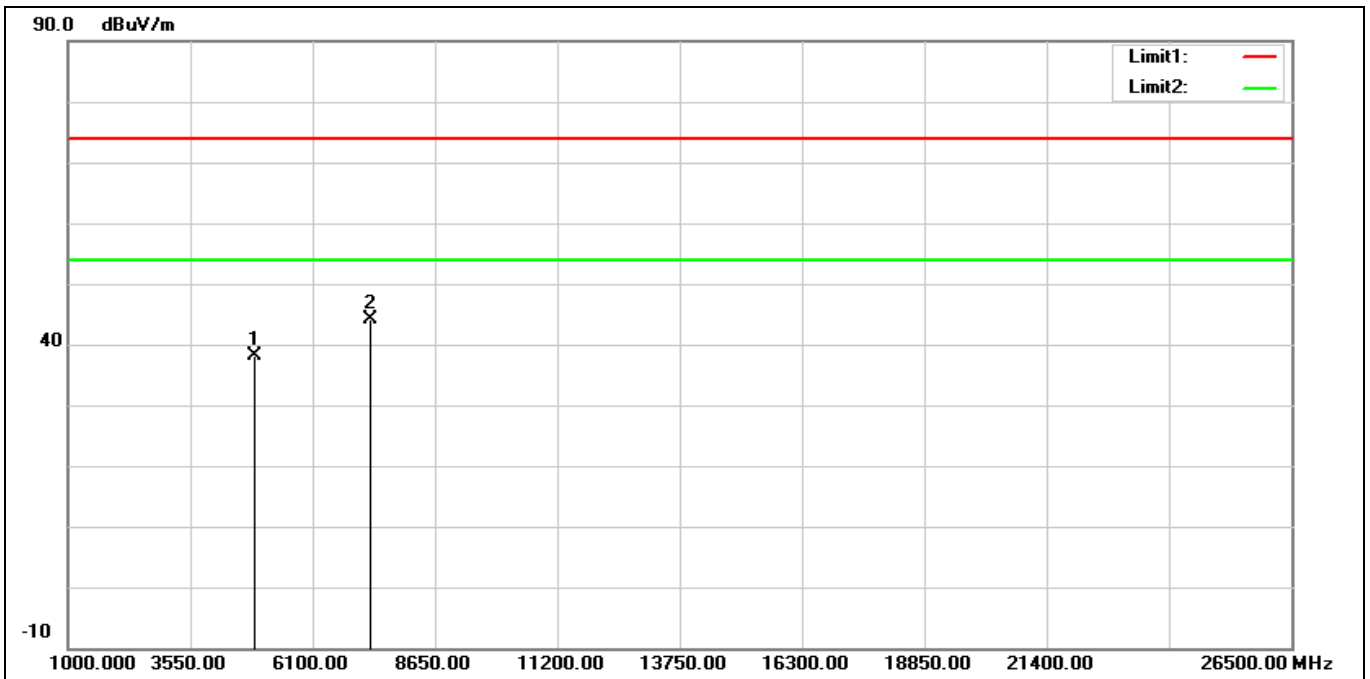

No.	Frequency (MHz)	Reading (dBuV)	Correction (dB/m)	Result (dBuV/m)	Limit (dBuV/m)	Margin (dB)	Remark
1	4880.000	37.87	0.38	38.25	74.00	-35.75	peak
2*	7320.000	36.11	7.99	44.10	74.00	-29.90	peak

Standard:	Part 15C	Test Site:	966 Chamber
Polarization:	Horizontal		
Test Mode:	BLR C8 2480 MHz		
Remark:			

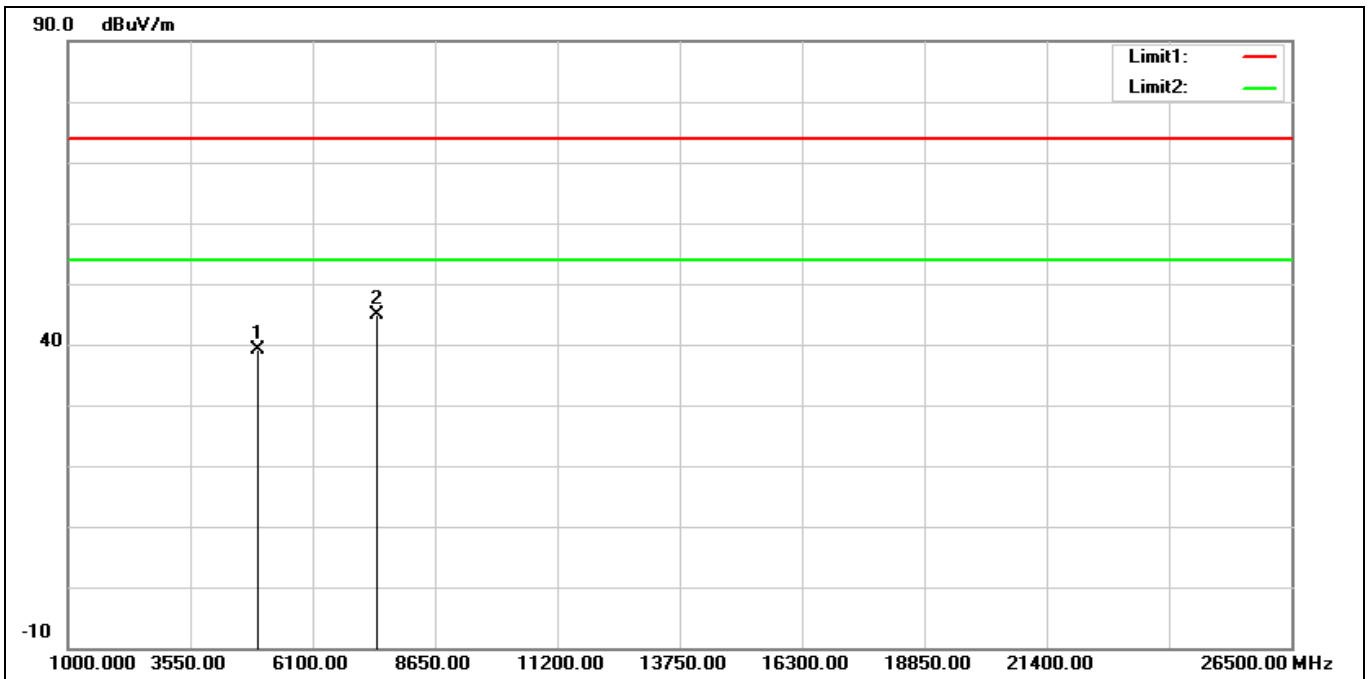

No.	Frequency (MHz)	Reading (dBuV)	Correction (dB/m)	Result (dBuV/m)	Limit (dBuV/m)	Margin (dB)	Remark
1	4960.000	38.68	0.57	39.25	74.00	-34.75	peak
2*	7440.000	36.62	8.34	44.96	74.00	-29.04	peak

Standard:	Part 15C	Test Site:	966 Chamber
Polarization:	Vertical		
Test Mode:	BLR C8 2480 MHz		
Remark:			

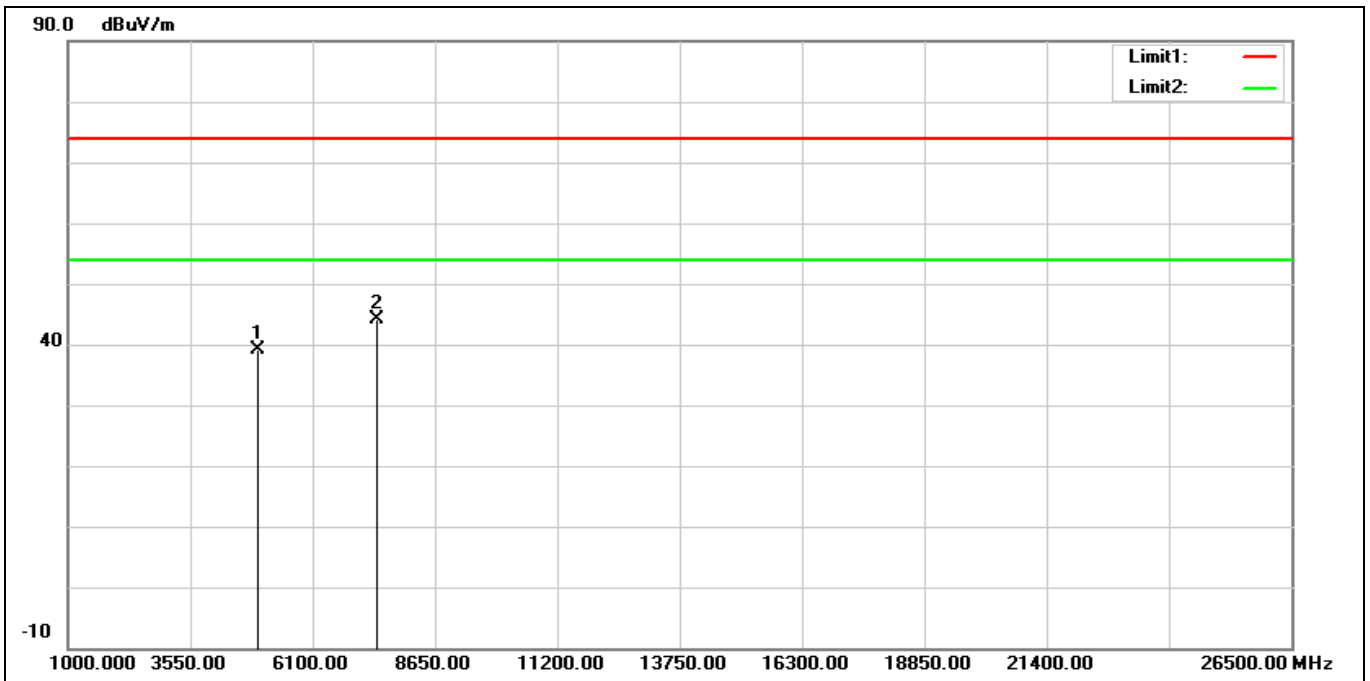

No.	Frequency (MHz)	Reading (dBuV)	Correction (dB/m)	Result (dBuV/m)	Limit (dBuV/m)	Margin (dB)	Remark
1	4960.000	38.55	0.57	39.12	74.00	-34.88	peak
2*	7440.000	35.81	8.34	44.15	74.00	-29.85	peak

Band Edge

Standard:	Part 15C	Test Site:	966 Chamber
Polarization:	Horizontal		
Test Mode:	BLE 2M 2402 MHz		
Remark:			

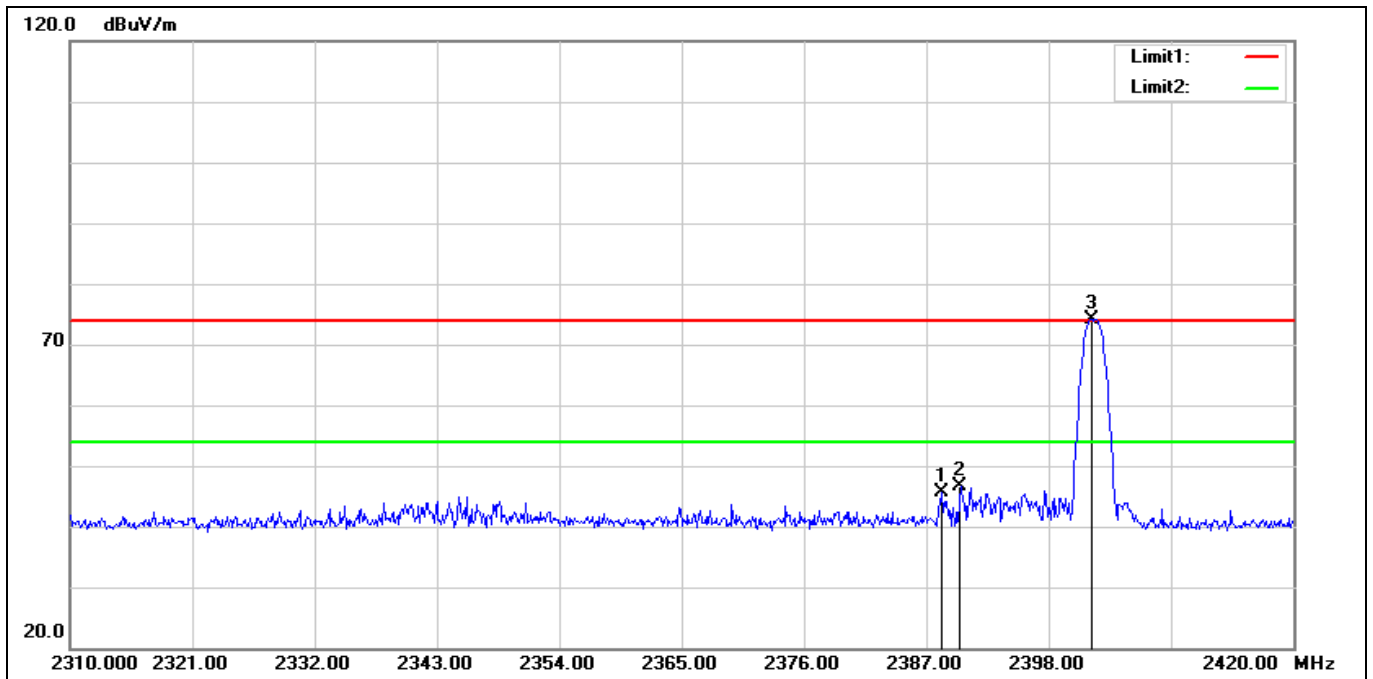

No.	Frequency (MHz)	Reading (dBuV)	Correction (dB/m)	Result (dBuV/m)	Limit (dBuV/m)	Margin (dB)	Remark
1	2388.430	51.78	-6.18	45.60	74.00	-28.40	peak
2	2390.000	52.80	-6.19	46.61	74.00	-27.39	peak
3*	2401.850	80.35	-6.25	74.10	74.00	0.10	peak

Standard:	Part 15C	Test Site:	966 Chamber
Polarization:	Vertical		
Test Mode:	BLE 2M 2402 MHz		
Remark:			

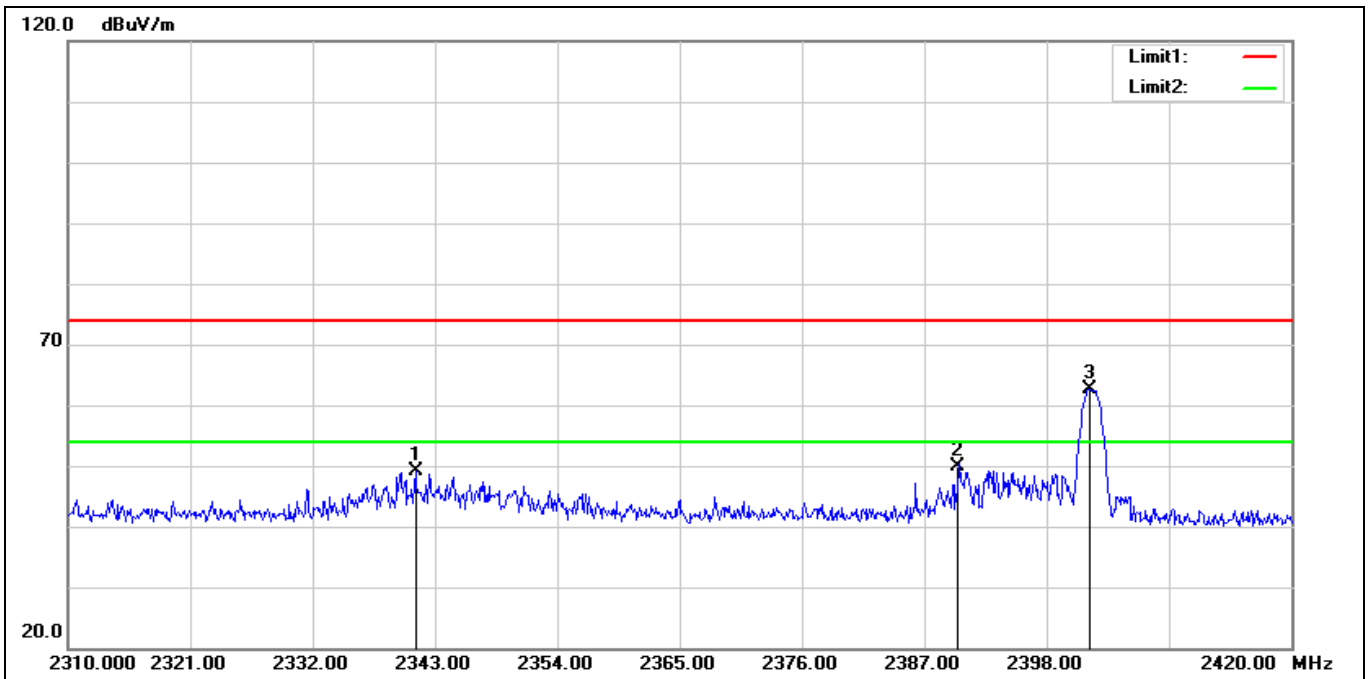

No.	Frequency (MHz)	Reading (dBuV)	Correction (dB/m)	Result (dBuV/m)	Limit (dBuV/m)	Margin (dB)	Remark
1	2341.240	55.05	-6.03	49.02	74.00	-24.98	peak
2	2390.000	56.18	-6.19	49.99	74.00	-24.01	peak
3*	2401.850	68.90	-6.25	62.65	74.00	-11.35	peak

Standard:	Part 15C	Test Site:	966 Chamber
Polarization:	Horizontal		
Test Mode:	BLE 2M 2480 MHz		
Remark:			

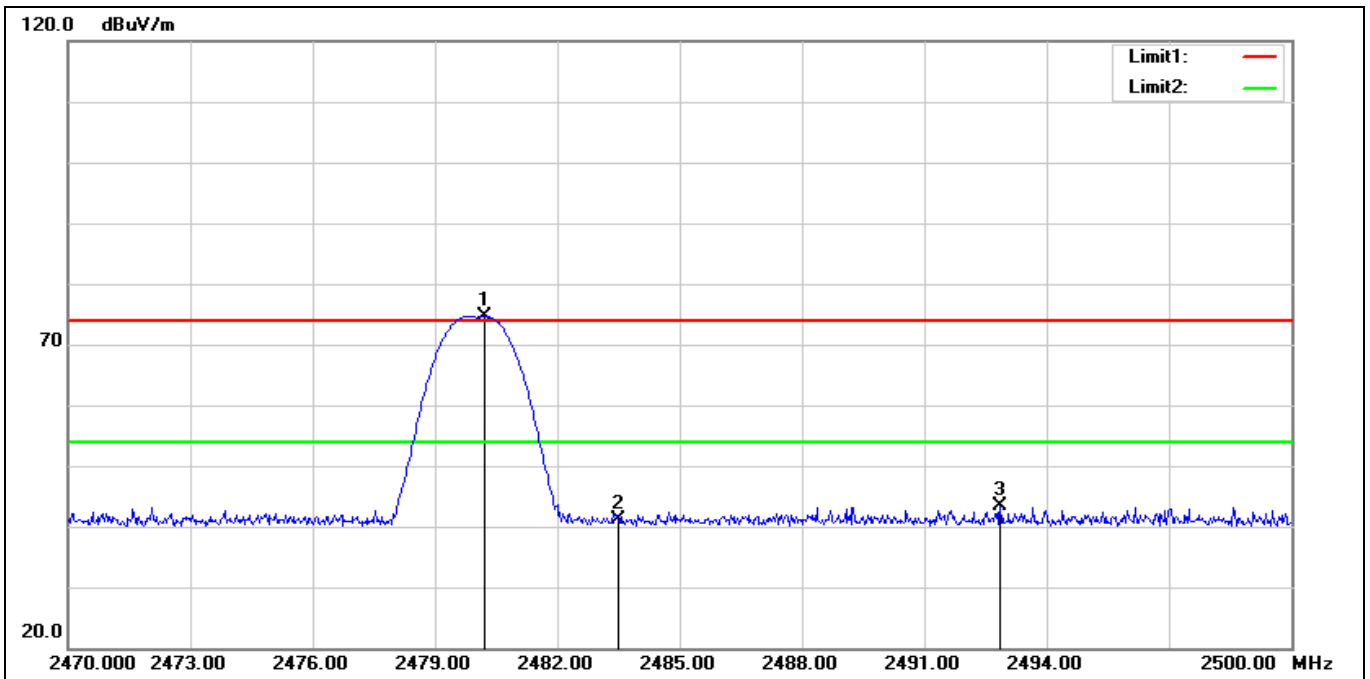

No.	Frequency (MHz)	Reading (dBuV)	Correction (dB/m)	Result (dBuV/m)	Limit (dBuV/m)	Margin (dB)	Remark
1*	2480.230	81.10	-6.46	74.64	74.00	0.64	peak
2	2483.500	47.50	-6.46	41.04	74.00	-32.96	peak
3	2492.860	49.87	-6.49	43.38	74.00	-30.62	peak

Standard:	Part 15C	Test Site:	966 Chamber
Polarization:	Vertical		
Test Mode:	BLE 2M 2480 MHz		
Remark:			

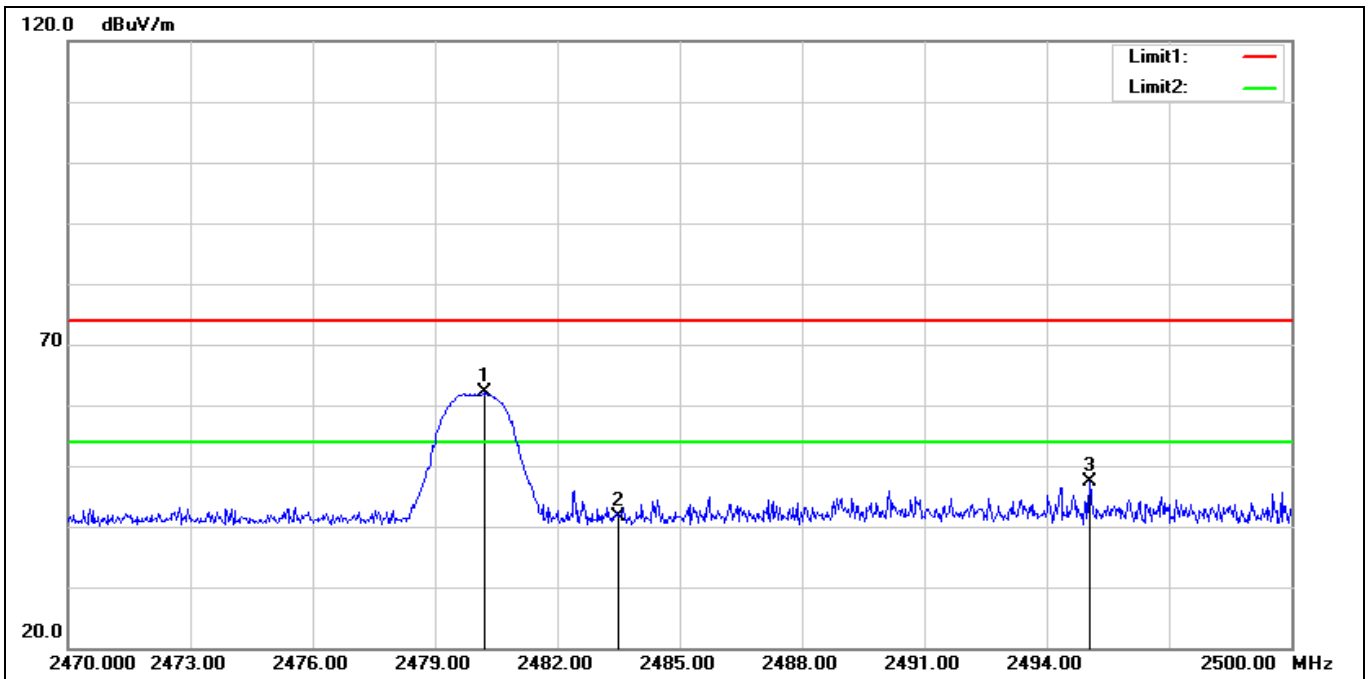

No.	Frequency (MHz)	Reading (dBuV)	Correction (dB/m)	Result (dBuV/m)	Limit (dBuV/m)	Margin (dB)	Remark
1*	2480.200	68.57	-6.46	62.11	74.00	-11.89	peak
2	2483.500	47.99	-6.46	41.53	74.00	-32.47	peak
3	2495.050	53.99	-6.49	47.50	74.00	-26.50	peak

Standard:	Part 15C	Test Site:	966 Chamber
Polarization:	Horizontal		
Test Mode:	BLR C8 2402 MHz		
Remark:			

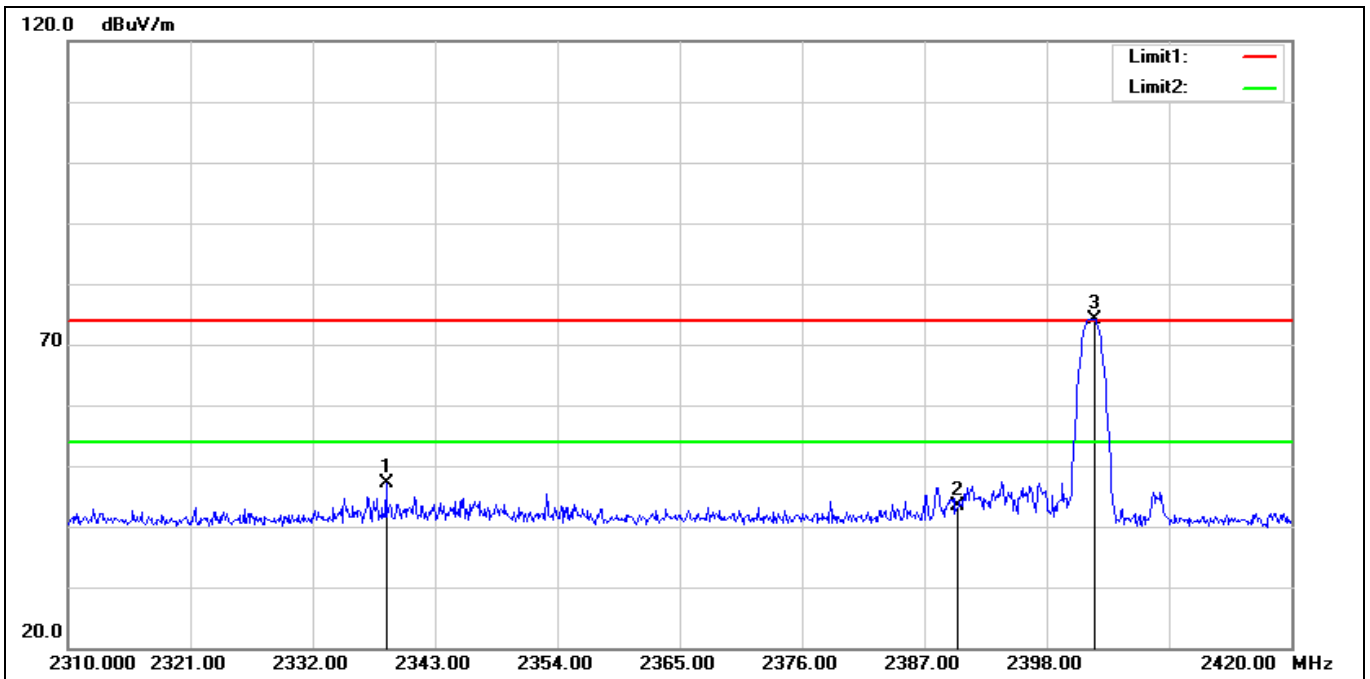

No.	Frequency (MHz)	Reading (dBuV)	Correction (dB/m)	Result (dBuV/m)	Limit (dBuV/m)	Margin (dB)	Remark
1	2338.600	53.12	-6.03	47.09	74.00	-26.91	peak
2	2390.000	49.65	-6.19	43.46	74.00	-30.54	peak
3*	2402.290	80.38	-6.25	74.13	74.00	0.13	peak

Standard:	Part 15C	Test Site:	966 Chamber
Polarization:	Horizontal		
Test Mode:	BLR C8 2402 MHz		
Remark:			

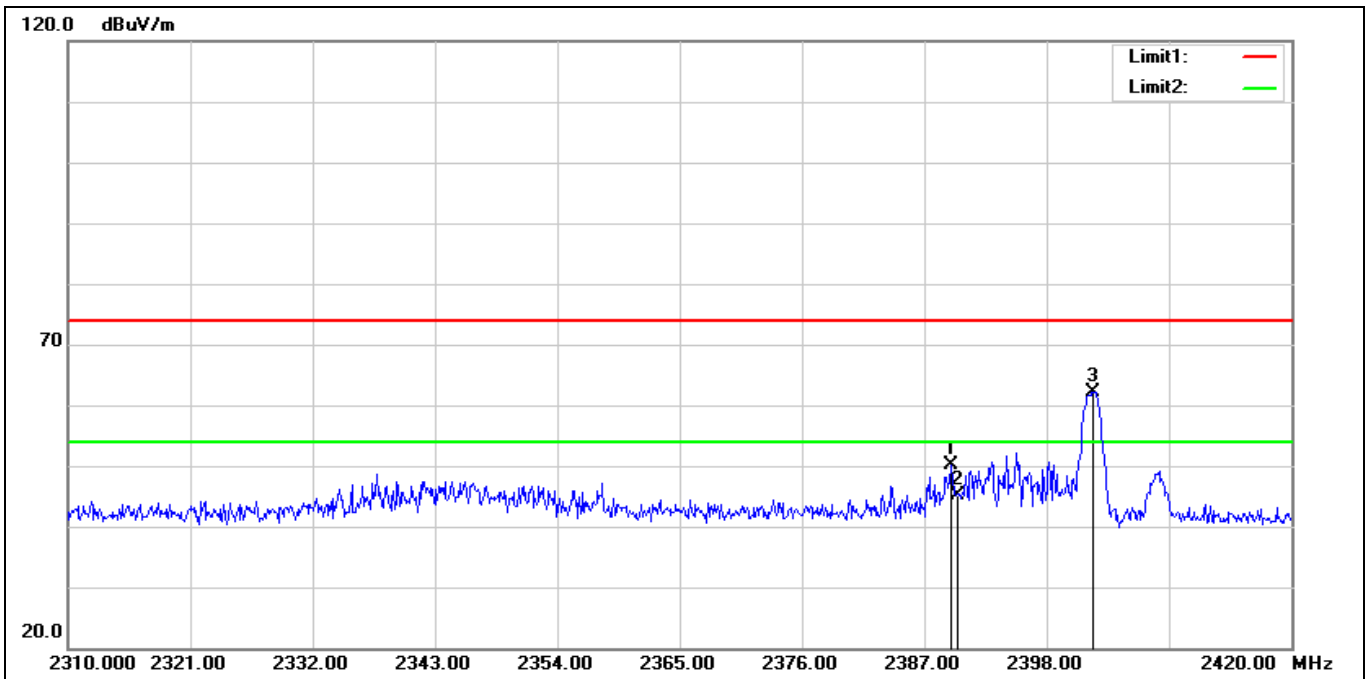

No.	Frequency (MHz)	Reading (dBuV)	Correction (dB/m)	Result (dBuV/m)	Limit (dBuV/m)	Margin (dB)	Remark
1	2389.420	56.23	-6.19	50.04	74.00	-23.96	peak
2	2390.000	51.29	-6.19	45.10	74.00	-28.90	peak
3*	2402.180	68.40	-6.25	62.15	74.00	-11.85	peak

Standard:	Part 15C	Test Site:	966 Chamber
Polarization:	Horizontal		
Test Mode:	BLR C8 2480 MHz		
Remark:			

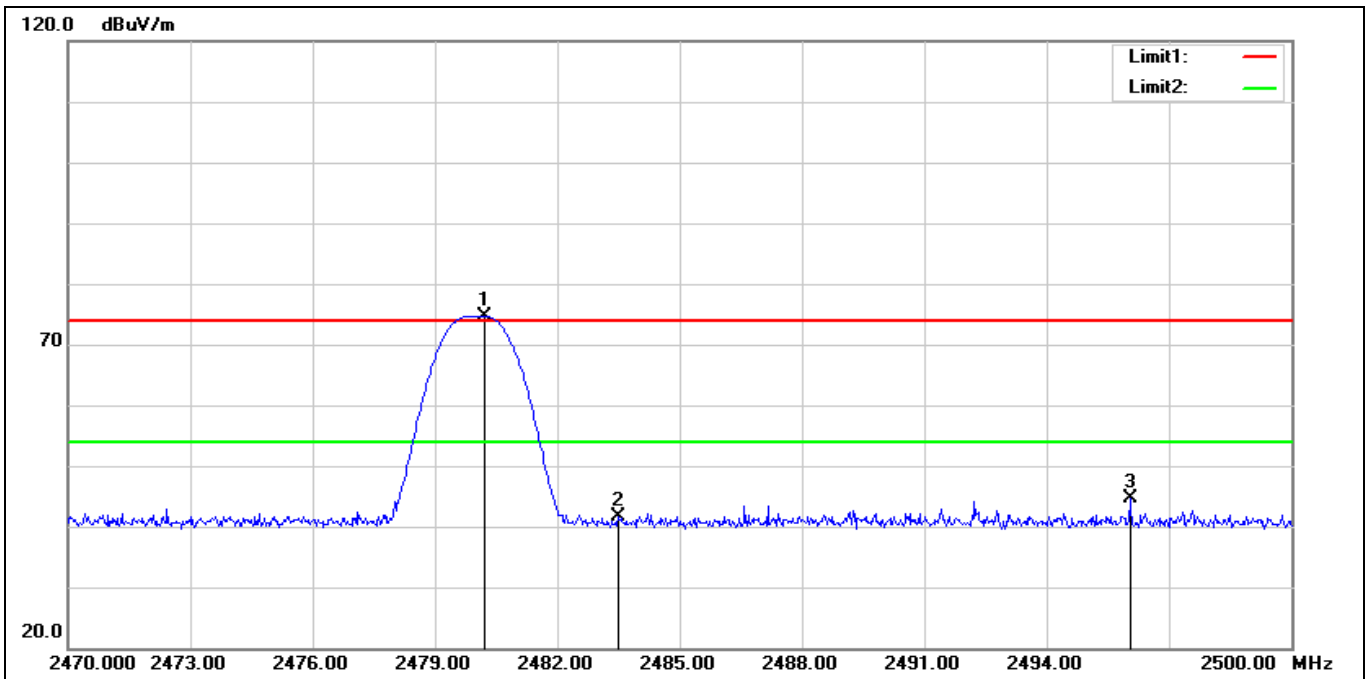

No.	Frequency (MHz)	Reading (dBuV)	Correction (dB/m)	Result (dBuV/m)	Limit (dBuV/m)	Margin (dB)	Remark
1*	2480.230	81.11	-6.46	74.65	74.00	0.65	peak
2	2483.500	48.02	-6.46	41.56	74.00	-32.44	peak
3	2496.040	51.14	-6.49	44.65	74.00	-29.35	peak

Standard:	Part 15C	Test Site:	966 Chamber
Polarization:	Vertical		
Test Mode:	BLR C8 2480 MHz		
Remark:			

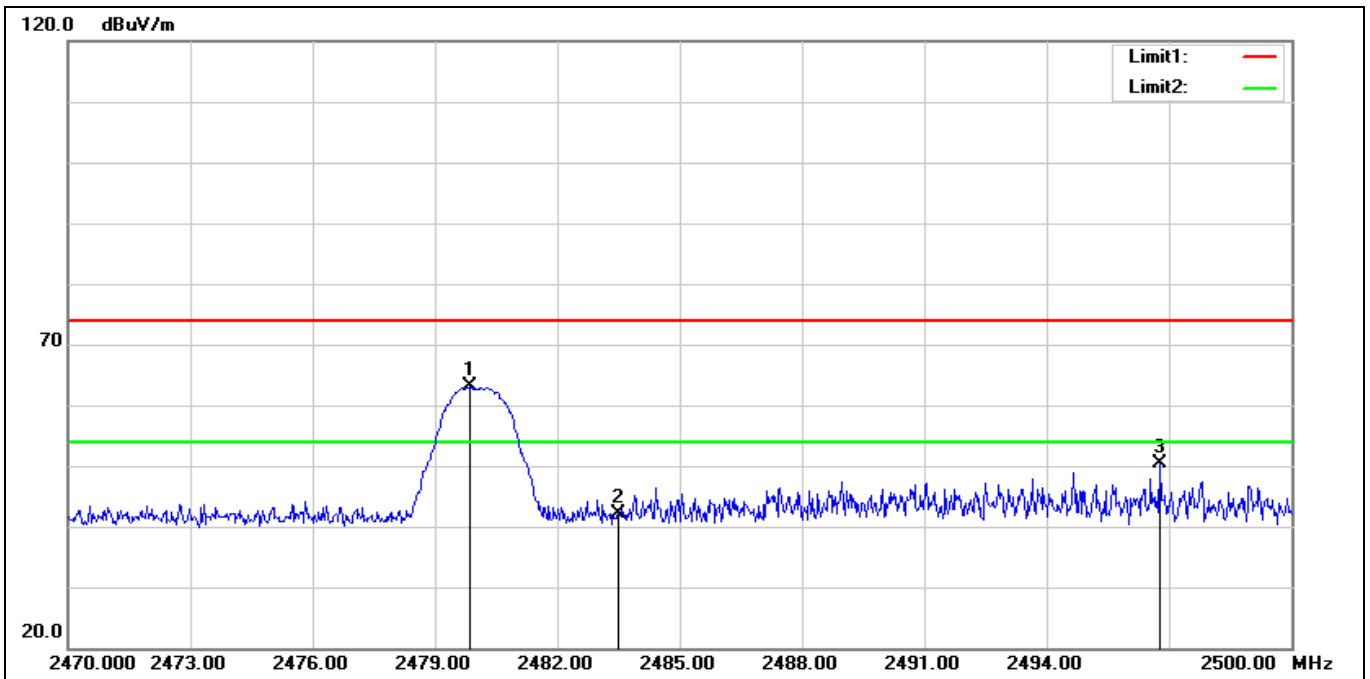

No.	Frequency (MHz)	Reading (dBuV)	Correction (dB/m)	Result (dBuV/m)	Limit (dBuV/m)	Margin (dB)	Remark
1*	2479.840	69.55	-6.46	63.09	74.00	-10.91	peak
2	2483.500	48.68	-6.46	42.22	74.00	-31.78	peak
3	2496.790	56.86	-6.50	50.36	74.00	-23.64	peak

Antenna brand: Laird

Below 1 GHz

Standard:	Part 15C	Test Site:	966 Chamber
Polarization:	Horizontal		
Test Mode:	BLE 2M 2402 MHz		
Remark:			

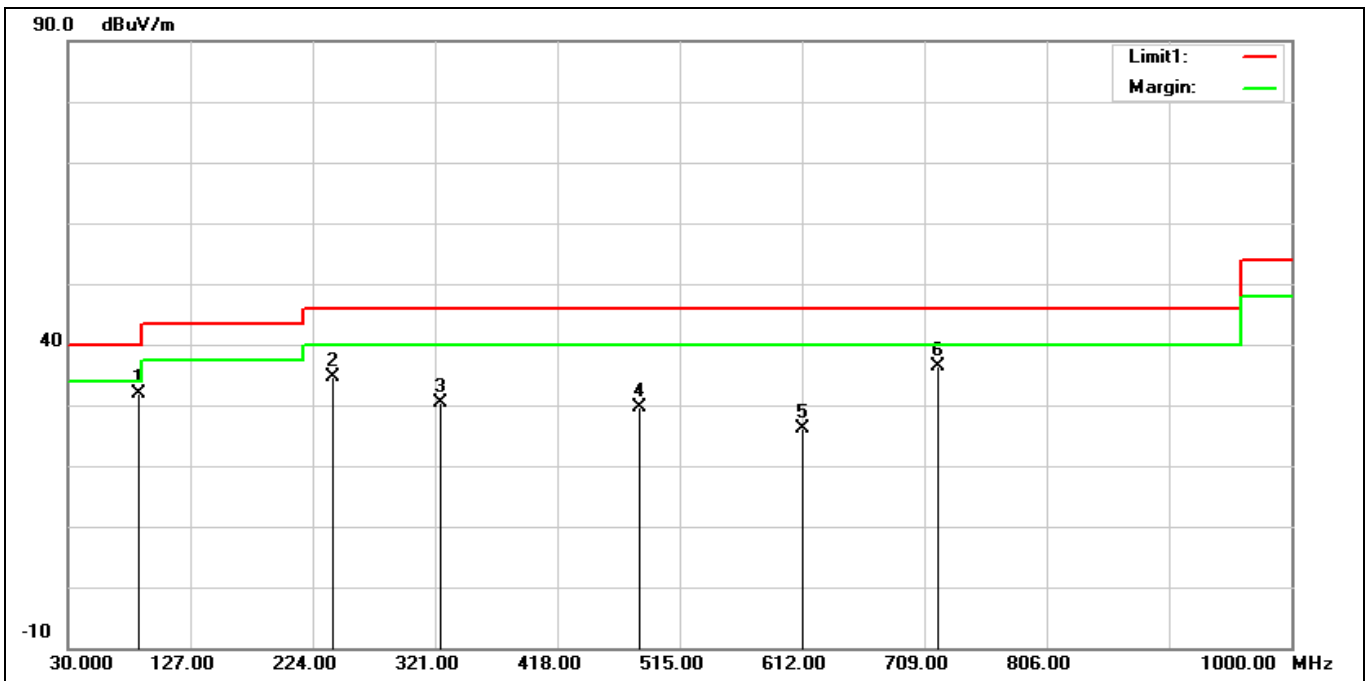

No.	Frequency (MHz)	Reading (dBuV)	Correction (dB/m)	Result (dBuV/m)	Limit (dBuV/m)	Margin (dB)	Remark
1*	86.2600	44.94	-13.01	31.93	40.00	-8.07	QP
2	240.4900	42.33	-7.65	34.68	46.00	-11.32	QP
3	325.8500	35.71	-5.26	30.45	46.00	-15.55	QP
4	482.9900	31.87	-2.16	29.71	46.00	-16.29	QP
5	612.9700	25.87	0.28	26.15	46.00	-19.85	QP
6	719.6700	34.30	2.09	36.39	46.00	-9.61	QP

Standard:	Part 15C	Test Site:	966 Chamber
Polarization:	Vertical		
Test Mode:	BLE 2M 2402 MHz		
Remark:			

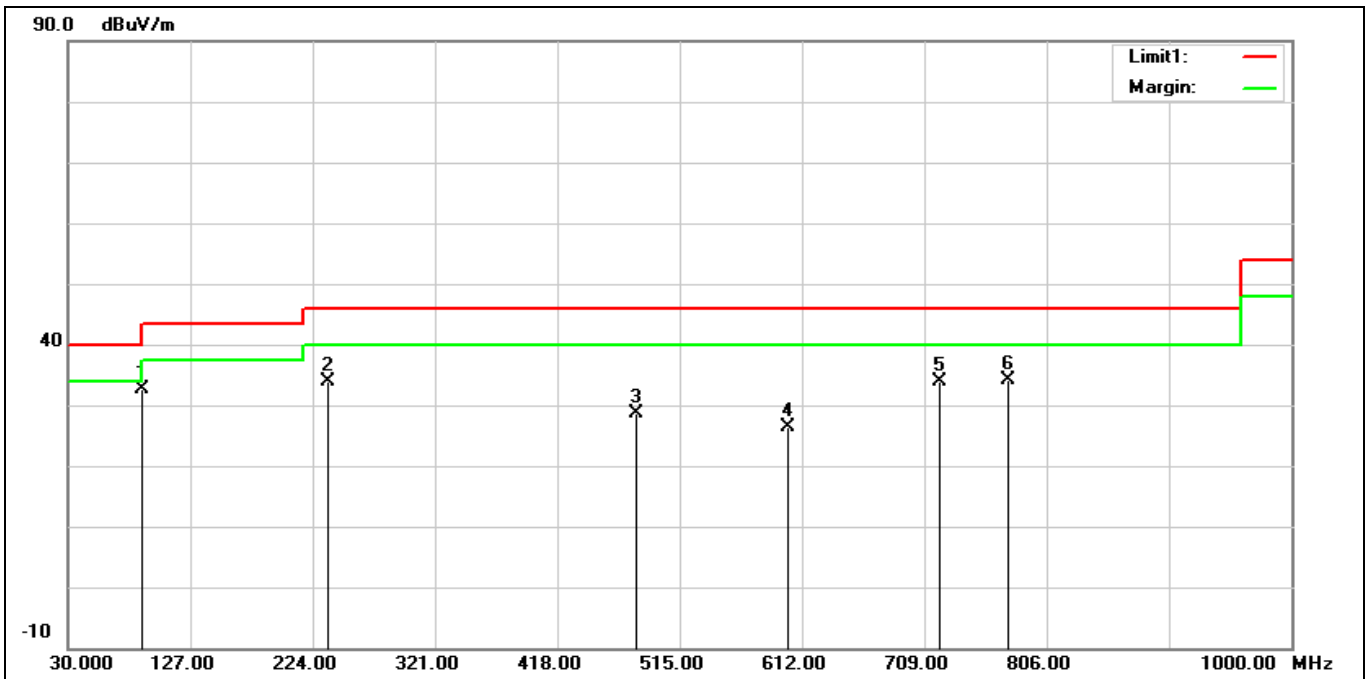

No.	Frequency (MHz)	Reading (dBuV)	Correction (dB/m)	Result (dBuV/m)	Limit (dBuV/m)	Margin (dB)	Remark
1*	88.2000	45.89	-13.23	32.66	43.50	-10.84	QP
2	236.6100	41.90	-7.92	33.98	46.00	-12.02	QP
3	480.0800	30.83	-2.20	28.63	46.00	-17.37	QP
4	601.3300	26.23	0.24	26.47	46.00	-19.53	QP
5	720.6400	31.69	2.11	33.80	46.00	-12.20	QP
6	774.9600	30.93	3.28	34.21	46.00	-11.79	QP

Harmonic

Above 1 GHz

Standard:	Part 15C	Test Site:	966 Chamber
Polarization:	Horizontal		
Test Mode:	BLE 2M 2402 MHz		
Remark:			

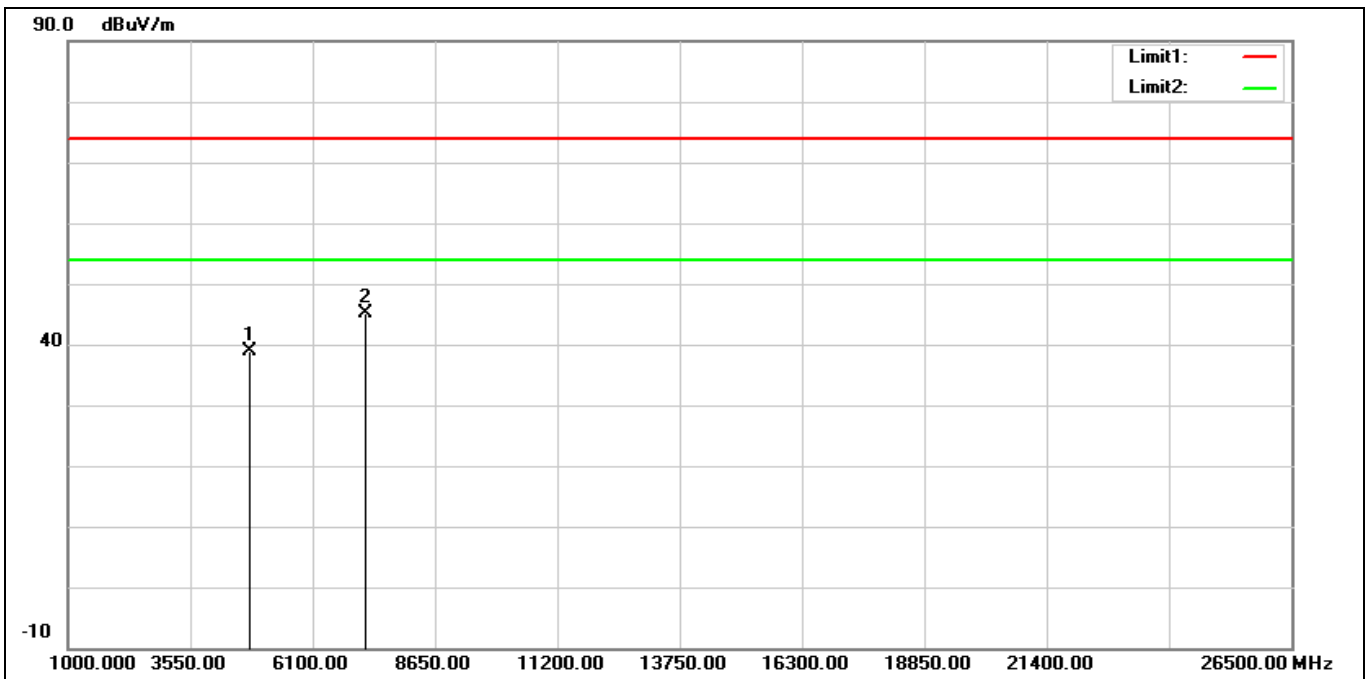

No.	Frequency (MHz)	Reading (dBuV)	Correction (dB/m)	Result (dBuV/m)	Limit (dBuV/m)	Margin (dB)	Remark
1	4804.000	38.66	0.29	38.95	74.00	-35.05	peak
2*	7206.000	37.42	7.82	45.24	74.00	-28.76	peak

Standard:	Part 15C	Test Site:	966 Chamber
Polarization:	Vertical		
Test Mode:	BLE 2M 2402 MHz		
Remark:			

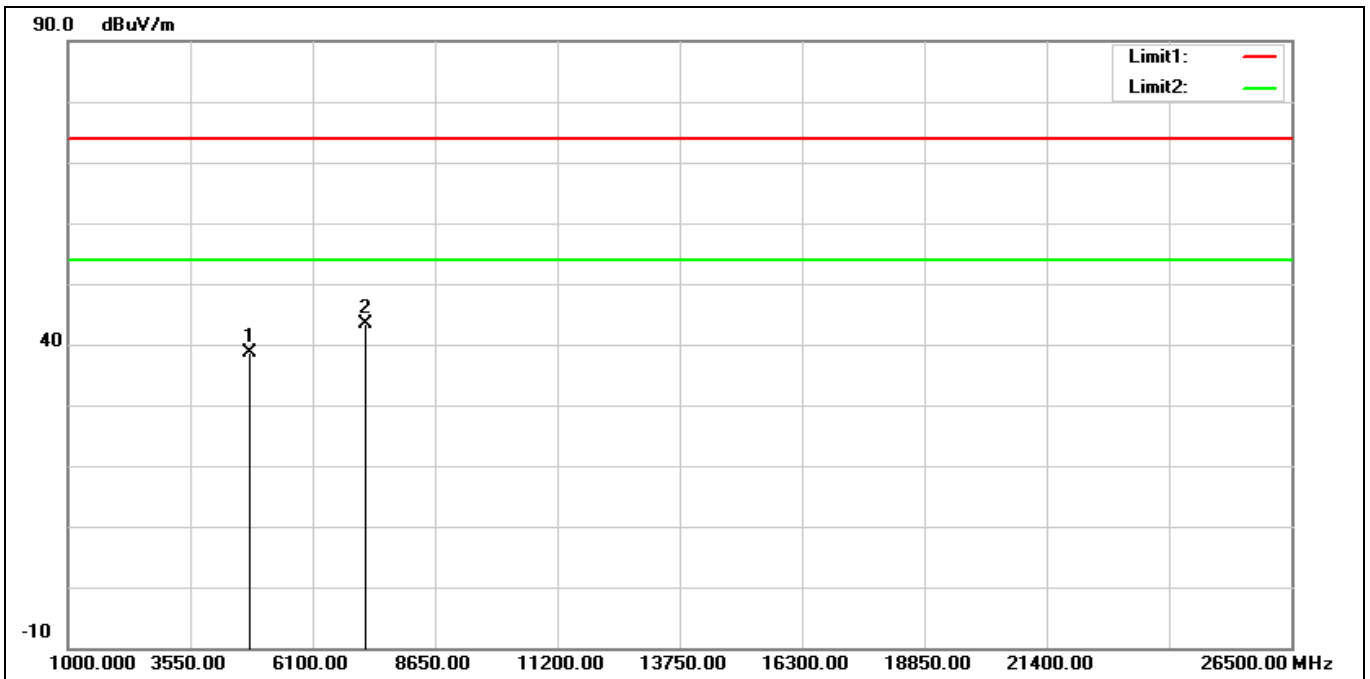

No.	Frequency (MHz)	Reading (dBuV)	Correction (dB/m)	Result (dBuV/m)	Limit (dBuV/m)	Margin (dB)	Remark
1	4804.000	38.24	0.29	38.53	74.00	-35.47	peak
2*	7206.000	35.54	7.82	43.36	74.00	-30.64	peak

Standard:	Part 15C	Test Site:	966 Chamber
Polarization:	Horizontal		
Test Mode:	BLE 2M 2440 MHz		
Remark:			

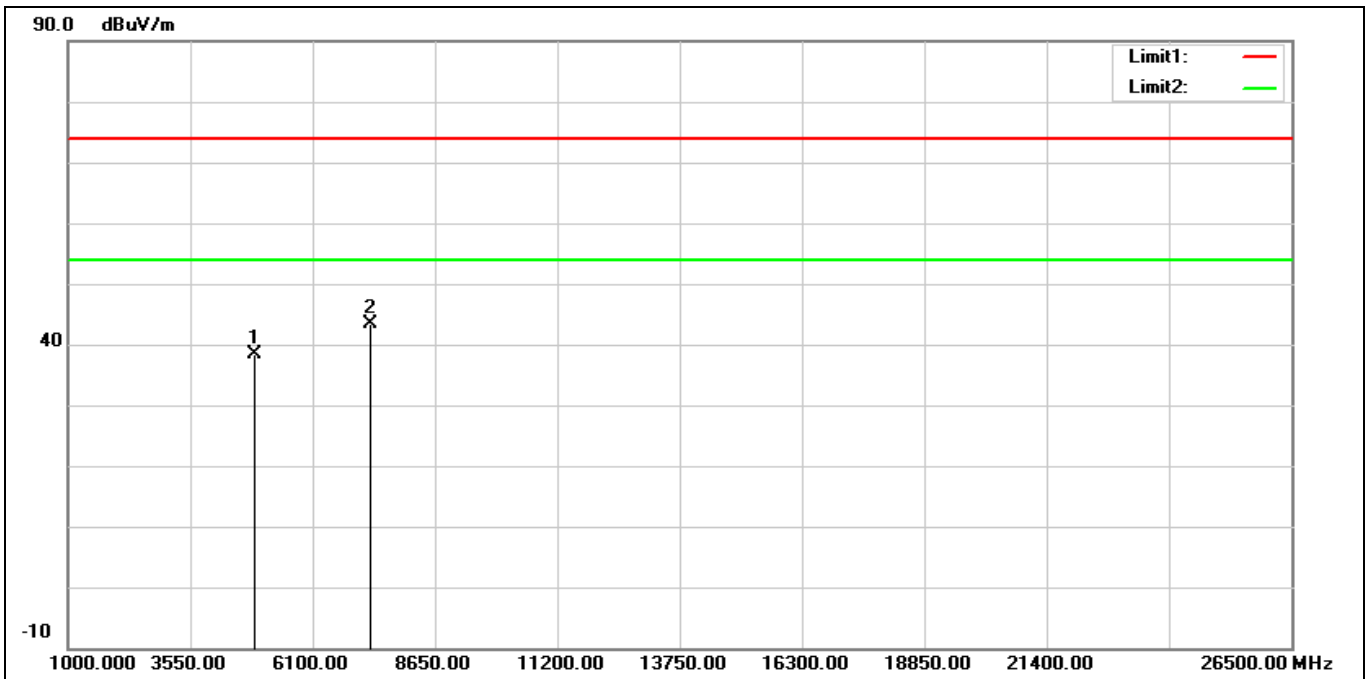

No.	Frequency (MHz)	Reading (dBuV)	Correction (dB/m)	Result (dBuV/m)	Limit (dBuV/m)	Margin (dB)	Remark
1	4880.000	37.98	0.38	38.36	74.00	-35.64	peak
2*	7320.000	35.27	7.99	43.26	74.00	-30.74	peak

Standard:	Part 15C	Test Site:	966 Chamber
Polarization:	Vertical		
Test Mode:	BLE 2M 2440 MHz		
Remark:			

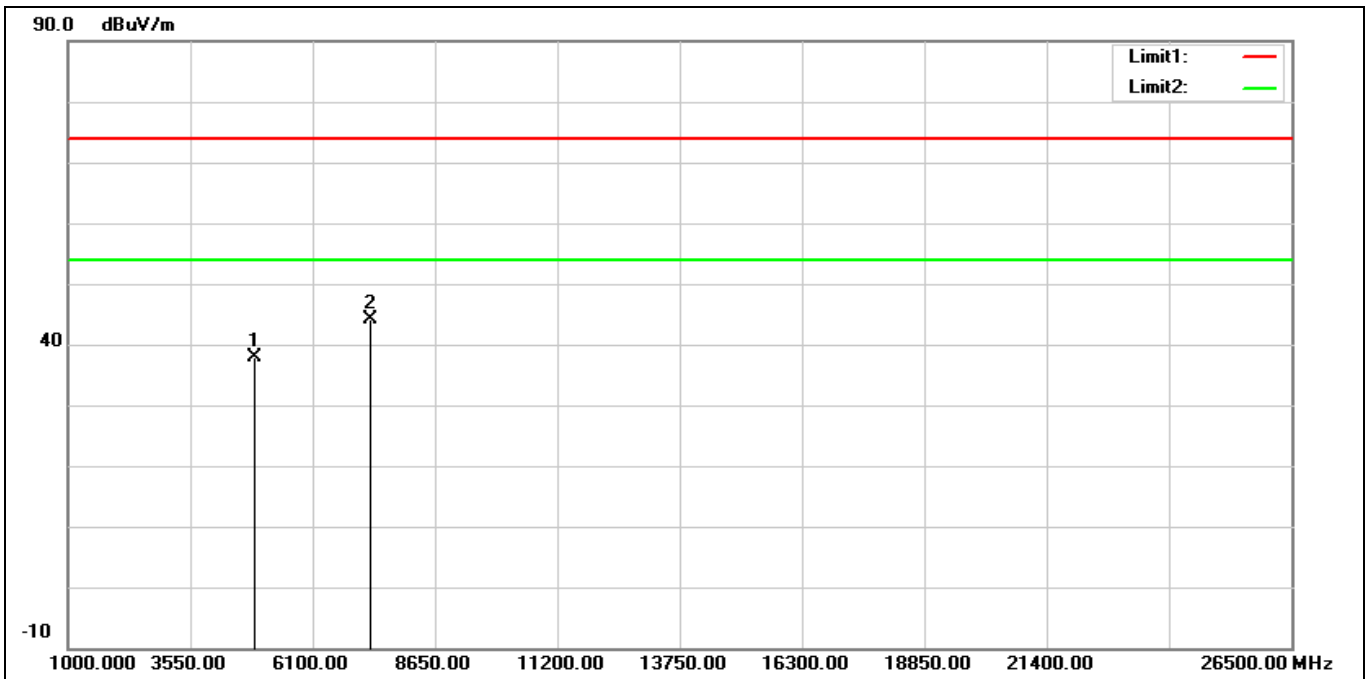

No.	Frequency (MHz)	Reading (dBuV)	Correction (dB/m)	Result (dBuV/m)	Limit (dBuV/m)	Margin (dB)	Remark
1	4880.000	37.46	0.38	37.84	74.00	-36.16	peak
2*	7320.000	36.18	7.99	44.17	74.00	-29.83	peak

Standard:	Part 15C	Test Site:	966 Chamber
Polarization:	Horizontal		
Test Mode:	BLE 2M 2480 MHz		
Remark:			

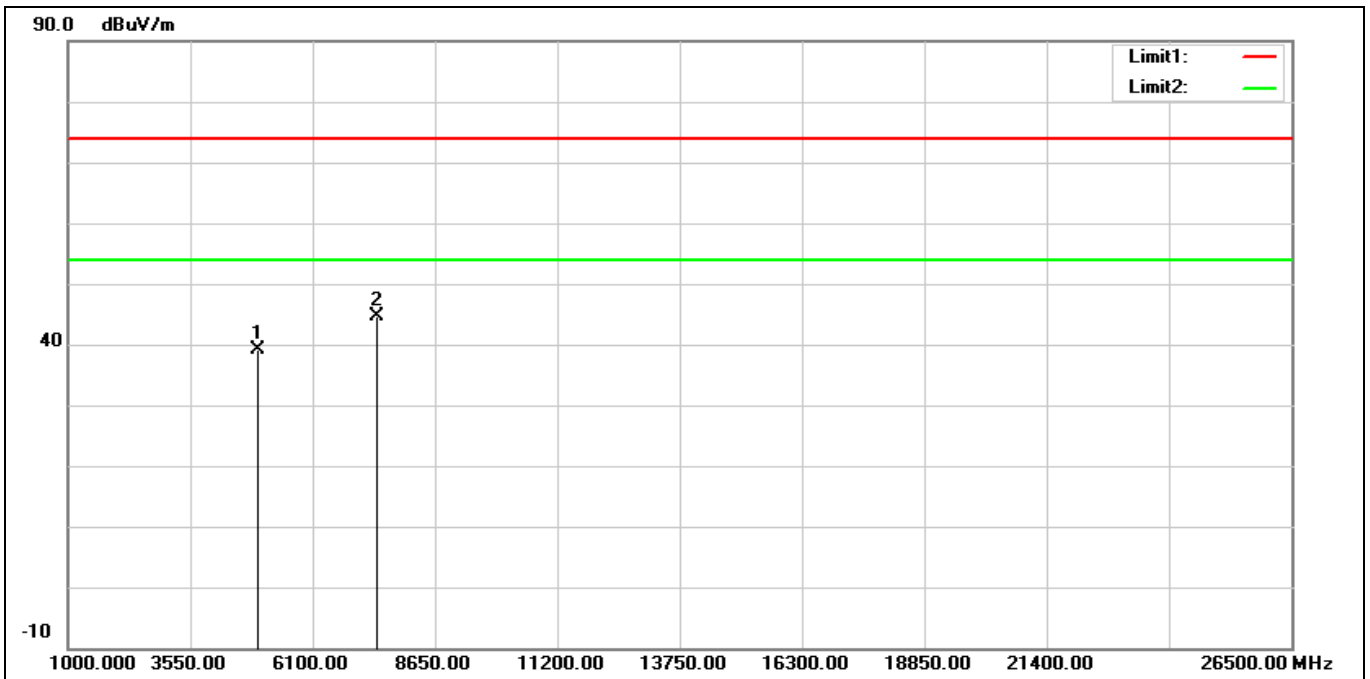

No.	Frequency (MHz)	Reading (dBuV)	Correction (dB/m)	Result (dBuV/m)	Limit (dBuV/m)	Margin (dB)	Remark
1	4960.000	38.65	0.57	39.22	74.00	-34.78	peak
2*	7440.000	36.24	8.34	44.58	74.00	-29.42	peak

Standard:	Part 15C	Test Site:	966 Chamber
Polarization:	Vertical		
Test Mode:	BLE 2M 2480 MHz		
Remark:			

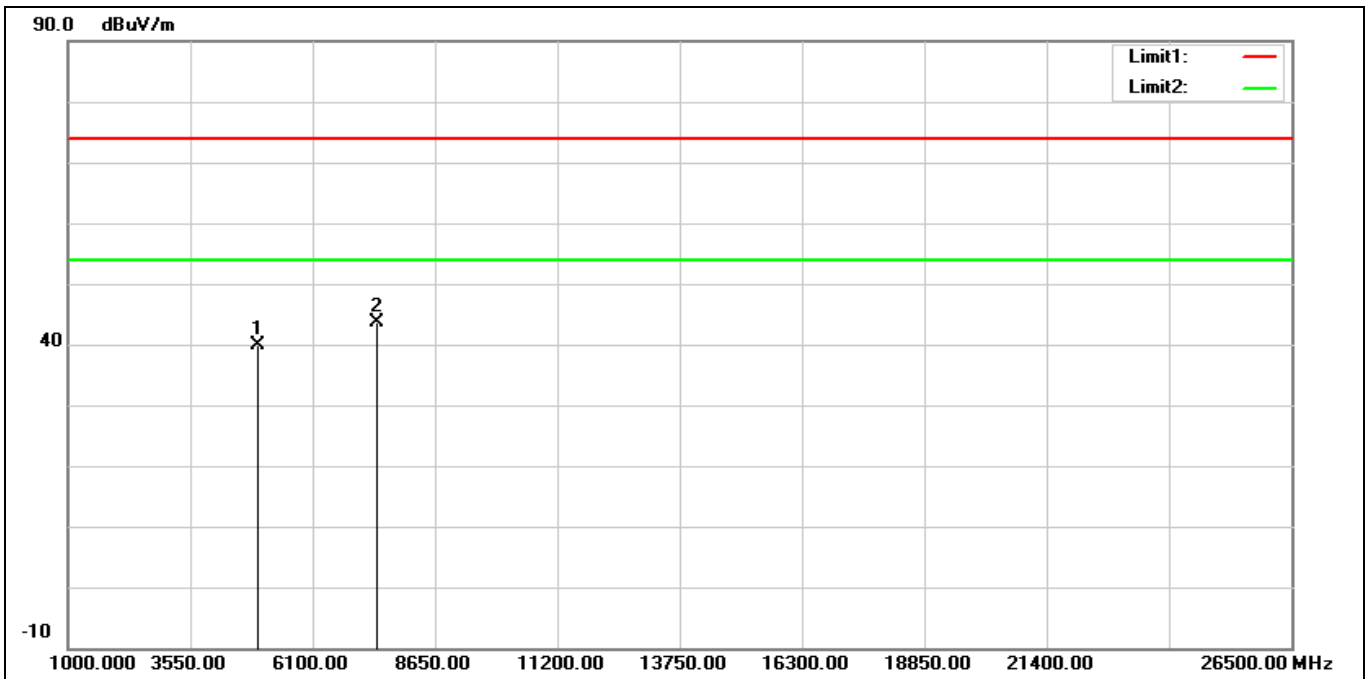

No.	Frequency (MHz)	Reading (dBuV)	Correction (dB/m)	Result (dBuV/m)	Limit (dBuV/m)	Margin (dB)	Remark
1	4960.000	39.19	0.57	39.76	74.00	-34.24	peak
2*	7440.000	35.27	8.34	43.61	74.00	-30.39	peak

Standard:	Part 15C	Test Site:	966 Chamber
Polarization:	Horizontal		
Test Mode:	BLR C8 2402 MHz		
Remark:			

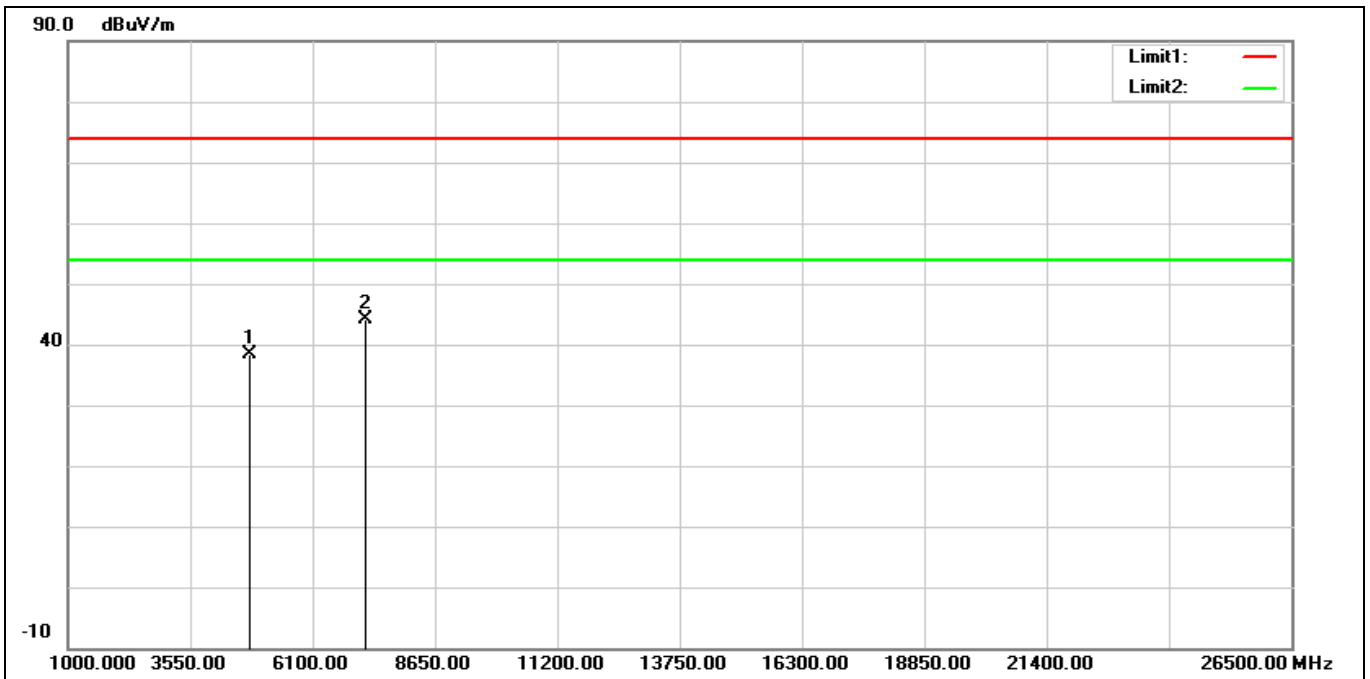

No.	Frequency (MHz)	Reading (dBuV)	Correction (dB/m)	Result (dBuV/m)	Limit (dBuV/m)	Margin (dB)	Remark
1	4804.000	38.01	0.29	38.30	74.00	-35.70	peak
2*	7206.000	36.30	7.82	44.12	74.00	-29.88	peak

Standard:	Part 15C	Test Site:	966 Chamber
Polarization:	Vertical		
Test Mode:	BLR C8 2402 MHz		
Remark:			

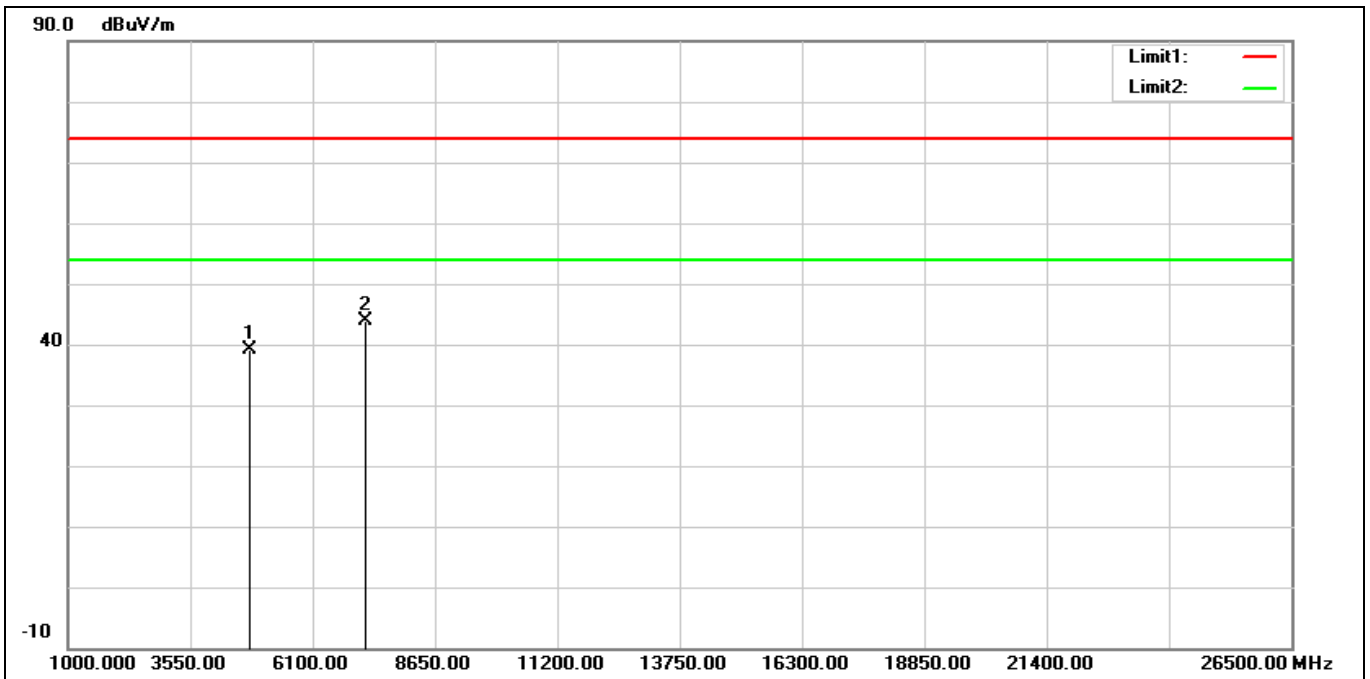

No.	Frequency (MHz)	Reading (dBuV)	Correction (dB/m)	Result (dBuV/m)	Limit (dBuV/m)	Margin (dB)	Remark
1	4804.000	38.91	0.29	39.20	74.00	-34.80	peak
2*	7206.000	35.99	7.82	43.81	74.00	-30.19	peak

Standard:	Part 15C	Test Site:	966 Chamber
Polarization:	Horizontal		
Test Mode:	BLR C8 2440 MHz		
Remark:			

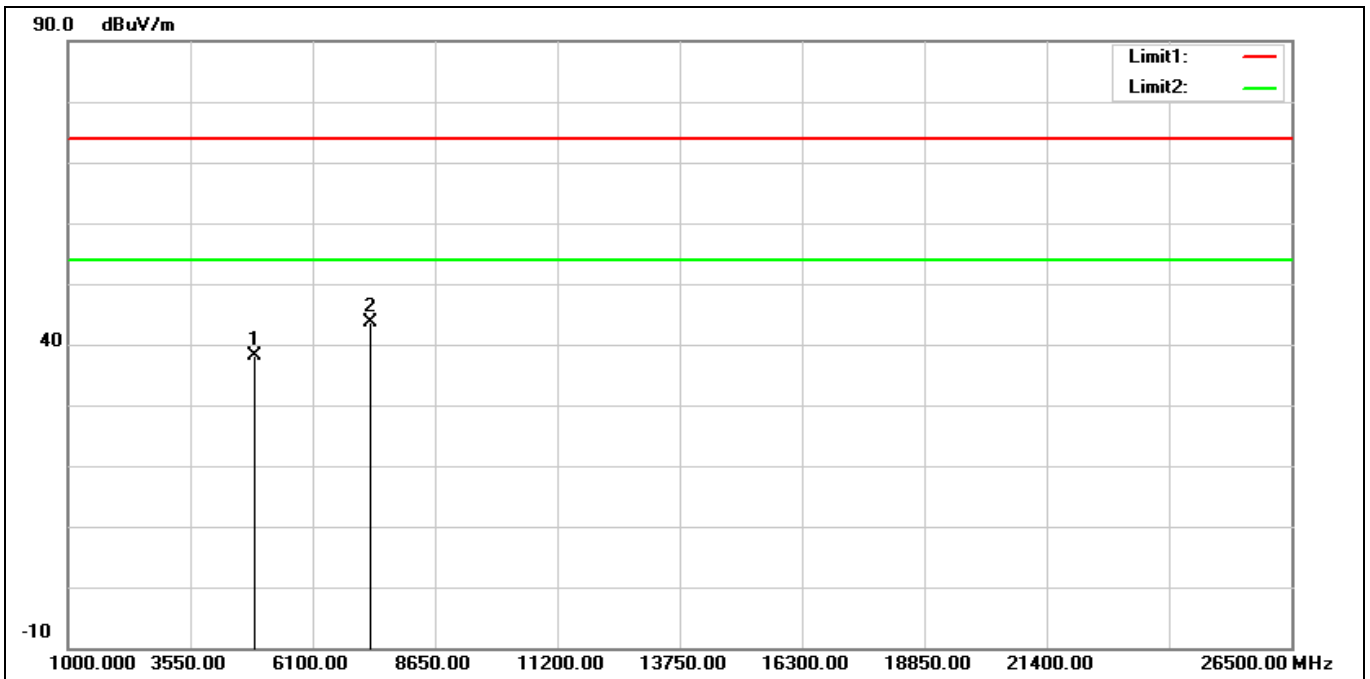

No.	Frequency (MHz)	Reading (dBuV)	Correction (dB/m)	Result (dBuV/m)	Limit (dBuV/m)	Margin (dB)	Remark
1	4880.000	37.79	0.38	38.17	74.00	-35.83	peak
2*	7320.000	35.53	7.99	43.52	74.00	-30.48	peak

Standard:	Part 15C	Test Site:	966 Chamber
Polarization:	Vertical		
Test Mode:	BLR C8 2440 MHz		
Remark:			

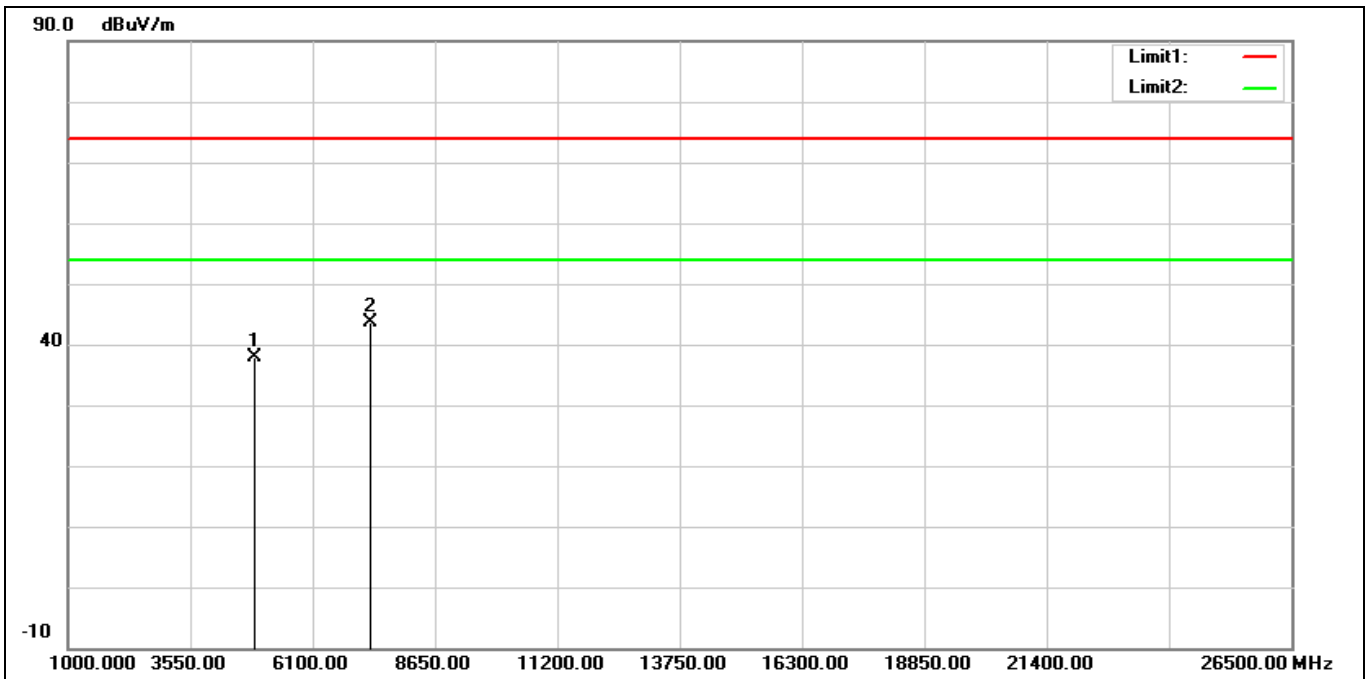

No.	Frequency (MHz)	Reading (dBuV)	Correction (dB/m)	Result (dBuV/m)	Limit (dBuV/m)	Margin (dB)	Remark
1	4880.000	37.46	0.38	37.84	74.00	-36.16	peak
2*	7320.000	35.58	7.99	43.57	74.00	-30.43	peak

Standard:	Part 15C	Test Site:	966 Chamber
Polarization:	Horizontal		
Test Mode:	BLR C8 2480 MHz		
Remark:			

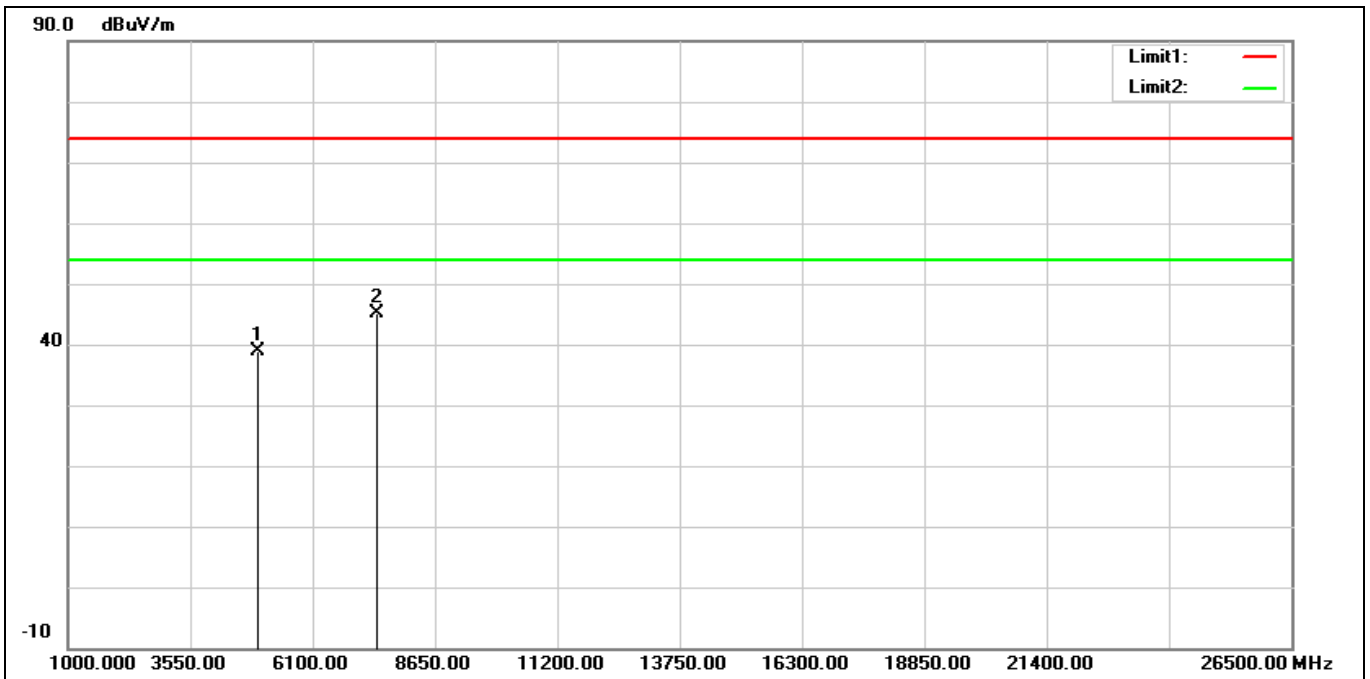

No.	Frequency (MHz)	Reading (dBuV)	Correction (dB/m)	Result (dBuV/m)	Limit (dBuV/m)	Margin (dB)	Remark
1	4960.000	38.34	0.57	38.91	74.00	-35.09	peak
2*	7440.000	36.76	8.34	45.10	74.00	-28.90	peak

Standard:	Part 15C	Test Site:	966 Chamber
Polarization:	Vertical		
Test Mode:	BLR C8 2480 MHz		
Remark:			

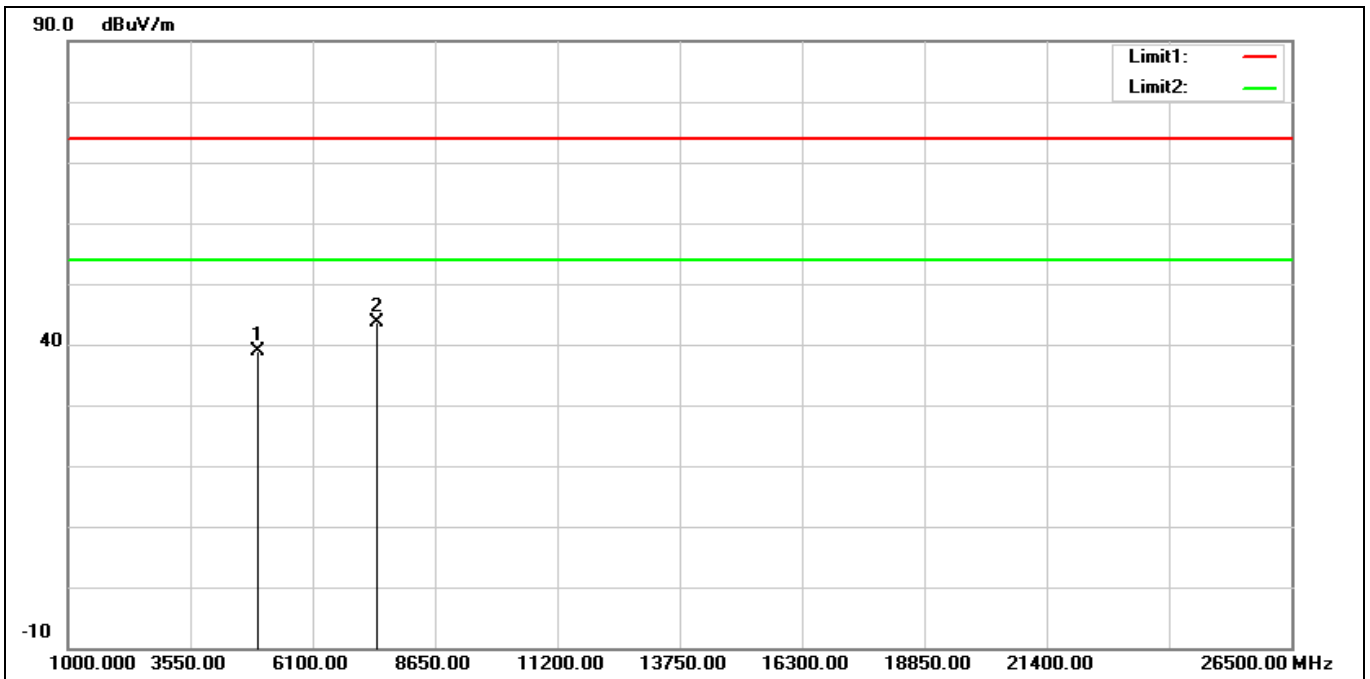

No.	Frequency (MHz)	Reading (dBuV)	Correction (dB/m)	Result (dBuV/m)	Limit (dBuV/m)	Margin (dB)	Remark
1	4960.000	38.26	0.57	38.83	74.00	-35.17	peak
2*	7440.000	35.37	8.34	43.71	74.00	-30.29	peak

Band Edge

Standard:	Part 15C	Test Site:	966 Chamber
Polarization:	Horizontal		
Test Mode:	BLE 2M 2402 MHz		
Remark:			

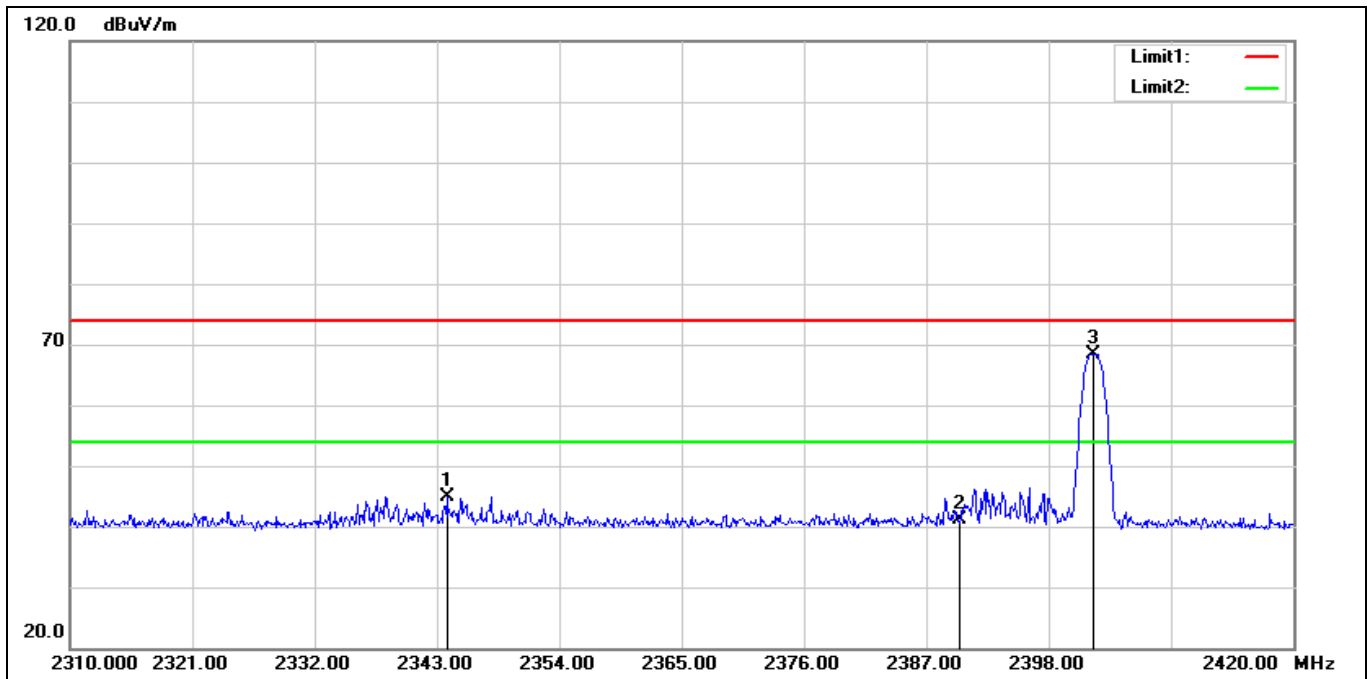

No.	Frequency (MHz)	Reading (dBuV)	Correction (dB/m)	Result (dBuV/m)	Limit (dBuV/m)	Margin (dB)	Remark
1	2343.880	50.98	-6.02	44.96	74.00	-29.04	peak
2	2390.000	47.39	-6.19	41.20	74.00	-32.80	peak
3*	2401.960	74.73	-6.25	68.48	74.00	-5.52	peak

Standard:	Part 15C	Test Site:	966 Chamber
Polarization:	Vertical		
Test Mode:	BLE 2M 2402 MHz		
Remark:			

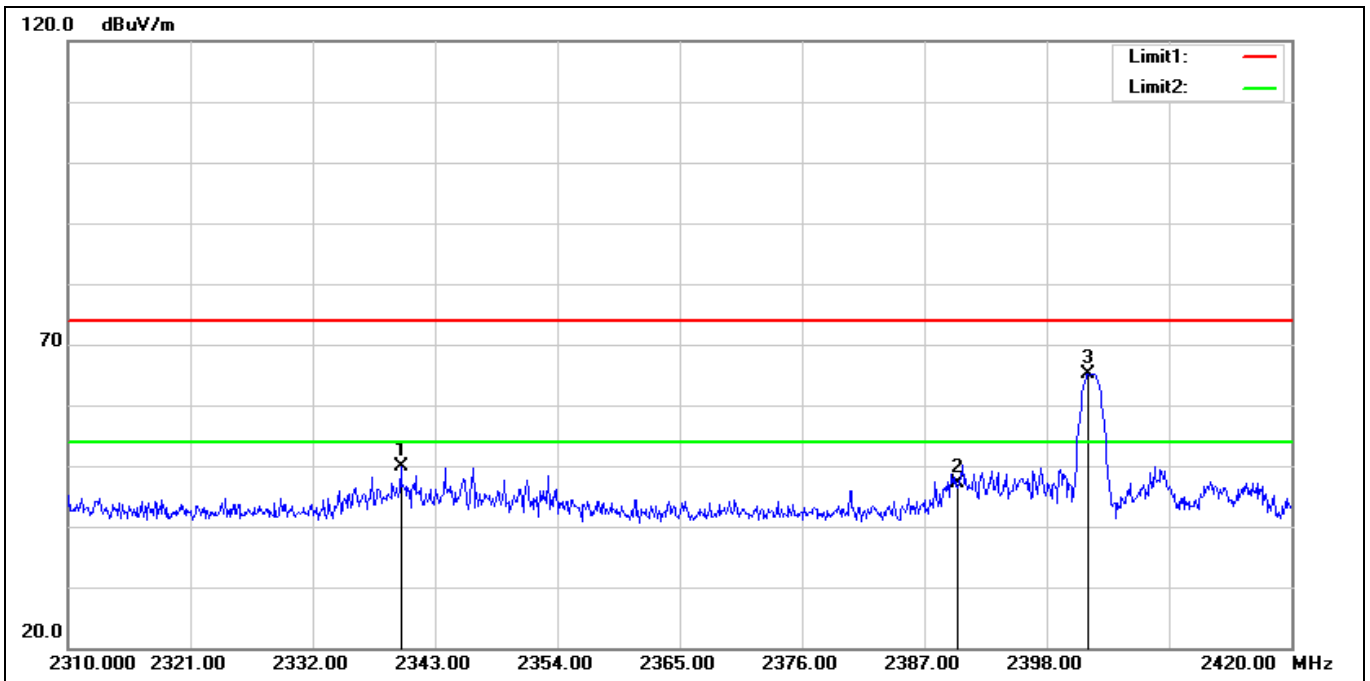

No.	Frequency (MHz)	Reading (dBuV)	Correction (dB/m)	Result (dBuV/m)	Limit (dBuV/m)	Margin (dB)	Remark
1	2339.920	56.00	-6.03	49.97	74.00	-24.03	peak
2	2390.000	53.44	-6.19	47.25	74.00	-26.75	peak
3*	2401.740	71.38	-6.25	65.13	74.00	-8.87	peak

Standard:	Part 15C	Test Site:	966 Chamber
Polarization:	Horizontal		
Test Mode:	BLE 2M 2480 MHz		
Remark:			

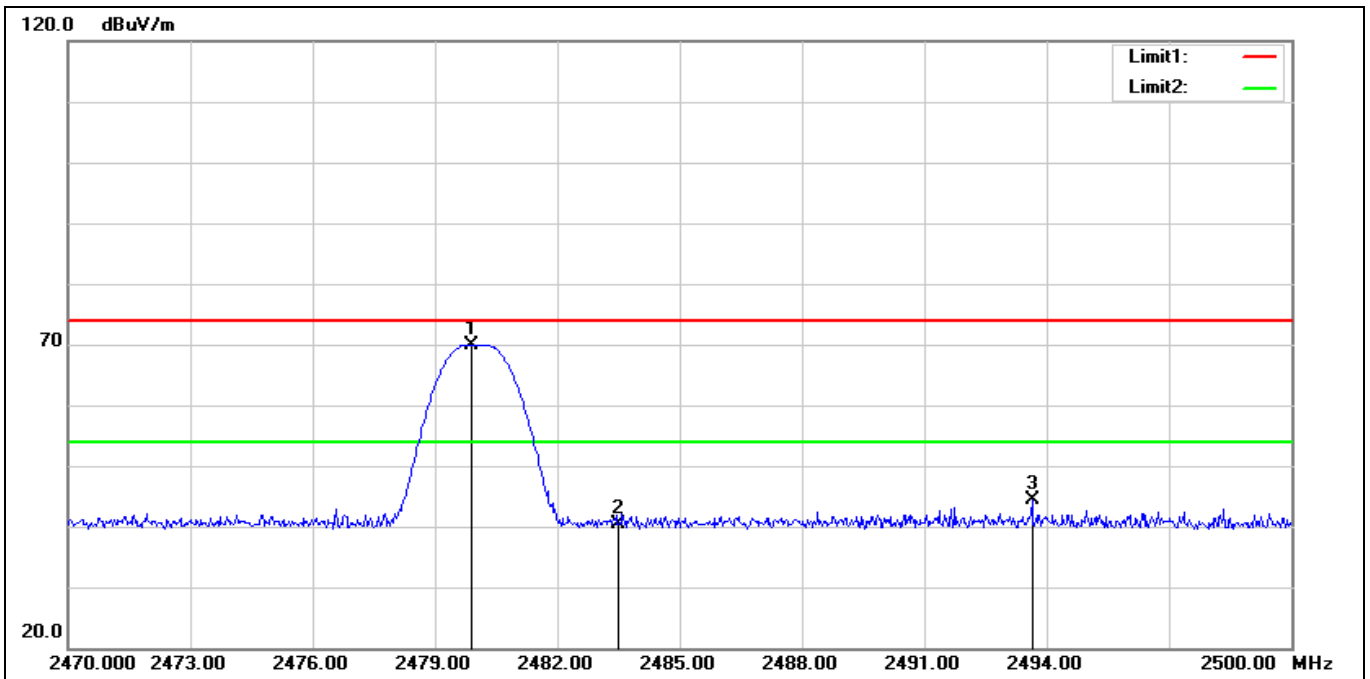

No.	Frequency (MHz)	Reading (dBuV)	Correction (dB/m)	Result (dBuV/m)	Limit (dBuV/m)	Margin (dB)	Remark
1*	2479.900	76.46	-6.46	70.00	74.00	-4.00	peak
2	2483.500	46.87	-6.46	40.41	74.00	-33.59	peak
3	2493.640	50.80	-6.49	44.31	74.00	-29.69	peak

Standard:	Part 15C	Test Site:	966 Chamber
Polarization:	Vertical		
Test Mode:	BLE 2M 2480 MHz		
Remark:			

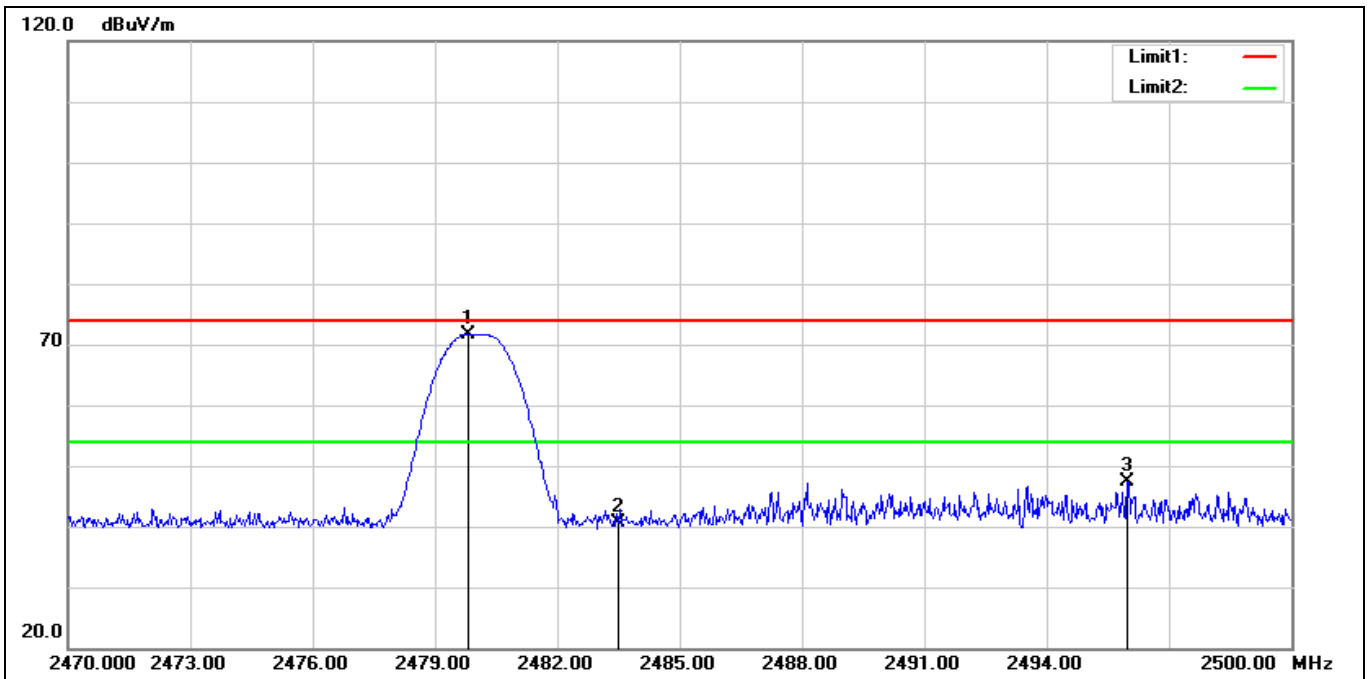

No.	Frequency (MHz)	Reading (dBuV)	Correction (dB/m)	Result (dBuV/m)	Limit (dBuV/m)	Margin (dB)	Remark
1*	2479.810	78.21	-6.46	71.75	74.00	-2.25	peak
2	2483.500	47.05	-6.46	40.59	74.00	-33.41	peak
3	2495.980	53.81	-6.49	47.32	74.00	-26.68	peak

Standard:	Part 15C	Test Site:	966 Chamber
Polarization:	Horizontal		
Test Mode:	BLR C8 2402 MHz		
Remark:			

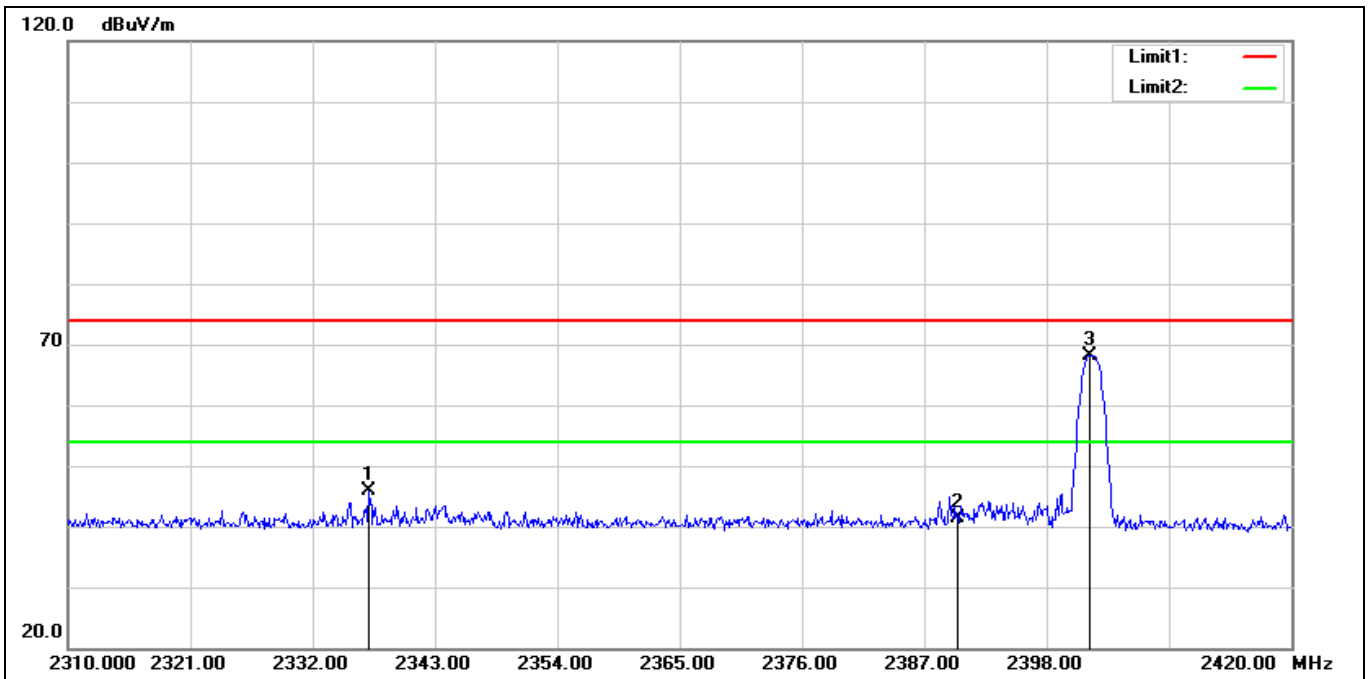

No.	Frequency (MHz)	Reading (dBuV)	Correction (dB/m)	Result (dBuV/m)	Limit (dBuV/m)	Margin (dB)	Remark
1	2337.060	51.94	-6.04	45.90	74.00	-28.10	peak
2	2390.000	47.58	-6.19	41.39	74.00	-32.61	peak
3*	2401.850	74.50	-6.25	68.25	74.00	-5.75	peak

Standard:	Part 15C	Test Site:	966 Chamber
Polarization:	Vertical		
Test Mode:	BLR C8 2402 MHz		
Remark:			

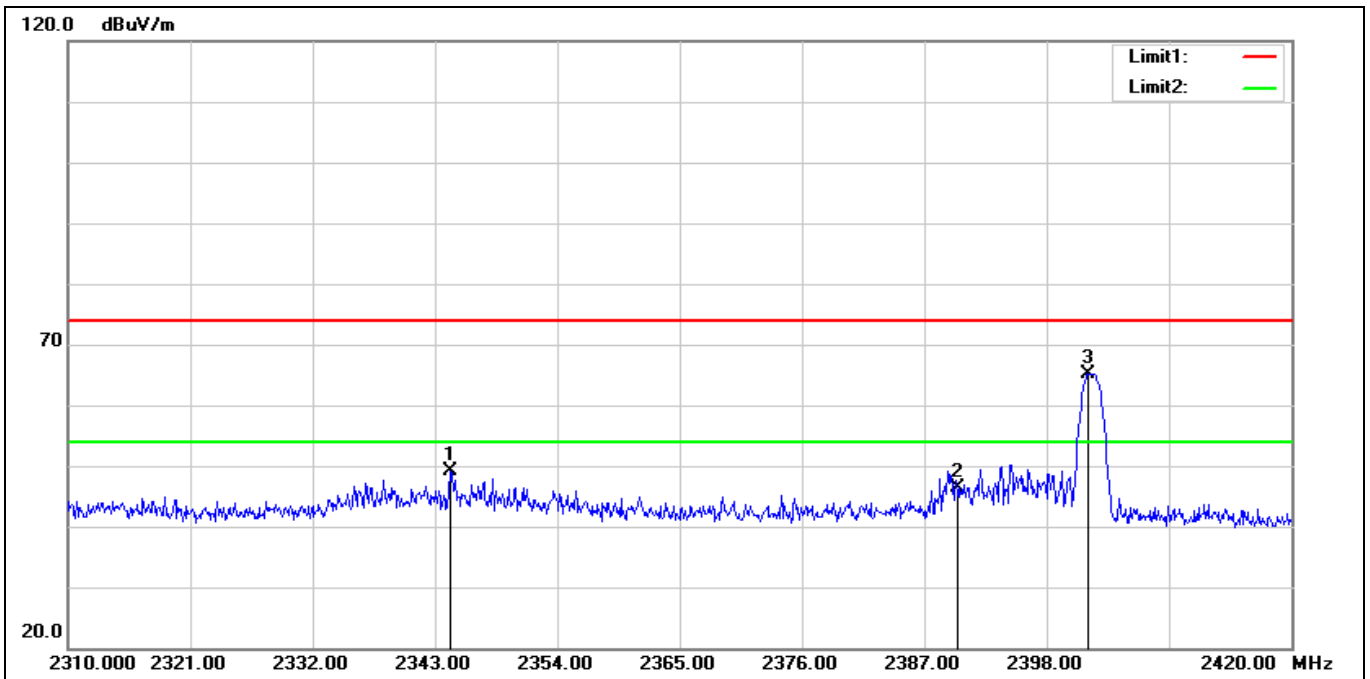

No.	Frequency (MHz)	Reading (dBuV)	Correction (dB/m)	Result (dBuV/m)	Limit (dBuV/m)	Margin (dB)	Remark
1	2344.430	55.12	-6.02	49.10	74.00	-24.90	peak
2	2390.000	52.58	-6.19	46.39	74.00	-27.61	peak
3*	2401.740	71.38	-6.25	65.13	74.00	-8.87	peak

Standard:	Part 15C	Test Site:	966 Chamber
Polarization:	Horizontal		
Test Mode:	BLR C8 2480 MHz		
Remark:			

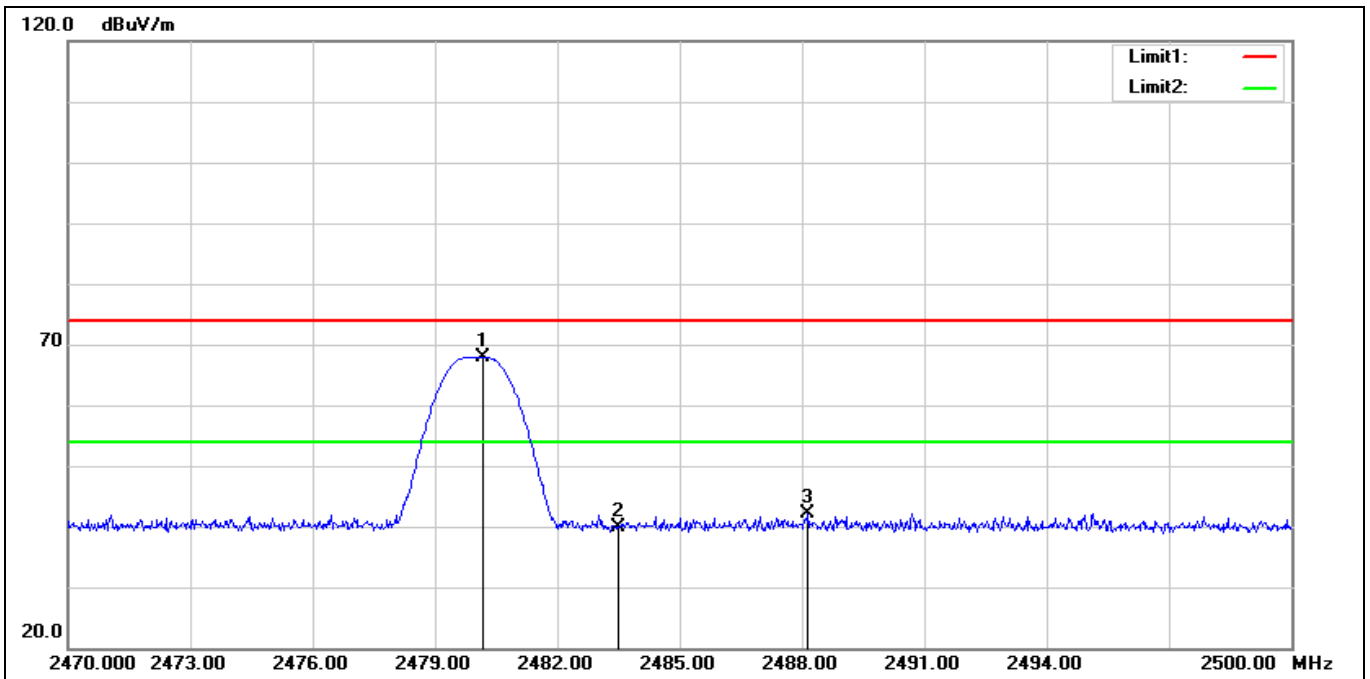

No.	Frequency (MHz)	Reading (dBuV)	Correction (dB/m)	Result (dBuV/m)	Limit (dBuV/m)	Margin (dB)	Remark
1*	2480.170	74.44	-6.46	67.98	74.00	-6.02	peak
2	2483.500	46.32	-6.46	39.86	74.00	-34.14	peak
3	2488.150	48.60	-6.47	42.13	74.00	-31.87	peak

Standard:	Part 15C	Test Site:	966 Chamber
Polarization:	Vertical		
Test Mode:	BLR C8 2480 MHz		
Remark:			

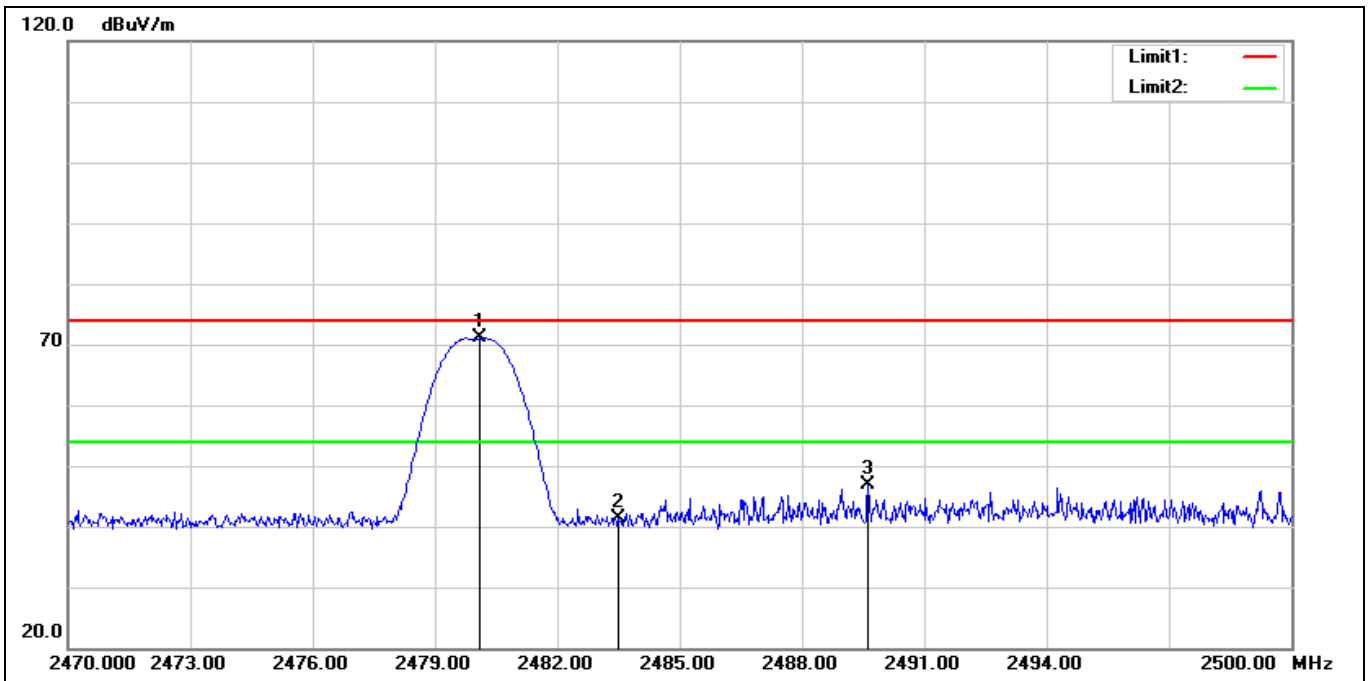

No.	Frequency (MHz)	Reading (dBuV)	Correction (dB/m)	Result (dBuV/m)	Limit (dBuV/m)	Margin (dB)	Remark
1*	2480.110	77.58	-6.46	71.12	74.00	-2.88	peak
2	2483.500	47.95	-6.46	41.49	74.00	-32.51	peak
3	2489.620	53.41	-6.48	46.93	74.00	-27.07	peak

---END---