

Tri band Wi-Fi6E Flexible Printed Antenna (2.4/5/6 GHz)

AFB4714A

Request Samples



Check Inventory



47 x 14 x 0.4 mm
RoHS Compliant
MSL Level = N/A

Features

- Tri-band Wi-Fi6E 2.4/5/6GHz
- Compact design
- High Gain
- High Efficiency
- Easy installation using adhesive tape
- Fully customizable cable and connector options for RF connection

Applications

- IoT
- M2M
- Wearables
- Set Top Boxes
- Transportation
- Home Automation
- Smart Metering/City

Product Image



Tri band Wi-Fi6E Flexible Printed Antenna (2.4/5/6 GHz)

AFB4714A

Request Samples



Check Inventory



47 x 14 x 0.4 mm
RoHS Compliant
 MSL Level = N/A

Part Number Builder

AFB4714A -

Cable length in 'mm'	
Cable length supported : Ø1.13 mm (50 mm to 500 mm)	
Code	Description
0190 (Standard)	190 mm
Other Examples :	
0050	50 mm
0200	200 mm

Cable Type & Connector Type		
Code	Cable Type	Connector Type
S (Standard)	Ø1.13 mm or other	IPEX-1 (F)
A		IPEX-4 (F)

Example Configurations :

Part Number	Cable length	Cable Type / Connector Type
AFB4714A-0190S	190 mm	Ø1.13 mm with IPEX-1 (F) (Standard)
AFB4714A-0050A	50 mm	Ø1.13 mm with IPEX-4 (F)

Note :

- For the standard part number (AFB4714A-0190S), please refer to the packaging at the end of the document.
- For custom configurations (AFB4714A-), MOQs, pricing and packaging changes may be applicable.

Tri band Wi-Fi6E Flexible Printed Antenna (2.4/5/6 GHz)

AFB4714A

Request Samples



Check Inventory



47 x 14 x 0.4 mm
RoHS Compliant
MSL Level = N/A

Electrical Specification

Parameter	Specification			Unit
Operating Frequency	2400 – 2500	5150 - 5850	5925 - 7125	MHz
VSWR	2.0			
Peak gain	2.7	3.1	3.2	dBi
Efficiency	69	51	57	%
Impedance	50			Ω
Polarization	Linear			
Radiation Pattern	Omni-directional			

Mechanical Specification

Parameter	Specification
Antenna Dimensions	47 x 14 x 0.4 mm
Antenna Type	Flexible Printed Circuit
Mounting Type	Adhesive
RF Connector	I-PEX 1 (F)
RF Cable Type	\varnothing 1.13 mm
Cable Length	190 \pm 3 mm

Environmental Specification

Parameter	Specification
Operating Temperature	-40°C to +80°C
Storage Temperature	-40°C to +80°C
ROHS Complaint	Yes
PB Free	Yes



5101 Hidden Creek Ln Spicewood TX 78669
Phone: 512-371-6159 | Fax: 512-351-8858
For terms and conditions of sales, please visit:
www.abracon.com

REVISED: 07-17-22

ABRACON IS
ISO9001-2015
CERTIFIED

Tri band Wi-Fi6E Flexible Printed Antenna (2.4/5/6 GHz)

AFB4714A

Request Samples



Check Inventory



47 x 14 x 0.4 mm
RoHS Compliant
MSL Level = N/A

Product Dimension

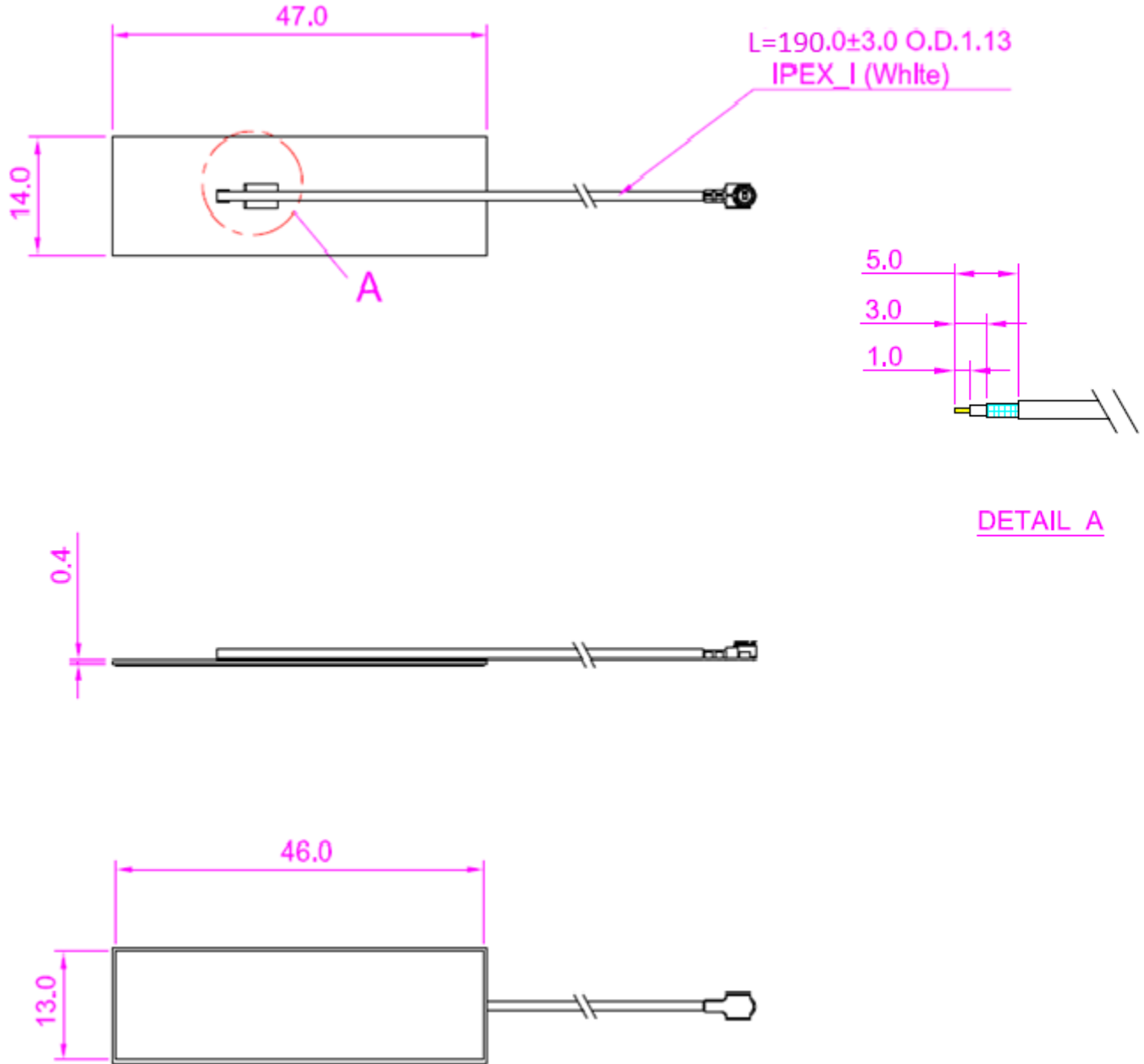

Unit : mm

Tri band Wi-Fi6E Flexible Printed Antenna (2.4/5/6 GHz)

AFB4714A

Request Samples



Check Inventory



47 x 14 x 0.4 mm
RoHS Compliant
MSL Level = N/A

Test Measurement – VSWR (In Free Space)

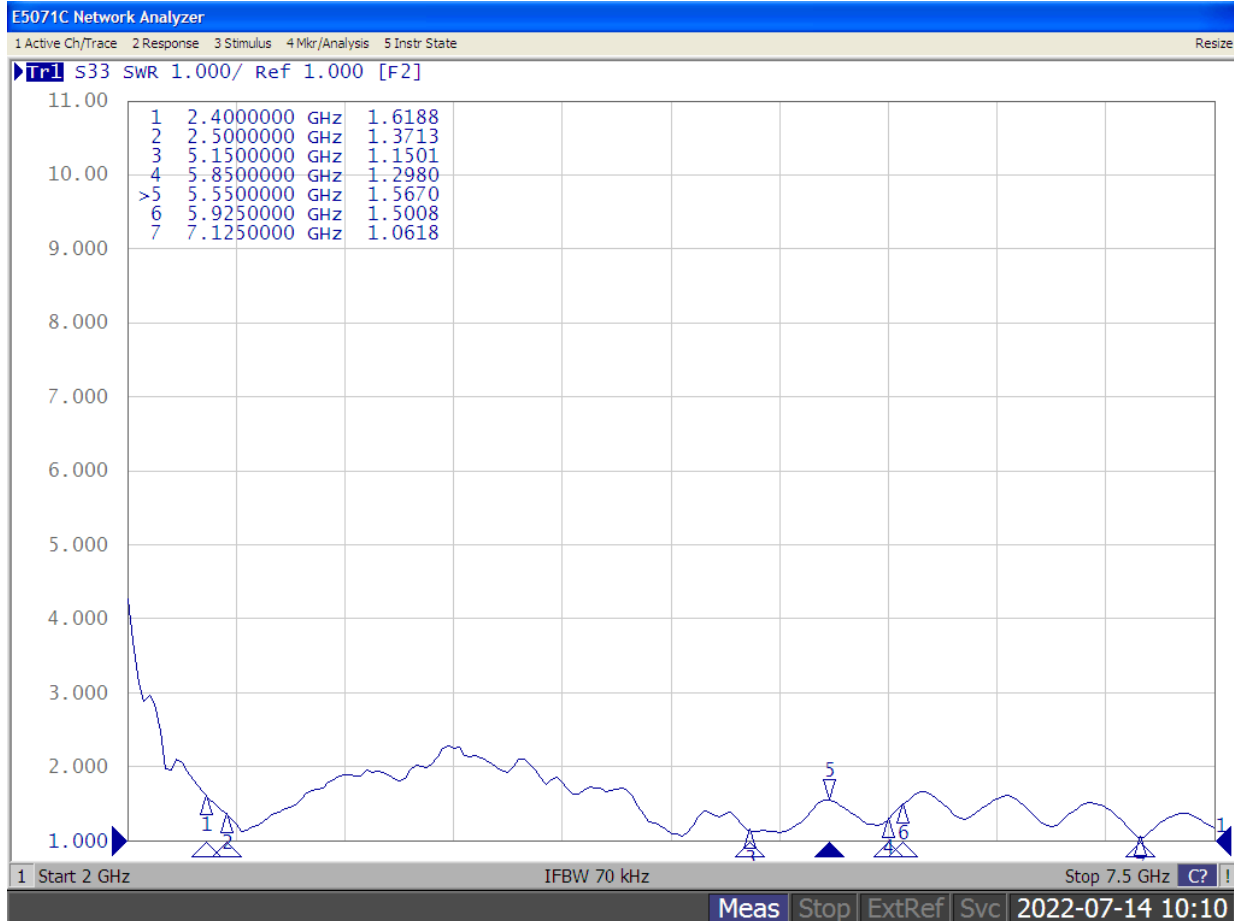

Tri band Wi-Fi6E Flexible Printed Antenna (2.4/5/6 GHz)

AFB4714A

Request Samples



Check Inventory



47 x 14 x 0.4 mm
RoHS Compliant
MSL Level = N/A

Test Measurement – VSWR (On Plastic)

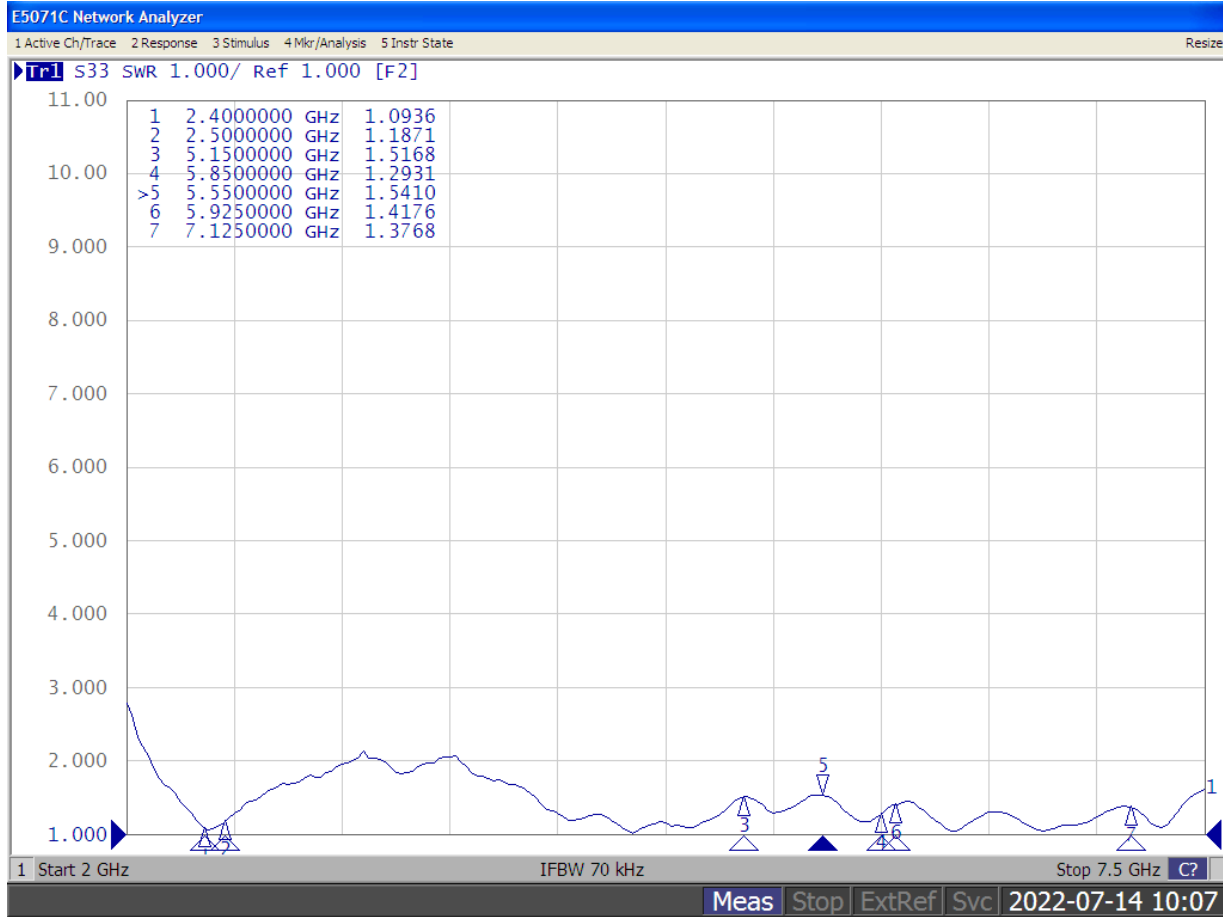

Tri band Wi-Fi6E Flexible Printed Antenna (2.4/5/6 GHz)

AFB4714A

Request Samples



Check Inventory



47 x 14 x 0.4 mm
RoHS Compliant
MSL Level = N/A

Antenna Gain Test – Chamber Setup



Tri band Wi-Fi6E Flexible Printed Antenna (2.4/5/6 GHz)

AFB4714A

Request Samples



Check Inventory



47 x 14 x 0.4 mm
RoHS Compliant
MSL Level = N/A

Radiation Characteristics

3D Pattern

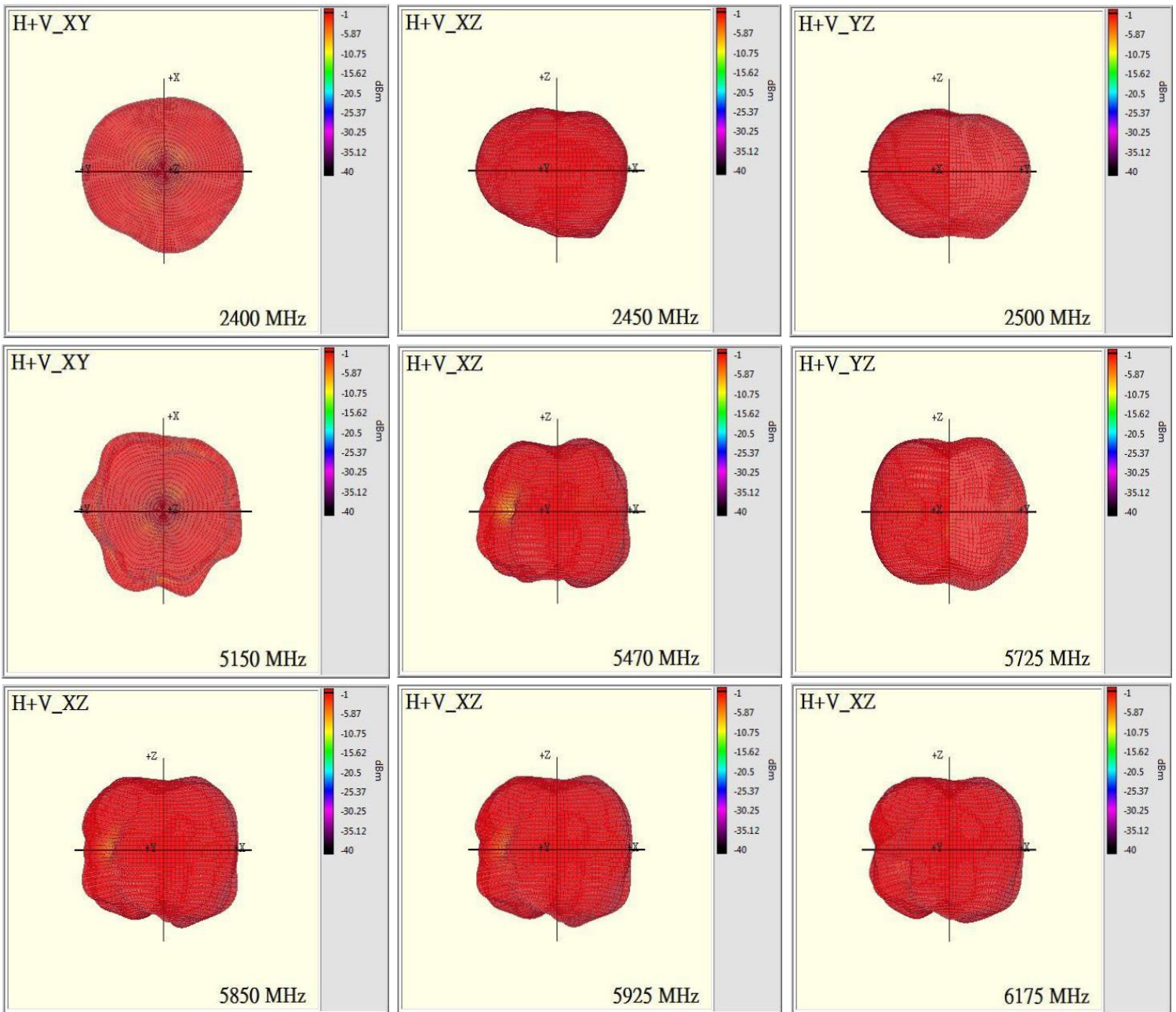

Tri band Wi-Fi6E Flexible Printed Antenna (2.4/5/6 GHz)

AFB4714A

Request Samples



Check Inventory



47 x 14 x 0.4 mm
RoHS Compliant
MSL Level = N/A

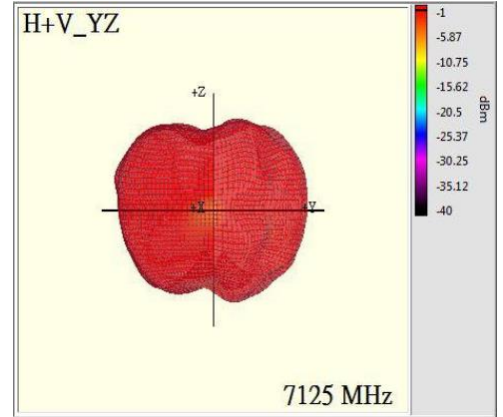
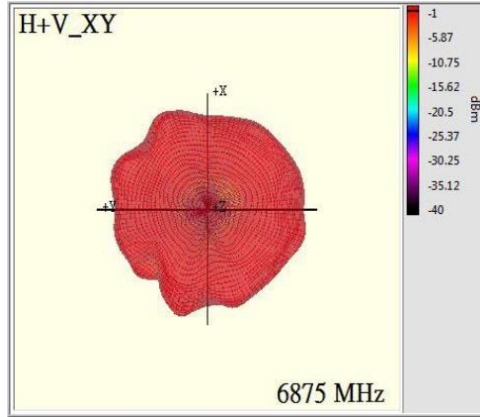
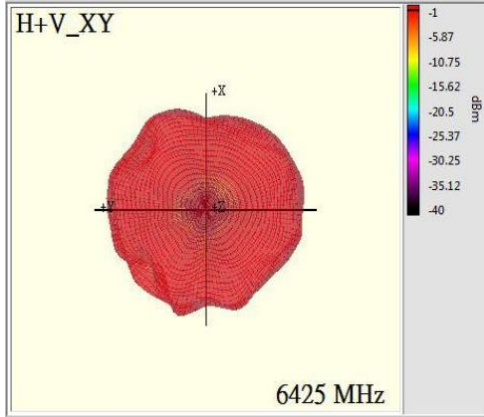

Gain and Efficiency

Frequency (MHz)	Efficiency (dB)	Efficiency (%)	Gain (dBi)
2400	-1.66	68.18	2.28
2450	-1.45	71.50	2.49
2500	-1.28	74.35	2.76
5150	-2.97	50.45	3.16
5250	-2.71	53.56	3.07
5350	-3.06	49.43	2.45
5470	-3.27	47.05	2.11
5600	-3.51	44.52	1.78
5725	-2.96	50.58	2.30
5785	-3.02	49.88	2.10
5800	-3.09	49.08	2.01
5850	-3.07	49.28	1.95
5925	-3.20	47.92	1.83
6175	-1.71	67.36	3.25
6425	-2.09	61.80	2.52
6525	-2.25	59.51	2.70
6700	-2.13	61.20	2.85
6875	-2.50	56.17	2.57
7000	-2.77	52.77	2.62
7125	-2.70	53.80	3.13

Tri band Wi-Fi6E Flexible Printed Antenna (2.4/5/6 GHz)

AFB4714A

Request Samples



Check Inventory



47 x 14 x 0.4 mm
RoHS Compliant
MSL Level = N/A

Packaging Information

Each package: 20 bags

Number of antennas / bag: 100 pcs

Total Pcs / package: 2000 pcs

ATTENTION: Abracon LLC's products are COTS – Commercial-Off-The-Shelf products; suitable for Commercial, Industrial and, where designated, Automotive Applications. Abracon's products are not specifically designed for Military, Aviation, Aerospace, Life-dependent Medical applications or any application requiring high reliability where component failure could result in loss of life and/or property. For applications requiring high reliability and/or presenting an extreme operating environment, written consent and authorization from Abracon LLC is required. Please contact Abracon LLC for more information.



5101 Hidden Creek Ln Spicewood TX 78669
Phone: 512-371-6159 | Fax: 512-351-8858
For terms and conditions of sales, please visit:
www.abracon.com

REVISED: 07-17-22

ABRACON IS
ISO9001-2015
CERTIFIED

Tri band Wi-Fi6E Flexible Printed Antenna (2.4/5/6 GHz)

AFB4714A

INTERNAL ONLY INFORMATION

1.0 Note

- i) The parts are manufactured in accordance with this specification. If other conditions and specifications which are required for this specification, please contact ABRACON for more information.
- ii) ABRACON will supply the parts in accordance with this specification unless we receive a written request to modify prior to an order placement.
- iii) In no case shall ABRACON be liable for any product failure from in appropriate handling or operation of the item beyond the scope of this specification.
- iv) When changing your production process, please notify ABRACON immediately.
- v) ABRACON's products are COTS – Commercial-Off-The-Shelf products; suitable for Commercial, Industrial and, where designated, Automotive Applications. ABRACON's products are not specifically designed for Military, Aviation, Aerospace, Life-dependent Medical applications or any application requiring high reliability where component failure could result in loss of life and/or property. For applications requiring high reliability and/or presenting an extreme operating environment, written consent and authorization from ABRACON LLC. is required. Please contact ABRACON LLC for more information.
- vi) All specifications and Marking will be subject to change without notice.

2.0 ABRACON LLC - TERMS & CONDITION OF SALE

The following are the terms and conditions under which Abracon LLC ("AB") agrees to sell, to the entity named on the face hereof ("Buyer"), the products specified on the face hereof (the "Products"). Notwithstanding Buyer's desire to use standardized RFQs, purchase order forms, order forms, acknowledgment forms and other documents which may contain terms in addition to or at variance with these terms, it is expressly understood and agreed that other forms shall neither add to, nor vary, these terms whether or not these terms are referenced therein. Buyer may assent to these terms by written acknowledgment, implication and/or by acceptance or payment of goods ordered any of which will constitute assent.

1. **Prices:** Prices shown on the face hereof are in US dollars, with delivery terms specified herein and are exclusive of any other charges including, without limitation, fees for export, special packaging, freight, insurance and similar charges. AB reserves the right to increase the price of Products by written notice to Buyer at least thirty (30) days prior to the original date of shipment. When quantity price discounts are quoted by AB, the discounts are computed separately for each type of product to be sold and are based upon the quantity of each type and each size ordered at any one time. If any discounted order is reduced by Buyer with AB's consent, the prices shall be adjusted to the higher prices, if applicable, for the remaining order.
2. **Taxes:** Unless otherwise specified in the quotation, the prices do not include any taxes, import or export duties, tariffs, customs charges or any such other levies. Buyer agrees to reimburse AB the amount of any federal, state, county, municipal, or other taxes, duties, tariffs, or custom charges AB is required to pay. If Buyer is exempt from any such charges, Buyer must provide AB with appropriate documentation.
3. **Payment Terms:** For each shipment, AB will invoice Buyer for the price of the Products plus all applicable taxes, packaging, transportation, insurance and other charges. Unless otherwise stated in a separate agreement or in AB's quotation, payments are due within thirty (30) days from the date of invoice, subject to AB's approval of Buyer's credit application. All invoicing disputes must be submitted in writing to AB within ten (10) days of the receipt of the invoice accompanied by a reasonably detailed explanation of the dispute. Payment of the undisputed amounts shall be made timely. AB reserves the right to require



5101 Hidden Creek Ln Spicewood TX 78669
Phone: 512-371-6159 | Fax: 512-351-8858
For terms and conditions of sales, please visit:
www.abracon.com

REVISED: 07-17-22

ABRACON IS
ISO9001-2015
CERTIFIED

Tri band Wi-Fi6E Flexible Printed Antenna (2.4/5/6 GHz)

AFB4714A

payment in advance or C.O.D. and otherwise modified credit terms. When partial shipments are made, payments for such shipments shall become due in accordance with the above terms upon submission of invoices. If, at the request of Buyer, shipment is postponed for more than thirty (30) days, payment will become due thirty days after notice to Buyer that Products are ready for shipment. Any unpaid due amounts will be subject to interest at one decimal five percent (1.5%) per month, or, if less, the maximum rate allowed by law.

4. **Delivery and Shipment:** Shipment dates are estimates only. Failure to deliver by a specified date shall neither entitle Buyer to any compensation nor impose any liability on AB. AB reserves the right to ship and bill ten percent more or less than the exact quantity specified on the face hereof. All shipments will be made Ex Works as per Incoterms 2000 from AB's place of shipment. In the absence of specific instructions, AB will select the carrier. Claims against AB for shortages must be made in writing within ten (10) days after the arrival of the shipment. AB is not required to notify Buyer of the shipment. Buyer shall pay all freight charges, insurance and other shipping expenses. Freight charges, insurance and other shipping expenses itemized in advance of actual shipment, if any, are estimates only that are calculated on the basis of standard tariffs and may not reflect actual costs. Buyer must pay actual costs.
5. **Purchase Order Changes and Cancellations:** Purchase orders for standard AB Products may not be canceled within sixty (60) days of the original shipping date. Purchase orders for non-standard AB Products are non-cancelable and non-returnable. All schedule changes must be requested at least thirty (30) days prior to original shipping date. Maximum schedule change "push-out" shall be no more than thirty (30) days from original shipping date. AB may terminate or cancel this order, in whole or in part, at any time prior to the completion of performance by written notice to Buyer without incurring any liability to Buyer for breach of contract or otherwise. AB reserves the right to allocate Products in its sole discretion among Buyer and other potential buyers, or defer or delay the shipment of any Product, which is in short supply due to any reason.
6. **Title and Risk of Loss:** AB's responsibility for any loss or damage ends, and title passes, when Products are delivered Ex Works as per Incoterms 2000 at AB's designated shipping location to carrier, to Buyer or to Buyer's agent, whichever occurs first.
7. **Packing:** Packaging shall be AB's standard shipping materials or as specified on the face hereof. Any cost of non-standard packaging and handling requested by Buyer shall be abided by AB provided Buyer gives reasonable prior notice and agrees in writing to pay additional costs.
8. **Security Interest:** Buyer hereby grants AB a purchase money security interest in the Products sold and in the proceeds of resale of such Products until such time as Buyer has paid all charges. AB retains all right and remedies available to AB under the Uniform Commercial Code.
9. **Specifications:** Specifications for each Product are the specifications specified in the published datasheets of such Product, as of the date of AB's quotation (the "Specifications"). Except as otherwise agreed, AB reserves the right to modify the Specifications at any time without adversely affecting the functionality.
10. **Acceptance:** Unless Buyer notifies AB in writing within ten (10) days from the date of receipt of Products that the Products fail to conform to the Specifications, the Products will be deemed accepted by Buyer. No such claim of non-conformity shall be valid if (i) the Products have been altered, modified or damaged by Buyer, (ii) the rejection notice fails to explain the non-conformance in reasonable detail and is not accompanied by a test report evidencing the non-conformity, or (iii) rejected Products are not returned to AB within thirty (30) days of rejection; provided, that no Product returns may be made without a return material authorization issued by AB.
11. **Limited Warranties and Disclaimers:** AB warrants to Buyer that each Product, for a period of twelve (12) months from shipment date thereof, will conform to the Specifications and be free from defects in materials and workmanship. AB's sole liability and Buyer's exclusive remedy for Products that fail to conform to this limited warranty ("Defective Products") is limited to repair or replacement of such Defective Products, or issue a credit or rebate of no more than the purchase price of such Defective Products, at AB's sole option and election. This warranty shall not apply: (i) if Products have been damaged or submitted to abnormal conditions (mechanical, electrical, or thermal) during transit, storage, installation, or use; or (ii) if Products are subject to Improper Use (as defined below); or (iii) if the non-conformance of Products results from misuse,



5101 Hidden Creek Ln Spicewood TX 78669
Phone: 512-371-6159 | Fax: 512-351-8858
For terms and conditions of sales, please visit:
www.abracon.com

REVISED: 07-17-22

ABRACON IS
ISO9001-2015
CERTIFIED

Tri band Wi-Fi6E Flexible Printed Antenna (2.4/5/6 GHz)

AFB4714A

neglect, improper testing, storage, installation, unauthorized repair, alteration, or excess usage at or beyond the maximum values (temperature limit, maximum voltage, and other Specification limits) defined by AB; (iv) to any other default not attributable to AB; or (v) removal, alteration, or tampering of the original AB product labeling. This warranty does not extend to Products or components purchased from entities other than AB or AB's authorized distributors or to third-party software or documentation that may be supplied with any Product. In the event no defect or breach of warranty is discovered by AB upon receipt of any returned Product, such Product will be returned to Buyer at Buyer's expense and Buyer will reimburse AB for the transportation charges, labor, and associated charges incurred in testing the allegedly Defective Product. The above warranty is for Buyer's benefit only, and is non-transferable. OTHER THAN THE LIMITED WARRANTY SET FORTH ABOVE, AB MAKES NO WARRANTIES, EXPRESS, STATUTORY, IMPLIED, OR OTHERWISE AND SPECIFICALLY DISCLAIMS THE IMPLIED WARRANTIES OF MERCHANTABILITY, FITNESS FOR A PARTICULAR PURPOSE AND NON-INFRINGEMENT, TO THE MAXIMUM EXTENT PERMITTED BY LAW. WITHOUT LIMITING THE GENERALITY OF THE FOREGOING DISCLAIMERS, AB INCORPORATES BY REFERENCE ANY PRODUCT-SPECIFIC WARRANTY DISCLAIMERS SET FORTH IN THE PUBLISHED PRODUCT DATASHEETS.

12. **Limitation of Liability:** AB SHALL HAVE NO LIABILITY FOR LOSS ARISING FROM ANY CLAIM MADE AGAINST BUYER, OR FOR SPECIAL, INDIRECT, RELIANCE, INCIDENTAL, CONSEQUENTIAL, OR PUNITIVE DAMAGES INCLUDING, WITHOUT LIMITATION, LOSS OF USE, PROFITS, REVENUES, OR COST OF PROCUREMENT OF SUBSTITUTE GOODS BASED ON ANY BREACH OR DEFAULT OF AB, HOWEVER CAUSED, AND UNDER ANY THEORY OF LIABILITY. BUYER'S SOLE REMEDY AND AB'S SOLE AND TOTAL LIABILITY FOR ANY CAUSE OF ACTION, WHETHER IN CONTRACT (INCLUDING BREACH OF WARRANTY) OR TORT (INCLUDING NEGLIGENCE OR MISREPRESENTATION) OR UNDER STATUTE OR OTHERWISE SHALL BE LIMITED TO AND SHALL NOT EXCEED THE AGGREGATE AMOUNTS PAID BY BUYER TO AB FOR PRODUCTS WHICH GIVE RISE TO CLAIMS. BUYER SHALL ALWAYS INFORM AB OF ANY BREACH AND AFFORD AB REASONABLE OPPORTUNITY TO CORRECT ANY BREACH. THE FOREGOING LIMITATIONS SHALL APPLY REGARDLESS OF WHETHER AB HAS BEEN ADVISED OF THE POSSIBILITY OF SUCH DAMAGES AND NOTWITHSTANDING THE FAILURE OF ESSENTIAL PURPOSE OF ANY LIMITED REMEDY.
13. **Improper Use:** Buyer agrees and covenants that, without AB's prior written approval, Products will not be used in life support systems, human implantation, nuclear facilities or systems or any other application where Product failure could lead to loss of life or catastrophic property damage (each such use being an "Improper Use"). Buyer will indemnify and hold AB harmless from any loss, cost, or damage resulting from Improper Use of the Products.
14. **Miscellaneous:** In the event of any insolvency or inability to pay debts as they become due by Buyer, or voluntary or involuntary bankruptcy proceeding by or against Buyer, or appointment of a receiver or assignee for the benefit of creditors of Buyer, AB may elect to cancel any unfulfilled obligations. No Products or underlying information or technology may be exported or re-exported, directly or indirectly, contrary to US law or US Government export controls. AB will be excused from any obligation to the extent performance thereof is caused by, or arises in connection with, acts of God, fire, flood, riots, material shortages, strikes, governmental acts, disasters, earthquakes, inability to obtain labor or materials through its regular sources, delay in delivery by AB's supplies or any other reason beyond the reasonable control of AB. In the event any one or more of the provisions contained herein shall for any reason be held to be invalid, illegal, or unenforceable in any respect, such invalidity, illegality, or unenforceability shall not affect any other provision hereof and these terms shall be construed as if such invalid, illegal, or unenforceable provision had never been contained herein. A waiver of a breach or default under these terms shall not be a waiver of any subsequent default. Failure of AB to enforce compliance with any of these terms shall not constitute a waiver of such terms. These terms are governed by the laws of the State of California without reference to conflict of law principles. The federal and state courts located within the State of California will have exclusive jurisdiction to adjudicate any dispute arising out of these terms.