

FCC Radio Test Report

FCC ID: 2AATB-SMC-1030



Report No. : BTL-FCCP-4-1803T076A
Equipment : Music Streamer
Model Name : SMC-1030
Brand Name : TTI
Applicant : Tatung Technology Inc.
Address : 10F, No.288, Sec 6, Civic Blvd, Xinyi Dist, Taipei City 11087, Taiwan

Radio Function : RLAN 5 GHz (U-NII 1, U-NII 3)

FCC Rule Part(s) : FCC Part15, Subpart E (15.407)
Measurement Procedure(s) : ANSI C63.4-2014

Date of Receipt : 2018/4/25
Date of Test : 2018/4/25 ~ 2019/9/20
Issued Date : 2019/11/7

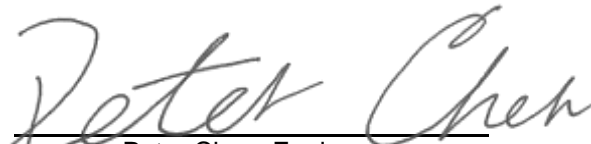
The above equipment has been tested and found in compliance with the requirement of the above standards by BTL Inc.

Prepared by :
Peter Chen, Engineer**Approved by** :
Scott Hsu, Vice Manager**BTL Inc.**

No.18, Ln. 171, Sec. 2, Jiuzong Rd., Neihu Dist., Taipei City 114, Taiwan

Tel: +886-2-2657-3299

Fax: +886-2-2657-3331

Web: www.newbtl.com

Declaration

BTL represents to the client that testing is done in accordance with standard procedures as applicable and that test instruments used has been calibrated with standards traceable to international standard(s) and/or national standard(s).

BTL's reports apply only to the specific samples tested under conditions. It is manufacture's responsibility to ensure that additional production units of this model are manufactured with the identical electrical and mechanical components. **BTL** shall have no liability for any declarations, inferences or generalizations drawn by the client or others from **BTL** issued reports.

The report must not be used by the client to claim product certification, approval, or endorsement by NIST, A2LA, or any agency of the U.S. Government.

This report is the confidential property of the client. As a mutual protection to the clients, the public and ourselves, the test report shall not be reproduced, except in full, without our written approval.

BTL's laboratory quality assurance procedures are in compliance with the **ISO/IEC 17025** requirements, and accredited by the conformity assessment authorities listed in this test report.

BTL is not responsible for the sampling stage, so the results only apply to the sample as received.

The information, data and test plan are provided by manufacturer which may affect the validity of results, so it is manufacturer's responsibility to ensure that the apparatus meets the essential requirements of applied standards and in all the possible configurations as representative of its intended use.

Limitation

For the use of the authority's logo is limited unless the Test Standard(s)/Scope(s)/Item(s) mentioned in this test report is (are) included in the conformity assessment authorities acceptance respective.

Please note that the measurement uncertainty is provided for informational purpose only and are not use in determining the Pass/Fail results.

CONTENTS

REPORT ISSUED HISTORY	5
1 SUMMARY OF TEST RESULTS	6
1.1 TEST FACILITY	7
1.2 MEASUREMENT UNCERTAINTY	7
1.3 TEST ENVIRONMENT CONDITIONS	8
1.4 TABLE OF PARAMETERS OF TEXT SOFTWARE SETTING	8
1.5 DUTY CYCLE	9
2 GENERAL INFORMATION	10
2.1 DESCRIPTION OF EUT	10
2.2 TEST MODES	12
2.3 BLOCK DIAGRAM SHOWING THE CONFIGURATION OF SYSTEM TESTED	13
2.4 SUPPORT UNITS	13
3 AC POWER LINE CONDUCTED EMISSIONS TEST	14
3.1 LIMIT	14
3.2 TEST PROCEDURE	14
3.3 DEVIATION FROM TEST STANDARD	14
3.4 TEST SETUP	15
3.5 TEST RESULT	15
4 RADIATED EMISSIONS TEST	16
4.1 LIMIT	16
4.2 TEST PROCEDURE	17
4.3 DEVIATION FROM TEST STANDARD	17
4.4 TEST SETUP	18
4.5 EUT OPERATING CONDITIONS	19
4.6 TEST RESULT – 30 MHZ TO 1 GHZ	19
4.7 TEST RESULT – ABOVE 1 GHZ	19
5 BANDWIDTH TEST	20
5.1 LIMIT	20
5.2 TEST PROCEDURE	20
5.3 DEVIATION FROM TEST STANDARD	20
5.4 TEST SETUP	20
5.5 EUT OPERATING CONDITIONS	20
5.6 TEST RESULT	20
6 OUTPUT POWER TEST	21
6.1 LIMIT	21
6.2 TEST PROCEDURE	21
6.3 DEVIATION FROM TEST STANDARD	21
6.4 TEST SETUP	21
6.5 EUT OPERATING CONDITIONS	21
6.6 TEST RESULT	21
7 POWER SPECTRAL DENSITY	22
7.1 LIMIT	22
7.2 TEST PROCEDURE	22
7.3 DEVIATION FROM TEST STANDARD	22
7.4 TEST SETUP	22
7.5 EUT OPERATING CONDITIONS	22
7.6 TEST RESULT	22

8	FREQUENCY STABILITY TEST	23
8.1	LIMIT	23
8.2	TEST PROCEDURE	23
8.3	DEVIATION FROM TEST STANDARD	23
8.4	TEST SETUP	23
8.5	EUT OPERATING CONDITIONS	23
8.6	TEST RESULT	23
9	LIST OF MEASURING EQUIPMENTS	24
10	EUT TEST PHOTO	26
11	EUT PHOTOS	26
APPENDIX A	AC POWER LINE CONDUCTED EMISSIONS	27
APPENDIX B	RADIATED EMISSIONS - 30 MHZ TO 1 GHZ	30
APPENDIX C	RADIATED EMISSIONS - ABOVE 1 GHZ	33
APPENDIX D	BANDWIDTH	106
APPENDIX E	CONDUCTED OUTPUT POWER	111
APPENDIX F	POWER SPECTRAL DENSITY	124
APPENDIX G	FREQUENCY STABILITY	137

REPORT ISSUED HISTORY

Report Version	Description	Issued Date
R00	Original Issue.	2019/11/7

1 SUMMARY OF TEST RESULTS

Test procedures according to the technical standards.

FCC Part 15, Subpart E (15.407)				
Standard(s) Section	Description	Test Result	Judgement	Remark
15.207	AC Power Line Conducted Emissions	APPENDIX A	Pass	-----
15.205 15.209 15.407(b)	Radiated Emissions	APPENDIX B APPENDIX C	Pass	-----
15.407(a)	Bandwidth	APPENDIX D	Pass	-----
15.407(a)	Output Power	APPENDIX E	Pass	-----
15.407(a)	Power Spectral Density	APPENDIX F	Pass	-----
15.407(g)	Frequency Stability	APPENDIX G	Pass	-----
15.203	Antenna Requirement	-----	Pass	-----
15.407(c)	Automatically Discontinue Transmission	-----	Pass	NOTE (2)

NOTE:

- (1) "N/A" denotes test is not applicable in this Test Report.
- (2) The EUT can detect the controlling signal of ACK message transmitting from remote device and verify whether it shall resend or discontinue transmission.

1.1 TEST FACILITY

The test facilities used to collect the test data in this report:

No. 68-1, Ln. 169, Sec. 2, Datong Rd., Xizhi Dist., New Taipei City 221, Taiwan

The test sites and facilities are covered under FCC RN: 355421 and DN: TW1099.

- C05 CB08 CB11 CB15 CB16
 SR06

1.2 MEASUREMENT UNCERTAINTY

The reported uncertainty of measurement $y \pm U$, where expanded uncertainty U is based on a standard uncertainty multiplied by a coverage factor of $k = 2$, providing a level of confidence of approximately **95 %**. The measurement instrumentation uncertainty considerations contained in CISPR 16-4-2. The BTL measurement uncertainty is less than the CISPR 16-4-2 U_{cispr} requirement.

A. AC power line conducted emissions test:

Test Site	Method	Measurement Frequency Range	U (dB)
C05	CISPR	150 kHz ~ 30MHz	3.44

B. Radiated emissions below 1 GHz test :

Test Site	Method	Measurement Frequency Range	Ant. H / V	U,(dB)
CB15 (3m)	CISPR	30MHz ~ 200MHz	V	4.20
		30MHz ~ 200MHz	H	3.64
		200MHz ~ 1,000MHz	V	4.56
		200MHz ~ 1,000MHz	H	3.90

C. Radiated emissions above 1 GHz test :

Test Site	Method	Measurement Frequency Range	Ant. H / V	U,(dB)
CB15 (3m)	CISPR	1GHz ~ 6GHz	V	4.46
		1GHz ~ 6GHz	H	4.40
		6GHz ~ 18GHz	V	3.88
		6GHz ~ 18GHz	H	4.00

Test Site	Method	Measurement Frequency Range	U,(dB)
CB15 (1m)	CISPR	18 ~ 26.5 GHz	4.62
		26.5 ~ 40 GHz	5.12

D. Conducted test :

Test Item	U,(dB)
Bandwidth	1.13
Output power	1.07
Power Spectral Density	1.20
Conducted Band edges	1.13
Frequency Stability	1.13

NOTE:

Unless specifically mentioned, the uncertainty of measurement has not been taken into account to declare the compliance or non-compliance to the specification.

1.3 TEST ENVIRONMENT CONDITIONS

Test Item	Environment Condition	Tested by
AC Power Line Conducted Emissions	25 °C, 45 %	Toby Tian
Radiated emissions below 1 GHz	22 °C, 60 %	Leo Liu
Radiated emissions above 1 GHz	22 °C, 60 %	Toby Tian
Bandwidth	23.9 °C, 52 %	Tim Lee
Output Power	23.9 °C, 52 %	Tim Lee
Power Spectral Density	23.9 °C, 52 %	Tim Lee
Frequency Stability	23.9 °C, 52 %	Tim Lee

1.4 TABLE OF PARAMETERS OF TEXT SOFTWARE SETTING

UNII-1			
Test Software	Mtool		
Mode	5180 MHz	5200 MHz	5240 MHz
IEEE 802.11a	64	64	64
IEEE 802.11n (HT20)	64	64	64
IEEE 802.11ac (VHT20)	64	64	64
Mode	5190 MHz	5230 MHz	
IEEE 802.11n (HT40)	48	64	
IEEE 802.11ac (VHT40)	48	64	
Mode	5210 MHz		
IEEE 802.11ac (VHT80)	50		

UNII-3			
Test Software	Mtool		
Mode	5745 MHz	5785 MHz	5825 MHz
IEEE 802.11a	58	58	58
IEEE 802.11n (HT20)	64	60	60
IEEE 802.11ac (VHT20)	64	60	60
Mode	5755 MHz	5795 MHz	
IEEE 802.11n (HT40)	56	56	
IEEE 802.11ac (VHT40)	56	56	
Mode	5775 MHz		
IEEE 802.11ac (VHT80)	64		

1.5 DUTY CYCLE

If duty cycle is $\geq 98\%$, duty factor is not required.

If duty cycle is $< 98\%$, duty factor shall be considered.

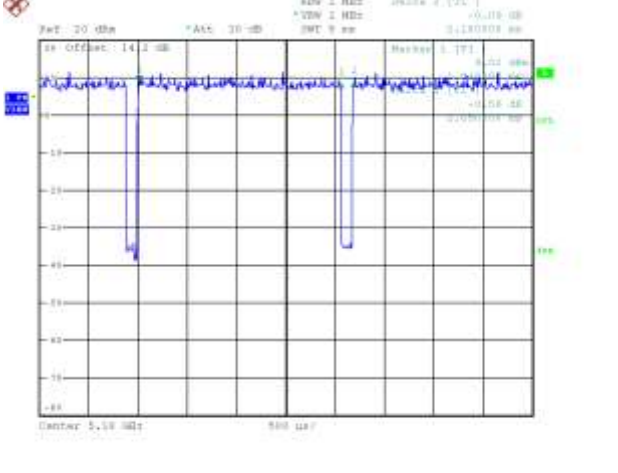
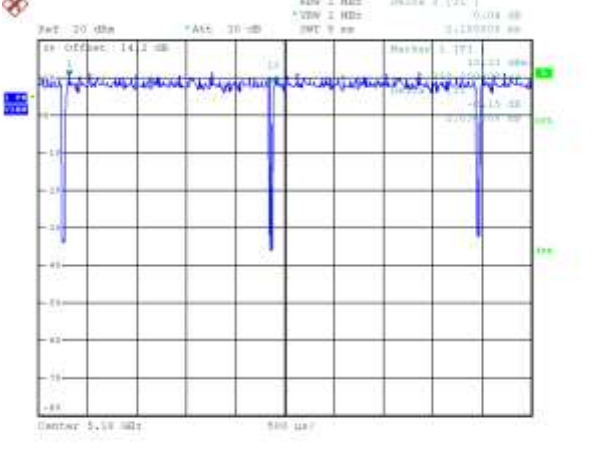
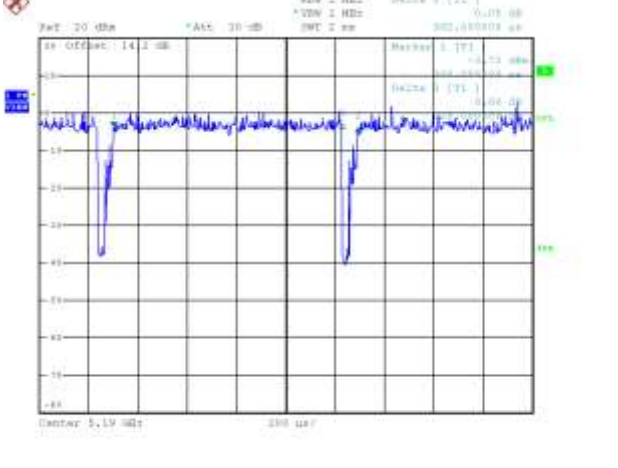
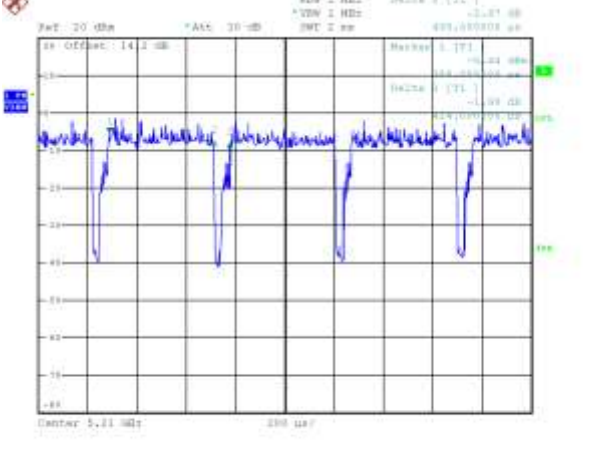
IEEE 802.11a	IEEE 802.11n (HT20)
 <p>Date: 15.MAY.2016 17:40:23</p>	 <p>Date: 15.MAY.2016 17:45:23</p>
<p>Duty cycle = 2.05 ms / 2.18 ms = 94.04 % Duty Factor = $10 * \log(1 / 0.9404) = 0.27$ dB</p>	<p>Duty cycle = 2.03 ms / 2.10 ms = 96.67 % Duty Factor = $10 * \log(1 / 0.9667) = 0.15$ dB</p>
IEEE 802.11n (HT40)	IEEE 802.11ac (VHT80)
 <p>Date: 15.MAY.2016 17:50:14</p>	 <p>Date: 15.MAY.2016 17:55:05</p>
<p>Duty cycle = 0.928 ms / 0.992 ms = 93.55 % Duty Factor = $10 * \log(1 / 0.9355) = 0.29$ dB</p>	<p>Duty cycle = 0.424 ms / 0.488ms = 86.89 % Duty Factor = $10 * \log(1 / 0.8689) = 0.61$ dB</p>

2 GENERAL INFORMATION

2.1 DESCRIPTION OF EUT

Equipment	Music Streamer
Model Name	SMC-1030
Brand Name	TTI
Model Difference	N/A
Power Source	DC voltage supplied from External Power Supply.
Power Rating	I/P: 100-240V~ 50-60 Hz 0.5A Max. O/P: 12.0V---1.0A
Products Covered	1 * Adapter: APD / WA-12M12FU 1 * remote control
Frequency Range	UNII-1: 5150 MHz to 5250 MHz UNII-3: 5725 MHz to 5850 MHz
Operation Frequency	UNII-1: 5180 MHz to 5240 MHz UNII-3: 5745 MHz to 5825 MHz
Modulation Technology	OFDM
Transfer Rate	up to 866 Mbps
Output Power Max. for UNII-1	IEEE 802.11a: 20.06 dBm (0.1013 W) IEEE 802.11n (HT20): 19.88 dBm (0.0973 W) IEEE 802.11n (HT40): 20.29 dBm (0.1069 W) IEEE 802.11ac (VHT20): 19.97 dBm (0.0992 W) IEEE 802.11ac (VHT40): 20.60 dBm (0.1149 W) IEEE 802.11ac (VHT80): 16.69 dBm (0.0467 W)
Output Power Max. for UNII-3	IEEE 802.11a: 17.90 dBm (0.616 W) IEEE 802.11n (HT20): 19.08 dBm (0.0810 W) IEEE 802.11n (HT40): 17.74 dBm (0.0594 W) IEEE 802.11ac (VHT20): 19.24 dBm (0.0839 W) IEEE 802.11ac (VHT40): 17.32 dBm (0.0539 W) IEEE 802.11ac (VHT80): 17.05 dBm (0.0507 W)
Test Model	SMC-1030
Sample Status	Engineering Sample
EUT Modification(s)	N/A

NOTE:

- (1) For a more detailed features description, please refer to the manufacturer's specifications or the user's manual.

(2) Channel List:

UNII-1					
IEEE 802.11a IEEE 802.11n (HT20) IEEE 802.11ac (VHT20)		IEEE 802.11n (HT40) IEEE 802.11ac (VHT40)		IEEE 802.11ac (VHT80)	
Channel	Frequency (MHz)	Channel	Frequency (MHz)	Channel	Frequency (MHz)
36	5180	38	5190	42	5210
40	5200	46	5230		
44	5220				
48	5240				

UNII-3					
IEEE 802.11a IEEE 802.11n (HT20) IEEE 802.11ac (VHT20)		IEEE 802.11n (HT40) IEEE 802.11ac (VHT40)		IEEE 802.11ac (VHT80)	
Channel	Frequency (MHz)	Channel	Frequency (MHz)	Channel	Frequency (MHz)
149	5745	151	5755	155	5775
153	5765	159	5795		
157	5785				
161	5805				
165	5825				

(3) Table for Filed Antenna:

Ant.	Brand	Model Name	Antenna Type	Connector	Gain (dBi)	Note
1	Ethertronics	TTI_SMC-1030	PCB	I-PEX	6.0	UNII-1
					5.2	UNII-3
2	Ethertronics	TTI_SMC-1030	PCB	I-PEX	4.3	UNII-1
					3.7	UNII-3

NOTE:

- (a) The EUT incorporates a MIMO function. Physically, the EUT provides two completed transmitters and receivers (2T2R). 2.4 GHz and 5GHz can't transmit simultaneously.
- (b) For Power Spectral Density (CDD mode)
 Directional Gain = $10 \log [(10^{G1/20} + 10^{G2/20} + \dots + 10^{Gn/20})^2 / N_{ANT}] = 8.07 \text{ dBi}$ dBi. > 6dBi.
 The reduced power spectral density limits (dBm/MHz) =
 5150 MHz to 5250 MHz : $17 \text{ dBm/MHz} - (8.07 \text{ dBi} - 6 \text{ dBi}) = 14.93 \text{ dBm/MHz}$ ◦
 5725 MHz to 5850 MHz : $30 \text{ dBm/500 kHz} - (8.07 \text{ dBi} - 6 \text{ dBi}) = 27.93 \text{ dBm/500 kHz}$ ◦
- (c) For Conducted Output Power (CDD mode)
 For $N_{ANT} = 2 < 5$,
 Direction gain = $G_{ANT} + 0 = 6 + 0 = 6 \text{ dBi}$.
 The Direction gain is less than 6 dBi, so conducted power limits will not be reduced.
- (4) Operating Mode and Antenna Configuration

Operating Mode	2 TX
802.11a	Ant. 1 + Ant. 2
802.11n (HT20)	Ant. 1 + Ant. 2
802.11n (HT40)	Ant. 1 + Ant. 2
802.11ac (VHT20)	Ant. 1 + Ant. 2
802.11ac (VHT40)	Ant. 1 + Ant. 2
802.11ac (VHT80)	Ant. 1 + Ant. 2

2.2 TEST MODES

Test Items	Test mode	Channel	Note
AC power line conducted emissions	TX Mode_IEEE 802.11ac (VHT80)	155	-
Transmitter Radiated Emissions (below 1GHz)	TX Mode_IEEE 802.11ac (VHT80)	155	-
Transmitter Radiated Emissions (above 1GHz)	TX Mode_IEEE 802.11a	36/40/48 149/157/165	-
	TX Mode_IEEE 802.11n (HT20) TX Mode_IEEE 802.11ac (VHT20)		802.11n (HT20) for UNII-1 802.11ac(VHT20) for UNII-3
	TX Mode_IEEE 802.11ac (VHT40)	38/46 151/159	-
	TX Mode_IEEE 802.11ac (VHT80)	42 155	
Bandwidth	TX Mode_IEEE 802.11a	36/40/48	-
	TX Mode_IEEE 802.11n (HT20)	149/157/165	
	TX Mode_IEEE 802.11n (HT40)	38/46 151/159	
	TX Mode_IEEE 802.11ac (VHT80)	42 155	
Output Power	TX Mode_IEEE 802.11a	36/40/48	-
	TX Mode_IEEE 802.11n (HT20)	149/157/165	
	TX Mode_IEEE 802.11n (HT40)	38/46 151/159	
	TX Mode_IEEE 802.11ac (VHT80)	42 155	
Power Spectral Density	TX Mode_IEEE 802.11a	36/40/48	-
	TX Mode_IEEE 802.11n (HT20)	149/157/165	
	TX Mode_IEEE 802.11n (HT40)	38/46 151/159	
	TX Mode_IEEE 802.11ac (VHT80)	42 155	
Frequency Stability	TX Mode_IEEE 802.11a	36 149	-

NOTE:

- (1) The Radiated emissions test was verified based on the worst conducted power and Bandwidth test results reported in the original report.
- (2) All X, Y and Z axes are evaluated, but only the worst case (X axis) is recorded.
- (3) There were no emissions found below 30 MHz within 20 dB of the limit.

2.3 BLOCK DIAGRAM SHOWING THE CONFIGURATION OF SYSTEM TESTED

Equipment letters and Cable numbers refer to item numbers described in the tables of clause 2.4.
AC power line conducted emissions

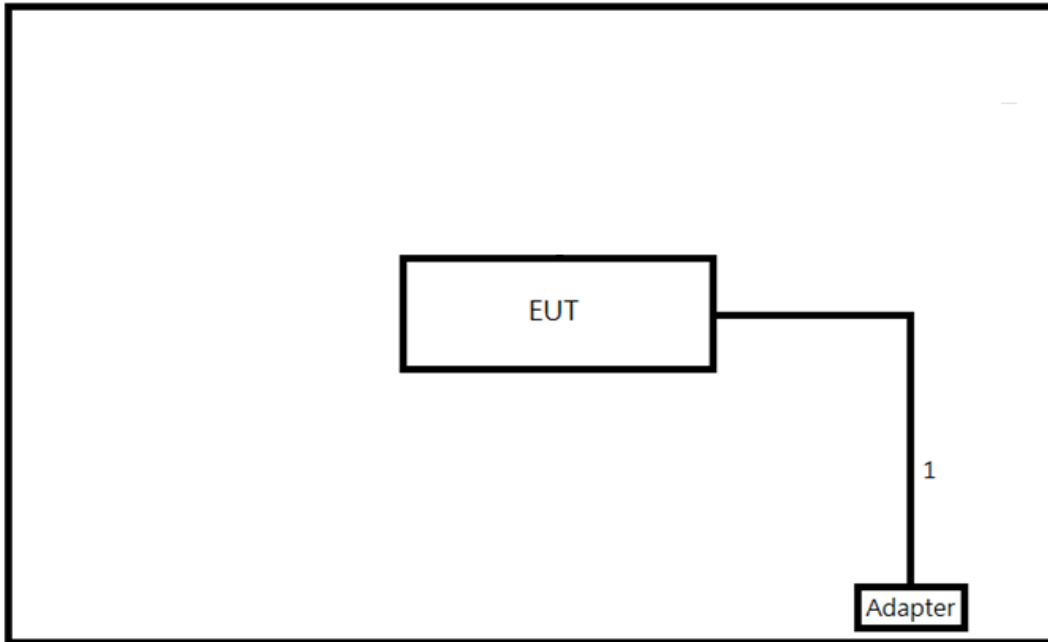

Radiated Emissions

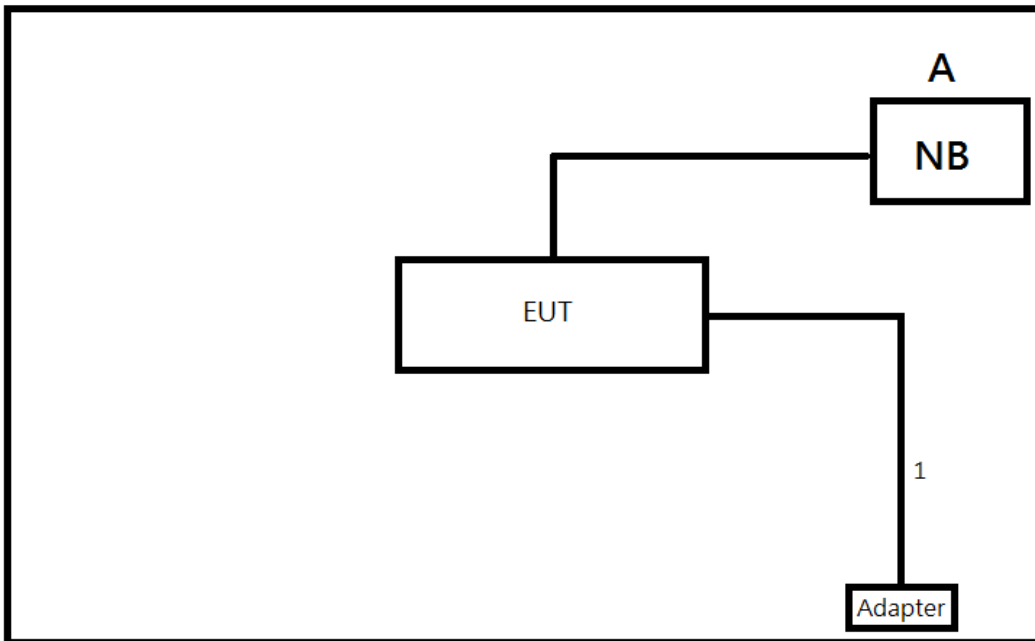

2.4 SUPPORT UNITS

Item	Equipment	Brand	Model No.	Series No.	Remarks
A	NB	HP	TPN-I119	N/A	-

Item	Shielded	Ferrite Core	Length	Cable Type	Remarks
1	NO	NO	1m	Power Cable	-

3 AC POWER LINE CONDUCTED EMISSIONS TEST

3.1 LIMIT

Frequency (MHz)	Limit (dB μ V)	
	Quasi-peak	Average
0.15 - 0.5	66 - 56 *	56 - 46 *
0.50 - 5.0	56	46
5.0 - 30.0	60	50

NOTE:

- (1) The tighter limit applies at the band edges.
- (2) The limit of " * " marked band means the limitation decreases linearly with the logarithm of the frequency in the range.
- (3) The test result calculated as following:
 Measurement Value = Reading Level + Correct Factor
 Correct Factor = Insertion Loss + Cable Loss + Attenuator Factor (if use)
 Margin Level = Measurement Value – Limit Value
 Calculation example:

Reading Level		Correct Factor		Measurement Value
38.22	+	3.45	=	41.67

Measurement Value		Limit Value		Margin Level
41.67	-	60	=	-18.33

The following table is the setting of the receiver.

Receiver Parameter	Setting
Attenuation	10 dB
Start Frequency	0.15 MHz
Stop Frequency	30 MHz
IF Bandwidth	9 KHz

3.2 TEST PROCEDURE

- a. The EUT was placed 0.8 m above the horizontal ground plane with the EUT being connected to the power mains through a line impedance stabilization network (LISN).
 All other support equipment were powered from an additional LISN(s).
 The LISN provides 50 Ohm/50uH of impedance for the measuring instrument.
- b. Interconnecting cables that hang closer than 40 cm to the ground plane shall be folded back and forth in the center forming a bundle to keep the cable above 40 cm.
- c. Excess I/O cables that are not connected to a peripheral shall be bundled in the center.
 The end of the cable will be terminated, using the correct terminating impedance.
 The overall length shall not exceed 1 m.
- d. The LISN is spaced at least 80 cm from the nearest part of the EUT chassis.
- e. For the actual test configuration, please refer to the related Item - EUT TEST PHOTO.

NOTE:

- (1) In the results, each reading is marked as Peak, QP or AVG per the detector used.
 BW=9 kHz (6 dB Bandwidth)
- (2) All readings are Peak unless otherwise stated QP or AVG in column of Note. Both the QP and the AVG readings must be less than the limit for compliance.

3.3 DEVIATION FROM TEST STANDARD

No deviation.

3.4 TEST SETUP

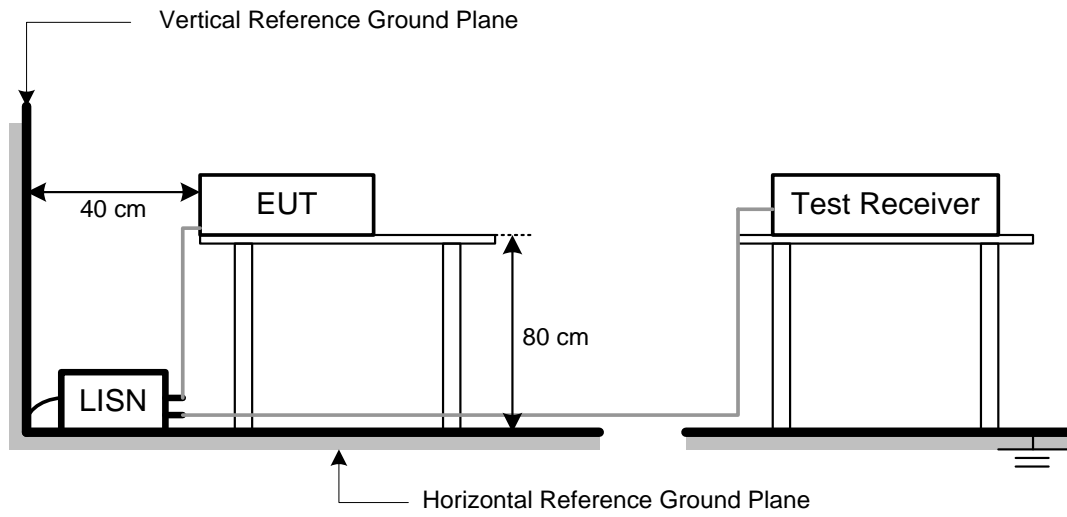

3.5 TEST RESULT

Please refer to the APPENDIX A.

4 RADIATED EMISSIONS TEST

4.1 LIMIT

In case the emission fall within the restricted band specified on 15.205, then the 15.209 limit in the table below has to be followed.

LIMITS OF RADIATED EMISSIONS MEASUREMENT (9 kHz to 1000 MHz)

Frequency (MHz)	Field Strength (microvolts/meter)	Measurement Distance (meters)
0.009~0.490	2400/F(KHz)	300
0.490~1.705	24000/F(KHz)	30
1.705~30.0	30	30
30~88	100	3
88~216	150	3
216~960	200	3
960~1000	500	3

LIMITS OF UNWANTED EMISSION OUT OF THE RESTRICTED BANDS

Frequency (MHz)	EIRP Limit (dBm)	Equivalent Field Strength at 3m (dBµV/m)
5150-5250	-27	68.3
5250-5350	-27	68.3
5470-5725	-27	68.3
5725-5850	-27 (NOTE 2)	68.3
	10 (NOTE 2)	105.3
	15.6 (NOTE 2)	110.9
	27 (NOTE 2)	122.3

NOTE:

(1) The following formula is used to convert the equipment isotropic radiated power (eirp) to field strength:

$$E = \frac{1000000\sqrt{30P}}{3} \mu\text{V/m, where P is the eirp (Watts)}$$

(2) According to FCC 16-24, All emissions shall be limited to a level of -27 dBm/MHz at 75 MHz or more above or below the band edge increasing linearly to 10 dBm/MHz at 25 MHz above or below the band edge, and from 25 MHz above or below the band edge increasing linearly to a level of 15.6 dBm/MHz at 5 MHz above or below the band edge, and from 5 MHz above or below the band edge increasing linearly to a level of 27 dBm/MHz at the band edge.

(3) The test result calculated as following:

Measurement Value = Reading Level + Correct Factor

Correct Factor = Antenna Factor + Cable Loss - Amplifier Gain(if use)

Margin Level = Measurement Value - Limit Value

Calculation example:

Reading Level		Correct Factor		Measurement Value
19.11	+	2.11	=	21.22

Measurement Value		Limit Value		Margin Level
21.22	-	68.3	=	-47.08

Spectrum Parameter	Setting
Attenuation	Auto
Start Frequency	1000 MHz
Stop Frequency	10th carrier harmonic
RBW / VBW (Emission in restricted band)	1MHz / 3MHz for Peak, 1MHz / 1/T for Average

Spectrum Parameter	Setting
Attenuation	Auto
Start ~ Stop Frequency	9KHz~90KHz for PK/AVG detector
Start ~ Stop Frequency	90KHz~110KHz for QP detector
Start ~ Stop Frequency	110KHz~490KHz for PK/AVG detector
Start ~ Stop Frequency	490KHz~30MHz for QP detector
Start ~ Stop Frequency	30MHz~1000MHz for QP detector

4.2 TEST PROCEDURE

- a. The measuring distance of 3 m shall be used for measurements. The EUT was placed on the top of a rotating table 0.8 meter above the ground at a 3 meter semi-anechoic chamber. The table was rotated 360 degrees to determine the position of the highest radiation.(below 1GHz)
- b. The measuring distance of 3 m shall be used for measurements. The EUT was placed on the top of a rotating table 1.5 meter above the ground at a 3 meter semi-anechoic chamber. The table was rotated 360 degrees to determine the position of the highest radiation.(above 1GHz)
- c. The height of the equipment or of the substitution antenna shall be 0.8 m or 1.5 m, the height of the test antenna shall vary between 1 m to 4 m. Both horizontal and vertical polarizations of the antenna are set to make the measurement.
- d. For each suspected emission, the EUT was arranged to its worst case and then the antenna was tuned to heights find the maximum reading (used Bore sight function).
- e. The receiver system was set to peak and average detect function and specified bandwidth with maximum hold mode when the test frequency is above 1GHz.
- f. The initial step in collecting radiated emission data is a receiver peak detector mode pre-scanning the measurement frequency range. Significant peaks are then marked and then Quasi Peak detector mode re-measured.
- g. All readings are Peak unless otherwise stated QP in column of Note. Peak denotes that the Peak reading compliance with the QP Limits and then QP Mode measurement didn't perform. (below 1GHz)
- h. All readings are Peak Mode value unless otherwise stated AVG in column of Note. If the Peak Mode Measured value compliance with the Peak Limits and lower than AVG Limits, the EUT shall be deemed to meet both Peak & AVG Limits and then only Peak Mode was measured, but AVG Mode didn't perform. (above 1GHz)
- i. For the actual test configuration, please refer to the related Item – EUT TEST PHOTO.

4.3 DEVIATION FROM TEST STANDARD

No deviation.

4.4 TEST SETUP

9 kHz to 30 MHz

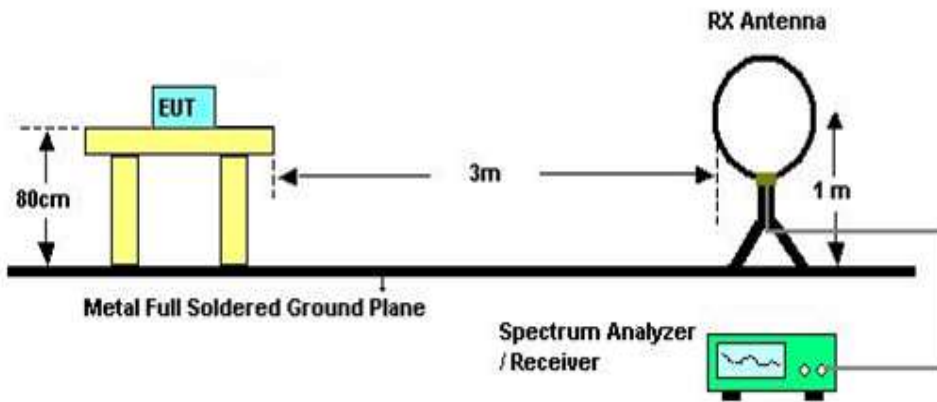

30 MHz to 1 GHz

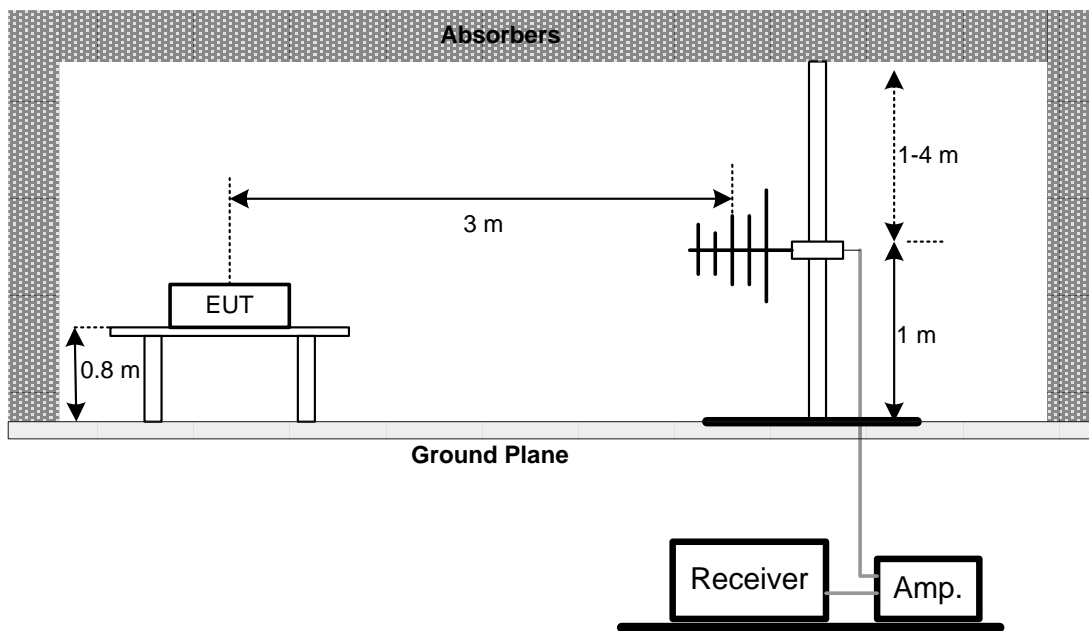

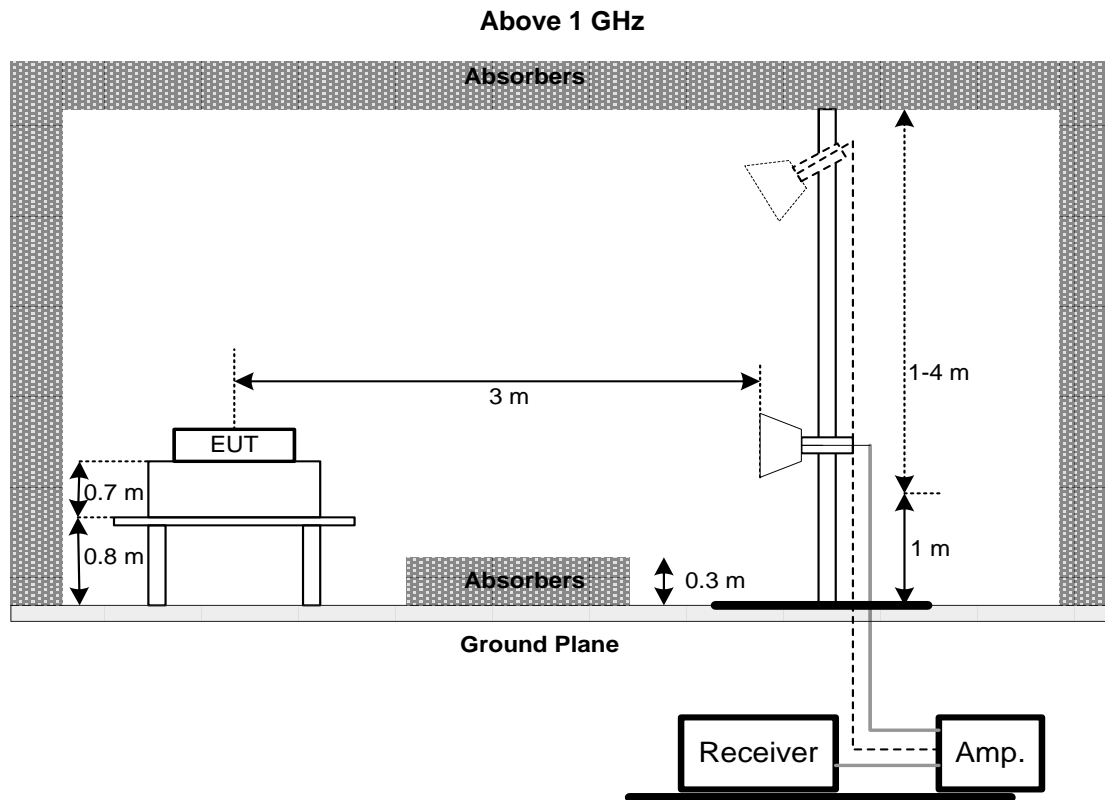

4.5 EUT OPERATING CONDITIONS

The EUT was programmed to be in continuously transmitting mode.

4.6 TEST RESULT – 30 MHZ TO 1 GHZ

Please refer to the APPENDIX B.

4.7 TEST RESULT – ABOVE 1 GHZ

Please refer to the APPENDIX C.

NOTE:

- (1) No limit: This is fundamental signal, the judgment is not applicable.
For fundamental signal judgment was referred to Peak output test.

5 BANDWIDTH TEST

5.1 LIMIT

FCC Part15, Subpart E (15.407)		
Section	Test Item	Frequency Range (MHz)
15.407(a)	26 dB Bandwidth	5150-5250
		5250-5350
		5470-5725
	Minimum 500 kHz 6 dB Bandwidth	5725-5850

5.2 TEST PROCEDURE

- a. The EUT was directly connected to the spectrum analyzer and antenna output port as show in the block diagram below.
- b. Spectrum Setting:

Spectrum Parameter	Setting
Attenuation	Auto
Span Frequency	> 26 dB Bandwidth
RBW	300 kHz(Bandwidth 20 MHz) 1 MHz(Bandwidth 40 MHz and 80 MHz)
VBW	1 MHz(Bandwidth 20 MHz) 3 MHz(Bandwidth 40 MHz and 80 MHz)
Detector	Peak
Trace	Max Hold
Sweep Time	Auto

5.3 DEVIATION FROM TEST STANDARD

No deviation.

5.4 TEST SETUP

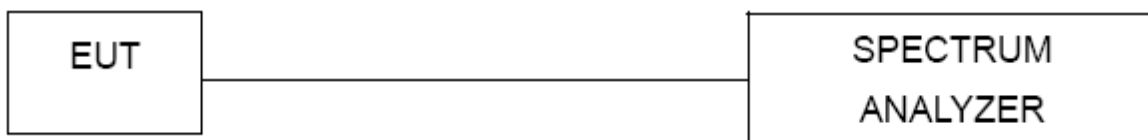

5.5 EUT OPERATING CONDITIONS

The EUT was programmed to be in continuously transmitting mode.

5.6 TEST RESULT

Please refer to the APPENDIX D.

6 OUTPUT POWER TEST

6.1 LIMIT

FCC Part15, Subpart E (15.407)			
Section	Test Item	Limit	Frequency Range (MHz)
15.407(a)	Maximum Output Power	Fixed:1 Watt (30 dBm) Mobile and portable: 250 mW (24 dBm)	5150-5250
		250 mW (24 dBm)	5250-5350
		1 Watt (30dBm)	5470-5725 5725-5850

Note: The maximum e.i.r.p at any elevation angle above 30 degrees as measured from the horizon must not exceed 125 mW(21 dBm).

6.2 TEST PROCEDURE

- a. The EUT was directly connected to the power meter and antenna output port as show in the block diagram below.
- b. Spectrum Setting:

Spectrum Parameter	Setting
Attenuation	Auto
Span Frequency	Encompass the entire emissions bandwidth (EBW) of the signal
RBW	= 1 MHz
VBW	≥ 3 MHz
Detector	RMS
Trace	Max Hold
Sweep Time	auto

- c. The maximum peak conducted output power was performed in accordance with method of FCC KDB 789033 D02 General UNII Test Procedures New Rules v02r01.

6.3 DEVIATION FROM TEST STANDARD

No deviation.

6.4 TEST SETUP



6.5 EUT OPERATING CONDITIONS

The EUT was programmed to be in continuously transmitting mode.

6.6 TEST RESULT

Please refer to the APPENDIX E.

7 POWER SPECTRAL DENSITY

7.1 LIMIT

FCC Part15, Subpart E (15.407)			
Section	Test Item	Limit	Frequency Range (MHz)
15.407(a)	Power Spectral Density	Other than Mobile and portable: 17 dBm/MHz Mobile and portable: 11 dBm/MHz	5150-5250
		11 dBm/MHz	5250-5350
		30 dBm/500 kHz	5470-5725
			5725-5850

7.2 TEST PROCEDURE

- a. The EUT was directly connected to the spectrum analyzer and antenna output port as show in the block diagram below.
- b. Spectrum Setting:

Spectrum Parameter	Setting
Attenuation	Auto
Span Frequency	Encompass the entire emissions bandwidth (EBW) of the signal
RBW	= 1 MHz
VBW	≥ 3 MHz
Detector	RMS
Trace	Max Hold
Sweep Time	Auto

7.3 DEVIATION FROM TEST STANDARD

No deviation.

7.4 TEST SETUP

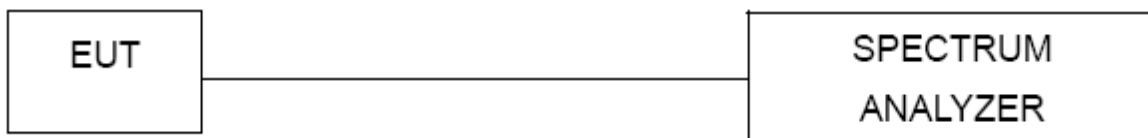

7.5 EUT OPERATING CONDITIONS

The EUT was programmed to be in continuously transmitting mode.

7.6 TEST RESULT

Please refer to the APPENDIX F.

8 FREQUENCY STABILITY TEST

8.1 LIMIT

FCC Part15, Subpart E (15.407)			
Section	Test Item	Limit	Frequency Range (MHz)
15.407(g)	Frequency Stability	Specified in the user's manual	5150-5250
			5250-5350
			5470-5725
			5725-5850

8.2 TEST PROCEDURE

- The EUT was directly connected to the spectrum analyzer and antenna output port as show in the block diagram below.
- Spectrum Setting:

Spectrum Parameter	Setting
Attenuation	Auto
Span Frequency	Entire absence of modulation emissions bandwidth
RBW	10 kHz
VBW	10 kHz
Sweep Time	Auto

- The test extreme voltage is to change the primary supply voltage from 85 to 115 percent of the nominal value.
- User manual temperature is 0°C~40°C.

8.3 DEVIATION FROM TEST STANDARD

No deviation.

8.4 TEST SETUP

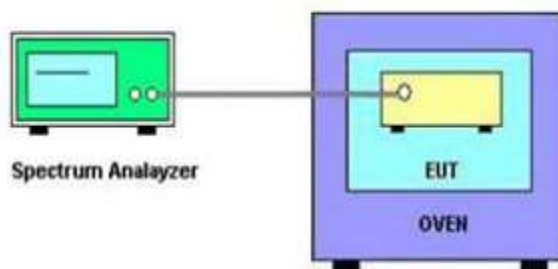

8.5 EUT OPERATING CONDITIONS

The EUT was programmed to be in continuously transmitting mode.

8.6 TEST RESULT

Please refer to the APPENDIX G.

9 LIST OF MEASURING EQUIPMENTS

AC Power Line Conducted Emissions						
Item	Kind of Equipment	Manufacturer	Type No.	Serial No.	Calibrated Date	Calibrated Until
1	TWO-LINE V-NETWORK	R&S	ENV216	101050	2019/3/18	2020/3/16
2	Test Cable	EMCI	EMCCFD300-BM-BMR-6000	170715	2019/8/9	2020/8/7
3	EMI Test Receiver	R&S	ESR7	101433	2018/12/5	2019/12/4
4	Measurement Software	EZ	EZ EMC (Version NB-03A)	N/A	N/A	N/A

Radiated Emissions						
Item	Kind of Equipment	Manufacturer	Type No.	Serial No.	Calibrated Date	Calibrated Until
1	Preamplifier	EMCI	EMC02325	980217	2019/4/15	2020/4/13
2	Preamplifier	EMCI	EMC2654045	980030	2019/2/2	2020/2/1
3	Test Cable	EMCI	EMC104-SM-SM-8000	8m	2019/4/15	2020/4/13
4	Test Cable	EMCI	EMC104-SM-SM-800	150207	2019/4/15	2020/4/13
5	Test Cable	EMCI	EEMC104-SM-SM-3000	151205	2019/4/15	2020/4/13
6	MXE EMI Receiver	Agilent	N9038A	MY55420127	2019/3/26	2020/3/24
7	Signal Analyzer	Agilent	N9010A	MY52220990	2019/4/17	2020/4/15
8	Horn Ant	SCHWARZBECK	BBHA 9120D	9120D-1342	2019/5/3	2020/5/1
9	Trilog-Broadband Antenna	Schwarzbeck	VULB 9168	9168-548	2019/3/22	2020/3/20
10	5dB Attenuator	EMCI	EMCI-N-6-05	AT-N0623	2019/3/22	2020/3/20

Bandwidth						
Item	Kind of Equipment	Manufacturer	Type No.	Serial No.	Calibrated Date	Calibrated Until
1	Spectrum Analyzer	R&S	FSP40	100129	2019/5/23	2020/5/22

Output Power						
Item	Kind of Equipment	Manufacturer	Type No.	Serial No.	Calibrated Date	Calibrated Until
1	Spectrum Analyzer	R&S	FSP40	100129	2019/5/23	2020/5/22
2	Power Meter	Anritsu	ML2495A	1128008	2018/12/6	2019/12/5
3	Power Sensor	Anritsu	MA2411B	1126001	2018/12/6	2019/12/5

Power Spectral Density						
Item	Kind of Equipment	Manufacturer	Type No.	Serial No.	Calibrated Date	Calibrated Until
1	Spectrum Analyzer	R&S	FSP40	100129	2019/5/23	2020/5/22

Frequency Stability						
Item	Kind of Equipment	Manufacturer	Type No.	Serial No.	Calibrated Date	Calibrated Until
1	Spectrum Analyzer	R&S	FSP40	100129	2019/5/23	2020/5/22

Remark: "N/A" denotes no model name, no serial no. or no calibration specified.
All calibration period of equipment list is one year.

10 EUT TEST PHOTO

Please refer to document Appendix No.: TP-1803T076A-2 (APPENDIX-TEST PHOTOS).

11 EUT PHOTOS

Please refer to document Appendix No.: EP-1803T076A-1 (APPENDIX-EUT PHOTOS).

APPENDIX A AC POWER LINE CONDUCTED EMISSIONS

Test Mode	UNII-3/ TX Mode_IEEE 802.11ac (VHT80)	Tested Date	2019/5/7
Test Voltage	AC 120V/60Hz	Phase	Line

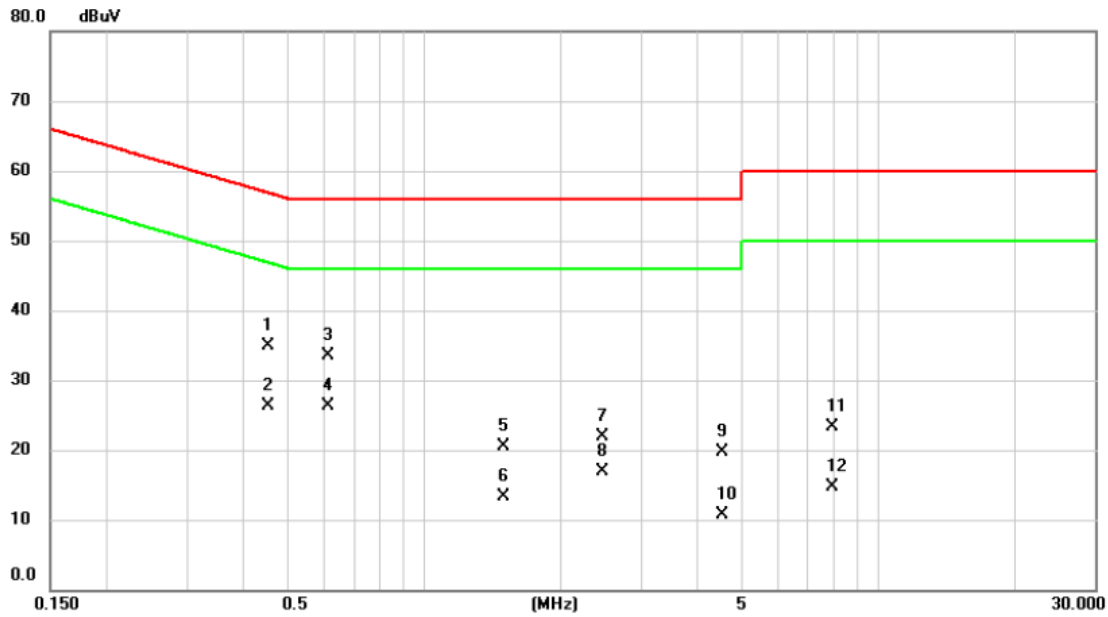

No. Mk.	Freq. MHz	Reading Level dBuV	Correct Factor dB	Measurement dBuV	Limit dBuV	Over dB	Detector	Comment
1	0.4537	25.36	9.58	34.94	56.81	-21.87	QP	
2	0.4537	16.79	9.58	26.37	46.81	-20.44	AVG	
3	0.6134	23.90	9.59	33.49	56.00	-22.51	QP	
4 *	0.6134	16.77	9.59	26.36	46.00	-19.64	AVG	
5	1.4955	10.81	9.64	20.45	56.00	-35.55	QP	
6	1.4955	3.61	9.64	13.25	46.00	-32.75	AVG	
7	2.4653	12.20	9.69	21.89	56.00	-34.11	QP	
8	2.4653	7.17	9.69	16.86	46.00	-29.14	AVG	
9	4.5285	9.95	9.74	19.69	56.00	-36.31	QP	
10	4.5285	0.90	9.74	10.64	46.00	-35.36	AVG	
11	7.9260	13.55	9.81	23.36	60.00	-36.64	QP	
12	7.9260	4.91	9.81	14.72	50.00	-35.28	AVG	

REMARKS:

- (1) Measurement Value = Reading Level + Correct Factor.
- (2) Margin Level = Measurement Value - Limit Value.

Test Mode	UNII-3/ TX Mode_IEEE 802.11ac (VHT80)	Tested Date	2019/5/7
Test Voltage	AC 120V/60Hz	Phase	Neutral

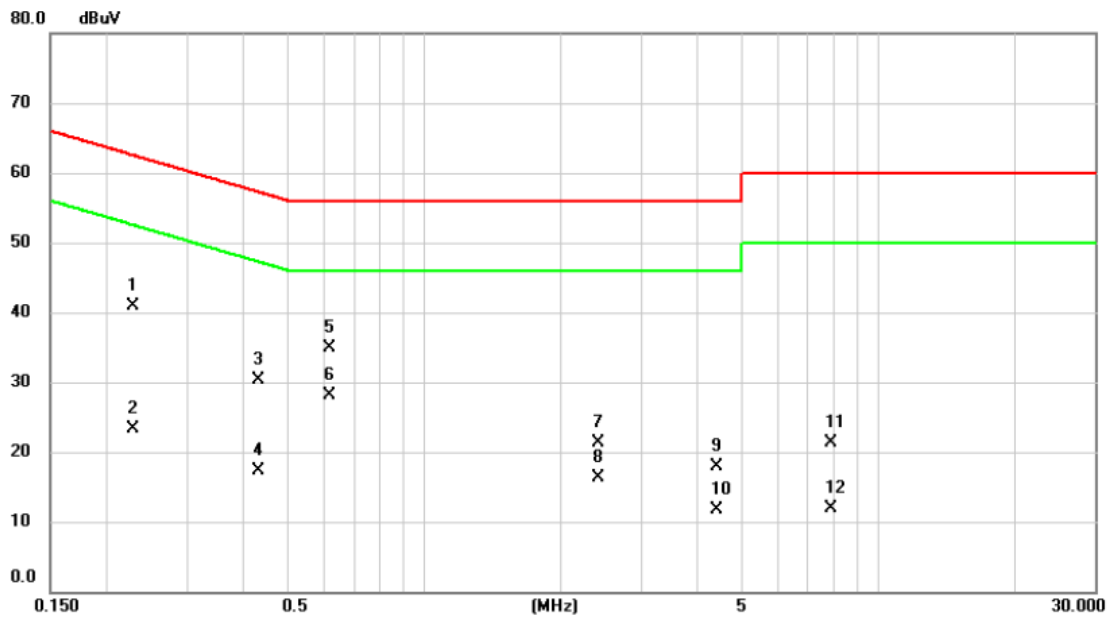

No. Mk.	Freq. MHz	Reading Level dBuV	Correct Factor dB	Measurement dBuV	Limit dBuV	Over dB	Detector	Comment
1	0.2288	31.24	9.63	40.87	62.49	-21.62	QP	
2	0.2288	13.70	9.63	23.33	52.49	-29.16	CAV	
3	0.4312	20.74	9.63	30.37	57.23	-26.86	QP	
4	0.4312	7.67	9.63	17.30	47.23	-29.93	AVG	
5	0.6180	25.27	9.64	34.91	56.00	-21.09	QP	
6 *	0.6180	18.52	9.64	28.16	46.00	-17.84	AVG	
7	2.4157	11.59	9.73	21.32	56.00	-34.68	QP	
8	2.4157	6.64	9.73	16.37	46.00	-29.63	AVG	
9	4.4003	8.16	9.78	17.94	56.00	-38.06	QP	
10	4.4003	1.90	9.78	11.68	46.00	-34.32	AVG	
11	7.8585	11.35	9.87	21.22	60.00	-38.78	QP	
12	7.8585	2.01	9.87	11.88	50.00	-38.12	AVG	

REMARKS:

- (1) Measurement Value = Reading Level + Correct Factor.
- (2) Margin Level = Measurement Value - Limit Value.

APPENDIX B RADIATED EMISSIONS - 30 MHZ TO 1 GHZ

Test Mode	UNII-3/ TX Mode_IEEE 802.11ac (VHT80)	Tested Date	2019/5/7
Test Voltage	AC 120V/60Hz	Polarization	Vertical

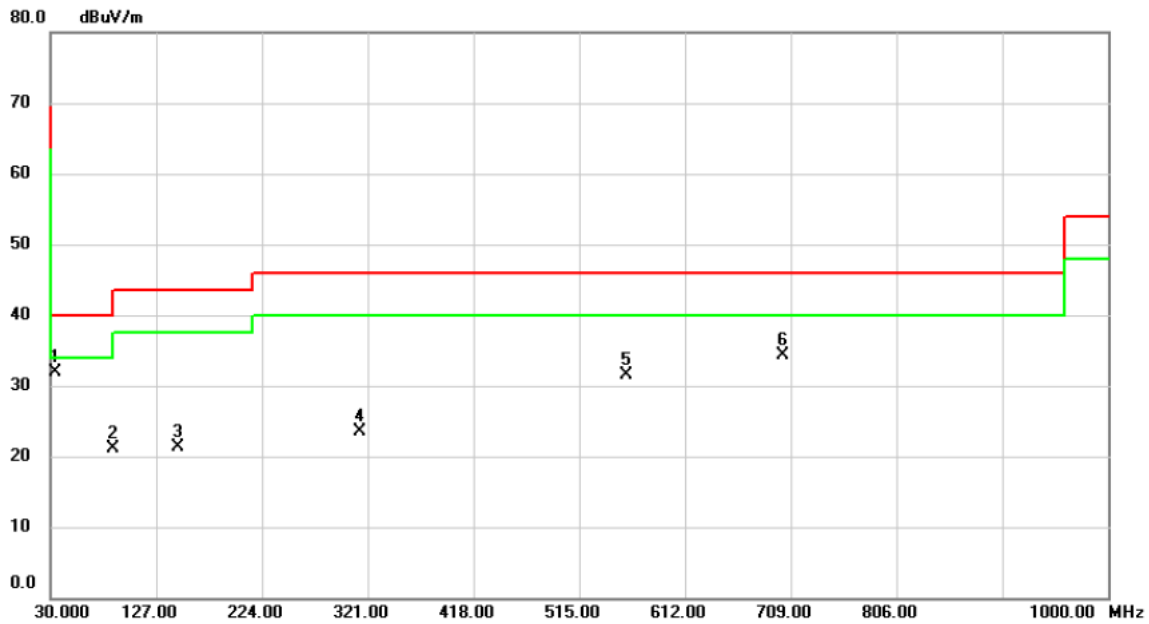

No.	Mk.	Freq. MHz	Reading Level dBuV	Correct Factor dB	Measure- ment dBuV/m	Limit dBuV/m	Over dB	Detector	Comment
1	*	33.8800	40.95	-9.02	31.93	40.00	-8.07	peak	
2		87.2300	34.45	-13.44	21.01	40.00	-18.99	peak	
3		146.4000	30.02	-8.69	21.33	43.50	-22.17	peak	
4		314.2100	30.66	-7.14	23.52	46.00	-22.48	peak	
5		558.6500	33.24	-1.73	31.51	46.00	-14.49	peak	
6		701.2400	33.07	1.30	34.37	46.00	-11.63	peak	

REMARKS:

- (1) Measurement Value = Reading Level + Correct Factor.
- (2) Margin Level = Measurement Value - Limit Value.

Test Mode	UNII-3/ TX Mode_IEEE 802.11ac (VHT80)	Tested Date	2019/5/7
Test Voltage	AC 120V/60Hz	Polarization	Horizontal

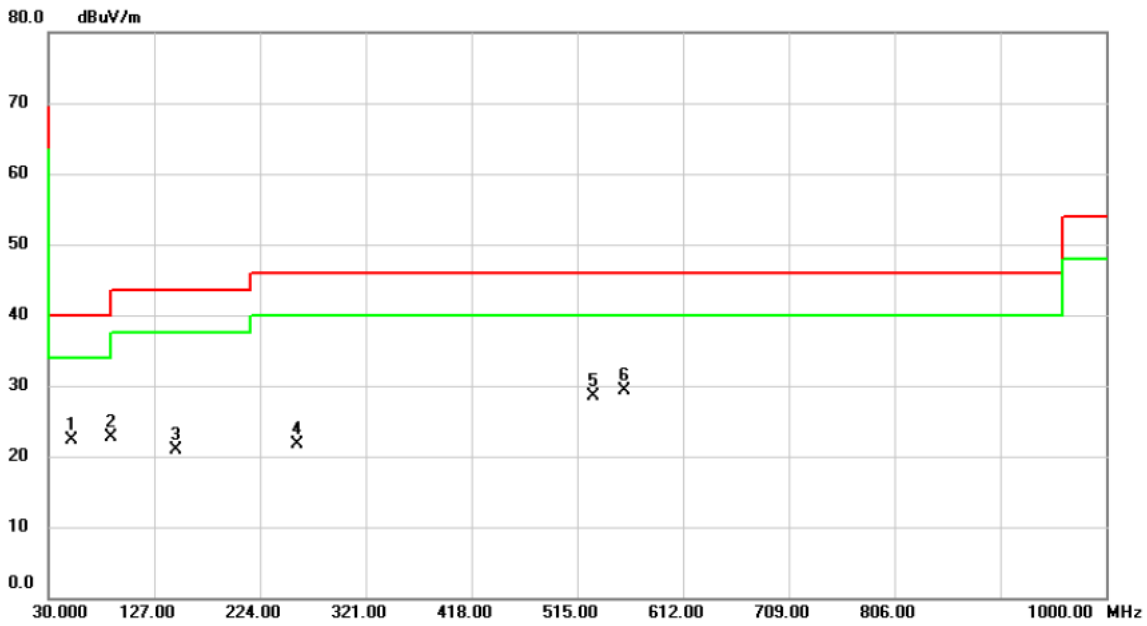

No.	Mk.	Freq. MHz	Reading Level dBuV	Correct Factor dB	Measure- ment dBuV/m	Limit dBuV/m	Over dB	Detector	Comment
1		51.3400	30.37	-8.13	22.24	40.00	-17.76	peak	
2		87.2300	36.19	-13.44	22.75	40.00	-17.25	peak	
3		146.4000	29.60	-8.69	20.91	43.50	-22.59	peak	
4		257.9500	30.41	-8.79	21.62	46.00	-24.38	peak	
5		529.5500	30.88	-2.39	28.49	46.00	-17.51	peak	
6	*	558.6500	31.01	-1.73	29.28	46.00	-16.72	peak	

REMARKS:

- (1) Measurement Value = Reading Level + Correct Factor.
- (2) Margin Level = Measurement Value - Limit Value.

APPENDIX C RADIATED EMISSIONS - ABOVE 1 GHZ

Test Mode	UNII-1_TX a Mode 5180MHz	Tested Date	2019/5/9~11
Test Voltage	AC 120V/60Hz	Polarization	Vertical

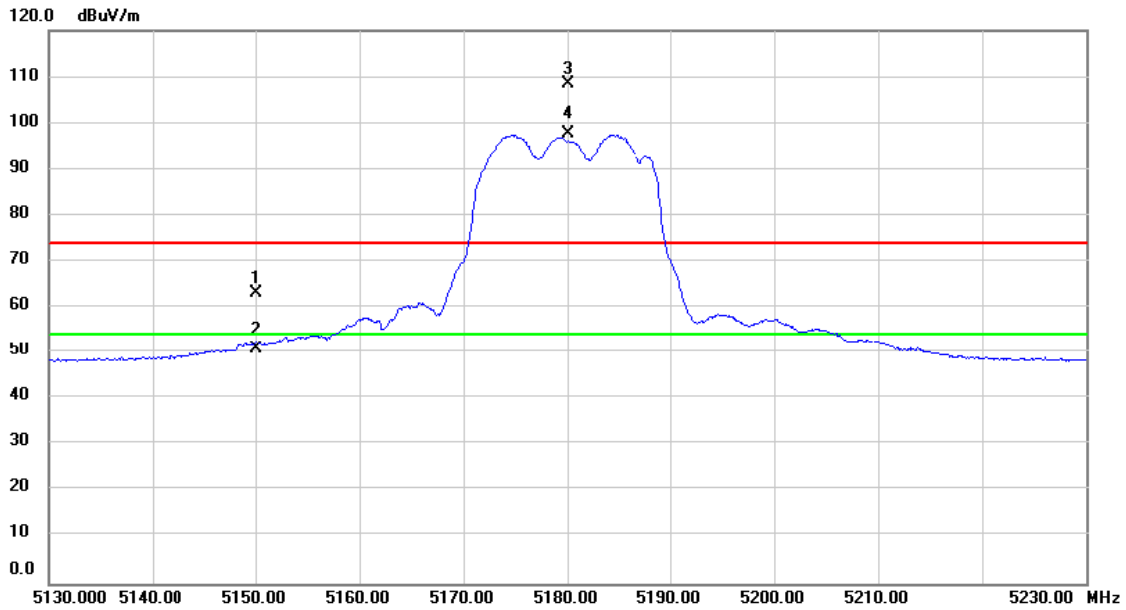

No.	Mk.	Freq. MHz	Reading Level dBuV	Correct Factor dB	Measure- ment dBuV/m	Limit dBuV/m	Over dB	Detector	Comment
1		5150.000	25.64	37.50	63.14	74.00	-10.86	peak	
2		5150.000	13.22	37.50	50.72	54.00	-3.28	AVG	
3	X	5180.000	70.86	37.55	108.41	74.00	34.41	peak	No Limit
4	*	5180.000	60.01	37.55	97.56	54.00	43.56	AVG	No Limit

REMARKS:

(1) Measurement Value = Reading Level + Correct Factor.

(2) Margin Level = Measurement Value - Limit Value.

Test Mode	UNII-1_TX a Mode 5180MHz	Tested Date	2019/5/9~11
Test Voltage	AC 120V/60Hz	Polarization	Horizontal

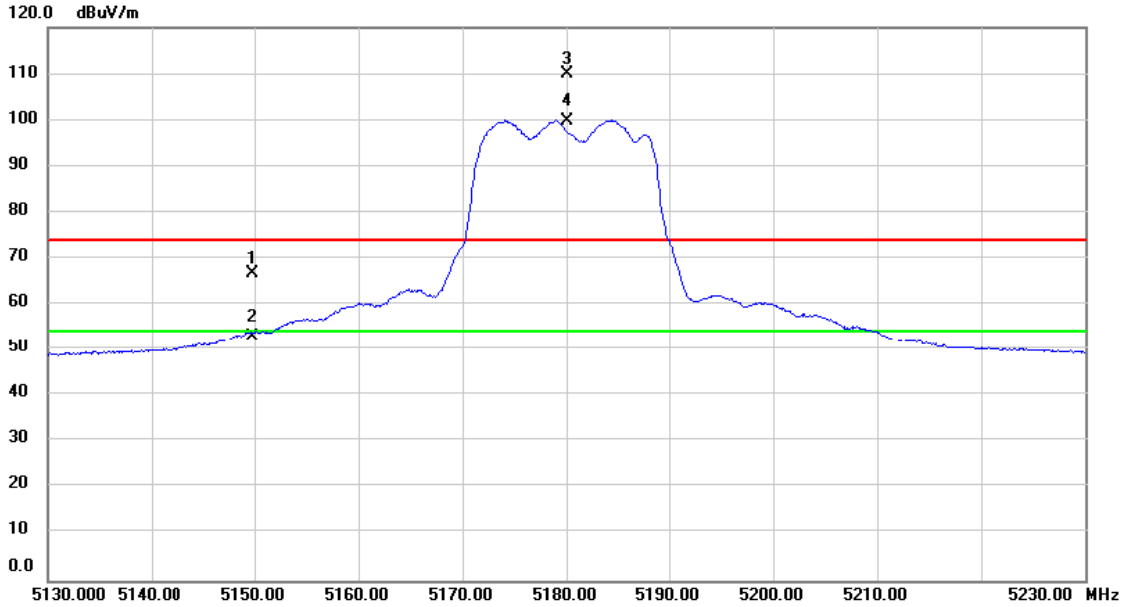

No.	Mk.	Freq. MHz	Reading Level dBuV	Correct Factor dB	Measure- ment dBuV/m	Limit dBuV/m	Over dB	Detector	Comment
1		5149.850	29.25	37.49	66.74	74.00	-7.26	peak	
2		5149.850	15.43	37.49	52.92	54.00	-1.08	AVG	
3	X	5180.000	72.47	37.55	110.02	74.00	36.02	peak	No Limit
4	*	5180.000	62.09	37.55	99.64	54.00	45.64	AVG	No Limit

REMARKS:

- (1) Measurement Value = Reading Level + Correct Factor.
- (2) Margin Level = Measurement Value - Limit Value.

Test Mode	UNII-1_TX a Mode 5200MHz	Tested Date	2019/5/9~11
Test Voltage	AC 120V/60Hz	Polarization	Vertical

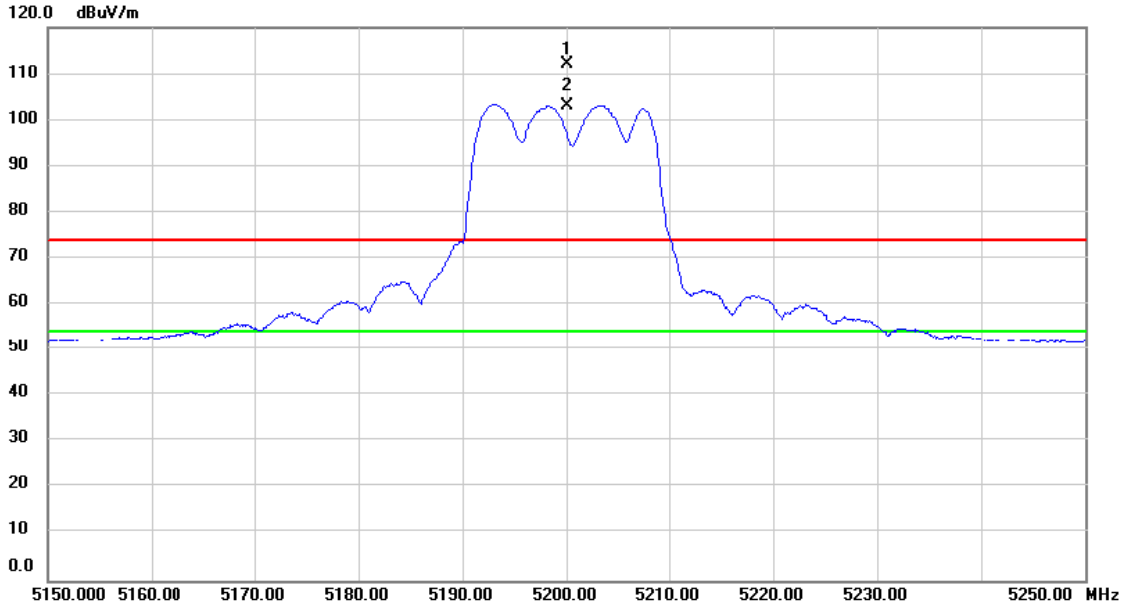

No.	Mk.	Freq. MHz	Reading Level dBuV	Correct Factor dB	Measure- ment dBuV/m	Limit dBuV/m	Over dB	Detector	Comment
1	X	5200.000	74.38	37.58	111.96	74.00	37.96	peak	No Limit
2	*	5200.000	65.53	37.58	103.11	54.00	49.11	AVG	No Limit

REMARKS:

- (1) Measurement Value = Reading Level + Correct Factor.
- (2) Margin Level = Measurement Value - Limit Value.

Test Mode	UNII-1_TX a Mode 5200MHz	Tested Date	2019/5/9~11
Test Voltage	AC 120V/60Hz	Polarization	Horizontal

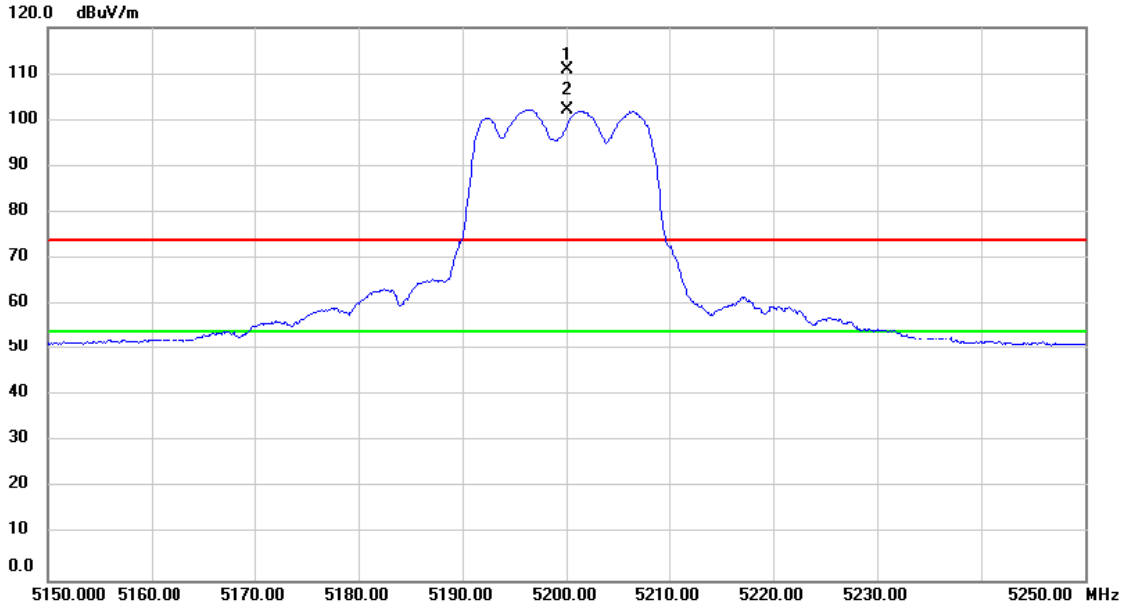

No.	Mk.	Freq. MHz	Reading Level dBuV	Correct Factor dB	Measure- ment dBuV/m	Limit dBuV/m	Over dB	Detector	Comment
1	X	5200.000	73.19	37.58	110.77	74.00	36.77	peak	No Limit
2	*	5200.000	64.67	37.58	102.25	54.00	48.25	AVG	No Limit

REMARKS:

- (1) Measurement Value = Reading Level + Correct Factor.
- (2) Margin Level = Measurement Value - Limit Value.

Test Mode	UNII-1_TX a Mode 5240MHz	Tested Date	2019/5/9~11
Test Voltage	AC 120V/60Hz	Polarization	Vertical

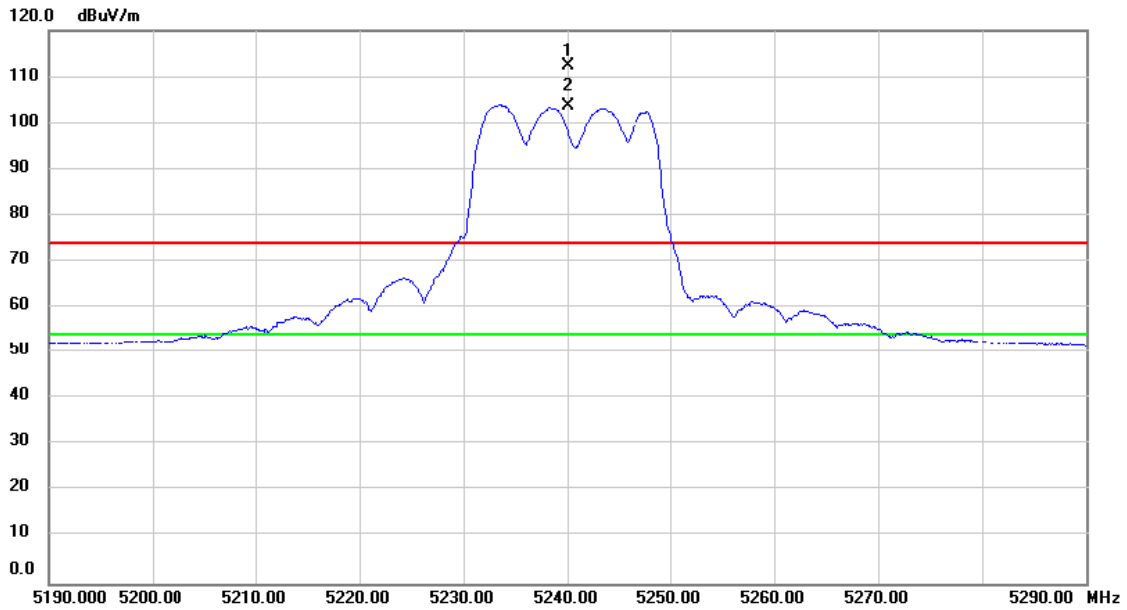

No.	Mk.	Freq. MHz	Reading Level dBuV	Correct Factor dB	Measure- ment dBuV/m	Limit dBuV/m	Over dB	Detector	Comment
1	X	5240.000	74.62	37.65	112.27	74.00	38.27	peak	No Limit
2	*	5240.000	66.10	37.65	103.75	54.00	49.75	AVG	No Limit

REMARKS:

- (1) Measurement Value = Reading Level + Correct Factor.
- (2) Margin Level = Measurement Value - Limit Value.

Test Mode	UNII-1_TX a Mode 5240MHz	Tested Date	2019/5/9~11
Test Voltage	AC 120V/60Hz	Polarization	Horizontal

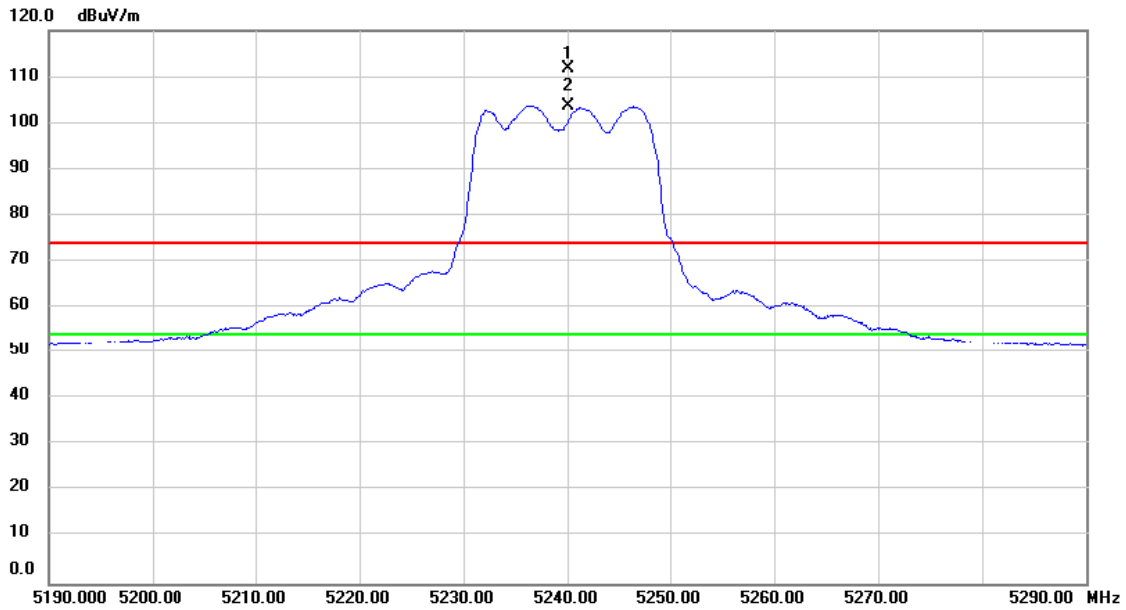

No.	Mk.	Freq. MHz	Reading Level dBuV	Correct Factor dB	Measure- ment dBuV/m	Limit dBuV/m	Over dB	Detector	Comment
1	X	5240.000	73.97	37.65	111.62	74.00	37.62	peak	No Limit
2	*	5240.000	66.00	37.65	103.65	54.00	49.65	AVG	No Limit

REMARKS:

- (1) Measurement Value = Reading Level + Correct Factor.
- (2) Margin Level = Measurement Value - Limit Value.

Test Mode	UNII-1_TX n (HT20) Mode 5180MHz	Tested Date	2019/5/9~11
Test Voltage	AC 120V/60Hz	Polarization	Vertical

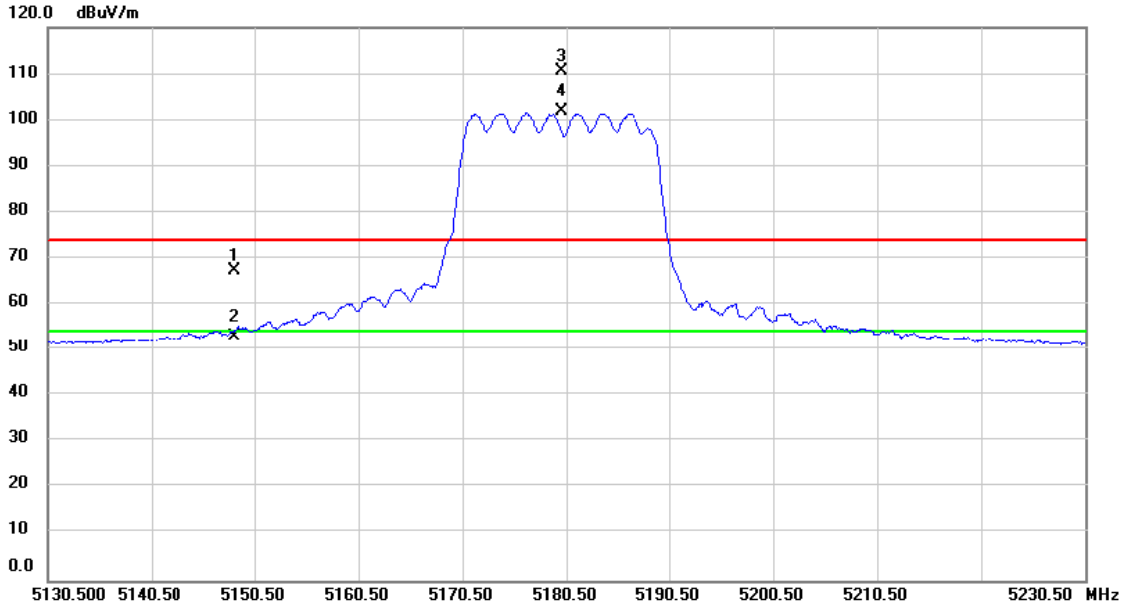

No.	Mk.	Freq. MHz	Reading Level dBuV	Correct Factor dB	Measure- ment dBuV/m	Limit dBuV/m	Over dB	Detector	Comment
1		5148.577	29.98	37.49	67.47	74.00	-6.53	peak	
2		5148.577	15.46	37.49	52.95	54.00	-1.05	AVG	
3	X	5180.000	73.01	37.55	110.56	74.00	36.56	peak	No Limit
4	*	5180.000	64.22	37.55	101.77	54.00	47.77	AVG	No Limit

REMARKS:

- (1) Measurement Value = Reading Level + Correct Factor.
- (2) Margin Level = Measurement Value - Limit Value.

Test Mode	UNII-1_TX n (HT20) Mode 5180MHz	Tested Date	2019/5/9~11
Test Voltage	AC 120V/60Hz	Polarization	Horizontal

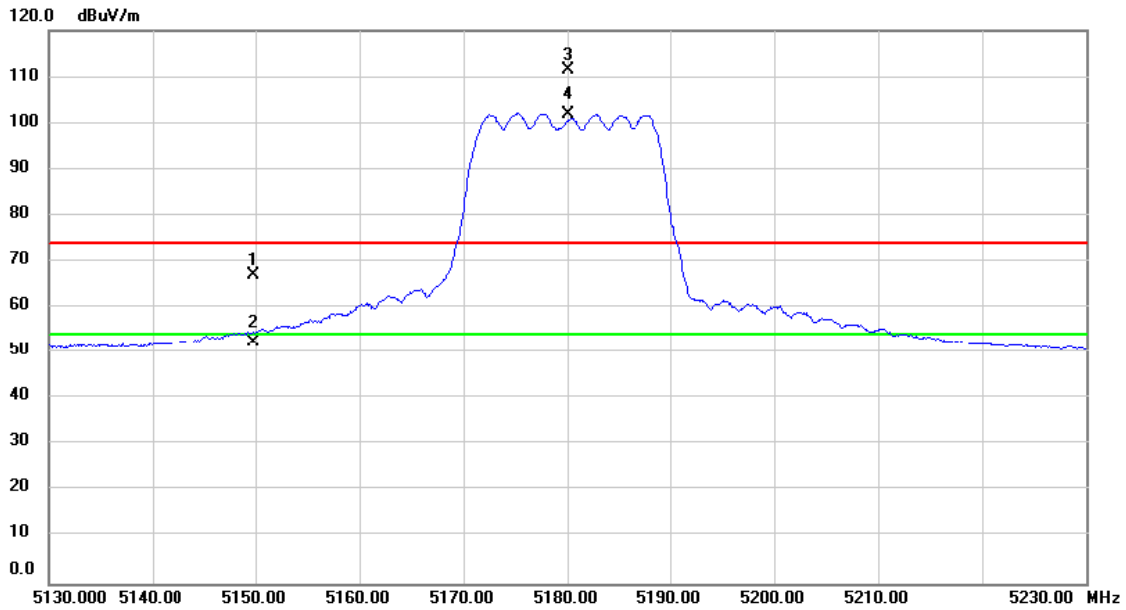

No.	Mk.	Freq. MHz	Reading Level dBuV	Correct Factor dB	Measure- ment dBuV/m	Limit dBuV/m	Over dB	Detector	Comment
1		5149.860	29.57	37.49	67.06	74.00	-6.94	peak	
2		5149.860	14.80	37.49	52.29	54.00	-1.71	AVG	
3	X	5180.000	73.80	37.55	111.35	74.00	37.35	peak	No Limit
4	*	5180.000	64.29	37.55	101.84	54.00	47.84	AVG	No Limit

REMARKS:

- (1) Measurement Value = Reading Level + Correct Factor.
- (2) Margin Level = Measurement Value - Limit Value.

Test Mode	UNII-1_TX n (HT20) Mode 5200MHz	Tested Date	2019/5/9~11
Test Voltage	AC 120V/60Hz	Polarization	Vertical

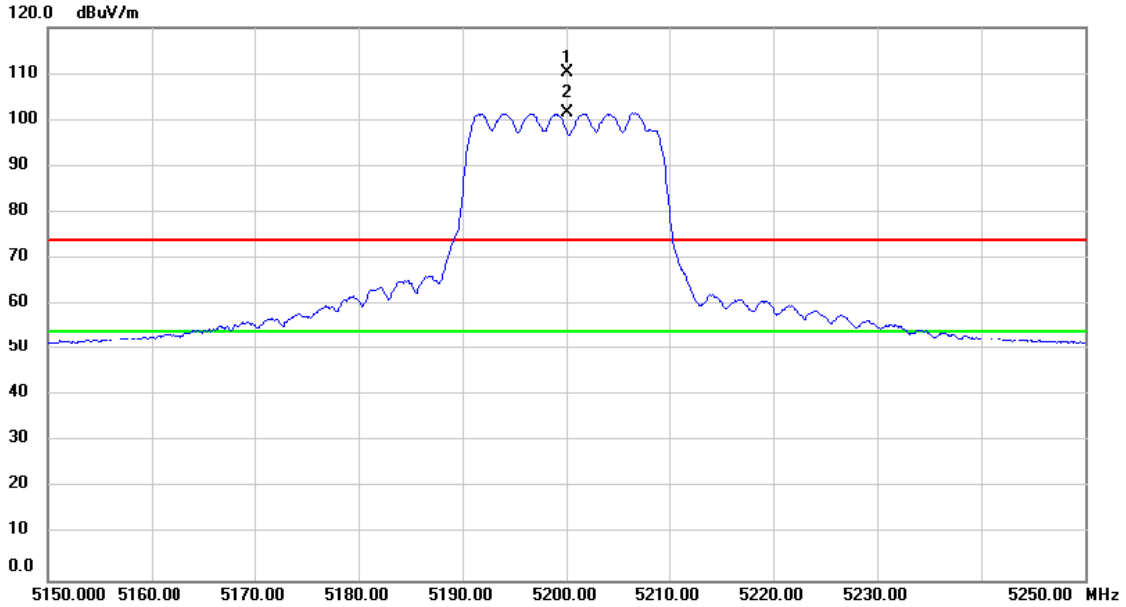

No.	Mk.	Freq. MHz	Reading Level dBuV	Correct Factor dB	Measure- ment dBuV/m	Limit dBuV/m	Over dB	Detector	Comment
1	X	5200.000	72.73	37.58	110.31	74.00	36.31	peak	No Limit
2	*	5200.000	64.01	37.58	101.59	54.00	47.59	AVG	No Limit

REMARKS:

- (1) Measurement Value = Reading Level + Correct Factor.
- (2) Margin Level = Measurement Value - Limit Value.

Test Mode	UNII-1_TX n (HT20) Mode 5200MHz	Tested Date	2019/5/9~11
Test Voltage	AC 120V/60Hz	Polarization	Horizontal

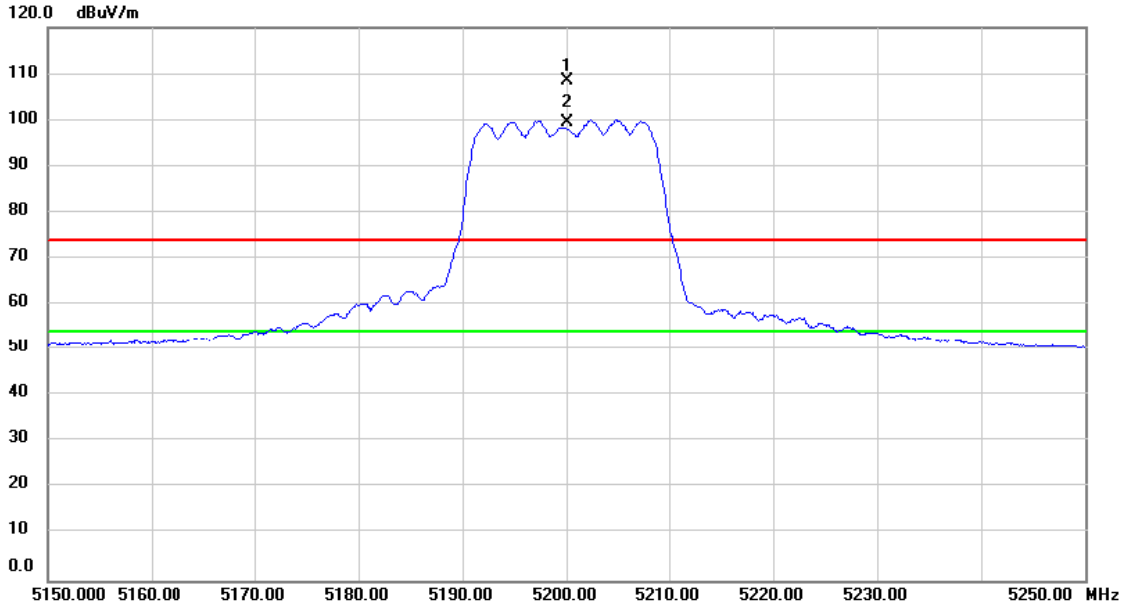

No.	Mk.	Freq.	Reading Level	Correct Factor	Measurement	Limit	Over	Detector	Comment
		MHz	dBuV	dB	dBuV/m	dBuV/m	dB		
1	X	5200.000	70.84	37.58	108.42	74.00	34.42	peak	No Limit
2	*	5200.000	62.02	37.58	99.60	54.00	45.60	AVG	No Limit

REMARKS:

- (1) Measurement Value = Reading Level + Correct Factor.
- (2) Margin Level = Measurement Value - Limit Value.

Test Mode	UNII-1_TX n (HT20) Mode 5240MHz	Tested Date	2019/5/9~11
Test Voltage	AC 120V/60Hz	Polarization	Vertical

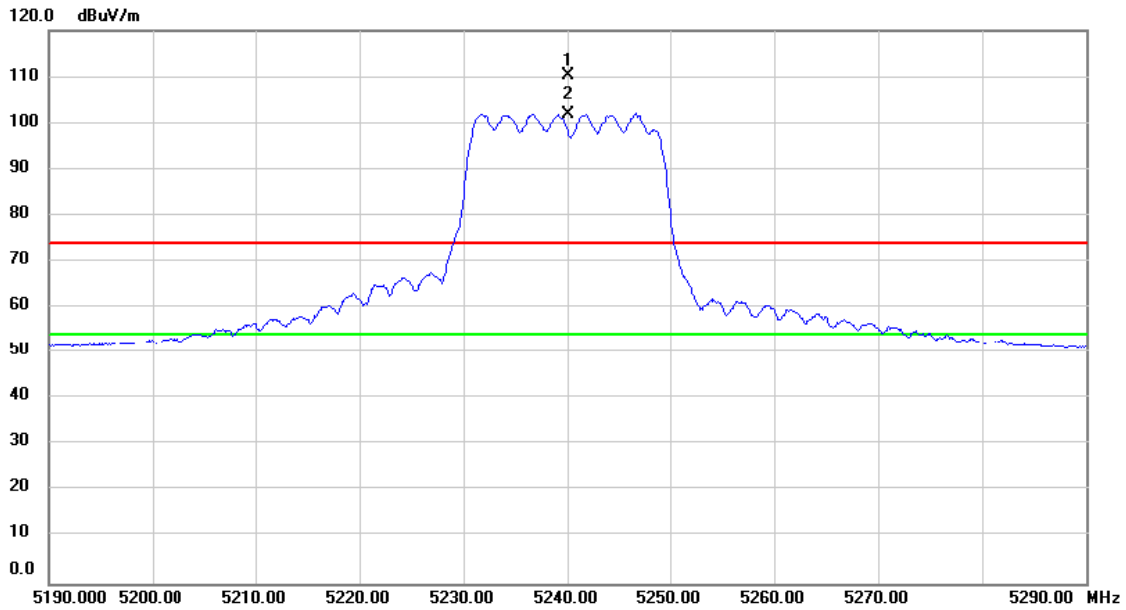

No.	Mk.	Freq. MHz	Reading Level dBuV	Correct Factor dB	Measure- ment dBuV/m	Limit dBuV/m	Over dB	Detector	Comment
1	X	5240.000	72.72	37.65	110.37	74.00	36.37	peak	No Limit
2	*	5240.000	64.30	37.65	101.95	54.00	47.95	AVG	No Limit

REMARKS:

- (1) Measurement Value = Reading Level + Correct Factor.
- (2) Margin Level = Measurement Value - Limit Value.

Test Mode	UNII-1_TX n (HT20) Mode 5240MHz	Tested Date	2019/5/9~11
Test Voltage	AC 120V/60Hz	Polarization	Horizontal

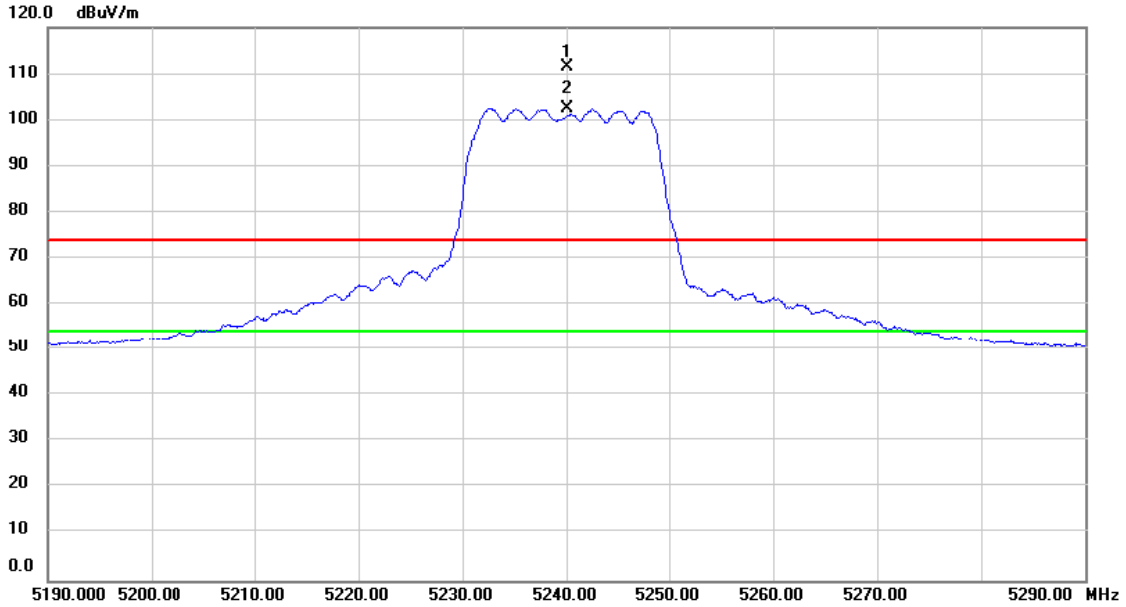

No.	Mk.	Freq. MHz	Reading Level dBuV	Correct Factor dB	Measure- ment dBuV/m	Limit dBuV/m	Over dB	Detector	Comment
1	X	5240.000	73.80	37.65	111.45	74.00	37.45	peak	No Limit
2	*	5240.000	64.77	37.65	102.42	54.00	48.42	AVG	No Limit

REMARKS:

- (1) Measurement Value = Reading Level + Correct Factor.
- (2) Margin Level = Measurement Value - Limit Value.

Test Mode	UNII-1_TX ac (VHT40) Mode 5190MHz	Tested Date	2019/5/9~11
Test Voltage	AC 120V/60Hz	Polarization	Vertical

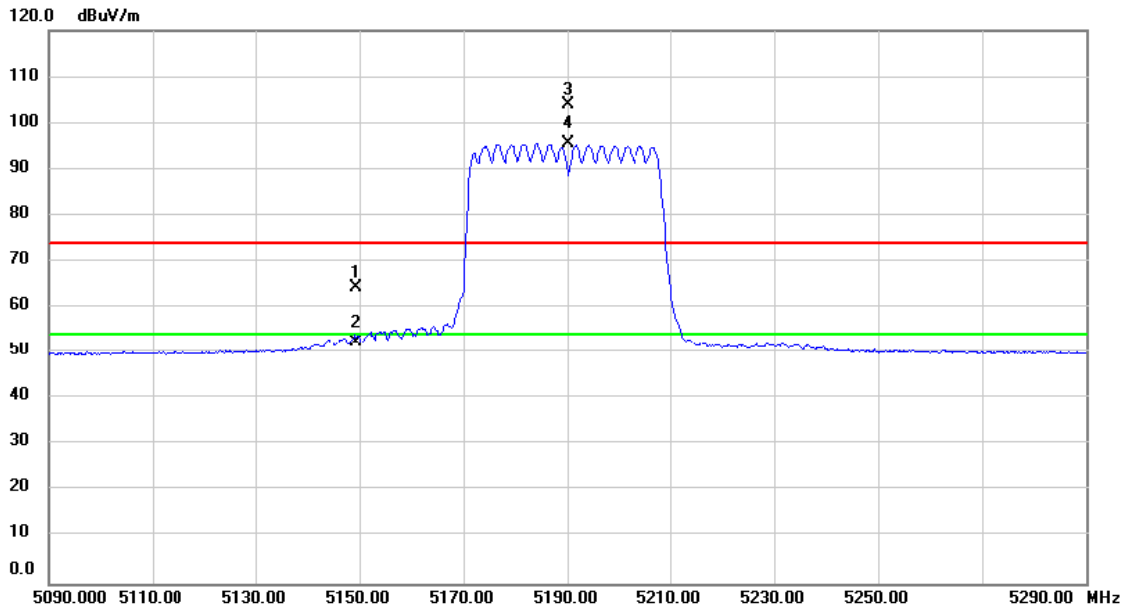

No.	Mk.	Freq. MHz	Reading Level dBuV	Correct Factor dB	Measure- ment dBuV/m	Limit dBuV/m	Over dB	Detector	Comment
1		5149.340	26.81	37.49	64.30	74.00	-9.70	peak	
2		5149.340	14.77	37.49	52.26	54.00	-1.74	AVG	
3	X	5190.000	66.33	37.56	103.89	74.00	29.89	peak	No Limit
4	*	5190.000	57.94	37.56	95.50	54.00	41.50	AVG	No Limit

REMARKS:

- (1) Measurement Value = Reading Level + Correct Factor.
- (2) Margin Level = Measurement Value - Limit Value.

Test Mode	UNII-1_TX ac (VHT40) Mode 5190MHz	Tested Date	2019/5/9~11
Test Voltage	AC 120V/60Hz	Polarization	Horizontal

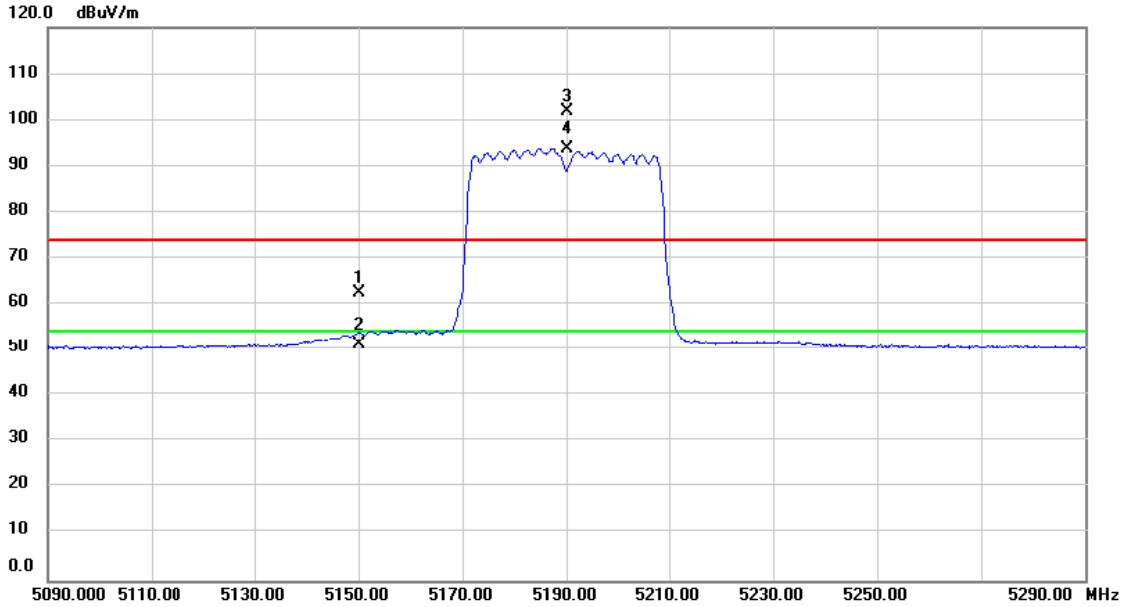

No.	Mk.	Freq. MHz	Reading Level dBuV	Correct Factor dB	Measure- ment dBuV/m	Limit dBuV/m	Over dB	Detector	Comment
1		5150.000	24.94	37.50	62.44	74.00	-11.56	peak	
2		5150.000	13.55	37.50	51.05	54.00	-2.95	AVG	
3	X	5190.000	64.33	37.56	101.89	74.00	27.89	peak	No Limit
4	*	5190.000	56.21	37.56	93.77	54.00	39.77	AVG	No Limit

REMARKS:

- (1) Measurement Value = Reading Level + Correct Factor.
- (2) Margin Level = Measurement Value - Limit Value.

Test Mode	UNII-1_TX ac (VHT40) Mode 5230MHz	Tested Date	2019/5/9~11
Test Voltage	AC 120V/60Hz	Polarization	Vertical

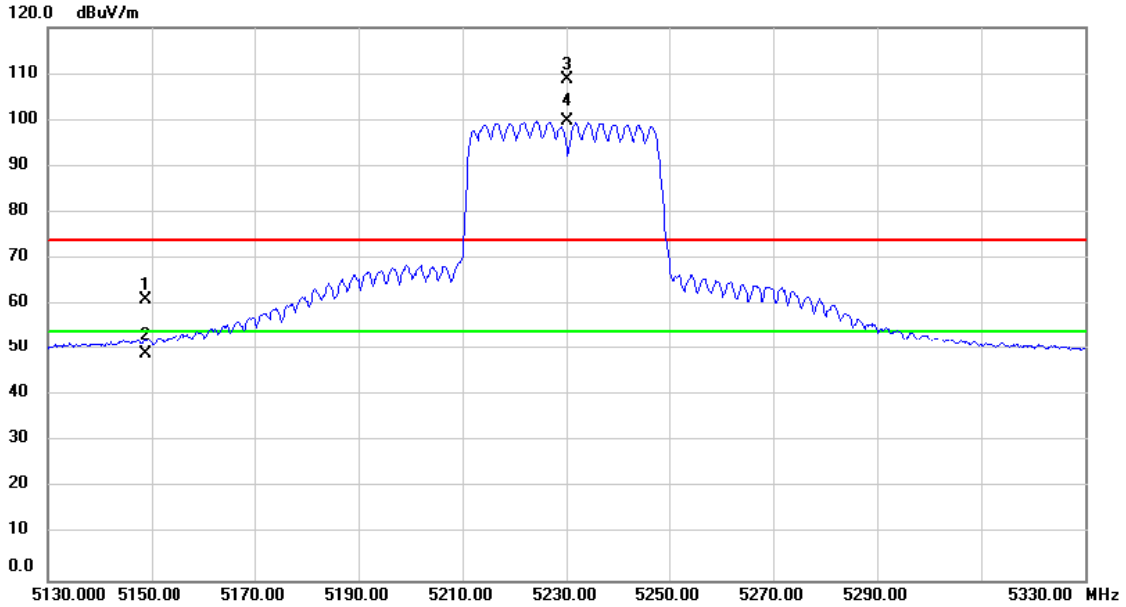

No.	Mk.	Freq. MHz	Reading Level dBuV	Correct Factor dB	Measure- ment dBuV/m	Limit dBuV/m	Over dB	Detector	Comment
1		5148.760	23.56	37.49	61.05	74.00	-12.95	peak	
2		5148.760	11.61	37.49	49.10	54.00	-4.90	AVG	
3	X	5230.000	71.17	37.64	108.81	74.00	34.81	peak	No Limit
4	*	5230.000	62.03	37.64	99.67	54.00	45.67	AVG	No Limit

REMARKS:

- (1) Measurement Value = Reading Level + Correct Factor.
- (2) Margin Level = Measurement Value - Limit Value.

Test Mode	UNII-1_TX ac (VHT40) Mode 5230MHz	Tested Date	2019/5/9~11
Test Voltage	AC 120V/60Hz	Polarization	Horizontal

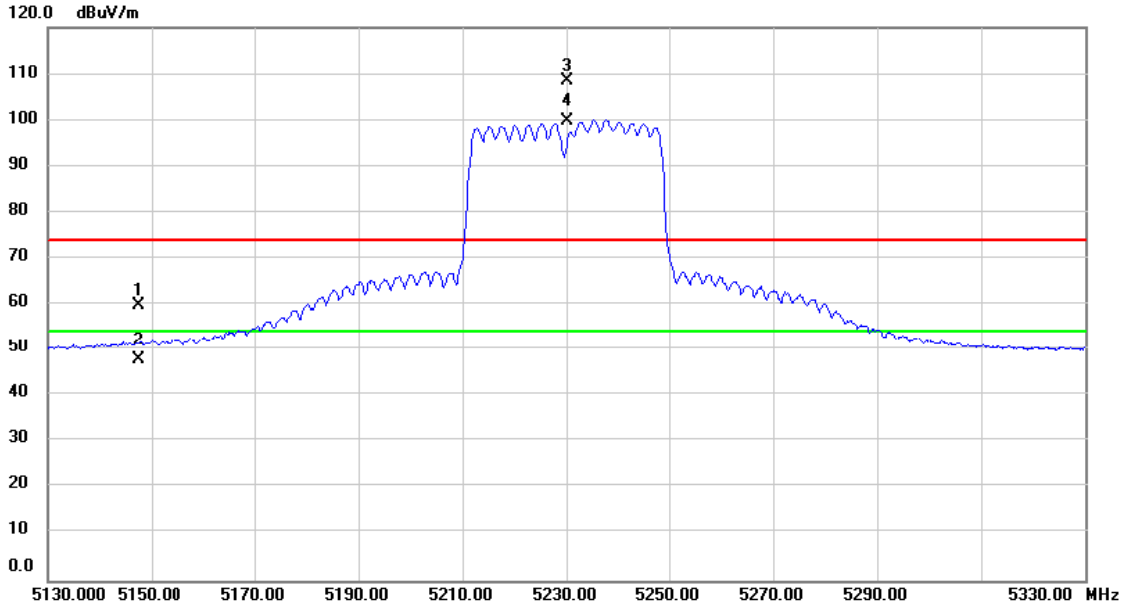

No.	Mk.	Freq. MHz	Reading Level dBuV	Correct Factor dB	Measure- ment dBuV/m	Limit dBuV/m	Over dB	Detector	Comment
1		5147.560	22.50	37.49	59.99	74.00	-14.01	peak	
2		5147.560	10.32	37.49	47.81	54.00	-6.19	AVG	
3	X	5230.000	70.71	37.64	108.35	74.00	34.35	peak	No Limit
4	*	5230.000	62.18	37.64	99.82	54.00	45.82	AVG	No Limit

REMARKS:

- (1) Measurement Value = Reading Level + Correct Factor.
- (2) Margin Level = Measurement Value - Limit Value.

Test Mode	UNII-1_TX ac (VHT80) Mode 5210MHz	Tested Date	2019/5/9~11
Test Voltage	AC 120V/60Hz	Polarization	Vertical

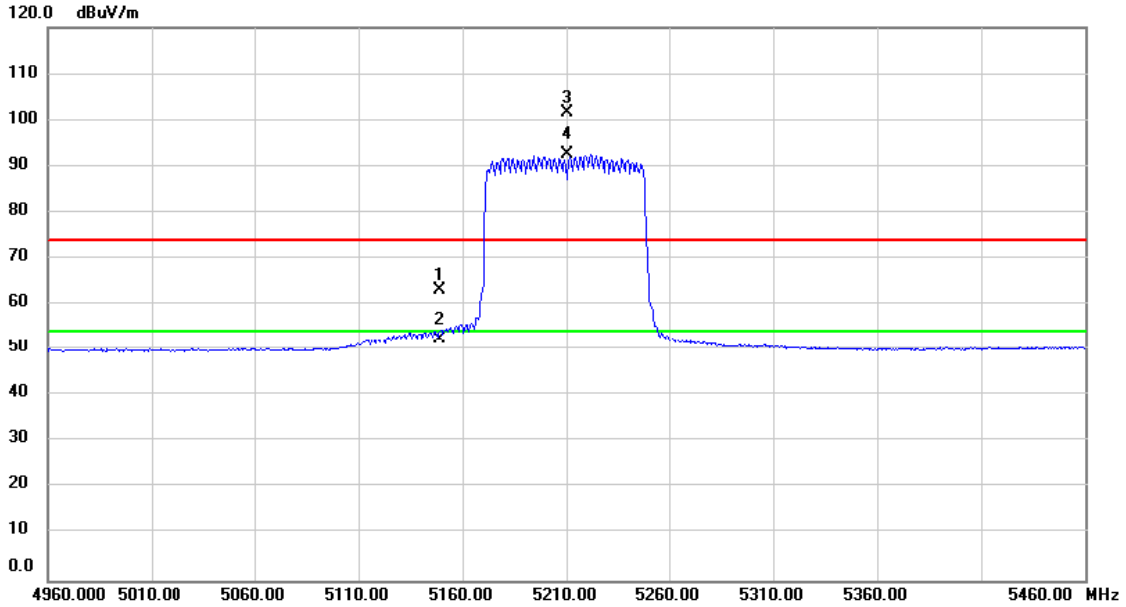

No.	Mk.	Freq. MHz	Reading Level dBuV	Correct Factor dB	Measure- ment dBuV/m	Limit dBuV/m	Over dB	Detector	Comment
1		5148.860	25.70	37.49	63.19	74.00	-10.81	peak	
2		5148.860	14.96	37.49	52.45	54.00	-1.55	AVG	
3	X	5210.000	64.03	37.60	101.63	74.00	27.63	peak	No Limit
4	*	5210.000	54.94	37.60	92.54	54.00	38.54	AVG	No Limit

REMARKS:

- (1) Measurement Value = Reading Level + Correct Factor.
- (2) Margin Level = Measurement Value - Limit Value.

Test Mode	UNII-1_TX ac (VHT80) Mode 5210MHz	Tested Date	2019/5/9~11
Test Voltage	AC 120V/60Hz	Polarization	Horizontal

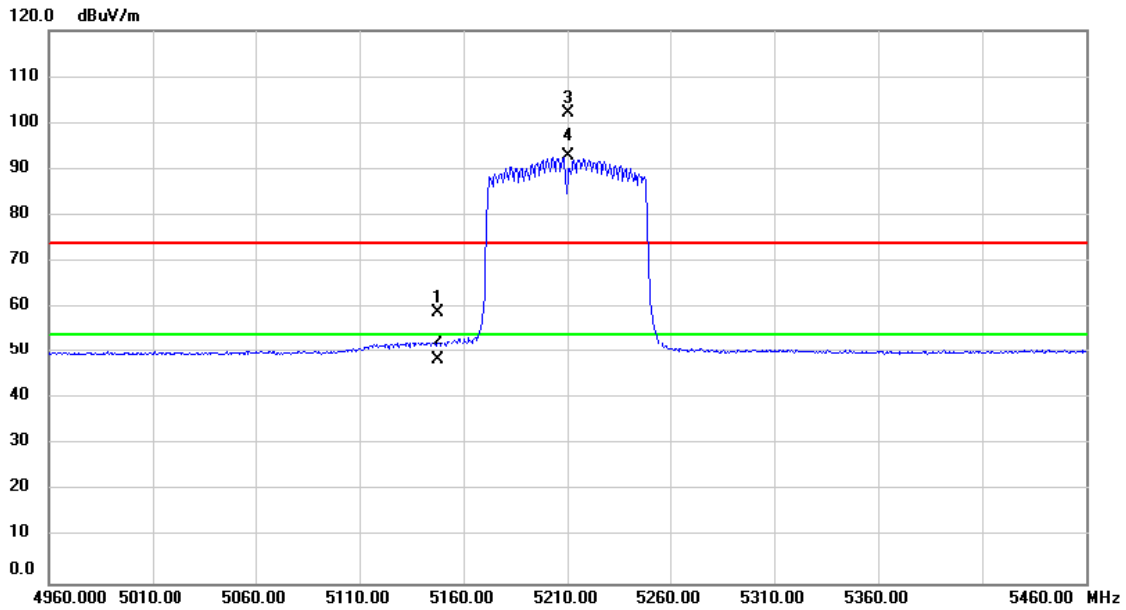

No.	Mk.	Freq. MHz	Reading Level dBuV	Correct Factor dB	Measure- ment dBuV/m	Limit dBuV/m	Over dB	Detector	Comment
1		5147.910	21.47	37.49	58.96	74.00	-15.04	peak	
2		5147.910	11.09	37.49	48.58	54.00	-5.42	AVG	
3	X	5210.000	64.43	37.60	102.03	74.00	28.03	peak	No Limit
4	*	5210.000	55.33	37.60	92.93	54.00	38.93	AVG	No Limit

REMARKS:

- (1) Measurement Value = Reading Level + Correct Factor.
- (2) Margin Level = Measurement Value - Limit Value.

Test Mode	UNII-3_TX a Mode 5745MHz	Tested Date	2019/5/9~11
Test Voltage	AC 120V/60Hz	Polarization	Vertical

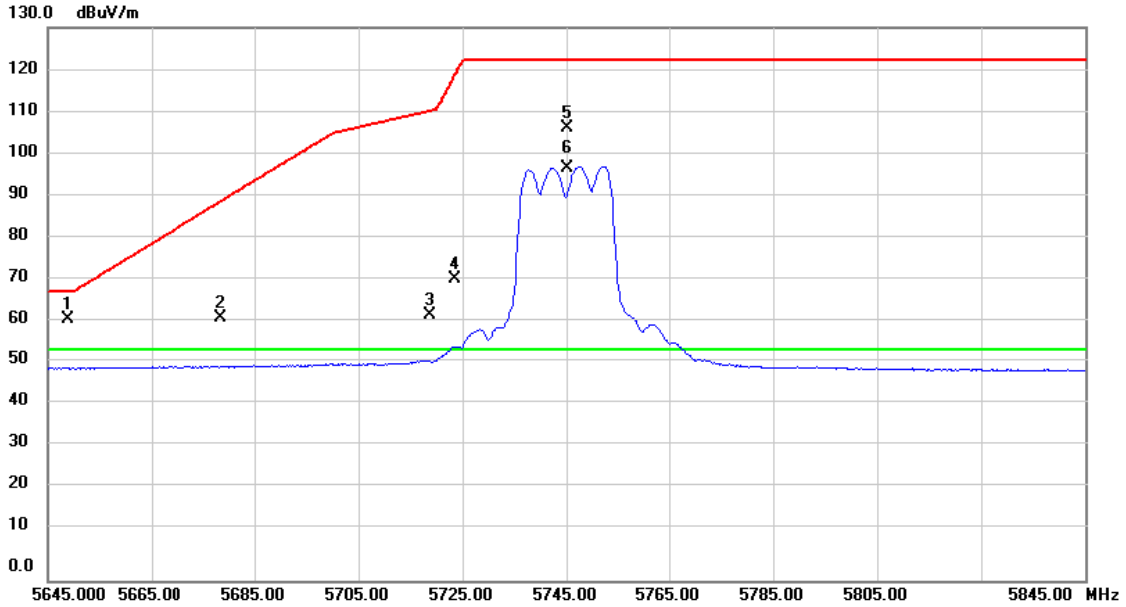

No.	Mk.	Freq.	Reading Level	Correct Factor	Measurement	Limit	Over	Detector	Comment
		MHz	dBuV	dB	dBuV/m	dBuV/m	dB		
1		5648.835	23.20	38.46	61.66	68.20	-6.54	peak	
2		5678.350	23.46	38.53	61.99	89.22	-27.23	peak	
3		5718.740	23.86	38.63	62.49	110.45	-47.96	peak	
4		5723.650	32.43	38.64	71.07	119.12	-48.05	peak	
5		5745.000	67.69	38.69	106.38	122.20	-15.82	peak	No Limit
6	*	5745.000	58.29	38.69	96.98	54.00	42.98	AVG	No Limit

REMARKS:

- (1) Measurement Value = Reading Level + Correct Factor.
- (2) Margin Level = Measurement Value - Limit Value.

Test Mode	UNII-3_TX a Mode 5745MHz	Tested Date	2019/5/9~11
Test Voltage	AC 120V/60Hz	Polarization	Horizontal

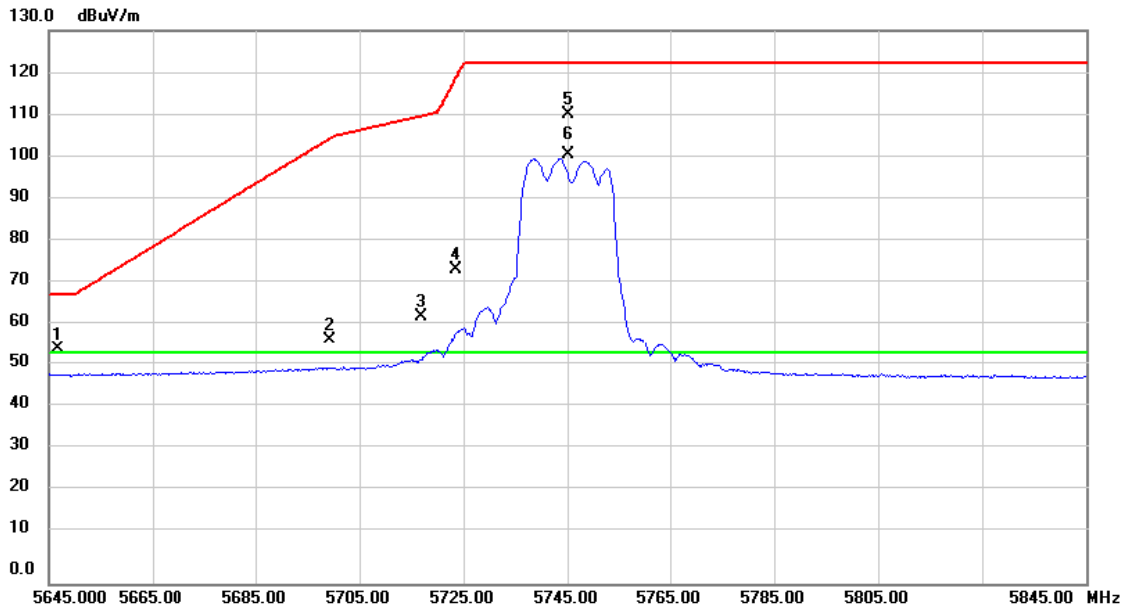

No.	Mk.	Freq.	Reading Level	Correct Factor	Measurement	Limit	Over	Detector	Comment
		MHz	dBuV	dB	dBuV/m	dBuV/m	dB		
1		5646.680	16.72	38.45	55.17	68.20	-13.03	peak	
2		5699.350	18.93	38.58	57.51	104.72	-47.21	peak	
3		5716.760	24.14	38.62	62.76	109.89	-47.13	peak	
4		5723.525	35.46	38.64	74.10	118.84	-44.74	peak	
5		5745.000	71.78	38.69	110.47	122.20	-11.73	peak	No Limit
6	*	5745.000	62.16	38.69	100.85	54.00	46.85	AVG	No Limit

REMARKS:

- (1) Measurement Value = Reading Level + Correct Factor.
- (2) Margin Level = Measurement Value - Limit Value.

Test Mode	UNII-3_TX a Mode 5785MHz	Tested Date	2019/5/9~11
Test Voltage	AC 120V/60Hz	Polarization	Vertical

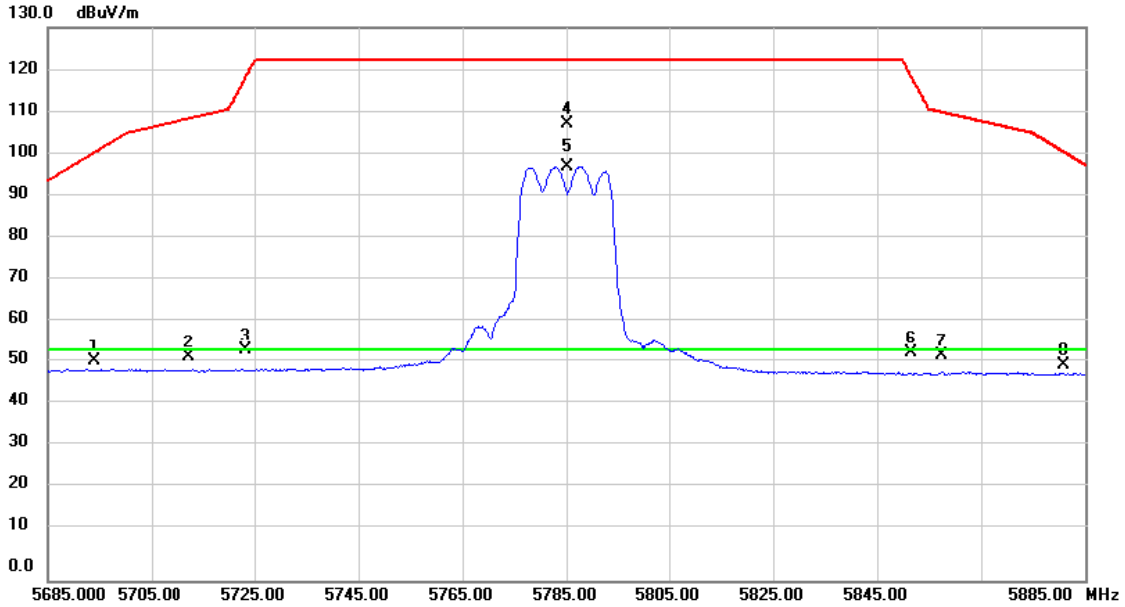

No.	Mk.	Freq. MHz	Reading Level dBuV	Correct Factor dB	Measure- ment dBuV/m	Limit dBuV/m	Over dB	Detector	Comment
1		5693.970	12.99	38.57	51.56	100.76	-49.20	peak	
2		5712.380	13.85	38.61	52.46	108.67	-56.21	peak	
3		5723.165	15.33	38.64	53.97	118.02	-64.05	peak	
4		5785.000	68.55	38.79	107.34	122.20	-14.86	peak	No Limit
5	*	5785.000	58.60	38.79	97.39	54.00	43.39	AVG	No Limit
6		5851.495	14.52	38.95	53.47	118.79	-65.32	peak	
7		5857.520	13.85	38.97	52.82	110.09	-57.27	peak	
8		5880.960	11.59	39.03	50.62	100.77	-50.15	peak	

REMARKS:

- (1) Measurement Value = Reading Level + Correct Factor.
- (2) Margin Level = Measurement Value - Limit Value.

Test Mode	UNII-3_TX a Mode 5785MHz	Tested Date	2019/5/9~11
Test Voltage	AC 120V/60Hz	Polarization	Horizontal

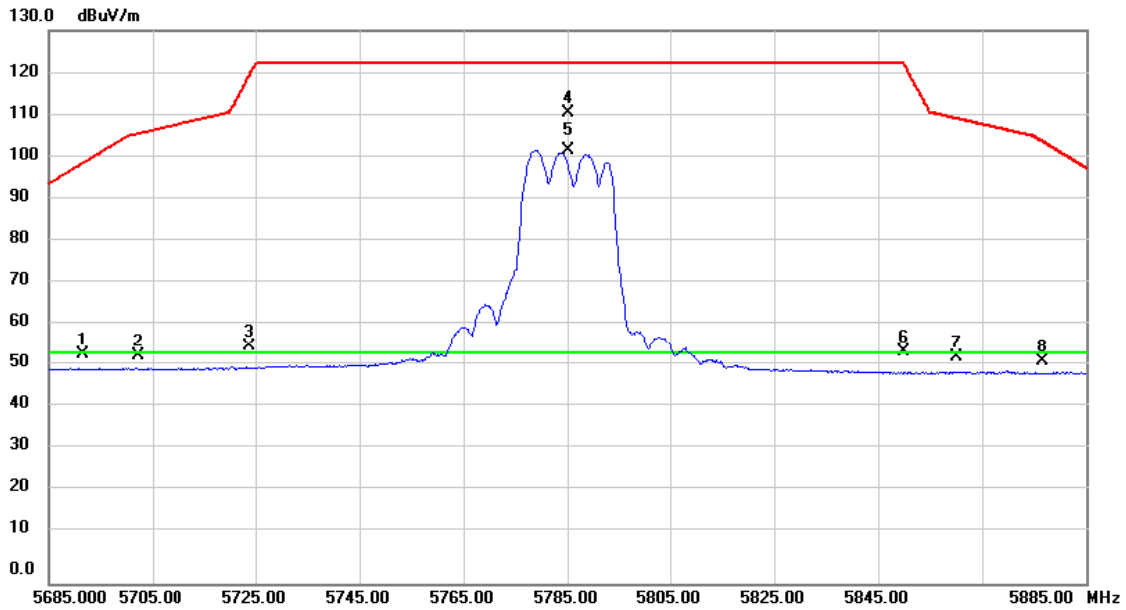

No.	Mk.	Freq. MHz	Reading Level dBuV	Correct Factor dB	Measure- ment dBuV/m	Limit dBuV/m	Over dB	Detector	Comment
1		5691.495	15.13	38.56	53.69	98.93	-45.24	peak	
2		5702.220	14.87	38.58	53.45	105.82	-52.37	peak	
3		5723.820	17.04	38.64	55.68	119.51	-63.83	peak	
4		5785.000	72.02	38.79	110.81	122.20	-11.39	peak	No Limit
5	*	5785.000	63.07	38.79	101.86	54.00	47.86	AVG	No Limit
6		5850.000	15.65	38.95	54.60	122.20	-67.60	peak	
7		5860.080	14.00	38.98	52.98	109.38	-56.40	peak	
8		5876.700	13.05	39.01	52.06	103.94	-51.88	peak	

REMARKS:

- (1) Measurement Value = Reading Level + Correct Factor.
- (2) Margin Level = Measurement Value - Limit Value.

Test Mode	UNII-3_TX a Mode 5825MHz	Tested Date	2019/5/9~11
Test Voltage	AC 120V/60Hz	Polarization	Vertical

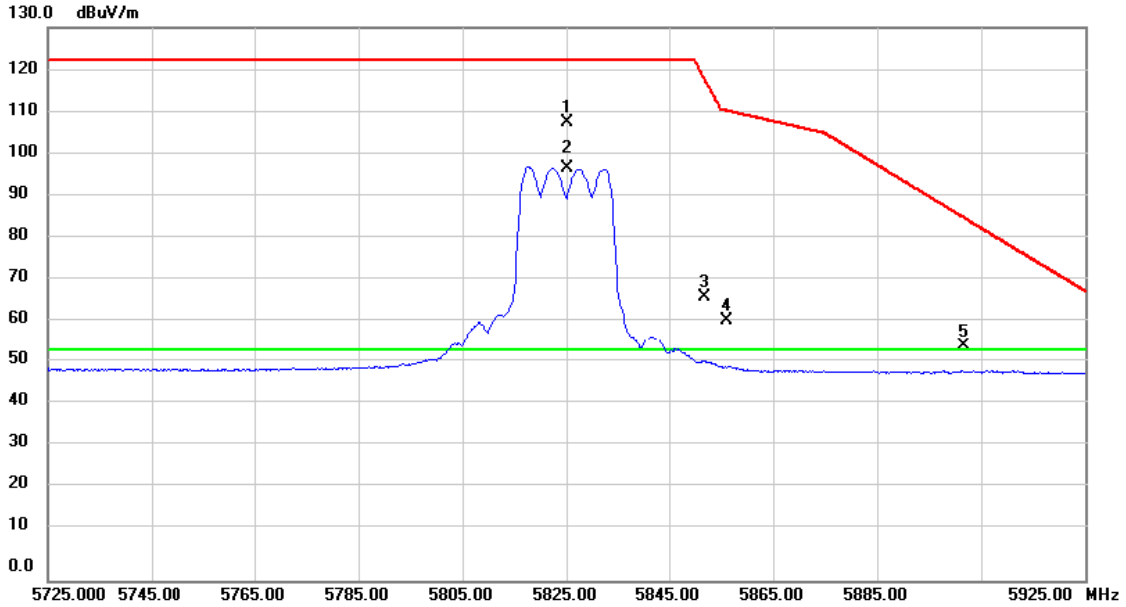

No.	Mk.	Freq. MHz	Reading Level dBuV	Correct Factor dB	Measure- ment dBuV/m	Limit dBuV/m	Over dB	Detector	Comment
1		5825.000	68.76	38.89	107.65	122.20	-14.55	peak	No Limit
2	*	5825.000	58.14	38.89	97.03	54.00	43.03	AVG	No Limit
3		5851.780	27.90	38.95	66.85	118.14	-51.29	peak	
4		5856.100	22.21	38.96	61.17	110.49	-49.32	peak	
5		5901.650	15.86	39.07	54.93	85.44	-30.51	peak	

REMARKS:

- (1) Measurement Value = Reading Level + Correct Factor.
- (2) Margin Level = Measurement Value - Limit Value.

Test Mode	UNII-3_TX a Mode 5825MHz	Tested Date	2019/5/9~11
Test Voltage	AC 120V/60Hz	Polarization	Horizontal

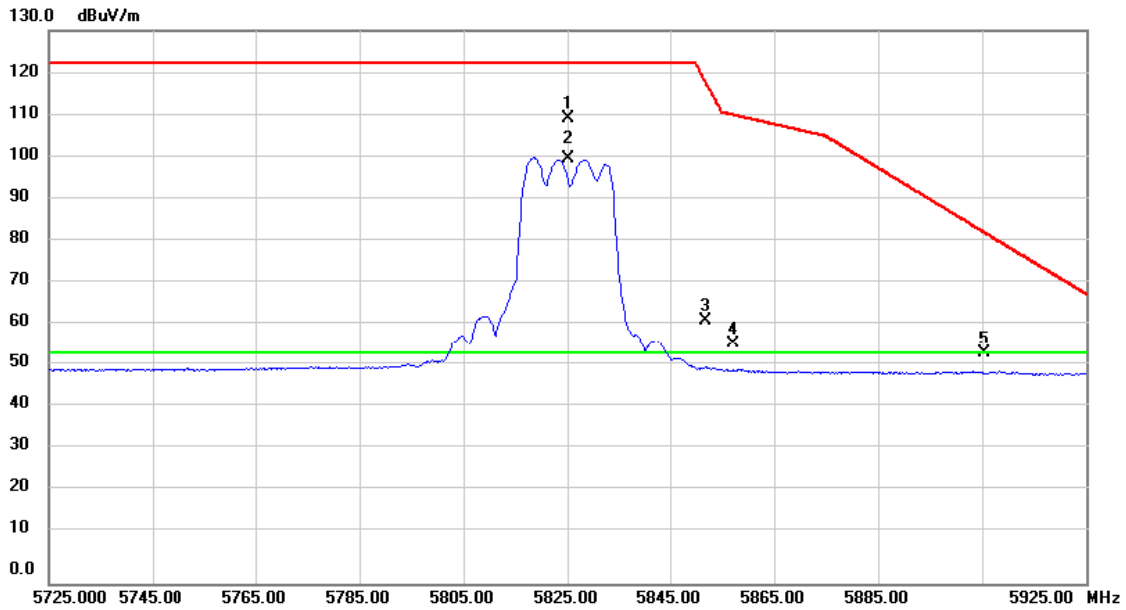

No.	Mk.	Freq. MHz	Reading Level dBuV	Correct Factor dB	Measure- ment dBuV/m	Limit dBuV/m	Over dB	Detector	Comment
1		5825.000	70.34	38.89	109.23	122.20	-12.97	peak	No Limit
2	*	5825.000	60.94	38.89	99.83	54.00	45.83	AVG	No Limit
3		5851.685	22.99	38.95	61.94	118.36	-56.42	peak	
4		5857.240	17.32	38.96	56.28	110.17	-53.89	peak	
5		5905.500	15.15	39.09	54.24	82.59	-28.35	peak	

REMARKS:

- (1) Measurement Value = Reading Level + Correct Factor.
- (2) Margin Level = Measurement Value - Limit Value.

Test Mode	UNII-3_TX n (HT20) Mode 5745MHz	Tested Date	2019/5/9~11
Test Voltage	AC 120V/60Hz	Polarization	Vertical

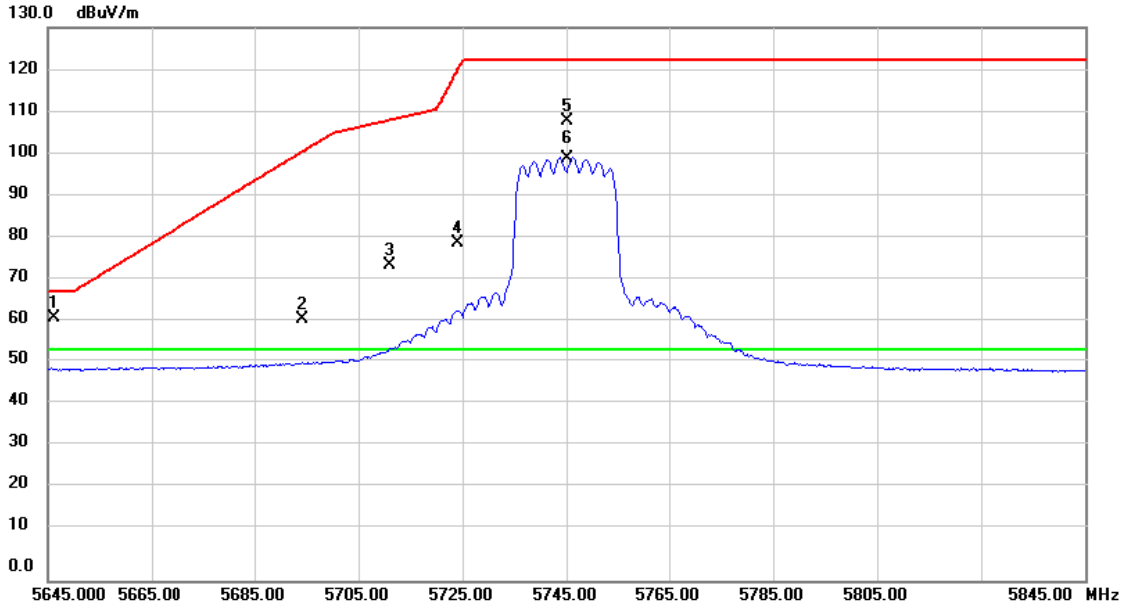

No.	Mk.	Freq. MHz	Reading Level dBuV	Correct Factor dB	Measure- ment dBuV/m	Limit dBuV/m	Over dB	Detector	Comment
1		5646.135	23.61	38.45	62.06	68.20	-6.14	peak	
2		5694.200	22.99	38.57	61.56	100.92	-39.36	peak	
3		5711.100	35.60	38.61	74.21	108.31	-34.10	peak	
4		5724.135	40.73	38.64	79.37	120.23	-40.86	peak	
5		5745.000	69.46	38.69	108.15	122.20	-14.05	peak	No Limit
6	*	5745.000	60.61	38.69	99.30	54.00	45.30	AVG	No Limit

REMARKS:

- (1) Measurement Value = Reading Level + Correct Factor.
- (2) Margin Level = Measurement Value - Limit Value.

Test Mode	UNII-3_TX n (HT20) Mode 5745MHz	Tested Date	2019/5/9~11
Test Voltage	AC 120V/60Hz	Polarization	Horizontal

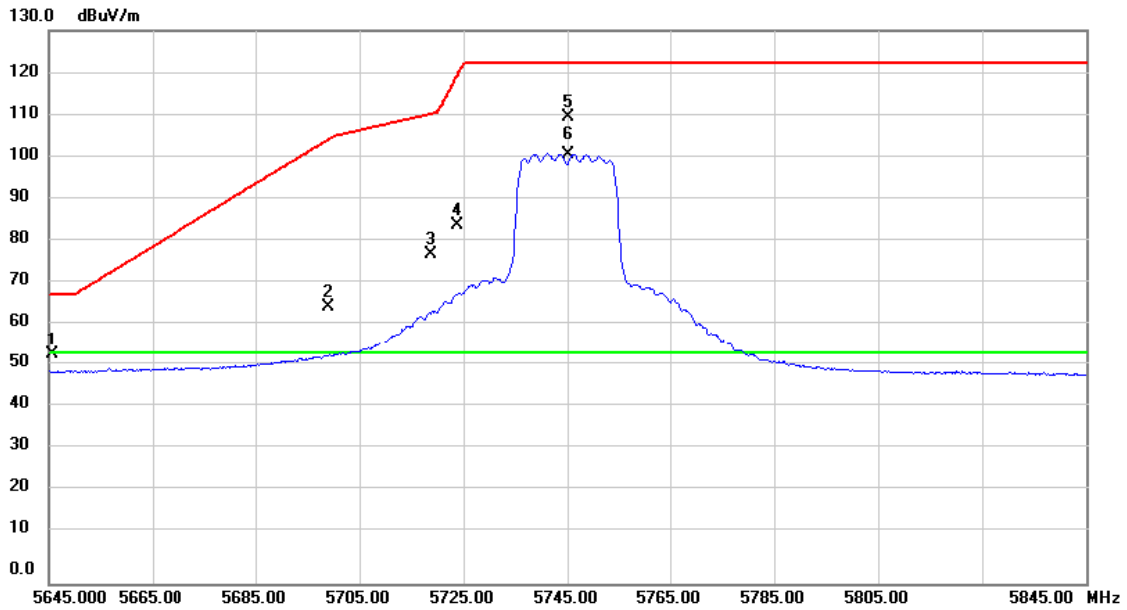

No.	Mk.	Freq. MHz	Reading Level dBuV	Correct Factor dB	Measure- ment dBuV/m	Limit dBuV/m	Over dB	Detector	Comment
1		5645.700	15.31	38.45	53.76	68.20	-14.44	peak	
2		5699.000	26.57	38.58	65.15	104.46	-39.31	peak	
3		5718.700	38.99	38.63	77.62	110.44	-32.82	peak	
4		5723.780	45.85	38.64	84.49	119.42	-34.93	peak	
5		5745.000	71.16	38.69	109.85	122.20	-12.35	peak	No Limit
6	*	5745.000	62.27	38.69	100.96	54.00	46.96	AVG	No Limit

REMARKS:

- (1) Measurement Value = Reading Level + Correct Factor.
- (2) Margin Level = Measurement Value - Limit Value.

Test Mode	UNII-3_TX n (HT20) Mode 5785MHz	Tested Date	2019/5/9~11
Test Voltage	AC 120V/60Hz	Polarization	Vertical

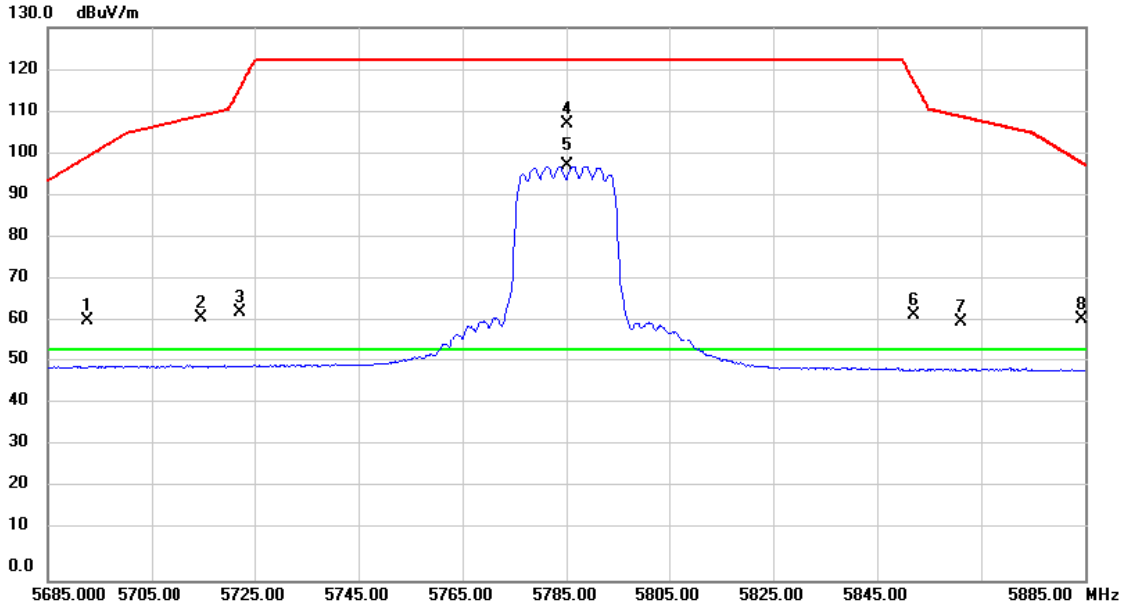

No.	Mk.	Freq. MHz	Reading Level dBuV	Correct Factor dB	Measure- ment dBuV/m	Limit dBuV/m	Over dB	Detector	Comment
1		5692.725	22.82	38.57	61.39	99.84	-38.45	peak	
2		5714.600	23.29	38.62	61.91	109.29	-47.38	peak	
3		5722.255	24.45	38.63	63.08	115.94	-52.86	peak	
4		5785.000	68.69	38.79	107.48	122.20	-14.72	peak	No Limit
5	*	5785.000	58.82	38.79	97.61	54.00	43.61	AVG	No Limit
6		5852.145	23.67	38.95	62.62	117.31	-54.69	peak	
7		5861.220	22.08	38.98	61.06	109.06	-48.00	peak	
8		5884.230	22.43	39.04	61.47	98.35	-36.88	peak	

REMARKS:

- (1) Measurement Value = Reading Level + Correct Factor.
- (2) Margin Level = Measurement Value - Limit Value.

Test Mode	UNII-3_TX n (HT20) Mode 5785MHz	Tested Date	2019/5/9~11
Test Voltage	AC 120V/60Hz	Polarization	Horizontal

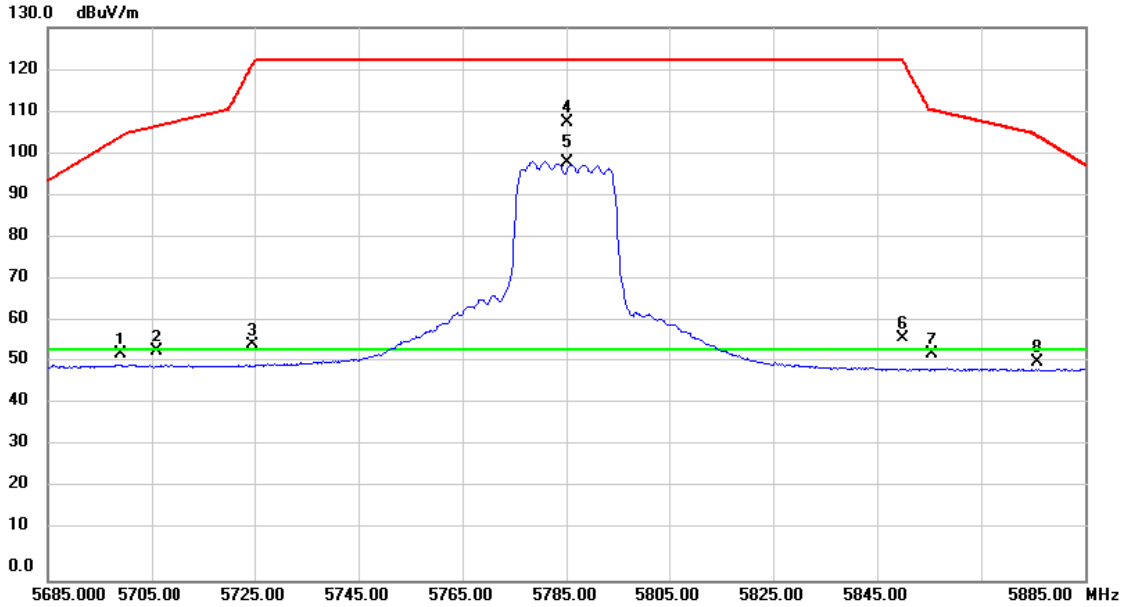

No.	Mk.	Freq. MHz	Reading Level dBuV	Correct Factor dB	Measure- ment dBuV/m	Limit dBuV/m	Over dB	Detector	Comment
1		5699.050	14.45	38.58	53.03	104.50	-51.47	peak	
2		5706.060	15.25	38.59	53.84	106.90	-53.06	peak	
3		5724.590	16.83	38.64	55.47	121.27	-65.80	peak	
4		5785.000	68.88	38.79	107.67	122.20	-14.53	peak	No Limit
5	*	5785.000	59.64	38.79	98.43	54.00	44.43	AVG	No Limit
6		5850.000	17.99	38.95	56.94	122.20	-65.26	peak	
7		5855.440	14.18	38.96	53.14	110.68	-57.54	peak	
8		5875.790	12.09	39.01	51.10	104.61	-53.51	peak	

REMARKS:

- (1) Measurement Value = Reading Level + Correct Factor.
- (2) Margin Level = Measurement Value - Limit Value.

Test Mode	UNII-3_TX n (HT20)Mode 5825MHz	Tested Date	2019/5/9~11
Test Voltage	AC 120V/60Hz	Polarization	Vertical

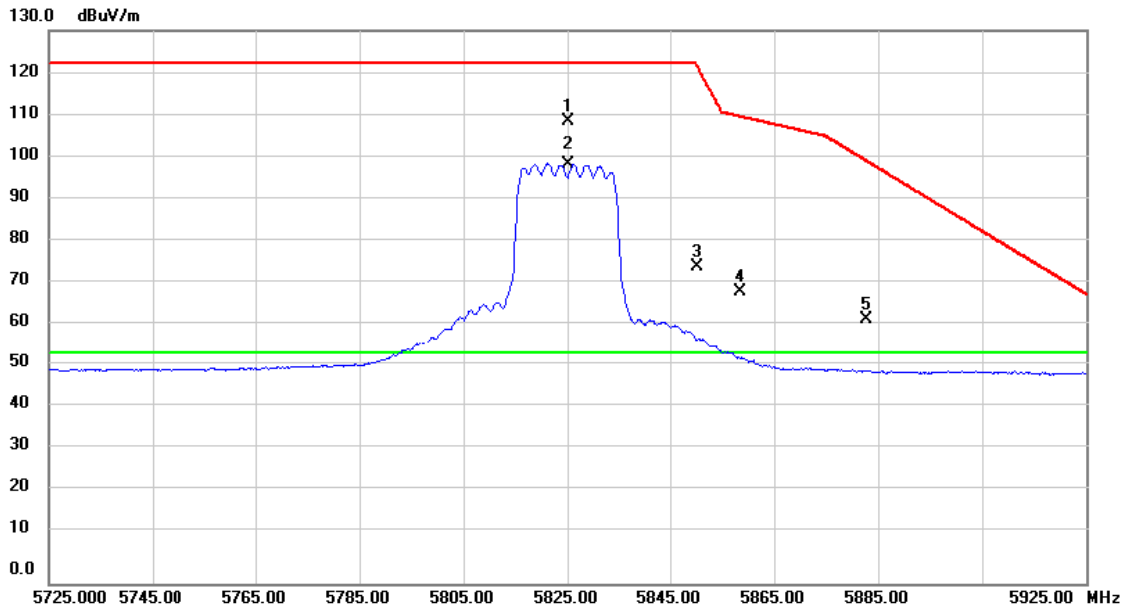

No.	Mk.	Freq. MHz	Reading Level dBuV	Correct Factor dB	Measure- ment dBuV/m	Limit dBuV/m	Over dB	Detector	Comment
1		5825.000	69.85	38.89	108.74	122.20	-13.46	peak	No Limit
2	*	5825.000	59.68	38.89	98.57	54.00	44.57	AVG	No Limit
3		5850.235	35.79	38.95	74.74	121.66	-46.92	peak	
4		5858.500	29.88	38.97	68.85	109.82	-40.97	peak	
5		5882.700	23.28	39.04	62.32	99.48	-37.16	peak	

REMARKS:

- (1) Measurement Value = Reading Level + Correct Factor.
- (2) Margin Level = Measurement Value - Limit Value.

Test Mode	UNII-3_TX n (HT20)Mode 5825MHz	Tested Date	2019/5/9~11
Test Voltage	AC 120V/60Hz	Polarization	Horizontal

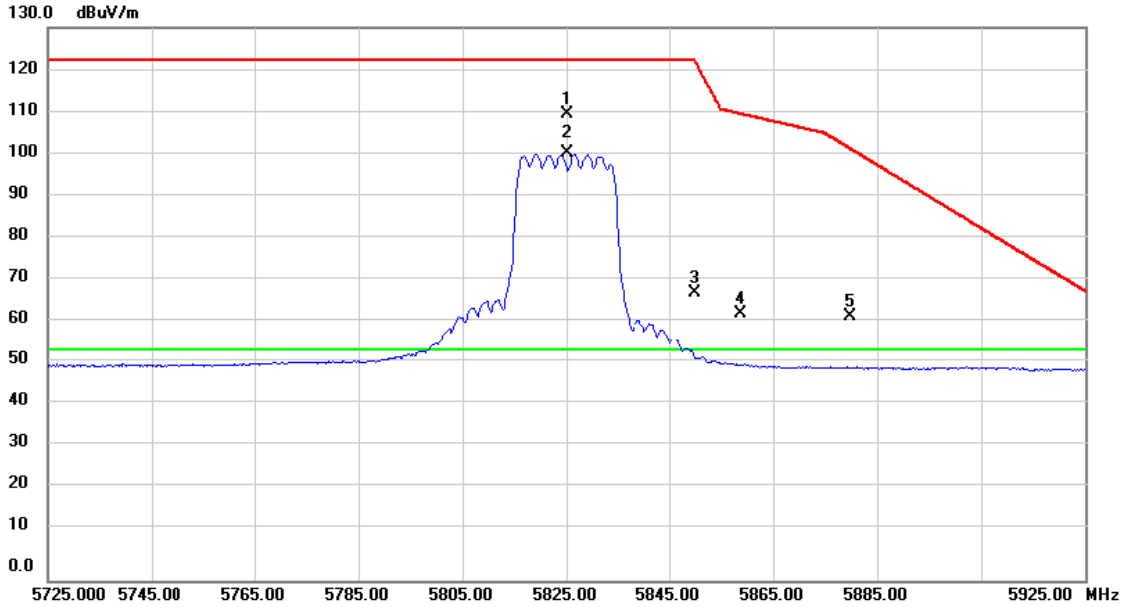

No.	Mk.	Freq. MHz	Reading Level dBuV	Correct Factor dB	Measure- ment dBuV/m	Limit dBuV/m	Over dB	Detector	Comment
1		5825.000	70.71	38.89	109.60	122.20	-12.60	peak	No Limit
2	*	5825.000	61.54	38.89	100.43	54.00	46.43	AVG	No Limit
3		5850.020	28.70	38.95	67.65	122.15	-54.50	peak	
4		5858.660	23.91	38.97	62.88	109.77	-46.89	peak	
5		5879.900	23.22	39.02	62.24	101.56	-39.32	peak	

REMARKS:

- (1) Measurement Value = Reading Level + Correct Factor.
- (2) Margin Level = Measurement Value - Limit Value.

Test Mode	UNII-3_TX ac (VHT40) Mode 5755MHz	Tested Date	2019/5/9~11
Test Voltage	AC 120V/60Hz	Polarization	Vertical

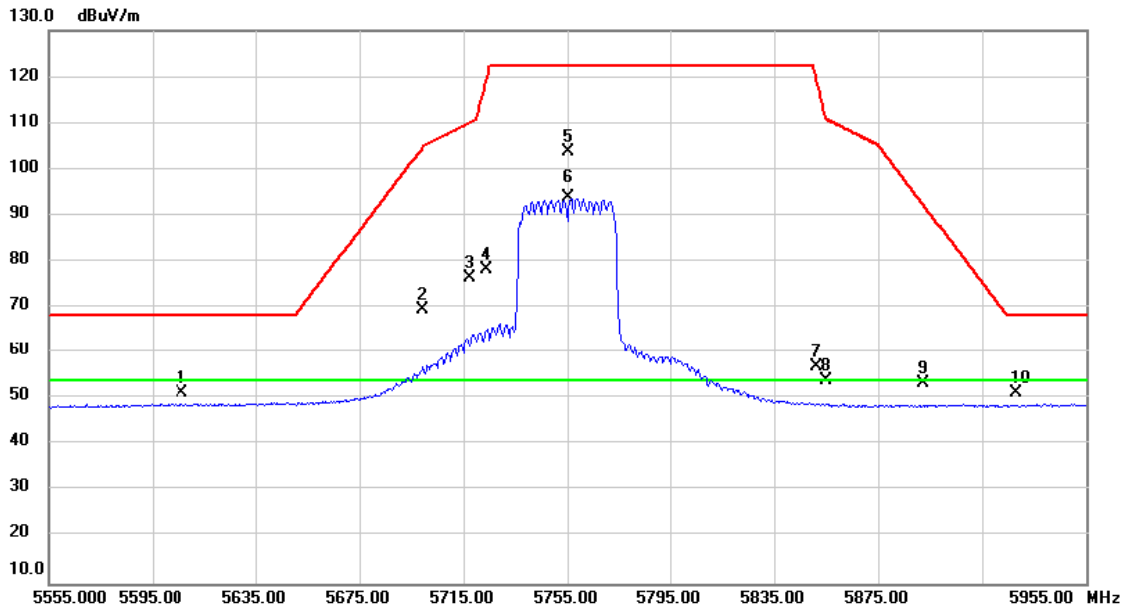

No. Mk.	Freq. MHz	Reading Level dBuV	Correct Factor dB	Measurement dBuV/m	Limit dBuV/m	Over dB	Detector	Comment
1	5606.680	12.98	38.35	51.33	68.20	-16.87	peak	
2	5699.150	30.90	38.58	69.48	104.57	-35.09	peak	
3	5717.540	37.82	38.63	76.45	110.11	-33.66	peak	
4	5723.790	39.54	38.64	78.18	119.44	-41.26	peak	
5	5755.000	65.04	38.72	103.76	122.20	-18.44	peak	No Limit
6 *	5755.000	55.09	38.72	93.81	54.00	39.81	AVG	No Limit
7	5851.145	18.00	38.95	56.95	119.59	-62.64	peak	
8	5855.220	15.04	38.96	54.00	110.74	-56.74	peak	
9	5892.450	14.24	39.05	53.29	92.25	-38.96	peak	
10	5928.180	12.09	39.15	51.24	68.20	-16.96	peak	

REMARKS:

- (1) Measurement Value = Reading Level + Correct Factor.
- (2) Margin Level = Measurement Value - Limit Value.

Test Mode	UNII-3_TX ac (VHT40) Mode 5755MHz	Tested Date	2019/5/9~11
Test Voltage	AC 120V/60Hz	Polarization	Horizontal

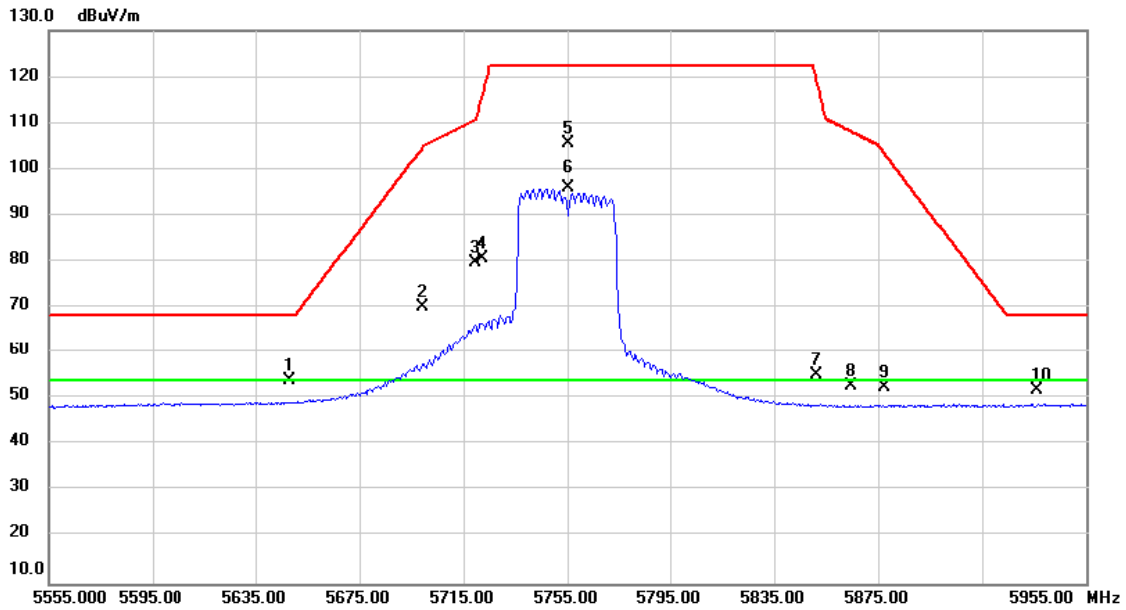

No. Mk.	Freq. MHz	Reading Level dBuV	Correct Factor dB	Measurement dBuV/m	Limit dBuV/m	Over dB	Detector	Comment
1	5648.100	15.61	38.46	54.07	68.20	-14.13	peak	
2	5699.200	31.61	38.58	70.19	104.61	-34.42	peak	
3	5719.700	41.01	38.63	79.64	110.72	-31.08	peak	
4	5722.000	42.00	38.63	80.63	115.36	-34.73	peak	
5	5755.000	66.86	38.72	105.58	122.20	-16.62	peak	No Limit
6 *	5755.000	57.21	38.72	95.93	54.00	41.93	AVG	No Limit
7	5851.510	16.28	38.95	55.23	118.76	-63.53	peak	
8	5864.680	13.73	38.99	52.72	108.09	-55.37	peak	
9	5877.300	13.57	39.01	52.58	103.49	-50.91	peak	
10	5936.280	12.71	39.16	51.87	68.20	-16.33	peak	

REMARKS:

- (1) Measurement Value = Reading Level + Correct Factor.
- (2) Margin Level = Measurement Value - Limit Value.

Test Mode	UNII-3_TX ac (VHT40) Mode 5795MHz	Tested Date	2019/5/9~11
Test Voltage	AC 120V/60Hz	Polarization	Vertical

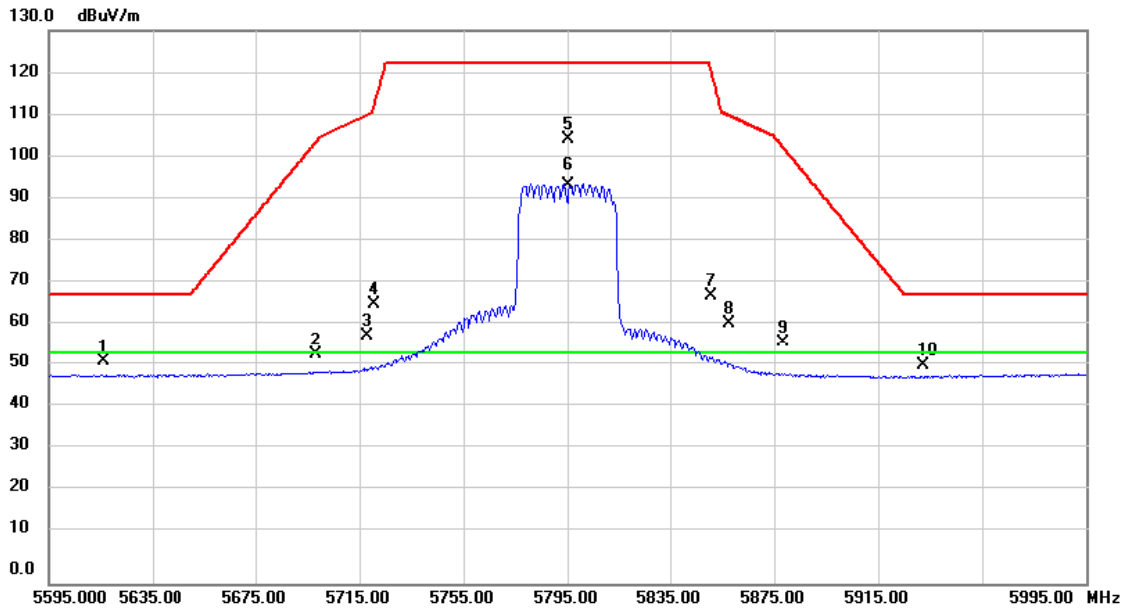

No.	Mk.	Freq. MHz	Reading Level dBuV	Correct Factor dB	Measure- ment dBuV/m	Limit dBuV/m	Over dB	Detector	Comment
1		5616.285	13.65	38.37	52.02	68.20	-16.18	peak	
2		5698.150	15.16	38.58	53.74	103.84	-50.10	peak	
3		5717.820	19.70	38.63	58.33	110.19	-51.86	peak	
4		5720.840	27.34	38.63	65.97	112.72	-46.75	peak	
5		5795.000	65.54	38.82	104.36	122.20	-17.84	peak	No Limit
6	*	5795.000	55.09	38.82	93.91	54.00	39.91	AVG	No Limit
7		5850.940	28.75	38.95	67.70	120.06	-52.36	peak	
8		5857.920	22.43	38.97	61.40	109.98	-48.58	peak	
9		5878.500	17.65	39.02	56.67	102.60	-45.93	peak	
10		5932.260	12.11	39.15	51.26	68.20	-16.94	peak	

REMARKS:

- (1) Measurement Value = Reading Level + Correct Factor.
- (2) Margin Level = Measurement Value - Limit Value.

Test Mode	UNII-3_TX ac (VHT40) Mode 5795MHz	Tested Date	2019/5/9~11
Test Voltage	AC 120V/60Hz	Polarization	Horizontal

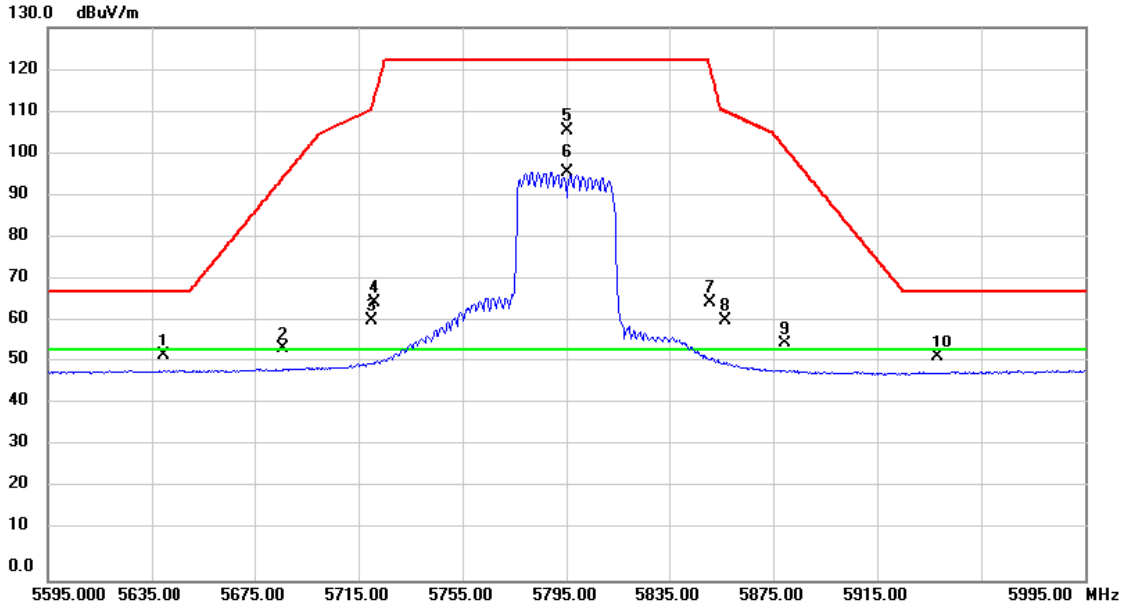

No. Mk.	Freq. MHz	Reading Level dBuV	Correct Factor dB	Measurement dBuV/m	Limit dBuV/m	Over dB	Detector	Comment
1	5639.715	14.38	38.43	52.81	68.20	-15.39	peak	
2	5686.200	15.92	38.55	54.47	95.02	-40.55	peak	
3	5719.960	22.76	38.63	61.39	110.79	-49.40	peak	
4	5721.295	26.94	38.63	65.57	113.75	-48.18	peak	
5	5795.000	66.93	38.82	105.75	122.20	-16.45	peak	No Limit
6 *	5795.000	57.37	38.82	96.19	54.00	42.19	AVG	No Limit
7	5850.820	26.68	38.95	65.63	120.33	-54.70	peak	
8	5856.400	22.20	38.96	61.16	110.41	-49.25	peak	
9	5879.300	16.88	39.02	55.90	102.01	-46.11	peak	
10	5937.950	13.37	39.17	52.54	68.20	-15.66	peak	

REMARKS:

- (1) Measurement Value = Reading Level + Correct Factor.
- (2) Margin Level = Measurement Value - Limit Value.

Test Mode	UNII-3_TX ac (VHT80) Mode 5775MHz	Tested Date	2019/5/9~11
Test Voltage	AC 120V/60Hz	Polarization	Vertical

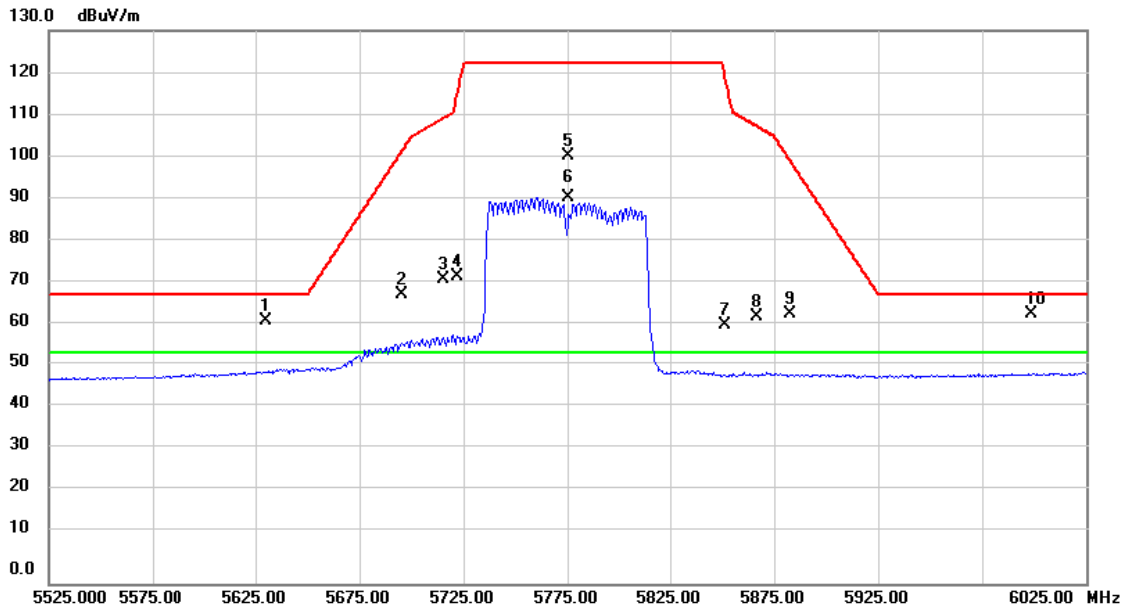

No.	Mk.	Freq. MHz	Reading Level dBuV	Correct Factor dB	Measure- ment dBuV/m	Limit dBuV/m	Over dB	Detector	Comment
1		5630.125	23.64	38.41	62.05	68.20	-6.15	peak	
2		5695.250	29.68	38.57	68.25	101.70	-33.45	peak	
3		5715.125	32.97	38.62	71.59	109.44	-37.85	peak	
4		5722.280	33.59	38.63	72.22	116.00	-43.78	peak	
5		5775.000	61.86	38.77	100.63	122.20	-21.57	peak	No Limit
6	*	5775.000	52.02	38.77	90.79	54.00	36.79	AVG	No Limit
7		5851.180	21.91	38.95	60.86	119.51	-58.65	peak	
8		5866.480	23.96	38.99	62.95	107.58	-44.63	peak	
9		5882.950	24.41	39.04	63.45	99.30	-35.85	peak	
10		5998.600	24.27	39.32	63.59	68.20	-4.61	peak	

REMARKS:

- (1) Measurement Value = Reading Level + Correct Factor.
- (2) Margin Level = Measurement Value - Limit Value.

Test Mode	UNII-3_TX ac (VHT80) Mode 5775MHz	Tested Date	2019/5/9~11
Test Voltage	AC 120V/60Hz	Polarization	Horizontal

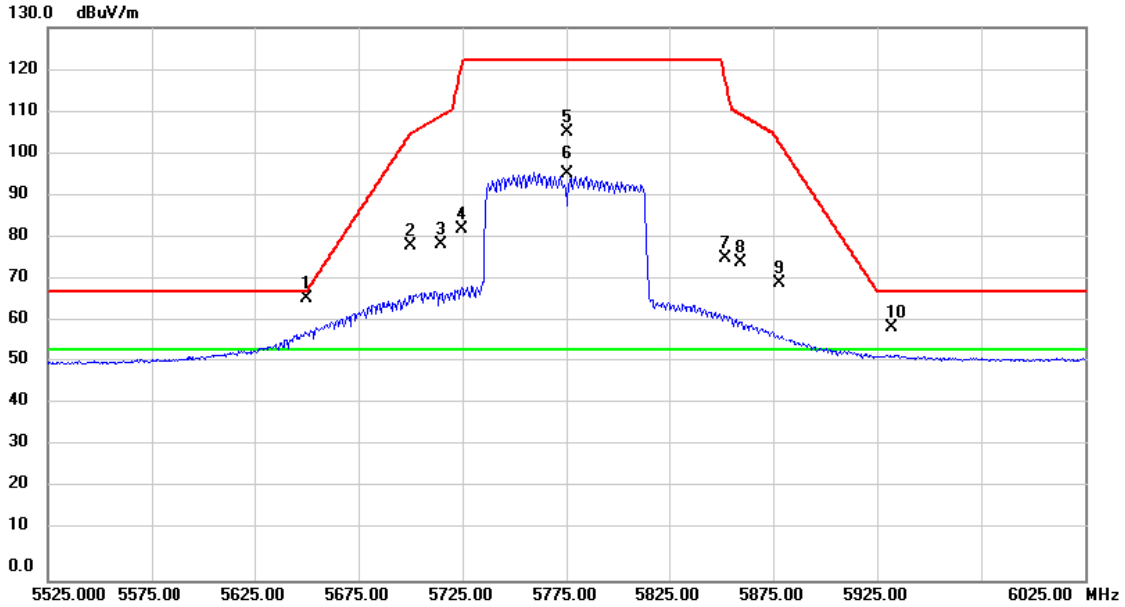

No.	Mk.	Freq. MHz	Reading Level dBuV	Correct Factor dB	Measure- ment dBuV/m	Limit dBuV/m	Over dB	Detector	Comment
1		5650.000	28.13	38.46	66.59	68.20	-1.61	peak	
2		5699.700	40.07	38.58	78.65	104.98	-26.33	peak	
3		5714.500	40.37	38.62	78.99	109.26	-30.27	peak	
4		5724.945	44.20	38.64	82.84	122.07	-39.23	peak	
5		5775.000	66.73	38.77	105.50	122.20	-16.70	peak	No Limit
6	*	5775.000	57.09	38.77	95.86	54.00	41.86	AVG	No Limit
7		5852.130	36.98	38.95	75.93	117.34	-41.41	peak	
8		5859.020	35.80	38.98	74.78	109.67	-34.89	peak	
9		5877.900	30.95	39.02	69.97	103.05	-33.08	peak	
10		5932.300	20.40	39.15	59.55	68.20	-8.65	peak	

REMARKS:

- (1) Measurement Value = Reading Level + Correct Factor.
- (2) Margin Level = Measurement Value - Limit Value.

Test Mode	UNII-1_TX a Mode 5180MHz	Tested Date	2019/5/9~11
Test Voltage	AC 120V/60Hz	Polarization	Vertical

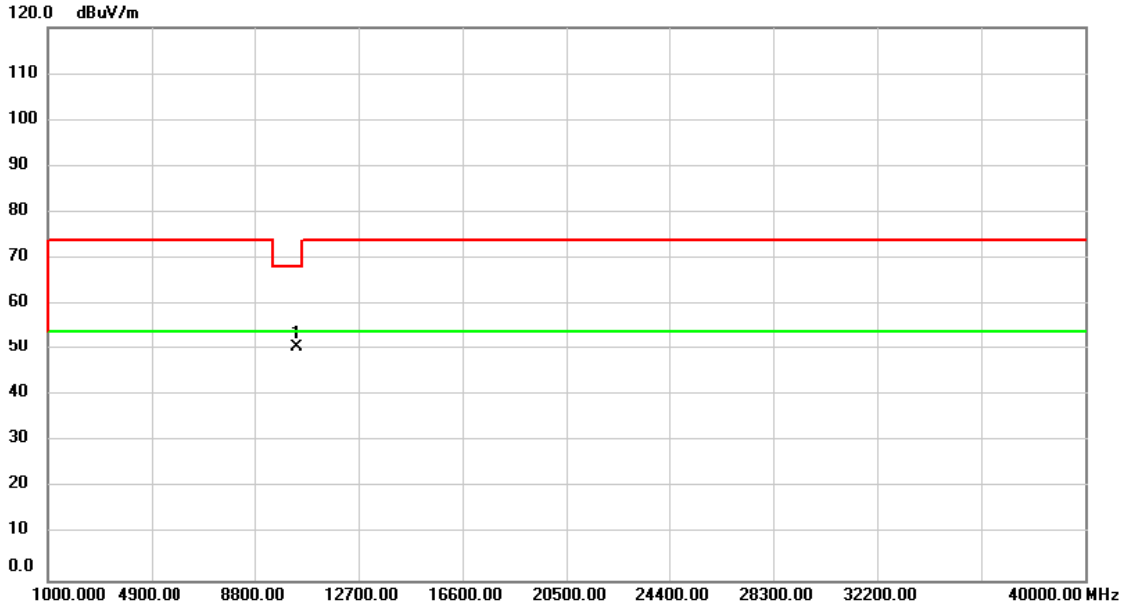

No.	Mk.	Freq.	Reading Level	Correct Factor	Measurement	Limit	Over	Detector	Comment
		MHz	dBuV	dB	dBuV/m	dBuV/m	dB		
1	*	10360.00	49.39	1.25	50.64	68.20	-17.56	peak	

REMARKS:

- (1) Measurement Value = Reading Level + Correct Factor.
- (2) Margin Level = Measurement Value - Limit Value.

Test Mode	UNII-1_TX a Mode 5180MHz	Tested Date	2019/5/9~11
Test Voltage	AC 120V/60Hz	Polarization	Horizontal

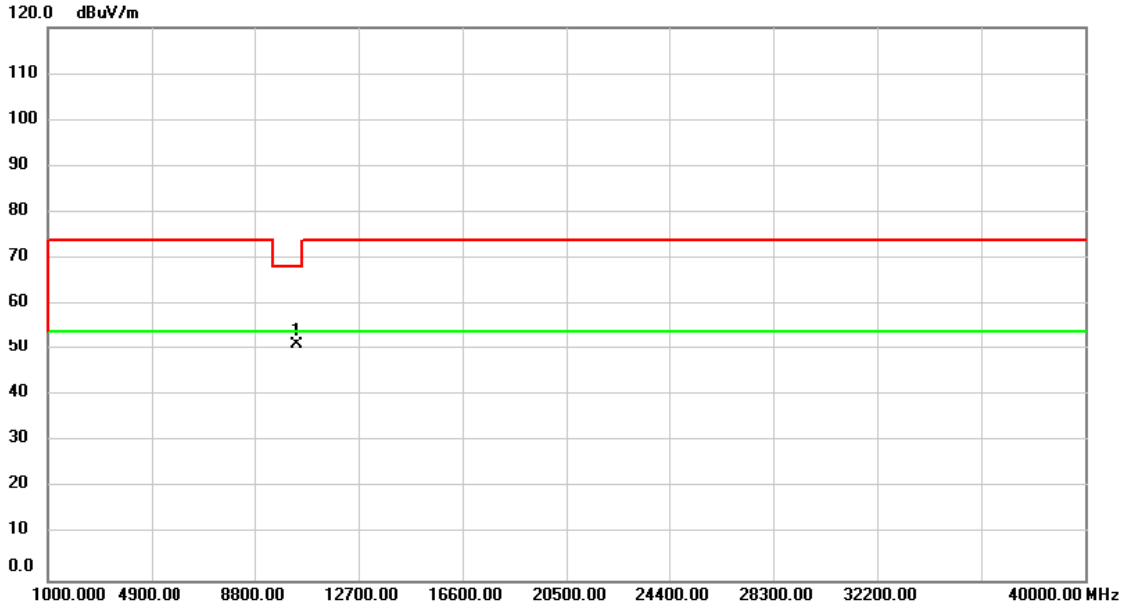

No.	Mk.	Freq.	Reading Level	Correct Factor	Measurement	Limit	Over	Detector	Comment
		MHz	dBuV	dB	dBuV/m	dBuV/m	dB		
1	*	10360.00	49.77	1.25	51.02	68.20	-17.18	peak	

REMARKS:

- (1) Measurement Value = Reading Level + Correct Factor.
- (2) Margin Level = Measurement Value - Limit Value.

Test Mode	UNII-1_TX a Mode 5200MHz	Tested Date	2019/5/9~11
Test Voltage	AC 120V/60Hz	Polarization	Vertical

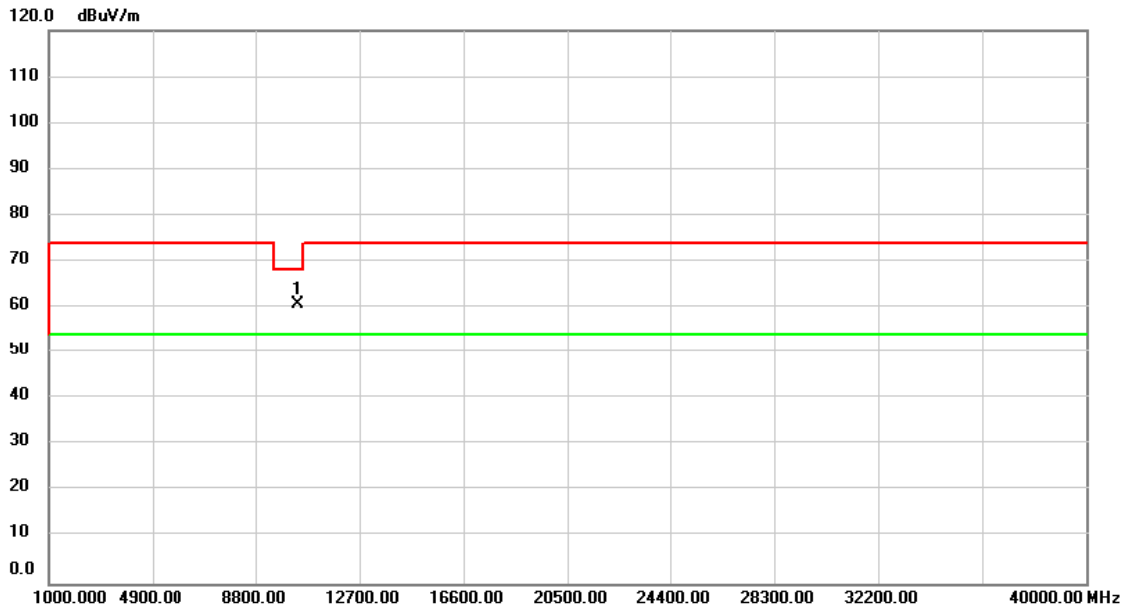

No.	Mk.	Freq.	Reading Level	Correct Factor	Measurement	Limit	Over	Detector	Comment
		MHz	dBuV	dB	dBuV/m	dBuV/m	dB		
1	*	10400.00	59.50	1.30	60.80	68.20	-7.40	peak	

REMARKS:

- (1) Measurement Value = Reading Level + Correct Factor.
- (2) Margin Level = Measurement Value - Limit Value.

Test Mode	UNII-1_TX a Mode 5200MHz	Tested Date	2019/5/9~11
Test Voltage	AC 120V/60Hz	Polarization	Horizontal

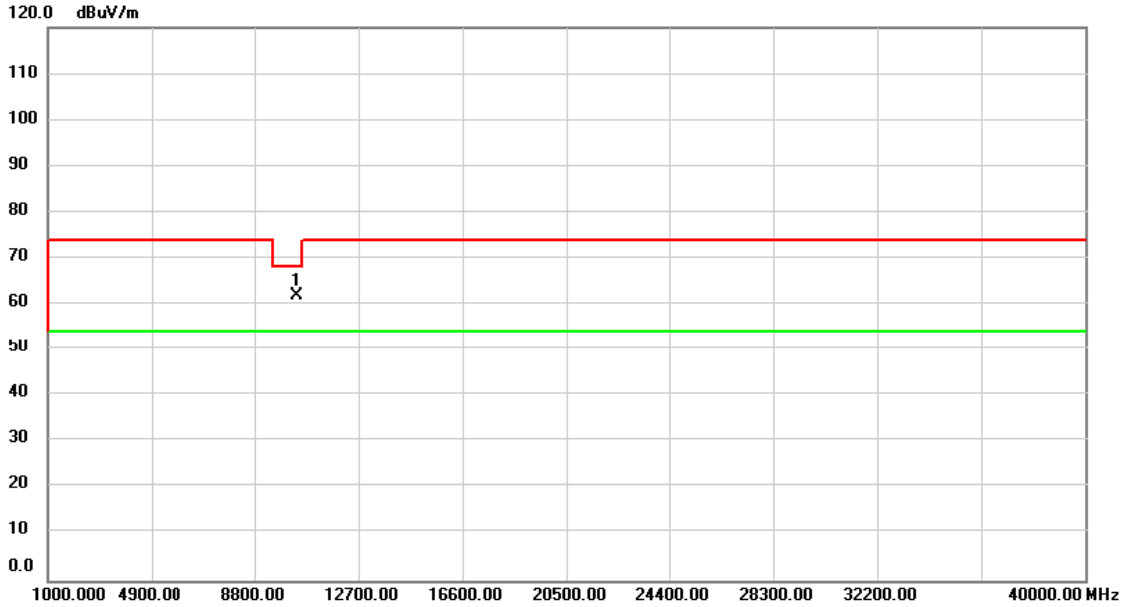

No.	Mk.	Freq.	Reading Level	Correct Factor	Measurement	Limit	Over	Detector	Comment
		MHz	dBuV	dB	dBuV/m	dBuV/m	dB		
1	*	10400.00	60.75	1.30	62.05	68.20	-6.15	peak	

REMARKS:

- (1) Measurement Value = Reading Level + Correct Factor.
- (2) Margin Level = Measurement Value - Limit Value.

Test Mode	UNII-1_TX a Mode 5240MHz	Tested Date	2019/5/9~11
Test Voltage	AC 120V/60Hz	Polarization	Vertical

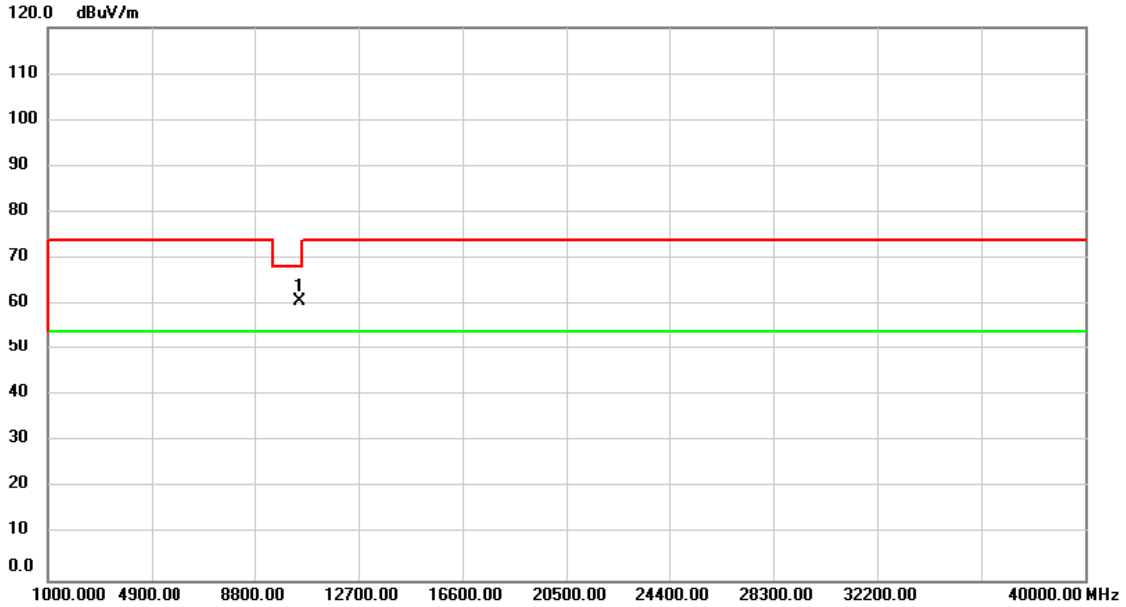

No.	Mk.	Freq.	Reading Level	Correct Factor	Measurement	Limit	Over	Detector	Comment
		MHz	dBuV	dB	dBuV/m	dBuV/m	dB		
1	*	10480.00	59.46	1.39	60.85	68.20	-7.35	peak	

REMARKS:

- (1) Measurement Value = Reading Level + Correct Factor.
- (2) Margin Level = Measurement Value - Limit Value.

Test Mode	UNII-1_TX a Mode 5240MHz	Tested Date	2019/5/9~11
Test Voltage	AC 120V/60Hz	Polarization	Horizontal

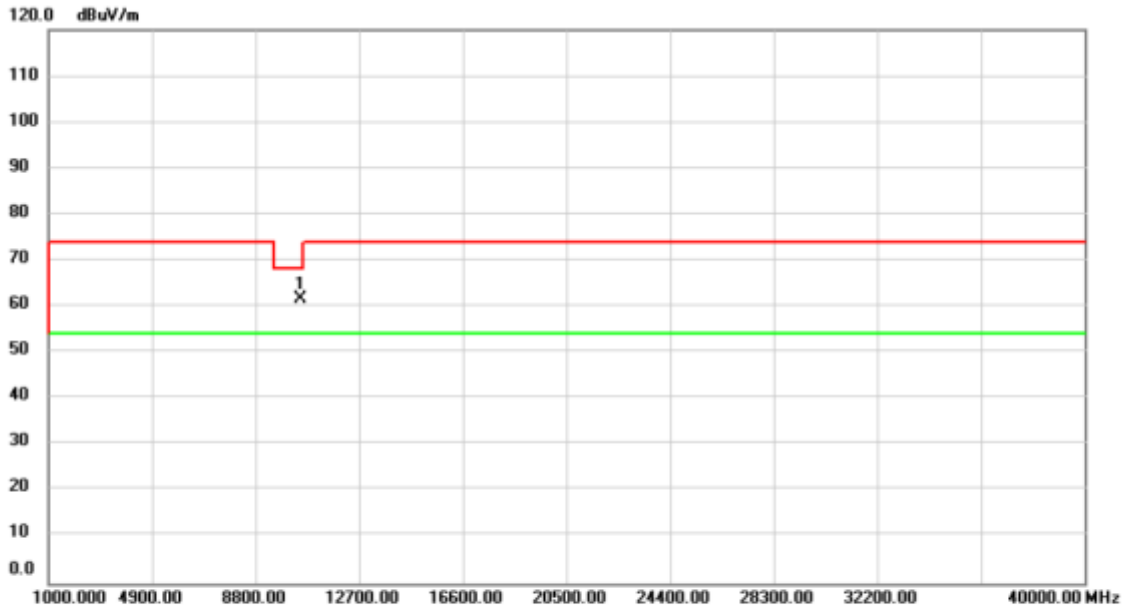

No.	Mk.	Freq.	Reading Level	Correct Factor	Measurement	Limit	Over	Detector	Comment
		MHz	dBuV	dB	dBuV/m	dBuV/m	dB		
1	*	10480.00	60.13	1.39	61.52	68.20	-6.68	peak	

REMARKS:

- (1) Measurement Value = Reading Level + Correct Factor.
- (2) Margin Level = Measurement Value - Limit Value.

Test Mode	UNII-1_TX n (HT20) Mode 5180MHz	Tested Date	2019/5/9~11
Test Voltage	AC 120V/60Hz	Polarization	Vertical

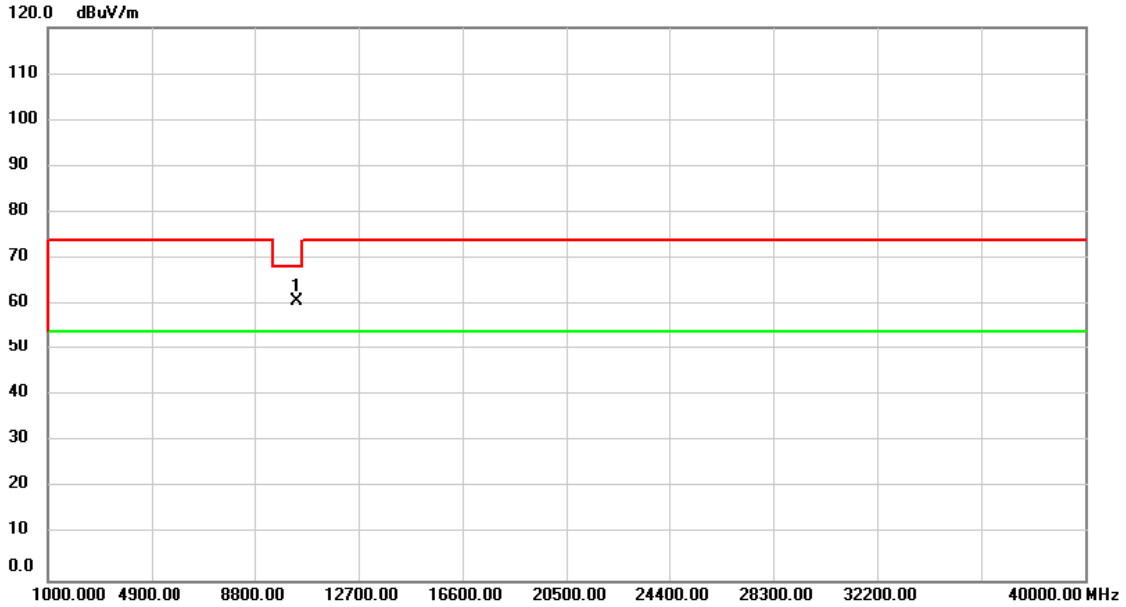

No.	Mk.	Freq.	Reading Level	Correct Factor	Measurement	Limit	Over	Detector	Comment
		MHz	dBuV	dB	dBuV/m	dBuV/m	dB		
1	*	10360.00	59.51	1.25	60.76	68.20	-7.44	peak	

REMARKS:

- (1) Measurement Value = Reading Level + Correct Factor.
- (2) Margin Level = Measurement Value - Limit Value.

Test Mode	UNII-1_TX n (HT20) Mode 5180MHz	Tested Date	2019/5/9~11
Test Voltage	AC 120V/60Hz	Polarization	Horizontal

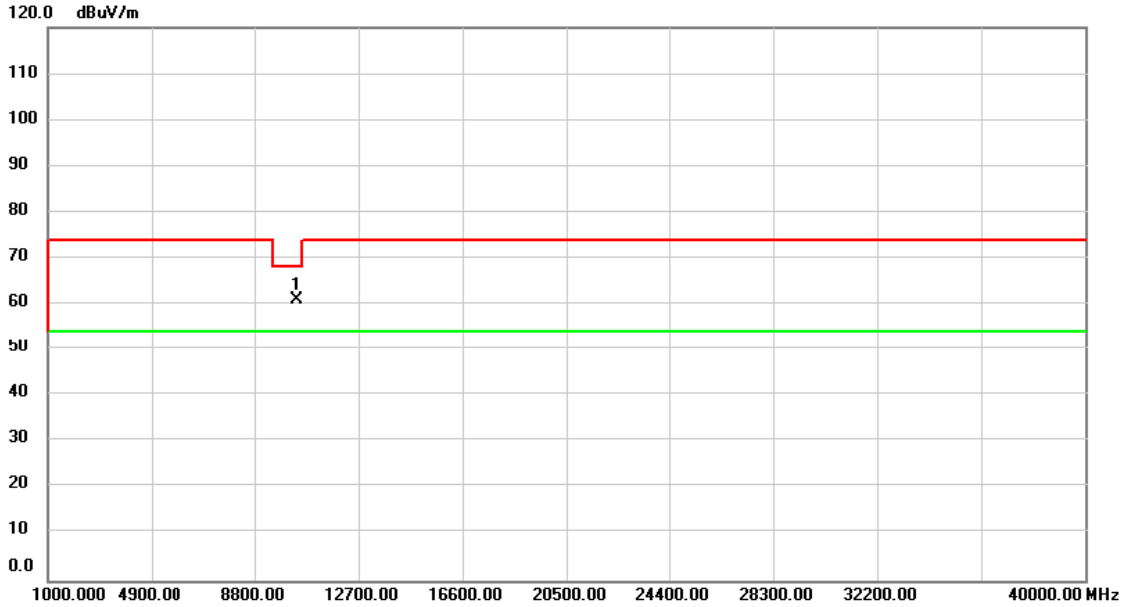

No.	Mk.	Freq.	Reading Level	Correct Factor	Measurement	Limit	Over	Detector	Comment
		MHz	dBuV	dB	dBuV/m	dBuV/m	dB		
1	*	10360.00	59.83	1.25	61.08	68.20	-7.12	peak	

REMARKS:

- (1) Measurement Value = Reading Level + Correct Factor.
- (2) Margin Level = Measurement Value - Limit Value.

Test Mode	UNII-1_TX n (HT20) Mode 5200MHz	Tested Date	2019/5/9~11
Test Voltage	AC 120V/60Hz	Polarization	Vertical

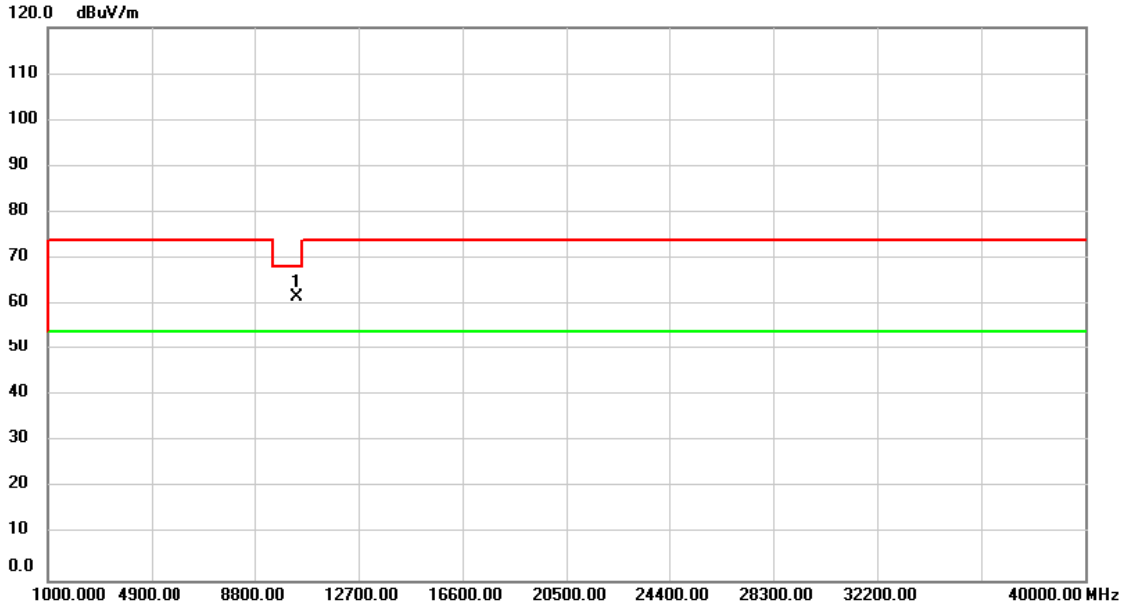

No.	Mk.	Freq. MHz	Reading Level dBuV	Correct Factor dB	Measure- ment dBuV/m	Limit dBuV/m	Over dB	Detector	Comment
1	*	10400.00	60.43	1.30	61.73	68.20	-6.47	peak	

REMARKS:

- (1) Measurement Value = Reading Level + Correct Factor.
- (2) Margin Level = Measurement Value - Limit Value.

Test Mode	UNII-1_TX n (HT20) Mode 5200MHz	Tested Date	2019/5/9~11
Test Voltage	AC 120V/60Hz	Polarization	Horizontal

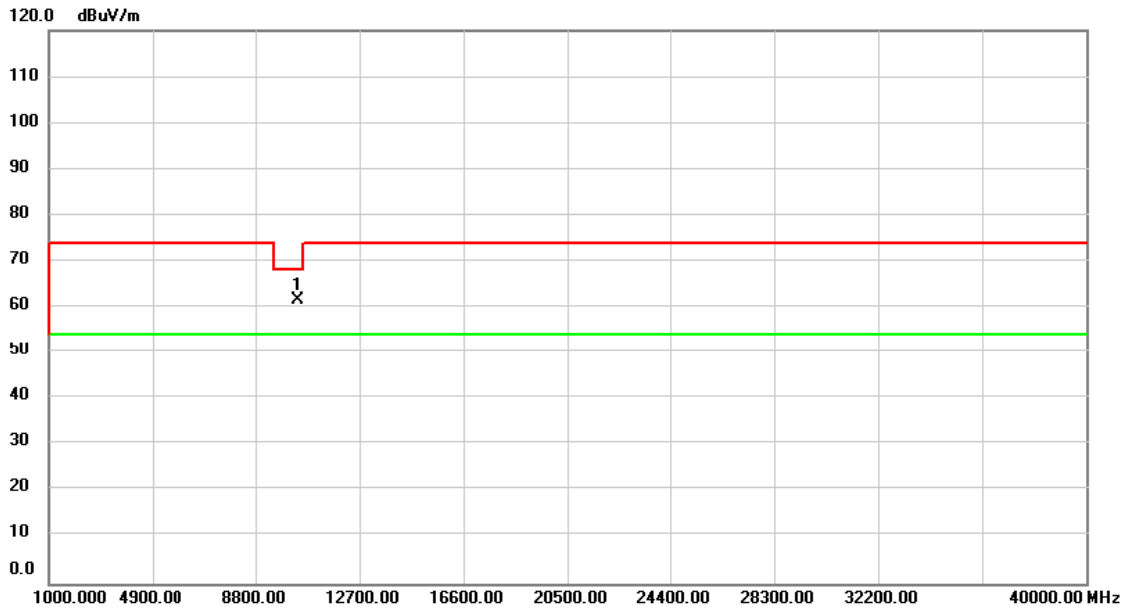

No.	Mk.	Freq. MHz	Reading Level dBuV	Correct Factor dB	Measure- ment dBuV/m	Limit dBuV/m	Over dB	Detector	Comment
1	*	10400.00	60.40	1.30	61.70	68.20	-6.50	peak	

REMARKS:

- (1) Measurement Value = Reading Level + Correct Factor.
- (2) Margin Level = Measurement Value - Limit Value.

Test Mode	UNII-1_TX n (HT20) Mode 5240MHz	Tested Date	2019/5/9~11
Test Voltage	AC 120V/60Hz	Polarization	Vertical

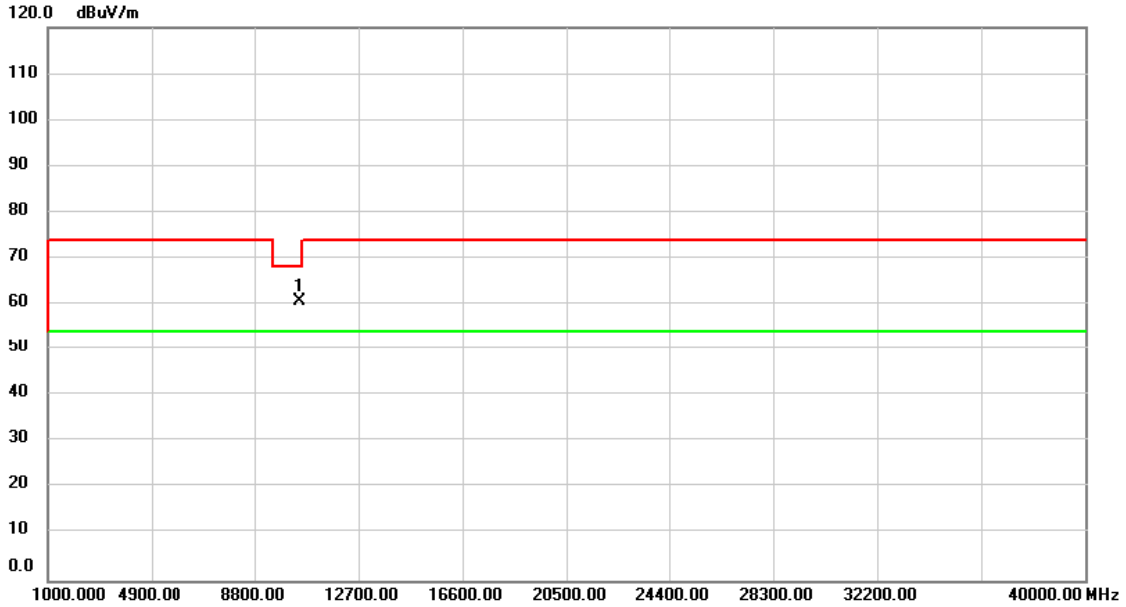

No.	Mk.	Freq. MHz	Reading Level dBuV	Correct Factor dB	Measure- ment dBuV/m	Limit dBuV/m	Over dB	Detector	Comment
1	*	10480.00	59.29	1.39	60.68	68.20	-7.52	peak	

REMARKS:

- (1) Measurement Value = Reading Level + Correct Factor.
- (2) Margin Level = Measurement Value - Limit Value.

Test Mode	UNII-1_TX n (HT20) Mode 5240MHz	Tested Date	2019/5/9~11
Test Voltage	AC 120V/60Hz	Polarization	Horizontal

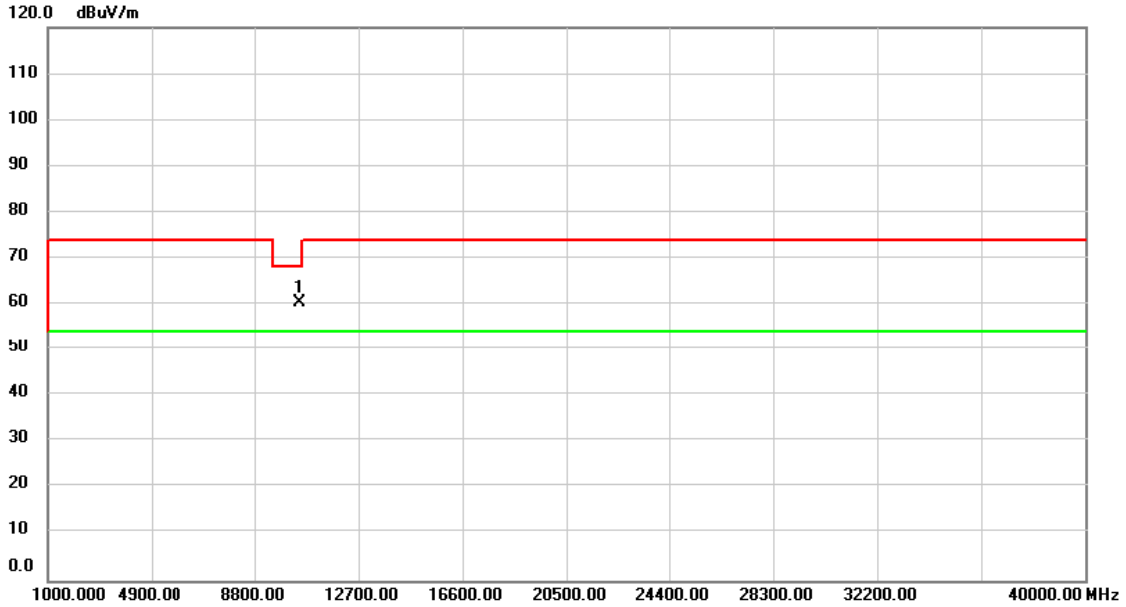

No.	Mk.	Freq.	Reading Level	Correct Factor	Measurement	Limit	Over	Detector	Comment
		MHz	dBuV	dB	dBuV/m	dBuV/m	dB		
1	*	10480.00	59.11	1.39	60.50	68.20	-7.70	peak	

REMARKS:

- (1) Measurement Value = Reading Level + Correct Factor.
- (2) Margin Level = Measurement Value - Limit Value.

Test Mode	UNII-1_TX ac (VHT40) Mode 5190MHz	Tested Date	2019/5/9~11
Test Voltage	AC 120V/60Hz	Polarization	Vertical

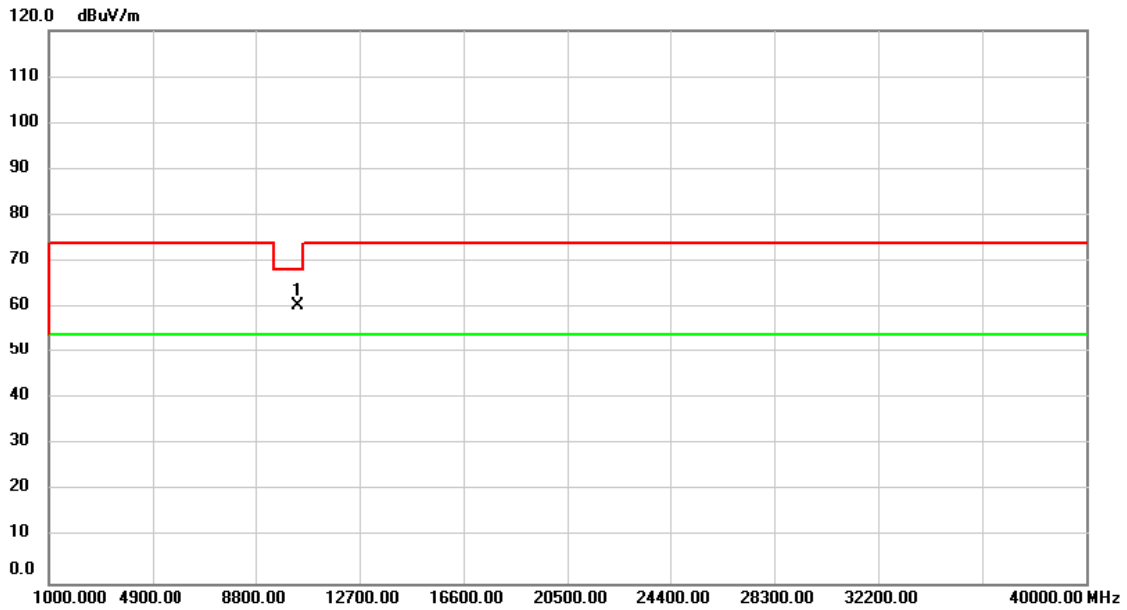

No.	Mk.	Freq. MHz	Reading Level dBuV	Correct Factor dB	Measure- ment dBuV/m	Limit dBuV/m	Over dB	Detector	Comment
1	*	10380.00	59.28	1.27	60.55	68.20	-7.65	peak	

REMARKS:

- (1) Measurement Value = Reading Level + Correct Factor.
- (2) Margin Level = Measurement Value - Limit Value.

Test Mode	UNII-1_TX ac (VHT40) Mode 5190MHz	Tested Date	2019/5/9~11
Test Voltage	AC 120V/60Hz	Polarization	Horizontal

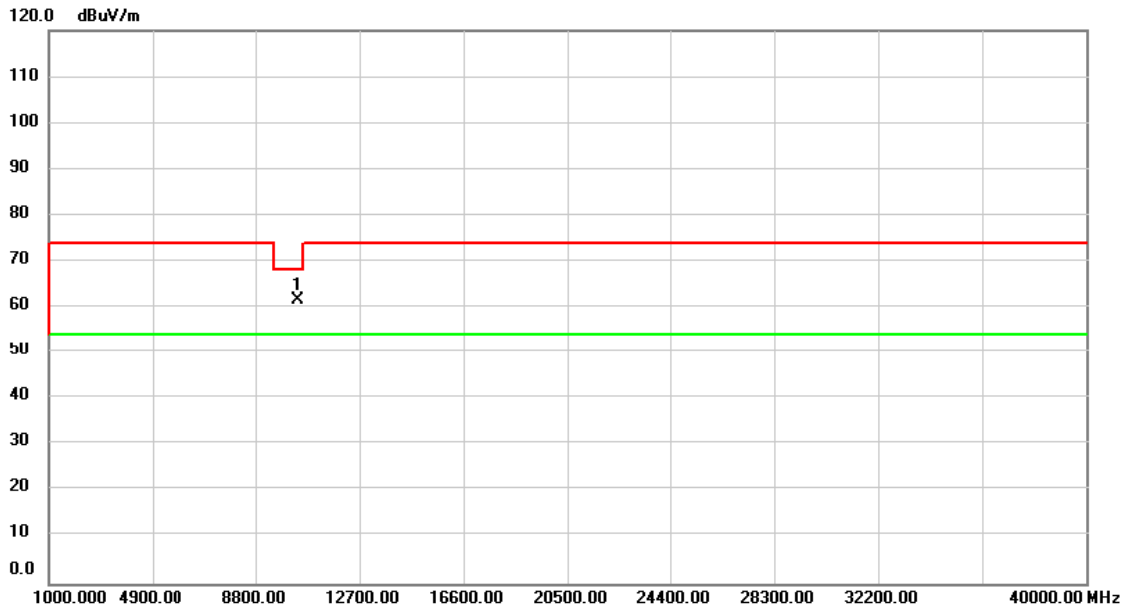

No.	Mk.	Freq. MHz	Reading Level dBuV	Correct Factor dB	Measure- ment dBuV/m	Limit dBuV/m	Over dB	Detector	Comment
1	*	10380.00	60.41	1.27	61.68	68.20	-6.52	peak	

REMARKS:

- (1) Measurement Value = Reading Level + Correct Factor.
- (2) Margin Level = Measurement Value - Limit Value.

Test Mode	UNII-1_TX ac (VHT40) Mode 5230MHz	Tested Date	2019/5/9~11
Test Voltage	AC 120V/60Hz	Polarization	Vertical

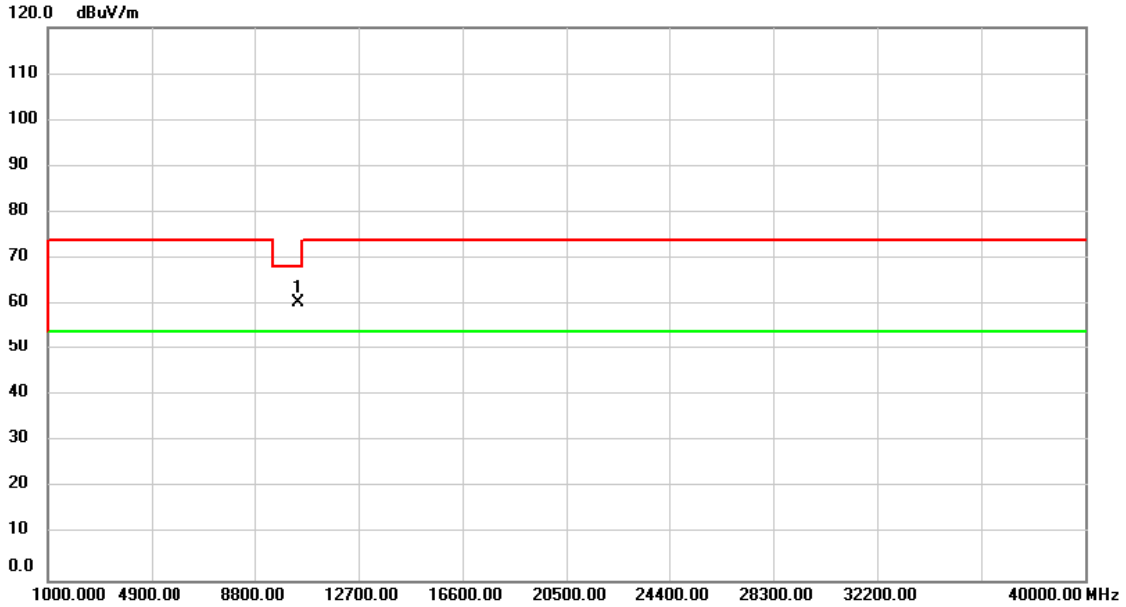

No.	Mk.	Freq.	Reading Level	Correct Factor	Measurement	Limit	Over	Detector	Comment
		MHz	dBuV	dB	dBuV/m	dBuV/m	dB		
1	*	10460.00	58.99	1.38	60.37	68.20	-7.83	peak	

REMARKS:

- (1) Measurement Value = Reading Level + Correct Factor.
- (2) Margin Level = Measurement Value - Limit Value.

Test Mode	UNII-1_TX ac (VHT40) Mode 5230MHz	Tested Date	2019/5/9~11
Test Voltage	AC 120V/60Hz	Polarization	Horizontal

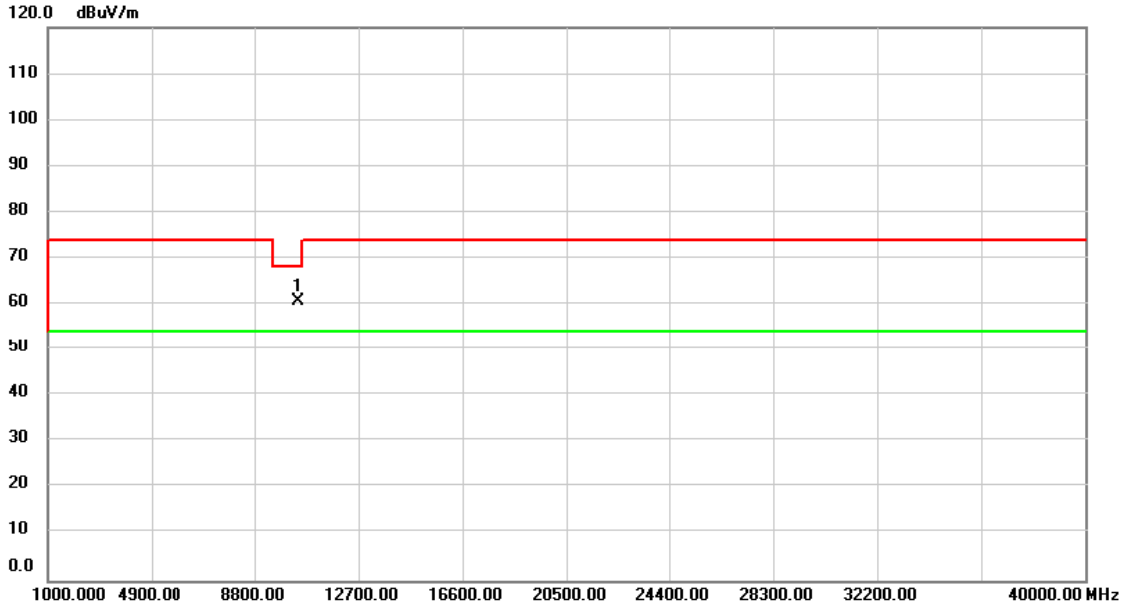

No.	Mk.	Freq.	Reading Level	Correct Factor	Measurement	Limit	Over	Detector	Comment
		MHz	dBuV	dB	dBuV/m	dBuV/m	dB		
1	*	10460.00	59.31	1.38	60.69	68.20	-7.51	peak	

REMARKS:

- (1) Measurement Value = Reading Level + Correct Factor.
- (2) Margin Level = Measurement Value - Limit Value.

Test Mode	UNII-1_TX ac (VHT80) Mode 5210MHz	Tested Date	2019/5/9~11
Test Voltage	AC 120V/60Hz	Polarization	Vertical

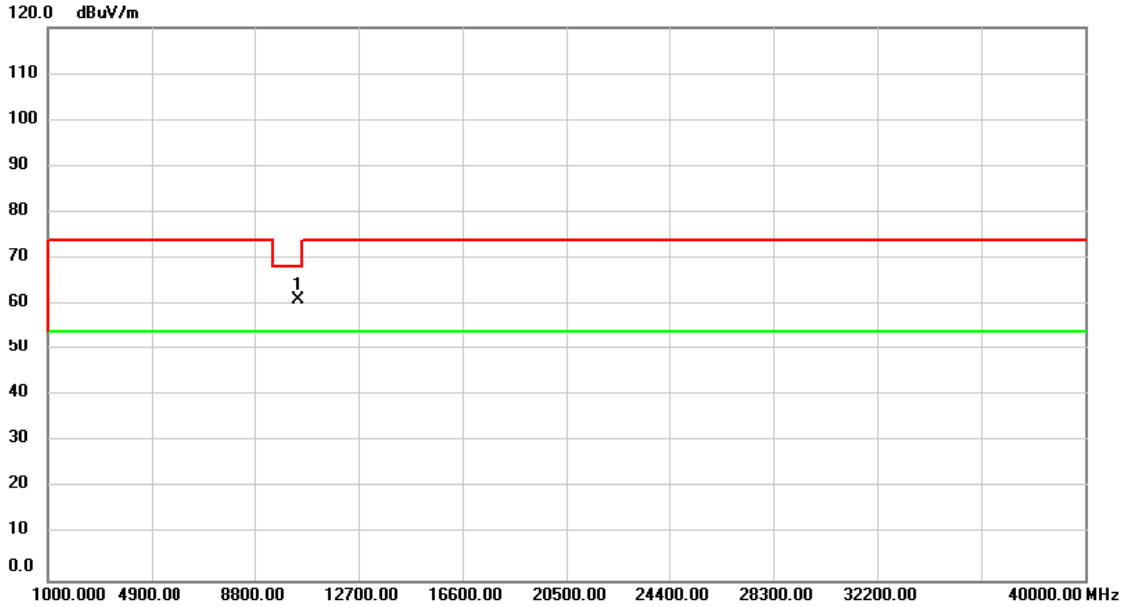

No.	Mk.	Freq.	Reading Level	Correct Factor	Measurement	Limit	Over	Detector	Comment
		MHz	dBuV	dB	dBuV/m	dBuV/m	dB		
1	*	10420.00	59.71	1.32	61.03	68.20	-7.17	peak	

REMARKS:

- (1) Measurement Value = Reading Level + Correct Factor.
- (2) Margin Level = Measurement Value - Limit Value.

Test Mode	UNII-1_TX ac (VHT80) Mode 5210MHz	Tested Date	2019/5/9~11
Test Voltage	AC 120V/60Hz	Polarization	Horizontal

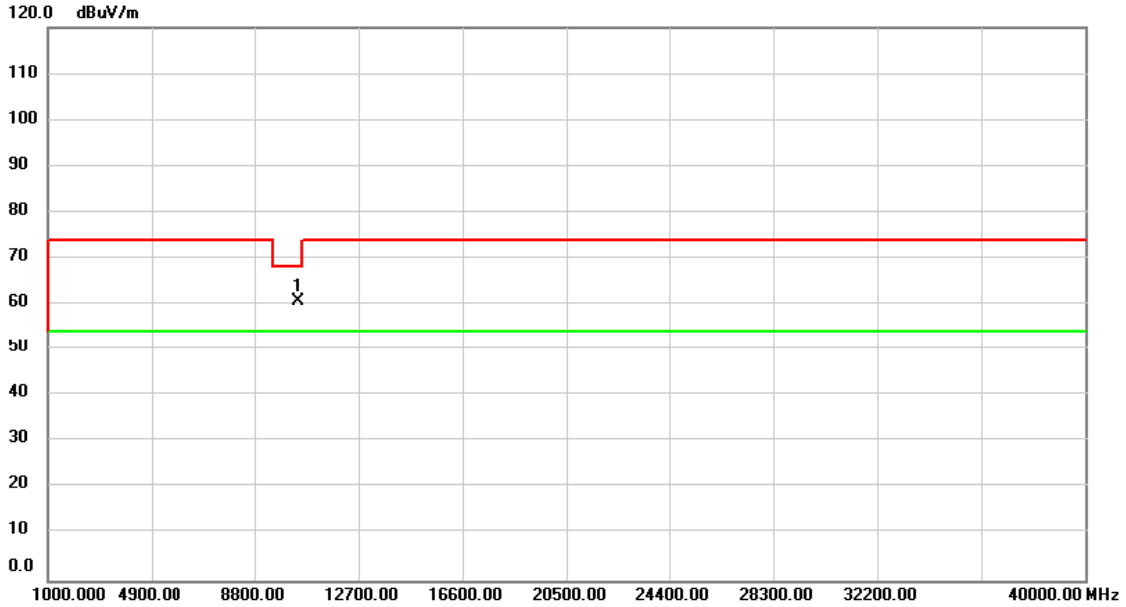

No.	Mk.	Freq. MHz	Reading Level dBuV	Correct Factor dB	Measure- ment dBuV/m	Limit dBuV/m	Over dB	Detector	Comment
1	*	10420.00	59.47	1.32	60.79	68.20	-7.41	peak	

REMARKS:

- (1) Measurement Value = Reading Level + Correct Factor.
- (2) Margin Level = Measurement Value - Limit Value.

Test Mode	UNII-3_TX a Mode 5745MHz	Tested Date	2019/5/9~11
Test Voltage	AC 120V/60Hz	Polarization	Vertical

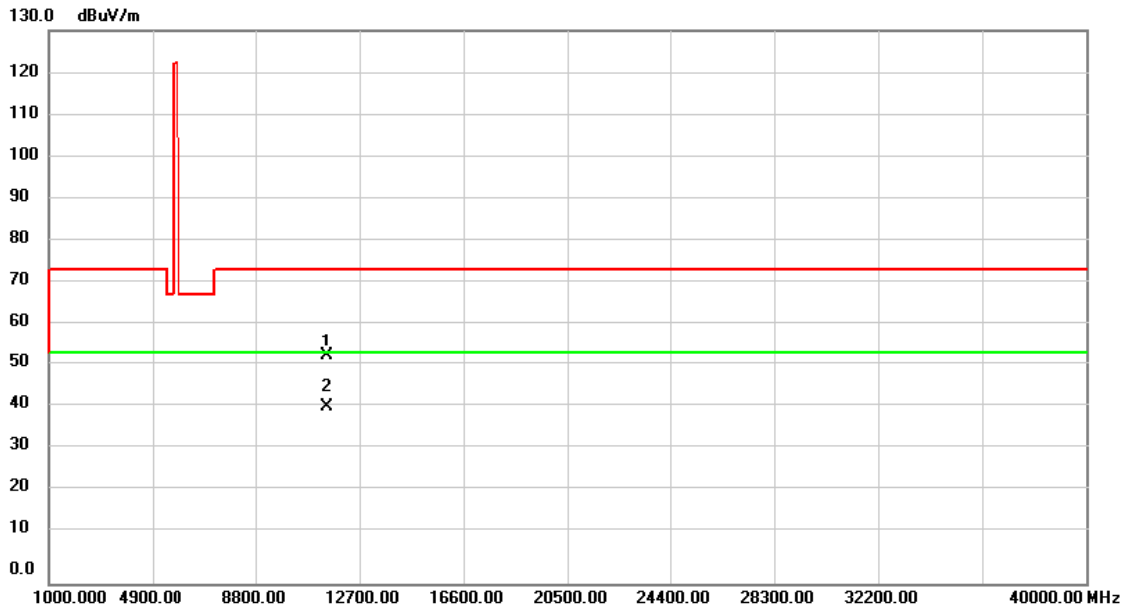

No.	Mk.	Freq. MHz	Reading Level dBuV	Correct Factor dB	Measure- ment dBuV/m	Limit dBuV/m	Over dB	Detector	Comment
1		11490.00	50.28	3.09	53.37	74.00	-20.63	peak	
2	*	11490.00	38.26	3.09	41.35	54.00	-12.65	AVG	

REMARKS:

- (1) Measurement Value = Reading Level + Correct Factor.
- (2) Margin Level = Measurement Value - Limit Value.

Test Mode	UNII-3_TX a Mode 5745MHz	Tested Date	2019/5/9~11
Test Voltage	AC 120V/60Hz	Polarization	Horizontal

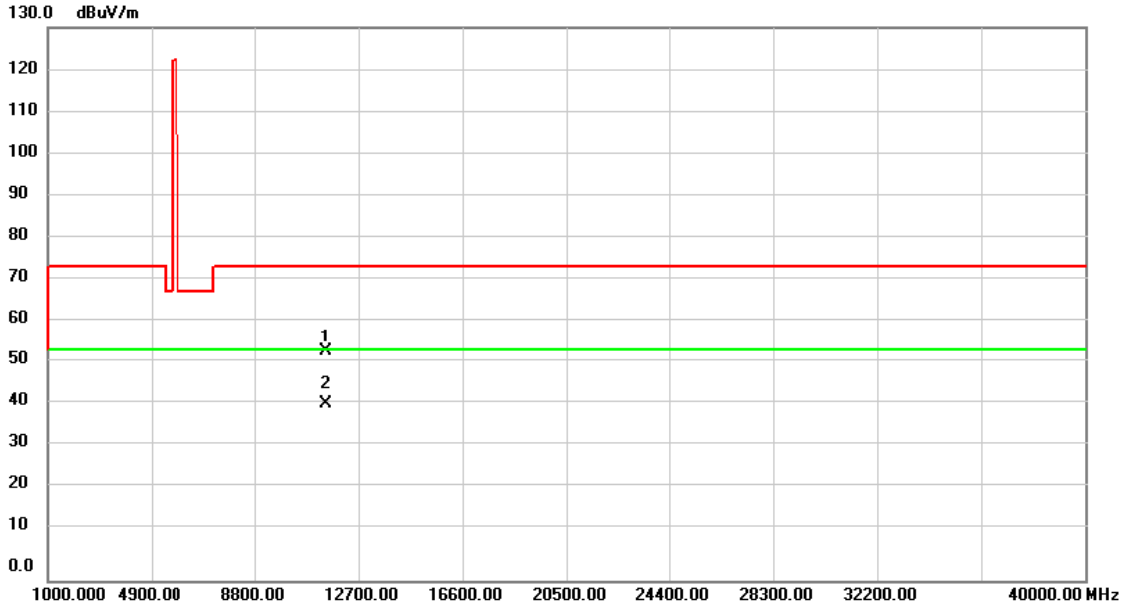

No.	Mk.	Freq. MHz	Reading Level dBuV	Correct Factor dB	Measure- ment dBuV/m	Limit dBuV/m	Over dB	Detector	Comment
1		11490.00	50.69	3.09	53.78	74.00	-20.22	peak	
2	*	11490.00	38.38	3.09	41.47	54.00	-12.53	AVG	

REMARKS:

- (1) Measurement Value = Reading Level + Correct Factor.
- (2) Margin Level = Measurement Value - Limit Value.

Test Mode	UNII-3_TX a Mode 5785MHz	Tested Date	2019/5/9~11
Test Voltage	AC 120V/60Hz	Polarization	Vertical

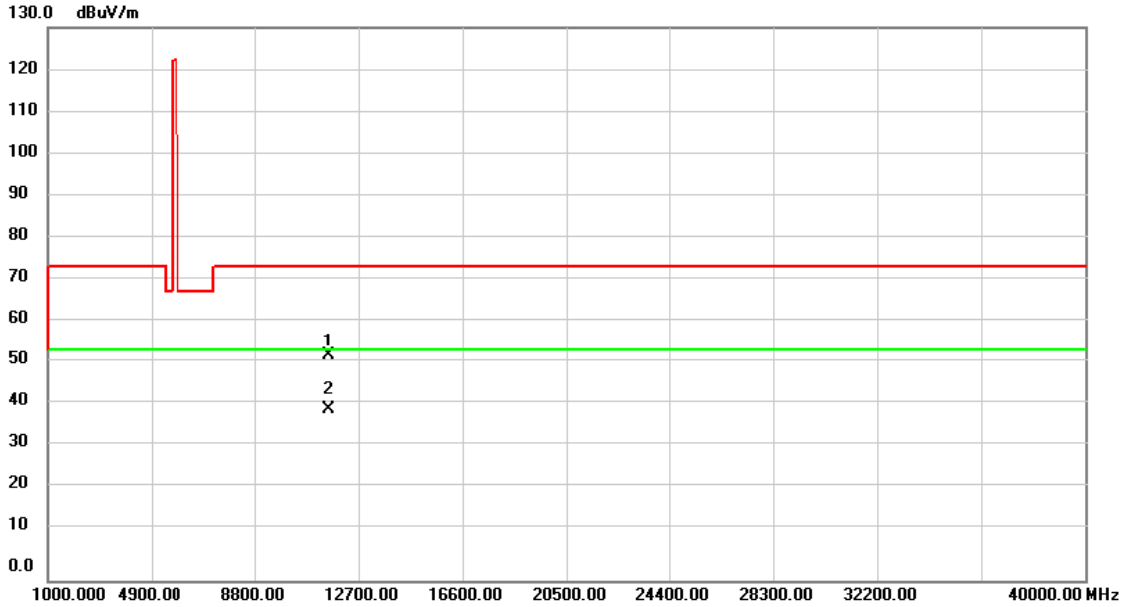

No.	Mk.	Freq. MHz	Reading Level dBuV	Correct Factor dB	Measure- ment dBuV/m	Limit dBuV/m	Over dB	Detector	Comment
1		11570.00	49.76	2.93	52.69	74.00	-21.31	peak	
2	*	11570.00	37.32	2.93	40.25	54.00	-13.75	AVG	

REMARKS:

- (1) Measurement Value = Reading Level + Correct Factor.
- (2) Margin Level = Measurement Value - Limit Value.

Test Mode	UNII-3_TX a Mode 5785MHz	Tested Date	2019/5/9~11
Test Voltage	AC 120V/60Hz	Polarization	Horizontal

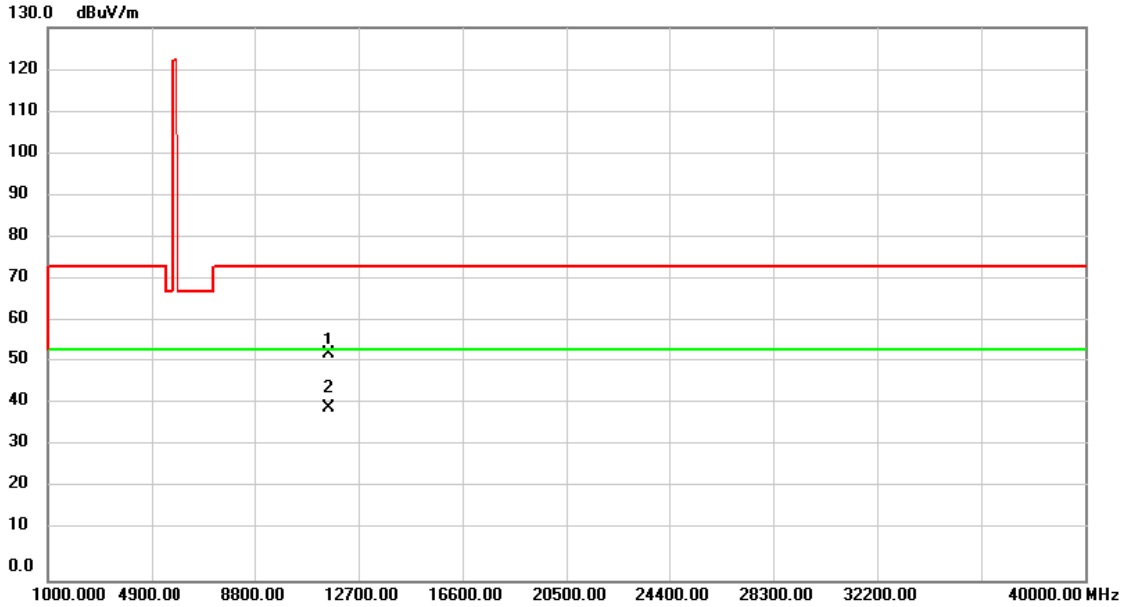

No.	Mk.	Freq. MHz	Reading Level dBuV	Correct Factor dB	Measure- ment dBuV/m	Limit dBuV/m	Over dB	Detector	Comment
1		11570.00	50.16	2.93	53.09	74.00	-20.91	peak	
2	*	11570.00	37.51	2.93	40.44	54.00	-13.56	AVG	

REMARKS:

- (1) Measurement Value = Reading Level + Correct Factor.
- (2) Margin Level = Measurement Value - Limit Value.

Test Mode	UNII-3_TX a Mode 5825MHz	Tested Date	2019/5/9~11
Test Voltage	AC 120V/60Hz	Polarization	Vertical

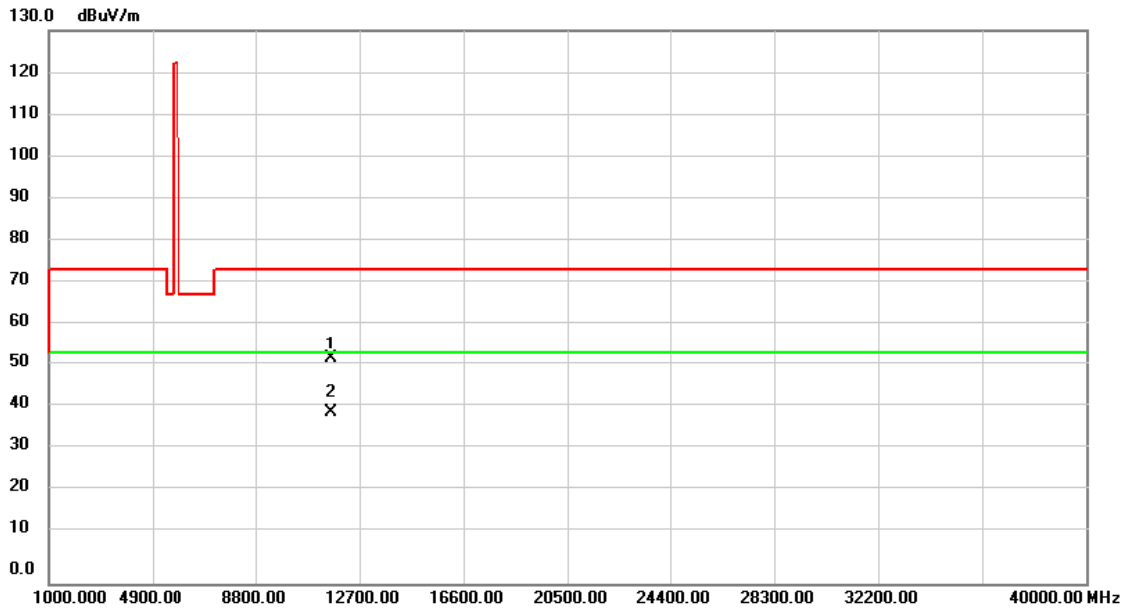

No.	Mk.	Freq. MHz	Reading Level dBuV	Correct Factor dB	Measure- ment dBuV/m	Limit dBuV/m	Over dB	Detector	Comment
1		11650.00	50.21	2.73	52.94	74.00	-21.06	peak	
2	*	11650.00	37.37	2.73	40.10	54.00	-13.90	AVG	

REMARKS:

- (1) Measurement Value = Reading Level + Correct Factor.
- (2) Margin Level = Measurement Value - Limit Value.

Test Mode	UNII-3_TX a Mode 5825MHz	Tested Date	2019/5/9~11
Test Voltage	AC 120V/60Hz	Polarization	Horizontal

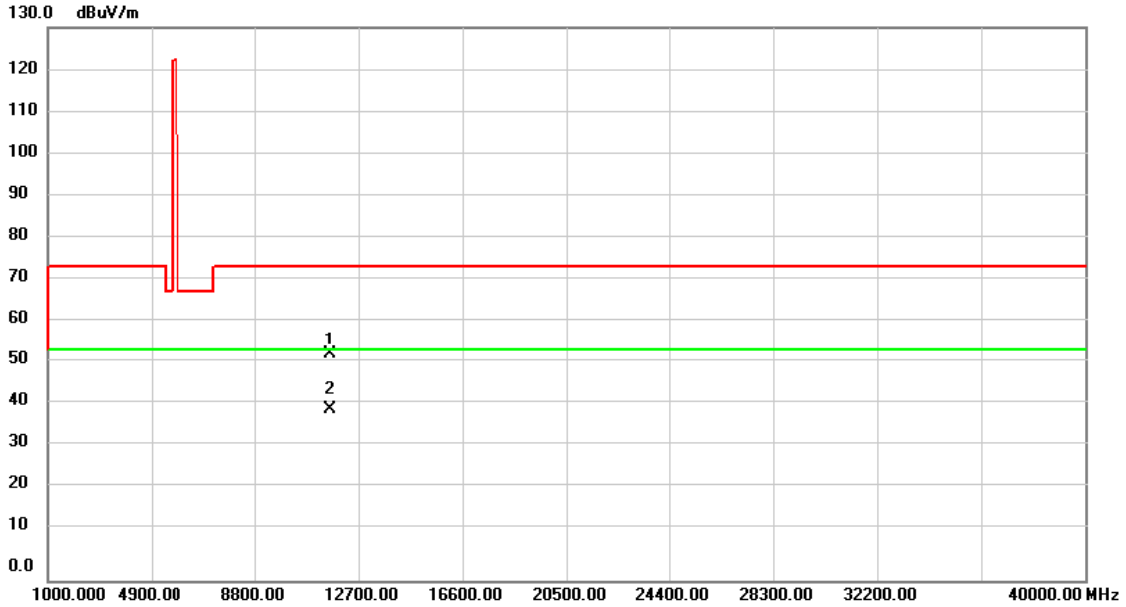

No.	Mk.	Freq. MHz	Reading Level dBuV	Correct Factor dB	Measure- ment dBuV/m	Limit dBuV/m	Over dB	Detector	Comment
1		11650.00	50.47	2.73	53.20	74.00	-20.80	peak	
2	*	11650.00	37.35	2.73	40.08	54.00	-13.92	AVG	

REMARKS:

- (1) Measurement Value = Reading Level + Correct Factor.
- (2) Margin Level = Measurement Value - Limit Value.

Test Mode	UNII-3_TX n (HT20) Mode 5745MHz	Tested Date	2019/5/9~11
Test Voltage	AC 120V/60Hz	Polarization	Vertical

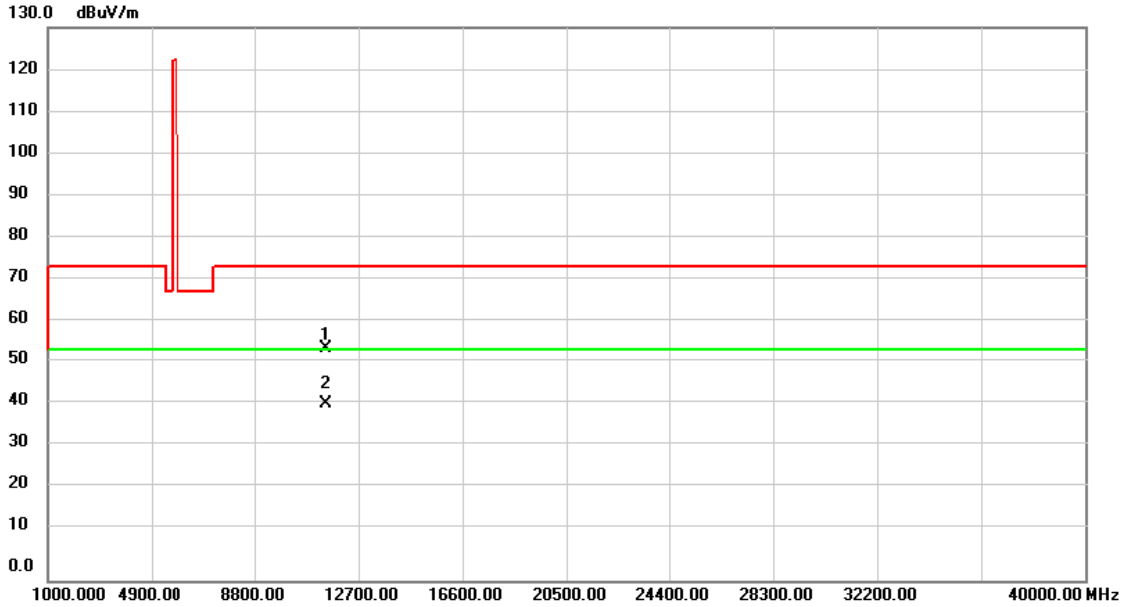

No.	Mk.	Freq. MHz	Reading Level dBuV	Correct Factor dB	Measure- ment dBuV/m	Limit dBuV/m	Over dB	Detector	Comment
1		11490.00	51.48	3.09	54.57	74.00	-19.43	peak	
2	*	11490.00	38.21	3.09	41.30	54.00	-12.70	AVG	

REMARKS:

- (1) Measurement Value = Reading Level + Correct Factor.
- (2) Margin Level = Measurement Value - Limit Value.

Test Mode	UNII-3_TX n (HT20) Mode 5745MHz	Tested Date	2019/5/9~11
Test Voltage	AC 120V/60Hz	Polarization	Horizontal

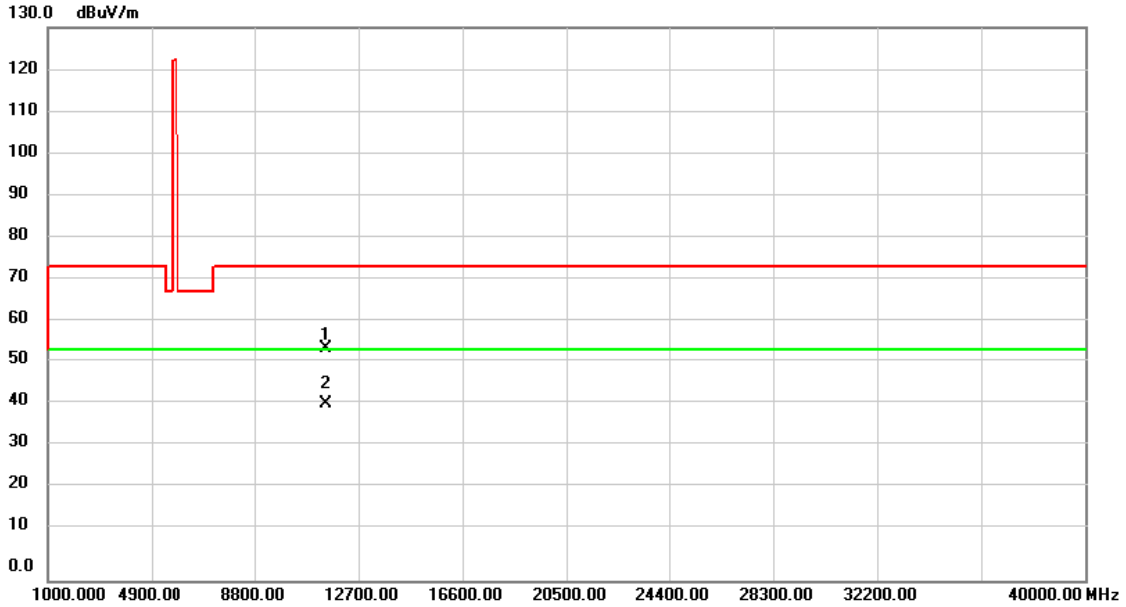

No.	Mk.	Freq. MHz	Reading Level dBuV	Correct Factor dB	Measure- ment dBuV/m	Limit dBuV/m	Over dB	Detector	Comment
1		11490.00	51.25	3.09	54.34	74.00	-19.66	peak	
2	*	11490.00	38.23	3.09	41.32	54.00	-12.68	AVG	

REMARKS:

- (1) Measurement Value = Reading Level + Correct Factor.
- (2) Margin Level = Measurement Value - Limit Value.

Test Mode	UNII-3_TX n (HT20) Mode 5785MHz	Tested Date	2019/5/9~11
Test Voltage	AC 120V/60Hz	Polarization	Vertical

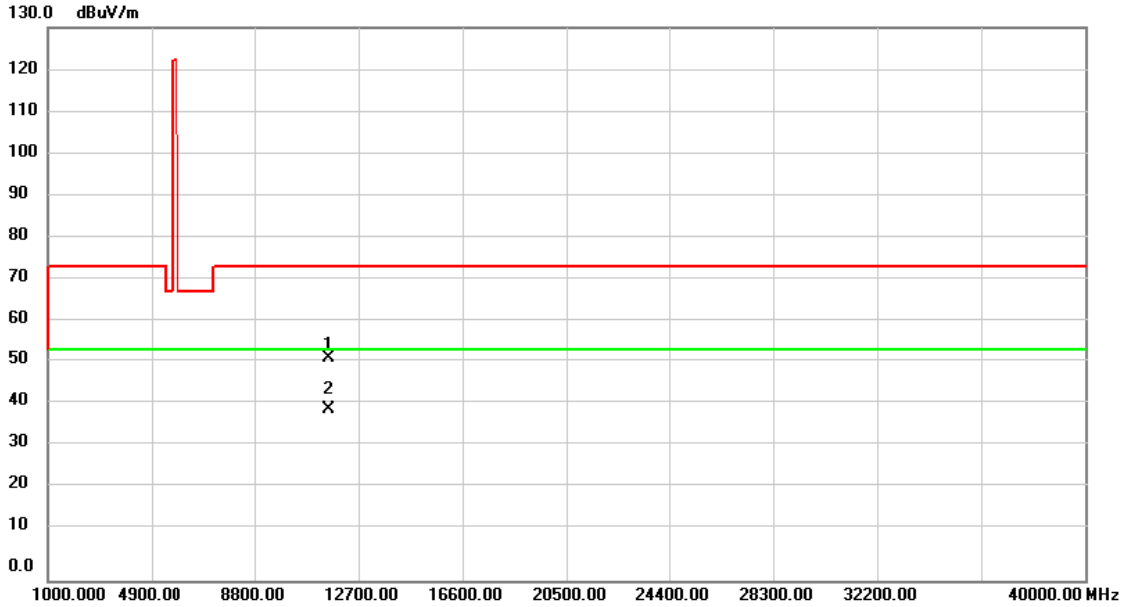

No.	Mk.	Freq. MHz	Reading Level dBuV	Correct Factor dB	Measure- ment dBuV/m	Limit dBuV/m	Over dB	Detector	Comment
1		11570.00	49.38	2.93	52.31	74.00	-21.69	peak	
2	*	11570.00	37.18	2.93	40.11	54.00	-13.89	AVG	

REMARKS:

- (1) Measurement Value = Reading Level + Correct Factor.
- (2) Margin Level = Measurement Value - Limit Value.

Test Mode	UNII-3_TX n (HT20) Mode 5785MHz	Tested Date	2019/5/9~11
Test Voltage	AC 120V/60Hz	Polarization	Horizontal

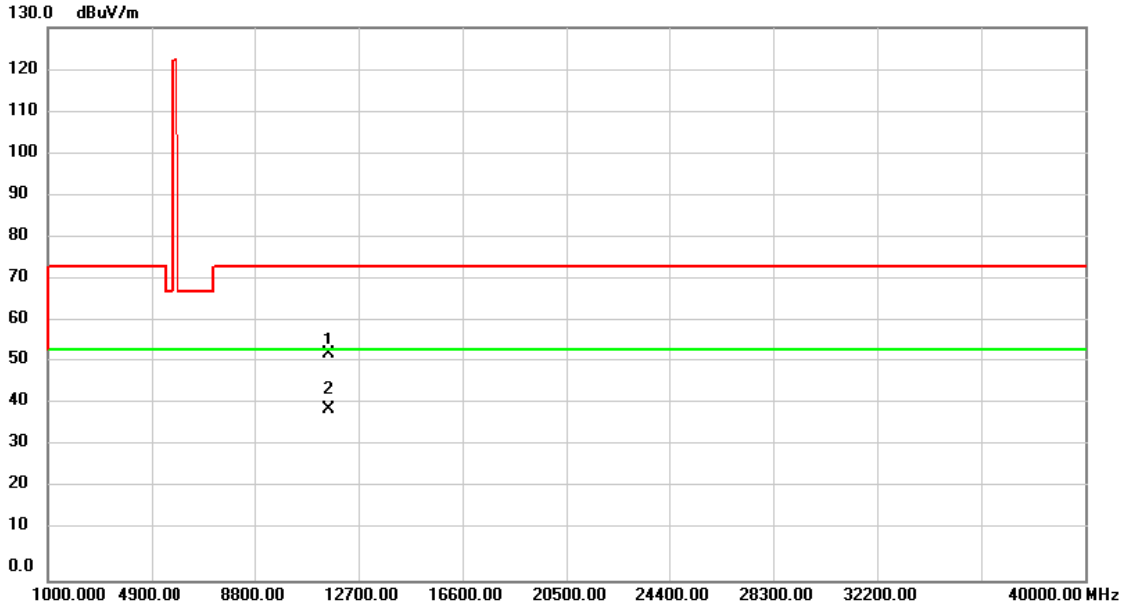

No.	Mk.	Freq. MHz	Reading Level dBuV	Correct Factor dB	Measure- ment dBuV/m	Limit dBuV/m	Over dB	Detector	Comment
1		11570.00	50.24	2.93	53.17	74.00	-20.83	peak	
2	*	11570.00	37.21	2.93	40.14	54.00	-13.86	AVG	

REMARKS:

- (1) Measurement Value = Reading Level + Correct Factor.
- (2) Margin Level = Measurement Value - Limit Value.

Test Mode	UNII-3_TX n (HT20)Mode 5825MHz	Tested Date	2019/5/9~11
Test Voltage	AC 120V/60Hz	Polarization	Vertical

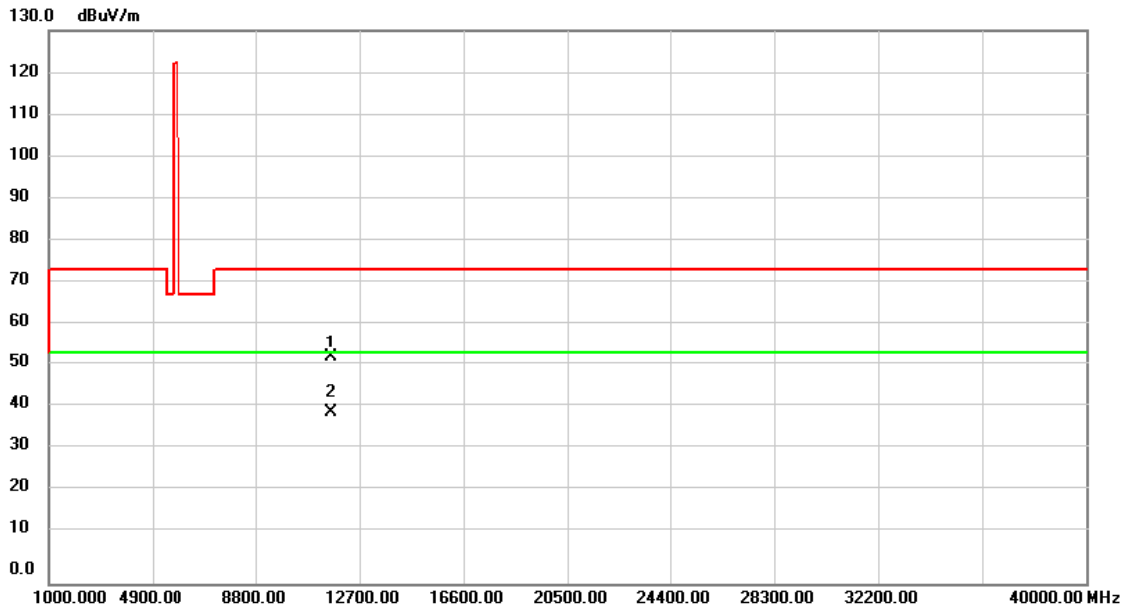

No.	Mk.	Freq. MHz	Reading Level dBuV	Correct Factor dB	Measure- ment dBuV/m	Limit dBuV/m	Over dB	Detector	Comment
1		11650.00	50.27	2.73	53.00	74.00	-21.00	peak	
2	*	11650.00	37.34	2.73	40.07	54.00	-13.93	AVG	

REMARKS:

- (1) Measurement Value = Reading Level + Correct Factor.
- (2) Margin Level = Measurement Value - Limit Value.

Test Mode	UNII-3_TX n (HT20)Mode 5825MHz	Tested Date	2019/5/9~11
Test Voltage	AC 120V/60Hz	Polarization	Horizontal

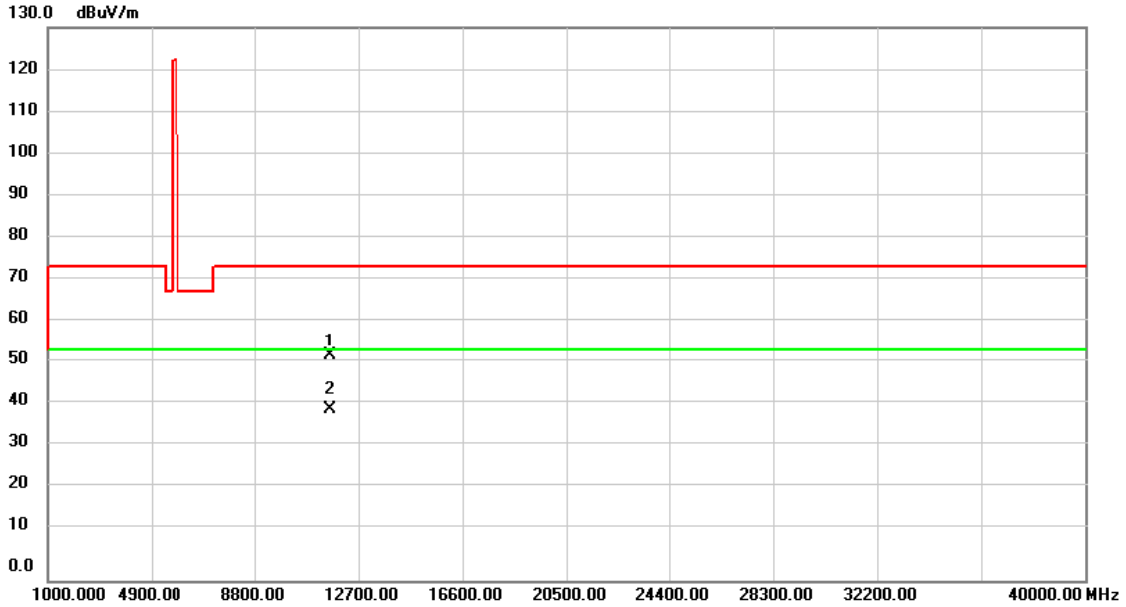

No.	Mk.	Freq. MHz	Reading Level dBuV	Correct Factor dB	Measure- ment dBuV/m	Limit dBuV/m	Over dB	Detector	Comment
1		11650.00	50.13	2.73	52.86	74.00	-21.14	peak	
2	*	11650.00	37.46	2.73	40.19	54.00	-13.81	AVG	

REMARKS:

- (1) Measurement Value = Reading Level + Correct Factor.
- (2) Margin Level = Measurement Value - Limit Value.

Test Mode	UNII-3_TX ac (VHT40) Mode 5755MHz	Tested Date	2019/5/9~11
Test Voltage	AC 120V/60Hz	Polarization	Vertical

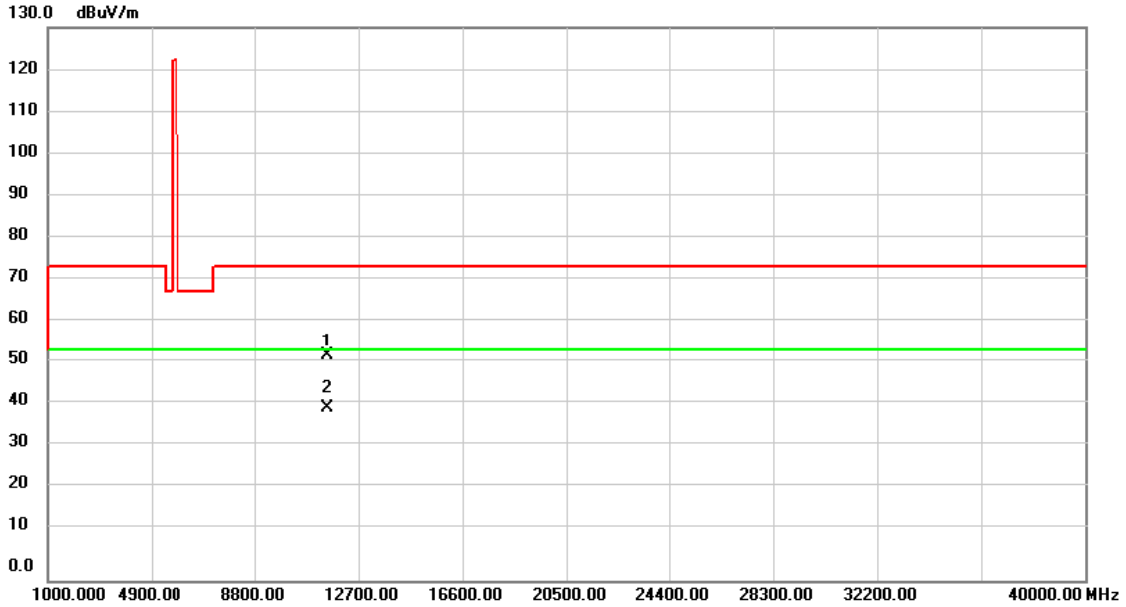

No.	Mk.	Freq. MHz	Reading Level dBuV	Correct Factor dB	Measure- ment dBuV/m	Limit dBuV/m	Over dB	Detector	Comment
1		11510.00	49.84	3.08	52.92	74.00	-21.08	peak	
2	*	11510.00	37.42	3.08	40.50	54.00	-13.50	AVG	

REMARKS:

- (1) Measurement Value = Reading Level + Correct Factor.
- (2) Margin Level = Measurement Value - Limit Value.

Test Mode	UNII-3_TX ac (VHT40) Mode 5755MHz	Tested Date	2019/5/9~11
Test Voltage	AC 120V/60Hz	Polarization	Horizontal

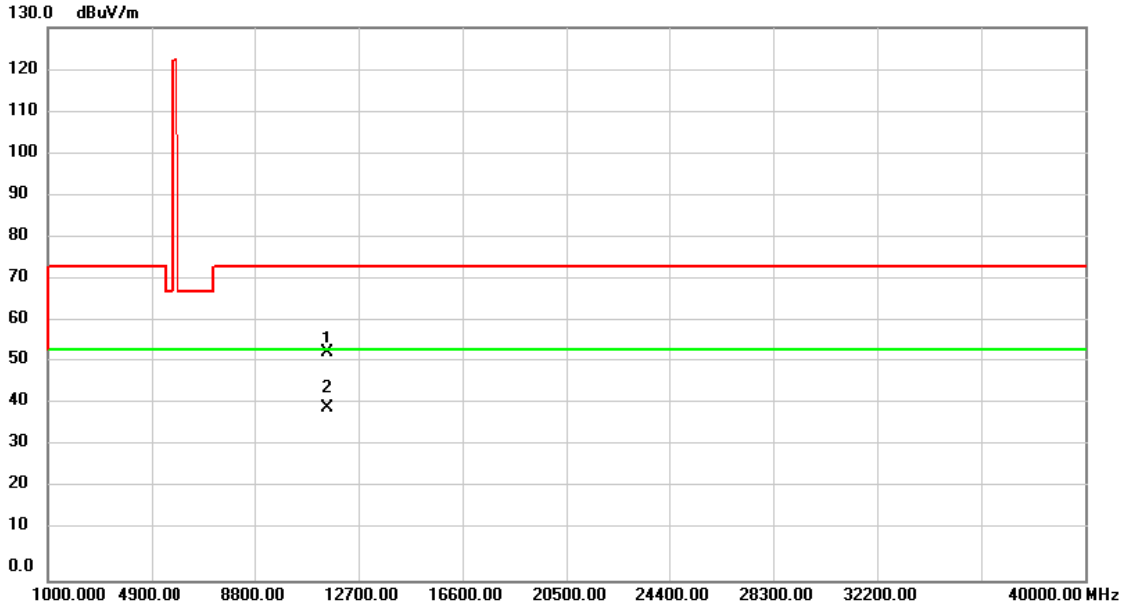

No.	Mk.	Freq. MHz	Reading Level dBuV	Correct Factor dB	Measure- ment dBuV/m	Limit dBuV/m	Over dB	Detector	Comment
1		11510.00	50.41	3.08	53.49	74.00	-20.51	peak	
2	*	11510.00	37.44	3.08	40.52	54.00	-13.48	AVG	

REMARKS:

- (1) Measurement Value = Reading Level + Correct Factor.
- (2) Margin Level = Measurement Value - Limit Value.

Test Mode	UNII-3_TX ac (VHT40) Mode 5795MHz	Tested Date	2019/5/9~11
Test Voltage	AC 120V/60Hz	Polarization	Vertical

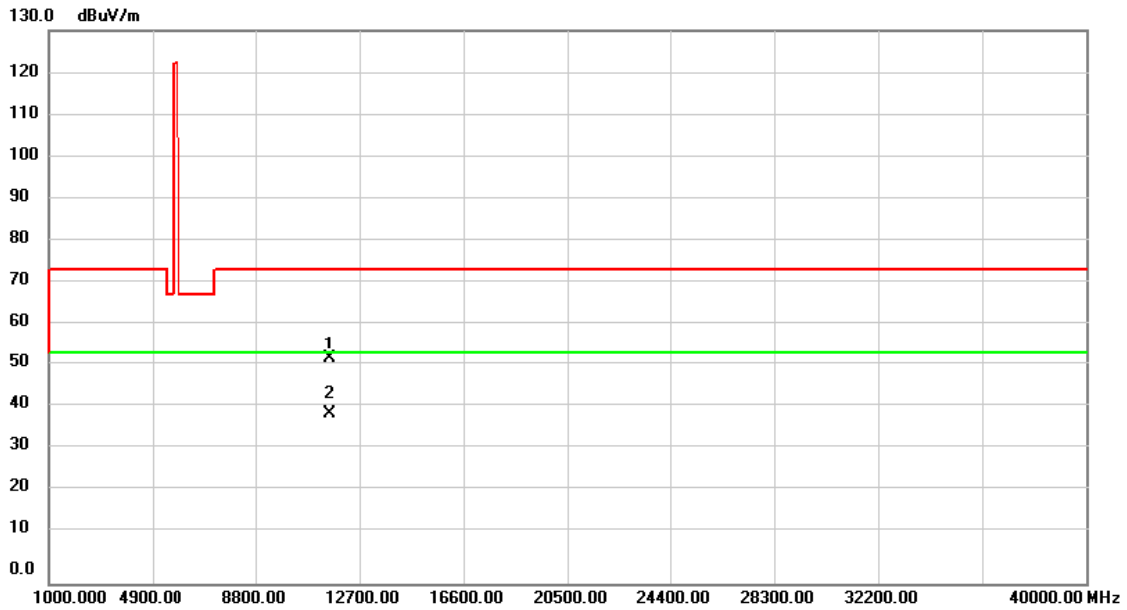

No.	Mk.	Freq. MHz	Reading Level dBuV	Correct Factor dB	Measure- ment dBuV/m	Limit dBuV/m	Over dB	Detector	Comment
1		11590.00	49.89	2.89	52.78	74.00	-21.22	peak	
2	*	11590.00	36.89	2.89	39.78	54.00	-14.22	AVG	

REMARKS:

- (1) Measurement Value = Reading Level + Correct Factor.
- (2) Margin Level = Measurement Value - Limit Value.

Test Mode	UNII-3_TX ac (VHT40) Mode 5795MHz	Tested Date	2019/5/9~11
Test Voltage	AC 120V/60Hz	Polarization	Horizontal

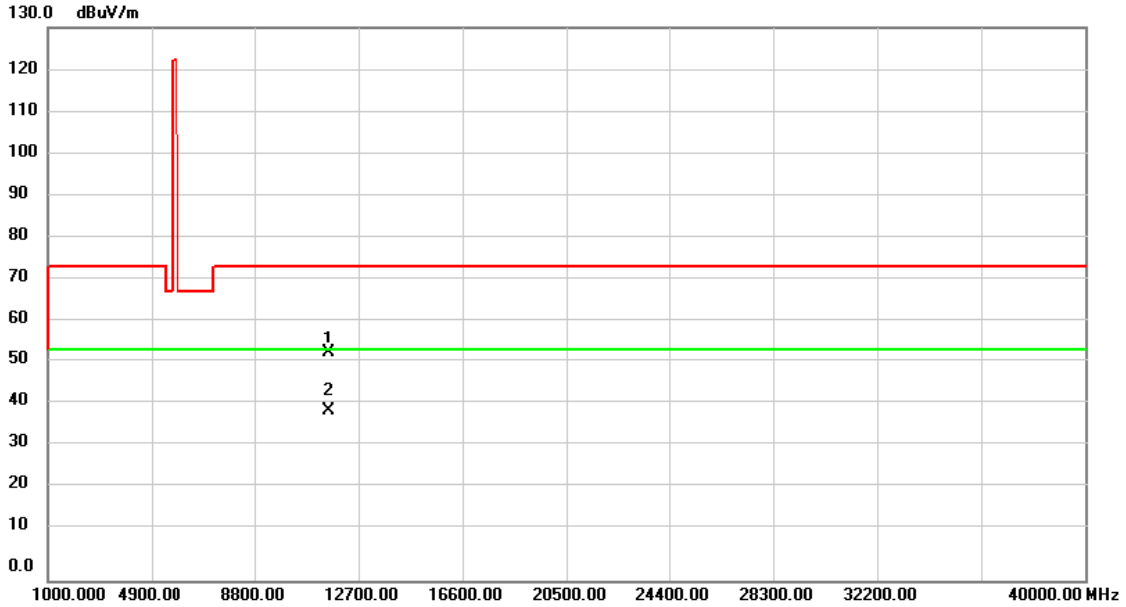

No.	Mk.	Freq. MHz	Reading Level dBuV	Correct Factor dB	Measure- ment dBuV/m	Limit dBuV/m	Over dB	Detector	Comment
1		11590.00	50.57	2.89	53.46	74.00	-20.54	peak	
2	*	11590.00	36.81	2.89	39.70	54.00	-14.30	AVG	

REMARKS:

- (1) Measurement Value = Reading Level + Correct Factor.
- (2) Margin Level = Measurement Value - Limit Value.

Test Mode	UNII-3_TX ac (VHT80) Mode 5775MHz	Tested Date	2019/5/9~11
Test Voltage	AC 120V/60Hz	Polarization	Vertical

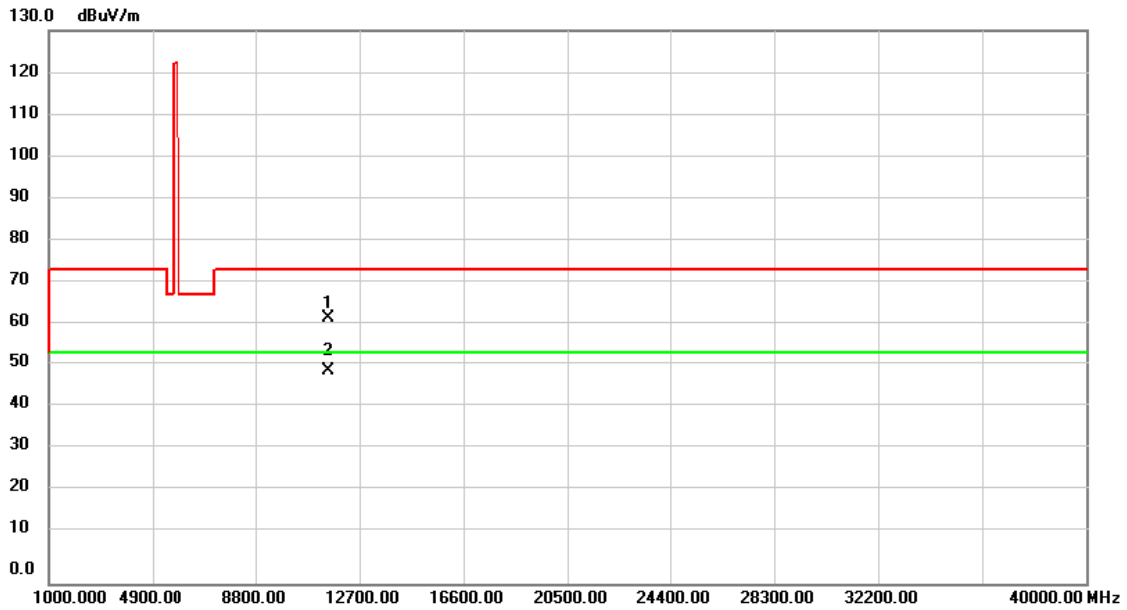

No.	Mk.	Freq. MHz	Reading Level dBuV	Correct Factor dB	Measure- ment dBuV/m	Limit dBuV/m	Over dB	Detector	Comment
1		11550.00	59.60	2.98	62.58	74.00	-11.42	peak	
2	*	11550.00	46.91	2.98	49.89	54.00	-4.11	AVG	

REMARKS:

- (1) Measurement Value = Reading Level + Correct Factor.
- (2) Margin Level = Measurement Value - Limit Value.

Test Mode	UNII-3_TX ac (VHT80) Mode 5775MHz	Tested Date	2019/5/9~11
Test Voltage	AC 120V/60Hz	Polarization	Horizontal

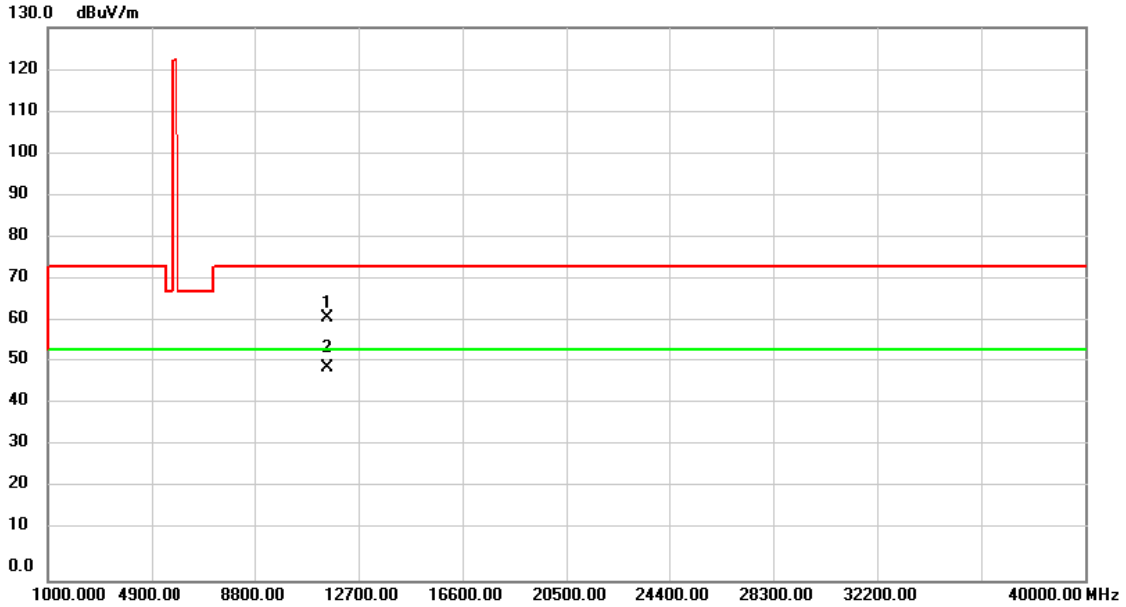

No.	Mk.	Freq. MHz	Reading Level dBuV	Correct Factor dB	Measure- ment dBuV/m	Limit dBuV/m	Over dB	Detector	Comment
1		11550.00	58.97	2.98	61.95	74.00	-12.05	peak	
2	*	11550.00	46.95	2.98	49.93	54.00	-4.07	AVG	

REMARKS:

- (1) Measurement Value = Reading Level + Correct Factor.
- (2) Margin Level = Measurement Value - Limit Value.

APPENDIX D BANDWIDTH

Test Mode	UNII-1_IIEEE 802.11a
Test Voltage	AC 120V/60Hz

Frequency (MHz)	26dB Bandwidth (MHz)	99% Occupied Bandwidth (MHz)
5180	21.95	17.40
5200	21.91	17.40
5240	21.86	17.40

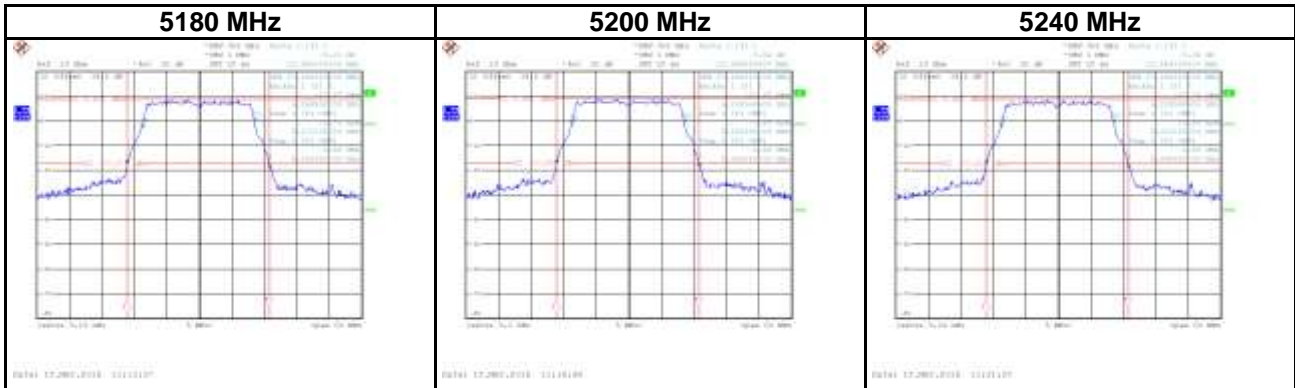

Test Mode	UNII-1_IIEEE 802.11n (HT20)
Test Voltage	AC 120V/60Hz

Frequency (MHz)	26dB Bandwidth (MHz)	99% Occupied Bandwidth (MHz)
5180	22.10	18.40
5200	22.09	18.40
5240	22.15	18.40

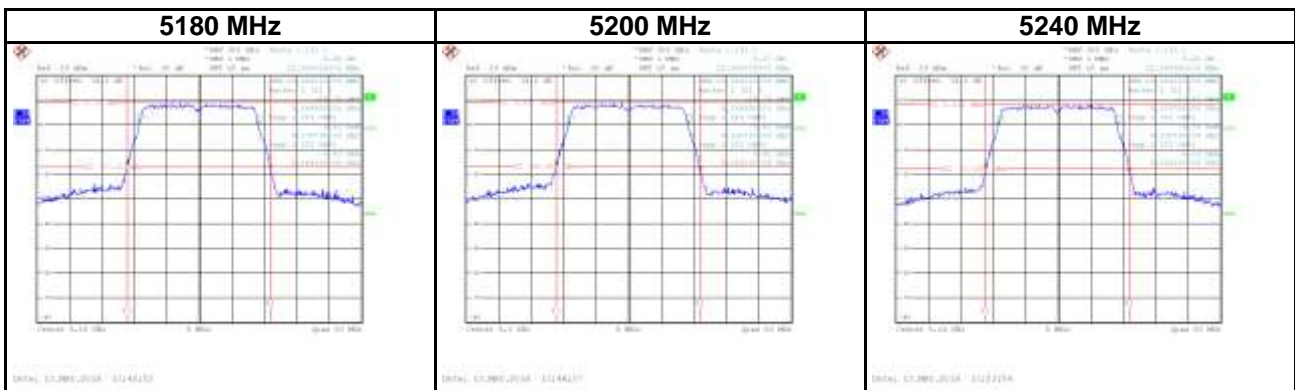

Test Mode	UNII-1_IEEE 802.11n (HT40)
Test Voltage	AC 120V/60Hz

Frequency (MHz)	26dB Bandwidth (MHz)	99% Occupied Bandwidth (MHz)
5190	41.81	37.00
5230	41.70	37.20



Test Mode	UNII-1_IEEE 802.11ac (VHT80)
Test Voltage	AC 120V/60Hz

Frequency (MHz)	26dB Bandwidth (MHz)	99% Occupied Bandwidth (MHz)
5210	82.81	76.40

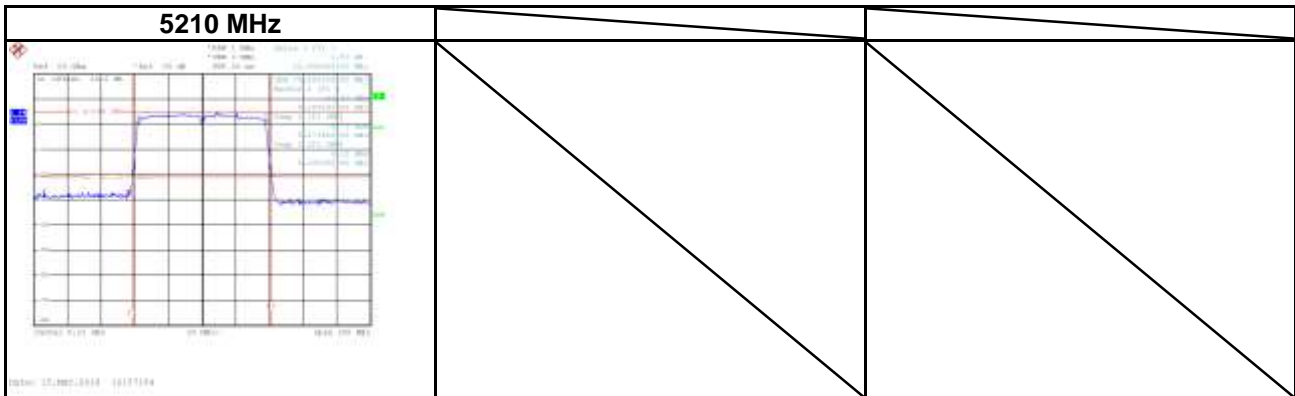

Test Mode	UNII-3_ IEEE 802.11a
Test Voltage	AC 120V/60Hz

Frequency (MHz)	6dB Bandwidth (MHz)	99% Occupied Bandwidth (MHz)
5745	16.45	16.60
5785	16.45	16.60
5825	16.45	16.60

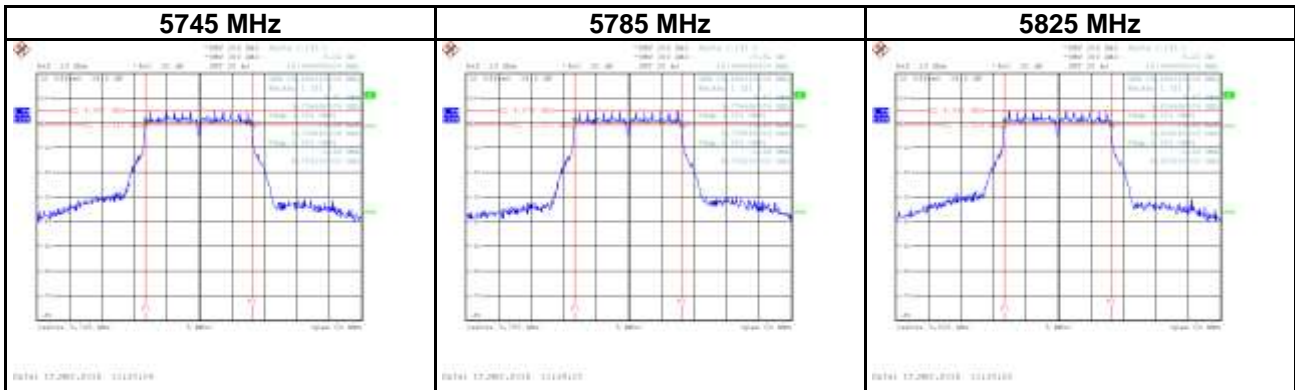

Test Mode	UNII-3_ IEEE 802.11n (HT20)
Test Voltage	AC 120V/60Hz

Frequency (MHz)	6dB Bandwidth (MHz)	99% Occupied Bandwidth (MHz)
5745	17.65	17.90
5785	17.65	17.80
5825	17.65	17.80

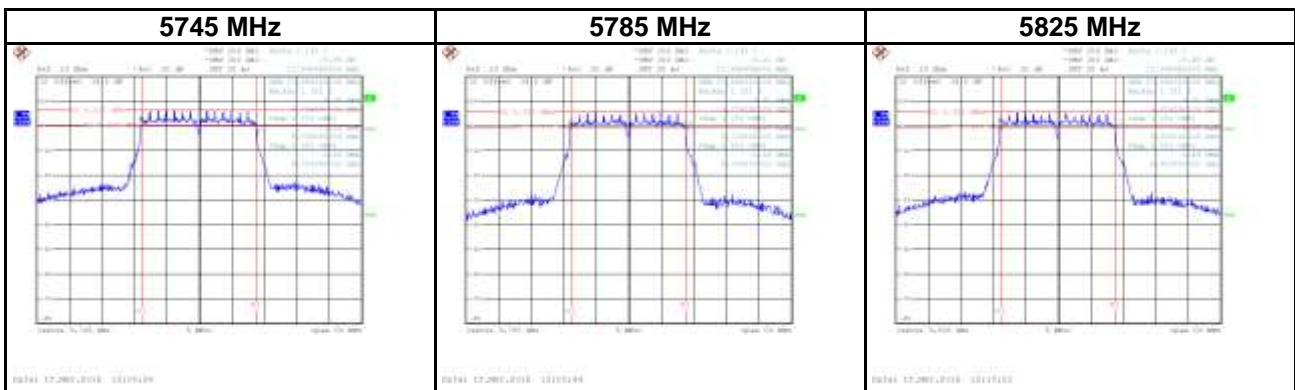

Test Mode	UNII-3_IEEE 802.11n (HT40)
Test Voltage	AC 120V/60Hz

Frequency (MHz)	6dB Bandwidth (MHz)	99% Occupied Bandwidth (MHz)
5755	36.61	36.20
5795	36.80	36.40

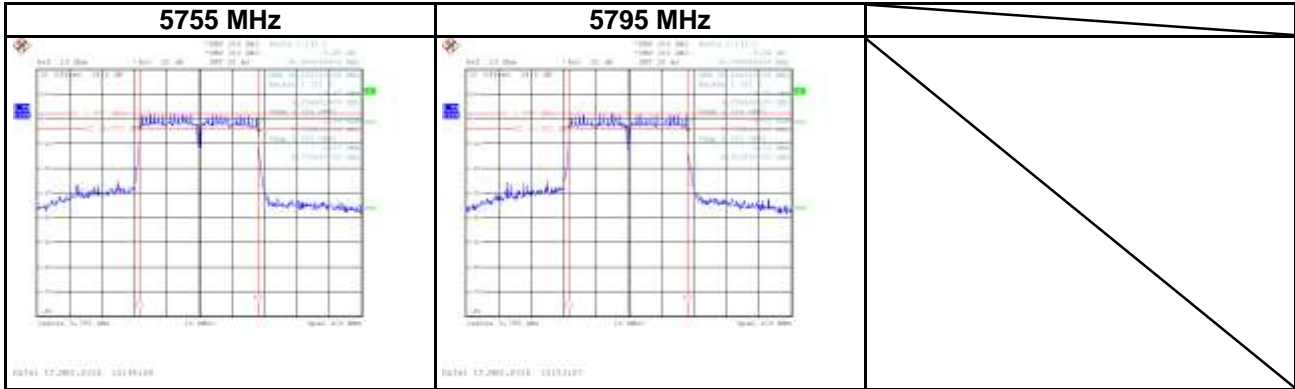

Test Mode	UNII-3_IEEE 802.11ac (VHT80)
Test Voltage	AC 120V/60Hz

Frequency (MHz)	6dB Bandwidth (MHz)	99% Occupied Bandwidth (MHz)
5775	76.00	76.00

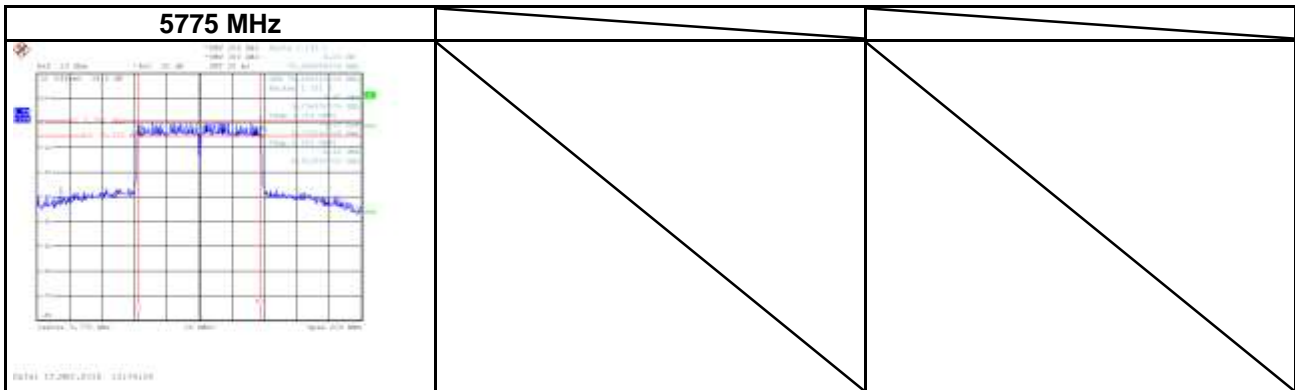

APPENDIX E CONDUCTED OUTPUT POWER

Test Mode	UNII-1_IEEE 802.11a_ANT 1	Tested Date	2019/9/20
Test Voltage	AC 120V/60Hz		

Frequency (MHz)	Conducted Power (dBm)	Conducted Power (W)	Max. Limit (dBm)	Max. Limit (W)	Result
5180	17.78	0.0600	24.00	0.2512	Complies
5200	17.77	0.0598	24.00	0.2512	Complies
5240	17.73	0.0593	24.00	0.2512	Complies

Test Mode	UNII-1_IEEE 802.11a_ANT 2	Tested Date	2019/9/20
Test Voltage	AC 120V/60Hz		

Frequency (MHz)	Conducted Power (dBm)	Conducted Power (W)	Max. Limit (dBm)	Max. Limit (W)	Result
5180	16.04	0.0402	24.00	0.2512	Complies
5200	16.18	0.0415	24.00	0.2512	Complies
5240	16.01	0.0399	24.00	0.2512	Complies

Test Mode	UNII-1_IEEE 802.11a_Total	Tested Date	2019/9/20
Test Voltage	AC 120V/60Hz		

Frequency (MHz)	Conducted Power (dBm)	Conducted Power (W)	Max. Limit (dBm)	Max. Limit (W)	Result
5180	20.01	0.1002	24.00	0.2512	Complies
5200	20.06	0.1013	24.00	0.2512	Complies
5240	19.96	0.0992	24.00	0.2512	Complies

Test Mode	UNII-1_IEEE 802.11n (HT20)_ANT 1	Tested Date	2019/9/20
Test Voltage	AC 120V/60Hz		

Frequency (MHz)	Conducted Power (dBm)	Conducted Power (W)	Max. Limit (dBm)	Max. Limit (W)	Result
5180	17.61	0.0577	24.00	0.2512	Complies
5200	17.70	0.0589	24.00	0.2512	Complies
5240	17.87	0.0612	24.00	0.2512	Complies

Test Mode	UNII-1_IEEE 802.11n (HT20)_ANT 2	Tested Date	2019/9/20
Test Voltage	AC 120V/60Hz		

Frequency (MHz)	Conducted Power (dBm)	Conducted Power (W)	Max. Limit (dBm)	Max. Limit (W)	Result
5180	15.59	0.0362	24.00	0.2512	Complies
5200	15.85	0.0385	24.00	0.2512	Complies
5240	15.52	0.0356	24.00	0.2512	Complies

Test Mode	UNII-1_IEEE 802.11n (HT20)_Total	Tested Date	2019/9/20
Test Voltage	AC 120V/60Hz		

Frequency (MHz)	Conducted Power (dBm)	Conducted Power (W)	Max. Limit (dBm)	Max. Limit (W)	Result
5180	19.73	0.0939	24.00	0.2512	Complies
5200	19.88	0.0973	24.00	0.2512	Complies
5240	19.86	0.0969	24.00	0.2512	Complies

Test Mode	UNII-1_IEEE 802.11ac (VHT20)_ANT 1	Tested Date	2019/9/20
Test Voltage	AC 120V/60Hz		

Frequency (MHz)	Conducted Power (dBm)	Conducted Power (W)	Max. Limit (dBm)	Max. Limit (W)	Result
5180	17.66	0.0583	24.00	0.2512	Complies
5200	17.88	0.0614	24.00	0.2512	Complies
5240	17.94	0.0622	24.00	0.2512	Complies

Test Mode	UNII-1_IEEE 802.11ac (VHT20)_ANT 2	Tested Date	2019/9/20
Test Voltage	AC 120V/60Hz		

Frequency (MHz)	Conducted Power (dBm)	Conducted Power (W)	Max. Limit (dBm)	Max. Limit (W)	Result
5180	15.82	0.0382	24.00	0.2512	Complies
5200	15.78	0.0378	24.00	0.2512	Complies
5240	15.62	0.0365	24.00	0.2512	Complies

Test Mode	UNII-1_IEEE 802.11ac (VHT20)_Total	Tested Date	2019/9/20
Test Voltage	AC 120V/60Hz		

Frequency (MHz)	Conducted Power (dBm)	Conducted Power (W)	Max. Limit (dBm)	Max. Limit (W)	Result
5180	19.85	0.0965	24.00	0.2512	Complies
5200	19.97	0.0992	24.00	0.2512	Complies
5240	19.94	0.0987	24.00	0.2512	Complies

Test Mode	UNII-1_IEEE 802.11n (HT40)_ANT 1	Tested Date	2019/9/20
Test Voltage	AC 120V/60Hz		

Frequency (MHz)	Conducted Power (dBm)	Conducted Power (W)	Max. Limit (dBm)	Max. Limit (W)	Result
5190	13.77	0.0238	24.00	0.2512	Complies
5230	17.94	0.0622	24.00	0.2512	Complies

Test Mode	UNII-1_IEEE 802.11n (HT40)_ANT 2	Tested Date	2019/9/20
Test Voltage	AC 120V/60Hz		

Frequency (MHz)	Conducted Power (dBm)	Conducted Power (W)	Max. Limit (dBm)	Max. Limit (W)	Result
5190	13.69	0.0234	24.00	0.2512	Complies
5230	16.50	0.0447	24.00	0.2512	Complies

Test Mode	UNII-1_IEEE 802.11n (HT40)_Total	Tested Date	2019/9/20
Test Voltage	AC 120V/60Hz		

Frequency (MHz)	Conducted Power (dBm)	Conducted Power (W)	Max. Limit (dBm)	Max. Limit (W)	Result
5190	16.74	0.0472	24.00	0.2512	Complies
5230	20.29	0.1069	24.00	0.2512	Complies

Test Mode	UNII-1_IEEE 802.11ac (VHT40)_ANT 1	Tested Date	2019/9/20
Test Voltage	AC 120V/60Hz		

Frequency (MHz)	Conducted Power (dBm)	Conducted Power (W)	Max. Limit (dBm)	Max. Limit (W)	Result
5190	13.84	0.0242	24.00	0.2512	Complies
5230	18.18	0.0658	24.00	0.2512	Complies

Test Mode	UNII-1_IEEE 802.11ac (VHT40)_ANT 2	Tested Date	2019/9/20
Test Voltage	AC 120V/60Hz		

Frequency (MHz)	Conducted Power (dBm)	Conducted Power (W)	Max. Limit (dBm)	Max. Limit (W)	Result
5190	17.03	0.0505	24.00	0.2512	Complies
5230	16.91	0.0491	24.00	0.2512	Complies

Test Mode	UNII-1_IEEE 802.11ac (VHT40)_Total	Tested Date	2019/9/20
Test Voltage	AC 120V/60Hz		

Frequency (MHz)	Conducted Power (dBm)	Conducted Power (W)	Max. Limit (dBm)	Max. Limit (W)	Result
5190	18.73	0.0747	24.00	0.2512	Complies
5230	20.60	0.1149	24.00	0.2512	Complies

Test Mode	UNII-1_IEEE 802.11ac (VHT80)_ANT 1	Tested Date	2019/9/20
Test Voltage	AC 120V/60Hz		

Frequency (MHz)	Conducted Power (dBm)	Conducted Power (W)	Max. Limit (dBm)	Max. Limit (W)	Result
5210	13.69	0.0234	24.00	0.2512	Complies

Test Mode	UNII-1_IEEE 802.11ac (VHT80)_ANT 2	Tested Date	2019/9/20
Test Voltage	AC 120V/60Hz		

Frequency (MHz)	Conducted Power (dBm)	Conducted Power (W)	Max. Limit (dBm)	Max. Limit (W)	Result
5210	13.67	0.0233	24.00	0.2512	Complies

Test Mode	UNII-1_IEEE 802.11ac (VHT80)_Total	Tested Date	2019/9/20
Test Voltage	AC 120V/60Hz		

Frequency (MHz)	Conducted Power (dBm)	Conducted Power (W)	Max. Limit (dBm)	Max. Limit (W)	Result
5210	16.69	0.0467	24.00	0.2512	Complies

Test Mode	UNII-3_IEEE 802.11a_ANT 1	Tested Date	2019/9/20
Test Voltage	AC 120V/60Hz		

Frequency (MHz)	Conducted Power (dBm)	Conducted Power (W)	Max. Limit (dBm)	Max. Limit (W)	Result
5745	17.24	0.0530	30.00	1.0000	Complies
5785	17.22	0.0527	30.00	1.0000	Complies
5825	17.01	0.0502	30.00	1.0000	Complies

Test Mode	UNII-3_IEEE 802.11a_ANT 2	Tested Date	2019/9/20
Test Voltage	AC 120V/60Hz		

Frequency (MHz)	Conducted Power (dBm)	Conducted Power (W)	Max. Limit (dBm)	Max. Limit (W)	Result
5745	9.37	0.0086	30.00	1.0000	Complies
5785	9.44	0.0088	30.00	1.0000	Complies
5825	9.86	0.0097	30.00	1.0000	Complies

Test Mode	UNII-3_IEEE 802.11a_Total	Tested Date	2019/9/20
Test Voltage	AC 120V/60Hz		

Frequency (MHz)	Conducted Power (dBm)	Conducted Power (W)	Max. Limit (dBm)	Max. Limit (W)	Result
5745	17.90	0.0616	30.00	1.0000	Complies
5785	17.89	0.0615	30.00	1.0000	Complies
5825	17.78	0.0599	30.00	1.0000	Complies

Test Mode	UNII-3_IEEE 802.11n (HT20)_ANT 1	Tested Date	2019/9/20
Test Voltage	AC 120V/60Hz		

Frequency (MHz)	Conducted Power (dBm)	Conducted Power (W)	Max. Limit (dBm)	Max. Limit (W)	Result
5745	18.37	0.0687	30.00	1.0000	Complies
5785	17.34	0.0542	30.00	1.0000	Complies
5825	17.37	0.0546	30.00	1.0000	Complies

Test Mode	UNII-3_IEEE 802.11n (HT20)_ANT 2	Tested Date	2019/9/20
Test Voltage	AC 120V/60Hz		

Frequency (MHz)	Conducted Power (dBm)	Conducted Power (W)	Max. Limit (dBm)	Max. Limit (W)	Result
5745	10.89	0.0123	30.00	1.0000	Complies
5785	9.93	0.0098	30.00	1.0000	Complies
5825	10.63	0.0116	30.00	1.0000	Complies

Test Mode	UNII-3_IEEE 802.11n (HT20)_Total	Tested Date	2019/9/20
Test Voltage	AC 120V/60Hz		

Frequency (MHz)	Conducted Power (dBm)	Conducted Power (W)	Max. Limit (dBm)	Max. Limit (W)	Result
5745	19.08	0.0810	30.00	1.0000	Complies
5785	18.06	0.0640	30.00	1.0000	Complies
5825	18.20	0.0661	30.00	1.0000	Complies

Test Mode	UNII-3_IIEEE 802.11ac (VHT20)_ANT 1	Tested Date	2019/9/20
Test Voltage	AC 120V/60Hz		

Frequency (MHz)	Conducted Power (dBm)	Conducted Power (W)	Max. Limit (dBm)	Max. Limit (W)	Result
5745	18.57	0.0719	30.00	1.0000	Complies
5785	17.38	0.0547	30.00	1.0000	Complies
5825	17.36	0.0545	30.00	1.0000	Complies

Test Mode	UNII-3_IIEEE 802.11ac (VHT20)_ANT 2	Tested Date	2019/9/20
Test Voltage	AC 120V/60Hz		

Frequency (MHz)	Conducted Power (dBm)	Conducted Power (W)	Max. Limit (dBm)	Max. Limit (W)	Result
5745	10.78	0.0120	30.00	1.0000	Complies
5785	10.12	0.0103	30.00	1.0000	Complies
5825	10.94	0.0124	30.00	1.0000	Complies

Test Mode	UNII-3_IIEEE 802.11ac (VHT20)_Total	Tested Date	2019/9/20
Test Voltage	AC 120V/60Hz		

Frequency (MHz)	Conducted Power (dBm)	Conducted Power (W)	Max. Limit (dBm)	Max. Limit (W)	Result
5745	19.24	0.0839	30.00	1.0000	Complies
5785	18.13	0.0650	30.00	1.0000	Complies
5825	18.25	0.0669	30.00	1.0000	Complies

Test Mode	UNII-3_IEEE 802.11n (HT40)_ANT 1	Tested Date	2019/9/20
Test Voltage	AC 120V/60Hz		

Frequency (MHz)	Conducted Power (dBm)	Conducted Power (W)	Max. Limit (dBm)	Max. Limit (W)	Result
5755	16.88	0.0488	30.00	1.0000	Complies
5795	16.97	0.0498	30.00	1.0000	Complies

Test Mode	UNII-3_IEEE 802.11n (HT40)_ANT 2	Tested Date	2019/9/20
Test Voltage	AC 120V/60Hz		

Frequency (MHz)	Conducted Power (dBm)	Conducted Power (W)	Max. Limit (dBm)	Max. Limit (W)	Result
5755	9.53	0.0090	30.00	1.0000	Complies
5795	9.83	0.0096	30.00	1.0000	Complies

Test Mode	UNII-3_IEEE 802.11n (HT40)_Total	Tested Date	2019/9/20
Test Voltage	AC 120V/60Hz		

Frequency (MHz)	Conducted Power (dBm)	Conducted Power (W)	Max. Limit (dBm)	Max. Limit (W)	Result
5755	17.61	0.0577	30.00	1.0000	Complies
5795	17.74	0.0594	30.00	1.0000	Complies

Test Mode	UNII-3_IIEEE 802.11ac (VHT40)_ANT 1	Tested Date	2019/9/20
Test Voltage	AC 120V/60Hz		

Frequency (MHz)	Conducted Power (dBm)	Conducted Power (W)	Max. Limit (dBm)	Max. Limit (W)	Result
5755	13.78	0.0239	30.00	1.0000	Complies
5795	16.38	0.0435	30.00	1.0000	Complies

Test Mode	UNII-3_IIEEE 802.11ac (VHT40)_ANT 2	Tested Date	2019/9/20
Test Voltage	AC 120V/60Hz		

Frequency (MHz)	Conducted Power (dBm)	Conducted Power (W)	Max. Limit (dBm)	Max. Limit (W)	Result
5755	9.78	0.0095	30.00	1.0000	Complies
5795	10.21	0.0105	30.00	1.0000	Complies

Test Mode	UNII-3_IIEEE 802.11ac (VHT40)_Total	Tested Date	2019/9/20
Test Voltage	AC 120V/60Hz		

Frequency (MHz)	Conducted Power (dBm)	Conducted Power (W)	Max. Limit (dBm)	Max. Limit (W)	Result
5755	15.24	0.0334	30.00	1.0000	Complies
5795	17.32	0.0539	30.00	1.0000	Complies

Test Mode	UNII-3_IEEE 802.11ac (VHT80)_ANT 1	Tested Date	2019/9/20
Test Voltage	AC 120V/60Hz		

Frequency (MHz)	Conducted Power (dBm)	Conducted Power (W)	Max. Limit (dBm)	Max. Limit (W)	Result
5775	16.28	0.0425	30.00	1.0000	Complies

Test Mode	UNII-3_IEEE 802.11ac (VHT80)_ANT 2	Tested Date	2019/9/20
Test Voltage	AC 120V/60Hz		

Frequency (MHz)	Conducted Power (dBm)	Conducted Power (W)	Max. Limit (dBm)	Max. Limit (W)	Result
5775	9.15	0.0082	30.00	1.0000	Complies

Test Mode	UNII-3_IEEE 802.11ac (VHT80)_Total	Tested Date	2019/9/20
Test Voltage	AC 120V/60Hz		

Frequency (MHz)	Conducted Power (dBm)	Conducted Power (W)	Max. Limit (dBm)	Max. Limit (W)	Result
5775	17.05	0.0507	30.00	1.0000	Complies

APPENDIX F POWER SPECTRAL DENSITY

Test Mode	UNII-1_IEEE 802.11a_ANT 1
Test Voltage	AC 120V/60Hz

Frequency (MHz)	Power Density (dBm/MHz)	Duty Factor (dB)	Power Density+ Duty Factor (dBm/MHz)	Limit (dBm/MHz)	Result
5180	4.61	0.27	4.88	14.93	Complies
5200	4.71	0.27	4.98	14.93	Complies
5240	4.44	0.27	4.71	14.93	Complies

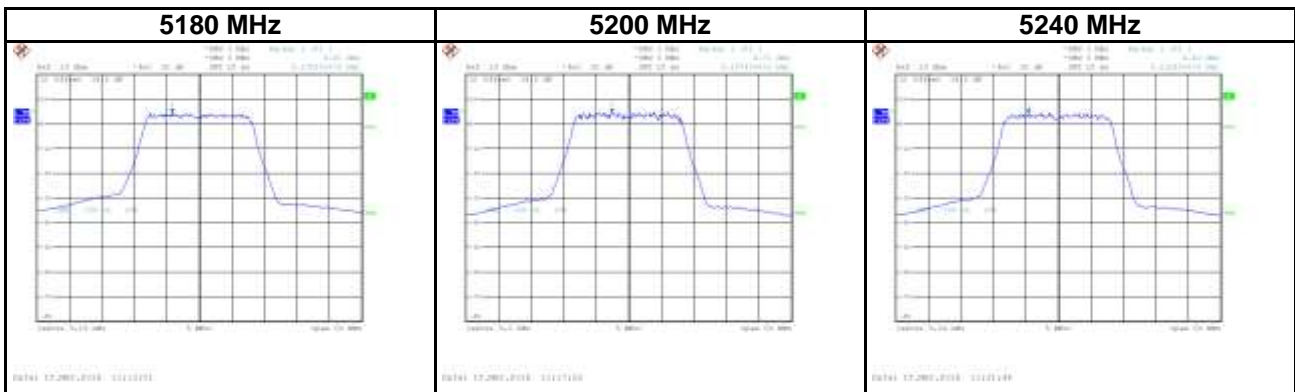

Test Mode	UNII-1_IEEE 802.11a_ANT 2
Test Voltage	AC 120V/60Hz

Frequency (MHz)	Power Density (dBm/MHz)	Duty Factor (dB)	Power Density+ Duty Factor (dBm/MHz)	Limit (dBm/MHz)	Result
5180	3.73	0.27	4.00	14.93	Complies
5200	3.77	0.27	4.04	14.93	Complies
5240	3.75	0.27	4.02	14.93	Complies

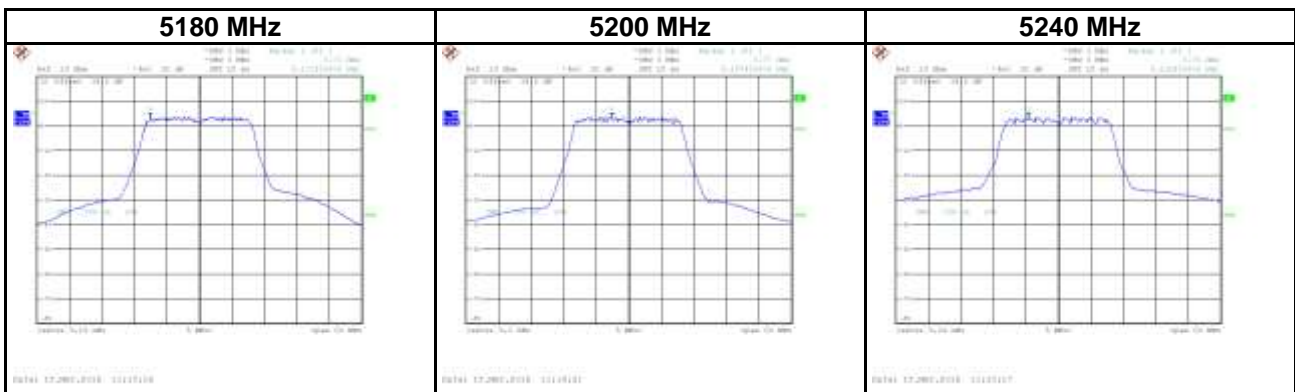

Test Mode	UNII-1_IEEE 802.11a_Total
Test Voltage	AC 120V/60Hz

Frequency (MHz)	Power Density (dBm/MHz)	Duty Factor (dB)	Power Density+ Duty Factor (dBm/MHz)	Limit (dBm/MHz)	Result
5180	7.20	0.27	7.47	14.93	Complies
5200	7.28	0.27	7.54	14.93	Complies
5240	7.12	0.27	7.39	14.93	Complies

Test Mode	UNII-1_IEEE 802.11n (HT20)_ANT 1
Test Voltage	AC 120V/60Hz

Frequency (MHz)	Power Density (dBm/MHz)	Duty Factor (dB)	Power Density+ Duty Factor (dBm/MHz)	Limit (dBm/MHz)	Result
5180	4.95	0.15	5.10	14.93	Complies
5200	4.87	0.15	5.02	14.93	Complies
5240	4.48	0.15	4.63	14.93	Complies

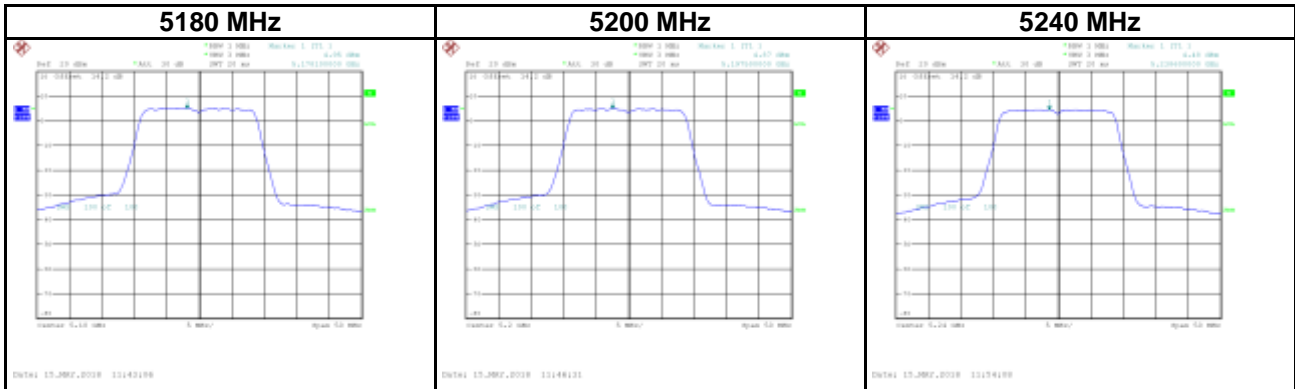

Test Mode	UNII-1_IEEE 802.11n (HT20)_ANT 2
Test Voltage	AC 120V/60Hz

Frequency (MHz)	Power Density (dBm/MHz)	Duty Factor (dB)	Power Density+ Duty Factor (dBm/MHz)	Limit (dBm/MHz)	Result
5180	4.08	0.15	4.23	14.93	Complies
5200	3.82	0.15	3.97	14.93	Complies
5240	3.80	0.15	3.95	14.93	Complies

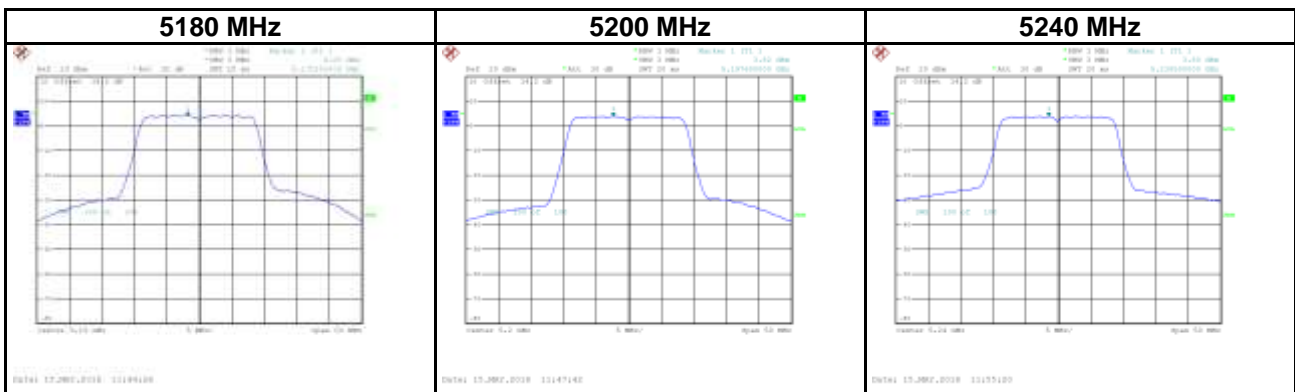

Test Mode	UNII-1_IEEE 802.11n (HT20)_Total
Test Voltage	AC 120V/60Hz

Frequency (MHz)	Power Density (dBm/MHz)	Duty Factor (dB)	Power Density+ Duty Factor (dBm/MHz)	Limit (dBm/MHz)	Result
5180	7.55	0.15	7.69	14.93	Complies
5200	7.39	0.15	7.53	14.93	Complies
5240	7.16	0.15	7.31	14.93	Complies

Test Mode	UNII-1_IEEE 802.11n (HT40)_ANT 1
Test Voltage	AC 120V/60Hz

Frequency (MHz)	Power Density (dBm/MHz)	Duty Factor (dB)	Power Density+ Duty Factor (dBm/MHz)	Limit (dBm/MHz)	Result
5190	-1.77	0.29	-1.48	14.93	Complies
5230	1.74	0.29	2.03	14.93	Complies

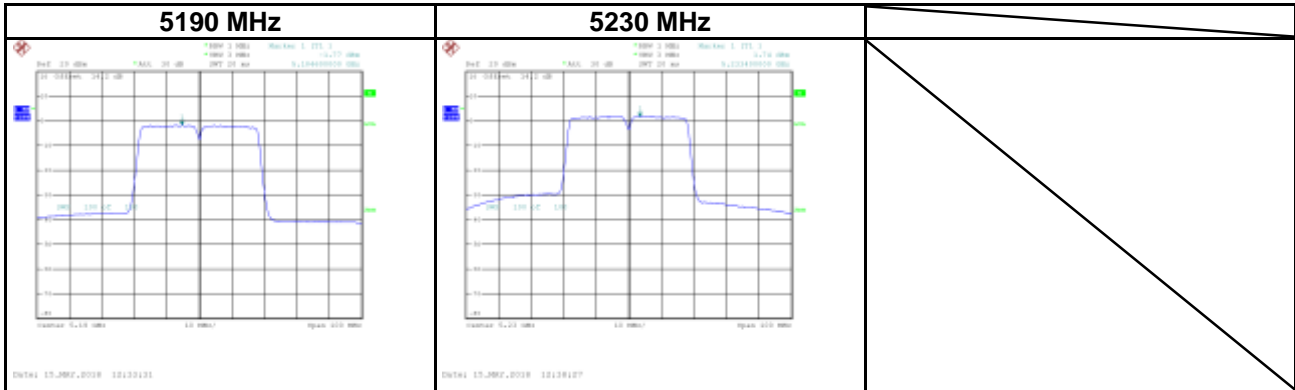

Test Mode	UNII-1_IEEE 802.11n (HT40)_ANT 2
Test Voltage	AC 120V/60Hz

Frequency (MHz)	Power Density (dBm/MHz)	Duty Factor (dB)	Power Density+ Duty Factor (dBm/MHz)	Limit (dBm/MHz)	Result
5190	-2.32	0.29	-2.03	14.93	Complies
5230	1.47	0.29	1.76	14.93	Complies



Test Mode	UNII-1_IEEE 802.11n (HT40)_Total
Test Voltage	AC 120V/60Hz

Frequency (MHz)	Power Density (dBm/MHz)	Duty Factor (dB)	Power Density+ Duty Factor (dBm/MHz)	Limit (dBm/MHz)	Result
5190	0.97	0.29	1.26	14.93	Complies
5230	4.62	0.29	4.91	14.93	Complies

Test Mode	UNII-1_IEEE 802.11ac (VHT80)_ANT 1
Test Voltage	AC 120V/60Hz

Frequency (MHz)	Power Density (dBm/MHz)	Duty Factor (dB)	Power Density+ Duty Factor (dBm/MHz)	Limit (dBm/MHz)	Result
5210	-5.29	0.61	-4.68	14.93	Complies

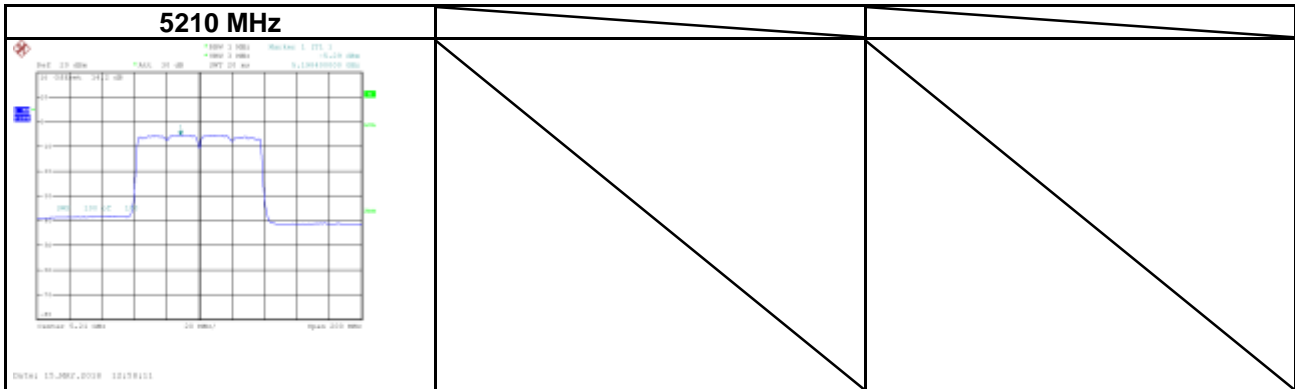

Test Mode	UNII-1_IEEE 802.11ac (VHT80)_ANT 2
Test Voltage	AC 120V/60Hz

Frequency (MHz)	Power Density (dBm/MHz)	Duty Factor (dB)	Power Density+ Duty Factor (dBm/MHz)	Limit (dBm/MHz)	Result
5210	-5.46	0.61	-4.85	14.93	Complies

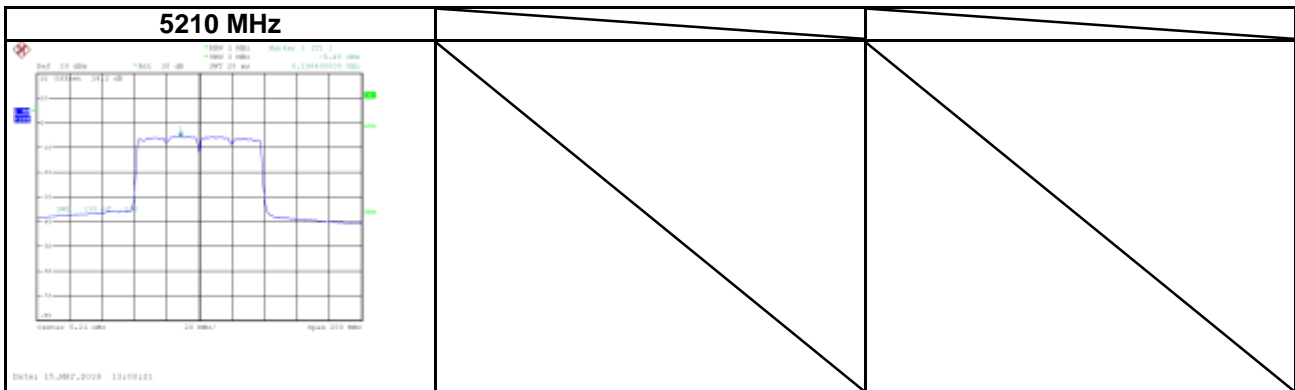

Test Mode	UNII-1_IEEE 802.11ac (VHT80)_Total
Test Voltage	AC 120V/60Hz

Frequency (MHz)	Power Density (dBm/MHz)	Duty Factor (dB)	Power Density+ Duty Factor (dBm/MHz)	Limit (dBm/MHz)	Result
5210	-2.36	0.61	-1.75	14.93	Complies

Test Mode	UNII-3_IEEE 802.11a_ANT 1
Test Voltage	AC 120V/60Hz

Frequency (MHz)	Power Density (dBm/500 kHz)	Duty Factor (dB)	Power Density+ Duty Factor (dBm/500 kHz)	Limit (dBm/500 kHz)	Result
5745	1.10	0.27	1.37	27.93	Complies
5785	0.73	0.27	1.00	27.93	Complies
5825	1.07	0.27	1.34	27.93	Complies

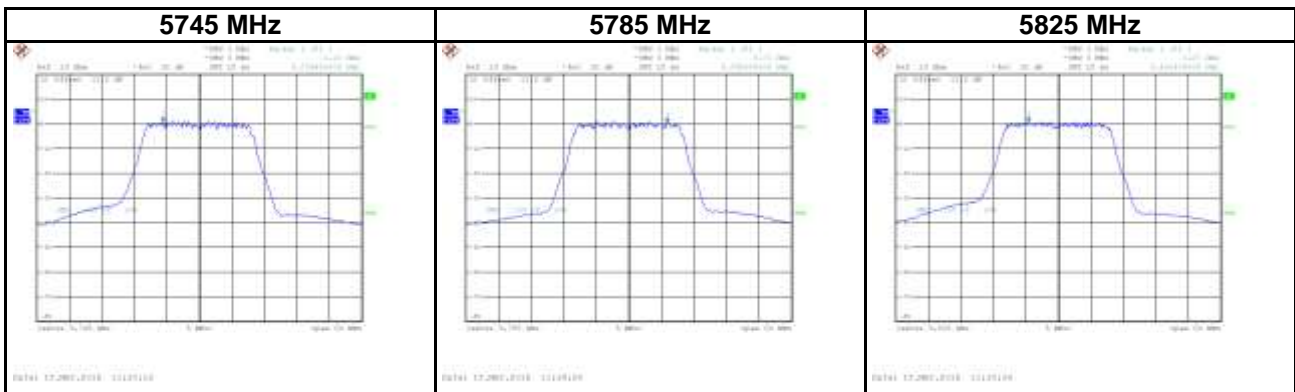

Test Mode	UNII-3_IEEE 802.11a_ANT 2
Test Voltage	AC 120V/60Hz

Frequency (MHz)	Power Density (dBm/500 kHz)	Duty Factor (dB)	Power Density+ Duty Factor (dBm/500 kHz)	Limit (dBm/500 kHz)	Result
5745	-0.75	0.27	-0.48	27.93	Complies
5785	-0.68	0.27	-0.41	27.93	Complies
5825	-0.82	0.27	-0.55	27.93	Complies

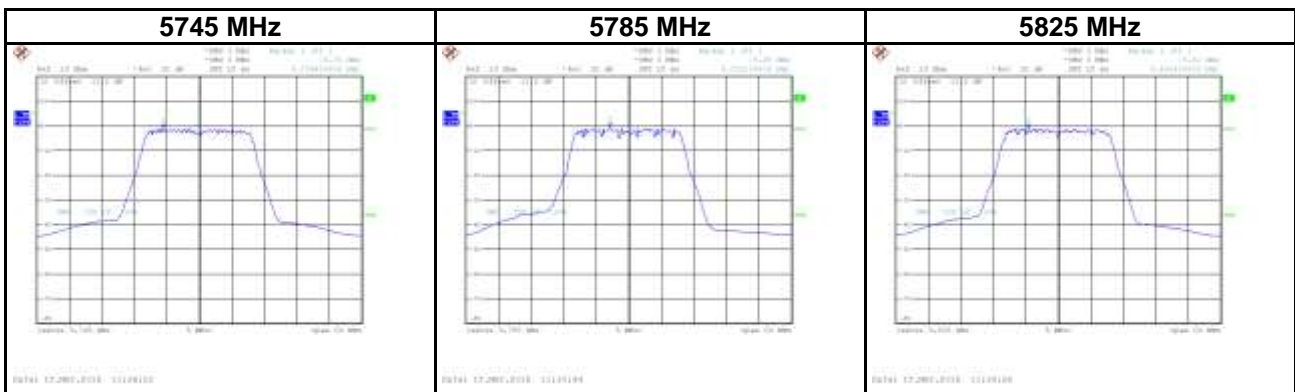

Test Mode	UNII-3_IEEE 802.11a_Total
Test Voltage	AC 120V/60Hz

Frequency (MHz)	Power Density (dBm/500 kHz)	Duty Factor (dB)	Power Density+ Duty Factor (dBm/500 kHz)	Limit (dBm/500 kHz)	Result
5745	3.28	0.27	3.55	27.93	Complies
5785	3.09	0.27	3.36	27.93	Complies
5825	3.24	0.27	3.50	27.93	Complies

Test Mode	UNII-3_IEEE 802.11n (HT20)_ANT 1
Test Voltage	AC 120V/60Hz

Frequency (MHz)	Power Density (dBm/500 kHz)	Duty Factor (dB)	Power Density+ Duty Factor (dBm/500 kHz)	Limit (dBm/500 kHz)	Result
5745	2.45	0.15	2.60	27.93	Complies
5785	1.33	0.15	1.48	27.93	Complies
5825	1.60	0.15	1.75	27.93	Complies

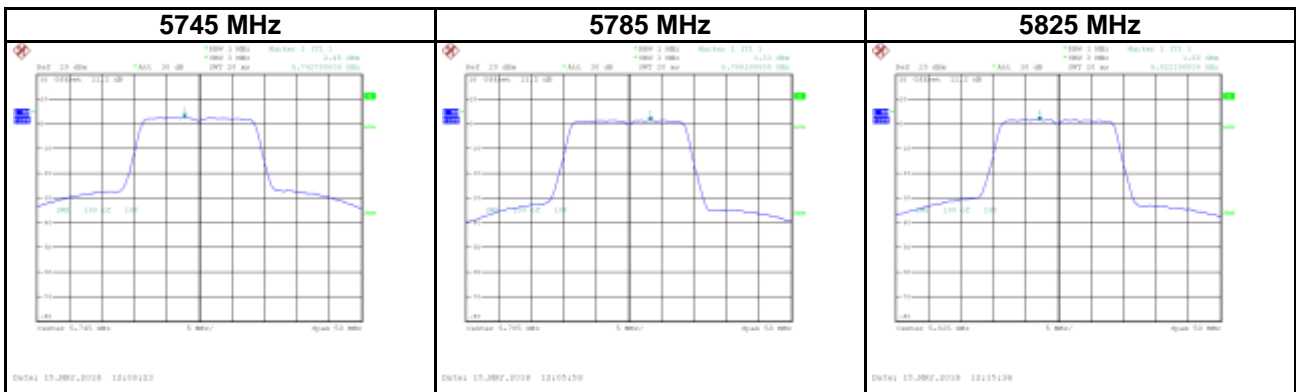

Test Mode	UNII-3_IEEE 802.11n (HT20)_ANT 2
Test Voltage	AC 120V/60Hz

Frequency (MHz)	Power Density (dBm/500 kHz)	Duty Factor (dB)	Power Density+ Duty Factor (dBm/500 kHz)	Limit (dBm/500 kHz)	Result
5745	0.91	0.15	1.06	27.93	Complies
5785	-0.24	0.15	-0.09	27.93	Complies
5825	-0.29	0.15	-0.14	27.93	Complies

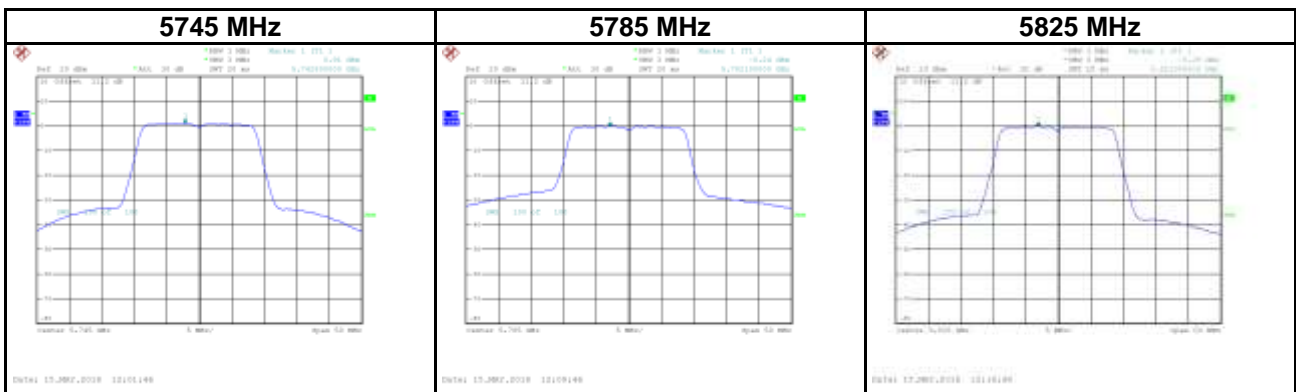

Test Mode	UNII-3_IEEE 802.11n (HT20)_Total
Test Voltage	AC 120V/60Hz

Frequency (MHz)	Power Density (dBm/500 kHz)	Duty Factor (dB)	Power Density+ Duty Factor (dBm/500 kHz)	Limit (dBm/500 kHz)	Result
5745	4.76	0.15	4.91	27.93	Complies
5785	3.63	0.15	3.77	27.93	Complies
5825	3.77	0.15	3.91	27.93	Complies

Test Mode	UNII-3_IEEE 802.11n (HT40)_ANT 1
Test Voltage	AC 120V/60Hz

Frequency (MHz)	Power Density (dBm/500 kHz)	Duty Factor (dB)	Power Density+ Duty Factor (dBm/500 kHz)	Limit (dBm/500 kHz)	Result
5755	-1.95	0.29	-1.66	27.93	Complies
5795	-2.07	0.29	-1.78	27.93	Complies

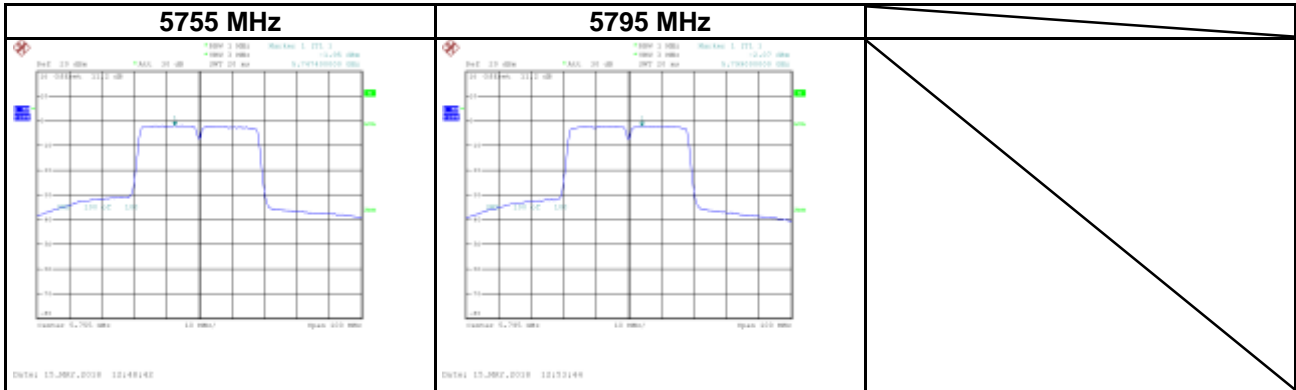

Test Mode	UNII-3_IEEE 802.11n (HT40)_ANT 2
Test Voltage	AC 120V/60Hz

Frequency (MHz)	Power Density (dBm/500 kHz)	Duty Factor (dB)	Power Density+ Duty Factor (dBm/500 kHz)	Limit (dBm/500 kHz)	Result
5755	-3.13	0.29	-2.84	27.93	Complies
5795	-3.52	0.29	-3.23	27.93	Complies

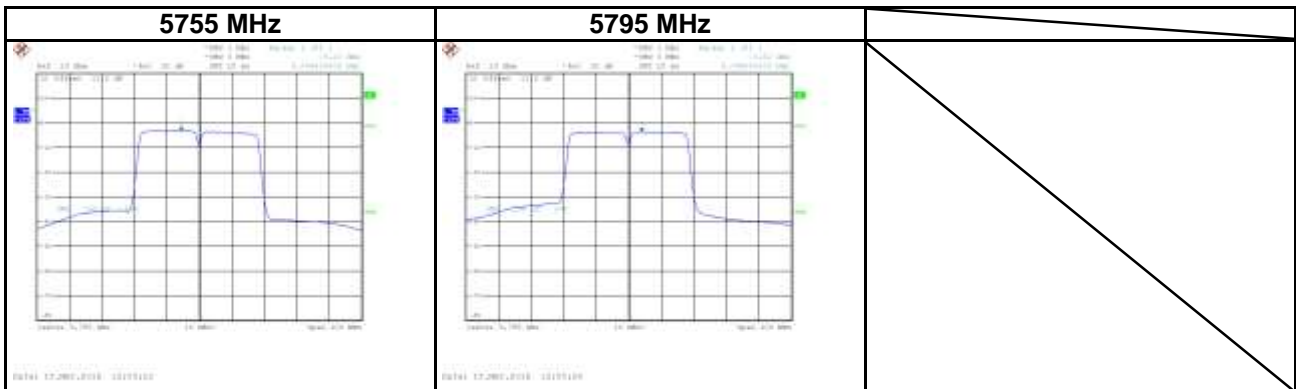

Test Mode	UNII-3_IEEE 802.11n (HT40)_Total
Test Voltage	AC 120V/60Hz

Frequency (MHz)	Power Density (dBm/500 kHz)	Duty Factor (dB)	Power Density+ Duty Factor (dBm/500 kHz)	Limit (dBm/500 kHz)	Result
5755	0.51	0.29	0.80	27.93	Complies
5795	0.28	0.29	0.57	27.93	Complies

Test Mode	UNII-3_IIEEE 802.11ac (VHT80)_ANT 1
Test Voltage	AC 120V/60Hz

Frequency (MHz)	Power Density (dBm/500 kHz)	Duty Factor (dB)	Power Density+ Duty Factor (dBm/500 kHz)	Limit (dBm/500 kHz)	Result
5775	-4.20	0.61	-3.59	27.93	Complies

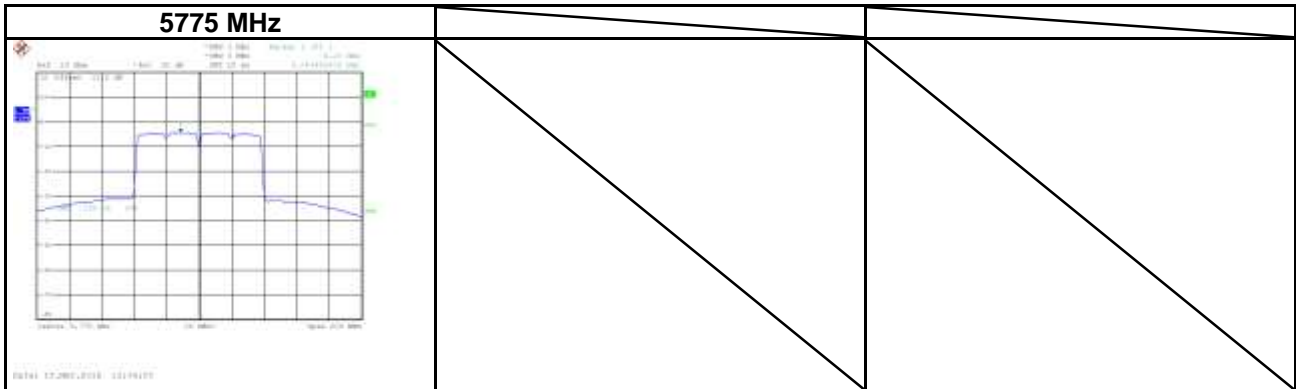

Test Mode	UNII-3_IIEEE 802.11ac (VHT80)_ANT 2
Test Voltage	AC 120V/60Hz

Frequency (MHz)	Power Density (dBm/500 kHz)	Duty Factor (dB)	Power Density+ Duty Factor (dBm/500 kHz)	Limit (dBm/500 kHz)	Result
5775	-5.24	0.61	-4.63	27.93	Complies

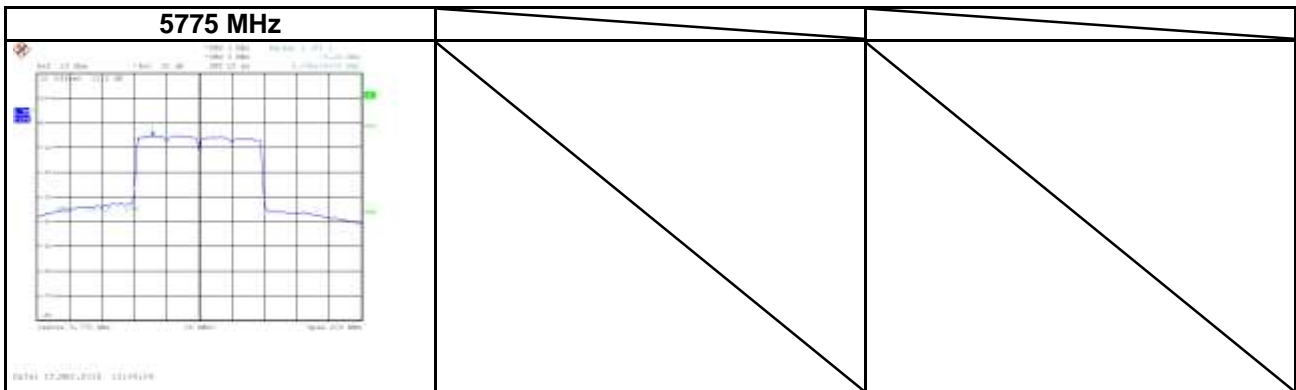

Test Mode	UNII-3_IIEEE 802.11ac (VHT80)_Total
Test Voltage	AC 120V/60Hz

Frequency (MHz)	Power Density (dBm/500 kHz)	Duty Factor (dB)	Power Density+ Duty Factor (dBm/500 kHz)	Limit (dBm/500 kHz)	Result
5775	-1.68	0.61	-1.07	27.93	Complies

APPENDIX G FREQUENCY STABILITY

Test Mode	UNII-1_IEEE 802.11a	Tested Date	2019/9/20
Test Voltage	AC 120V/60Hz		

Voltage vs. Frequency Stability

Operating Frequency	5180
Voltage (V)	Measurement Frequency (MHz)
132	5180.0000
120	5179.9008
108	5179.9008
Maximum Deviation (MHz)	5179.9020
Maximum Deviation (ppm)	0.0992

Temperature vs. Frequency Stability

Operating Frequency	5180
Temperature (°C)	Measurement Frequency (MHz)
0	5180.0000
10	5179.9056
20	5179.9040
30	5179.9024
40	5179.9016
Maximum Deviation (MHz)	5179.9008
Maximum Deviation (ppm)	0.0992

Test Mode	UNII-3_IEEE 802.11a	Tested Date	2019/9/20
Test Voltage	AC 120V/60Hz		

Voltage vs. Frequency Stability

Operating Frequency	5745
Voltage (V)	Measurement Frequency (MHz)
132	5745.0000
120	5744.8900
108	5744.8904
Maximum Deviation (MHz)	5744.8912
Maximum Deviation (ppm)	0.1100

Temperature vs. Frequency Stability

Operating Frequency	5745
Temperature (°C)	Measurement Frequency (MHz)
0	5745.0000
10	5744.8932
20	5744.8920
30	5744.8916
40	5744.8912
Maximum Deviation (MHz)	5744.8908
Maximum Deviation (ppm)	0.1092

End of Test Report