

**SC4507**

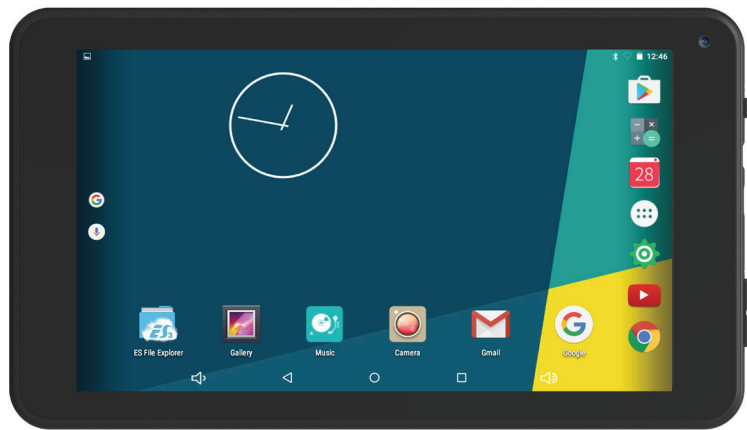

## **Internet Tablet Quick Start Guide**

Please read carefully before use

# U Table of Contents

<b>THANK YOU .....</b>	<b>3</b>	<b>CONNECTING TO THE INTERNET .....</b>	<b>19</b>
Package Contents.....	3	Requirements .....	19
Features.....	4	Connect to a Wi-Fi Network.....	20
<b>GETTING TO KNOW THE INTERNET TABLET</b>	<b>5</b>	<b>BROWSING THE WEB .....</b>	<b>22</b>
About the Touchscreen .....	8	<b>OPTIONAL CONNECTIONS .....</b>	<b>26</b>
Protective Film .....	8	Connecting to a Computer .....	26
Touchscreen Actions.....	8	Connecting Headphones .....	27
About the Orientation Sensor .....	9	Using the USB Full-Size Adapter.....	28
Charging the Tablet .....	10	Connecting a Keyboard.....	28
Inserting a Memory Card .....	10	Connecting a Storage Device.....	28
Resetting the Tablet.....	11	<b>SETTING THE SYSTEM OPTIONS .....</b>	<b>29</b>
<b>GETTING STARTED.....</b>	<b>12</b>	<b>SPECIFICATIONS .....</b>	<b>30</b>
Turning the Tablet On and Off .....	12	<b>SAFETY NOTICES .....</b>	<b>31</b>
Turning the Screen On and Off (Standby) .....	13	<b>WARRANTY.....</b>	<b>35</b>
Unlocking the Screen .....	13		
Home Screen at a Glance .....	14		
About Applications .....	15		
Preinstalled Applications.....	15		
Installing Applications .....	17		
About Widgets.....	17		
About Notifications.....	18		

# Ū Thank You

Congratulations on your purchase of the Internet Tablet. This guide is provided to help you get started quickly with your tablet; please read it carefully and save it for future reference.



*To view PDF documents, download and install the free Adobe Acrobat reader from the Adobe website at [www.adobe.com](http://www.adobe.com).*

## Package Contents

Please make sure that the items shown below are included in the package. Should an item be missing, please contact the local retailer from whom purchased this product.

- ✦ Internet Tablet
- ✦ USB cable
- ✦ Adapter
- ✦ Manual

## Features

- ✦ Browse the Web.  
Visit your favourite websites
- ✦ Check your e-mail  
Keep in touch with friends and family
- ✦ Watch YouTube™ videos  
Browse the world's most popular video-sharing community
- ✦ Discover thousands of apps for Android™  
Games, applications and more with the installed marketplace
- ✦ Connect to the Internet wirelessly  
High-speed Wi-Fi 802.11 b/g/n networking
- ✦ Enjoy your media library anywhere  
Portable powerhouse plays popular music, video and photo formats
- ✦ MicroSD memory card reader  
Increase your storage capacity (up to 32 GB supported)
- ✦ Built-in camera  
Convenient front-facing camera
- ✦ Automatic orientation detection  
Read any way you want; the display adjusts automatically!
- ✦ Bluetooth Connect

# Getting to Know the Internet Tablet

## Unit at a Glance

Name		Description
1	Camera	Front-facing camera

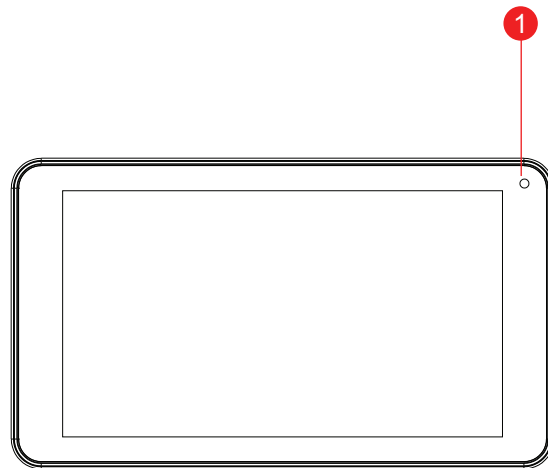

Name		Description
2	Power Key	Press to turn the unit on, or to turn the screen on and off.
3	Headphone jack	Audio output connection for head-phones.
4	USB Host	Connect a storage device to the tablet.
5	Volume + key	Press to increase the volume level.
6	Volume - key	Press to decrease the volume level.
7	SD Card slot	Load external microSD memory cards here.

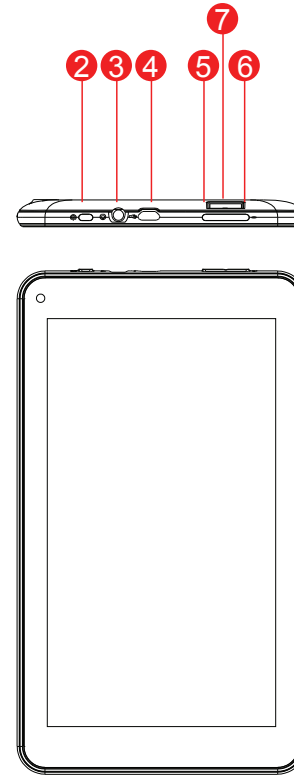

Name		Description
8	camera	Rear-facing camera
9	Speaker	Speaker output is automatically muted when using head-phone jack.
10	Reset	Press to reset the tablet if it freezes or otherwise behaves abnormally. (Use a paperclip or other small object to gently press this key.)

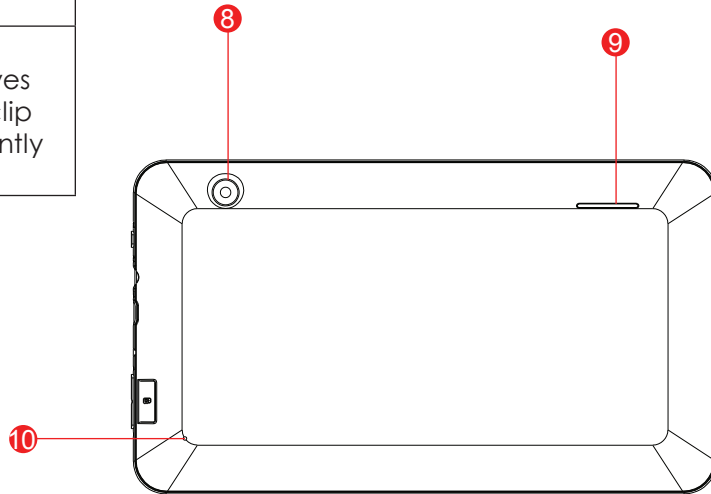

## About the Touchscreen

Your tablet comes equipped with an easy-to-use touchscreen.

Our capacitive multi-touchscreen requires gentle fingertip touch on the glass screen to activate tablet's functions. Multiple fingers may be used to perform gestures (e.g. 2-finger picture zoom).



*To avoid damaging the screen, do not touch it with excessive force or with any object other than your finger. For best response, make sure your hands are clean before using the touchscreen controls.*

### Protective Film

A thin film has been applied to the touchscreen to protect it during shipping. The protective film should be removed before use. To remove it, simply take a corner of the film and peel it away from the screen.

### Touchscreen Actions

You can control the functions of the tablet by using the touchscreen in combination with the three touch keys located on the bezel. To control the tablet with the

touchscreen, use your fingertip to manipulate icons, buttons, menu items, the on-screen keyboard and other items displayed on the screen.

You can perform the following actions on the touchscreen using your fingertip.

<b>Touch:</b>	To activate an on-screen item (e.g., application icons, buttons, menu items and the letter/symbols of the on-screen keyboard), simply touch them with your fingertip.
<b>Touch and Hold:</b>	Some on-screen items have an alternate action if you touch and hold them (e.g., opening an alternate menu, or activating the drag function). To touch and hold an item, touch the item and do not lift your fingertip until the action occurs.
<b>Drag:</b>	Drag an on-screen item to change its position (e.g., an application icon on the home screen). To drag an item, touch and hold it for a moment, then without lifting your fingertip, move your fingertip on the screen until the item reaches its target destination.



<b>Swipe:</b>	To swipe, touch the screen and then quickly move your fingertip across the screen without lifting your fingertip. Do not pause on the screen with your fingertip at the initial point of contact or you may accidentally drag an item instead.
<b>Double-tap:</b>	Quickly tap the screen twice on a webpage or other application screen to zoom (the application must support the double-tap/zoom function). Within the browser, double-tapping a webpage section will cause the browser to zoom and fit that section to the width of the screen.

## About the Orientation Sensor

The tablet contains a sensor that will automatically change the orientation of most screens as you rotate the tablet. The sensor works best when the tablet is rotated perpendicular to the ground (i.e., when the tablet is held upright and not flat on its back).



The orientation sensor can be turned on and off in the **Accessibility** settings menu.

## Charging the Tablet

The current battery status will be always displayed in the top right of the screen in the system information bar. The battery icon  will change in accordance with the battery status.

When connected to the DC charger, the status area on the top bar will display the  charging icon. Note the lightning symbol inside the battery icon.

To charge the battery:

1. Plug one end of the included power adapter into an AC 100-240V outlet.
2. Plug the other end of the included power adapter into the power jack on the tablet.
3. Disconnect the power adapter when the tablet is fully charged.



*The battery used in this device may cause a fire or chemical burn if mistreated. Do not disassemble, incinerate or heat the device. Do not leave the device in direct sunlight, or in a car with its windows closed. Do not connect the device to a power source other than that which is indicated here or on the label as this may result in a fire or electric shock.*

*Battery protection and low battery may cause your tablet fail to boot, please charge the battery.*

## Inserting a Memory Card

The tablet accepts microSD memory cards. Insert a memory card into the microSD card slot to:

- ✦ Increase the memory capacity of your tablet
- ✦ Play media files stored on the memory card (e.g., music, video or photo files).

**To insert a memory card:**

1. Align the memory card with the card slot. The metal contacts of the memory card should face down away from the LCD screen.
2. Slide the card into the spring-loaded slot. Push the card in until it clicks into place.



*Do not attempt to insert objects other than a microSD memory card into the card slot. A compatible memory card should fit easily into the card slot. If you encounter resistance, check the alignment of the card. Do not attempt to force the card in.*

*Avoid touching the gold contacts of the memory card.*

## To release and remove a memory card:

### 1. UNMOUNT the memory card.

- From the home screen, tap the **Launcher Tab**, and then touch **Settings** to show the settings menu.
- Touch **Storage** to show the storage settings.
- Touch **Unmount SD card** to prepare the memory card for safe removal.



- Push the card further into the slot until you hear a click. The card will spring out of the slot.
- Grasp the card by its edge to remove it.



*To avoid damage and data corruption, do not remove a memory card while data is being written to or read from the card. For example, do not remove a card while playing a music file stored on the card.*

## Resetting the Tablet

Reset the tablet if it should freeze, and not respond or otherwise malfunction.

- Disconnect your tablet if it is connected to a computer.
- Use a paper clip to gently press the <RESET> button located on the back of the tablet.



# Getting Started

## Turning the Tablet on and off

To turn the tablet on:

- ✦ Press and hold the **Power** key until the LCD screen turns on. Wait until the Home screen appears; the tablet is now ready for use.

To turn the tablet off:

1. Press and hold the **Power** key until the confirmation message appears.

2. Touch **OK** to turn off the tablet.

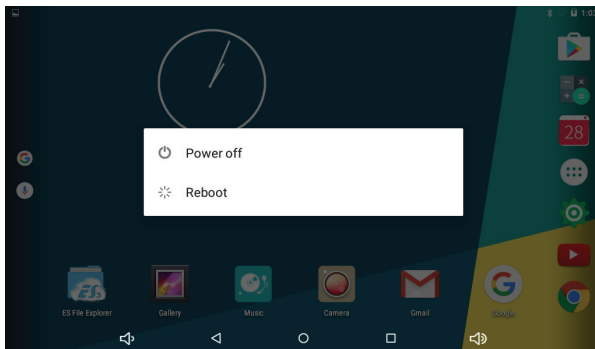

## Turning the Screen On and Off (Standby)

When the tablet is on, you can turn off the screen to conserve battery power. Simply press the **Power** key once to turn the screen off. Press the **Power** key again to turn the screen back on.



*To conserve battery power, the screen can be set to turn off automatically when the tablet is not in use (between 15 seconds and 30 minutes). This **Sleep** option can be found in the **Display** menu.*

## Unlocking the Screen

When the screen turns off, you will have to unlock the screen when you turn it back on.

To unlock the screen, touch and drag the **Lock** icon to the edge of the circle that appears.



If a password has been set, enter the password to finish unlocking the screen. The Screen Unlock password can be set in the **Security** settings menu.

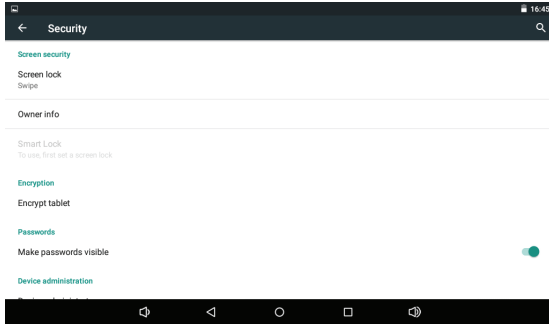

**WARNING:** Please write down your password lock pattern/PIN/Password. Misplacing or forgetting this method will lock the user out. Recovering the unit will reset the device back to factory defaults. **ALL YOUR DATA & PROGRAMS WILL BE LOST.**

## Home Screen at a Glance

The home screen is the starting point for all of the features of your tablet.



Name		Description
1	Notification Bar	Shows notification icons such as time, battery level and the network signal strength; touch the bar to open the full Notifications panel. Touch a Notification icon to display more detail.

Name		Description
2	Back	Touch to go back to the previous screen.
3	Home icon	Touch to go back to the central Home screen.
4	Recent Apps	Touch to display the list of thumbnail images of apps you have worked on recently. Touch an App to open it.
5	Launcher Tab	Open the Launcher to view the list of all Applications installed on the tablet. Touch the Launcher tab to open the Launcher.

## About Applications



To open an application, touch the application icon on the home screen or in the Launcher.

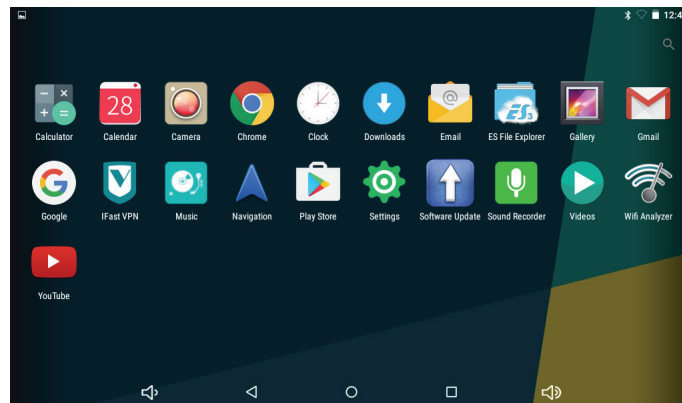

Launcher screen:

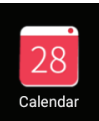
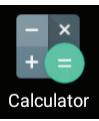
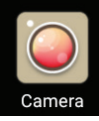

### ***Preinstalled Applications***

Some applications have been installed on your tablet for your convenience. These applications include:

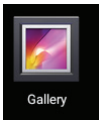
 <p>Chrome</p>	Browse the web.
 <p>Calendar</p>	Display the calendar or record events and appointments to manage your schedule.
 <p>Calculator</p>	Perform simple mathematical operations.
 <p>Camera</p>	Take pictures or videos with the front-facing camera.
 <p>Clock</p>	View the current time, or set an alarm.
 <p>ES File Explorer</p>	View and manage files stored on the tablet.

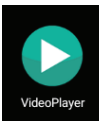
 <p>Email</p>	Check your e-mail.
 <p>Gallery</p>	View photos and videos, plus edit photos.
 <p>Settings</p>	Access the settings menu to adjust the tablet's options.
 <p>VideoPlayer</p>	View videos.



## ***Installing Applications***

You can also download and install additional applications from the device's applications marketplace, the web browser, or other sources.

The tablet must be set to allow installation of applications from non-market sources. The unknown sources option can be set in the **Application** settings menu.

## **About Widgets**

Widgets are self-contained applications that you can place on the Home screens to access your favourite features.

### ***Adding Widgets to a Home Screen***

1. Touch and hold the Home screen to show all Widgets.
2. Touch and hold on a widget icon to add it to the Home screen.

## ***Removing Widgets***

Touch and hold the Widget until the Remove icon appears on the left of the screen, then drag the Widget to the Remove icon to remove it.

# About Notifications

The icons that appear in the Notification bar at the top left corner of the screen alert you when new messages arrive or alarms or other application events occur.

View and respond to the notifications by opening the full Notifications panel.

- ✦ Touch the **Notification** bar to open the Notifications panel.

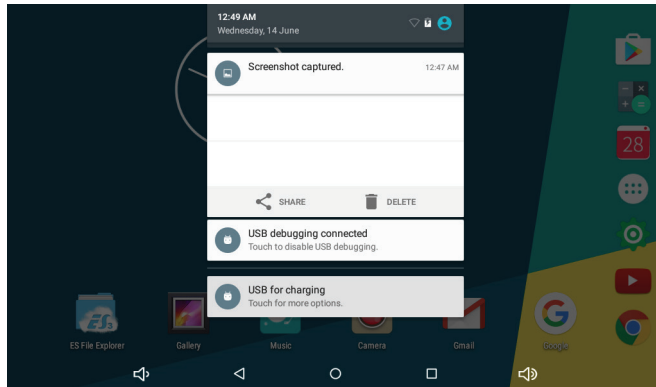

Touch a notification in the list; the Notifications panel will close and the application associated with the notification will launch.

## To close the Notifications panel:

- ✦ Touch any other area of the screen except the Notifications panel , or;
- ✦ Touch the **Back** icon.

To respond to a notification:



# Connecting to the Internet

This tablet can utilize Wi-Fi data networks to connect to the Internet.

- ✧ Wireless Wi-Fi technology can provide Internet access at distances of over 300 feet; however, this distance can be affected by your surrounding environment and Wi-Fi router.

## Requirements

In order to connect to the Internet, you will need either of the following:

### **A wireless router or access point with a broadband Internet connection**

The wireless router must support Wi-Fi 802.11b/g/n connections. If the router supports 802.11n, make sure that it has been configured to accept 802.11b/g/n connections as well.



*A minimum connection speed of 64 Kbps is recommended. Faster speeds will enable a better Internet experience.*

Please refer to your wireless router's documentation for help, or ask your network administrator for details.



*You may encounter open Wi-Fi networks, or "hot spots." These networks are usually configured so that you can simply connect to them without needing to know its settings; the tablet will obtain all the information it needs from the router automatically.*

You will need to know the name of your network (SSID), as well as the password or other credentials if your network is secured. These settings can usually be found on the administration webpage of your wireless router.

# Connect to a Wi-Fi network

The Notification bar displays icons that indicate your tablet's Wi-Fi status.

	Connected to a Wi-Fi network (waves indicate connection strength).
[no icon]	There are no Wi-Fi networks in range, or the Wi-Fi radio is off.

1. **Turn on the Wi-Fi radio if it is not already on. To turn on Wi-Fi:**
  - a. Go to the Home screen:  
Touch the **Home** icon.
  - b. Open the Launcher screen:  
Touch the **Launcher Tab**, then touch **Settings**.
  - c. Open the Wi-Fi settings menu:  
Touch **WiFi**.
  - d. Make sure that the Wi-Fi option box is set to ON:  
Touch and slide the block right to enable the **Wi-Fi** connection.

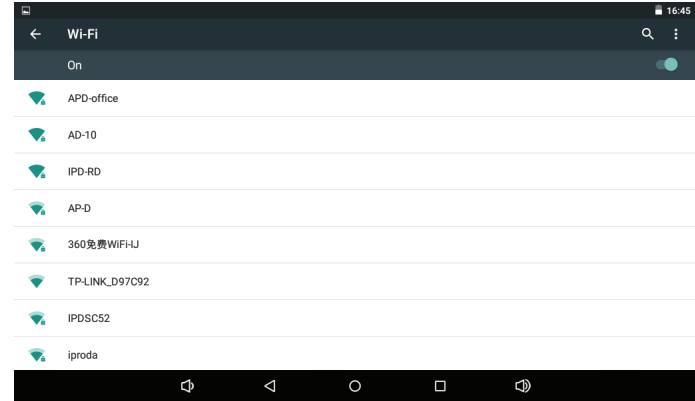

When the Wi-Fi is on, the tablet will look for and display a list of available Wi-Fi networks.



*If a network that you have previously connected to is found, the tablet will connect to it.*

*If you do not see your network in the list, you can force the tablet to re-scan. To scan for networks, tap the **SCAN** icon that is located on the top right corner of the screen.*

2. **Select an available Wi-Fi network to connect to:**

In the same Wi-Fi settings menu above, touch a network in the list.

If the network is open, the tablet will prompt you to confirm connection to the network. Touch **Connect** to confirm.

If the network is secured (as indicated by a Lock icon), the tablet will prompt you to enter a password or other credentials. Touch the Wireless password box to show the on-screen keyboard and then use it to enter the password. Touch **Connect** to confirm.

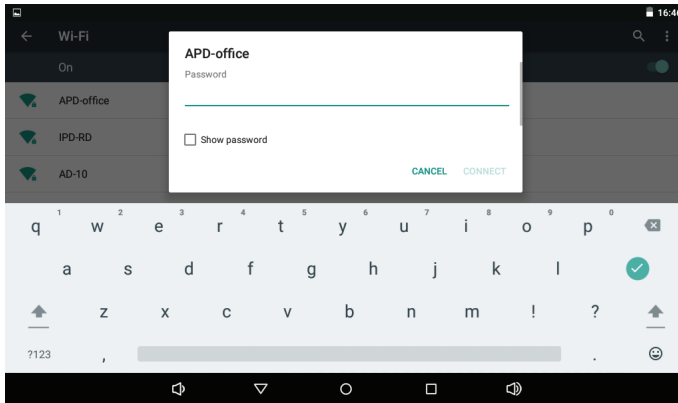

When you have successfully connected to a Wi-Fi network, the Notifications bar at the top right of the screen will show a Wi-Fi signal indicator.



*To learn about how to add a Wi-Fi network when it is not in range or when the router is set to obscure the network name (SSID); or to configure advanced Wi-Fi options, please refer to the manual.*



# Browsing the Web

The Browser application lets you visit webpages and find information on the web, keep up with the news, your friends, or enjoy video from YouTube™, the world's most popular video-sharing community.

To use Browser, the tablet must be connected to the Internet. Read the section “Connecting to the Internet” to learn how to connect to the Internet.

To open Browser, touch the Browser icon on the Home screen or in the Launcher.

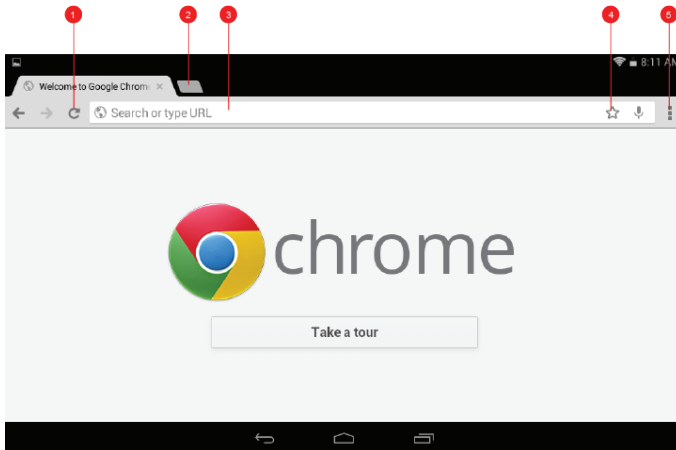

	Name	Description
1	Refresh	Refresh the webpage.
2	New Window (+)	Creates a new browser window.
3	Address Bar	Displays the address (URL) of the current page. Touch the bar to enter a new address or to search the web.
4	Add Bookmark icon	Touch to add bookmarks.
5	Goto Bookmarks icon	Touch to view bookmarks, to view your most visited sites, or to view your browser history.

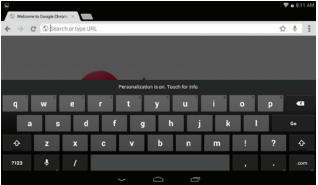

Some common Browser actions are described below.

✦ **To go to a webpage.**

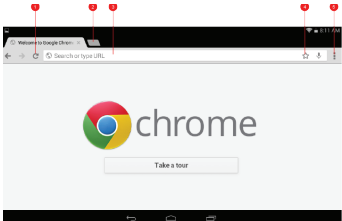

<p>1. Touch the <b>Address bar</b> at the top of the Browser screen. The keyboard will open automatically. (If the Address bar is not visible, drag the page down to return to the top of the Browser screen.)</p>	
<p>2. Use the keyboard to enter the address (URL) of the webpage (e.g., <a href="http://www.google.com">www.google.com</a>).</p>	
<p>3. Touch <b>Enter</b> key to open the webpage.</p>	

✦ **To bookmark a webpage.**

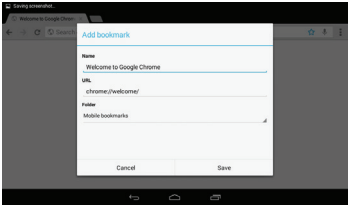
Bookmark your favourite webpages in order to visit them quickly without entering a URL.

<p>1. Go to the webpage that you want to bookmark</p>	
<p>2. Touch the <b>Add Bookmark</b> icon.</p>	
<p>3. If desired, you can modify the name of the bookmark or its location (URL address). Otherwise, touch <b>OK</b> to finish adding the bookmark.</p>	

## ✦ To go to a bookmarked webpage.

1. Touch the <b>Goto Bookmark</b> icon.	
2. Touch a bookmark tile to open it.	

## ✦ To delete a bookmarked webpage.

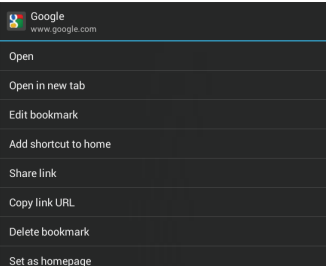
1. Touch the <b>Goto Bookmark</b> icon.	
2. Touch and hold a bookmark tile to open the option menu.	

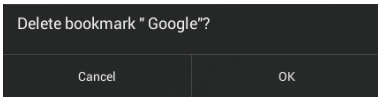
3. Touch "Delete bookmark".	
4. Touch "OK" to confirm.	

## Browser menu

While viewing a webpage, touch the icon (as shown on the right) to open the Browser Menu, the icon is located on the top right corner of the screen, the options are:



- ✦ New tab: Open the webpage in a new window, under a new tab.
- ✦ New incognito tab: Open the webpage in a new window, under a new tab and the pages you view in the new window will not appear in your browser history or search history. See the on-screen explanation of going incognito.
- ✦ Bookmarks: Press to open your bookmarks.
- ✦ Other devices: Bring your open tabs, bookmarks, history, and more from your computer to your phone or tablet.
- ✦ History: Tap to open your history entries.



- ✦ Print: Save as PDF file.
- ✦ Find in page: Search for content on the current page.
- ✦ Request desktop site: Switch between the computer and android version of the desktop.
- ✦ Settings: Customize the Browser.
- ✦ Help & feedback: Press to enter the help and feedback page.

# Optional Connections

## Connecting to a Computer

Connect the tablet to a computer to transfer files.

### 1. Connect your tablet to the computer.

With the included USB cable:

- ✦ Plug the small end of the cable into the USB 2.0 Hi-speed connector of the tablet.
- ✦ Plug the large end of the cable into an available USB 2.0 Hi-speed port on the computer.



*The Tablet's "mass storage mode" is compatible with many operating systems including: Microsoft® Windows® XP, Vista, 7 or higher and Mac OS or Linux.*

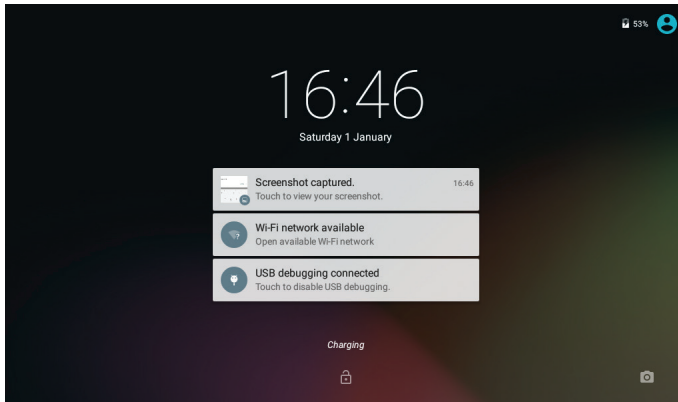

## 2. Mount the storage drive.

- ✦ Touch **Connected as a media device** to mount the tablet's built-in storage, then touch **Media device(MTP)**, now you can copy files to/from your computer.

Your tablet will be recognized by the computer as a Removable Storage drive. Drag and drop files between your tablet and the computer. To learn more about copying files, please refer to the documentation included with your computer or operating system.

## Connecting Headphones

Connect a pair of headphones (or earphones) to the tablet to enjoy media in private.

Lower the volume level of the tablet before connecting headphones and then slowly raise the volume to a comfortable listening level.

- ✦ The headphones must have a 3.5 mm (1/8 in) plug.
- ✦ When headphones are connected, speaker output will be disabled automatically.



*Hearing experts advise against the constant use of personal stereos played at high volume. Constant exposure to high volumes can lead to hearing loss. If you should experience ringing in the ears or hearing loss, discontinue use and seek medical advice.*

## Using the USB Full-Size Adapter

The USB full-size adapter can be used to connect and use USB devices with the tablet. The adapter converts the Micro USB port on the tablet into a USB On-the-Go (OTG) connector.

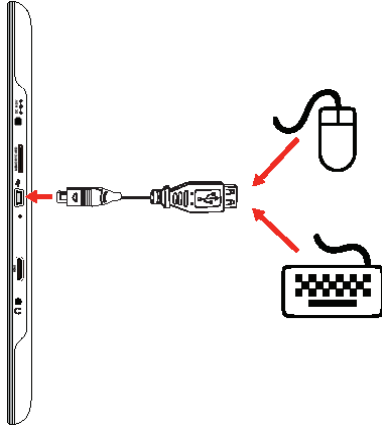

*You may also use this connection to add a mouse to the tablet.*

*The adapter supports one connection at a time. To use a keyboard and mouse simultaneously, you will need to add an external USB hub.*

## Connecting a Storage Device

Use the included USB full-size (Type A) adapter to connect a storage device to the tablet (e.g., a USB flash memory drive).



*This connection supports a maximum storage size of 32 GB. For additional storage capacity, a microSD card can be added to the tablet.*

## Connecting a Keyboard

When you want to type for an extended period of time, you may connect a full-size keyboard to the tablet.

Use the included USB full-size (Type A) adapter to connect a keyboard to the tablet.

# Setting the System Options

Open the system settings menu to adjust how the tablet looks and functions.



*Many applications will have their own settings; refer to the documentation provided by the application developer to learn more.*

To open the Settings menu:

1. From the Home screen, touch the **Launcher Tab**.
2. Touch **Settings** to open the Settings menu.

The settings are grouped by category. Touch a category to open and adjust its settings on the right hand side.



*Please refer to the manual for a description of the items in the Settings menu.*

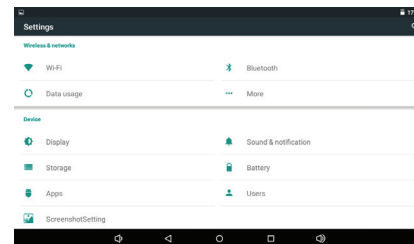



# Specifications

<b>Processor</b>	A33 QUAD CORE
<b>RAM</b>	1GB
<b>Storage</b>	8GB flash built-in microSD card slot (max. 32GB supported)
<b>Display</b>	7.0" LCD (1024*600), capacitive touchscreen
<b>Networking</b>	Wi-Fi IEEE 802.11 b/g/n
<b>Bluetooth</b>	BT4.0
<b>Audio Output</b>	3.5 mm headphone
<b>PC Interface</b>	USB 2.0 Hi-speed
<b>Additional Features</b>	Front/Back-facing camera Built-in microphone Mono speakers
<b>Operating System</b>	Android™ 6.0
<b>Power</b>	Rechargeable Li-poly battery Power Adapter (DC 5V)
<b>Playback Time (hours) *</b>	Up to 8 hours music, 3 hours video, 3 hours web browsing

\* Music was tested with a 128 kbps MP3 file; video was tested with a 1920 x 1080 MPEG-4/AVC file; browsing was tested with the screen brightness set to default. Actual playback results may vary.



# Safety Notices

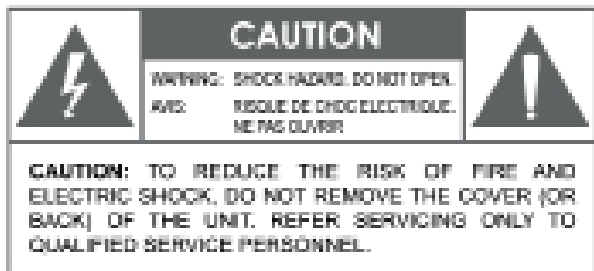

The lightning flash with arrowhead symbol within an equilateral triangle is intended to alert the user to the presence of uninsulated "dangerous voltage" within the product's enclosure that may be of sufficient magnitude to constitute a risk of electric shock.



The exclamation point within an equilateral triangle is intended to alert the user to the presence of important operation and servicing instructions in the literature accompanying the appliance.



For recycling or disposal information about this product, please contact your local authorities or the Electronics Industries Alliance: [www.eiae.org](http://www.eiae.org).

## For Customer Use:

Enter below the serial number that is located on the rear of the unit. Retain this information for future reference.

Model No. \_\_\_\_\_

Serial No. \_\_\_\_\_

**WARNING:** To prevent fire or shock hazard, do not expose this device to rain or moisture. Dangerous high voltage is present inside the enclosure. Do not open the cabinet.

**Protect your hearing:** Hearing experts advise against the constant use of personal stereos played at high volume. Constant exposure to high volumes can lead to hearing loss. If you should experience ringing in the ears or hearing loss, discontinue use and seek medical advice.

**Note:** If the product suddenly has no response or powers off, an electrostatic discharge may be the cause. In this circumstance, please follow the procedures below for recovery:

- Turn off the unit by pushing the reset button at the rear of the tablet.
- Turn on the unit again.

## FCC Statement:

This device complies with part 15 of the FCC Rules. Operation is subject to the following two conditions: (1) This device may not cause harmful interference, and (2) this device must accept any interference received, including interference that may cause undesired operation.

Any Changes or modifications not expressly approved by the party responsible for compliance could void the user's authority to operate the equipment.

Note: This equipment has been tested and found to comply with the limits for a Class B digital device, pursuant to part 15 of the FCC Rules. These limits are designed to provide reasonable protection against harmful interference in a residential installation. This equipment generates uses and can radiate radio frequency energy and, if not installed and used in accordance with the instructions, may cause harmful interference to radio communications. However, there is no guarantee that interference will not occur in a particular installation. If this equipment does cause harmful interference to radio or television reception, which can be determined by turning the equipment off and on, the user is encouraged to try to correct the interference by one or more of the following measures:

- Reorient or relocate the receiving antenna.
- Increase the separation between the equipment and receiver.
- Connect the equipment into an outlet on a circuit different from that to which the receiver is connected.
- Consult the dealer or an experienced radio/TV technician for help.

This equipment complies with FCC radiation exposure limits set forth for an uncontrolled environment.



## Important Safety Instructions

1. **Read Instructions:** All the safety and operating instructions should be read before the product is operated.
2. **Retain Instructions:** The safety and operating instructions should be retained for future reference.
3. **Heed Warnings:** All warnings on the product and in the operating instructions should be adhered to.
4. **Follow Instructions:** All operating and usage instructions should be followed.
5. **Cleaning:** Unplug this product from the wall outlet before cleaning. Do not use liquid cleaners or aerosol cleaners. Use a damp cloth for cleaning.
6. **Attachments:** Use only attachments recommended by the manufacturer. Use of other attachments may be hazardous.
7. **Water and Moisture:** Do not use this product near water (e.g., near a bath tub, washbowl, kitchen sink, laundry tub, in wet basements, or near a swimming pool and the like).
8. **Ventilation:** Slots and openings in the cabinet are provided for ventilation to ensure reliable operation of the product and to protect it from overheating. These openings should never be blocked by placing the product on a bed, sofa, rug, or other similar surface. This product should not be placed in a built-in installation such as a bookcase or rack unless proper ventilation is provided or the manufacturer instructions have been adhered to.
9. **Power Sources:** This product should be operated only from the type of power source indicated on the rating label. If you are not sure of the type of power supply to your home, consult your product dealer or local power company. For products intended to operate from battery power or other sources, refer to the operating instructions.
10. **Overloading:** Do not overload wall outlets, extension cords, or integral convenience receptacles as this can result in a risk of fire or electric shock.
11. **Object and Liquid Entry:** Never push objects of any kind into this product through openings as they may touch dangerous voltage points or shout-out parts that could result in a fire or electric shock. Never spill liquid of any kind on the product.
12. **Servicing:** Do not attempt to service this product yourself as opening or removing covers may expose you to dangerous voltage or other hazards. Refer all servicing to qualified service personnel.
13. **Damage Requiring Service:** Unplug this product from the wall outlet and refer servicing to qualified service personnel under the following conditions: a) when the power-supply or plug is damaged; b) if liquid has been spilled or if objects have fallen into the product; c) if the product has been exposed to rain or water; d) if

the product does not operate normally by following the operating instructions. Adjust only those controls that are covered by the operating instructions as improper adjustment of other controls may result in damage and will often require extensive work by a qualified technician to restore the product to its normal operation; e) if the product has been dropped or damaged in any way; f) when the product exhibits a distinct change in performance—this indicates a need for service.

14. **Replacement Parts:** When replacement parts are required, be sure that your service technician has used replacement parts specified by the manufacturer or have the same characteristics as the original part. Unauthorized substitutions may result in fire, electric shock, or other hazards.
15. **Safety Check:** Upon completion of any service or repairs to this product, ask the service technician to perform safety checks to ensure that the product is in proper operating condition.
16. **Heat:** The product should be situated away from heat sources such as radiators, heat registers, stoves, or other products (including amplifiers) that produce heat.