



CTC Laboratories, Inc.

2/F., Building 1 and 1-2/F., Building 2, Jiaquan Building, Guanlan High-Tech Park, Longhua District, Shenzhen, Guangdong, China

Tel: +86-755-27521059 Fax: +86-755-27521011 <http://www.sz-ctc.org.cn>

TEST REPORT

Report No. : **CTC20231892E06**

FCC ID..... : **2AASG-CS7219**

Applicant : **Shenzhen MinDe Electronics Technology Ltd.**

Address..... : 5th Floor, Section 1, 25th Block, No.5, Kezhi Xi Road, Keji Yuan, Nanshan District, Shenzhen, P.R. China

Manufacturer..... : Shenzhen MinDe Electronics Technology Ltd.

Address..... : 5th Floor, Section 1, 25th Block, No.5, Kezhi Xi Road, Keji Yuan, Nanshan District, Shenzhen, P.R. China

Product Name : **Bluetooth Image Scanner**

Trade Mark : **MINDEO**

Model/Type reference..... : CS7219-HD(BT)

Listed Model(s) : CS7219-HD, CS7219, CS7219i, CS7XXX, CS7XXXi, CS7XXX-HD, CS7XXX-XD, CS7XXX-SR, CS7XXXi-HD, CS7XXXi-XD, CS7XXXi-SR (X Stand for 0-9, A-Z)

Standard : **FCC CFR Title 47 Part 15 Subpart C Section 15.247**

Date of receipt of test sample..... : Oct. 12, 2023

Date of testing..... : Oct. 12, 2023 to Nov. 11, 2023

Date of issue..... : Dec. 12, 2023

Result..... : **PASS**

Compiled by:		
(Printed name+signature)	Jim Jiang	
Supervised by:		
(Printed name+signature)	Eric Zhang	
Approved by:		
(Printed name+signature)	Totti Zhao	

This test report may be duplicated completely for legal use with the approval of the applicant. It should not be reproduced except in full, without the written approval of our laboratory. The client should not use it to claim product endorsement by CTC. The Test Result in the report only apply to the tested sample. The test report shall be invalid without all the signatures of testing engineers, reviewer and approver. Any objections must be raised to CTC within 15 days since the date when the report is received. It will not be taken into consideration beyond this limit. The test report merely corresponds to the test sample.



Table of Contents

Page

- 1. TEST SUMMARY 3
 - 1.1. TEST STANDARDS..... 3
 - 1.2. REPORT VERSION 3
 - 1.3. TEST DESCRIPTION..... 3
 - 1.4. TEST FACILITY 4
 - 1.5. MEASUREMENT UNCERTAINTY 5
 - 1.6. ENVIRONMENTAL CONDITIONS..... 5
- 2. GENERAL INFORMATION 6
 - 2.1. CLIENT INFORMATION 6
 - 2.2. GENERAL DESCRIPTION OF EUT 6
 - 2.3. ACCESSORY EQUIPMENT INFORMATION 7
 - 2.4. OPERATION STATE 8
 - 2.5. MEASUREMENT INSTRUMENTS LIST 9
- 3. TEST ITEM AND RESULTS 11
 - 3.1. CONDUCTED EMISSION..... 11
 - 3.2. RADIATED EMISSION 14
 - 3.3. BAND EDGE EMISSIONS (RADIATED) 22
 - 3.4. BAND EDGE AND SPURIOUS EMISSIONS (CONDUCTED) 27
 - 3.5. DTS BANDWIDTH..... 32
 - 3.6. PEAK OUTPUT POWER 35
 - 3.7. POWER SPECTRAL DENSITY 36
 - 3.8. DUTY CYCLE 38
 - 3.9. ANTENNA REQUIREMENT 40



1. TEST SUMMARY

1.1. Test Standards

The tests were performed according to following standards:

[FCC Rules Part 15.247](#): Operation within the bands 902–928MHz, 2400–2483.5MHz, and 5725–5850MHz.

[RSS-247 Issue 3](#): Digital Transmission Systems (DTSs), Frequency Hopping Systems (FHSs) and Licence-Exempt Local Area Network (LE-LAN) Devices.

[RSS-Gen Issue 5](#): General Requirements for Compliance of Radio Apparatus.

[ANSI C63.10-2013](#): American National Standard of Procedures for Compliance Testing of Unlicensed Wireless Devices.

1.2. Report Version

Revised No.	Date of issue	Description
01	Dec. 12, 2023	Original

1.3. Test Description

FCC Part 15 Subpart C (15.247) / RSS-247 Issue 3				
Test Item	Standard Section		Result	Test Engineer
	FCC	IC		
Antenna Requirement	15.203	RSS-Gen 6.8	Pass	Jim Jiang
Conducted Emission	15.207	RSS-Gen 8.8	Pass	Jim Jiang
Conducted Band Edge and Spurious Emissions	15.247(d)	RSS-247 5.5	Pass	Jim Jiang
Radiated Band Edge and Spurious Emissions	15.205&15.209&15.247(d)	RSS-247 5.5	Pass	Jim Jiang
6dB Bandwidth	15.247(a)(2)	RSS-247 5.2 (a)	Pass	Jim Jiang
Conducted Max Output Power	15.247(b)(3)	RSS-247 5.4 (d)	Pass	Jim Jiang
Power Spectral Density	15.247(e)	RSS-247 5.2 (b)	Pass	Jim Jiang
Transmitter Radiated Spurious	15.209&15.247(d)	RSS-247 5.5&RSS-Gen 8.9	Pass	Jim Jiang

Note:

- The measurement uncertainty is not included in the test result.
- N/A: means this test item is not applicable for this device according to the technology characteristic of device.



1.4. Test Facility

Address of the report laboratory

CTC Laboratories, Inc.

Add: 2/F., Building 1 and 1-2/F., Building 2, Jiaquan Building, Guanlan High-Tech Park, Longhua District, Shenzhen, Guangdong, China

Laboratory accreditation

The test facility is recognized, certified, or accredited by the following organizations:

A2LA-Lab Cert. No.: 4340.01

CTC Laboratories, Inc. EMC Laboratory has been accredited by A2LA for technical competence in the field of electrical testing, and proved to be in compliance with ISO/IEC 17025:2017 General Requirements for the Competence of Testing and Calibration Laboratories and any additional program requirements in the identified field of testing.

Industry Canada (Registration No.: 9783A, CAB Identifier: CN0029)

CTC Laboratories, Inc. EMC Laboratory has been registered by Certification and Engineer Bureau of Industry Canada for the performance of with Registration NO.: 9783A on Jan, 2016.

FCC (Registration No.: 951311, Designation Number CN1208)

CTC Laboratories, Inc. EMC Laboratory has been registered and fully described in a report filed with the (FCC) Federal Communications Commission. The acceptance letter from the FCC is maintained in our files. Registration 951311, Aug 26, 2017.



1.5. Measurement Uncertainty

The data and results referenced in this document are true and accurate. The reader is cautioned that there may be errors within the calibration limits of the equipment and facilities. The measurement uncertainty was calculated for all measurements listed in this test report acc. to TR-100028-01 “Electromagnetic compatibility and Radio spectrum Matters (ERM);Uncertainties in the measurement of mobile radio equipment characteristics; Part 1” and TR-100028-02 “Electromagnetic compatibility and Radio spectrum Matters (ERM); Uncertainties in the measurement of mobile radio equipment characteristics; Part 2” and is documented in the CTC Laboratories, Inc. quality system acc. to DIN EN ISO/IEC 17025. Furthermore, component and process variability of devices similar to that tested may result in additional deviation. The manufacturer has the sole responsibility of continued compliance of the device.

Below is the best measurement capability for CTC Laboratories, Inc.

Test Items	Measurement Uncertainty	Notes
DTS Bandwidth	±0.0196%	(1)
Maximum Conducted Output Power	±0.686 dB	(1)
Maximum Power Spectral Density Level	±0.743 dB	(1)
Band-edge Compliance	±1.328 dB	(1)
Unwanted Emissions In Non-restricted Freq Bands	9kHz-1GHz: ±0.746dB 1GHz-26GHz: ±1.328dB	(1)
Conducted Emissions 9kHz~30MHz	±3.08 dB	(1)
Radiated Emissions 30~1000MHz	±4.51 dB	(1)
Radiated Emissions 1~18GHz	±5.84 dB	(1)
Radiated Emissions 18~40GHz	±6.12 dB	(1)

Note (1): This uncertainty represents an expanded uncertainty expressed at approximately the 95% confidence level using a coverage factor of k=2.

1.6. Environmental Conditions

During the measurement the environmental conditions were within the listed ranges:

Temperature:	15 °C to 35 °C
Relative Humidity:	20 % to 75 %
Air Pressure:	101 kPa



2. GENERAL INFORMATION

2.1. Client Information

Applicant:	Shenzhen MinDe Electronics Technology Ltd.
Address:	5th Floor, Section 1, 25th Block, No.5, Kezhi Xi Road, Keji Yuan, Nanshan District, Shenzhen, P.R. China
Manufacturer:	Shenzhen MinDe Electronics Technology Ltd.
Address:	5th Floor, Section 1, 25th Block, No.5, Kezhi Xi Road, Keji Yuan, Nanshan District, Shenzhen, P.R. China

2.2. General Description of EUT

Product Name:	Bluetooth Image Scanner
Trade Mark:	MINDEO
Model/Type reference:	CS7219-HD(BT)
Listed Model(s):	CS7219-HD, CS7219, CS7219i, CS7XXX, CS7XXXi, CS7XXX-HD, CS7XXX-XD, CS7XXX-SR, CS7XXXi-HD, CS7XXXi-XD, CS7XXXi-SR (X Stand for 0-9, A-Z)
Model Difference:	All these models are identical in the same PCB, layout, electrical circuit and enclosure. The difference is the model name.
Power Supply:	Input: DC5V 0.7A Battery: 3.7V, 2600mAh, 9.62Wh
Hardware Version:	/
Software Version:	/
Bluetooth 4.2 / BLE	
Modulation:	GFSK
Operation Frequency:	2402MHz~2480MHz
Channel Number:	40
Channel Separation:	2MHz
Data Rate:	1Mbps
Antenna Type:	Ceramic Antenna
Antenna Gain:	2.66dBi



2.3. Accessory Equipment Information

Equipment Information			
Name	Model	S/N	Manufacturer
Notebook	ThinkPad T460s	/	Lenovo
Cradle	CS2X90-BT CRADLE, CSXXXX-BT (X Stand for 0-9, A-Z)	/	MINDEO
Cable Information			
Name	Shielded Type	Ferrite Core	Length
USB Cable	Unshielded	NO	150cm
USB to RJ45 Cable	Unshielded	NO	200cm
Test Software Information			
Name	Version	/	/
RTLBTAPP	12.0.0.49974	/	/



2.4. Operation State

Operation Frequency List: The EUT has been tested under typical operating condition. The Applicant provides communication tools software to control the EUT for staying in continuous transmitting and receiving mode for testing. BT BLE, 40 channels are provided to the EUT. Channels 00/19/39 were selected for testing.

Operation Frequency List:

Channel	Frequency (MHz)
00	2402
01	2404
:	:
18	2438
19	2440
20	2442
:	:
38	2478
39	2480

Note: The display in grey were the channel selected for testing.

Test Mode:

For RF test items:
The engineering test program was provided and enabled to make EUT continuous transmit.
For AC power line conducted emissions:
The EUT was set to connect with the Bluetooth instrument under large package sizes transmission.
For Radiated spurious emissions test item:
The engineering test program was provided and enabled to make EUT continuous transmit. The EUT in each of three orthogonal axis emissions had been tested, but only the worst case (X axis) data recorded in the report.



2.5. Measurement Instruments List

Tonscend RF Test System					
Item	Test Equipment	Manufacturer	Model No.	Serial No.	Calibrated Until
1	Spectrum Analyzer	R&S	FSV40-N	101331	Mar. 14, 2024
2	Spectrum Analyzer	R&S	FSV40-N	101654	Aug. 07, 2024
3	Spectrum Analyzer	R&S	FSU26	100105	Dec. 16, 2023
4	MXA Signal Analyzer	Keysight	N9020A	MY46471737	Dec. 16, 2023
5	MXA Signal Analyzer	Keysight	N9020A	MY52091402	Aug. 22, 2024
6	MXG Vector Signal Generator	Agilent	N5182A	MY47420864	Dec. 16, 2023
7	PSG Analog Signal Generator	Agilent	E8257D	MY46521908	Dec. 16, 2023
8	EXG Analog Signal Generator	Keysight	N5173B	MY59100842	Dec. 16, 2023
9	MXG Vector Signal Generator	Keysight	N5182B	MY59100212	Dec. 16, 2023
10	Wideband Radio Communication Tester	R&S	CMW500	102257	May 25, 2024
11	Wideband Radio Communication Tester	R&S	CMW500	102414	Dec. 16, 2023
12	High and low temperature test chamber	ESPEC	MT3035	/	Mar. 24, 2024
13	USB Wideband Power Sensor	Keysight	U2021XA	MY55130004	Mar. 14, 2024
14	USB Wideband Power Sensor	Keysight	U2021XA	MY55130006	Mar. 14, 2024
15	Test Software	Tonscend	JS1120-3	V2.6.88.0346	/

Radiated Emission					
Item	Test Equipment	Manufacturer	Model No.	Serial No.	Calibrated Until
1	Trilog-Broadband Antenna	Schwarzbeck	VULB 9168	9168-1013	Dec. 07, 2024
2	Horn Antenna	Schwarzbeck	BBHA 9120D	9120D-648	Dec. 07, 2024
3	Spectrum Analyzer	R&S	FSU26	100105	Dec. 16, 2023
4	Spectrum Analyzer	R&S	FSV40-N	101331	Mar. 14, 2024
5	Pre-Amplifier	SONOMA	310	186194	Dec. 16, 2023
6	Low Noise Pre-Amplifier	EMCI	EMC051835	980075	Dec. 16, 2023
7	Test Receiver	R&S	ESC17	100967	Dec. 16, 2023
8	3m chamber 2	Frankonia	EE025	/	Oct. 23, 2024
9	Test Software	FARA	EZ-EMC	FA-03A2	/

CTC Laboratories, Inc.

2/F., Building 1 and 1-2/F., Building 2, Jiaquan Building, Guanlan High-Tech Park, Longhua District, Shenzhen, Guangdong, China
Tel.: (86)755-27521059 Fax: (86)755-27521011 Http://www.sz-ctc.org.cn



For anti-fake verification, please visit the official website of Certification and Accreditation Administration of the People's Republic of China : <http://yz.cnca.cn>



Conducted Emission					
Item	Test Equipment	Manufacturer	Model No.	Serial No.	Calibrated Until
1	LISN	R&S	ENV216	101112	Dec. 16, 2023
2	LISN	R&S	ENV216	101113	Dec. 16, 2023
3	EMI Test Receiver	R&S	ESCS30	100353	Dec. 16, 2023
4	ISN CAT6	Schwarzbeck	NTFM 8158	CAT6-8158-0046	Dec. 16, 2023
5	ISN CAT5	Schwarzbeck	NTFM 8158	CAT5-8158-0046	Dec. 16, 2023
6	Test Software	R&S	EMC32	6.10.10	/

Note: 1. The Cal. Interval was one year.

2. The Cal. Interval was three years of the antenna.

3. The cable loss has been calculated in test result which connection between each test instruments.

3. TEST ITEM AND RESULTS

3.1. Conducted Emission

Limit

FCC CFR Title 47 Part 15 Subpart C Section 15.207 / RSS-Gen 8.8

Frequency (MHz)	Conducted Limit (dBμV)	
	Quasi-peak	Average
0.15 - 0.5	66 to 56 *	56 to 46 *
0.5 - 5	56	46
5 - 30	60	50

* Decreases with the logarithm of the frequency.

Test Configuration

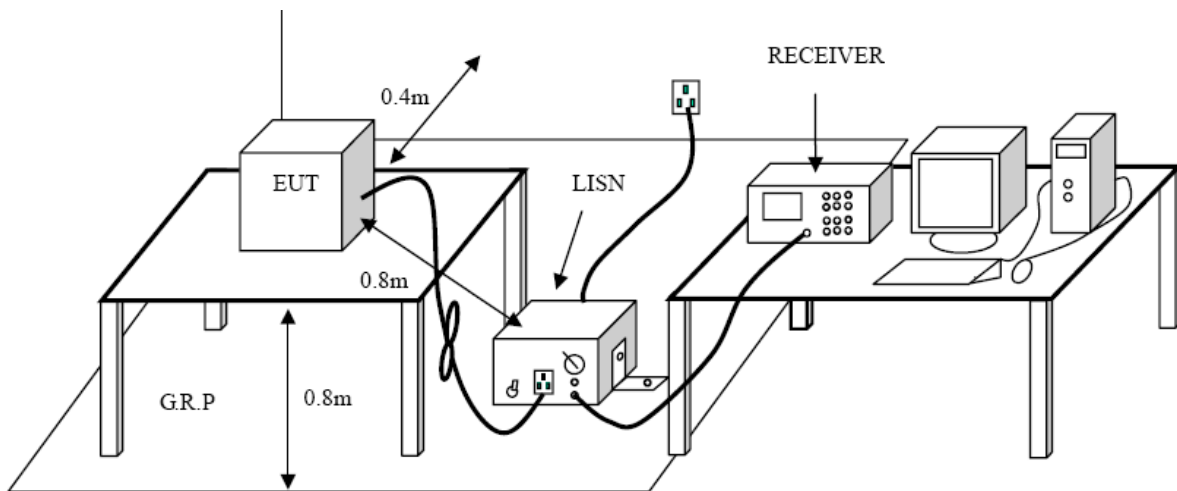

Test Procedure

1. The EUT was setup according to ANSI C63.10:2013 requirements.
2. The EUT was placed on a platform of nominal size, 1 m by 1.5 m, raised 80 cm above the conducting ground plane. The vertical conducting plane was located 40 cm to the rear of the EUT. All other surfaces of EUT were at least 80 cm from any other grounded conducting surface.
3. The EUT and simulators are connected to the main power through a line impedance stabilization network (LISN). The LISN provides a 50 ohm / 50 μH coupling impedance for the measuring equipment.
4. The peripheral devices are also connected to the main power through a LISN. (Please refer to the block diagram of the test setup and photographs)
5. Each current-carrying conductor of the EUT power cord, except the ground (safety) conductor, was individually connected through a LISN to the input power source.
6. The excess length of the power cord between the EUT and the LISN receptacle were folded back and forth at the center of the lead to form a bundle not exceeding 40 cm in length.
7. Conducted emissions were investigated over the frequency range from 0.15MHz to 30MHz using a receiver bandwidth of 9 kHz.
8. During the above scans, the emissions were maximized by cable manipulation.

Test Mode

Please refer to the clause 2.4.





Test Result

Test Voltage:	AC 120V/60Hz
Terminal:	Line
Remark:	Only worse case is reported

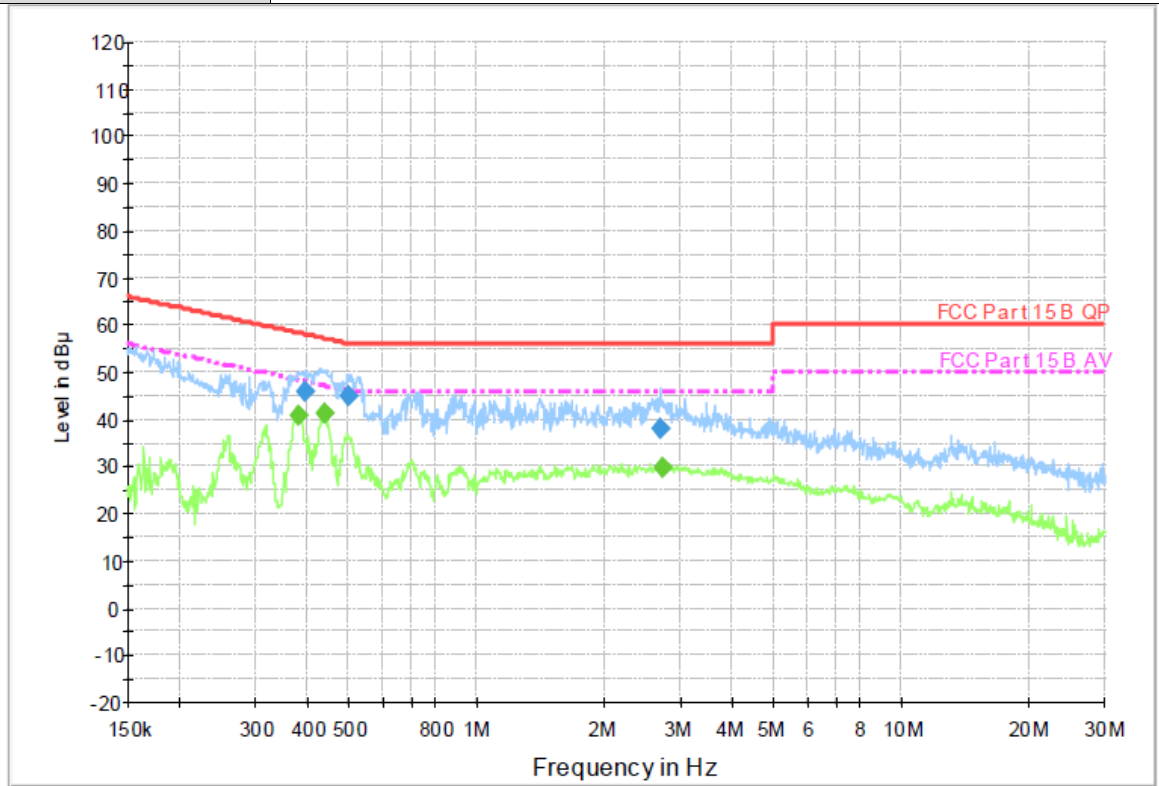

Final Measurement Detector 1

Frequency (MHz)	QuasiPeak (dBµ V)	Meas. Time (ms)	Bandwidth (kHz)	Filter	Line	Corr. (dB)	Margin (dB)	Limit (dBµ V)	Comment
0.394140	46.0	1000.00	9.000	On	L1	9.5	12.0	58.0	
0.496830	45.2	1000.00	9.000	On	L1	9.5	10.9	56.1	
2.688850	37.8	1000.00	9.000	On	L1	9.5	18.2	56.0	

Final Measurement Detector 2

Frequency (MHz)	Average (dBµ V)	Meas. Time (ms)	Bandwidth (kHz)	Filter	Line	Corr. (dB)	Margin (dB)	Limit (dBµ V)	Comment
0.378720	40.7	1000.00	9.000	On	L1	9.5	7.6	48.3	
0.437250	41.3	1000.00	9.000	On	L1	9.5	5.8	47.1	
2.721240	29.9	1000.00	9.000	On	L1	9.5	16.1	46.0	

Emission Level = Read Level + Correct Factor





Test Voltage:	AC 120V/60Hz
Terminal:	Neutral
Remark:	Only worse case is reported

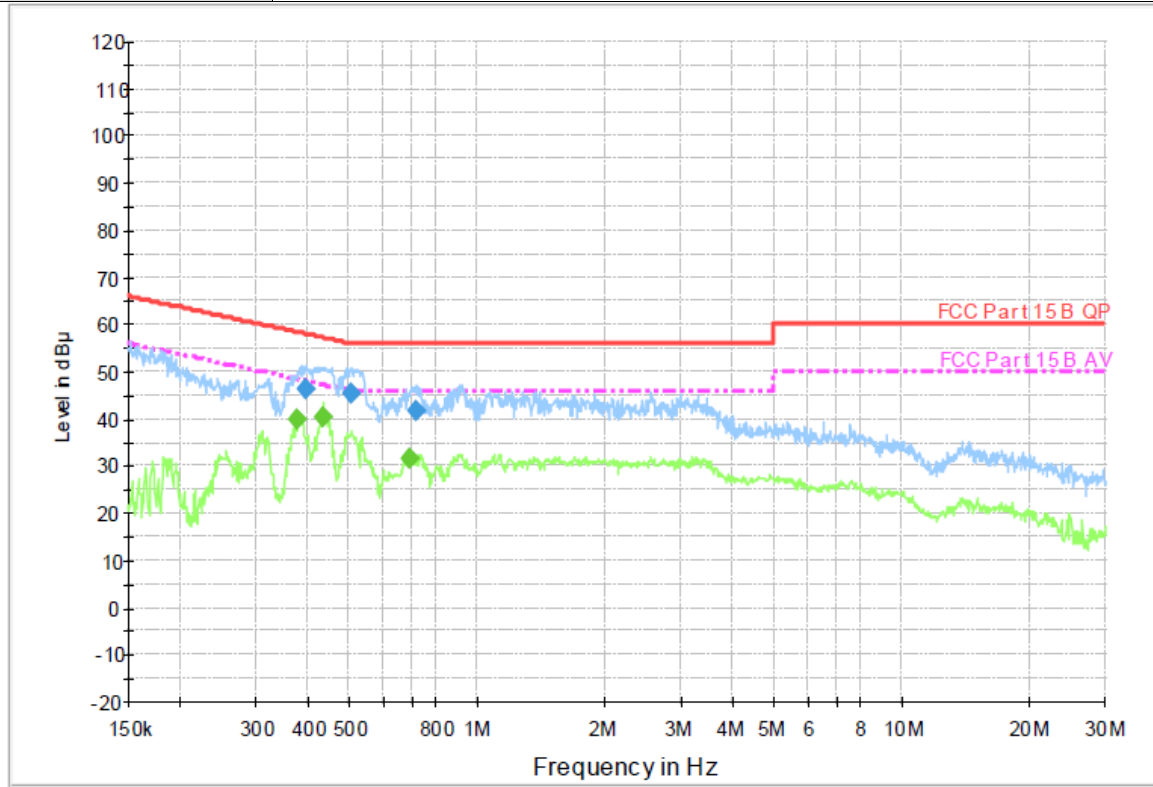

Final Measurement Detector 1

Frequency (MHz)	QuasiPeak (dBµ V)	Meas. Time (ms)	Bandwidth (kHz)	Filter	Line	Corr. (dB)	Margin (dB)	Limit (dBµ V)	Comment
0.394140	46.3	1000.00	9.000	On	N	9.4	11.7	58.0	
0.502810	45.5	1000.00	9.000	On	N	9.4	10.5	56.0	
0.717310	41.5	1000.00	9.000	On	N	9.4	14.5	56.0	

Final Measurement Detector 2

Frequency (MHz)	Average (dBµ V)	Meas. Time (ms)	Bandwidth (kHz)	Filter	Line	Corr. (dB)	Margin (dB)	Limit (dBµ V)	Comment
0.377210	40.1	1000.00	9.000	On	N	9.4	8.2	48.3	
0.432040	40.4	1000.00	9.000	On	N	9.4	6.8	47.2	
0.694760	31.4	1000.00	9.000	On	N	9.4	14.6	46.0	

Emission Level = Read Level + Correct Factor



3.2. Radiated Emission

Limit

FCC CFR Title 47 Part 15 Subpart C Section 15.209 / RSS-Gen 8.9

Frequency (MHz)	Field Strength (microvolts/meter)	Measurement Distance (meters)
0.009~0.490	2400/F (kHz)	300
0.490~1.705	24000/F (kHz)	30
1.705~30.0	30	30
30~88	100	3
88~216	150	3
216~960	200	3
960~1000	500	3

Frequency Range (MHz)	dBµV/m (at 3 meters)	
	Peak	Average
Above 1000	74	54

Note:

- (1) The tighter limit applies at the band edges.
- (2) Emission Level (dBµV/m)=20log Emission Level (µV/m).

Test Configuration

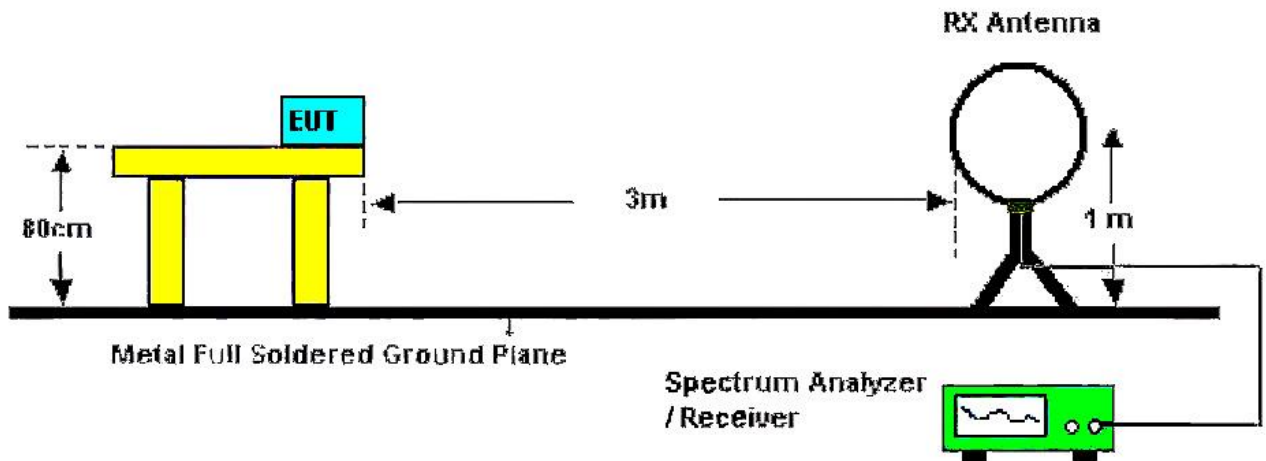

Below 30MHz Test Setup



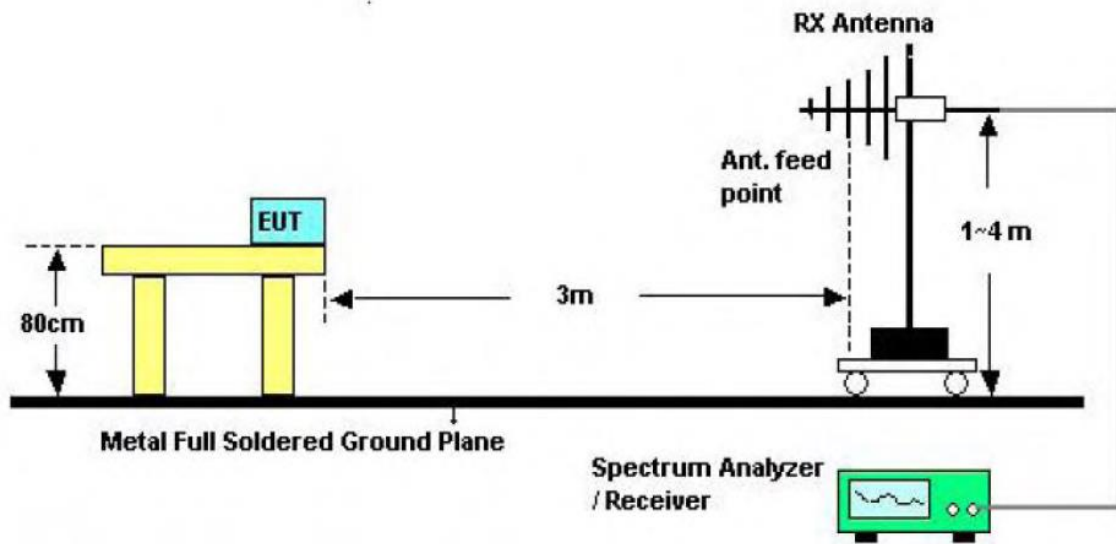

30-1000MHz Test Setup

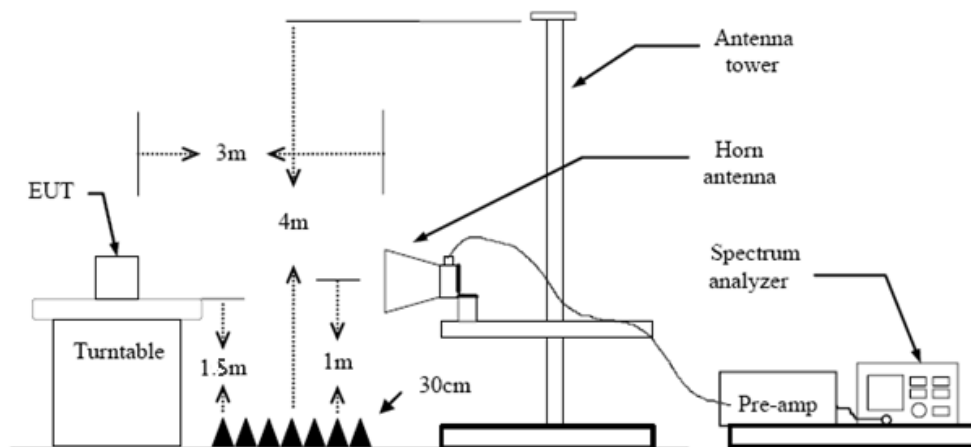

Above 1GHz Test Setup

Test Procedure

1. The EUT was setup and tested according to ANSI C63.10:2013.
2. The EUT is placed on a turn table which is 0.8 meter above ground for below 1 GHz, and 1.5 m for above 1 GHz. The turn table is rotated 360 degrees to determine the position of the maximum emission level.
3. The EUT was set 3 meters from the receiving antenna, which was mounted on the top of a variable height antenna tower.
4. For each suspected emission, the EUT was arranged to its worst case and then tune the Antenna tower (from 1 m to 4 m) and turntable (from 0 degree to 360 degrees) to find the maximum reading. A pre-amp and a high pass filter are used for the test in order to get better signal level to comply with the guidelines.
5. Set to the maximum power setting and enable the EUT transmit continuously.
6. Use the following spectrum analyzer settings
 - (1) Span shall wide enough to fully capture the emission being measured;



(2) 9k – 150kHz:

RBW=300 Hz, VBW=1 kHz, Sweep=auto, Detector function=peak, Trace=max hold

(3) 0.15M – 30MHz:

RBW=10 kHz, VBW=30 kHz, Sweep=auto, Detector function=peak, Trace=max hold

(4) 30M - 1 GHz:

RBW=120 kHz, VBW=300 kHz, Sweep=auto, Detector function=peak, Trace=max hold

If the emission level of the EUT measured by the peak detector is 3 dB lower than the applicable limit, the peak emission level will be reported. Otherwise, the emission measurement will be repeated using the quasi-peak detector and reported.

(5) From 1 GHz to 10th harmonic:

RBW=1MHz, VBW=3MHz Peak detector for Peak value.

RBW=1MHz, VBW see note 1 with Peak Detector for Average Value.

Note 1: For measurements above 1 GHz the resolution bandwidth is set to 1 MHz, then the video bandwidth is set to 3 MHz for peak measurements and 1 MHz resolution bandwidth with 1/T video bandwidth with peak detector for average measurements. For the Duty Cycle please refer to clause 3.8 Duty Cycle.

Test Mode

Please refer to the clause 2.4.

Test Result

9 kHz~30 MHz

From 9 kHz to 30 MHz: The conclusion is PASS.

Note: The amplitude of spurious emissions which are attenuated by more than 20dB below the permissible value has no need to be reported.



30MHz-1GHz

Ant. Pol.	Horizontal
Test Mode:	TX BLE 1M Mode 2402MHz
Remark:	Only worse case is reported.

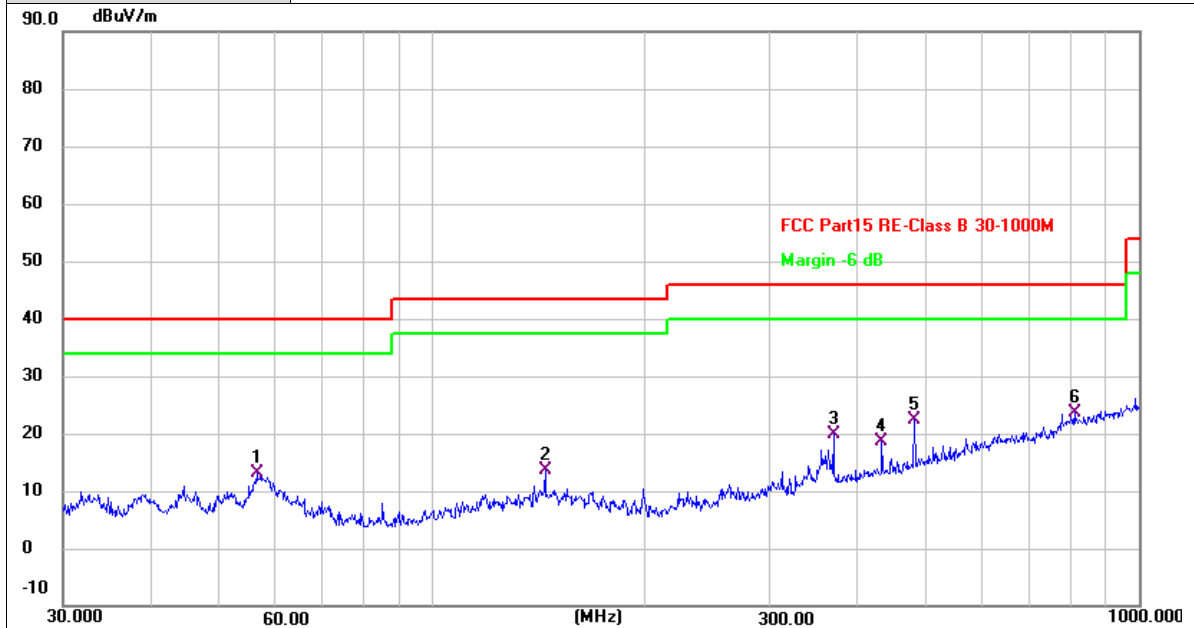

No.	Frequency (MHz)	Reading (dBuV)	Factor (dB/m)	Level (dBuV/m)	Limit (dBuV/m)	Margin (dB)	Detector
1	56.3948	31.70	-18.55	13.15	40.00	-26.85	QP
2	144.3345	31.85	-18.34	13.51	43.50	-29.99	QP
3	369.4047	35.30	-15.51	19.79	46.00	-26.21	QP
4	432.5455	32.19	-13.61	18.58	46.00	-27.42	QP
5	480.5276	34.99	-12.50	22.49	46.00	-23.51	QP
6 *	810.2653	29.49	-5.88	23.61	46.00	-22.39	QP

Remarks:

- 1. Factor (dB/m) = Antenna Factor (dB/m)+Cable Factor (dB)-Pre-amplifier Factor
- 2. Margin value = Level -Limit value



Ant. Pol.	Vertical
Test Mode:	TX BLE 1M Mode 2402MHz
Remark:	Only worse case is reported.

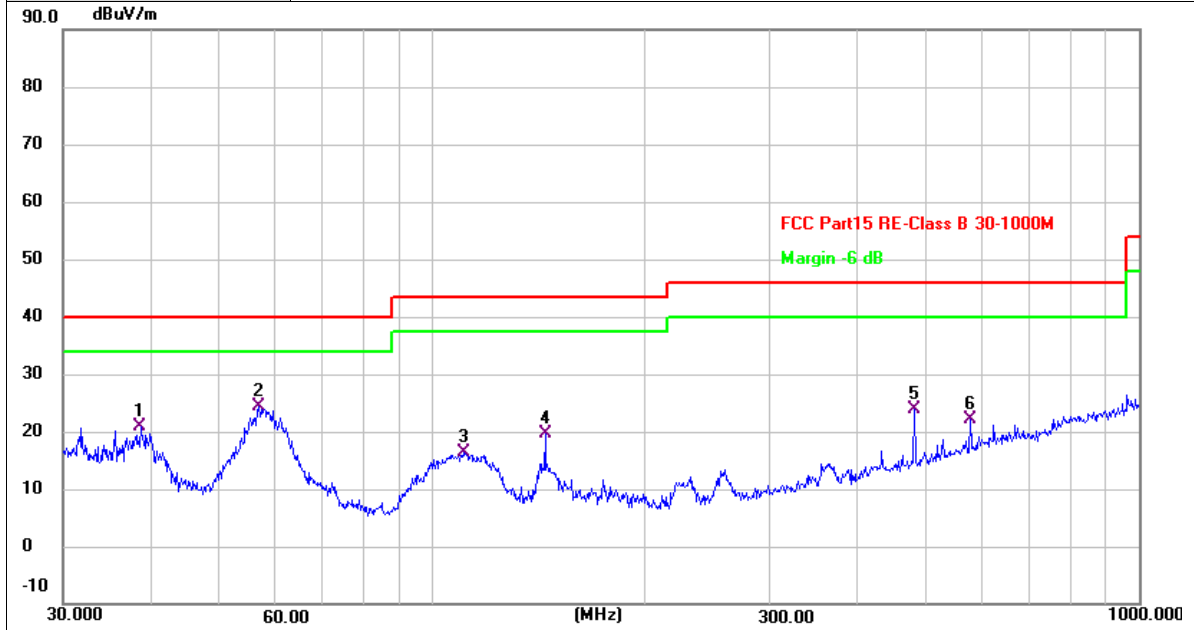

No.	Frequency (MHz)	Reading (dBuV)	Factor (dB/m)	Level (dBuV/m)	Limit (dBuV/m)	Margin (dB)	Detector
1	38.6160	39.26	-18.27	20.99	40.00	-19.01	QP
2 *	56.7917	42.88	-18.58	24.30	40.00	-15.70	QP
3	110.5686	37.60	-21.15	16.45	43.50	-27.05	QP
4	144.3346	38.06	-18.34	19.72	43.50	-23.78	QP
5	480.5276	36.40	-12.50	23.90	46.00	-22.10	QP
6	576.6443	32.29	-10.27	22.02	46.00	-23.98	QP

Remarks:

- Factor (dB/m) = Antenna Factor (dB/m)+Cable Factor (dB)-Pre-amplifier Factor
- Margin value = Level -Limit value





Above 1GHz

Ant. Pol.	Horizontal																														
Test Mode:	TX BLE 1M Mode 2402MHz																														
Remark:	No report for the emission which more than 20 dB below the prescribed limit.																														
<table border="1"> <thead> <tr> <th>No.</th> <th>Frequency (MHz)</th> <th>Reading (dBuV)</th> <th>Factor (dB/m)</th> <th>Level (dBuV/m)</th> <th>Limit (dBuV/m)</th> <th>Margin (dB)</th> <th>Detector</th> </tr> </thead> <tbody> <tr> <td>1 *</td> <td>4804.085</td> <td>30.11</td> <td>2.56</td> <td>32.67</td> <td>54.00</td> <td>-21.33</td> <td>AVG</td> </tr> <tr> <td>2</td> <td>4804.141</td> <td>40.67</td> <td>2.56</td> <td>43.23</td> <td>74.00</td> <td>-30.77</td> <td>peak</td> </tr> </tbody> </table>								No.	Frequency (MHz)	Reading (dBuV)	Factor (dB/m)	Level (dBuV/m)	Limit (dBuV/m)	Margin (dB)	Detector	1 *	4804.085	30.11	2.56	32.67	54.00	-21.33	AVG	2	4804.141	40.67	2.56	43.23	74.00	-30.77	peak
No.	Frequency (MHz)	Reading (dBuV)	Factor (dB/m)	Level (dBuV/m)	Limit (dBuV/m)	Margin (dB)	Detector																								
1 *	4804.085	30.11	2.56	32.67	54.00	-21.33	AVG																								
2	4804.141	40.67	2.56	43.23	74.00	-30.77	peak																								
Remarks: 1.Factor (dB/m) = Antenna Factor (dB/m)+Cable Factor (dB)-Pre-amplifier Factor 2.Margin value = Level -Limit value																															

Ant. Pol.	Vertical																														
Test Mode:	TX BLE 1M Mode 2402MHz																														
Remark:	No report for the emission which more than 20 dB below the prescribed limit.																														
<table border="1"> <thead> <tr> <th>No.</th> <th>Frequency (MHz)</th> <th>Reading (dBuV)</th> <th>Factor (dB/m)</th> <th>Level (dBuV/m)</th> <th>Limit (dBuV/m)</th> <th>Margin (dB)</th> <th>Detector</th> </tr> </thead> <tbody> <tr> <td>1 *</td> <td>4803.964</td> <td>32.72</td> <td>2.56</td> <td>35.28</td> <td>54.00</td> <td>-18.72</td> <td>AVG</td> </tr> <tr> <td>2</td> <td>4803.985</td> <td>42.59</td> <td>2.56</td> <td>45.15</td> <td>74.00</td> <td>-28.85</td> <td>peak</td> </tr> </tbody> </table>								No.	Frequency (MHz)	Reading (dBuV)	Factor (dB/m)	Level (dBuV/m)	Limit (dBuV/m)	Margin (dB)	Detector	1 *	4803.964	32.72	2.56	35.28	54.00	-18.72	AVG	2	4803.985	42.59	2.56	45.15	74.00	-28.85	peak
No.	Frequency (MHz)	Reading (dBuV)	Factor (dB/m)	Level (dBuV/m)	Limit (dBuV/m)	Margin (dB)	Detector																								
1 *	4803.964	32.72	2.56	35.28	54.00	-18.72	AVG																								
2	4803.985	42.59	2.56	45.15	74.00	-28.85	peak																								
Remarks: 1.Factor (dB/m) = Antenna Factor (dB/m)+Cable Factor (dB)-Pre-amplifier Factor 2.Margin value = Level -Limit value																															



Ant. Pol.	Horizontal
Test Mode:	TX BLE 1M Mode 2440MHz
Remark:	No report for the emission which more than 20 dB below the prescribed limit.

No.	Frequency (MHz)	Reading (dBuV)	Factor (dB/m)	Level (dBuV/m)	Limit (dBuV/m)	Margin (dB)	Detector
1 *	4879.971	29.31	2.79	32.10	54.00	-21.90	AVG
2	4880.002	40.26	2.79	43.05	74.00	-30.95	peak

Remarks:

1. Factor (dB/m) = Antenna Factor (dB/m)+Cable Factor (dB)-Pre-amplifier Factor

2. Margin value = Level -Limit value

Ant. Pol.	Vertical
Test Mode:	TX BLE 1M Mode 2440MHz
Remark:	No report for the emission which more than 20 dB below the prescribed limit.

No.	Frequency (MHz)	Reading (dBuV)	Factor (dB/m)	Level (dBuV/m)	Limit (dBuV/m)	Margin (dB)	Detector
1	4879.895	42.20	2.79	44.99	74.00	-29.01	peak
2 *	4880.022	31.88	2.79	34.67	54.00	-19.33	AVG

Remarks:

1. Factor (dB/m) = Antenna Factor (dB/m)+Cable Factor (dB)-Pre-amplifier Factor

2. Margin value = Level -Limit value



Ant. Pol.	Horizontal
Test Mode:	TX BLE 1M Mode 2480MHz
Remark:	No report for the emission which more than 20 dB below the prescribed limit.

No.	Frequency (MHz)	Reading (dBuV)	Factor (dB/m)	Level (dBuV/m)	Limit (dBuV/m)	Margin (dB)	Detector
1	4959.948	40.07	3.04	43.11	74.00	-30.89	peak
2 *	4960.212	29.59	3.04	32.63	54.00	-21.37	AVG

Remarks:

1. Factor (dB/m) = Antenna Factor (dB/m)+Cable Factor (dB)-Pre-amplifier Factor

2. Margin value = Level -Limit value

Ant. Pol.	Vertical
Test Mode:	TX BLE 1M Mode 2480MHz
Remark:	No report for the emission which more than 20 dB below the prescribed limit.

No.	Frequency (MHz)	Reading (dBuV)	Factor (dB/m)	Level (dBuV/m)	Limit (dBuV/m)	Margin (dB)	Detector
1	4959.885	42.07	3.04	45.11	74.00	-28.89	peak
2 *	4959.923	31.80	3.04	34.84	54.00	-19.16	AVG

Remarks:

1. Factor (dB/m) = Antenna Factor (dB/m)+Cable Factor (dB)-Pre-amplifier Factor

2. Margin value = Level -Limit value

3.3. Band Edge Emissions (Radiated)

Limit

FCC CFR Title 47 Part 15 Subpart C Section 15.247 (d) / RSS-247 5.5

Restricted Frequency Band (MHz)	(dB μ V/m) (at 3m)	
	Peak	Average
2310 ~ 2390	74	54
2483.5 ~ 2500	74	54

Test Configuration

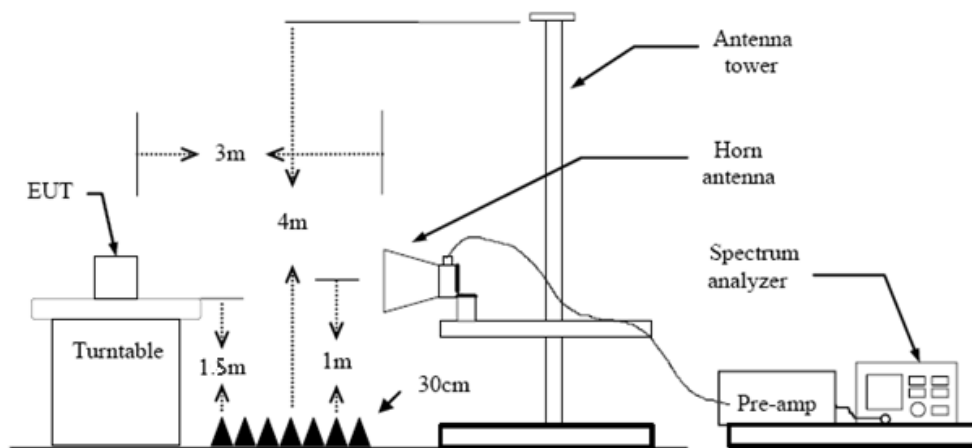

Test Procedure

1. The EUT was setup and tested according to ANSI C63.10:2013 requirements.
2. The EUT is placed on a turn table which is 1.5 meter above ground. The turn table is rotated 360 degrees to determine the position of the maximum emission level.
3. The EUT was positioned such that the distance from antenna to the EUT was 3 meters.
4. The antenna is scanned from 1 meter to 4 meters to find out the maximum emission level. This is repeated for both horizontal and vertical polarization of the antenna. In order to find the maximum emission, all of the interface cables were manipulated according to ANSI C63.10:2013 on radiated measurement.
5. The receiver set as follow:
 RBW=1MHz, VBW=3MHz Peak detector for Peak value.
 RBW=1MHz, VBW see note 1 with Peak Detector for Average Value.

Note 1: For measurements, above 1 GHz the resolution bandwidth is set to 1 MHz, then the video bandwidth is set to 3 MHz for peak measurements and 1 MHz resolution bandwidth with 1/T video bandwidth with peak detector for average measurements. For the Duty Cycle please refer to clause 3.8 Duty Cycle.

Test Mode

Please refer to the clause 2.4.



Test Result

Ant. Pol.	Horizontal
Test Mode:	TX BLE 1M Mode 2402MHz

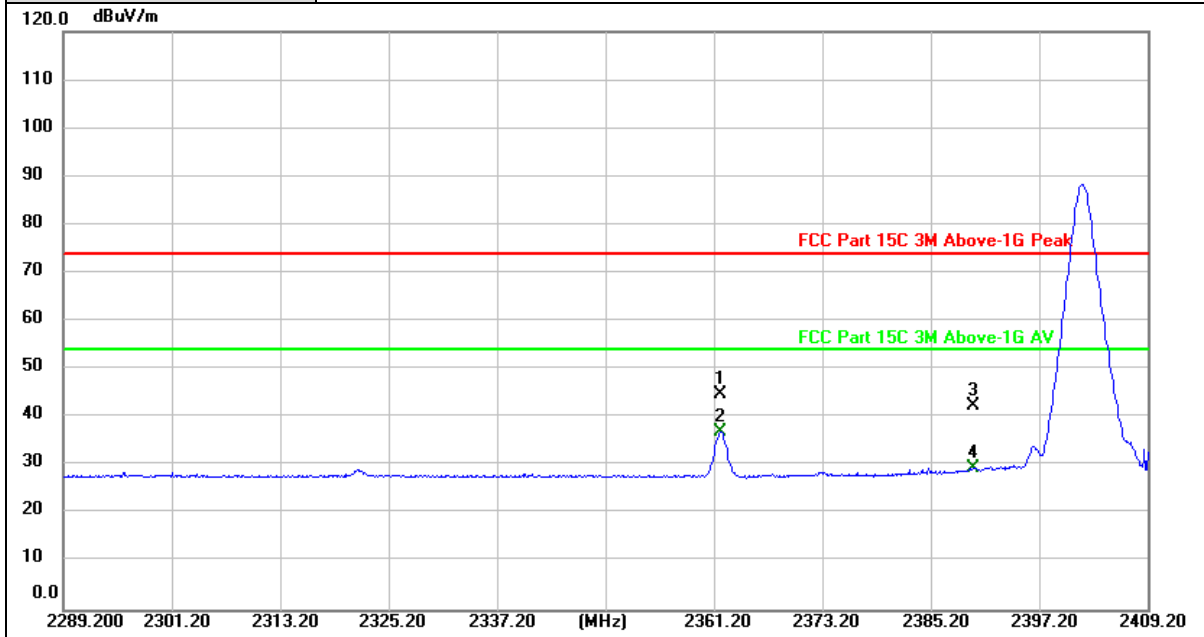

No.	Frequency (MHz)	Reading (dBuV)	Factor (dB/m)	Level (dBuV/m)	Limit (dBuV/m)	Margin (dB)	Detector
1	2361.968	53.72	-8.97	44.75	74.00	-29.25	peak
2 *	2361.968	46.12	-8.97	37.15	54.00	-16.85	AVG
3	2390.000	51.22	-8.88	42.34	74.00	-31.66	peak
4	2390.000	38.32	-8.88	29.44	54.00	-24.56	AVG

Remarks:

- 1.Factor (dB/m) = Antenna Factor (dB/m)+Cable Factor (dB)-Pre-amplifier Factor
- 2.Margin value = Level -Limit value

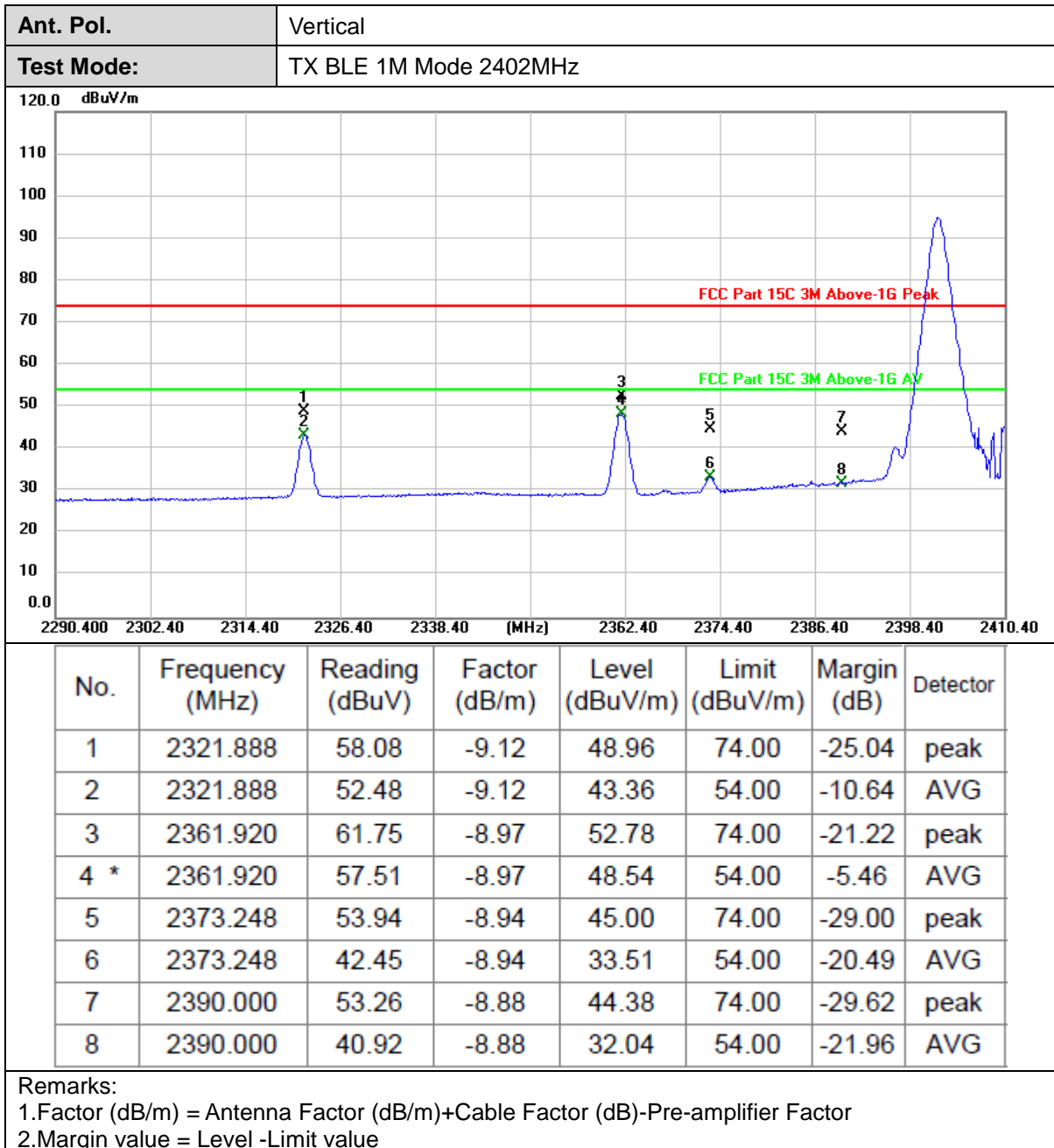



Ant. Pol. Horizontal

Test Mode: TX BLE 1M Mode 2480MHz

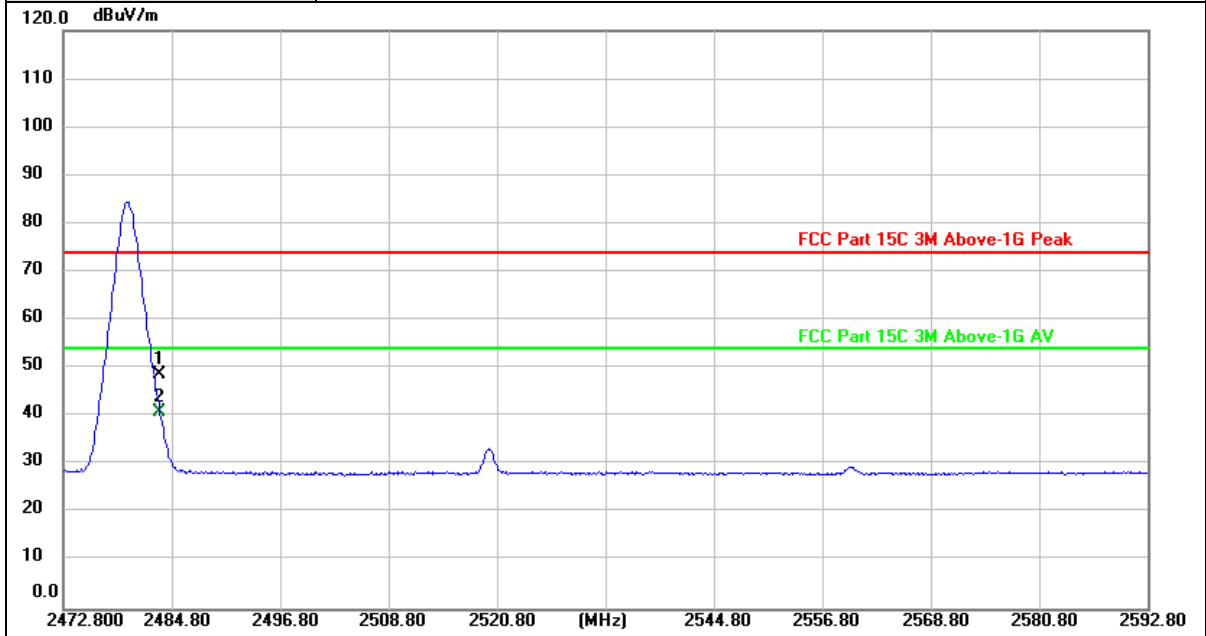

No.	Frequency (MHz)	Reading (dBuV)	Factor (dB/m)	Level (dBuV/m)	Limit (dBuV/m)	Margin (dB)	Detector
1	2483.500	57.21	-8.56	48.65	74.00	-25.35	peak
2 *	2483.500	49.45	-8.56	40.89	54.00	-13.11	AVG

Remarks:
 1. Factor (dB/m) = Antenna Factor (dB/m)+Cable Factor (dB)-Pre-amplifier Factor
 2. Margin value = Level -Limit value

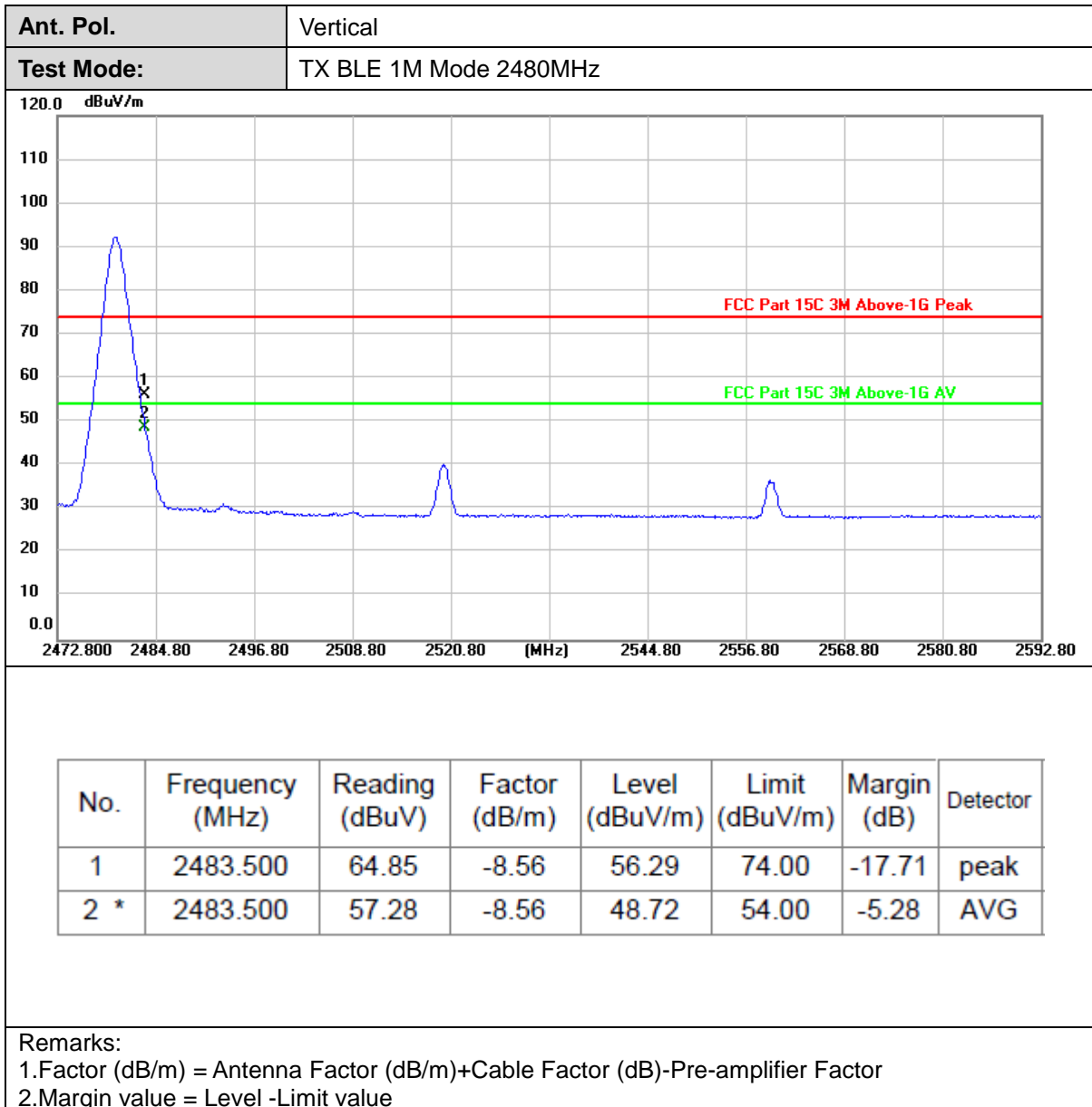



3.4. Band Edge and Spurious Emissions (Conducted)

Limit

FCC CFR Title 47 Part 15 Subpart C Section 15.247 (d) / RSS-247 5.5

In any 100 kHz bandwidth outside the frequency band in which the spread spectrum intentional radiator is operating, the radio frequency power that is produced by the intentional radiator shall be at least 20 dB below that in the 100 kHz bandwidth within the band that contains the highest level of the desired power, based on either an RF conducted or a radiated measurement, provided the transmitter demonstrates compliance with the peak conducted power limits. If the transmitter complies with the conducted power limits based on the use of RMS averaging over a time interval, as permitted under paragraph (b)(3) of this section, the attenuation required under this paragraph shall be 30 dB instead of 20 dB.

Test Configuration

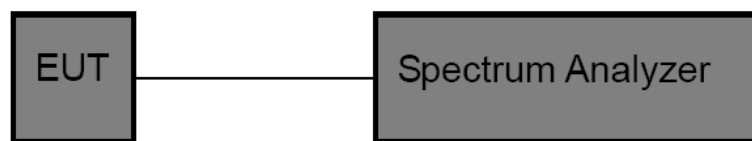

Test Procedure

1. The transmitter output was connected to the spectrum analyzer through an attenuator, the path loss was compensated to the results for each measurement.
2. Set to the maximum power setting and enable the EUT transmit continuously.
3. Use the following spectrum analyzer settings:
RBW = 100 kHz, VBW ≥ RBW, scan up through 10th harmonic.
Sweep = auto, Detector function = peak, Trace = max hold.
4. Measure and record the results in the test report.

Test Mode

Please refer to the clause 2.4.

Test Result

Conducted Spurious Emission

Test Mode	Antenna	Channel	FreqRange [MHz]	RefLevel [dBm]	Result[dBm]	Limit[dBm]	Verdict
BLE_1M	Ant1	2402	Reference	5.76	5.76	---	PASS
			30~1000	5.76	-60.75	≤-14.24	PASS
			1000~26500	5.76	-40.66	≤-14.24	PASS
		2440	Reference	5.42	5.42	---	PASS
			30~1000	5.42	-60.18	≤-14.58	PASS
			1000~26500	5.42	-42.47	≤-14.58	PASS
		2480	Reference	4.72	4.72	---	PASS
			30~1000	4.72	-60.62	≤-15.28	PASS
			1000~26500	4.72	-42.10	≤-15.28	PASS



Test Graphs:

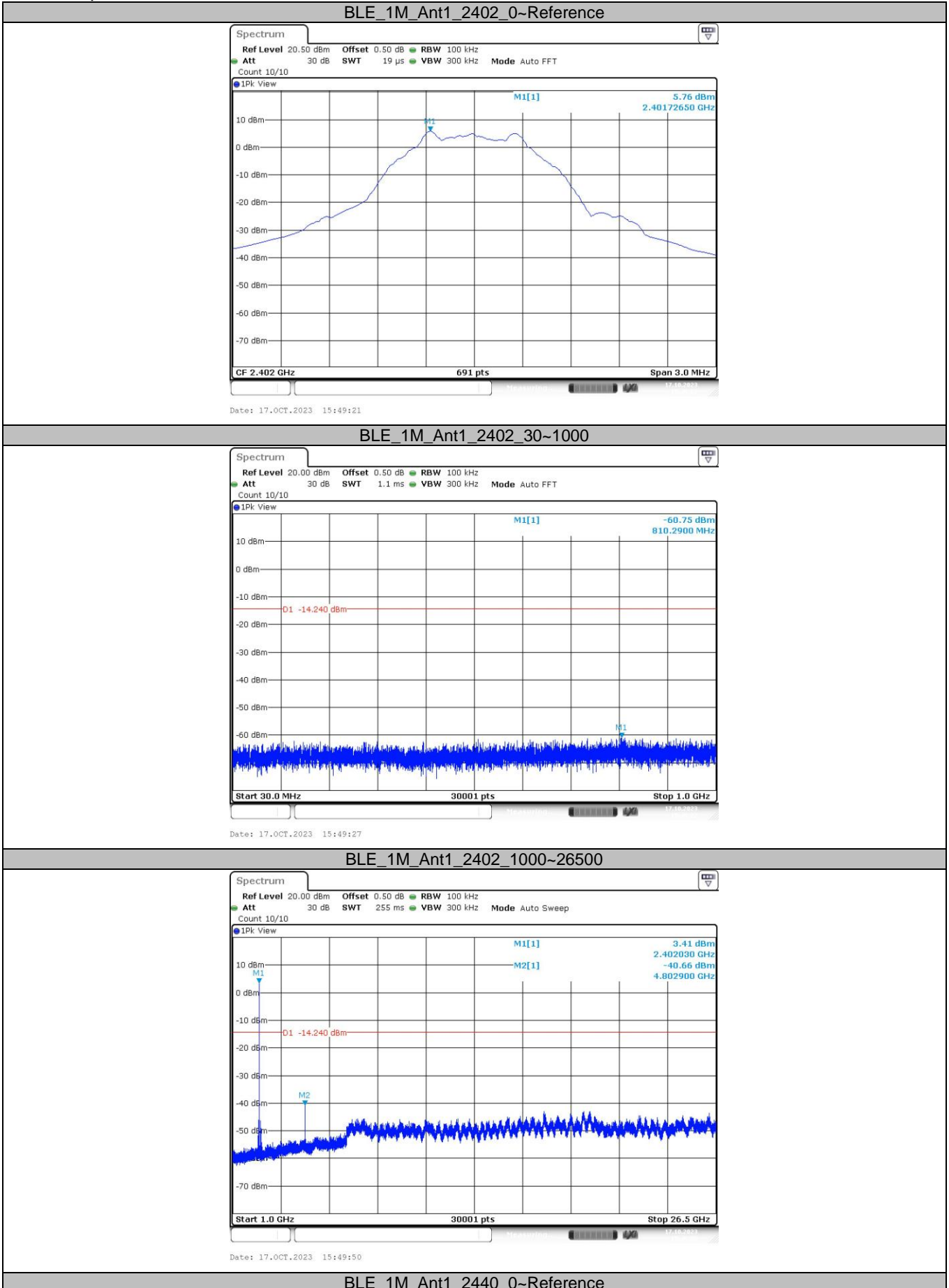



Date: 17.OCT.2023 15:52:34

BLE_1M_Ant1_2440_30~1000

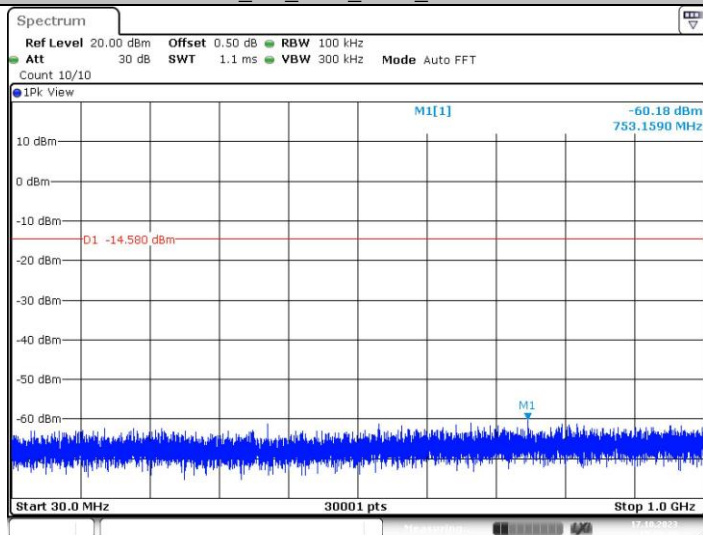

Date: 17.OCT.2023 15:52:40

BLE_1M_Ant1_2440_1000~26500

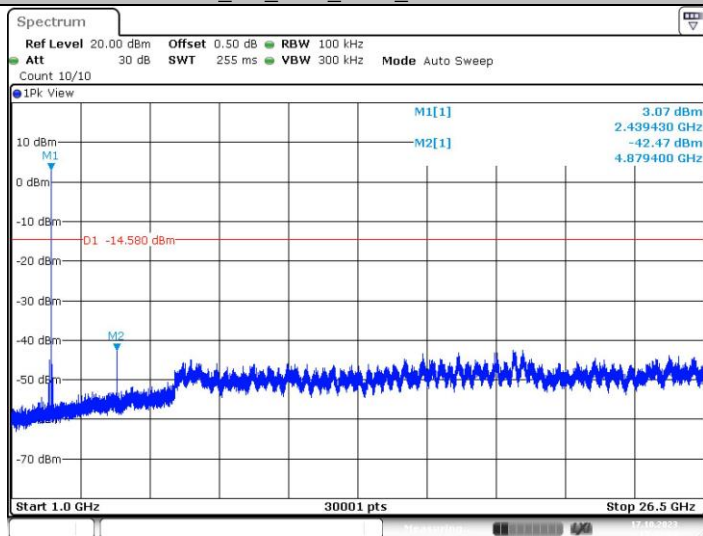

Date: 17.OCT.2023 15:53:03

BLE_1M_Ant1_2480_0~Reference



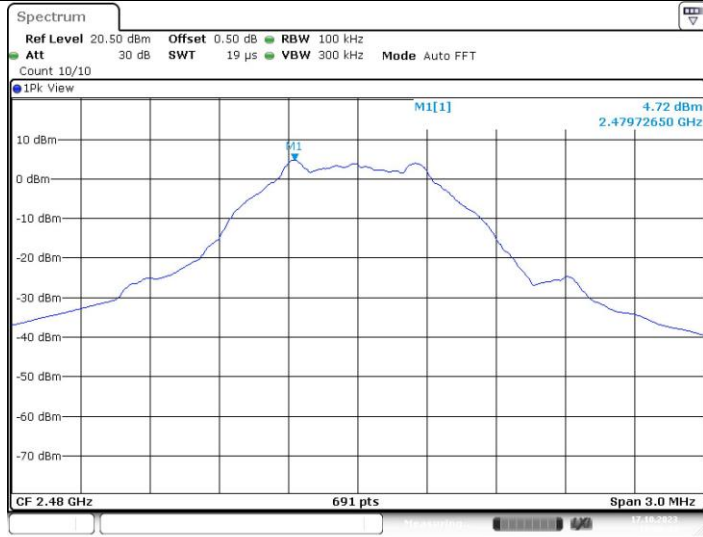

Date: 17.OCT.2023 16:00:43

BLE_1M_Ant1_2480_30~1000

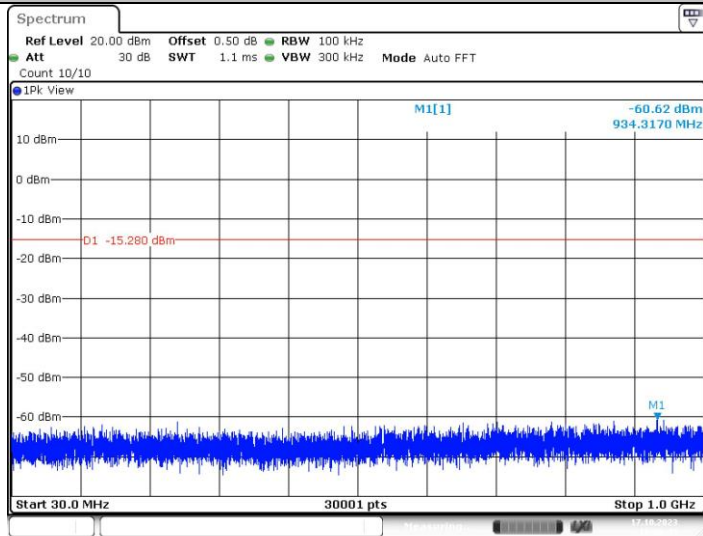

Date: 17.OCT.2023 16:00:49

BLE_1M_Ant1_2480_1000~26500

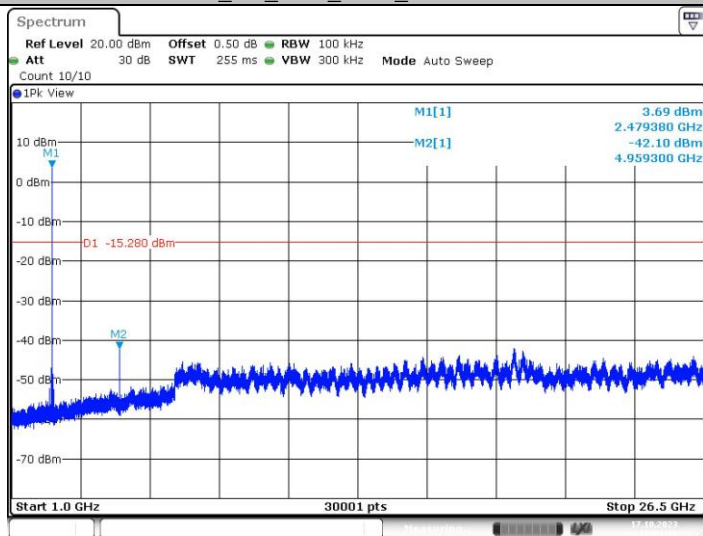

Date: 17.OCT.2023 16:01:12



Conducted Band edge

Test Mode	Antenna	ChName	Channel	RefLevel[dBm]	Result[dBm]	Limit[dBm]	Verdict
BLE_1M	Ant1	Low	2402	5.76	-43.08	≤-14.24	PASS
		High	2480	4.34	-45.84	≤-15.66	PASS

Test Graphs:

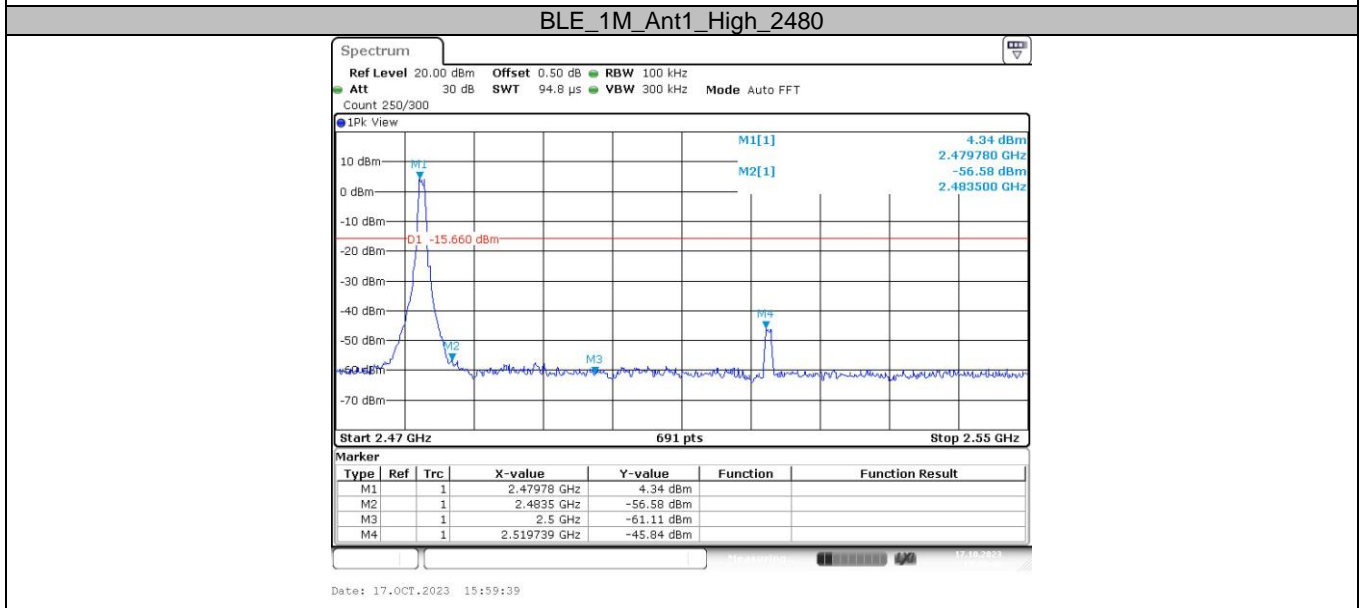
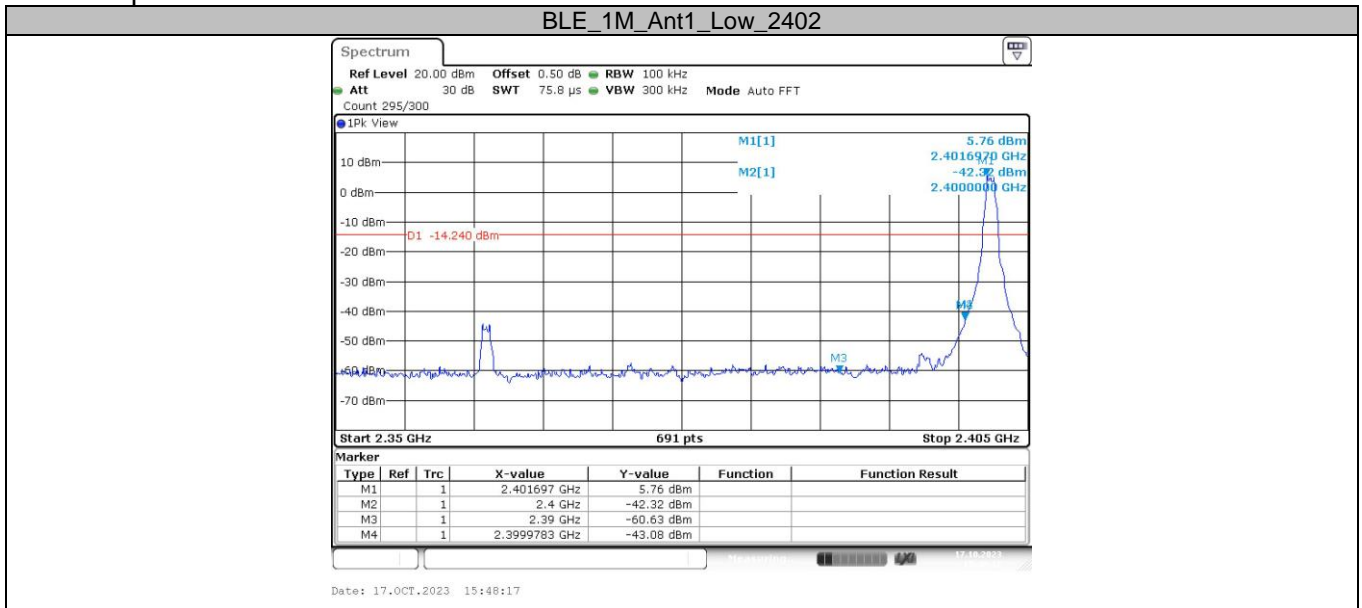



3.5. DTS Bandwidth

Limit

FCC CFR Title 47 Part 15 Subpart C Section 15.247 (a)(2) / RSS-247 5.2 a

Test Item	Limit	Frequency Range (MHz)
DTS Bandwidth	≥500 kHz (6dB bandwidth)	2400~2483.5

Test Configuration

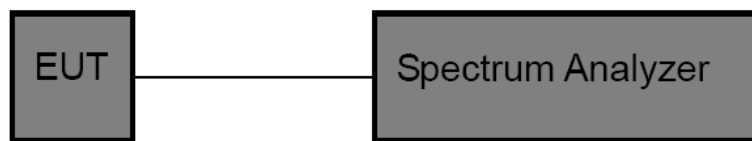

Test Procedure

- The EUT was directly connected to the spectrum analyzer and antenna output port as show in the block diagram above.
- DTS Spectrum Setting:
 - Set RBW = 100 kHz.
 - Set the video bandwidth (VBW) ≥ 3 RBW.
 - Detector = Peak.
 - Trace mode = Max hold.
 - Sweep = Auto couple.
- OCB Spectrum Setting:
 - Set RBW = 1% ~ 5% occupied bandwidth.
 - Set the video bandwidth (VBW) ≥ 3 RBW.
 - Detector = Peak.
 - Trace mode = Max hold.
 - Sweep = Auto couple.

NOTE: The EUT was set to continuously transmitting in each mode and low, Middle and high channel for the test.

Test Mode

Please refer to the clause 2.4.

Test Result

Test Mode	Frequency (MHz)	99% Bandwidth (MHz)	DTS Bandwidth (MHz)	Limit (MHz)	Verdict
BLE_1M	2402	1.047	0.716	≥0.5	Pass
	2440	1.051	0.716	≥0.5	Pass
	2480	1.043	0.720	≥0.5	Pass



99% Bandwidth:

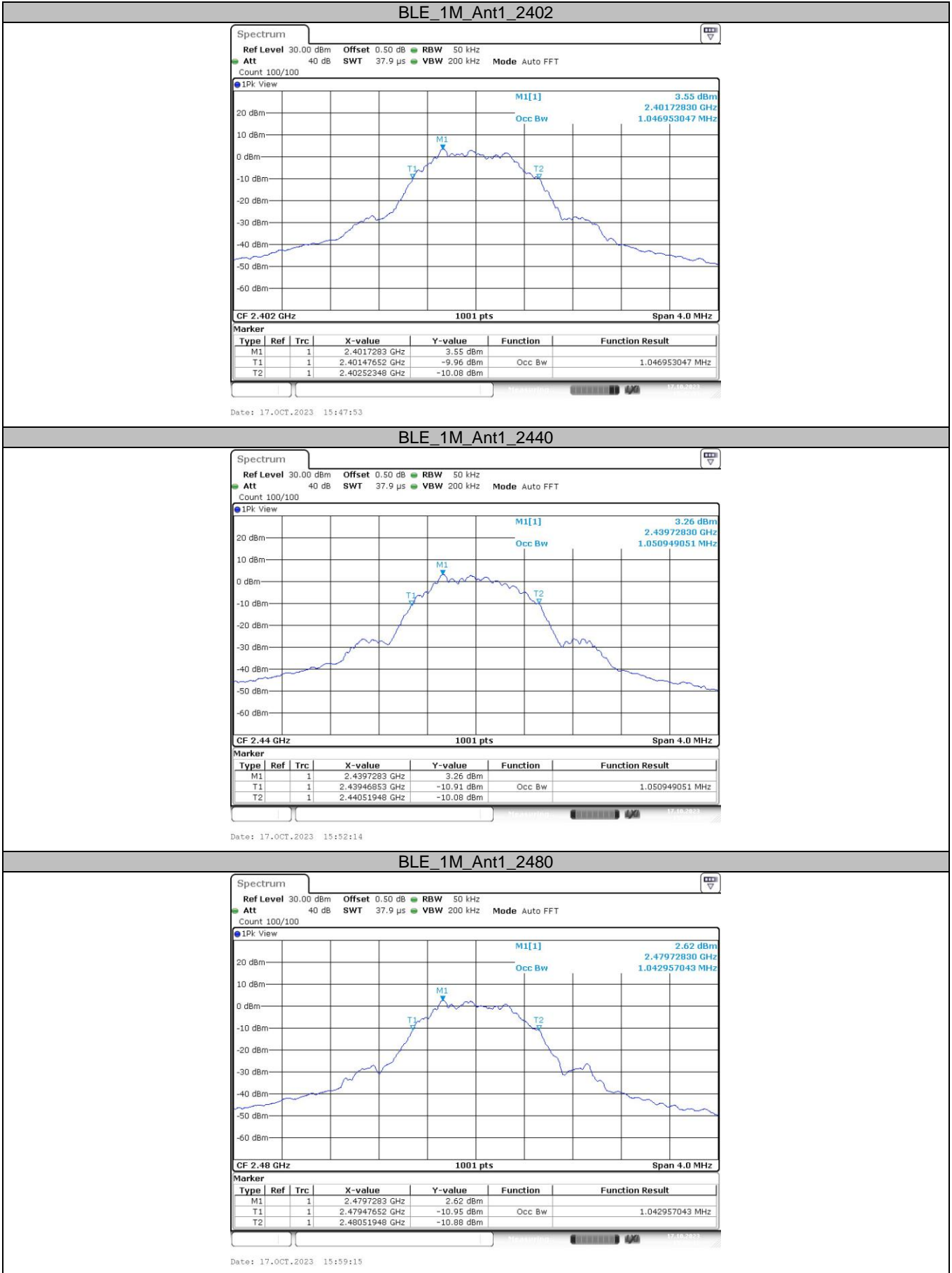

CTC Laboratories, Inc.

2/F., Building 1 and 1-2/F., Building 2, Jiaquan Building, Guanlan High-Tech Park, Longhua District, Shenzhen, Guangdong, China
Tel.: (86)755-27521059 Fax: (86)755-27521011 Http://www.sz-ctc.org.cn



For anti-fake verification, please visit the official website of Certification and Accreditation Administration of the People's Republic of China : <http://yz.cnca.cn>



DTS Bandwidth:

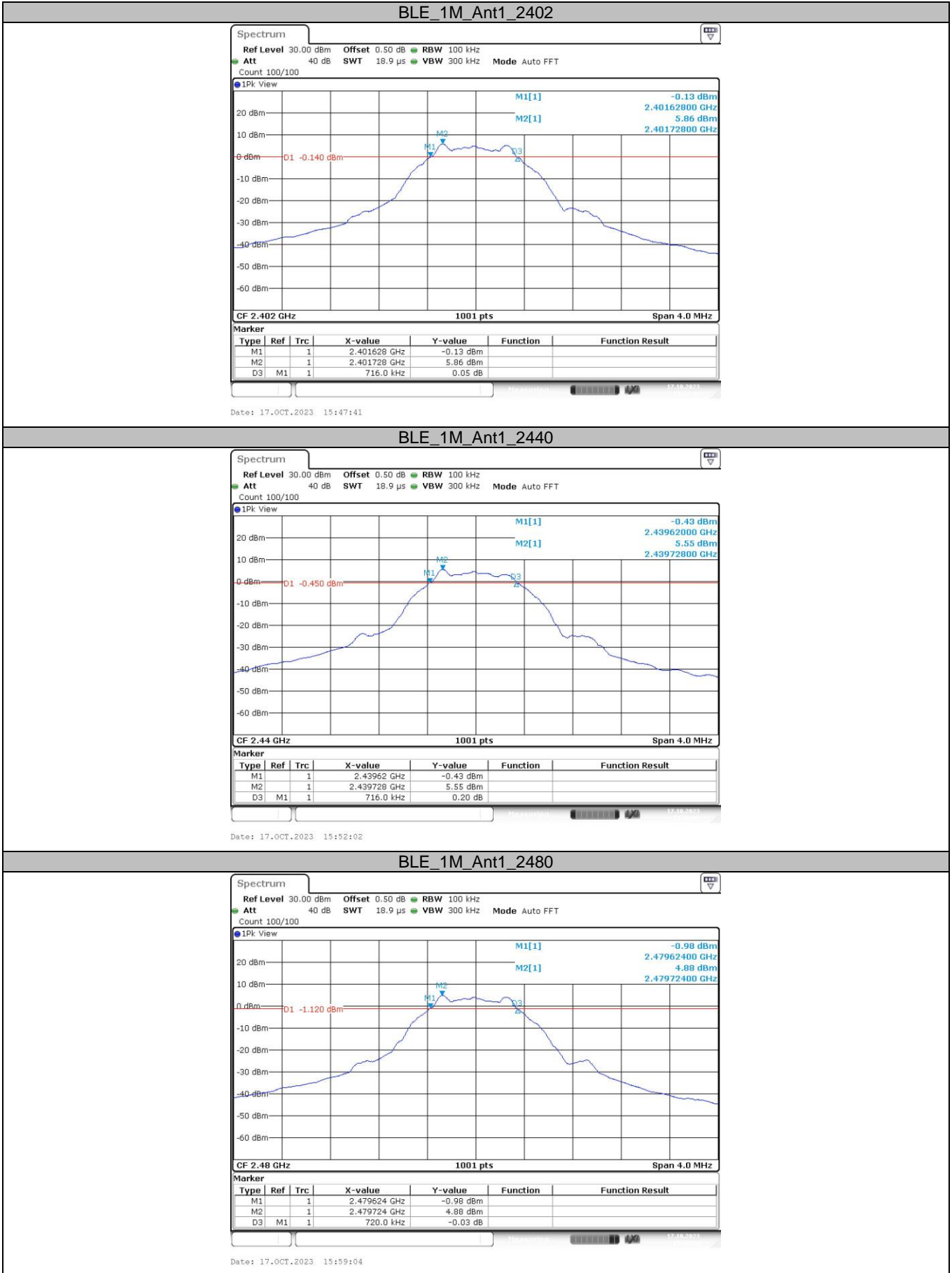

CTC Laboratories, Inc.

2/F., Building 1 and 1-2/F., Building 2, Jiaquan Building, Guanlan High-Tech Park, Longhua District, Shenzhen, Guangdong, China
Tel.: (86)755-27521059 Fax: (86)755-27521011 Http://www.sz-ctc.org.cn



For anti-fake verification, please visit the official website of Certification and Accreditation Administration of the People's Republic of China : <http://yz.cnca.cn>



3.6. Peak Output Power

Limit

FCC CFR Title 47 Part 15 Subpart C Section 15.247 (b)(3) / RSS-247 5.4 d

Section	Test Item	Limit	Frequency Range (MHz)
FCC CFR 47 Part15.247 (b)(3)	Maximum Conducted Output Power	1 Watt or 30dBm	2400~2483.5
ISED RSS-247 5.4 d	EIRP	4 Watt or 36dBm	2400~2483.5

Test Configuration

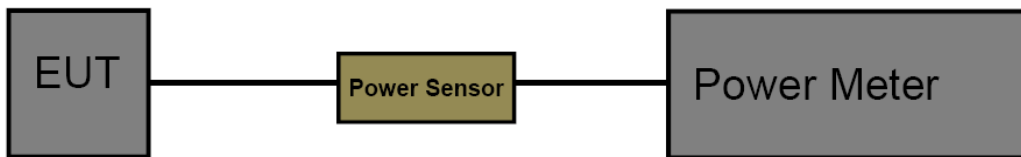

Test Procedure

1. The maximum conducted output power may be measured using a broadband Peak RF power meter.
2. Peak power measurements were performed only when the EUT was transmitting at its maximum power control level using a broadband power meter with a pulse sensor.
3. The power meter implemented triggering and gating capabilities which were set up such that power measurements were recorded only during the ON time of the transmitter.
Record the measurement data.

Test Mode

Please refer to the clause 2.4.

Test Result

Test Mode	Antenna	Channel	Result[dBm]	Limit[dBm]	Verdict
BLE_1M	Ant1	2402	6.22	≤30	PASS
		2440	5.99	≤30	PASS
		2480	5.38	≤30	PASS



3.7. Power Spectral Density

Limit

FCC CFR Title 47 Part 15 Subpart C Section 15.247 (e) / RSS-247 5.2 b

Test Item	Limit	Frequency Range (MHz)
Power Spectral Density	8 dBm (in any 3 kHz)	2400~2483.5

Test Configuration

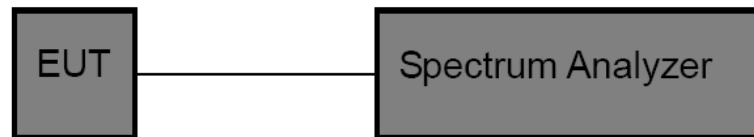

Test Procedure

1. The EUT was directly connected to the spectrum analyzer and antenna output port as show in the block diagram above.
2. The EUT was directly connected to the Spectrum Analyzer and antenna output port as show in the block diagram above. The measurement according to section 10.2 of KDB 558074 D01 DTS Meas Guidance v05r02.
3. Spectrum Setting:
Set analyzer center frequency to DTS channel center frequency.
Set the span to 1.5 times the DTS bandwidth.
Set the RBW to: 3 kHz.
Set the VBW to: 10 kHz.
Detector: peak.
Sweep time: auto.
Allow trace to fully stabilize. Then use the peak marker function to determine the maximum amplitude level.

Test Mode

Please refer to the clause 2.4.

Test Result

Test Mode	Antenna	Channel	Result[dBm/3-100kHz]	Limit[dBm/3kHz]	Verdict
BLE_1M	Ant1	2402	-11.52	≤8	PASS
		2440	-11.64	≤8	PASS
		2480	-11.48	≤8	PASS



Test Graphs:

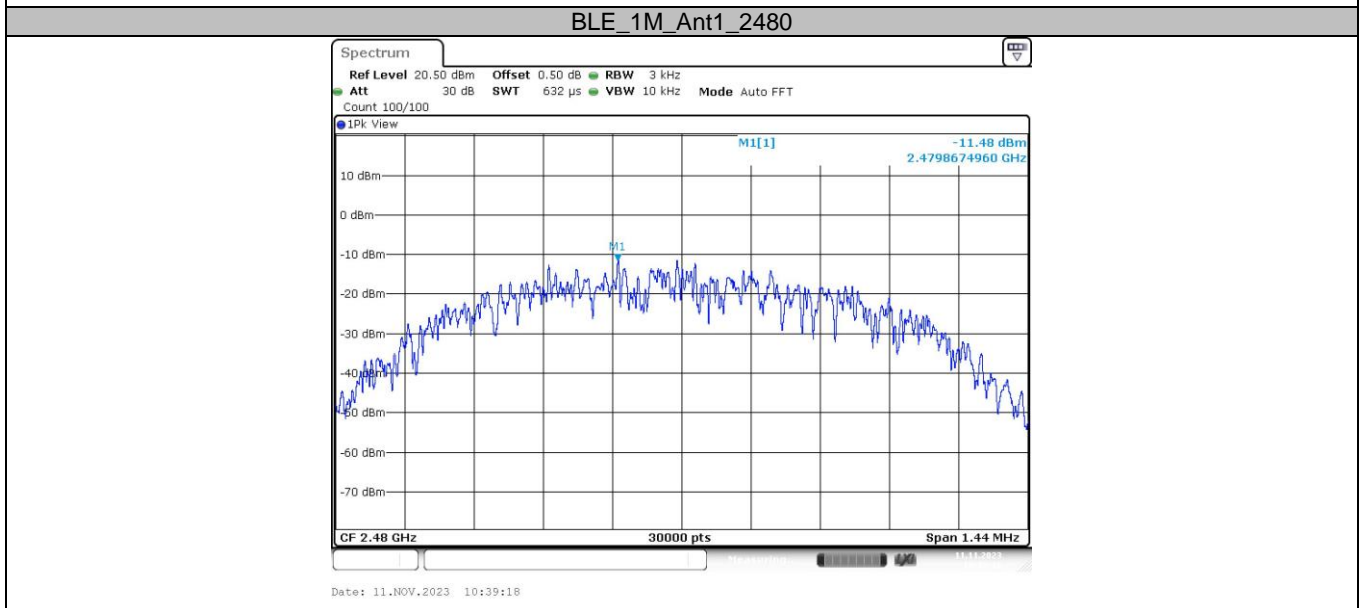
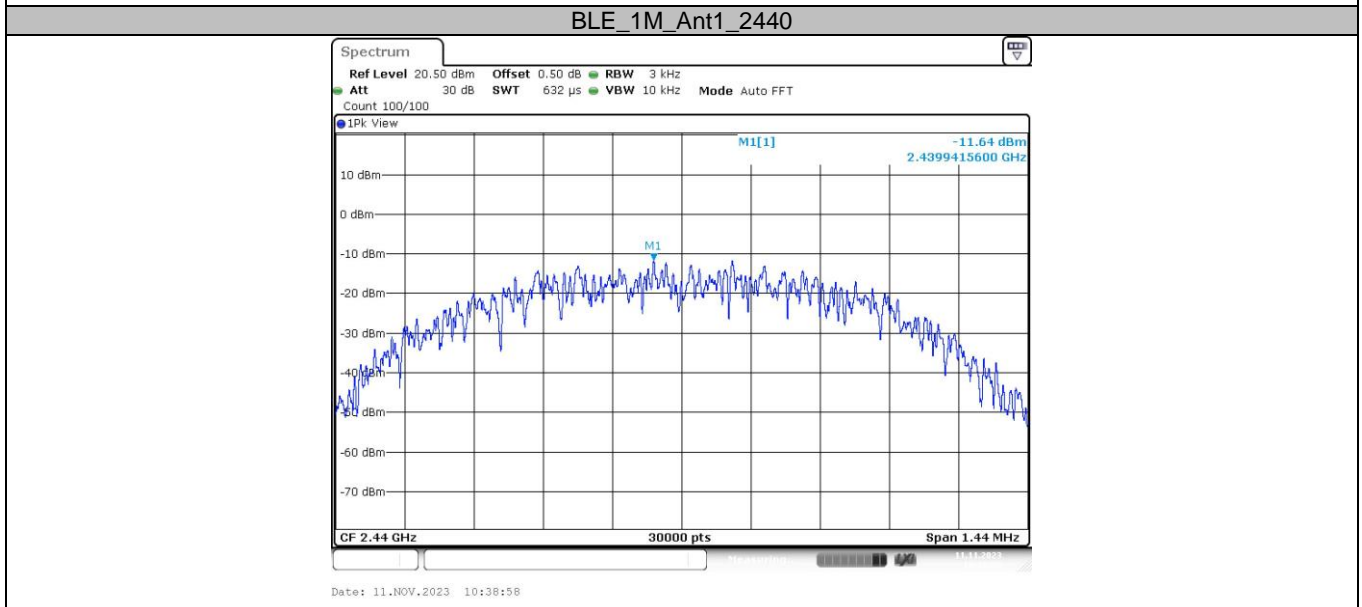
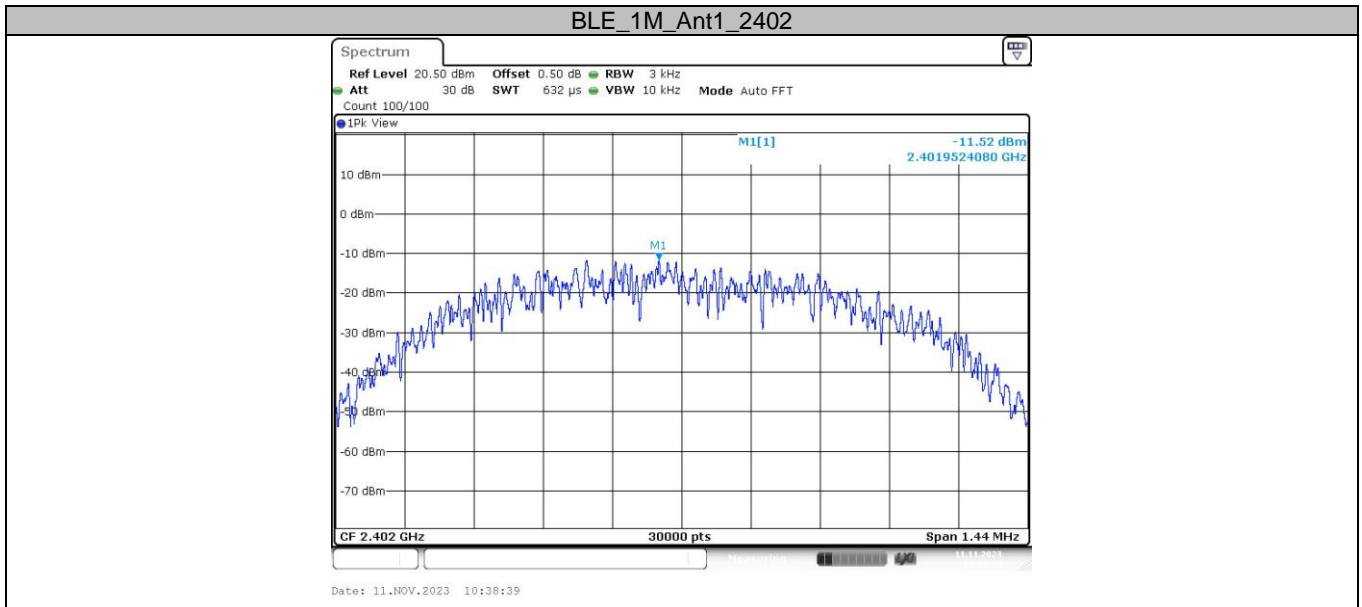



3.8. Duty Cycle

Limit

None, for report purposes only.

Test Configuration

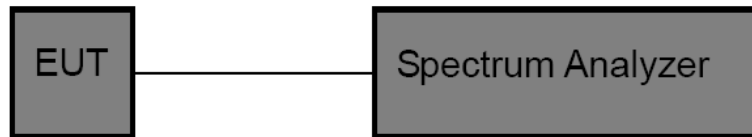

Test Procedure

1. The EUT was directly connected to the spectrum analyzer and antenna output port as show in the block diagram above.
2. The EUT was directly connected to the Spectrum Analyzer and antenna output port as show in the block diagram above. The measurement according to section 10.2 of KDB 558074 D01 DTS Meas Guidance v05r02.
3. Spectrum Setting:
 Set analyzer center frequency to test channel center frequency.
 Set the span to 0Hz.
 Set the RBW to 10MHz.
 Set the VBW to 10MHz.
 Detector: Peak.
 Sweep time: Auto.
 Allow trace to fully stabilize. Then use the peak marker function to determine the maximum amplitude level.

Test Mode

Please refer to the clause 2.4.

Test Result

Test Mode	Channel	Transmission Duration [ms]	Transmission Period [ms]	Duty Cycle [%]	1/T Minimum VBW (kHz)	Final Setting for VBW (kHz)
BLE_1M	2402	0.40	0.62	64.52	2.5	3
	2440	0.40	0.62	64.52	2.5	3
	2480	0.40	0.62	64.52	2.5	3



Test Graphs:

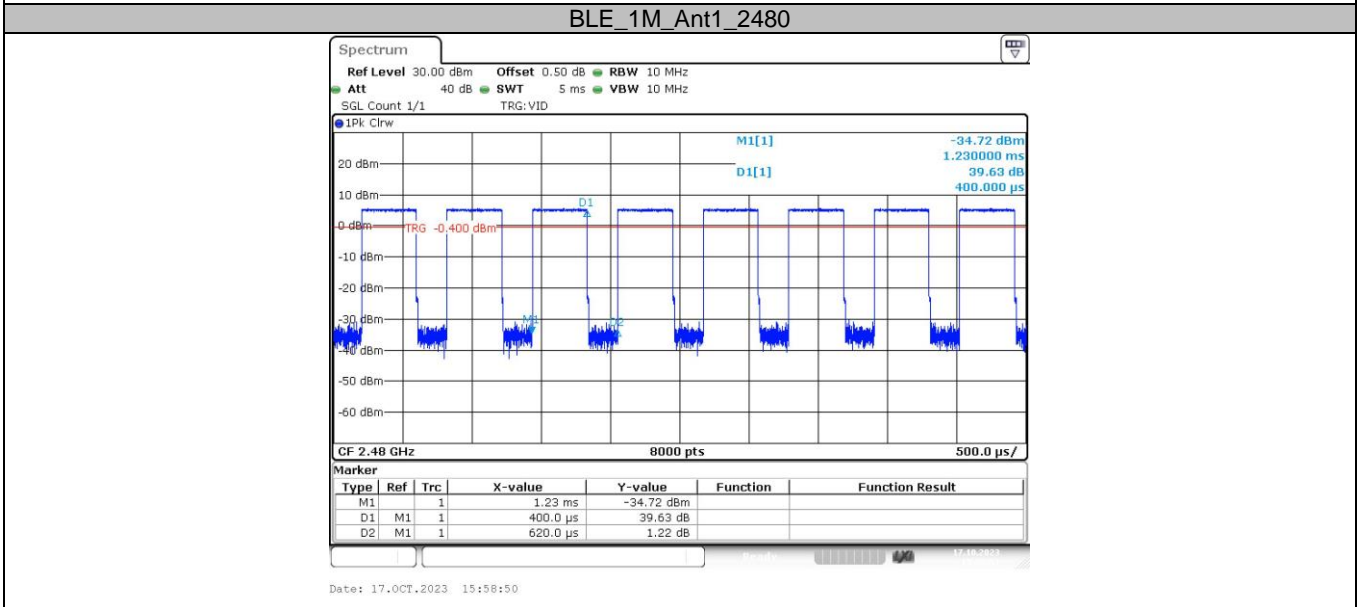
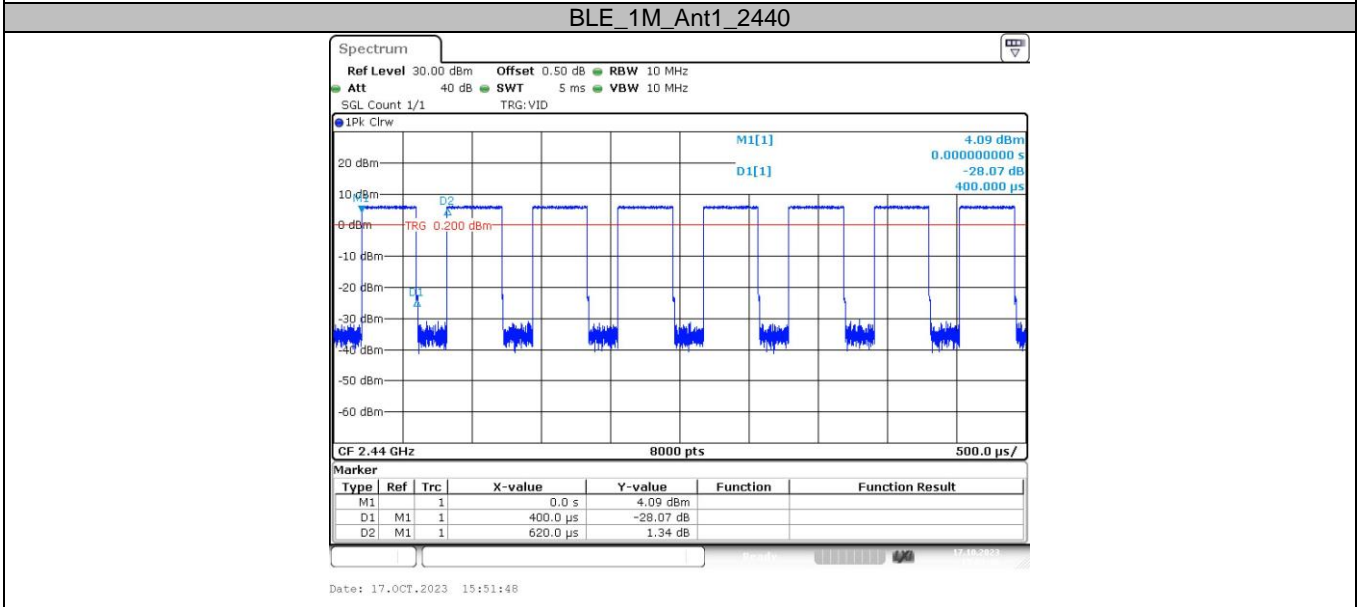
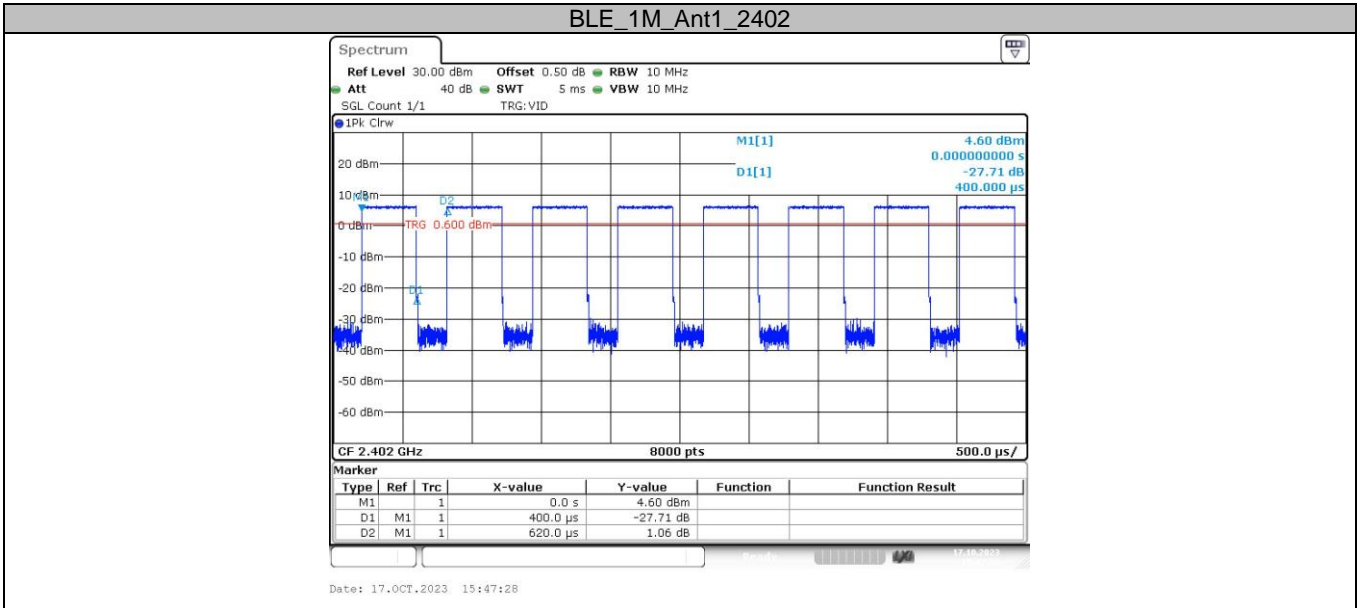



3.9. Antenna Requirement

Requirement

FCC CFR Title 47 Part 15 Subpart C Section 15.203

An intentional radiator shall be designed to ensure that no antenna other than that furnished by the responsible party shall be used with the device. The use of a permanently attached antenna or of antenna that uses a unique coupling to the intentional radiator, the manufacturer may design the unit so that a broken antenna can be replaced by the user, but the use of a standard antenna jack or electrical connector is prohibited.

FCC CFR Title 47 Part 15 Subpart C Section 15.247(c) (1)(i)

(i) Systems operating in the 2400~2483.5 MHz band that is used exclusively for fixed. Point-to-point operations may employ transmitting antennas with directional gain greater than 6dBi provided the maximum conducted output power of the intentional radiator is reduced by 1 dB for every 3 dB that the directional gain of the antenna exceeds 6dBi.

Test Result

The directional gain of the antenna is less than 6dBi, please refer to the EUT internal photographs antenna photo.

*****THE END*****