



FCC RADIO TEST REPORT

Applicant : BROWAN Communications Inc.
Address : No.15-1, Zhonghua Rd.,Hsinchu Industrial Park,
Hukou, Hsinchu, Taiwan, 30352.
Equipment : LoRa Module
Model No. : WMDS-183G2
Trade Name : BROWAN
FCC ID. : 2AAS9-WMDS183G2

I HEREBY CERTIFY THAT :

The sample was received on May. 30, 2022 and the testing was completed on Aug. 01, 2022 at CerpPASS Technology Corp. The test result refers exclusively to the test presented test model / sample. Without written approval of CerpPASS Technology Corp., the test report shall not be reproduced except in full.

Approved by:

Vic Hsiao / Supervisor

Laboratory Accreditation:

CerpPASS Technology Corporation Test Laboratory





CONTENTS

1. Summary of Test Procedure and Test Results	5
1.1 Applicable Standards	5
2. Test Configuration of Equipment under Test	6
2.1 Feature of Equipment under Test	6
2.2 Carrier Frequency of Channes	7
2.3 Test Mode & Test Software	8
2.4 Description of Test System	9
2.5 General Information of Test	10
2.6 Measurement Uncertainty	11
3. Test Equipment and Ancillaries Used for Tests	12
4. Antenna Requirements	14
4.1 Standard Applicable	14
4.2 Antenna Construction and Directional Gain	14
5. Test of AC Power Line Conducted Emission	15
5.1 Test Limit	15
5.2 Test Procedures	15
5.3 Typical Test Setup	16
5.4 Test Result and Data	17
5.5 Test Photographs	19
6. Test of Radiated Spurious Emission	20
6.1 Test Limit	20
6.2 Test Procedures	20
6.3 Typical Test Setup	21
6.4 Test Result and Data (9kHz ~ 30MHz)	22
6.5 Test Result and Data (30MHz ~ 1GHz)	22
6.6 Test Result and Data (1GHz ~ 25GHz)	28
6.7 Test Photographs (30MHz ~ 1GHz)	35
6.8 Test Photographs (1GHz ~ 25GHz)	36
7. Test of Conducted Spurious Emission	38
7.1 Test Limit	38
7.2 Test Procedure	38
7.3 Test Setup Layout	38
7.4 Test Result and Data	38
8. On Time, Duty Cycle and Measurement methods	42
8.1 Test Limit	42
8.2 Test Procedure	42
8.3 Test Setup Layout	42
8.4 Test Result and Data	42
9. 20dB Bandwidth Measurement Data	44
9.1 Test Limit	44
9.2 Test Procedures	44
9.3 Test Setup Layout	44



9.4 Test Result and Data..... 44

10. Frequencies Separation 46

10.1 Test Limit 46

10.2 Test Procedures 46

10.3 Test Setup Layout 46

10.4 Test Result and Data..... 46

11. Dwell Time on each channel 48

11.1 Test Limit 48

11.2 Test Procedures 48

11.3 Test Setup Layout 48

11.4 Test Result and Data..... 48

12. Number of Hopping Channels 51

12.1 Test Limit 51

12.2 Test Procedures 51

12.3 Test Setup Layout 51

12.4 Test Result and Data..... 51

13. Maximum Peak Output Power 53

13.1 Test Limit 53

13.2 Test Procedures 53

13.3 Test Setup Layout 53

13.4 Test Result and Data..... 53

14. Radio Frequency Exposure 54

14.1 Applicable Standards 54

14.2 EUT Specification..... 55

14.3 Results 55



History of this test report

Report No.	Issued Date	Description
22050020-TRFCC01	Aug. 03, 2022	Original
22050020-TRFCC01-A	Aug. 24, 2022	1. 125K & 500K report separately 2. Revise MPE data 3. Revise Model No



1. Summary of Test Procedure and Test Results

1.1 Applicable Standards

ANSI C63.10:2013

FCC Rules and Regulations Part 15 Subpart C §15.247

FCC Rule	Description of Test	Result
15.203	. Antenna Requirement	PASS
15.207	. AC Power Line Conducted Emission	PASS
15.209 15.205	. Radiated Spurious Emission	PASS
15.247(d)	. Conducted Spurious Emission	PASS
15.247(a)(1)	. Channel Carrier Frequencies Separation	PASS
15.247(a)(1)	. 20dB Bandwidth	PASS
15.247(a)(2)	. 6dB Bandwidth	PASS
15.247(a)(1)	. Dwell Time	PASS
15.247(b)	. Number of Hopping Channels	PASS
15.247(e)	. Power Spectral Density	PASS
15.247(b)	. Peak Output Power Measurement Data	PASS
2.1091	. Radio Frequency Exposure	PASS

*The lab has reduced the uncertainty risk factor from test equipment, environment and staff technicians which according to the standard on contract. Therefore, the test result will only be determined by standard requirement.



2. Test Configuration of Equipment under Test

2.1 Feature of Equipment under Test

Operation Frequency Range	902-928MHz
Center Frequency Range	Lora 125K:902.3-914.9MHz
Modulation Type	Hybrid
Modulation Technology	FHSS
Data Rate	125kbps
Antenna Type	Dipole Antenna
Max Antenna Gain	8 dBi
Cable (ipex cable)	Brand: Tengxiang Model: SMAFN8-3B0150-00X-P
Cable (N-Type to ipex)	Brand: TSKY Model: A8-A004-00189
Cable (N-Type to SMA)	Brand: KWANG HWA ELECT MATERIAL CO., LTD. Model: SL-NM-SMF-1M
Antenna 1	Brand: GSC Model: OMA-G01 Antenna Gain:8 dBi
Antenna 2	Brand: GSC Model: OMA-G03A Antenna Gain:5 dBi
Antenna 3	Brand: GSC Model: OMA-G04A Antenna Gain:3 dBi
Antenna 4	Brand: ASUS Model: A8-A003-00108 Antenna Gain:0 dBi
Antenna 5	Brand: Tengxiang Model: AB0915-4602RS-1P5M Antenna Gain: 0.61 dBi

Note: For more details, please refer to the User’s manual of the EUT.



2.2 Carrier Frequency of Channes

Lora 125K

Channel	Frequency (MHz)	Channel	Frequency (MHz)	Channel	Frequency (MHz)
*0	902.3	26	907.5	52	912.7
1	902.5	27	907.7	53	912.9
2	902.7	28	907.9	54	913.1
3	902.9	29	908.1	55	913.3
4	903.1	30	908.3	56	913.5
5	903.3	*31	908.5	57	913.7
6	903.5	32	908.7	58	913.9
7	903.7	33	908.9	59	914.1
8	903.9	34	909.1	60	914.3
9	904.1	35	909.3	61	914.5
10	904.3	36	909.5	62	914.7
11	904.5	37	909.7	*63	914.9
12	904.7	38	909.9	-	-
13	904.9	39	910.1	-	-
14	905.1	40	910.3	-	-
15	905.3	41	910.5	-	-
16	905.5	42	910.7	-	-
17	905.7	43	910.9	-	-
18	905.9	44	911.1	-	-
19	906.1	45	911.3	-	-
20	906.3	46	911.5	-	-
21	906.5	47	911.7	-	-
22	906.7	48	911.9	-	-
23	906.9	49	912.1	-	-
24	907.1	50	912.3	-	-
25	907.3	51	912.5	-	-

Note: Channels remarked * are selected to perform test.



2.3 Test Mode & Test Software

- a. During testing, the interface cables and equipment positions were varied according to ANSI C63.10
- b. The complete test system included Notebook and EUT for RF test.
- c. An executive program, "command" under Windows OS system was executed to transmit and receive data via Lora 125K.
- d. The following test modes were performed for the test:

Conducted Emissions from the AC mains power ports	
Test Mode	Operating Description
1	Lora 125K From Adapter
caused "Test Mode 1" generated the worst case, it was reported as the final data.	
Radiation Emissions (30MHz ~ 1GHz)	
Test Mode	Operating Description
1	Lora 125K From Adapter
caused "Test Mode 1" generated the worst case, it was reported as the final data.	
Radiation Emissions (1GHz ~ 25GHz)	
Test Mode	Operating Description
1	Lora 125K From Adapter
caused "Test Mode 1" generated the worst case, they were reported as the final data.	

Note:

- 1. There are two kinds of test voltage: AC 120V / 60Hz and AC 240V / 60Hz.
 For AC Power Line Conducted Emission, AC 120V / 60Hz is worst case.
 For Radiated Spurious Emission(30MHz ~ 1GHz & 1GHz ~ 25GHz), AC 120V / 60Hz is worst case.



2.4 Description of Test System

RF Conducted				
Equipment	Brand	Model	Length/Type	Power cord/Length/Type
Notebook	lenovo	S1GL2W	N/A	N/A
RJ45 Cable	TE CONNECTIVITY	CAT5E	1.2m / NS	N/A
adapter	Frecom	F18L16-120150SPAU	1m/NS	N/A
Radiated Emissions				
Equipment	Brand	Model	Length/Type	Power cord/Length/Type
Notebook	ASUS	P2430U	N/A	Adapter / 1.8m / NS
RJ45 Cable	TE CONNECTIVITY	CAT5E	1.2m / NS	N/A
adapter	Frecom	F18L16-120150SPAU	1m/NS	N/A
AC Power Line Conducted Emission				
Equipment	Brand	Model	Length/Type	Power cord/Length/Type
Notebook	ASUS	P2430U	N/A	Adapter / 1.8m / NS
RJ45 Cable	TE CONNECTIVITY	CAT5E	1.2m / NS	N/A
adapter	Frecom	F18L16-120150SPAU	1m/NS	N/A

**2.5 General Information of Test**

Test Site	Cerpass Technology Corporation Test Laboratory Address: No.10, Ln. 2, Lianfu St., Luzhu Dist., Taoyuan City 33848, Taiwan (R.O.C.) Tel:+886-3-3226-888 Fax:+886-3-3226-881	
	FCC	TW1439, TW1079
	IC	4934E-1, 4934E-2
	VCCI	T-2205 for Telecommunication test C-4663 for Conducted emission test R-4218 for Radiated emission test G-10812, G-10813 for radiated disturbance above 1GHz
Frequency Range Investigated:	Conducted: from 150kHz to 30 MHz Radiation: from 30 MHz to 40,000MHz	
Test Distance:	The test distance of radiated emission from antenna to EUT is 3 M.	

Test Item	Test Site	Test period	Environmental Conditions	Tested By
RF Conducted	RFCON01-NK	2022/6/8~2022/08/01	23.6~30.8°C / 39~57%	Dian Chen
Radiated Emissions	3M03-NK	2022/07/19~2022/07/20	22~25°C / 42~44%	Dian Chen
AC Power Line Conducted Emission	CON01-NK	2022/07/20	26°C / 60%	Dian Chen



2.6 Measurement Uncertainty

ISO/IEC 17025 requires that an estimate of the measurement uncertainties associated with the emissions test results be included in the report. The measurement uncertainties given below are based on a 95% confidence level (based on a coverage factor (k=2))

Measurement Item	Uncertainty
AC Power Line Conduction(150K~30MHz)	±3.12dB
Radiated Spurious Emission(9KHz~30MHz)	±3.4dB
Radiated Spurious Emission(30MHz~1GHz)	±5.7dB
Radiated Spurious Emission(1GHz~25GHz)	±6.8dB
Conducted Spurious Emission	±1.8dB
6dB Bandwidth	±4.4%
20dB Bandwidth	±4.4%
Occupied Bandwidth	±4.4%
Peak Output Power(Conducted Power Meter)	±1.1dB
Dwell Time / Deactivation Time	±1.2%
Power Spectral Density	±1.8dB
Duty Cycle	±1.2%



3. Test Equipment and Ancillaries Used for Tests

Test Item	Radiated Emissions				
Test Site	Semi Anechoic Room(3M03-NK)				
Bilog Antenna	Sunol	JB1	A020514-2	2022/6/2	2023/6/1
Active Loop Antenna	EMCO	6507	40855	2022/5/25	2023/5/24
Double Ridged Guide Horn Antenna	RF SPAN	DRH18-E	210309A18-ES	2021/11/9	2022/11/8
Horn Antenna	EMCO	3116	31974	2021/10/4	2022/10/3
EMI Receiver	ROHDE & SCHWARZ	ESCI	100821	2021/9/17	2022/9/16
Spectrum Analyzer	ROHDE & SCHWARZ	FSP 40	100219	2021/8/6	2022/8/5
Preamplifier	EM Electronics corp.	EM01G18G	60701	2022/5/12	2023/5/11
Preamplifier	EMC INSTRUMENTS	EMC184045	980065	2021/11/16	2022/11/15
Preamplifier	EM Electronics corp.	EM01M06G	60686	2021/10/28	2022/10/27
Cable-6m(9k~300M)	NA	EMC5D-BM-BM-6	130606	2022/3/21	2023/3/20
Cable-10m(30M-1G)	HUBER SUHNER	RG-214	01126M	2022/4/22	2023/4/21
Cable-4m(30M-1G)	HUBER SUHNER	RG-214	02953M	2022/4/22	2023/4/21
Cable-1m(30M-1G)	HUBER SUHNER	RG-214	01099M	2022/4/22	2023/4/21
Cable-6m(1G-26.5G)	HUBER SUHNER	SUCOFLEX 102	28417/2	2022/3/17	2023/3/16
Cable-0.5m(1G-18G)	EMEC	EM104-SMSM-0.5M	CCE1354	2022/5/26	2023/5/25
Cable-3m(1G-18G)	EMEC	EM104-SMSM-3M	CCE1355	2022/5/26	2023/5/25
Cable-0.5m(1G-40G)	HUBER SUHNER	SUCOFLEX 102	MY4569/2	2021/9/3	2022/9/2
Cable-1m(1G-40G)	HUBER SUHNER	SUCOFLEX 102	MY5739/2	2021/9/3	2022/9/2
Cable-6m(1G-40G)	HUBER SUHNER	SUCOFLEX 102	MY5740/2	2021/9/3	2022/9/2
E3	AUDIX	v8.2014-8-6	RK-000529	NA	NA

Test Item	RF Conducted				
Test Site	RFCON01-NK				
Instrument	Manufacturer	Model No	Serial No	Calibration Date	Valid Date
Spectrum Analyzer	ROHDE & SCHWARZ	FSP 40	100047	2022/03/04	2023/03/03
Attenuator	KEYSIGHT	8491B	MY39250703	2022/04/12	2023/04/11
Cable-0.5m(1G-26.5G)	HUBER SUHNER	SUCOFLEX 102	28422/2	2022/04/09	2023/04/08
Power Meter	Anritsu	ML2495A	1224005	2022/04/12	2023/04/11
Power Sensor	Anritsu	MA2411B	1207295	2022/04/12	2023/04/11
Switch Box	Theda	1-4	TW5451159	NA	NA



Test Item	AC Power Line Conducted Emission				
Test Site	CON01-NK				
Instrument	Manufacturer	Model No	Serial No	Calibration Date	Valid Date
EMI Receiver	ROHDE & SCHWARZ	ESCI	101200	2021/08/30	2022/08/29
Line Impedance Stabilization Network	Schwarzbeck	NSLK 8127	8127-516	2021/10/05	2022/10/04
Pulse Limiter	ROHDE & SCHWARZ	ESH3-Z2	101933	2021/09/15	2022/09/14
Cable-6m(9k~300M)	NA	EMC5D-BM-BM-6	130605	2021/09/22	2022/09/21
E3	AUDIX	v8.2014-8-6	RK-000531	NA	NA



4. Antenna Requirements

4.1 Standard Applicable

For intentional device, according to FCC 47 CFR Section 15.203, an intentional radiator shall be designed to ensure that no antenna other than that furnished by the responsible party shall be used with the device.

And according to FCC 47 CFR Section 15.247 (b), if transmitting antennas of directional gain greater than 6dBi are used, the power shall be reduced by the amount in dB that the directional gain of the antenna exceeds 6dBi.

4.2 Antenna Construction and Directional Gain

Antenna Type		Antenna Gain
Antenna A	Dipole Antenna	8 dBi

Directional gain greater than 6dBi are used, the power limit shall be reduced by 2 dB.



5. Test of AC Power Line Conducted Emission

5.1 Test Limit

Conducted Emissions were measured from 150 kHz to 30 MHz with a bandwidth of 9 KHz, according to the methods defined in ANSI C63.10-2013. The EUT was placed on a nonmetallic stand in a shielded room 0.8 meters above the ground plane. The interface cables and equipment positioning were varied within limits of reasonable applications to determine the position produced maximum conducted emissions.

Frequency (MHz)	Quasi Peak (dB μ V)	Average (dB μ V)
0.15 – 0.5	66-56*	56-46*
0.5 – 5.0	56	46
5.0 – 30.0	60	50

*Decreases with the logarithm of the frequency.

5.2 Test Procedures

- a. The EUT was placed 0.4 meter from the conducting wall of the shielding room was kept at least 80 centimeters from any other grounded conducting surface.
- b. Connect EUT to the power mains through a line impedance stabilization network (LISN).
- c. All the support units are connecting to the other LISN.
- d. The LISN provides 50 ohm coupling impedance for the measuring instrument.
- e. The FCC states that a 50 ohm, 50 micro-Henry LISN should be used.
- f. Both sides of AC line were checked for maximum conducted interference.
- g. The frequency range from 150 kHz to 30 MHz was searched.
- h. Set the test-receiver system to Peak Detect Function and Specified Bandwidth with Maximum Hold Mode.



5.3 Typical Test Setup

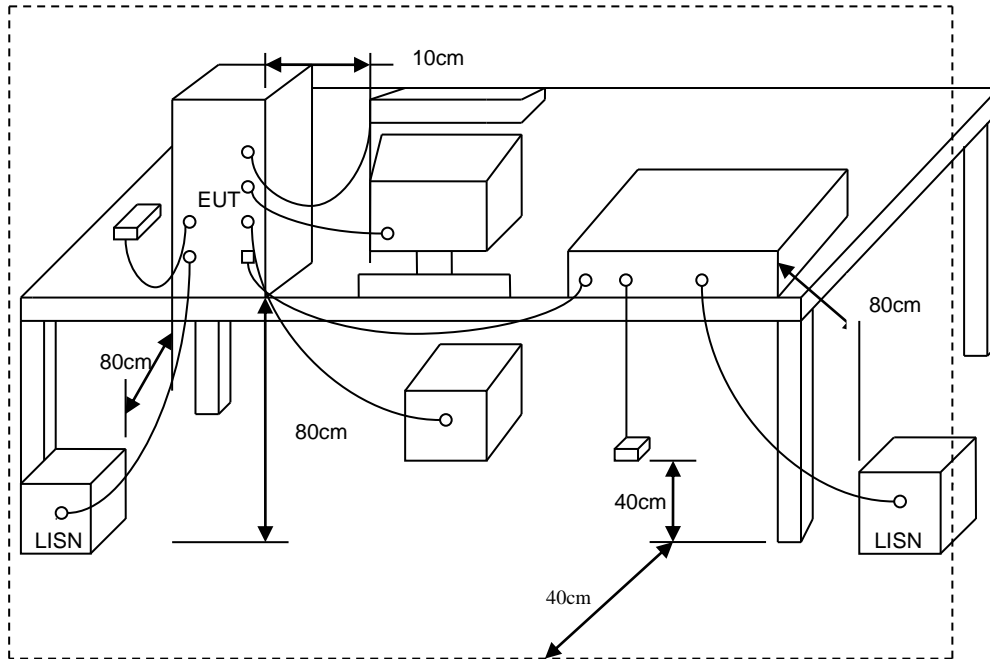



5.4 Test Result and Data

Lora 125K

Power	: AC 120V / 60Hz	Pol/Phase	: LINE
Test Mode	: Mode 1		

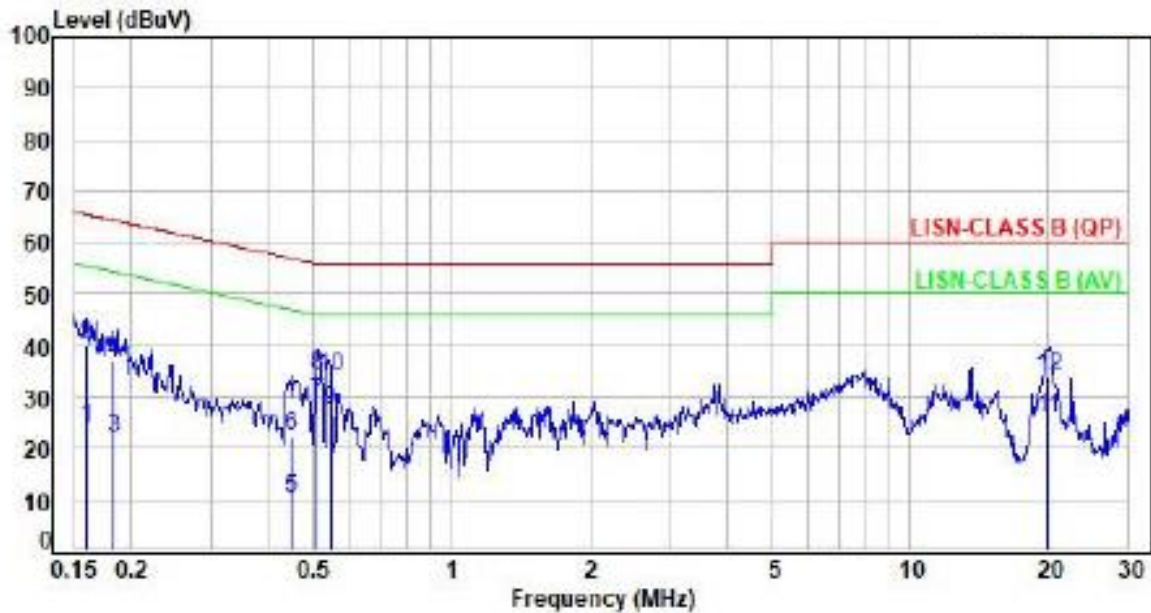

No.	Frequency (MHz)	Factor (dB)	Reading (dBuV)	Level (dBuV)	Limit (dBuV)	Margin (dB)	Detector	P/F
1	0.16	9.96	14.14	24.10	55.49	-31.39	Average	P
2	0.16	9.96	29.94	39.90	65.49	-25.59	QP	P
3	0.18	9.95	12.19	22.14	54.36	-32.22	Average	P
4	0.18	9.95	27.02	36.97	64.36	-27.39	QP	P
5	0.45	9.96	0.46	10.42	46.91	-36.49	Average	P
6	0.45	9.96	12.47	22.43	56.91	-34.48	QP	P
7	0.51	9.97	18.98	28.95	46.00	-17.05	Average	P
8	0.51	9.97	24.34	34.31	56.00	-21.69	QP	P
9	0.54	9.97	17.56	27.53	46.00	-18.47	Average	P
10	0.54	9.97	23.97	33.94	56.00	-22.06	QP	P
11	20.01	10.71	15.12	25.83	50.00	-24.17	Average	P
12	20.01	10.71	23.20	33.91	60.00	-26.09	QP	P

Note: Level=Reading+Factor
Margin=Level-Limit
Factor=(LISM or ISN or Current Probe)Factor + Cable Loss



Lora 125K

Power	: AC 120V / 60Hz	Pol/Phase	: NEUTRAL
Test Mode	: Mode 1		:

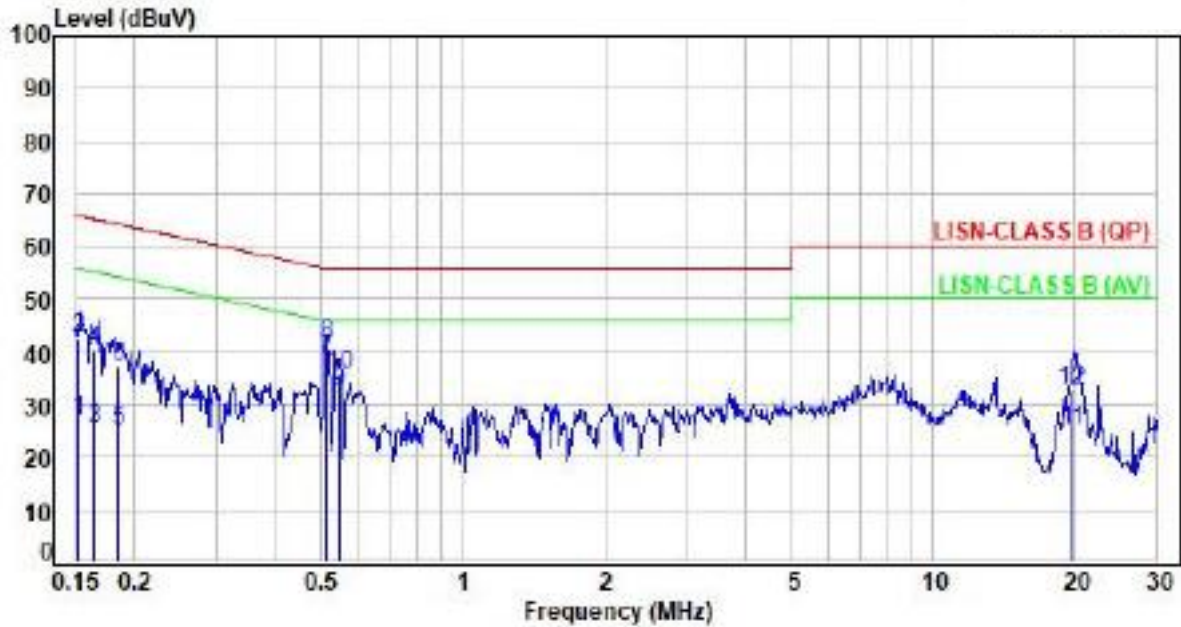

No.	Frequency (MHz)	Factor (dB)	Reading (dBuV)	Level (dBuV)	Limit (dBuV)	Margin (dB)	Detector	P/F
1	0.15	9.94	16.96	26.90	55.92	-29.02	Average	P
2	0.15	9.94	32.68	42.62	65.92	-23.30	QP	P
3	0.16	9.94	15.57	25.51	55.24	-29.73	Average	P
4	0.16	9.94	30.45	40.39	65.24	-24.85	QP	P
5	0.19	9.93	15.32	25.25	54.23	-28.98	Average	P
6	0.19	9.93	27.14	37.07	64.23	-27.16	QP	P
7	0.51	9.94	28.93	38.87	46.00	-7.13	Average	P
8	0.51	9.94	31.63	41.57	56.00	-14.43	QP	P
9	0.54	9.94	22.49	32.43	46.00	-13.57	Average	P
10	0.54	9.94	25.76	35.70	56.00	-20.30	QP	P
11	19.67	10.60	14.55	25.15	50.00	-24.85	Average	P
12	19.67	10.60	21.94	32.54	60.00	-27.46	QP	P

Note: Level=Reading+Factor
Margin=Level-Limit
Factor=(LISN or ISN or Current Probe)Factor + Cable Loss



6. Test of Radiated Spurious Emission

6.1 Test Limit

In any 100kHz bandwidth outside the frequency band in which the spread spectrum or digitally modulated intentional radiator is operating, the radio frequency power that is produced by the intentional radiator shall be at least 20dB below that in the 100kHz bandwidth within the band that contains the highest level of the desired power, based on either an RF conducted or a radiated measurement. If the transmitter measurement is based on the maximum conducted output power, the attenuation required under this paragraph shall be 30dB instead of 20dB. In addition, radiated emissions which fall in section 15.205(a) the restricted bands must also comply with the radiated emission limit specified in section 15.209(a).

Frequency (MHz)	Field Strength (microvolt/meter)	Measurement Distance (meters)
0.009 ~ 0.490	2400/F(kHz)	300
0.490 ~ 1.705	24000/F(kHz)	30
1.705 ~ 30.0	30	30
30 ~ 88	100	3
88 ~ 216	150	3
216 ~ 960	200	3
Above 960	500	3

6.2 Test Procedures

- The EUT was placed on a rotatable table top 0.8 meter above ground.
- The EUT was set 3 meters from the interference receiving antenna which was mounted on the top of a variable height antenna tower.
- The table was rotated 360 degrees to determine the position of the highest radiation.
- The antenna is a broadband antenna and its height is varied between one meter and four meters above ground to find the maximum value of the field strength both horizontal polarization and vertical polarization of the antenna are set to make the measurement.
- For each suspected emission the EUT was arranged to its worst case and then tune the antenna tower (from 1 M to 4 M) and turn table (from 0 degree to 360 degrees) to find the maximum reading.
- Set the test-receiver system to Peak or CISPR quasi-peak Detect Function and specified bandwidth with Maximum Hold Mode.
- If the emission level of the EUT in peak mode was 3 dB lower than the limit specified, then testing will be stopped and peak values of EUT will be reported, otherwise, the emissions which do not have 3 dB margin will be repeated one by one using the quasi-peak method and reported.
- For testing above 1GHz, the emission level of the EUT in peak mode was 20dB lower than average limit (that means the emission level in peak mode also complies with the limit in average mode), then testing will be stopped and peak values of EUT will be reported, otherwise, the emissions will be measured in average mode again and reported.

Note: The supporting fixture shall permit orientation of the EUT in each of three orthogonal axis positions such that emissions from the EUT are maximized.
(Z-AXIS is the worst.)



6.3 Typical Test Setup

Below 30MHz test setup

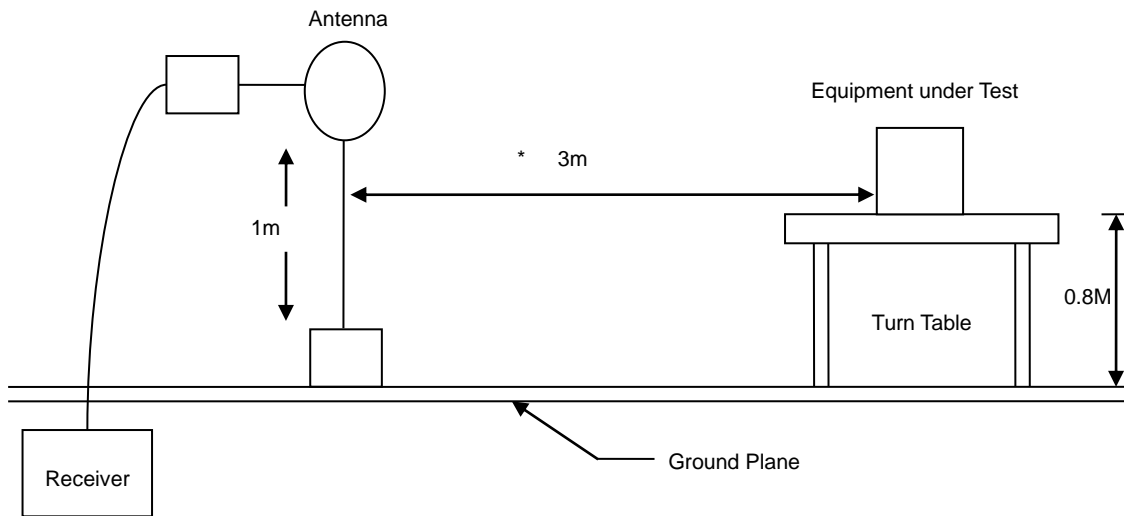

30MHz- 1GHz Test Setup

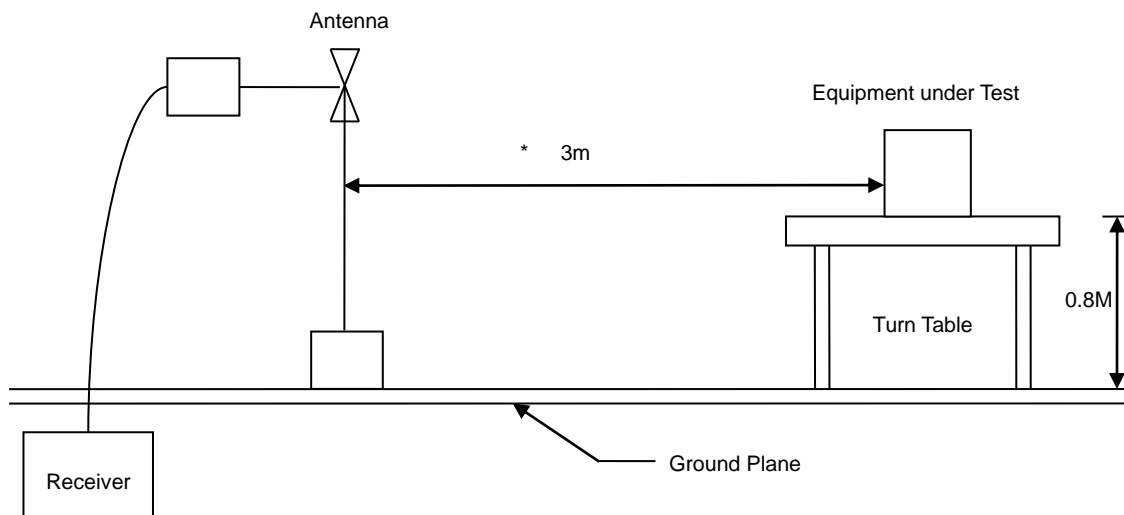

Above 1GHz Test Setup

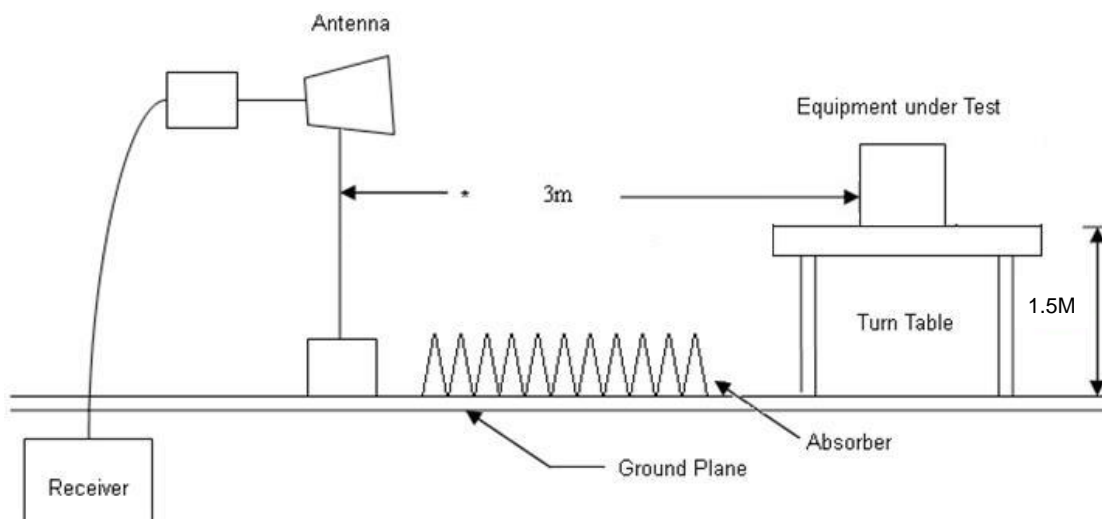



6.4 Test Result and Data (9kHz ~ 30MHz)

The 9kHz-30MHz spurious emission is under limit 20dB more.

6.5 Test Result and Data (30MHz ~ 1GHz)

Lora 125K

Power	: AC 120V / 60Hz	Pol/Phase	: VERTICAL
Test Mode	: Mode 1, CH00 902.3(MHz)		:

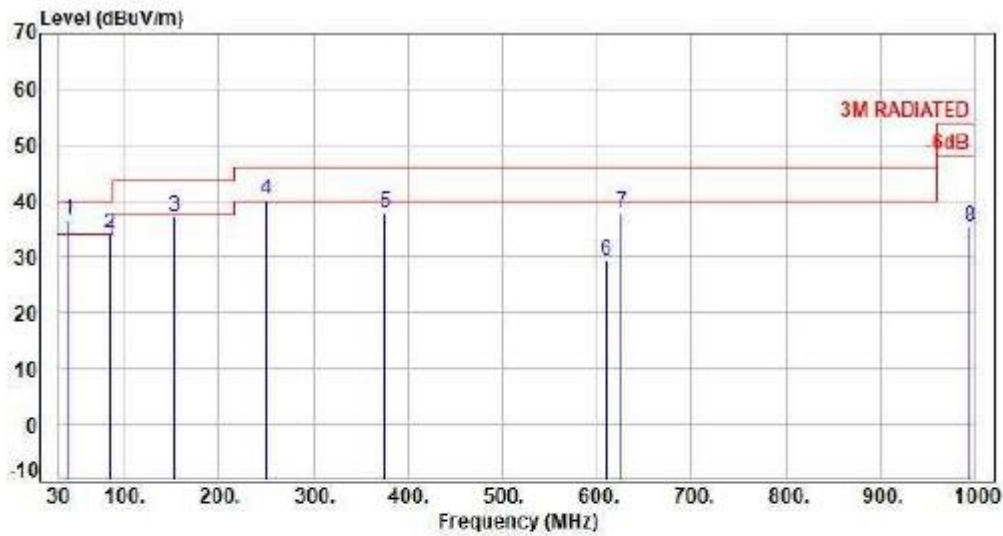

No.	Frequency (MHz)	Factor (dB)	Reading (dBuV)	Level (dBuV/m)	Limit (dBuV/m)	Margin (dB)	Detector	Height (cm)	Azimuth (deg)	P/F
1	41.64	19.92	16.64	36.56	40.00	-3.44	Peak	100	251	P
2	84.32	14.30	19.87	34.17	40.00	-5.83	Peak	400	0	P
3	152.22	20.15	16.85	37.00	43.50	-6.50	Peak	400	0	P
4	249.22	20.01	20.11	40.12	45.00	-5.88	Peak	400	0	P
5	375.32	23.98	13.91	37.89	45.00	-8.11	Peak	400	0	P
6	610.06	28.42	0.97	29.39	45.00	-16.61	Peak	400	0	P
7	625.58	28.97	0.65	37.62	45.00	-8.38	Peak	400	0	P
8	994.18	34.44	0.80	35.24	54.00	-18.76	Peak	400	0	P

Note: Level=Reading+Factor

Margin=Level-Limit

Factor=Antenna Factor + cable loss - Amplifier Factor



Lora 125K

Power	: AC 120V / 60Hz	Pol/Phase	: HORIZONTAL
Test Mode	: Mode 1, CH00 902.3(MHz)		:

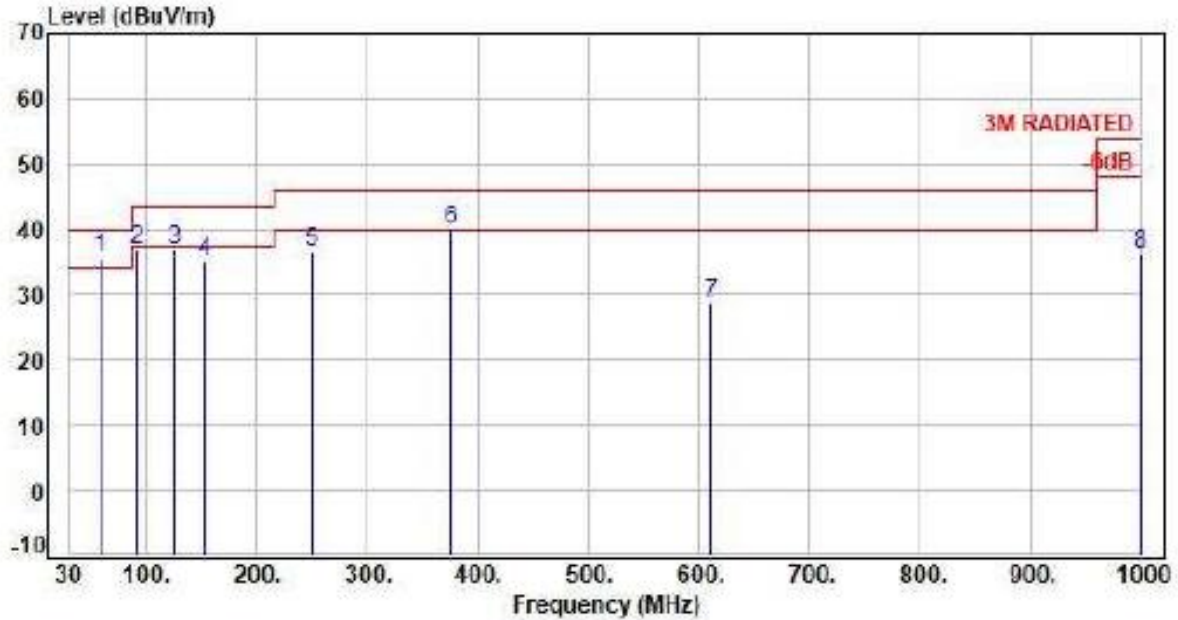

No.	Frequency (MHz)	Factor (dB)	Reading (dBuV)	Level (dBuV/m)	Limit (dBuV/m)	Margin (dB)	Detector	Height (cm)	Azimuth (deg)	P/F
1	59.10	14.83	20.94	35.77	40.00	-4.23	Peak	400	360	P
2	92.08	15.08	21.75	36.83	43.50	-6.67	Peak	400	360	P
3	125.06	21.45	15.35	36.80	43.50	-6.70	Peak	400	360	P
4	152.22	20.15	14.89	35.04	43.50	-8.46	Peak	400	360	P
5	249.22	20.01	16.56	36.57	46.00	-9.43	Peak	400	360	P
6	375.32	23.98	15.83	39.81	46.00	-6.19	Peak	400	360	P
7	612.00	28.50	0.07	28.57	46.00	-17.43	Peak	400	360	P
8	1000.00	34.58	1.57	36.15	54.00	-17.85	Peak	400	360	P

Note: Level=Reading+Factor
 Margin=Level-limit
 Factor=Antenna Factor + cable loss - Amplifier Factor



Lora 125K

Power	: AC 120V / 60Hz	Pol/Phase	: VERTICAL
Test Mode	: Mode 1, CH31 908.5(MHz)		:

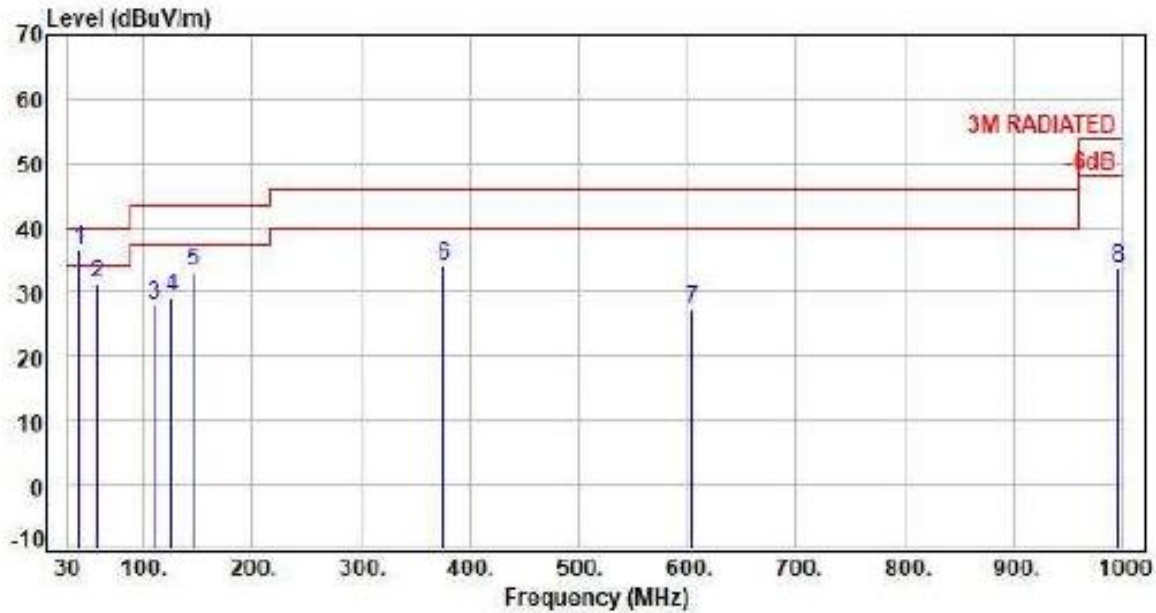

No.	Frequency (MHz)	Factor (dB)	Reading (dBuV)	Level (dBuV/m)	Limit (dBuV/m)	Margin (dB)	Detector	Height (cm)	Azimuth (deg)	P/F
1	41.64	19.92	16.57	36.49	40.00	-3.51	QP	100	249	P
2	57.16	14.60	16.63	31.23	40.00	-8.77	Peak	400	0	P
3	109.54	19.80	8.07	27.87	43.50	-15.63	Peak	400	0	P
4	125.06	21.45	7.83	29.28	43.50	-14.22	Peak	400	0	P
5	146.40	20.45	12.69	33.14	43.50	-10.36	Peak	400	0	P
6	375.32	23.98	10.87	34.85	46.00	-11.95	Peak	400	0	P
7	604.24	28.22	-0.71	27.51	46.00	-18.49	Peak	400	0	P
8	996.12	34.49	-0.78	33.71	54.00	-20.29	Peak	400	0	P

Note: Level=Reading+Factor
 Margin=Level-Limit
 Factor=Antenna Factor + cable loss - Amplifier Factor



Lora 125K

Power	: AC 120V / 60Hz	Pol/Phase	: HORIZONTAL
Test Mode	: Mode 1, CH31 908.5(MHz)		:

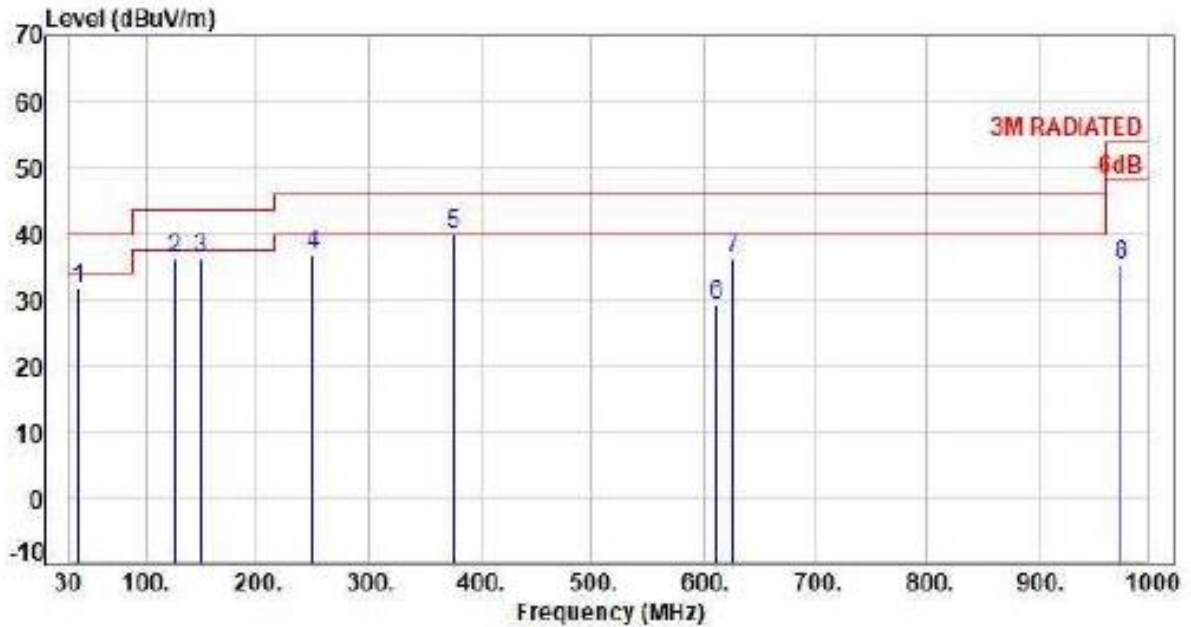

No.	Frequency (MHz)	Factor (dB)	Reading (dBuV)	Level (dBuV/m)	Limit (dBuV/m)	Margin (dB)	Detector	Height (cm)	Azimuth (deg)	P/F
1	39.78	21.44	10.21	31.65	40.00	-8.35	Peak	400	360	P
2	125.06	21.45	14.80	36.25	43.50	-7.25	Peak	400	360	P
3	148.34	20.36	15.87	36.23	43.50	-7.27	Peak	400	360	P
4	249.22	20.01	16.69	36.70	46.00	-9.30	Peak	400	360	P
5	375.32	23.98	15.82	39.80	46.00	-6.20	Peak	400	360	P
6	612.00	28.50	0.67	29.17	46.00	-16.83	Peak	400	360	P
7	625.58	28.97	7.33	36.30	46.00	-9.70	Peak	400	360	P
8	974.78	34.22	1.05	35.27	54.00	-18.73	Peak	400	360	P

Note: Level=Reading+Factor
Margin=Level-Limit
Factor=Antenna Factor + cable loss - Amplifier Factor



Lora 125K

Power	: AC 120V / 60Hz	Pol/Phase	: VERTICAL
Test Mode	: Mode 1, CH63 914.9(MHz)		:

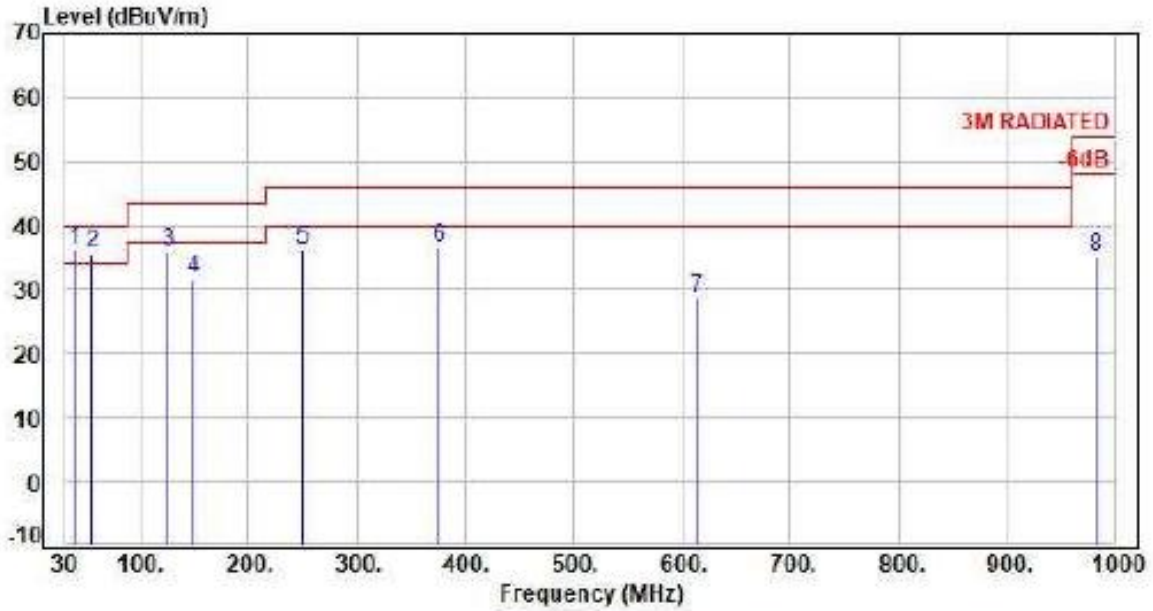

No.	Frequency (MHz)	Factor (dB)	Reading (dBuV)	Level (dBuV/m)	Limit (dBuV/m)	Margin (dB)	Detector	Height (cm)	Azimuth (deg)	P/F
1	39.78	21.44	14.94	36.38	40.00	-3.62	QP	100	253	P
2	55.22	14.23	21.33	35.56	40.00	-4.44	Peak	400	350	P
3	125.06	21.45	14.36	35.81	43.50	-7.69	Peak	400	350	P
4	148.34	20.36	11.44	31.80	43.50	-11.70	Peak	400	350	P
5	249.22	20.01	16.23	36.24	46.00	-9.76	Peak	400	350	P
6	375.32	23.98	12.51	36.49	46.00	-9.51	Peak	400	350	P
7	612.97	28.55	-0.07	28.48	46.00	-17.52	Peak	400	350	P
8	982.54	34.09	0.87	34.96	54.00	-19.04	Peak	400	350	P

Note: Level=Reading+Factor
Margin=Level-Limit
Factor=Antenna Factor + cable loss - Amplifier Factor



Lora 125K

Power	: AC 120V / 60Hz	Pol/Phase	: HORIZONTAL
Test Mode	: Mode 1, CH63 914.9(MHz)		:

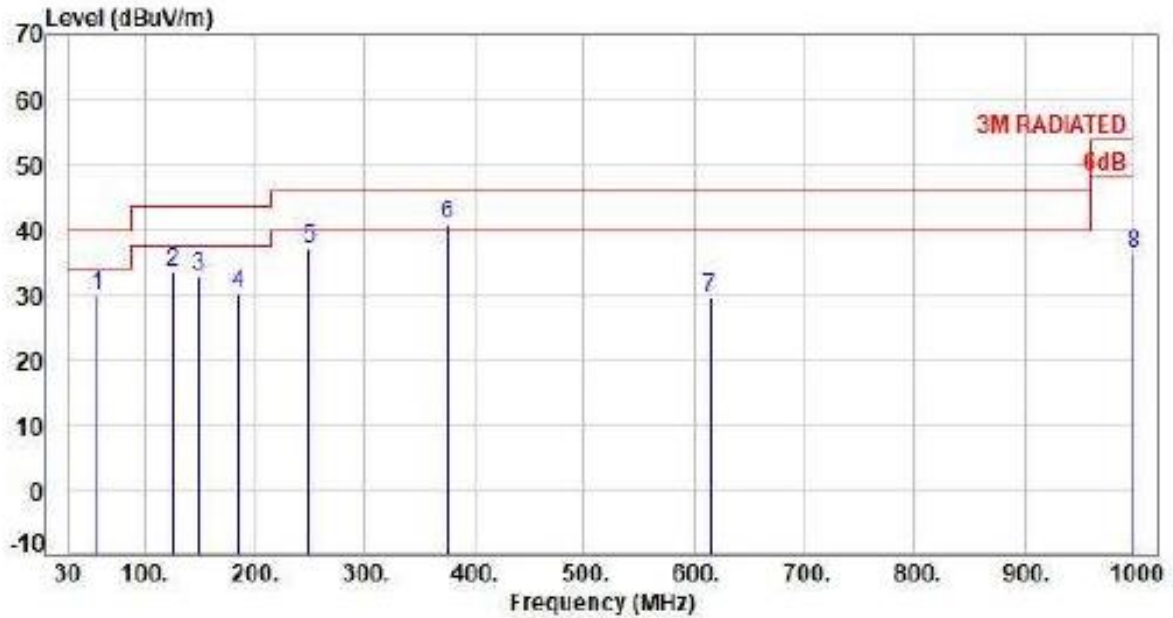

No.	Frequency (MHz)	Factor (dB)	Reading (dBuV)	Level (dBuV/m)	Limit (dBuV/m)	Margin (dB)	Detector	Height (cm)	Azimuth (deg)	P/F
1	57.16	14.60	15.14	29.74	40.00	-10.26	Peak	400	0	P
2	125.06	21.45	12.17	33.62	43.50	-9.88	Peak	400	0	P
3	148.34	20.36	12.47	32.83	43.50	-10.67	Peak	400	0	P
4	185.20	19.13	10.91	30.04	43.50	-13.46	Peak	400	0	P
5	249.22	20.01	17.07	37.08	46.00	-8.92	Peak	400	0	P
6	375.32	23.98	16.96	40.94	46.00	-5.06	Peak	400	0	P
7	613.94	28.59	0.85	29.44	46.00	-16.56	Peak	400	0	P
8	1000.00	34.58	1.77	36.35	54.00	-17.65	Peak	400	0	P

Note: Level=Reading+Factor
Margin=Level-Limit
Factor=Antenna Factor + cable loss - Amplifier Factor



6.6 Test Result and Data (1GHz ~ 25GHz)

Lora 125K

Power	: AC 120V / 60Hz	Pol/Phase	: VERTICAL
Test Mode	: Mode 1, CH00 902.3(MHz)		:

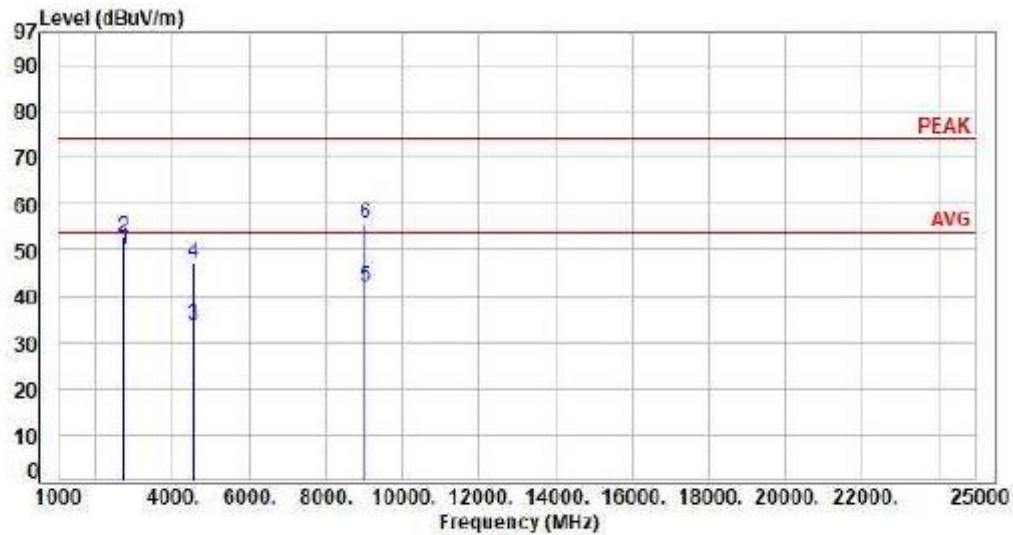

No.	Frequency (MHz)	Factor (dB)	Reading (dBuV)	Level (dBuV/m)	Limit (dBuV/m)	Margin (dB)	Detector	Height (cm)	Azimuth (deg)	P/F
1	2706.90	-28.53	78.56	50.03	54.00	-3.97	Average	247	357	P
2	2706.90	-28.53	81.20	52.67	74.00	-21.33	Peak	247	357	P
3	4511.50	-22.80	56.21	33.41	54.00	-20.59	Average	100	105	P
4	4511.50	-22.80	70.02	47.22	74.00	-26.78	Peak	100	105	P
5	9023.00	-13.76	55.76	42.00	54.00	-12.00	Average	100	264	P
6	9023.00	-13.76	69.46	55.70	74.00	-18.30	Peak	100	264	P

Note: Level=Reading+Factor
Margin=Level-Limit
Factor=Antenna Factor + cable loss - Amplifier Factor



Lora 125K

Power	: AC 120V / 60Hz	Pol/Phase	: HORIZONTAL
Test Mode	: Mode 1, CH00 902.3(MHz)		

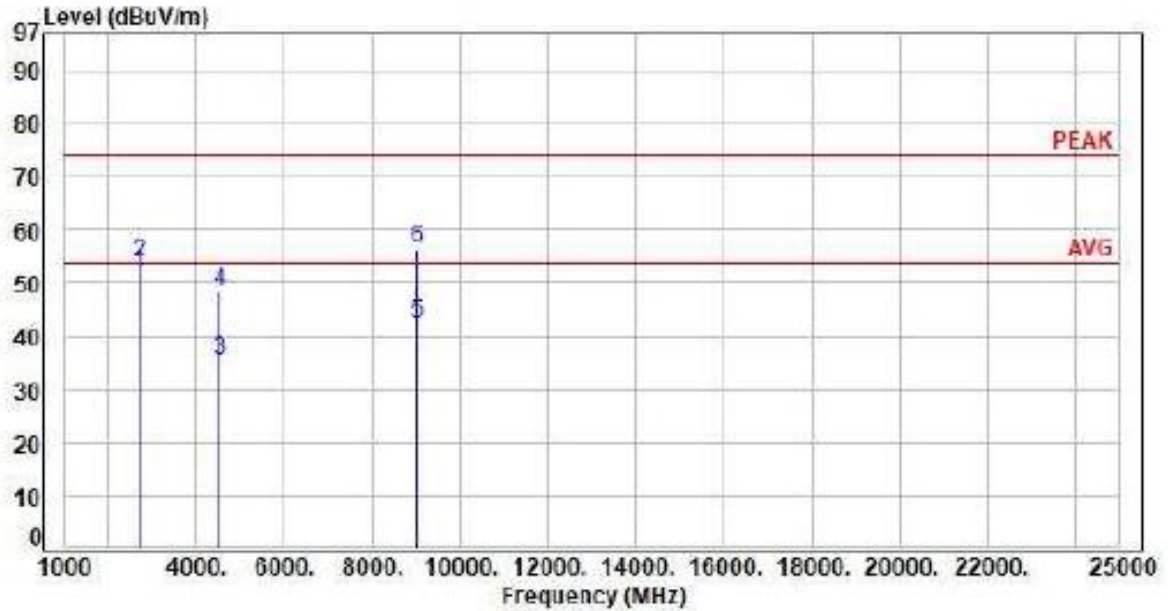

No.	Frequency (MHz)	Factor (dB)	Reading (dBuV)	Level (dBuV/m)	Limit (dBuV/m)	Margin (dB)	Detector	Height (cm)	Arimuth (deg)	P/F
1	2706.90	-28.53	80.52	51.99	54.00	-2.01	Average	121	18	P
2	2706.90	-28.53	82.42	53.89	74.00	-20.11	Peak	121	18	P
3	4511.50	-22.80	58.09	35.29	54.00	-18.71	Average	100	37	P
4	4511.50	-22.80	70.96	48.16	74.00	-25.84	Peak	100	37	P
5	9023.00	-13.76	56.20	42.44	54.00	-11.56	Average	100	185	P
6	9023.00	-13.76	70.27	56.51	74.00	-17.49	Peak	100	185	P

Note: Level=Reading+Factor

Margin=Level-Limit

Factor=Antenna Factor + cable loss - Amplifier Factor



Lora 125K

Power	: AC 120V / 60Hz	Pol/Phase	: VERTICAL
Test Mode	: Mode 1, CH31 908.5(MHz)		:

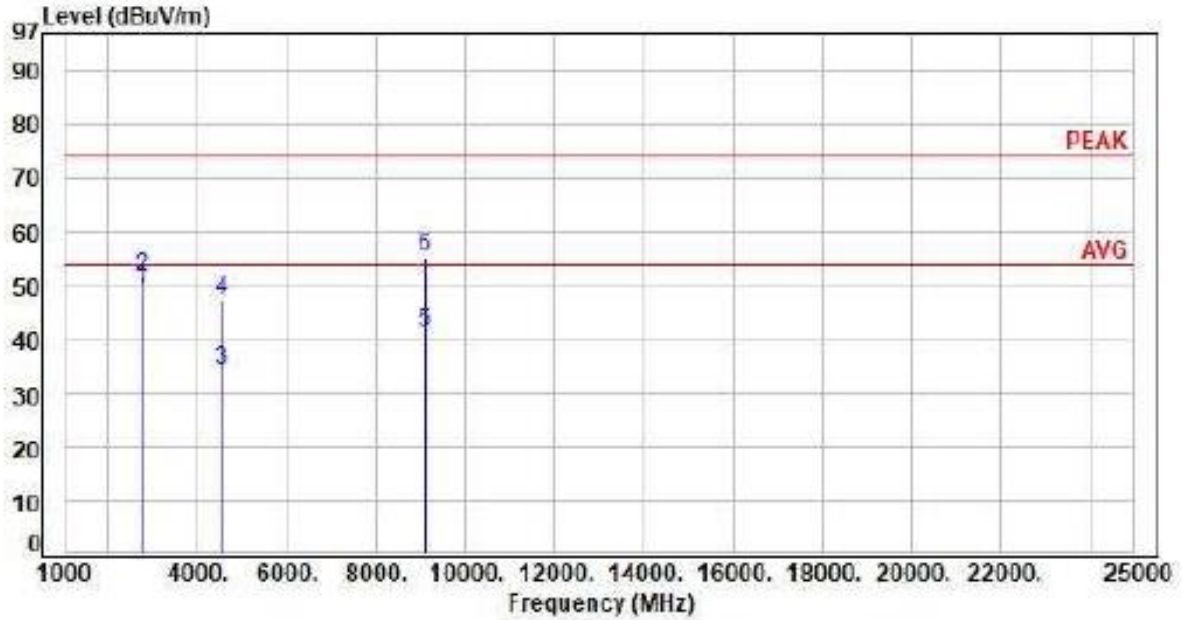

No.	Frequency (MHz)	Factor (dB)	Reading (dBuV)	Level (dBuV/m)	Limit (dBuV/m)	Margin (dB)	Detector	Height (cm)	Azimuth (deg)	P/F
1	2725.50	-28.47	77.81	49.34	54.00	-4.66	Average	238	356	P
2	2725.50	-28.47	79.95	51.48	74.00	-22.52	Peak	238	356	P
3	4542.50	-22.68	56.80	34.12	54.00	-19.88	Average	100	165	P
4	4542.50	-22.68	69.78	47.10	74.00	-26.90	Peak	100	165	P
5	9085.00	-13.53	55.01	41.48	54.00	-12.52	Average	100	268	P
6	9085.00	-13.53	68.88	55.35	74.00	-18.65	Peak	100	268	P

Note: Level-Reading+Factor
Margin=Level-Limit
Factor=Antenna Factor + cable loss - Amplifier Factor



Lora 125K

Power	: AC 120V / 60Hz	Pol/Phase	: HORIZONTAL
Test Mode	: Mode 1, CH31 908.5(MHz)		:

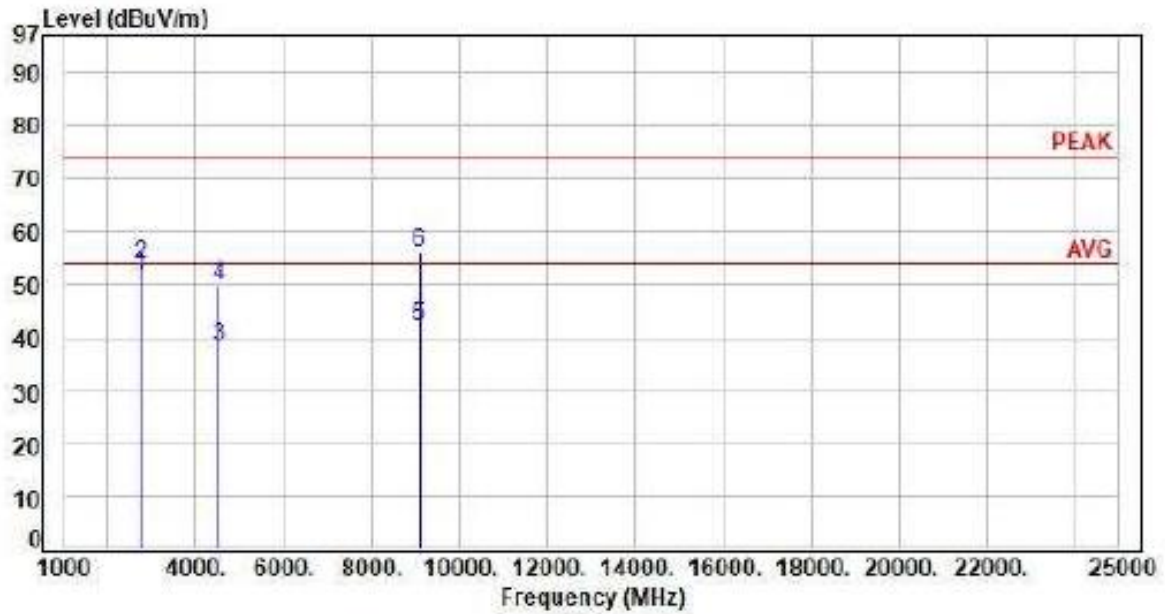

No.	Frequency (MHz)	Factor (dB)	Reading (dBuV)	Level (dBuV/m)	Limit (dBuV/m)	Margin (dB)	Detector	Height (cm)	Azimuth (deg)	P/F
1	2725.50	-28.47	80.21	51.74	54.00	-2.26	Average	152	20	P
2	2725.50	-28.47	82.37	53.90	74.00	-20.10	Peak	152	20	P
3	4542.50	-22.68	61.04	38.36	54.00	-15.64	Average	100	38	P
4	4542.50	-22.68	72.43	49.75	74.00	-24.25	Peak	100	38	P
5	9085.00	-13.53	55.68	42.07	54.00	-11.93	Average	100	164	P
6	9085.00	-13.53	69.68	56.15	74.00	-17.85	Peak	100	164	P

Note: Level=Reading+Factor

Margin=Level-Limit

Factor=Antenna Factor + cable loss - Amplifier Factor



Lora 125K

Power	: AC 120V / 60Hz	Pol/Phase	: VERTICAL
Test Mode	: Mode 1, CH63 914.9(MHz)		:

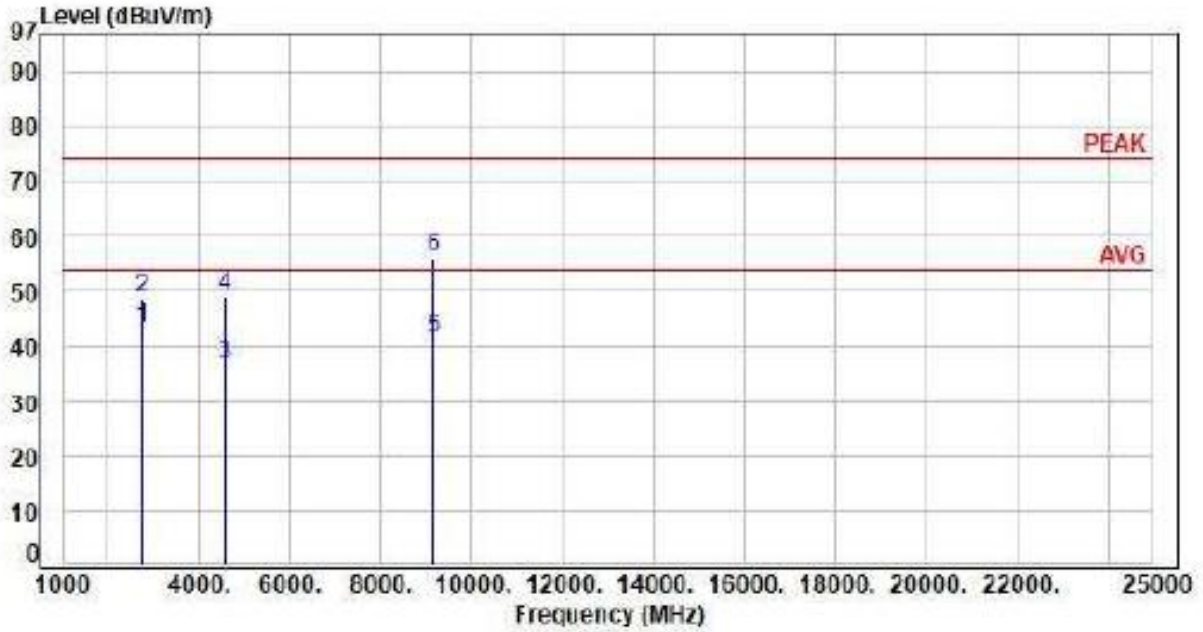

No.	Frequency (MHz)	Factor (dB)	Reading (dBuV)	Level (dBuV/m)	Limit (dBuV/m)	Margin (dB)	Detector	Height (cm)	Azimuth (deg)	P/F
1	2744.78	-28.42	71.42	43.00	54.00	-11.00	Average	242	359	P
2	2744.78	-28.42	76.94	48.52	74.00	-25.48	Peak	242	359	P
3	4574.50	-22.51	59.03	36.52	54.00	-17.48	Average	111	220	P
4	4574.50	-22.51	71.48	48.97	74.00	-25.03	Peak	111	220	P
5	9149.00	-13.49	54.97	41.48	54.00	-12.52	Average	100	166	P
6	9149.00	-13.49	69.47	55.98	74.00	-18.02	Peak	100	166	P

Note: Level=Reading+Factor
Margin=Level-Limit
Factor=Antenna Factor + cable loss - Amplifier Factor



Lora 125K

Power	: AC 120V / 60Hz	Pol/Phase	: HORIZONTAL
Test Mode	: Mode 1, CH63 914.9(MHz)		:

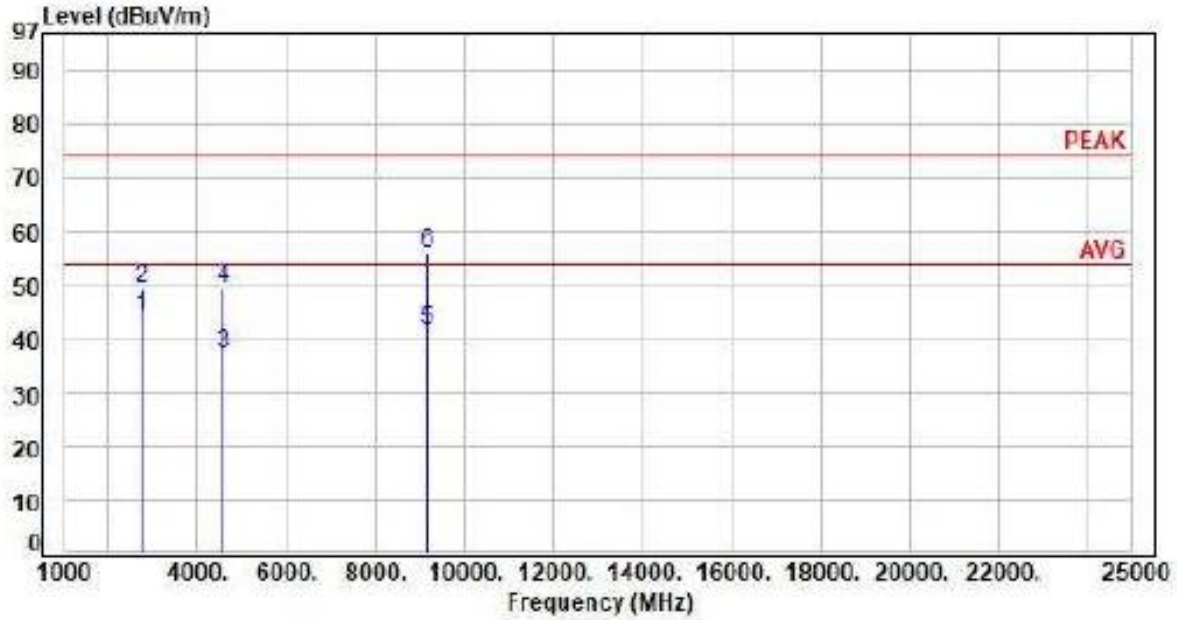

No.	Frequency (MHz)	Factor (dB)	Reading (dBuV)	Level (dBuV/m)	Limit (dBuV/m)	Margin (dB)	Detector	Height (cm)	Azimuth (deg)	P/F
1	2744.70	-28.42	72.60	44.18	54.00	-9.82	Average	143	18	P
2	2744.70	-28.42	77.75	49.33	74.00	-24.67	Peak	143	18	P
3	4574.50	-22.51	59.75	37.24	54.00	-16.76	Average	100	38	P
4	4574.50	-22.51	72.11	49.60	74.00	-24.40	Peak	100	38	P
5	9149.00	-13.49	54.99	41.50	54.00	-12.50	Average	100	265	P
6	9149.00	-13.49	69.53	56.04	74.00	-17.96	Peak	100	265	P

Note: Level=Reading+Factor
Margin=Level-Limit
Factor=Antenna Factor + cable loss - Amplifier Factor



Restricted Bands of Operation

Only spurious emissions are permitted in any of the frequency bands listed below:

MHz	MHz	MHz	GHz
0.09000 – 0.11000	16.42000 – 16.42300	399.9 – 410.0	4.500 – 5.250
0.49500 – 0.505**	16.69475 – 16.69525	608.0 – 614.0	5.350 – 5.460
2.17350 – 2.19050	16.80425 – 16.80475	960.0 – 1240.0	7.250 – 7.750
4.12500 – 4.12800	25.50000 – 25.67000	1300.0 – 1427.0	8.025 – 8.500
4.17725 – 4.17775	37.50000 – 38.25000	1435.0 – 1626.5	9.000 – 9.200
4.20725 – 4.20775	73.00000 – 74.60000	1645.5 – 1646.5	9.300 – 9.500
6.21500 – 6.21800	74.80000 – 75.20000	1660.0 – 1710.0	10.600 – 12.700
6.26775 – 6.26825	108.00000 – 121.94000	1718.8 – 1722.2	13.250 – 13.400
6.31175 – 6.31225	123.00000 – 138.00000	2200.0 – 2300.0	14.470 – 14.500
8.29100 – 8.29400	149.90000 – 150.05000	2310.0 – 2390.0	15.350 – 16.200
8.36200 – 8.36600	156.52475 – 156.52525	2483.5 – 2500.0	17.700 – 21.400
8.37625 – 8.38675	156.70000 – 156.90000	2655.0 – 2900.0	22.010 – 23.120
8.41425 – 8.41475	162.01250 – 167.17000	3260.0 – 3267.0	23.600 – 24.000
12.29000 – 12.29300	167.72000 – 173.20000	3332.0 – 3339.0	31.200 – 31.800
12.51975 – 12.52025	240.00000 – 285.00000	3345.8 – 3358.0	36.430 – 36.500
12.57675 – 12.57725	322.00000 – 335.40000	3600.0 – 4400.0	Above 38.6
13.36000 – 13.41000			

** : Until February 1, 1999, this restricted band shall be 0.490-0.510 MHz



7. Test of Conducted Spurious Emission

7.1 Test Limit

According to the methods defined in ANSI C63.10-2013 Section 11.11.1
Below -20dB of the highest emission level of operating band (in 100kHz Resolution Bandwidth).

7.2 Test Procedure

According to the methods defined in ANSI C63.10-2013 Section 11.11.2 & 11.11.3

- a. The transmitter output was connected to the spectrum analyzer via a low loss cable.
- b. Set both RBW 100KHz and VBW 300 KHz of spectrum analyzer with convenient frequency span including 100 KHz bandwidth from band edge.
- c. The band edges was measured and recorded.

7.3 Test Setup Layout

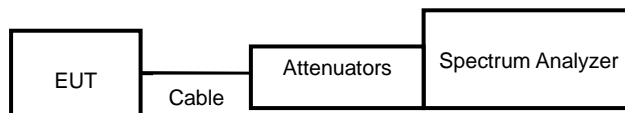

7.4 Test Result and Data

Note: Test plots refer to the following pages.



Modulation Type: Lora 125K
CH00

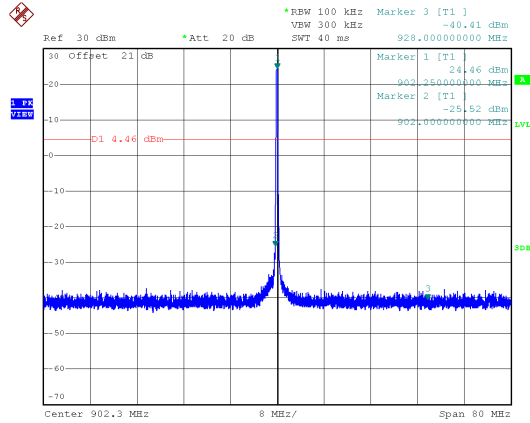

Modulation Type: Lora 125K
CH31

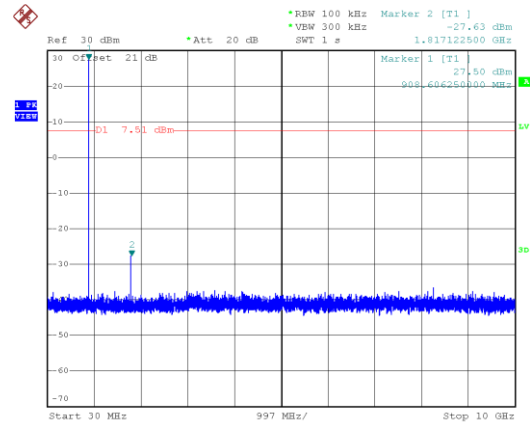
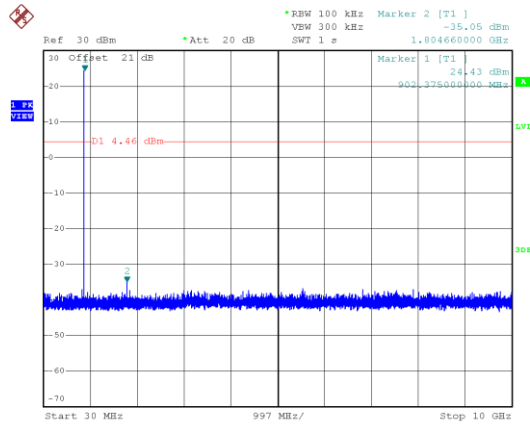
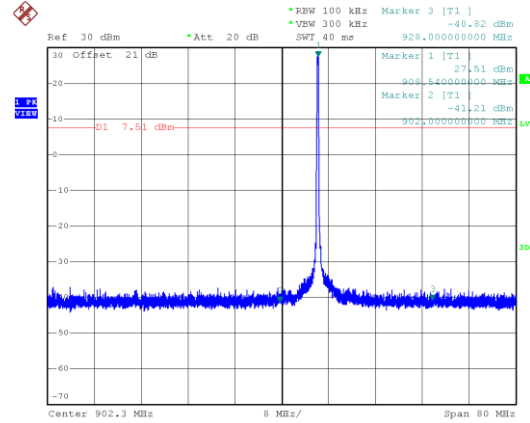



Modulation Type: Lora 125K
CH63

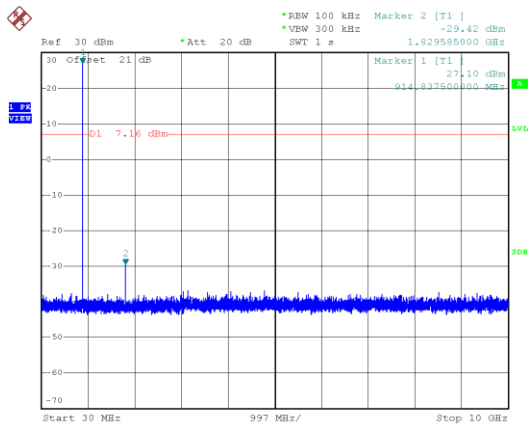
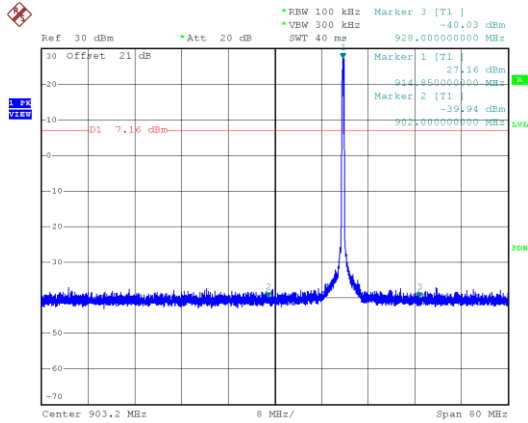



Hopping
Modulation Type: Lora 125K

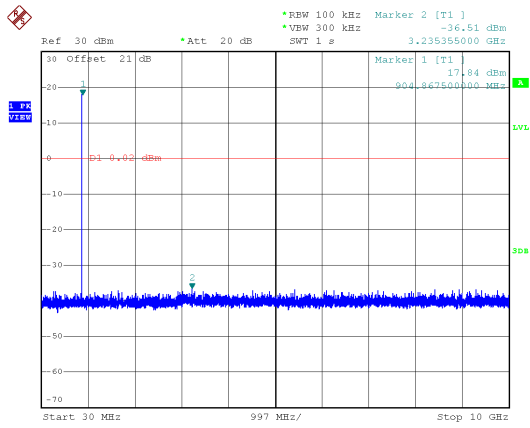
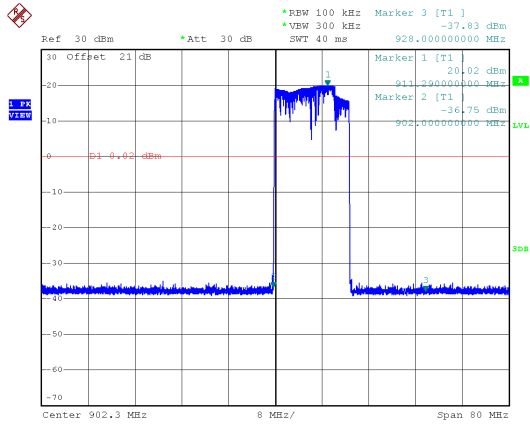



8. On Time, Duty Cycle and Measurement methods

8.1 Test Limit

None; for reporting purposes only.

8.2 Test Procedure

According to the methods defined in ANSI C63.10-2013 Section 11.6 Zero-Span Spectrum Analyzer Method.

8.3 Test Setup Layout

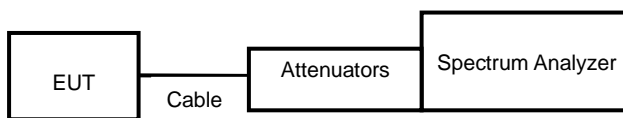

8.4 Test Result and Data

Modulation Mode	On Time (ms)	Period Time (ms)	Duty Cycle (%)
125 KHz	100.00	100.00	100.00%



Modulation Type: Lora 125K

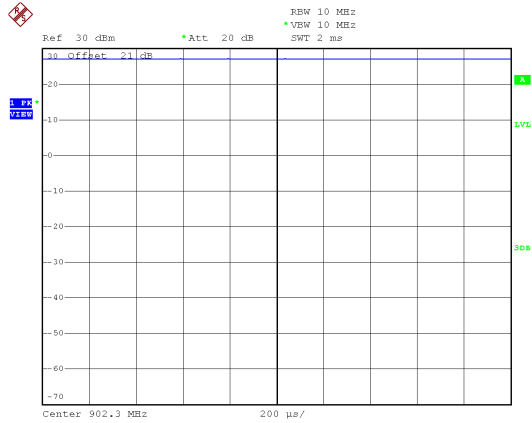



9. 20dB Bandwidth Measurement Data

9.1 Test Limit

The maximum allowed 20 dB bandwidth of the hopping channel is 250 kHz..

9.2 Test Procedures

According to the methods defined in ANSI C63.10-2013 Section 6.9

- a. The transmitter output was connected to the spectrum analyzer.
- b. Set RBW of spectrum analyzer to 10 KHz and VBW to 30 KHz.
- c. The 20 dB bandwidth is defined as the total spectrum the power of which is higher than peak power minus 20 dB.

9.3 Test Setup Layout

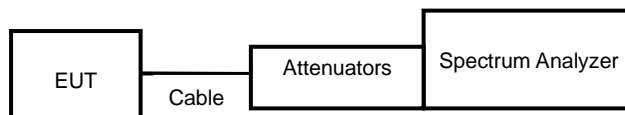

9.4 Test Result and Data

Modulation Type	Channel	Channel Frequency (MHz)	20dB Bandwidth (kHz)	Limit (kHz)
125 KHz	0	902.3	148.000	250
	31	908.5	150.000	250
	63	914.9	148.000	250



Modulation Type: 125K
CH00

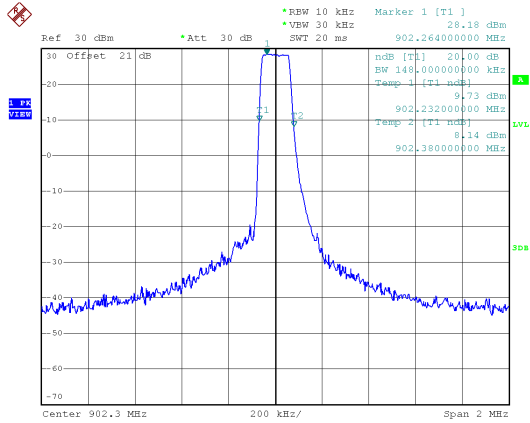

CH31

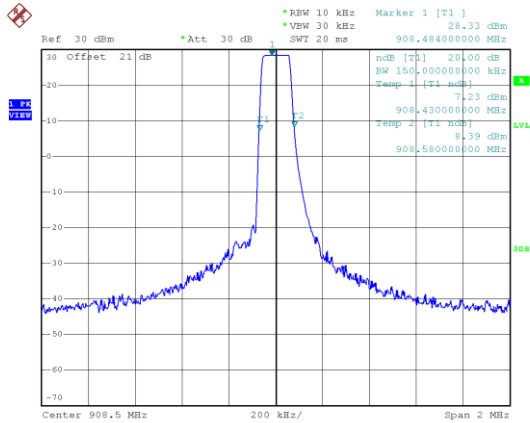

CH63

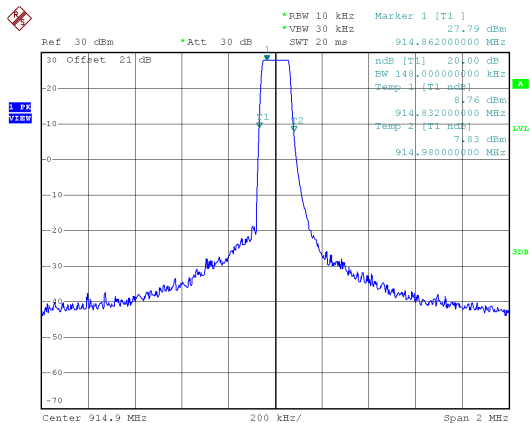



10. Frequencies Separation

10.1 Test Limit

Frequency hopping systems shall have hopping channel carrier frequencies separated by a minimum of 25 kHz or the 20 dB bandwidth of the hopping channel, whichever is greater.

10.2 Test Procedures

According to the methods defined in ANSI C63.10-2013 Section 7.8.2

- a. The transmitter output was connected to the spectrum analyzer.
- b. Set RBW of spectrum analyzer to 30 KHz and VBW to 100 KHz.
- c. By using the MaxHold function record the separation of two adjacent channels.
- d. Measure the frequency difference of these two adjacent channels.

10.3 Test Setup Layout

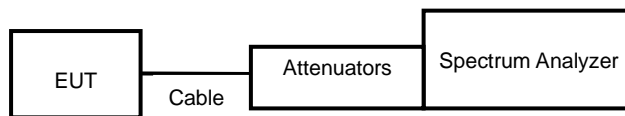

10.4 Test Result and Data

Modulation Type	Channel	Channel Frequency (MHz)	Channel Separation (KHz)	Limit (KHz)
125 KHz	0	902.3	200.00	148
	31	908.5	200.00	150
	63	914.9	200.00	148



Modulation Type: 125K
CH01

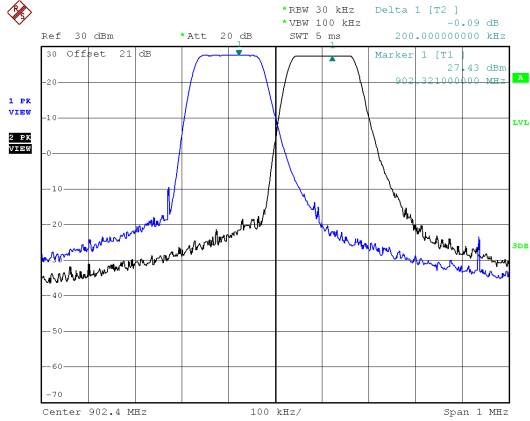

CH31

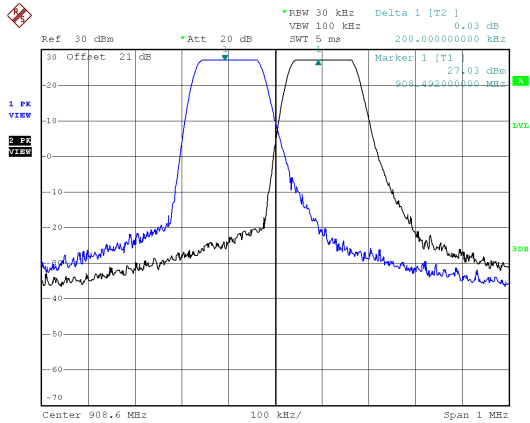

CH63

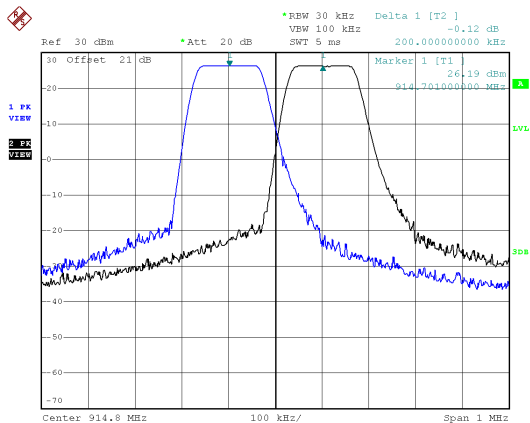



11. Dwell Time on each channel

11.1 Test Limit

For frequency hopping systems operating in the 902-928 MHz band: if the 20 dB bandwidth of the hopping channel is less than 250 kHz, the system shall use at least 50 hopping frequencies and the average time of occupancy on any frequency shall not be greater than 0.4 seconds within a 20 second period; if the 20 dB bandwidth of the hopping channel is 250 kHz or greater, the system shall use at least 25 hopping frequencies and the average time of occupancy on any frequency shall not be greater than 0.4 seconds within a 10 second period. The maximum allowed 20 dB bandwidth of the hopping channel is 500 kHz.

11.2 Test Procedures

According to the methods defined in ANSI C63.10-2013 Section 7.8.4

1. The transmitter output was connected to the spectrum analyzer.
2. Adjust the center frequency to measure frequency, then set zero span mode.
2. Set RBW of spectrum analyzer to 1 MHz and VBW to 3 MHz.
4. Measure the time duration of one transmission on the measured frequency.

11.3 Test Setup Layout

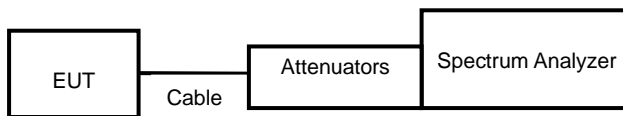

11.4 Test Result and Data

Lora 125K

Channel	Channel Frequency (MHz)	Length of transmission time (ms)	Number of transmission in a 10 sec	Dwell Time (ms)	Limit (ms)
0	902.3	56.800	1.00	56.80	400
31	908.5	56.800	1.00	56.80	400
63	914.9	56.600	1.00	56.60	400

Note:When frequency hops, each channel will be used one time before the next cycle starts.



Modulation Type: 125K
CH00

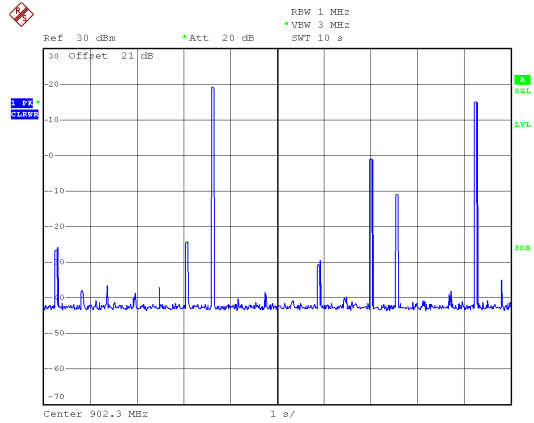

CH31

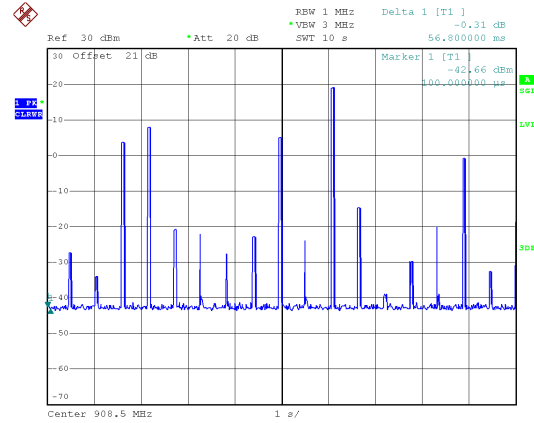

1

CH00

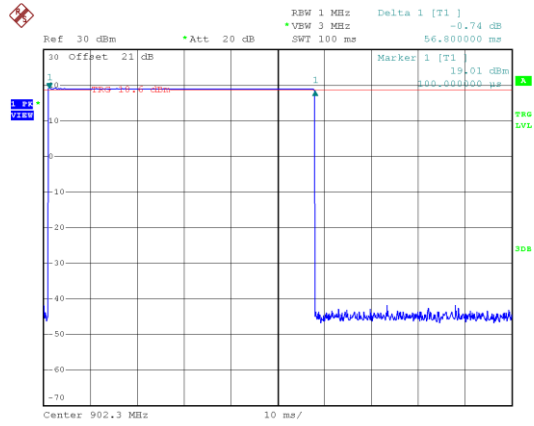

CH31

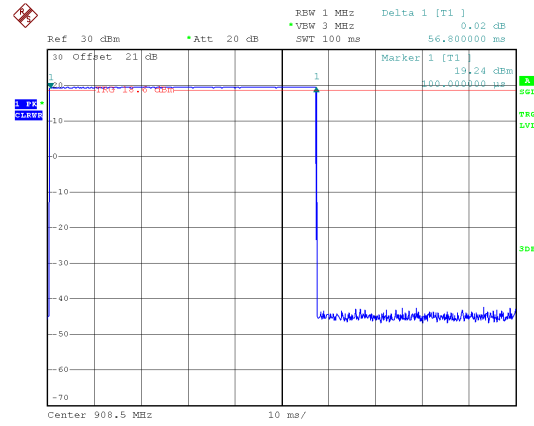



Modulation Type: 125K
CH63

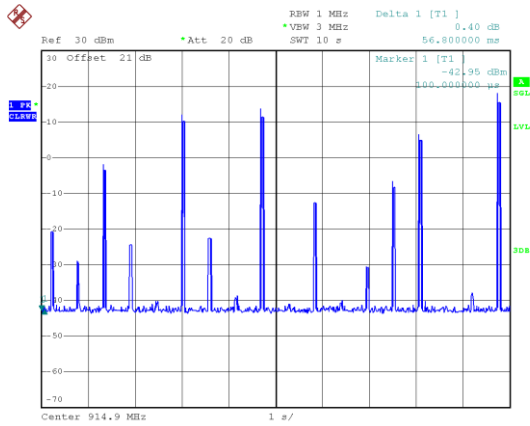

CH63

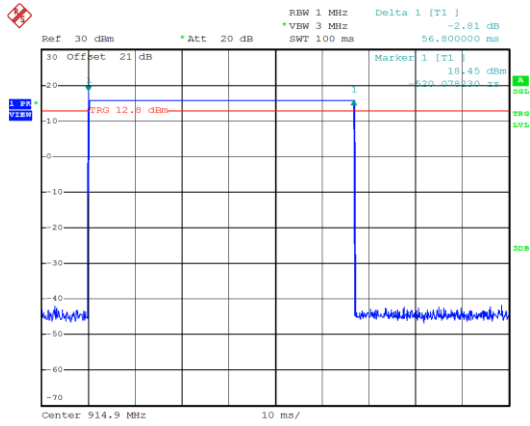



12. Number of Hopping Channels

12.1 Test Limit

Frequency hopping systems in the 902 ~ 928MHz band shall use at least 50 channels.

12.2 Test Procedures

According to the methods defined in ANSI C63.10-2013 Section 7.8.3

- a. The transmitter output was connected to the spectrum analyzer.
- b. 2. Set RBW of spectrum analyzer to 100 KHz and VBW to 300 KHz.
- c. 3. Set the MaxHold function, and then keep the EUT in hopping mode. Record all the signals from each channel until each one has been record.

12.3 Test Setup Layout

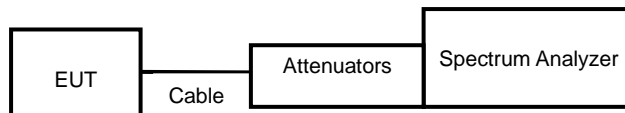

12.4 Test Result and Data

Modulation Type	Hopping Channels	Limit
125 KHz	64	5



Modulation Type: 125K

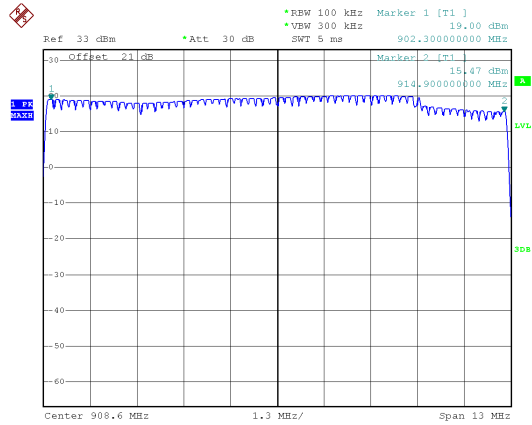



13. Maximum Peak Output Power

13.1 Test Limit

The Maximum Peak Output Power Measurement is 30dBm.

13.2 Test Procedures

According to the methods defined in ANSI C63.10-2013 Section 7.8.5

The antenna port(RF output)of the EUT was connected to the input(RF input)of a power meter.

Power was read directly from the meter and cable loss connection was added to the reading to obtain power at the EUT antenna terminal. The EUT Output Power was set to maximum to produce the worse case test result.

13.3 Test Setup Layout

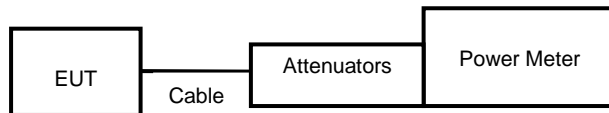

13.4 Test Result and Data

Lora 125K

Modulation Type	Setting	Channel	Channel Frequency (MHz)	PK Output Power (dBm)	PK Output Power (mW)	Powe Limit (dBm)
125K	17	0	902.3	27.53	566.239	28.000
	17	31	908.5	27.54	567.545	28.000
	17	63	914.9	27.16	519.996	28.000

Modulation Type	Setting	Channel	Channel Frequency (MHz)	AV Output Power (dBm)	AV Output Power (mW)	Powe Limit (dBm)
125K	17	0	902.3	27.46	557.186	NA
	17	31	908.5	27.52	564.937	NA
	17	63	914.9	27.12	515.229	NA

Note: Average power is for reference only.