



DFS Test Report

FCC ID: 2AAS9-MI13&IC:26296-MI13

Original Grant

Report No. : TBR-C-202206-0131-142
Applicant : BROWAN COMMUNICATIONS INCORPORATION
Equipment Under Test (EUT)
EUT Name : Wi-Fi 6 AX1800 Dual-Radio In-Wall AP
Model No. : MI13
Series Model No. : N/A
Brand Name : 
Sample ID : 202206-0131-3-1#&202206-0131-3-2#
Receipt Date : 2022-06-24
Test Date : 2022-06-25 to 2022-08-25
Issue Date : 2022-08-26
Standards : 47 CFR FCC Part 15.407
RSS-247 Issue 2 February 2017
Test Method : KDB 905462 D02 UNII DFS Compliance Procedures New Rules v02
Conclusions : **PASS**

In the configuration tested, the EUT complied with the standards specified above.

Test/Witness Engineer : 

Seven Wu

Test/Witness Engineer : 

Ivan Su

Approved & Authorized : 

Ray Lai



This report details the results of the testing carried out on one sample. The results contained in this test report do not relate to other samples of the same product. The manufacturer should ensure that all products in series production are in conformity with the product sample detailed in the report.

Contents

CONTENTS.....	2
1. GENERAL INFORMATION ABOUT EUT	4
1.1. Client Information.....	4
1.2. General Description of EUT (Equipment Under Test)	4
1.3. Test Facility.....	6
2. TEST SOFTWARE.....	7
3. SUPPORT EQUIPMENT.....	7
4. TEST EQUIPMENT.....	7
5. U-NII DFS RULE REQUIREMENTS	8
5.1. Applicability of DFS requirements	8
5.2. Test Limits and Radar Signal Parameters	9
6. CALIBRATION OF RADAR WAVEFORM	14
6.1. Test Procedure.....	14
6.2. Conducted Calibration Test Setup	15
6.3. Deviation from Test Standard	15
6.4. Radar Waveform Calibration Result	15
7. U-NII DFS TESTING.....	16
7.1. Test Procedure.....	16
7.2. Test Setup.....	16
7.3. Channel Loading.....	17
8. TESTING RESULTS.....	18
8.1. Summary of Test Results	18
8.2. DFS Detection Threshold	18
8.3. Radar Waveform Calibration.....	19
8.4. Channel Availability Check Time.....	40
8.5. In-Service(Pd).....	44
8.6. Channel Move Time and Channel Closing Transmission Time	53
8.7. Non-occupancy Period.....	54
8.8. Uniform Spreading.....	55
8.9. U-NII Detection Bandwidth.....	55

Revision History

Report No.	Version	Description	Issued Date
TBR-C-202206-0131-142	Rev.01	Initial issue of report	2022-08-26

1. General Information about EUT

1.1. Client Information

Applicant	:	BROWAN COMMUNICATIONS INCORPORATION
Address	:	No.15-1, Zhonghua Rd., Hsinchu Industrial Park, Hukou Hsinchu Hsien Taiwan 303
Manufacturer	:	Suzhou WINTECH Electronics Technology Co., Ltd
Address	:	Room#301, L2, Build#27, No.568 South Zhongshan Road, Taihu New City Town, Wujiang District, Suzhou City, China

1.2. General Description of EUT (Equipment Under Test)

EUT Name	:	Wi-Fi 6 AX1800 Dual-Radio In-Wall AP
HVIN/Models No.	:	MI13
Model Difference	:	N/A
Operating Frequency Band	:	<input checked="" type="checkbox"/> 5250-5350MHz <input checked="" type="checkbox"/> 5500-5720MHz
TPC	:	<input type="checkbox"/> No <input checked="" type="checkbox"/> Yes
Power Rating	:	POE Input: 56V=0.55A
Software Version	:	1.0.0
Hardware Version	:	V1.0
Note	:	This device was functioned as a <input checked="" type="checkbox"/> Master <input type="checkbox"/> Slave device with radar detection <input type="checkbox"/> Slave device without radar detection

Note:

- (1) For a more detailed features description, please refer to the manufacturer’s specifications or the User’s Manual.
- (2) Antenna information provided by the applicant.

Antenna	Model Name	Type	Antenna Gain (dBi)
ANT. 1	N/A	FPC	U-NII-2A: 5.1312
			U-NII-2C: 3.9670
ANT. 2	N/A	FPC	U-NII-2A: 4.7922
			U-NII-2C: 4.0104

(3) Conducted Output Power&E.I.R.P and PSD

Mode: TX (802.11a)				
Frequency Band (MHz)	Max Conducted Output Power (dBm)	PSD (dBm/MHz)	Max E.I.R.P (dBm)	Max E.I.R.P (mW)
5260~5320	18.74	8.21	23.53	225.42
5500~5700	18.63	8.52	22.64	183.65

Mode: TX (802.11n(HT40))							
Frequency Band (MHz)	Max Cond. Output Power (dBm)		PSD (dBm/MHz)	Max E.I.R.P (dBm)		Max E.I.R.P (mW)	
	Ant.1	Ant.2		Ant.1	Ant.2	Ant.1	Ant.2
5260~5320	18.64	18.65	8.52	23.77	23.44	238.23	220.80
5500~5700	18.29	18.34	8.46	22.26	22.35	168.267	171.791

Mode: TX (802.11ax(HE80))							
Frequency Band (MHz)	Max Cond. Output Power (dBm)		PSD (dBm/MHz)	Max E.I.R.P (dBm)		Max E.I.R.P (mW)	
	Ant.1	Ant.2		Ant.1	Ant.2	Ant.1	Ant.2
5260~5320	18.48	18.45	4.92	23.61	23.24	229.62	210.86
5500~5700	18.09	18.47	4.89	22.06	22.48	160.69	177.01

1.3. Test Facility

The testing report were performed by the Shenzhen Toby Technology Co., Ltd., in their facilities located at 1/F.,Building 6, Rundongsheng Industrial Zone, Longzhu, Xixiang, Bao'an District, Shenzhen, Guangdong, China. At the time of testing, the following bodies accredited the Laboratory:

CNAS (L5813)

The Laboratory has been accredited by CNAS to ISO/IEC 17025: 2017 General Requirements for the Competence of Testing and Calibration Laboratories for the competence in the field of testing. And the Registration No.: CNAS L5813.

A2LA Certificate No.: 4750.01

The laboratory has been accredited by American Association for Laboratory Accreditation(A2LA) to ISO/IEC 17025: 2017 General Requirements for the Competence of Testing and Calibration Laboratories for the technical competence in the field of Electrical Testing. And the A2LA Certificate No.: 4750.01.FCC Accredited Test Site Number: 854351. Designation Number: CN1223.

IC Registration No.: (11950A)

The Laboratory has been registered by Certification and Engineering Bureau of Industry Canada for radio equipment testing. The site registration: Site# 11950A. CAB identifier: CN0056.

2. Test Software

Test Item	Test Software	Manufacturer	Version No.
RF Conducted Measurement	MTS-8310	MWRFTest	V2.0.0.0
RF Test System	JS1120	Tonscend	V2.6.88.0336

3. Support Equipment

Equipment Information				
Name	Model	S/N	Manufacturer	Used “√”
Notebook	T430	----	Thinkpad	√
Notebook	T450s	----	Thinkpad	√
USB wireless adapter	NW392	----	NET-CORE	√

4. Test Equipment

Antenna Conducted Emission					
Equipment	Manufacturer	Model No.	Serial No.	Last Cal.	Cal. Due Date
Spectrum Analyzer	Rohde & Schwarz	FSV40-N	102197	Jun. 23, 2022	Jun. 22, 2023
MXA Signal Analyzer	Agilent	N9020A	MY47380425	Sep. 03, 2021	Sep. 02, 2022
Vector Signal Generator	Agilent	N5182A	MY50141294	Sep. 03, 2021	Sep. 02, 2022
Analog Signal Generator	Agilent	N5181A	MY50141953	Sep. 03, 2021	Sep. 02, 2022
Vector Signal Generator	Agilent	N5182B	MY59101429	Sep. 03, 2021	Sep. 02, 2022
Analog Signal Generator	Agilent	N5181A	MY48180463	Sep. 03, 2021	Sep. 02, 2022
RF Power Sensor	DARE!! Instruments	RadiPowerRPR3006W	17I00015SNO26	Sep. 03, 2021	Sep. 02, 2022
	DARE!! Instruments	RadiPowerRPR3006W	17I00015SNO29	Sep. 03, 2021	Sep. 02, 2022
	DARE!! Instruments	RadiPowerRPR3006W	17I00015SNO31	Sep. 03, 2021	Sep. 02, 2022
	DARE!! Instruments	RadiPowerRPR3006W	17I00015SNO33	Sep. 03, 2021	Sep. 02, 2022
RF Control Unit	Tonsced	JS0806-2	21F8060439	Sep. 03, 2021	Sep. 02, 2022

5. U-NII DFS Rule Requirements

5.1. Applicability of DFS requirements

The manufacturer shall state whether the UUT is capable of operating as a Master and/or a Client. If the UUT is capable of operating in more than one operating mode then each operating mode shall be tested separately. See tables 1 and 2 for the applicability of DFS requirements for each of the operational modes.

Table 3: Applicability of DFS requirements prior to use a channel

Requirement	Operational Mode		
	<input checked="" type="checkbox"/> Master	<input type="checkbox"/> Client without radar detection	<input type="checkbox"/> Client with radar detection
Non-Occupancy Period	✓	Not required	✓
DFS Detection Threshold	✓	Not required	✓
Channel Availability Check Time	✓	Not required	Not required
Uniform Spreading	✓	Not required	Not required
U-NII Detection Bandwidth	✓	Not required	✓

Table 4: Applicability of DFS requirements during normal operation

Requirement	Operational Mode		
	<input checked="" type="checkbox"/> Master	<input type="checkbox"/> Client without radar detection	<input type="checkbox"/> Client with radar detection
DFS Detection Threshold	✓	Not required	✓
Channel Closing Transmission Time	✓	✓	✓
Channel Move Time	✓	✓	✓
U-NII Detection Bandwidth	✓	Not required	✓

Additional requirements for devices with multiple bandwidth modes	<input checked="" type="checkbox"/> Master Device or Client with Radar Detection	<input type="checkbox"/> Client without Detection
Detection Bandwidth and Statistical Performance Check	All BW modes must be tested	Not required
Channel Move Time and Channel Closing Transmission Time	Test using widest BW mode available	Test using widest BW mode available
All other tests	Any single BW mode	Not required
<p>Note: Frequencies selected for statistical performance check (section 7.8.4) should include several frequencies within the radar detection bandwidth and frequencies near the edge of the radar detection bandwidth. For 802.11 devices it is suggested to select frequencies in each of the bonded 20MHz channels and the channel center frequency.</p>		

5.2. Test Limits and Radar Signal Parameters

DETECTION THRESHOLD VALUES

Table 5: DFS Detection Thresholds for Master Devices and Client Devices with Radar Detection.

Maximum Transmit Power	Value (See Notes 1 and 2)
EIRP ≥ 200 milliwatt	-64 dBm
EIRP < 200 milliwatt and Power spectral density < 10 dBm/MHz	-62 dBm
EIRP < 200 milliwatt that do not meet the power spectral density requirement	-64 dBm

Note 1: This is the level at the input of the receiver assuming a 0 dBi receive antenna.

Note 2: Throughout these test procedures an additional 1 dB has been added to the amplitude of the test transmission waveforms to account for variations in measurement equipment. This will ensure that the test signal is at or above the detection threshold level to trigger a DFS response.

Note 3: E.I.R.P is based on the highest antenna gain. For MIMO devices refer to KDB Publication 662911 D01.

Table 6: DFS Response Requirement Values

Parameter	Value
Non-occupancy period	Minimum 30 minutes
Channel Availability Check Time	60 seconds
Channel Move Time	10 seconds See Note 1.
Channel Closing Transmission Time	200 milliseconds + an aggregate of 60 milliseconds over remaining 10 second period. See Notes 1 and 2.
U-NII Detection Bandwidth	Minimum 100% of the UNII 99% transmission power bandwidth. See Note 3.

Note 1: Channel Move Time and the Channel Closing Transmission Time should be performed with Radar Type 0. The measurement timing begins at the end of the Radar Type 0 burst.

Note 2: The Channel Closing Transmission Time is comprised of 200 milliseconds starting at the beginning of the Channel Move Time plus any additional intermittent control signals required to facilitate a Channel move (an aggregate of 60 milliseconds) during the remainder of the 10 second period. The aggregate duration of control signals will not count quiet periods in between transmissions.

Note 3: During the U-NII Detection Bandwidth detection test, radar type 0 should be used. For each frequency step the minimum percentage of detection is 90 percent. Measurements are performed with no data traffic.

PARAMETERS OF DFS TEST SIGNALS

Step intervals of 0.1 microsecond for Pulse Width, 1 microsecond for PRI, 1 MHz for chirp width and 1 for the number of pulses will be utilized for the random determination of specific test waveforms.

Table 7: Short Pulse Radar Test Waveforms.

Radar Type	Pulse Width (μsec)	PRI (μsec)	Number of Pulses	Minimum Percentage of Successful Detection	Minimum Number of Trials
0	1	1428	18	See Note 1	See Note 1
1	1	Test A: 15 unique PRI values randomly selected from the list of 23 PRI values in Table 5a	Roundup $\left\{ \begin{matrix} \frac{1}{360} \\ \frac{19 \cdot 10^6}{PRI_{\mu sec}} \end{matrix} \right\}$	60%	30
		Test B: 15 unique PRI values randomly selected within the range of 518-3066 μsec, with a minimum increment of 1 μsec, excluding PRI values selected in Test A			
2	1-5	150-230	23-29	60%	30
3	6-10	200-500	16-18	60%	30
4	11-20	200-500	12-16	60%	30
Aggregate (Radar Types 1-4)				80%	120
Note 1: Short Pulse Radar Type 0 should be used for the detection bandwidth test, channel move time, and channel closing time tests.					

A minimum of 30 unique waveforms are required for each of the Short Pulse Radar Types 2 through 4. If more than 30 waveforms are used for Short Pulse Radar Types 2 through 4, then each additional waveform must also be unique and not repeated from the previous waveforms. If more than 30 waveforms are used for Short Pulse Radar Type 1, then each additional waveform is generated with Test B and must also be unique and not repeated from the previous waveforms in Tests A or B.

Table 7a: Pulse Repetition Intervals Values for Test A.

Pulse Repetition Frequency Number	Pulse Repetition Frequency (Pulses Per Second)	Pulse Repetition Interval (Microseconds)
1	1930.5	518
2	1858.7	538
3	1792.1	558
4	1730.1	578
5	1672.2	598
6	1618.1	618
7	1567.4	638
8	1519.8	658
9	1474.9	678
10	1432.7	698
11	1392.8	718
12	1355	738
13	1319.3	758
14	1285.3	778
15	1253.1	798
16	1222.5	818
17	1193.3	838
18	1165.6	858
19	1139	878
20	1113.6	898
21	1089.3	918
22	1066.1	938
23	326.2	3066

Table 8: Long Pulse Radar Test Waveform

Radar Type	Pulse Width (μsec)	Chirp Width (MHz)	PRI (μsec)	Number of Pulses per Burst	Number of Bursts	Minimum Percentage of Successful Detection	Minimum Number of Trials
5	50-100	5-20	1000-2000	1-3	8-20	80%	30

The parameters for this waveform are randomly chosen (The center frequency for each of the 30 trials of the Bin 5 radar shall be randomly selected within 80% of the Occupied Bandwidth.) Thirty unique waveforms are required for the Long Pulse Radar Type waveforms. If more than 30 waveforms are used for the Long Pulse Radar Type waveforms, then each additional waveform must also be unique and not repeated from the previous waveforms.

Table 9: Frequency Hopping Radar Test Waveform

Radar Type	Pulse Width (μsec)	Chirp Width (MHz)	PRI (μsec)	Number of Pulses per Burst	Number of Bursts	Minimum Percentage of Successful Detection	Minimum Number of Trials
6	1	333	9	0.333	300	70%	30

6. Calibration of Radar Waveform

6.1. Test Procedure

1. A 50 ohm load is connected in place of the spectrum analyzer, and the spectrum analyzer is connected in place of the master device and the signal generator is set to CW mode. The amplitude of the signal generator is adjusted to yield a level of -62dBm as measured on the spectrum analyzer.
2. Without changing any of the instrument settings, the spectrum analyzer is reconnected to the Common port of the Spectrum Analyzer Combiner/Divider. Measure the amplitude and calculate the difference from -62dBm . Adjust the Reference Level Offset of the spectrum analyzer to this difference.
3. The spectrum analyzer displays the level of the signal generator as received at the antenna ports of the Master Device. The interference detection threshold may be varied from the calibrated value of -62dBm and the spectrum analyzer will still indicate the level as received by the Master Device.
4. Set the signal generator to produce a radar waveform, trigger a burst manually and measure the level on the spectrum analyzer. Readjust the amplitude of the signal generator as required so that the peak level of the waveform is at a displayed level equal to the required or desired interference detection threshold. Separate signal generator amplitude settings are determined as required for each radar type.

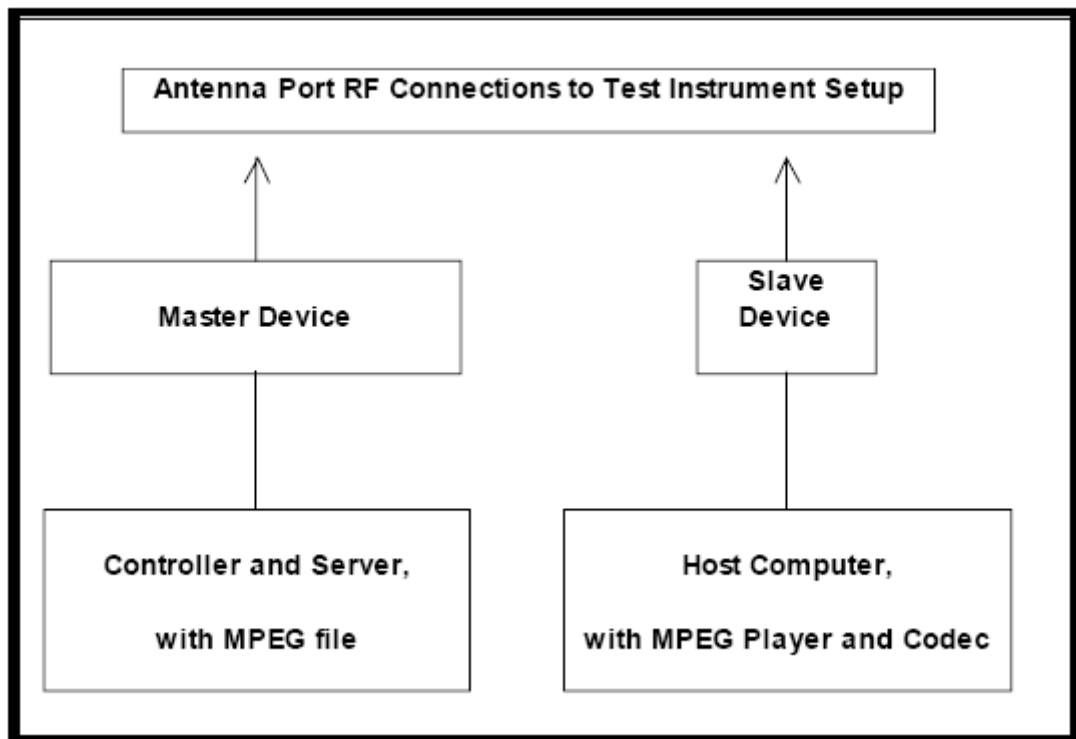

6.2. Conducted Calibration Test Setup

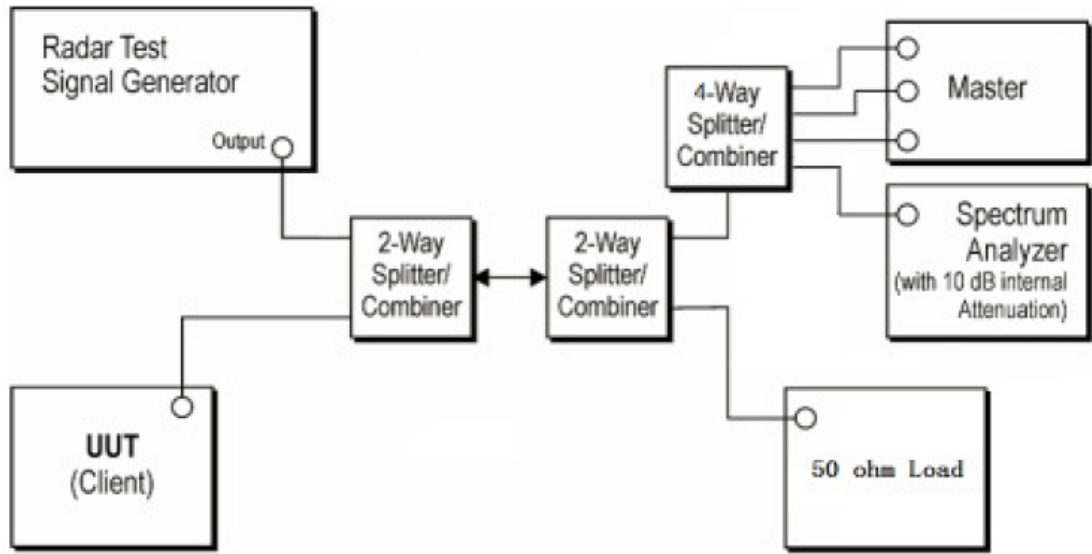

6.3. Deviation from Test Standard

No Deviation

6.4. Radar Waveform Calibration Result

7. U-NII DFS Testing

7.1. Test Procedure

1. Master device and client device are set up by conduction method as the following configuration.
2. The client device is connected to notebook and to access a IP address on wireless connection with the master device.
3. Then the master device is connected to another notebook to access a IP address.
4. Finally, let the two IP addresses run traffic with each other through the Run flow software “Lan test” to reach 17% channel loading as below:

7.2. Test Setup

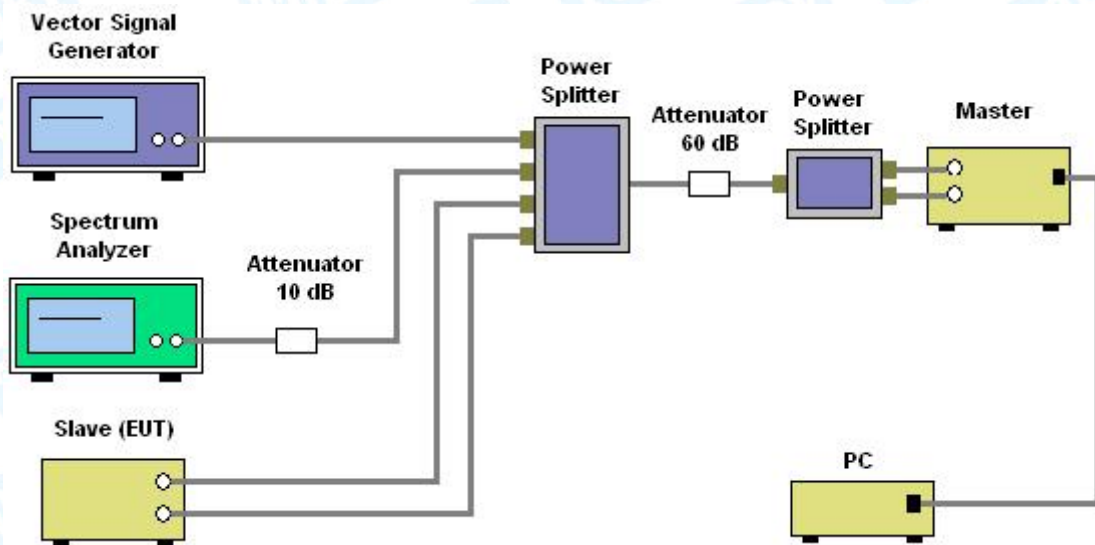

7.3. Channel Loading

Test Mode	Frequency[MHz]	Result	Limit [%]	Verdict
11AX80	5290	19.19	17	PASS
	5530	18.30	17	PASS

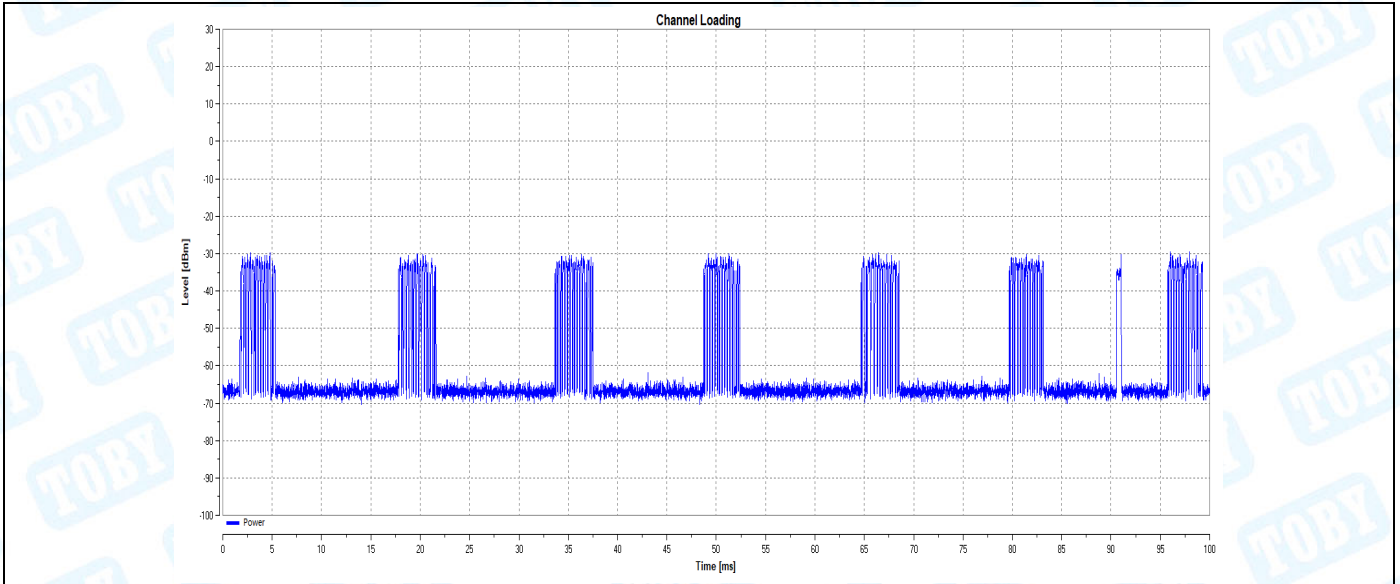

11AX80_5290

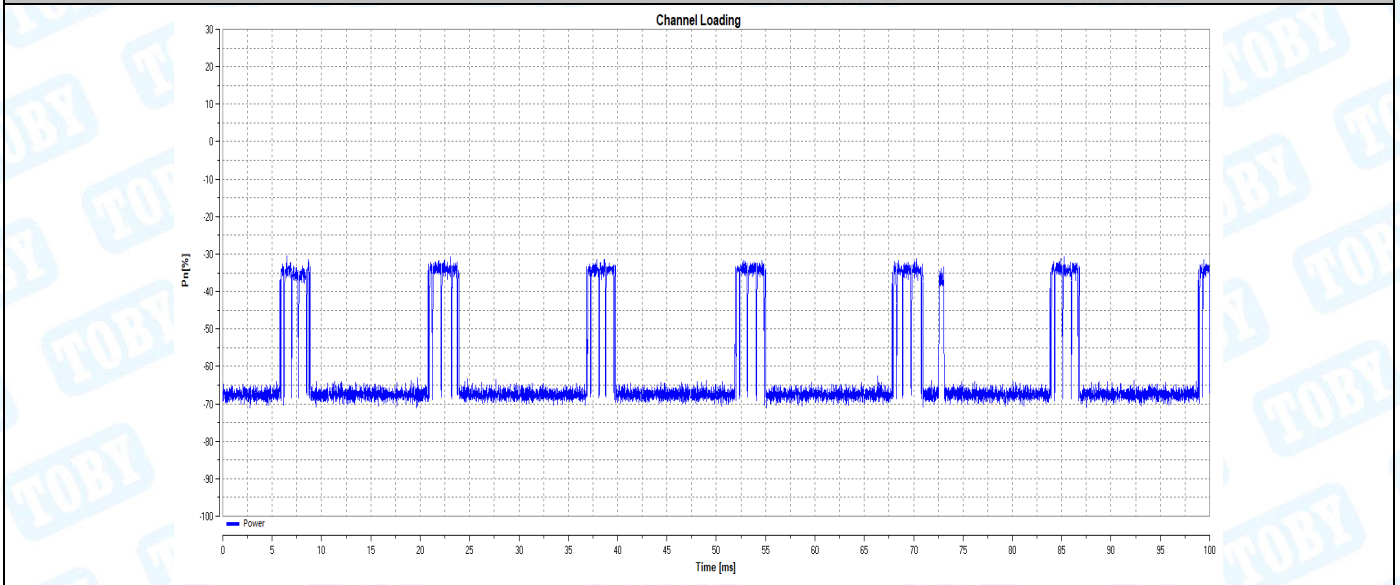

11AX80_5530

8. Testing Results

8.1. Summary of Test Results

Clause	Test Parameter	Remarks	Pass/Fail
15.407	DFS Detection Threshold	Applicable	Pass
15.407	Channel Availability Check Time	Applicable	Pass
15.407	Channel Move Time	Applicable	Pass
15.407	Channel Closing Transmission Time	Applicable	Pass
15.407	Non- Occupancy Period	Applicable	Pass
15.407	Uniform Spreading	Applicable	Pass
15.407	U-NII Detection Bandwidth	Applicable	Pass
Test Mode			
Device operating in master mode.			
Master with injection at the Master. (Radar Test Waveforms are injected into the Master)			

8.2. DFS Detection Threshold

Calibration:

For a detection threshold level of -64dBm and the Master antenna gain is 5.1312dBi, required detection threshold is $-58.87\text{dBm} = (-64 + 5.1312)\text{dBm}$.

To meet the stringent requirement, the DFS test used the detection threshold level of -62dBm.

Note: EIRP > 200 milliwatt in this report, so detection threshold level is -64dBm (please refer to page 5).

8.3. Radar Waveform Calibration

TestMode	Frequency[dbm]	Radar Type	Result	Limit[dbm]	Verdict	
11A	5260	Type0	-62.08	-62.00	PASS	
		Type1	-62.07	-62.00	PASS	
		Type2	-62.32	-62.00	PASS	
		Type3	-62.18	-62.00	PASS	
		Type4	-62.17	-62.00	PASS	
		Type5	-62.37	-62.00	PASS	
	5500	Type6	-62.28	-62.00	PASS	
		Type0	-62.22	-62.00	PASS	
		Type1	-62.40	-62.00	PASS	
		Type2	-62.20	-62.00	PASS	
		Type3	-62.02	-62.00	PASS	
		Type4	-62.40	-62.00	PASS	
	11N40	5270	Type5	-62.04	-62.00	PASS
			Type6	-62.48	-62.00	PASS
Type0			-62.07	-62.00	PASS	
Type1			-62.09	-62.00	PASS	
Type2			-62.10	-62.00	PASS	
Type3			-62.19	-62.00	PASS	
5510		Type4	-62.01	-62.00	PASS	
		Type5	-62.34	-62.00	PASS	
		Type6	-62.06	-62.00	PASS	
		Type0	-62.27	-62.00	PASS	
		Type1	-62.19	-62.00	PASS	
		Type2	-62.30	-62.00	PASS	
11AX80		5290	Type3	-62.18	-62.00	PASS
			Type4	-62.44	-62.00	PASS
	Type5		-62.21	-62.00	PASS	
	Type6		-62.33	-62.00	PASS	
	Type0		-62.03	-62.00	PASS	
	Type1		-62.01	-62.00	PASS	
	5530	Type2	-62.00	-62.00	PASS	
		Type3	-62.32	-62.00	PASS	
		Type4	-62.06	-62.00	PASS	
		Type5	-62.21	-62.00	PASS	
		Type6	-62.19	-62.00	PASS	
		Type0	-62.38	-62.00	PASS	
		Type1	-62.10	-62.00	PASS	
		Type2	-62.23	-62.00	PASS	
Type3		-62.01	-62.00	PASS		
Type4		-62.09	-62.00	PASS		
Type5		-62.39	-62.00	PASS		
Type6		-62.39	-62.00	PASS		

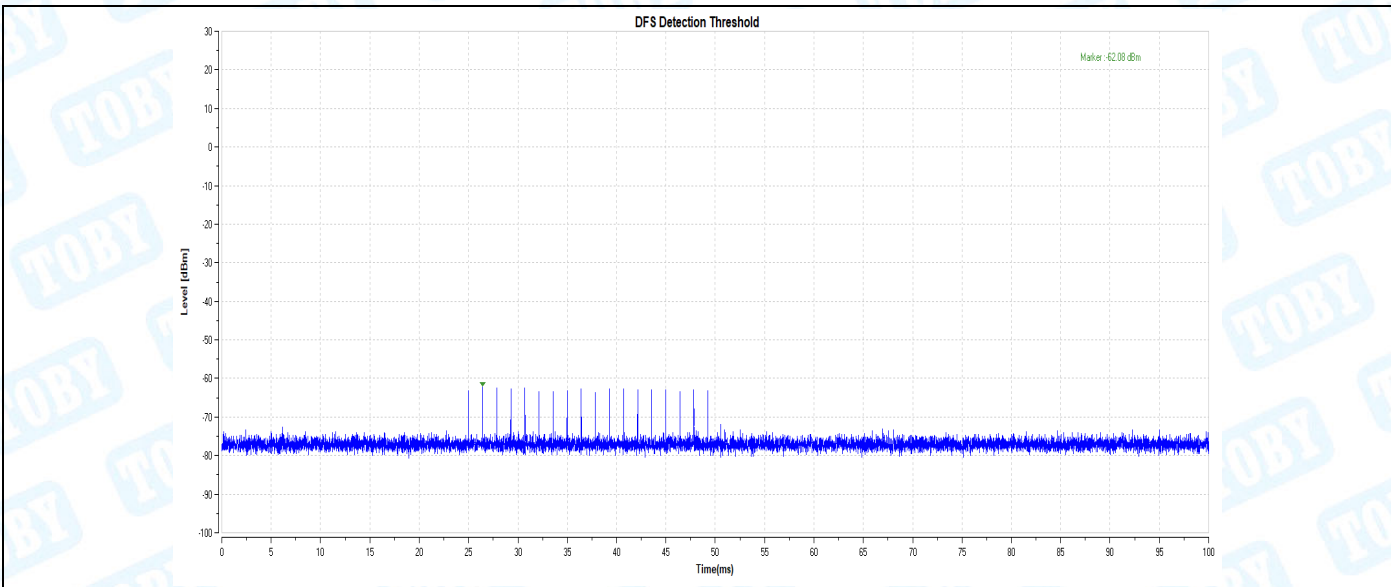

11A_5260_Type0

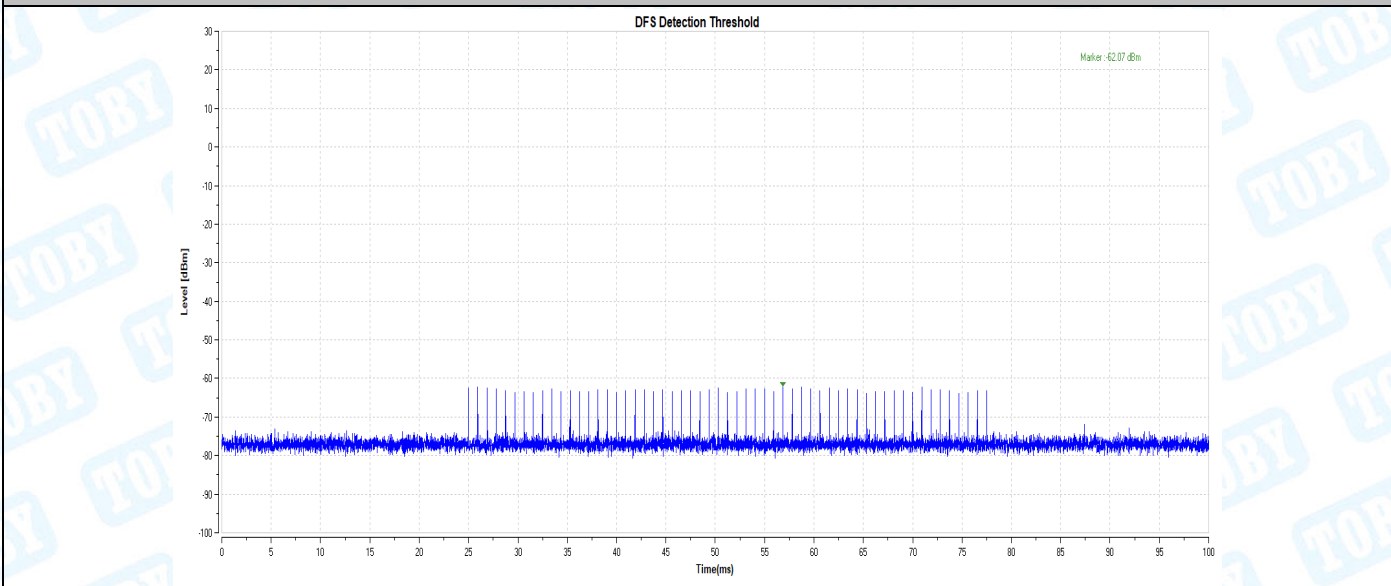

11A_5260_Type1

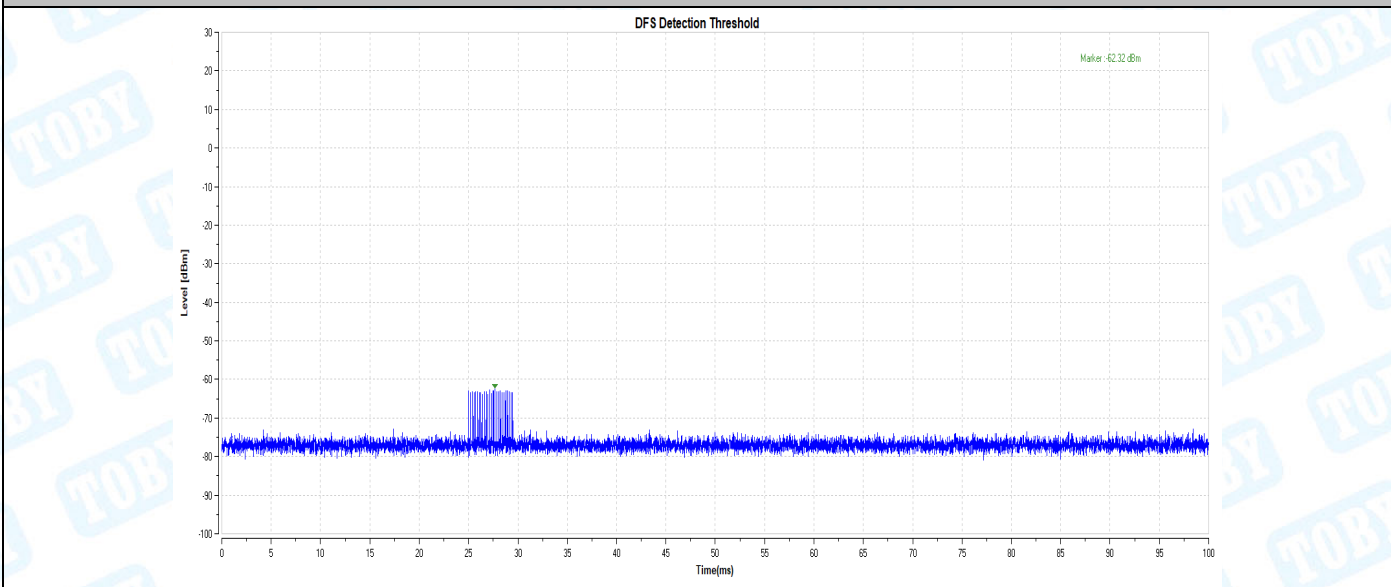

11A_5260_Type2

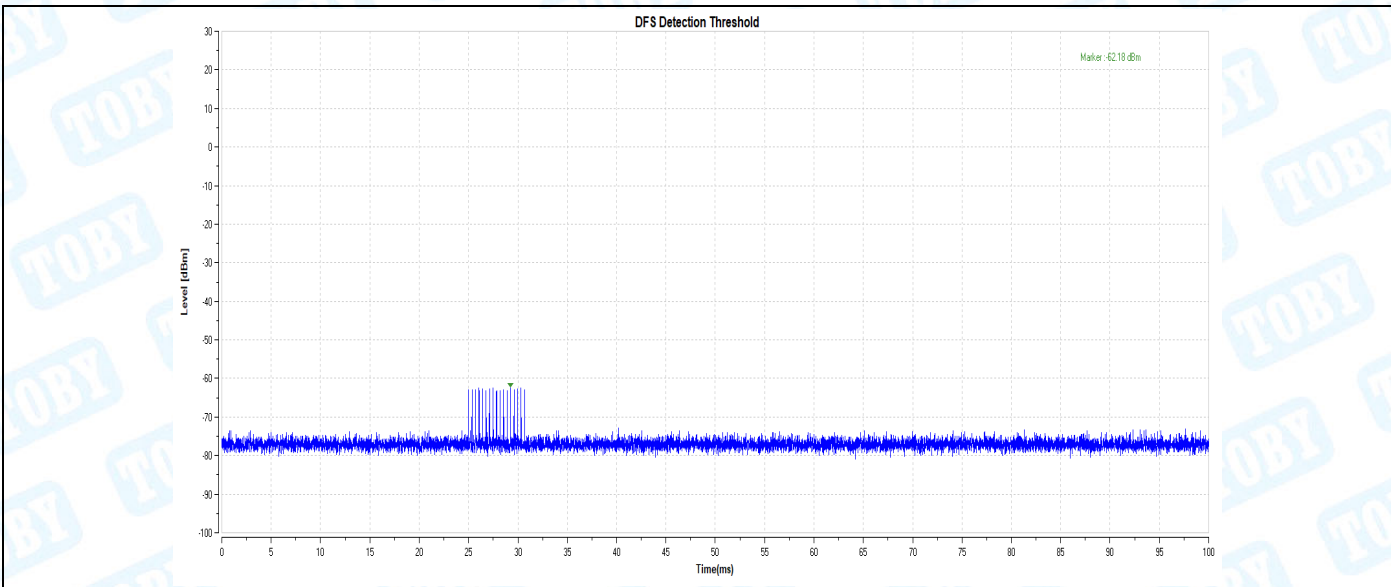

11A_5260_Type3

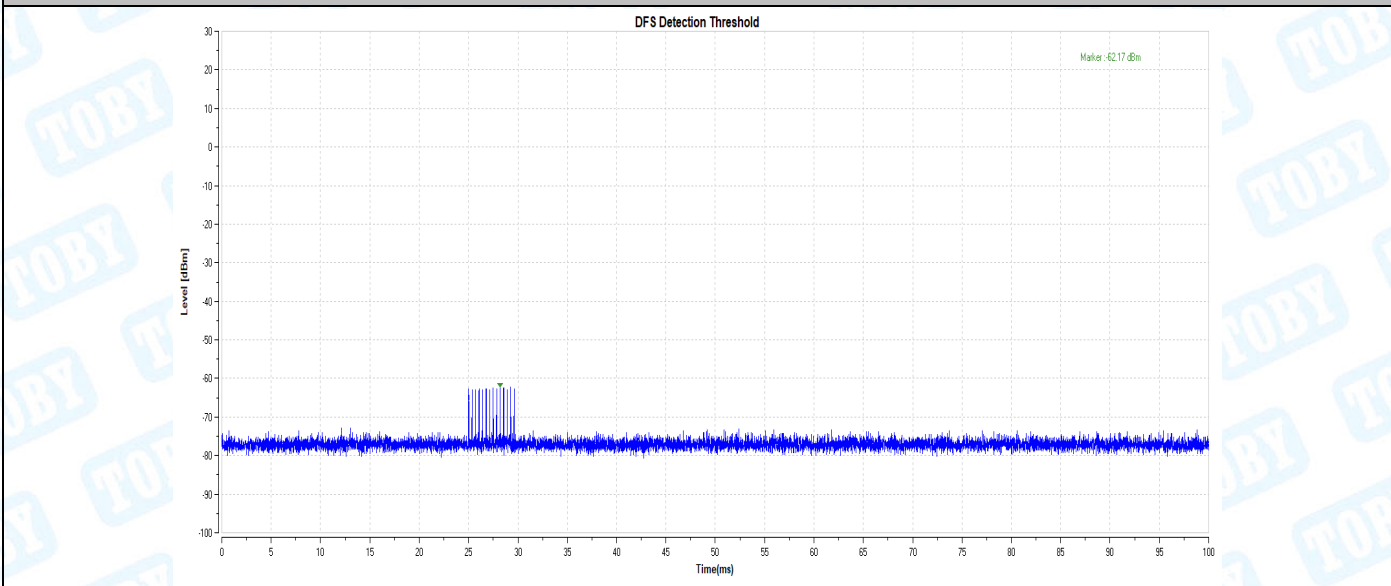

11A_5260_Type4

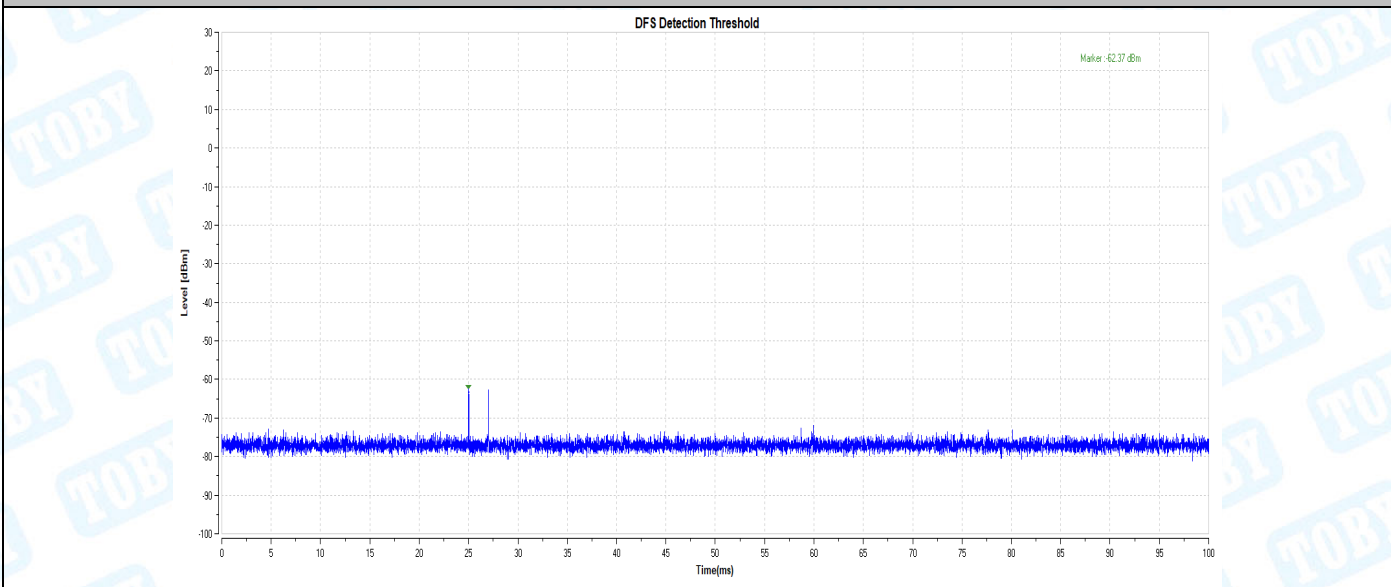

11A_5260_Type5

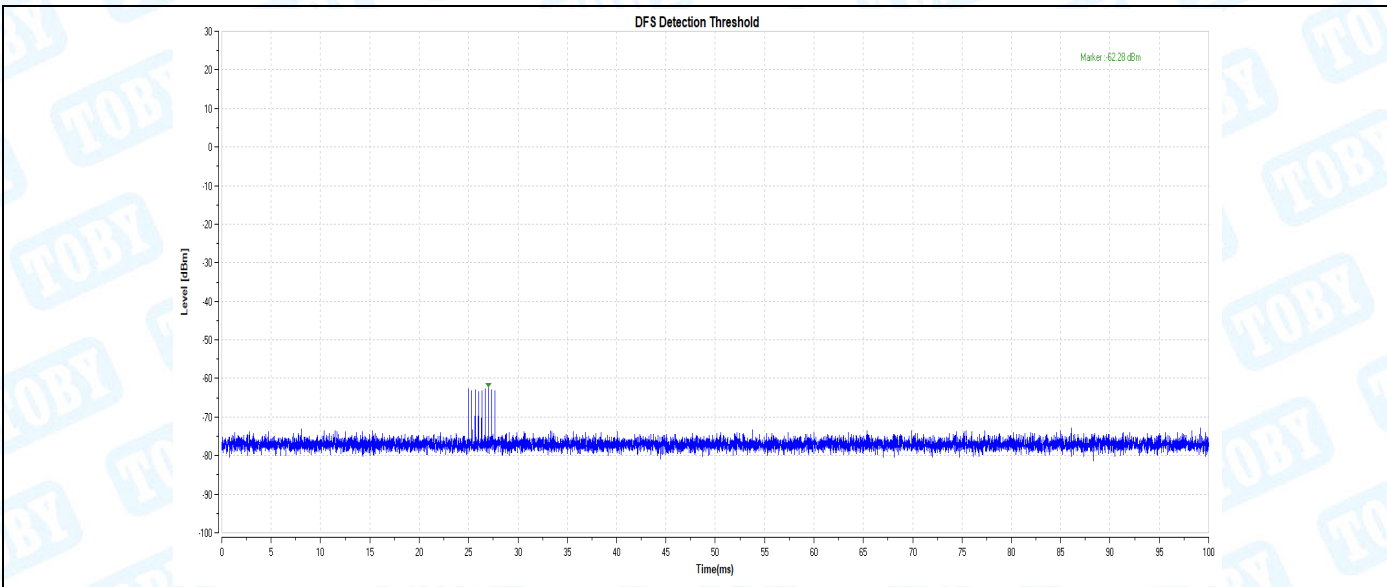

11A_5260_Type6

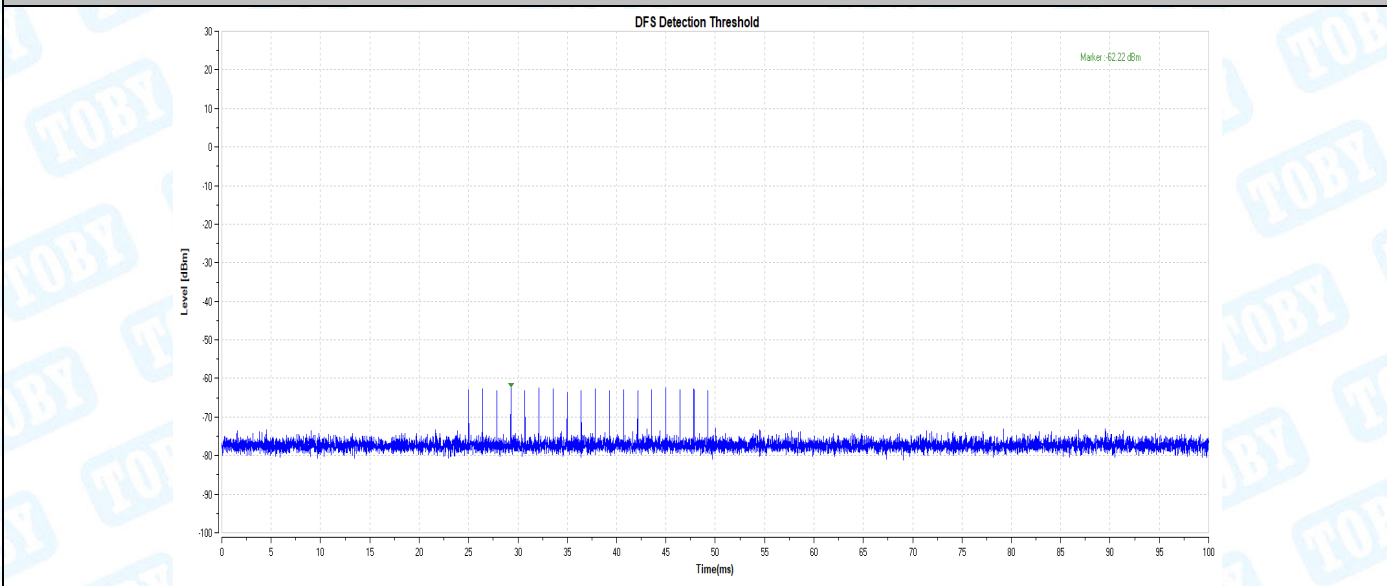

11A_5500_Type0

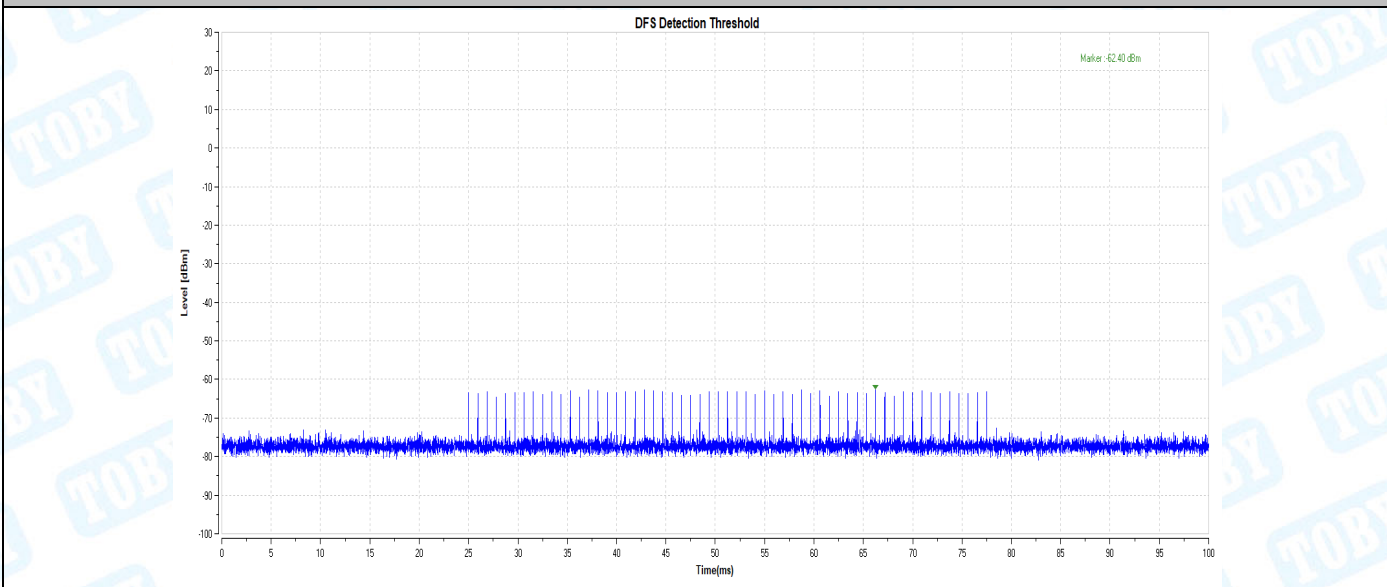

11A_5500_Type1

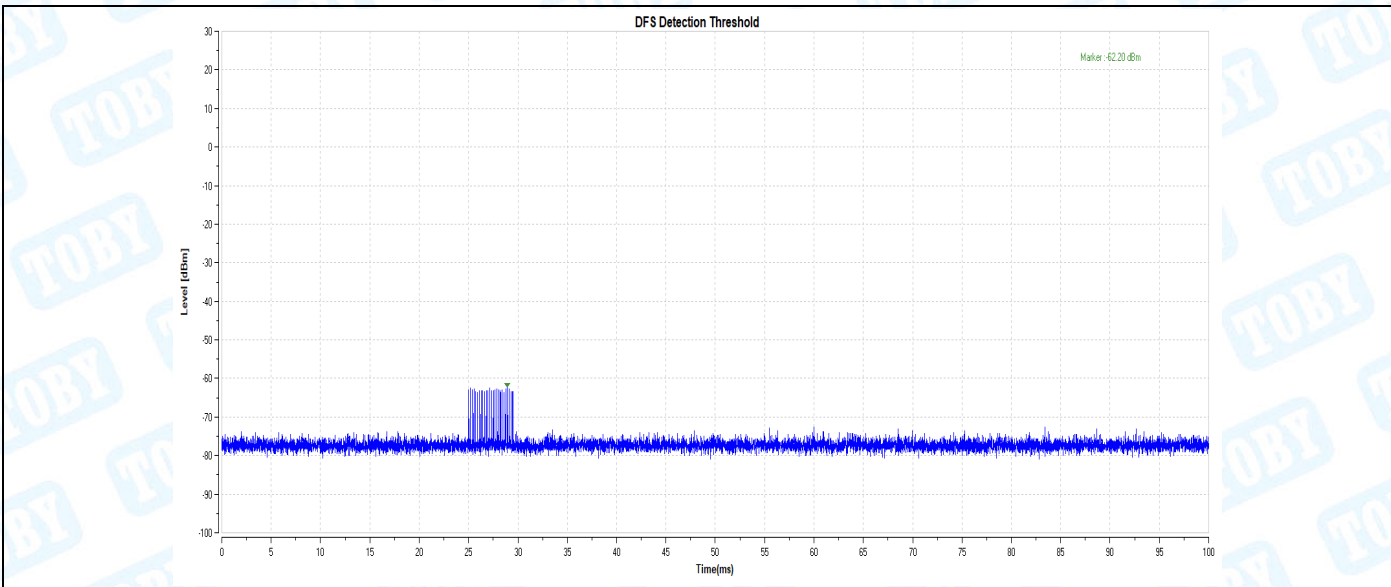

11A_5500_Type2

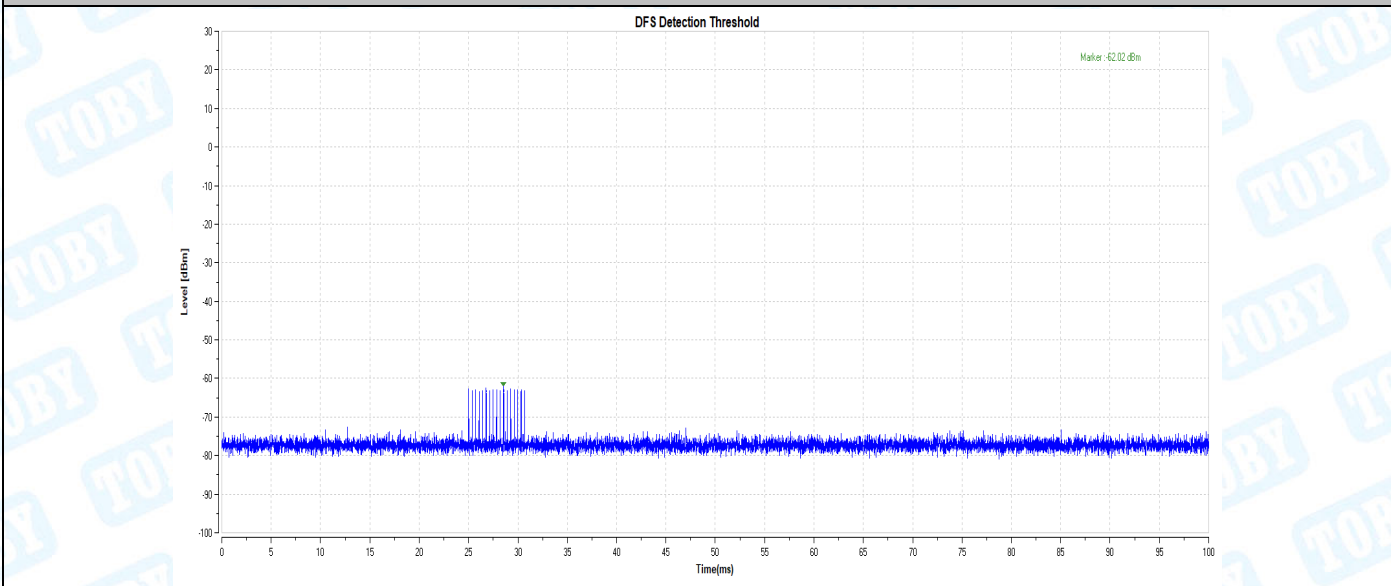

11A_5500_Type3

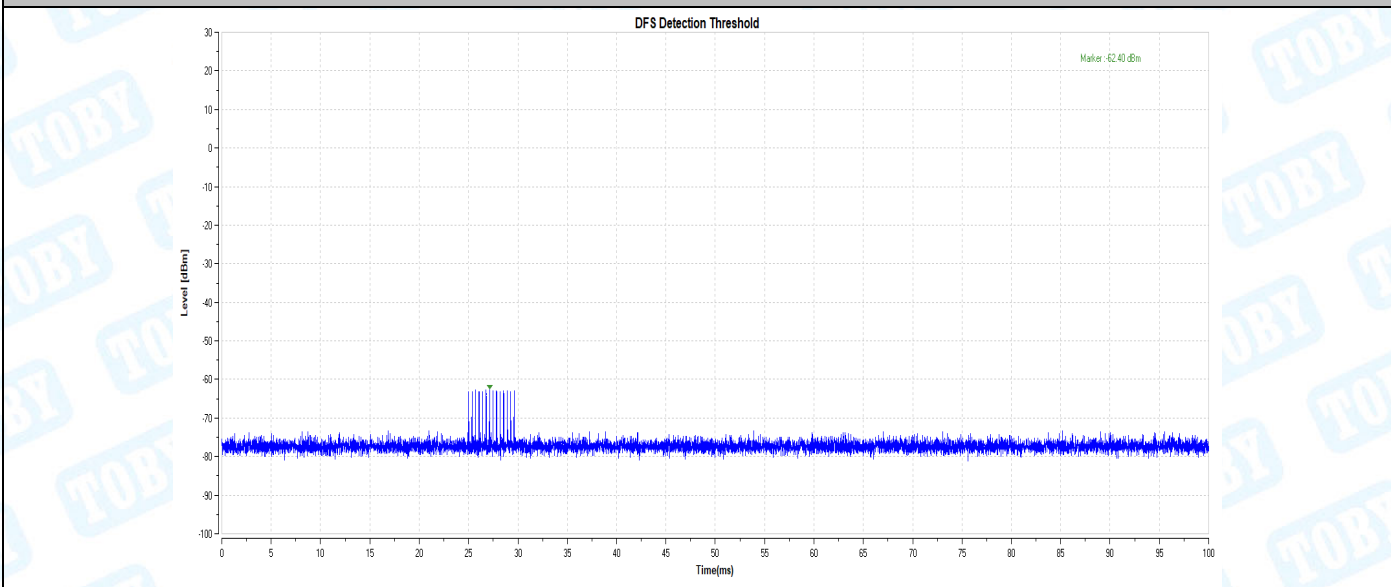

11A_5500_Type4

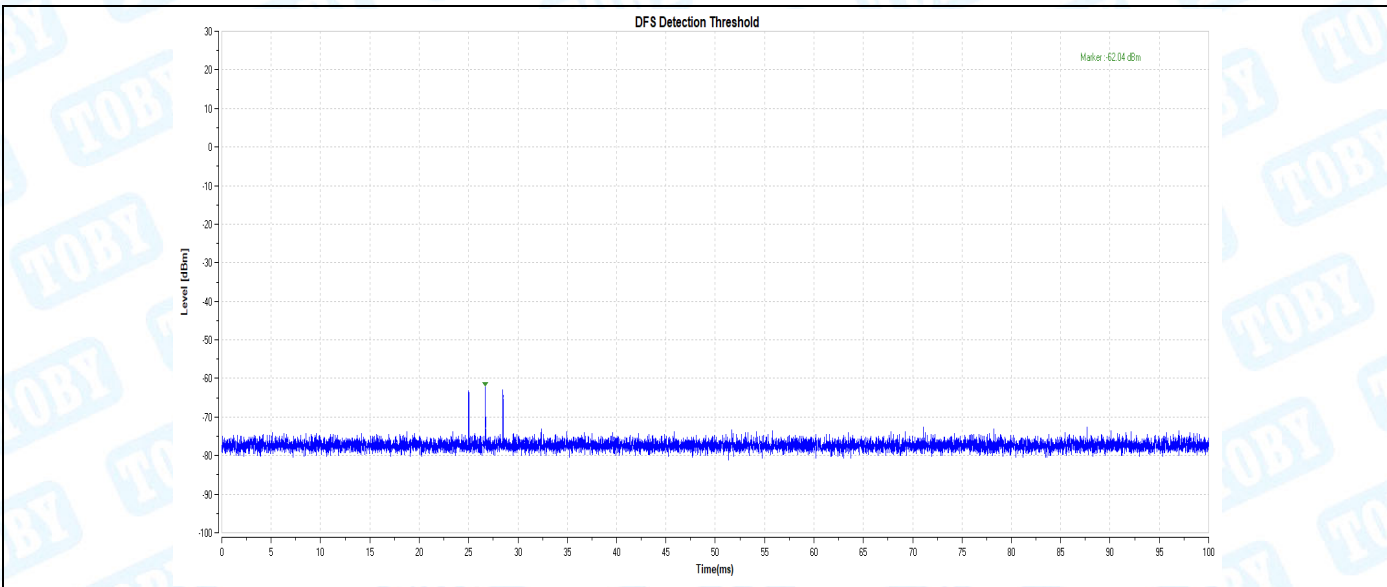

11A_5500_Type5

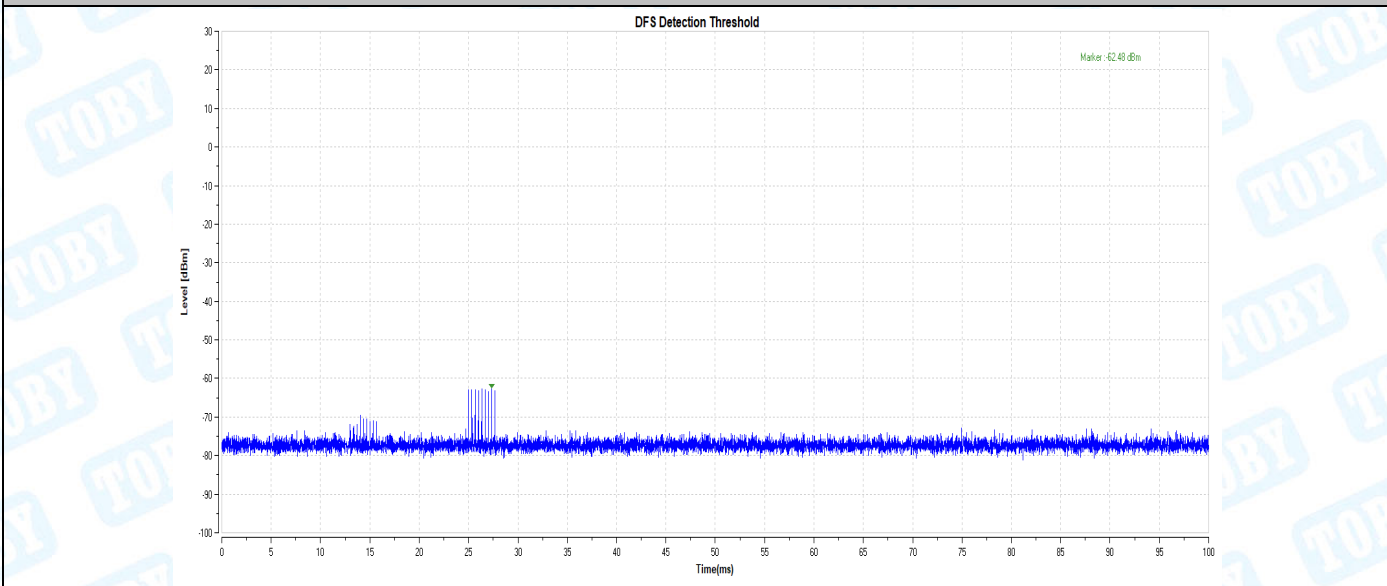

11A_5500_Type6

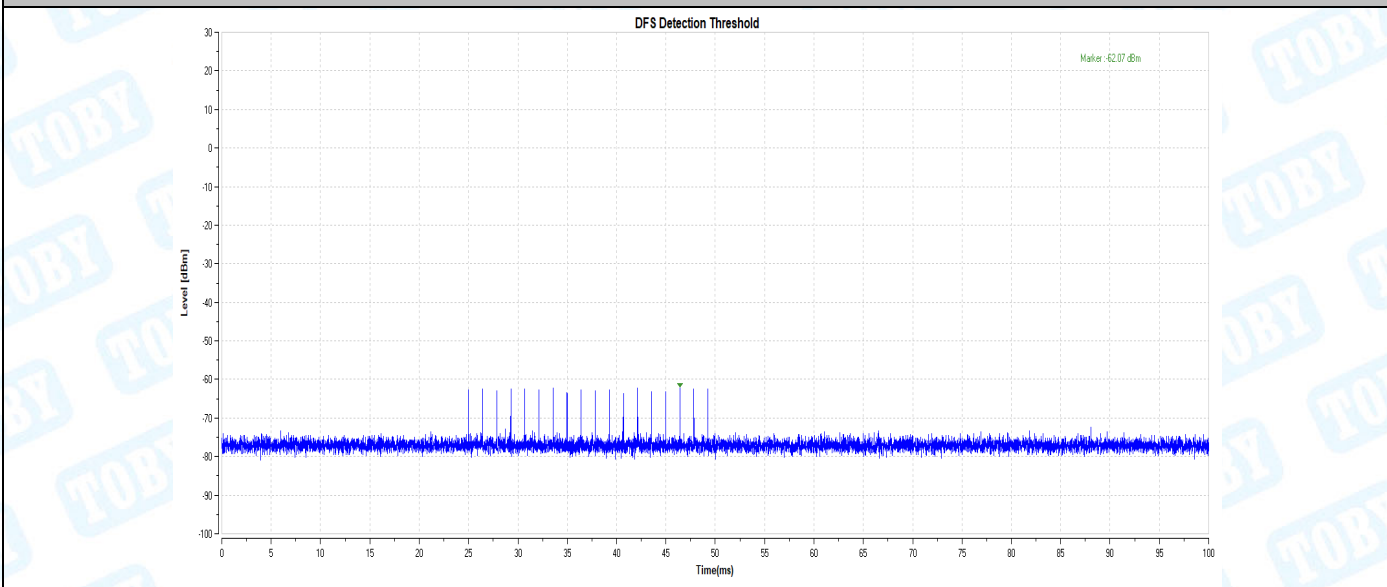

11N40_5270_Type0

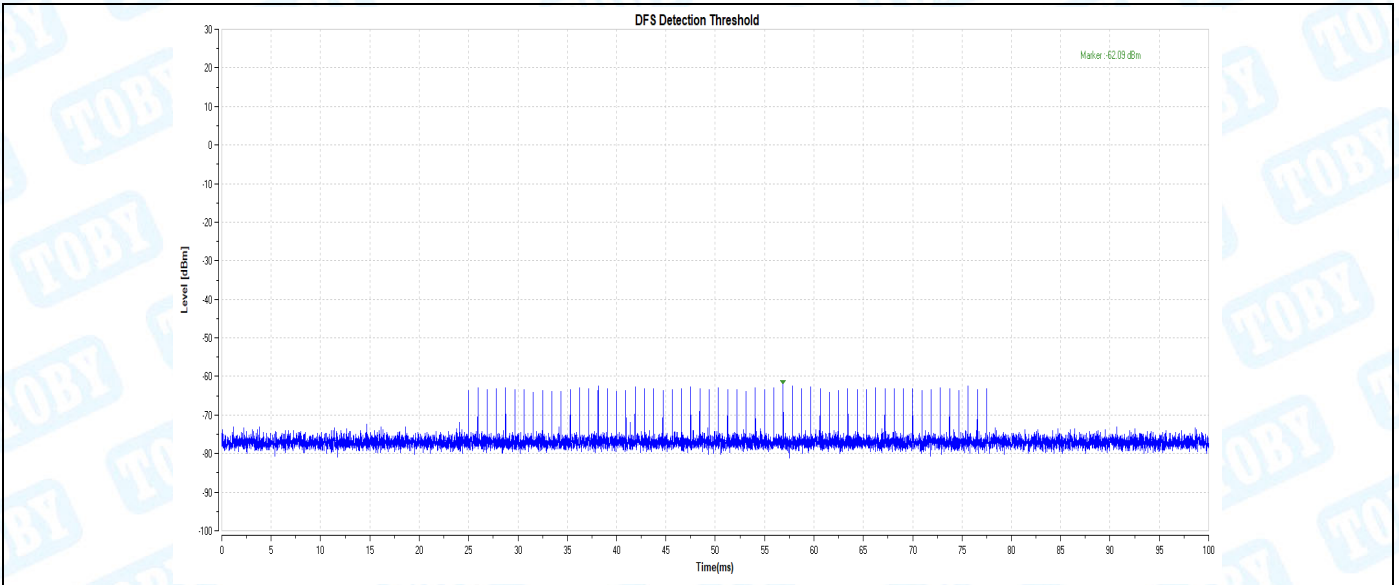

11N40_5270_Type1

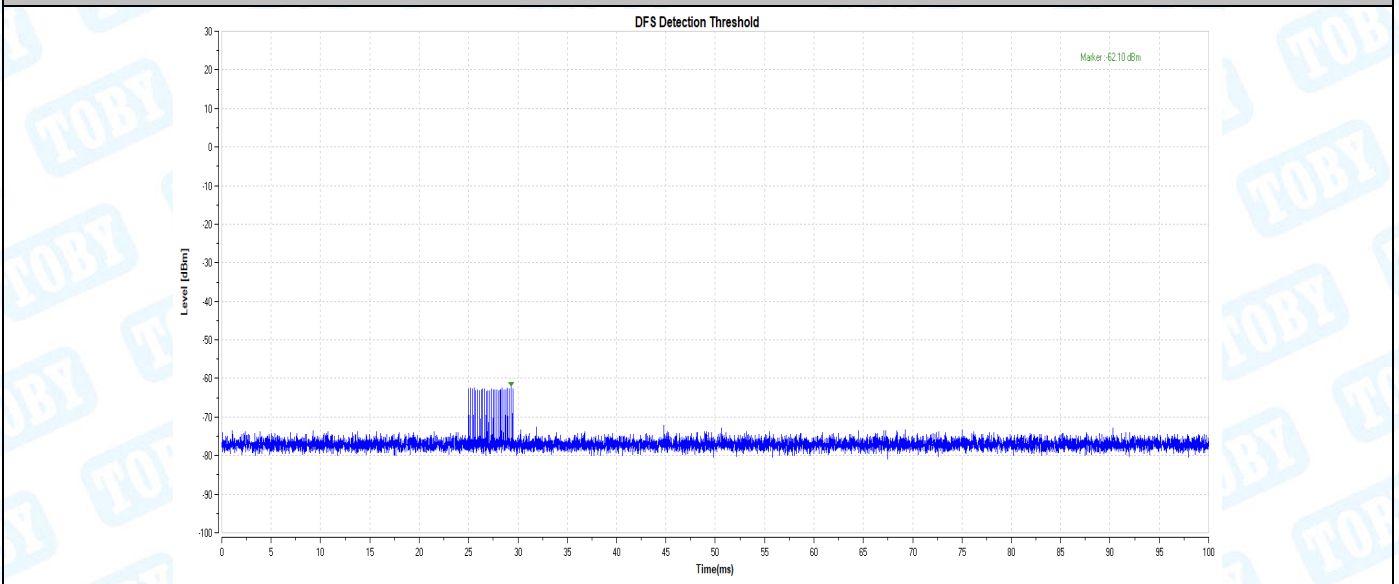

11N40_5270_Type2

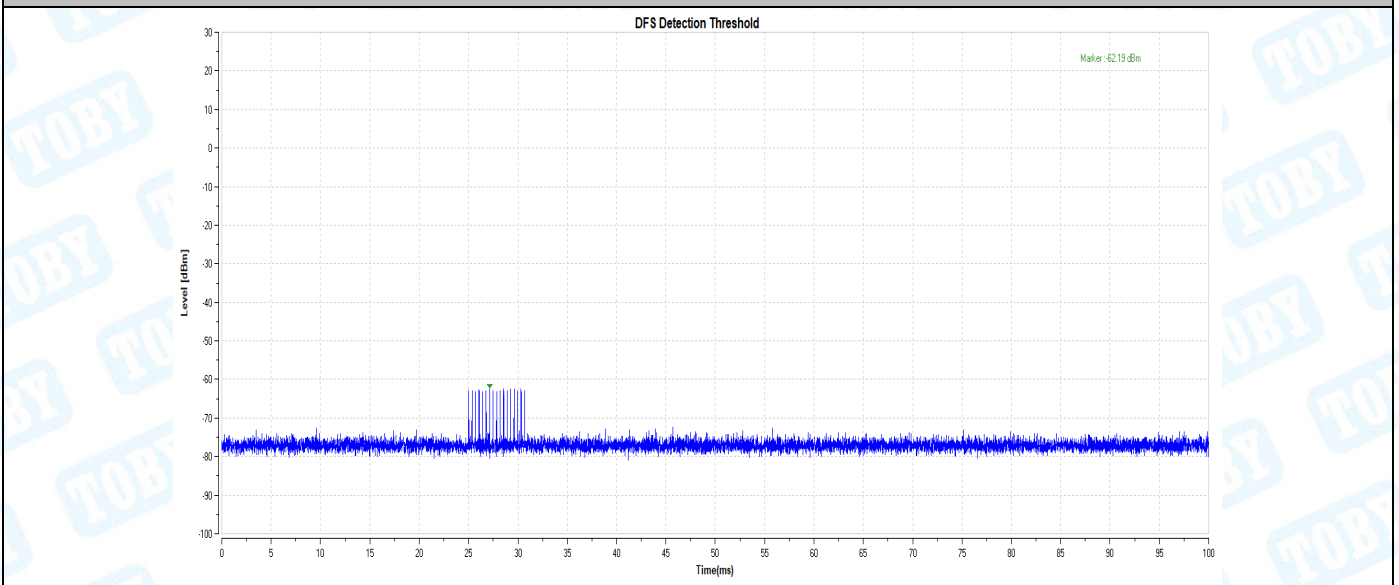

11N40_5270_Type3

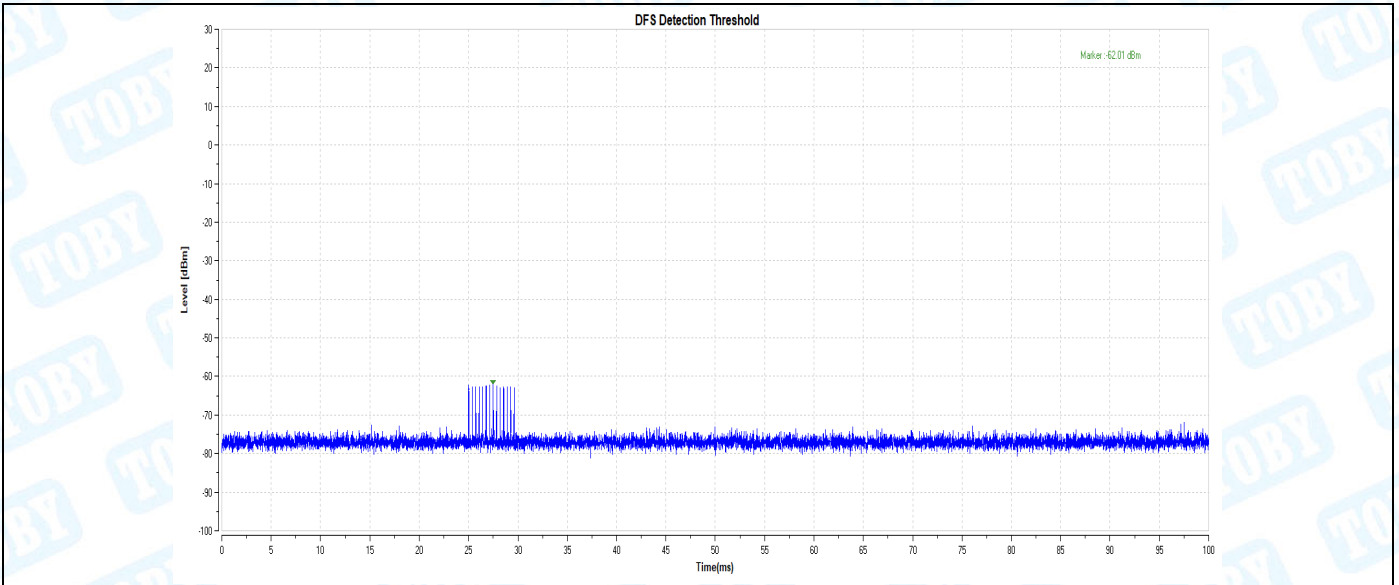

11N40_5270_Type4

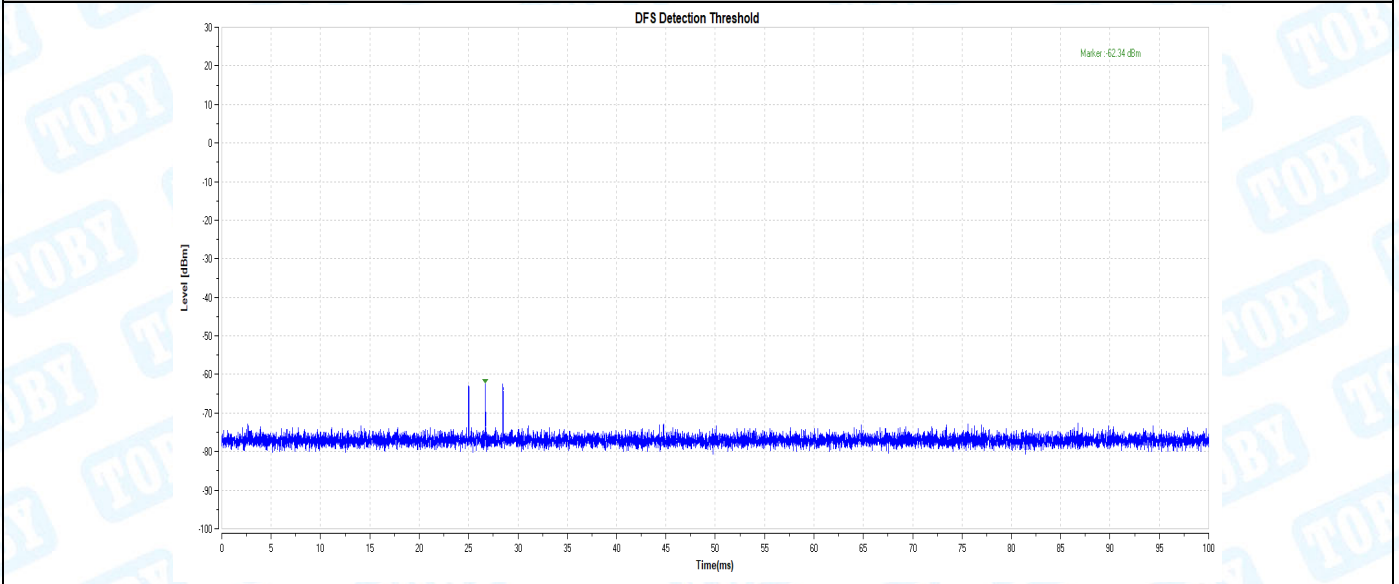

11N40_5270_Type5

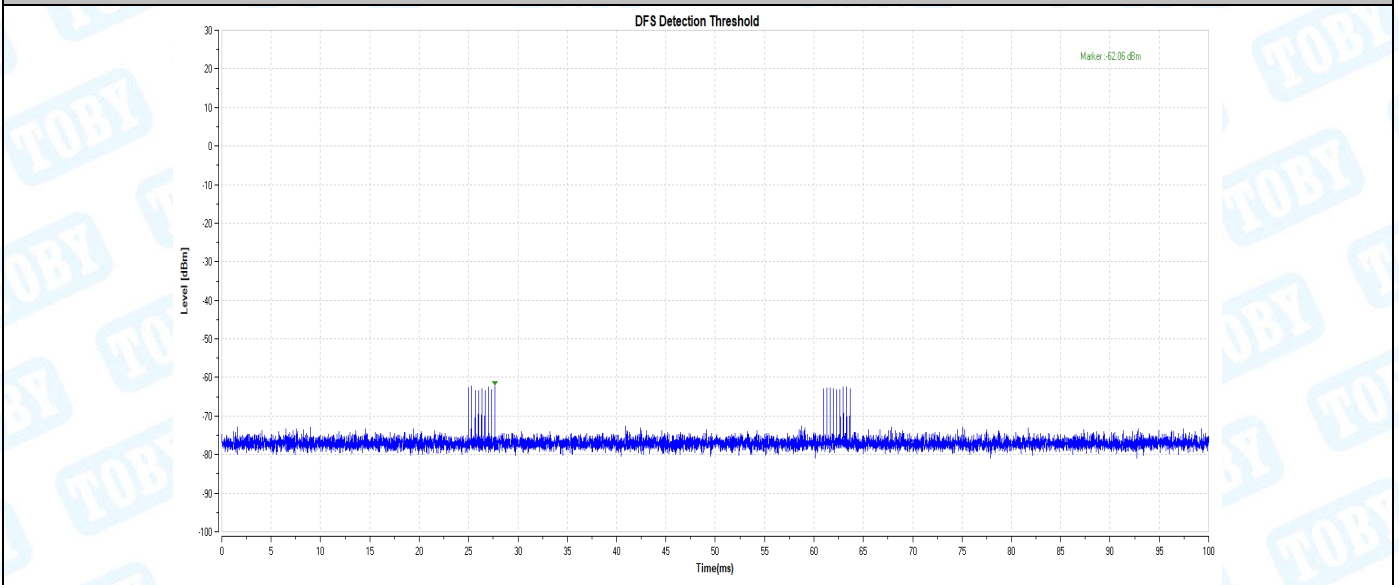

11N40_5270_Type6

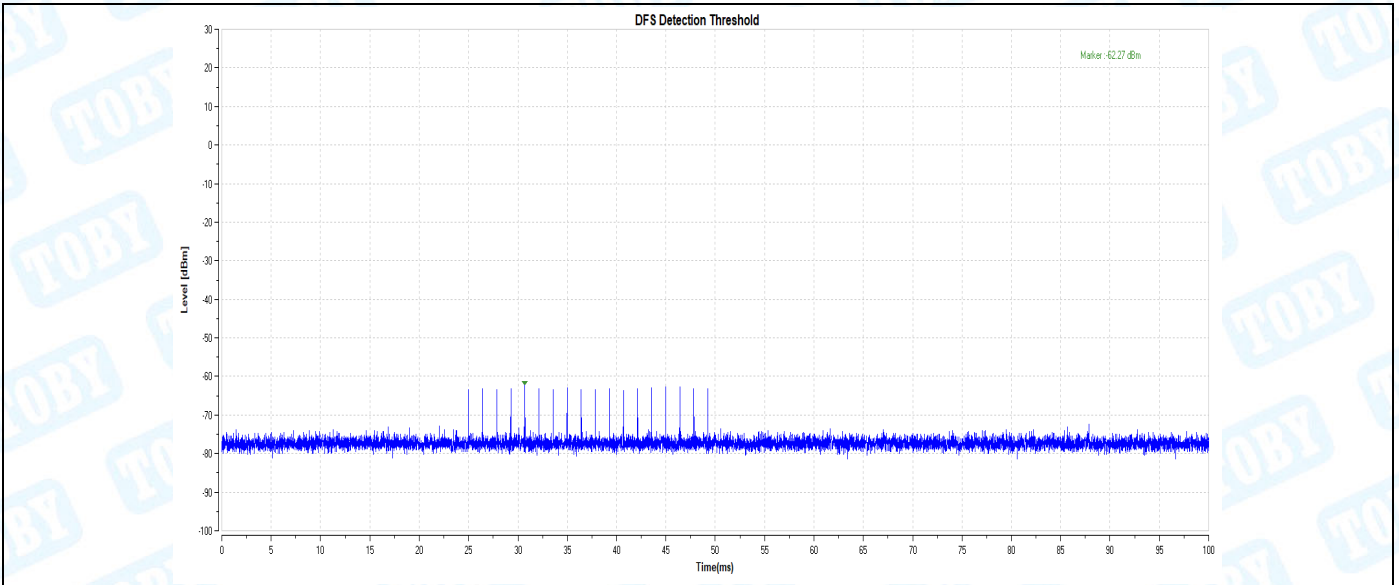

11N40_5510_Type0

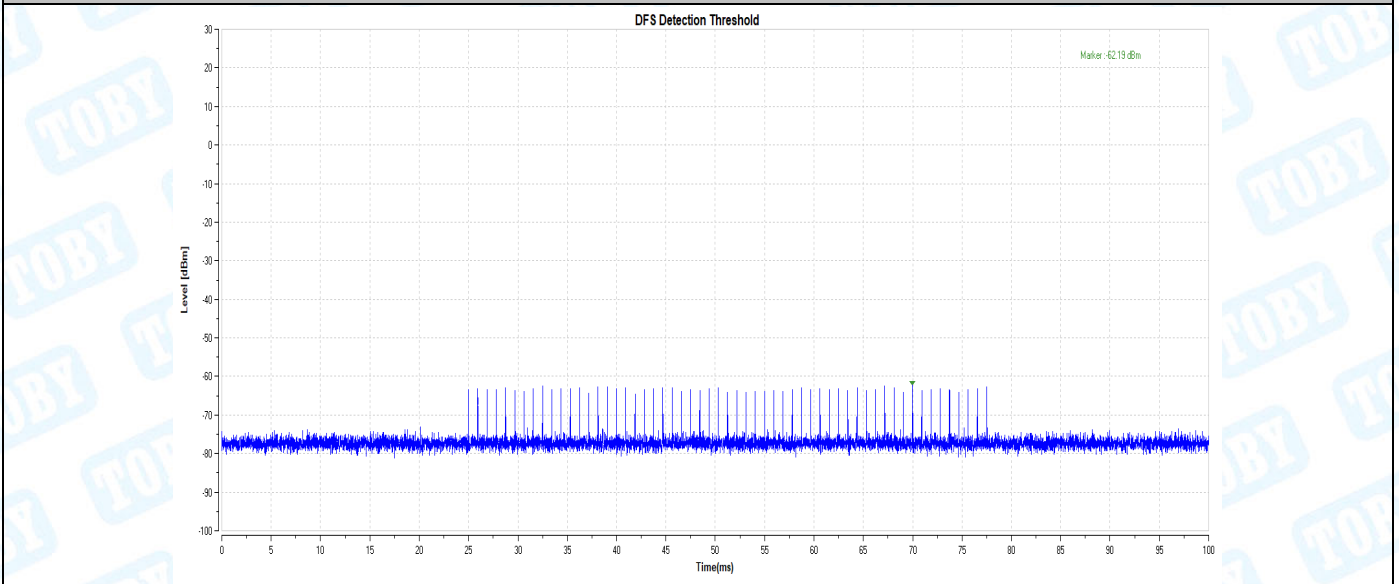

11N40_5510_Type1

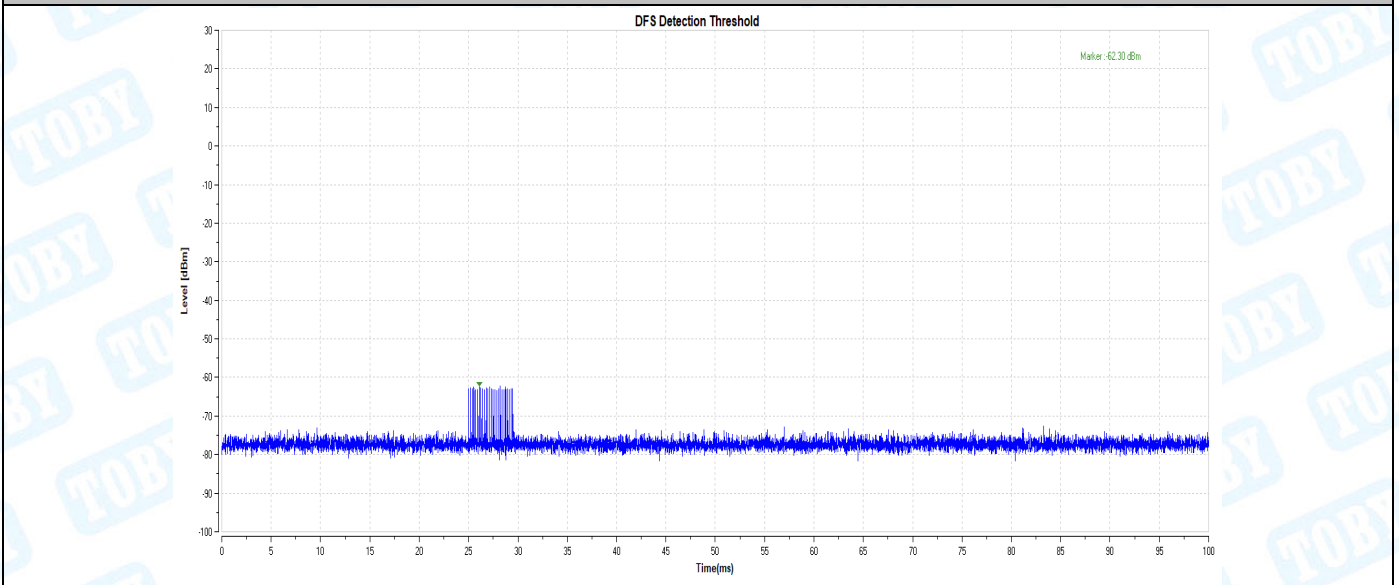

11N40_5510_Type2

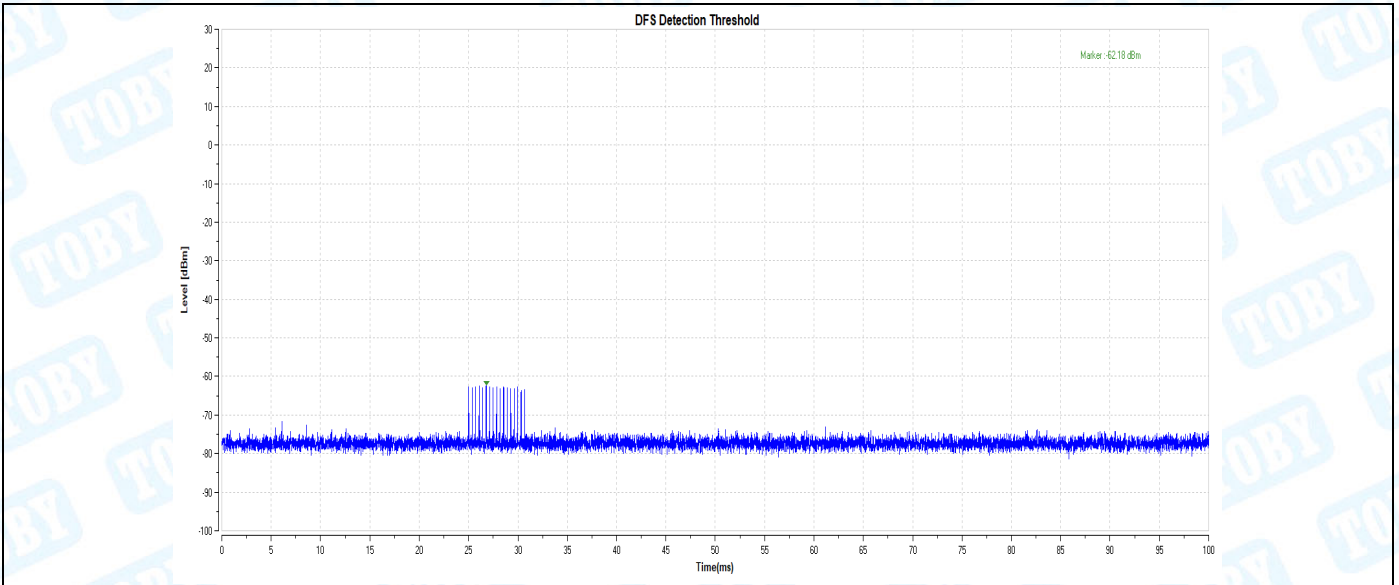

11N40_5510_Type3

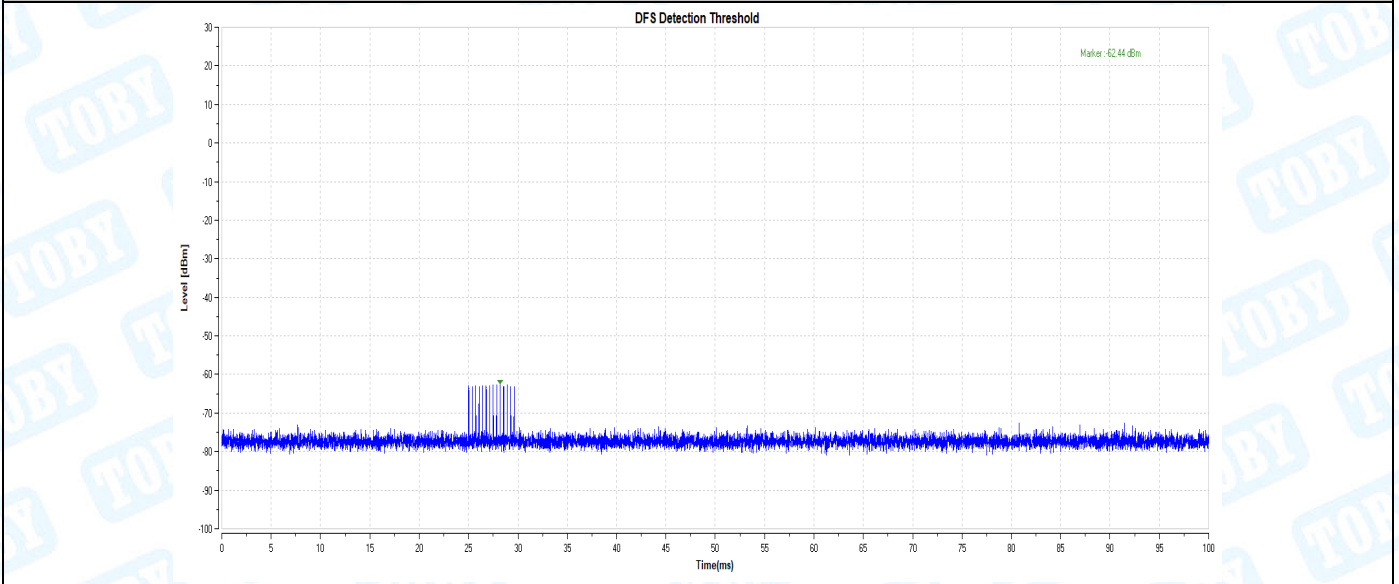

11N40_5510_Type4

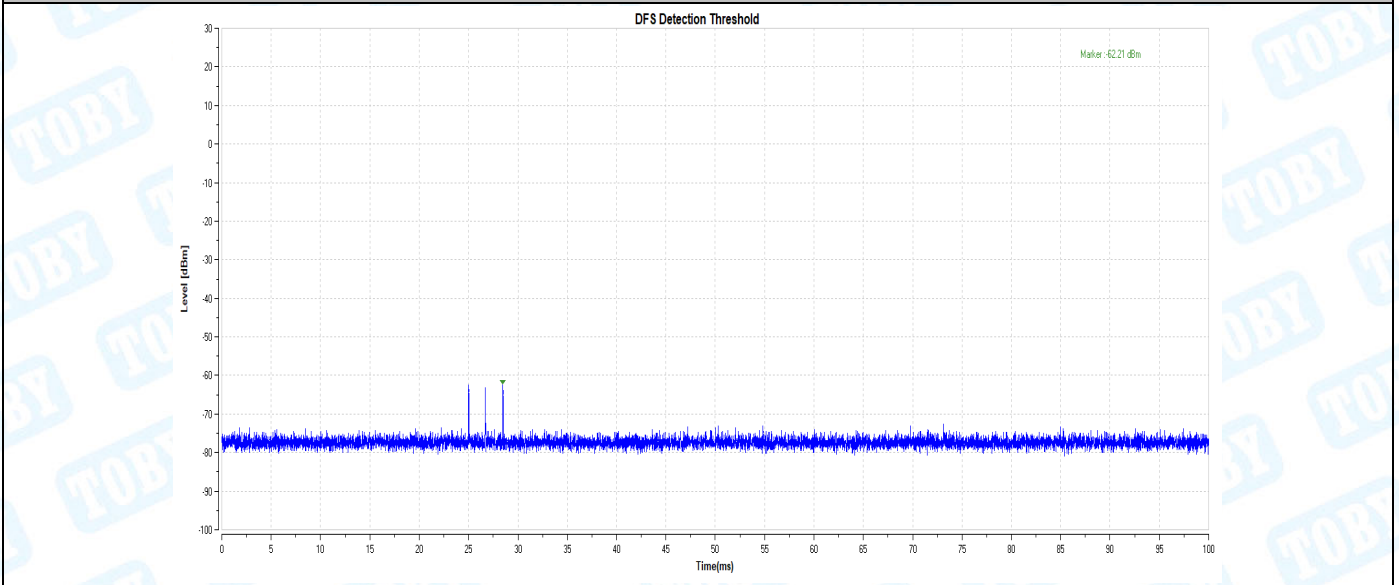

11N40_5510_Type5

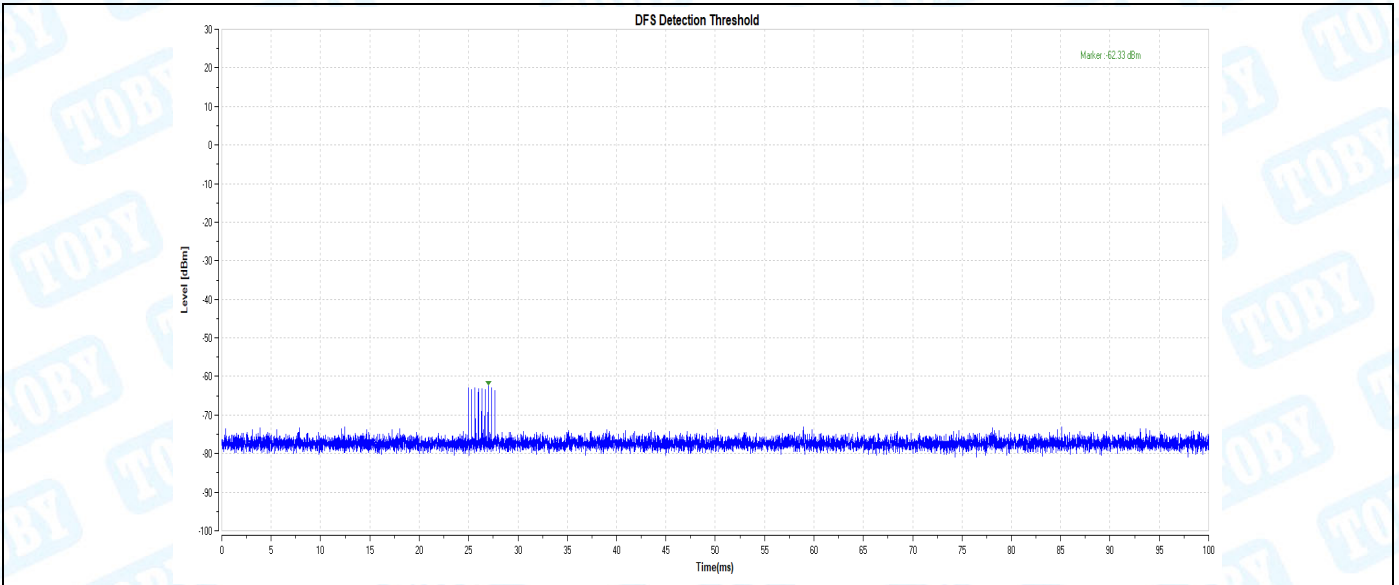

11N40_5510_Type6

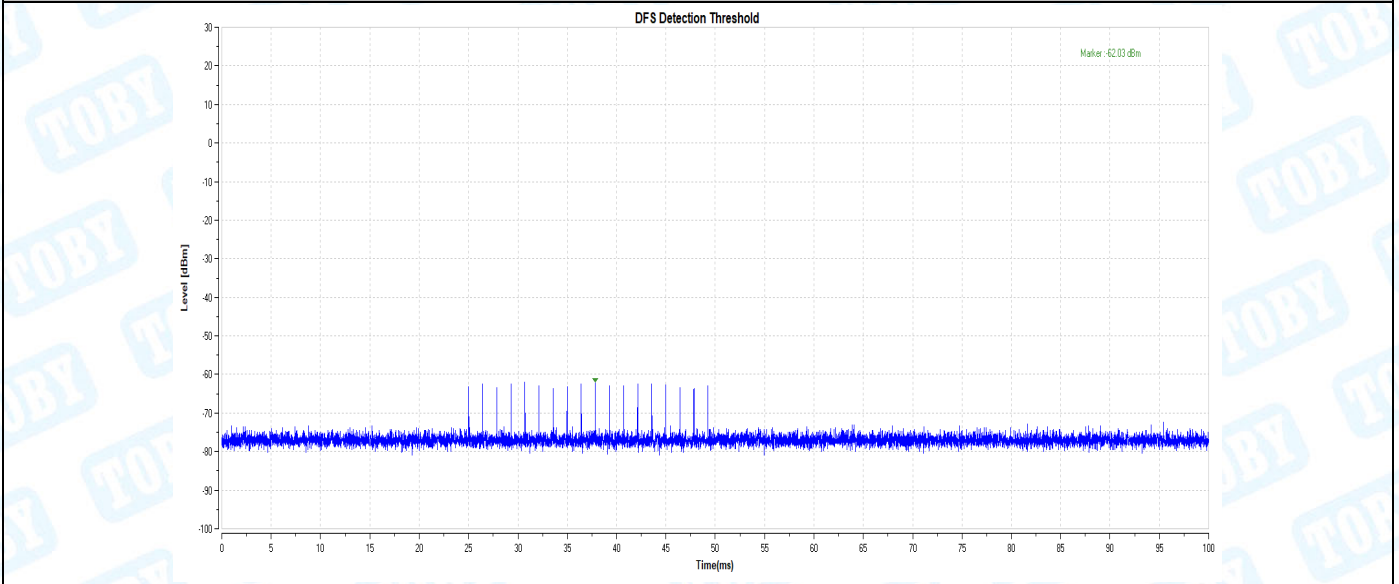

11AX80_5290_Type0

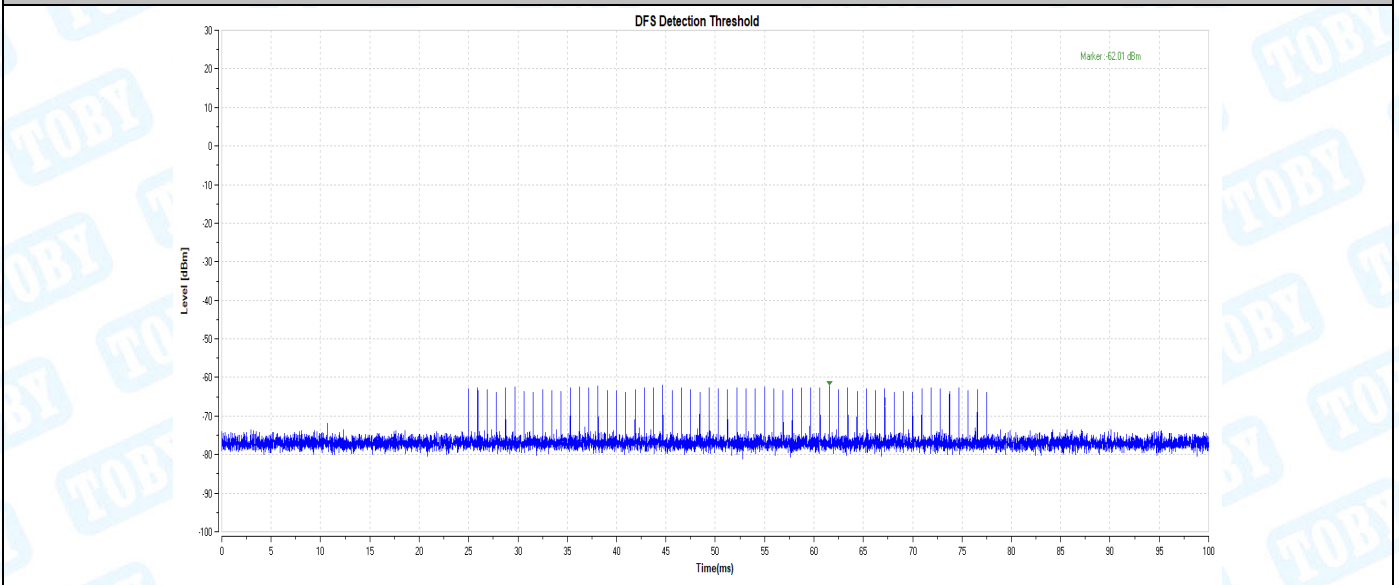

11AX80_5290_Type1

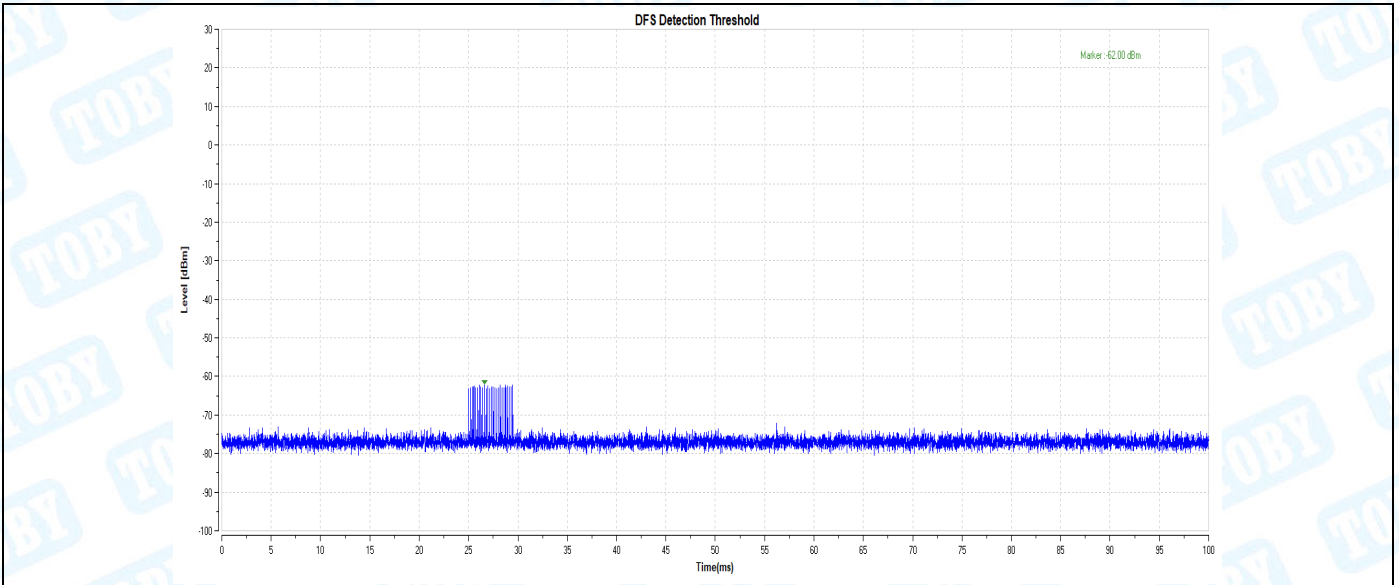

11AX80_5290_Type2

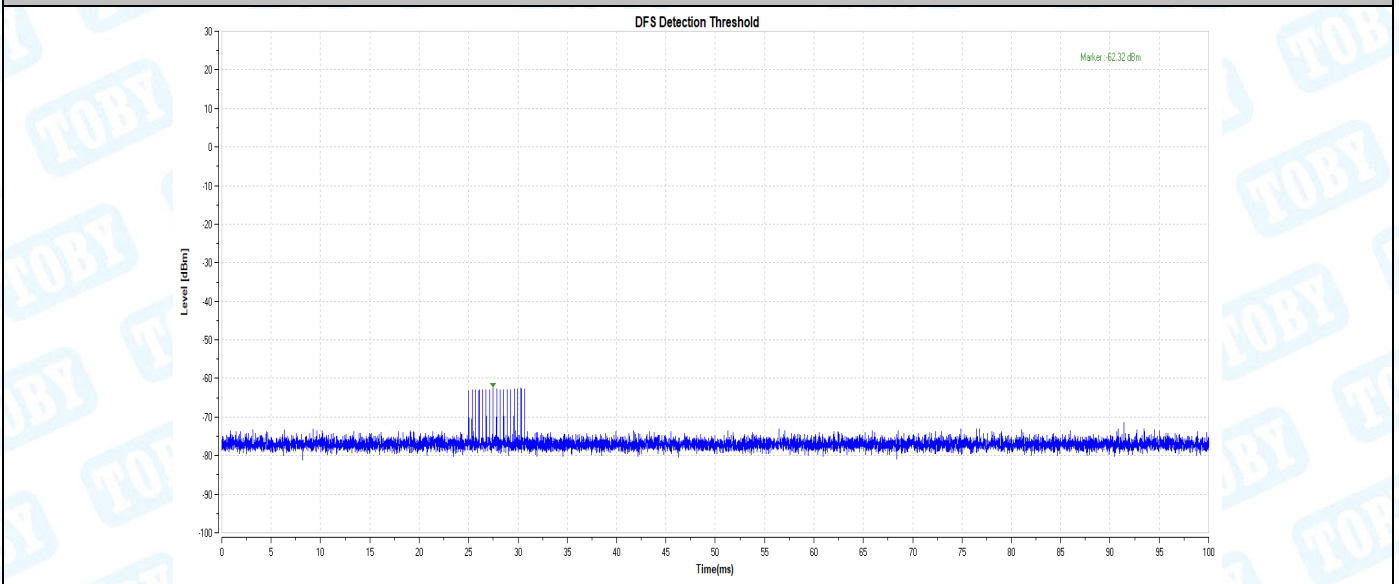

11AX80_5290_Type3

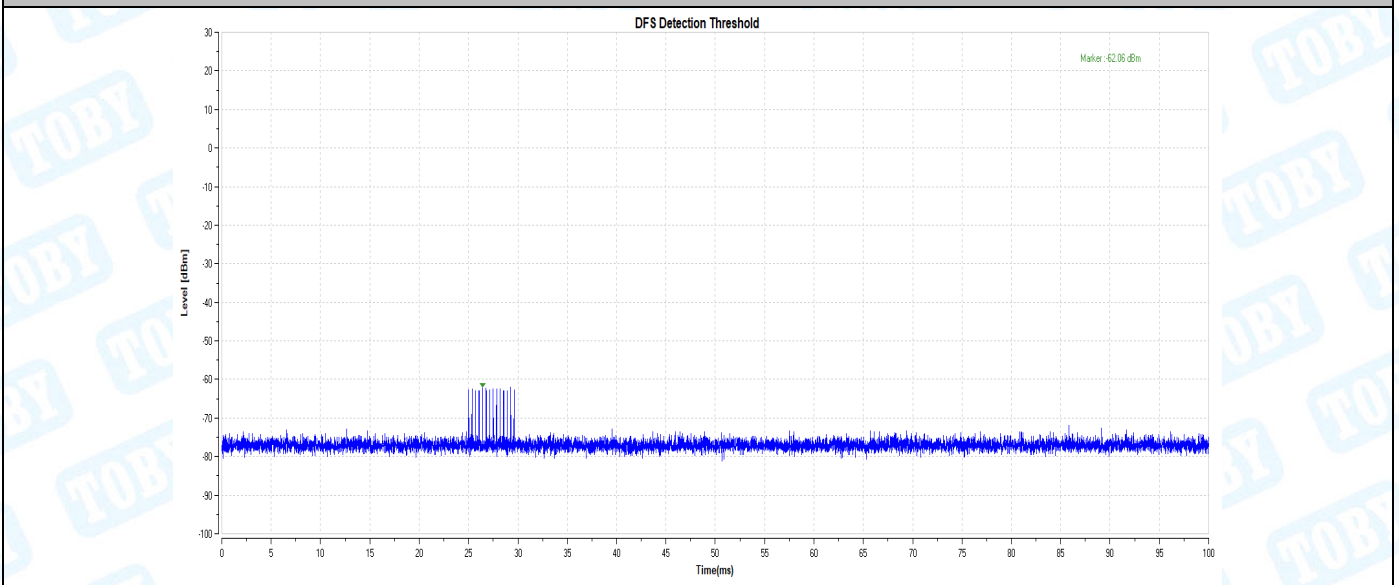

11AX80_5290_Type4

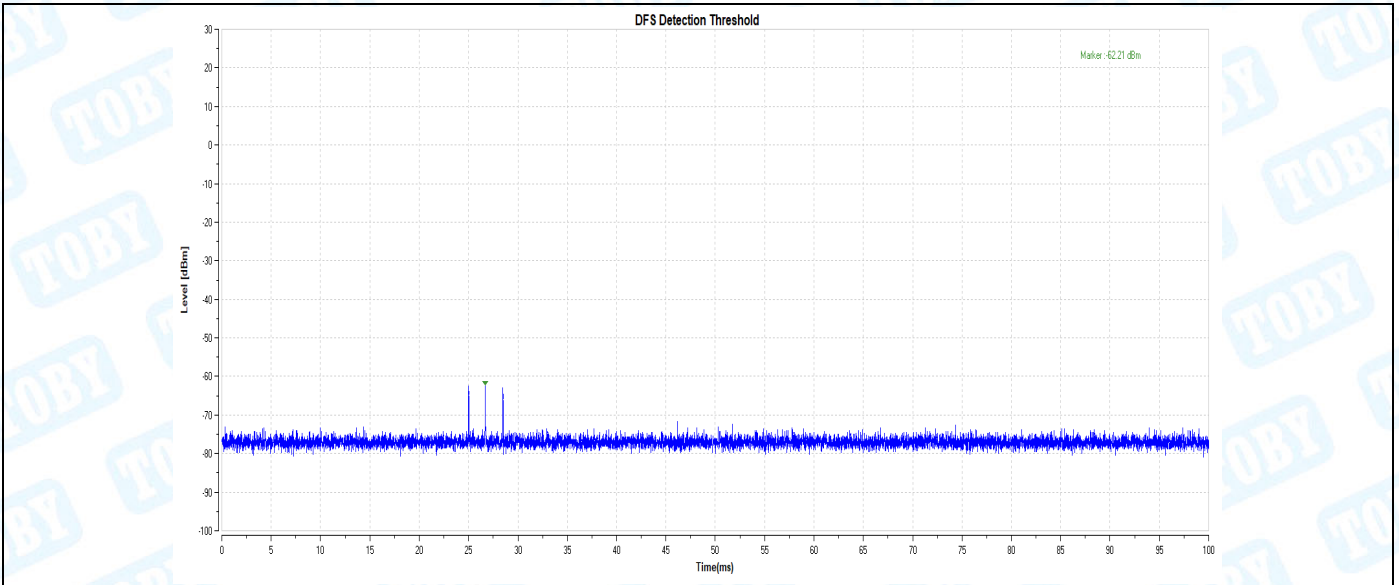

11AX80_5290_Type5

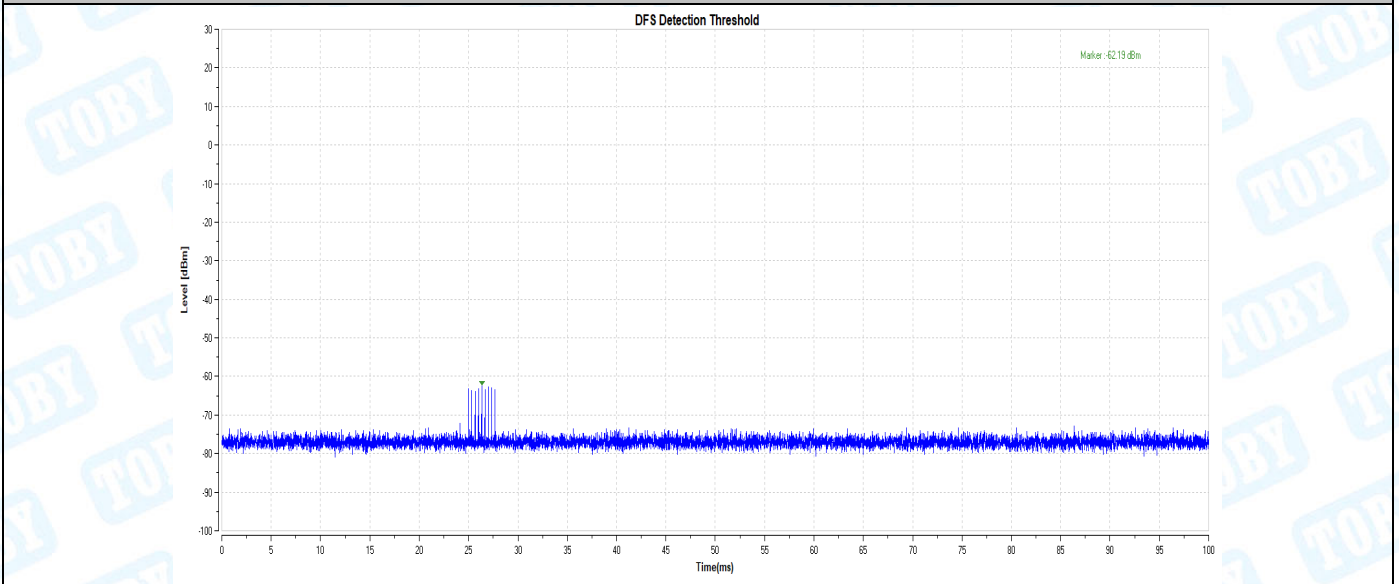

11AX80_5290_Type6

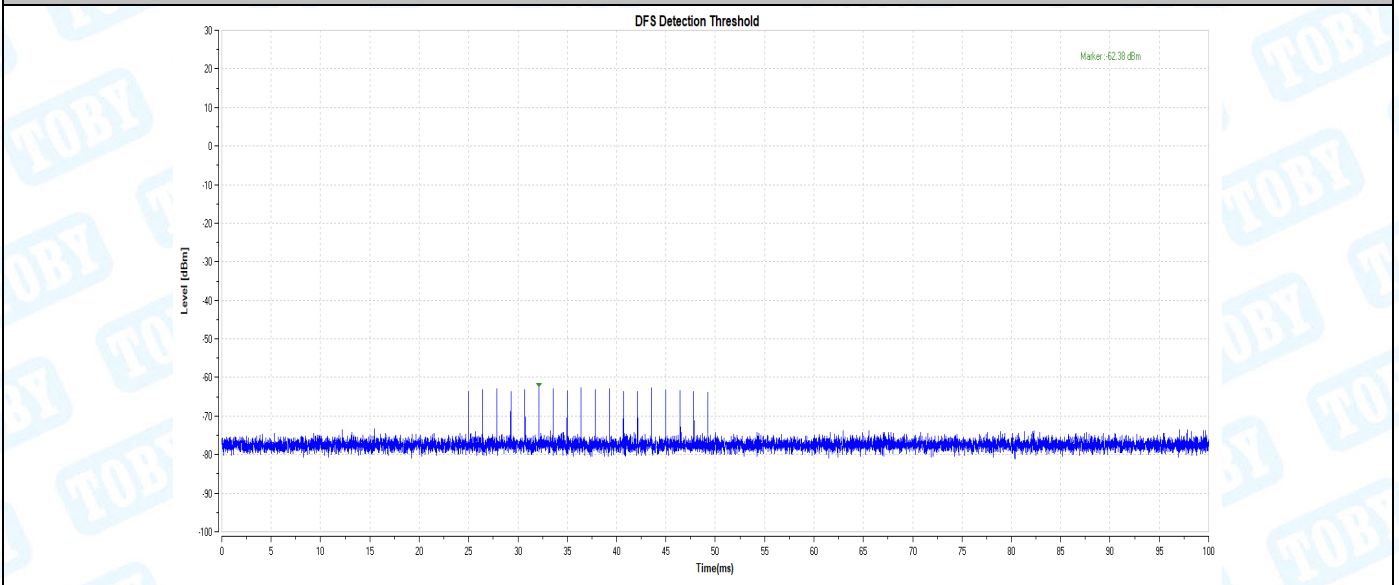

11AX80_5530_Type0

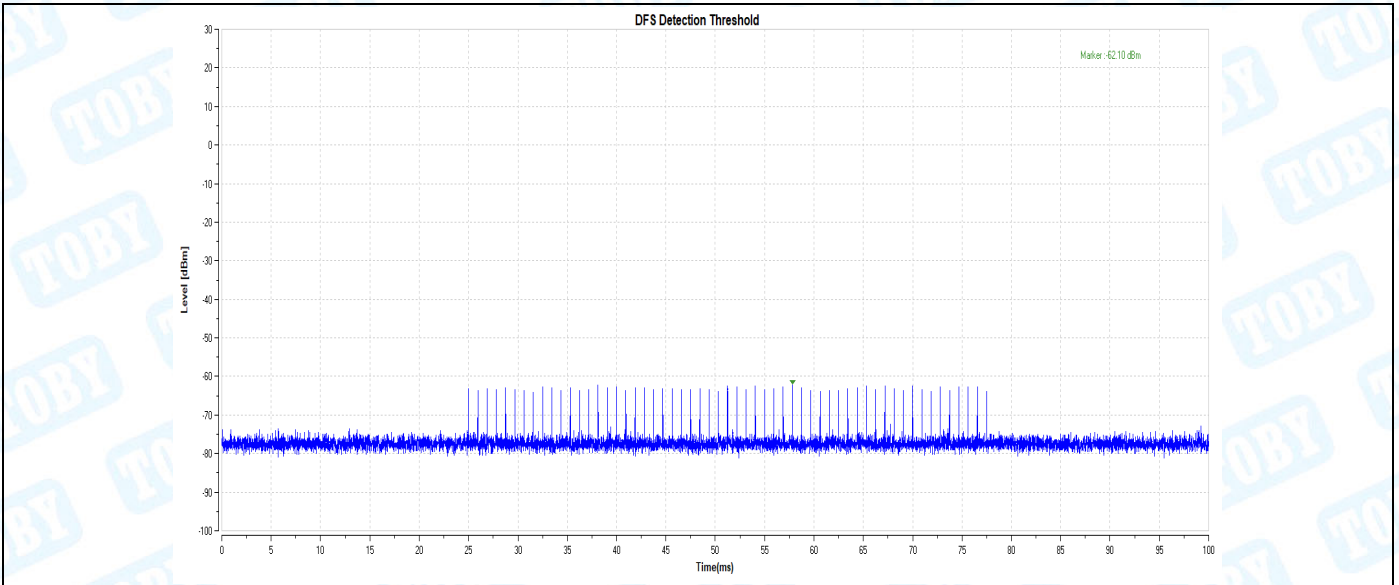

11AX80_5530_Type1

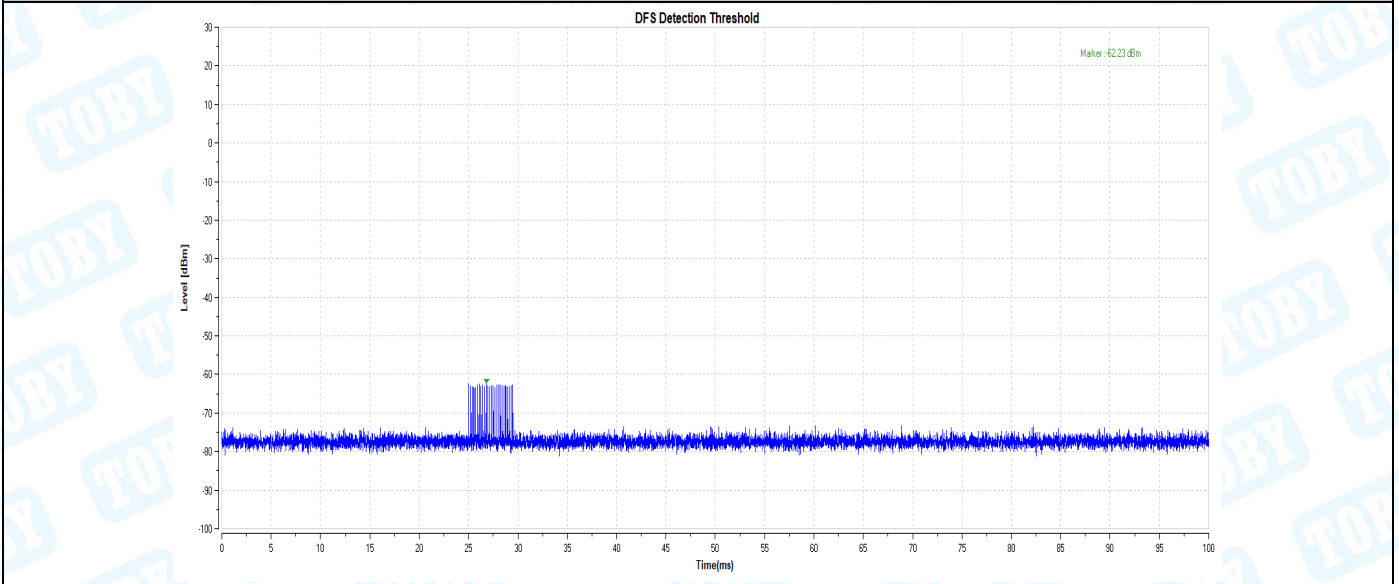

11AX80_5530_Type2

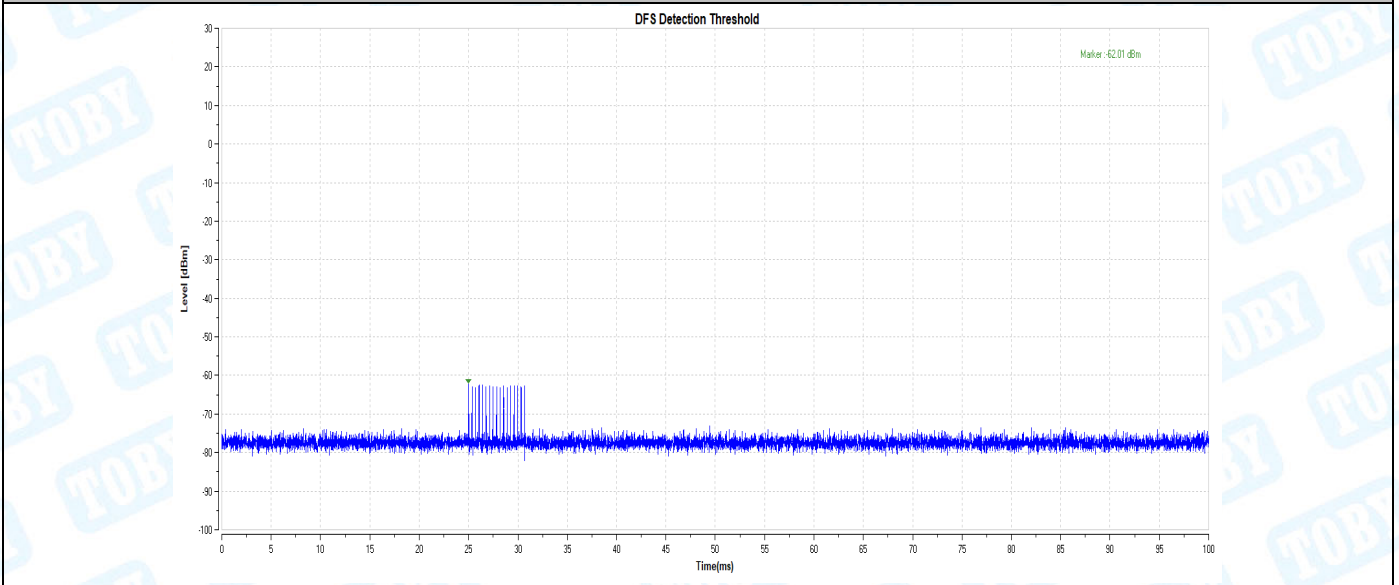

11AX80_5530_Type3

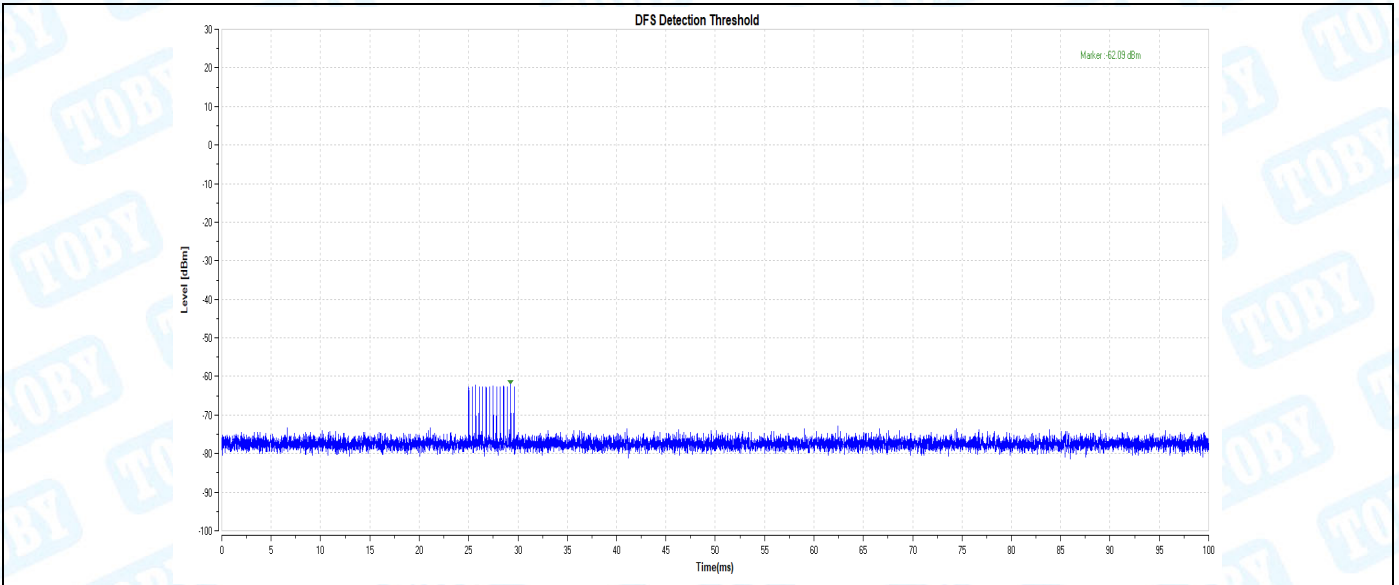

11AX80_5530_Type4

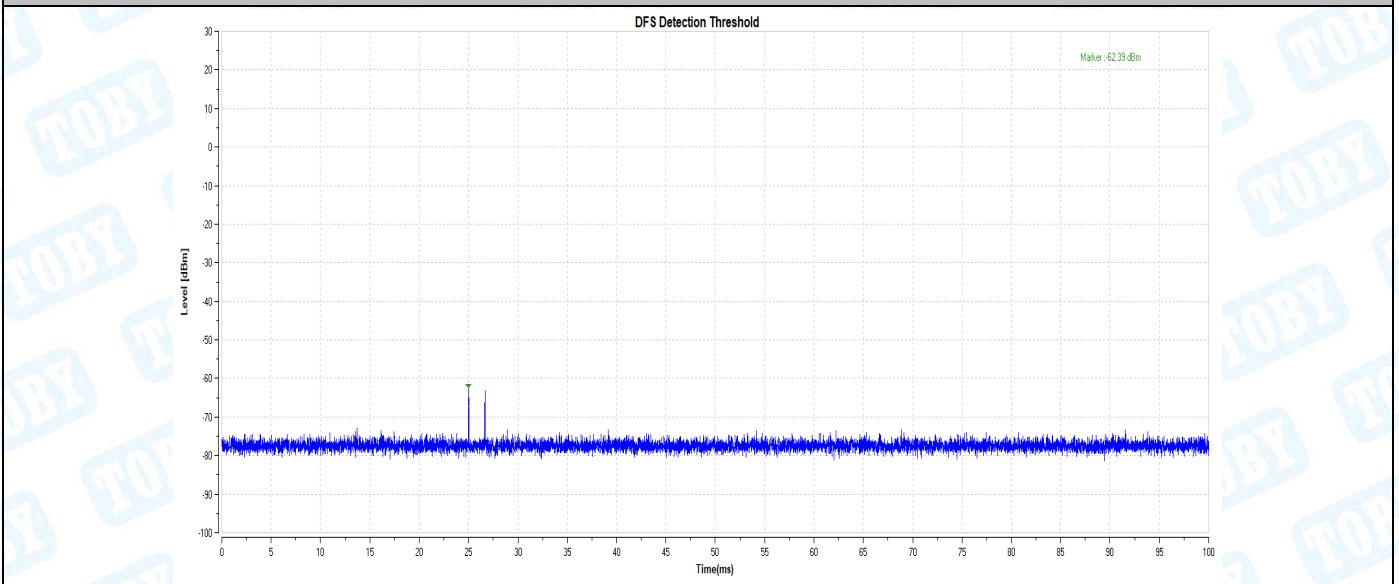

11AX80_5530_Type5

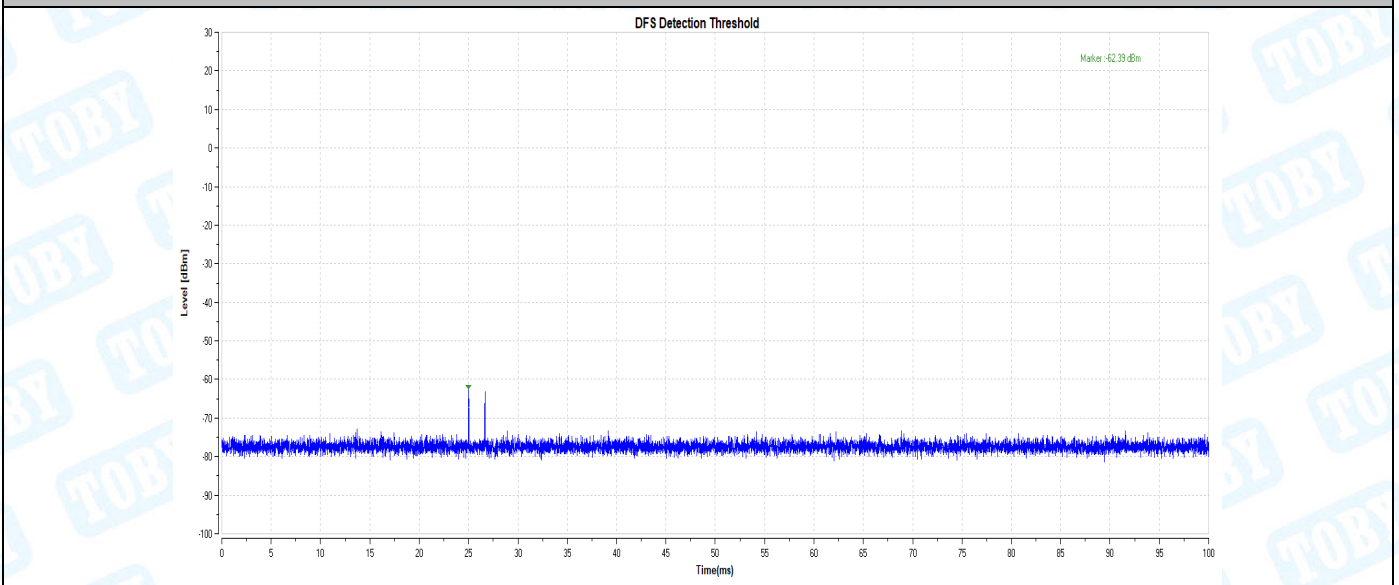

11AX80_5530_Type6

Radar Signal 1					
Trial ID	Radar Type	Pulse Width (us)	PRI (us)	Number of Pulses	Waveform Length (us)
0	Type 1	1	938	57	53466
1	Type 1	1	698	76	53048
2	Type 1	1	618	86	53148
3	Type 1	1	538	99	53262
4	Type 1	1	878	61	53558
5	Type 1	1	3066	18	55188
6	Type 1	1	638	83	52954
7	Type 1	1	918	58	53244
8	Type 1	1	838	63	52794
9	Type 1	1	858	62	53196
10	Type 1	1	798	67	53466
11	Type 1	1	718	74	53132
12	Type 1	1	578	92	53176
13	Type 1	1	598	89	53222
14	Type 1	1	558	95	53010
15	Type 1	1	2536	21	53256
16	Type 1	1	966	55	53130
17	Type 1	1	827	64	52928
18	Type 1	1	2501	22	55022
19	Type 1	1	2595	21	54495
20	Type 1	1	1114	48	53472
21	Type 1	1	1302	41	53382
22	Type 1	1	3045	18	54810
23	Type 1	1	1624	33	53592
24	Type 1	1	2878	19	54682
25	Type 1	1	1027	52	53404
26	Type 1	1	2485	22	54670
27	Type 1	1	1600	33	52800
28	Type 1	1	1172	46	53912
29	Type 1	1	1177	45	52965

Radar Signal 2					
Trial ID	Radar Type	Pulse Width (us)	PRI (us)	Number of Pulses	Waveform Length (us)
0	Type 2	3.2	179	26	4654
1	Type 2	1.1	207	23	4761
2	Type 2	2.1	230	24	5520
3	Type 2	4.8	200	29	5800
4	Type 2	3.9	214	28	5992
5	Type 2	2.9	222	26	5772
6	Type 2	3.2	204	26	5304
7	Type 2	2.5	192	25	4800
8	Type 2	3.1	164	26	4264
9	Type 2	1.2	156	23	3588
10	Type 2	3.9	210	27	5670
11	Type 2	4.6	201	29	5829
12	Type 2	3.2	162	26	4212
13	Type 2	2.2	197	25	4925
14	Type 2	4.5	163	29	4727
15	Type 2	3	203	26	5278
16	Type 2	5	168	29	4872
17	Type 2	2.4	217	25	5425
18	Type 2	2.9	191	26	4966
19	Type 2	2.3	166	25	4150
20	Type 2	3.7	150	27	4050
21	Type 2	2.2	176	25	4400
22	Type 2	4.9	195	29	5655
23	Type 2	2.9	202	26	5252
24	Type 2	2.5	178	25	4450
25	Type 2	1.1	206	23	4738
26	Type 2	3.8	155	27	4185
27	Type 2	4.7	157	29	4553
28	Type 2	2.4	224	25	5600
29	Type 2	4.2	159	28	4452

Radar Signal 3					
Trial ID	Radar Type	Pulse Width (us)	PRI (us)	Number of Pulses	Waveform Length (us)
0	Type 3	8.2	355	17	6035
1	Type 3	6.1	487	16	7792
2	Type 3	7.1	344	16	5504
3	Type 3	9.8	288	18	5184
4	Type 3	8.9	230	18	4140
5	Type 3	7.9	432	17	7344
6	Type 3	8.2	207	17	3519
7	Type 3	7.5	443	17	7531
8	Type 3	8.1	439	17	7463
9	Type 3	6.2	223	16	3568
10	Type 3	8.9	208	18	3744
11	Type 3	9.6	463	18	8334
12	Type 3	8.2	441	17	7497
13	Type 3	7.2	323	16	5168
14	Type 3	9.5	297	18	5346
15	Type 3	8	412	17	7004
16	Type 3	10	324	18	5832
17	Type 3	7.4	271	17	4607
18	Type 3	7.9	349	17	5933
19	Type 3	7.3	409	16	6544
20	Type 3	8.7	373	18	6714
21	Type 3	7.2	254	16	4064
22	Type 3	9.9	274	18	4932
23	Type 3	7.9	278	17	4726
24	Type 3	7.5	317	17	5389
25	Type 3	6.1	260	16	4160
26	Type 3	8.8	211	18	3798
27	Type 3	9.7	272	18	4896
28	Type 3	7.4	264	17	4488
29	Type 3	9.2	284	18	5112

Radar Signal 4					
Trial ID	Radar Type	Pulse Width (us)	PRI (us)	Number of Pulses	Waveform Length (us)
0	Type 4	16	355	14	4970
1	Type 4	11.3	487	12	5844
2	Type 4	13.5	344	13	4472
3	Type 4	19.4	288	16	4608
4	Type 4	17.5	230	15	3450
5	Type 4	15.3	432	14	6048
6	Type 4	15.9	207	14	2898
7	Type 4	14.3	443	13	5759
8	Type 4	15.8	439	14	6146
9	Type 4	11.5	223	12	2676
10	Type 4	17.4	208	15	3120
11	Type 4	19	463	16	7408
12	Type 4	16	441	14	6174
13	Type 4	13.8	323	13	4199
14	Type 4	18.9	297	16	4752
15	Type 4	15.5	412	14	5768
16	Type 4	19.9	324	16	5184
17	Type 4	14.1	271	13	3523
18	Type 4	15.2	349	14	4886
19	Type 4	13.8	409	13	5317
20	Type 4	17.1	373	15	5595
21	Type 4	13.8	254	13	3302
22	Type 4	19.8	274	16	4384
23	Type 4	15.3	278	14	3892
24	Type 4	14.5	317	13	4121
25	Type 4	11.3	260	12	3120
26	Type 4	17.3	211	15	3165
27	Type 4	19.2	272	16	4352
28	Type 4	14.2	264	13	3432
29	Type 4	18.2	284	15	4260

Radar Signal 5				
Trial ID	Radar Type	Number of Bursts	Burst Period (s)	Waveform Length (s)
0	Type 5	15	0.8	12
1	Type 5	8	1.5	12
2	Type 5	11	1.0909091	12
3	Type 5	20	0.6	12
4	Type 5	17	0.7058824	12
5	Type 5	14	0.8571429	12
6	Type 5	15	0.8	12
7	Type 5	12	1	12
8	Type 5	14	0.8571429	12
9	Type 5	8	1.5	12
10	Type 5	17	0.7058824	12
11	Type 5	19	0.6315789	12
12	Type 5	15	0.8	12
13	Type 5	12	1	12
14	Type 5	19	0.6315789	12
15	Type 5	14	0.8571429	12
16	Type 5	20	0.6	12
17	Type 5	12	1	12
18	Type 5	14	0.8571429	12
19	Type 5	12	1	12
20	Type 5	16	0.75	12
21	Type 5	12	1	12
22	Type 5	20	0.6	12
23	Type 5	14	0.8571429	12
24	Type 5	13	0.9230769	12
25	Type 5	8	1.5	12
26	Type 5	17	0.7058824	12
27	Type 5	19	0.6315789	12
28	Type 5	12	1	12
29	Type 5	18	0.6666667	12

Radar Signal 6							
Trial ID	Radar Type	Pulse Width (us)	PRI (us)	Pulses per Hop	Hopping Rate (kHz)	Hopping Sequence Length (ms)	Visible Frequency Number
0	Type 6	1	333.3	9	0.3333	300	32
1	Type 6	1	333.3	9	0.3333	300	27
2	Type 6	1	333.3	9	0.3333	300	25
3	Type 6	1	333.3	9	0.3333	300	33
4	Type 6	1	333.3	9	0.3333	300	37
5	Type 6	1	333.3	9	0.3333	300	30
6	Type 6	1	333.3	9	0.3333	300	33
7	Type 6	1	333.3	9	0.3333	300	27
8	Type 6	1	333.3	9	0.3333	300	33
9	Type 6	1	333.3	9	0.3333	300	30
10	Type 6	1	333.3	9	0.3333	300	37
11	Type 6	1	333.3	9	0.3333	300	36
12	Type 6	1	333.3	9	0.3333	300	38
13	Type 6	1	333.3	9	0.3333	300	35
14	Type 6	1	333.3	9	0.3333	300	28
15	Type 6	1	333.3	9	0.3333	300	37
16	Type 6	1	333.3	9	0.3333	300	35
17	Type 6	1	333.3	9	0.3333	300	37
18	Type 6	1	333.3	9	0.3333	300	27
19	Type 6	1	333.3	9	0.3333	300	34
20	Type 6	1	333.3	9	0.3333	300	35
21	Type 6	1	333.3	9	0.3333	300	37
22	Type 6	1	333.3	9	0.3333	300	41
23	Type 6	1	333.3	9	0.3333	300	36
24	Type 6	1	333.3	9	0.3333	300	29
25	Type 6	1	333.3	9	0.3333	300	32
26	Type 6	1	333.3	9	0.3333	300	30
27	Type 6	1	333.3	9	0.3333	300	31
28	Type 6	1	333.3	9	0.3333	300	31
29	Type 6	1	333.3	9	0.3333	300	40

8.4. Channel Availability Check Time

If the UUT successfully detected the radar burst, it should be observed as the UUT has no transmissions occurred until the UUT starts transmitting on another channel.

Test Result

TestMode	Frequency[MHz]	Result	Verdict
11AX80	5290	See test Graph	PASS
	5530	See test Graph	PASS

TestMode	Frequency[MHz]	Result	Verdict
11AX80	5290	See test Graph	PASS
	5530	See test Graph	PASS

TestMode	Frequency[MHz]	Result	Verdict
11AX80	5290	See test Graph	PASS
	5530	See test Graph	PASS

Test Graphs

Initial Channel Availability Check Time

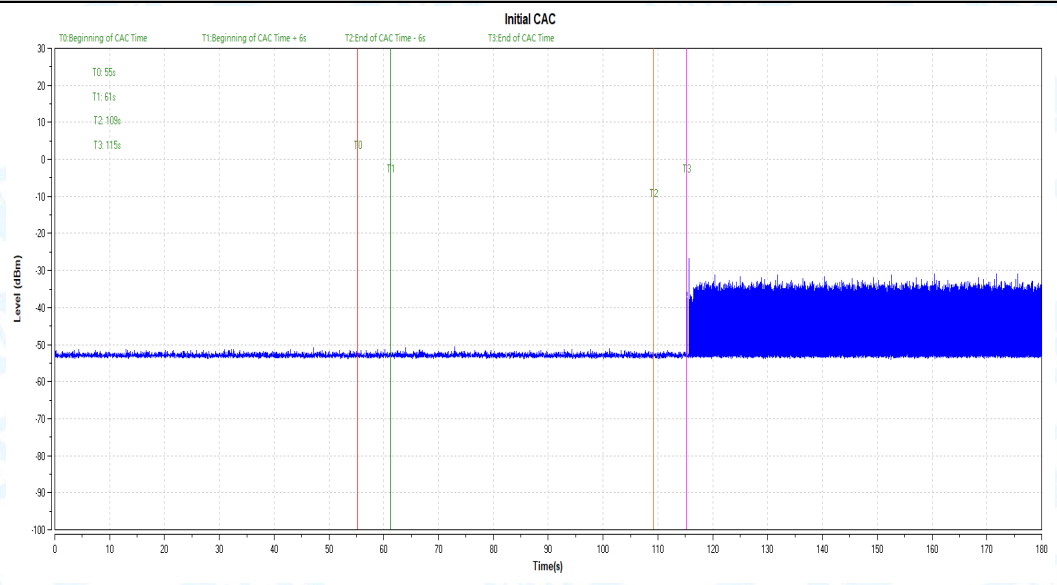

11AX80_5290

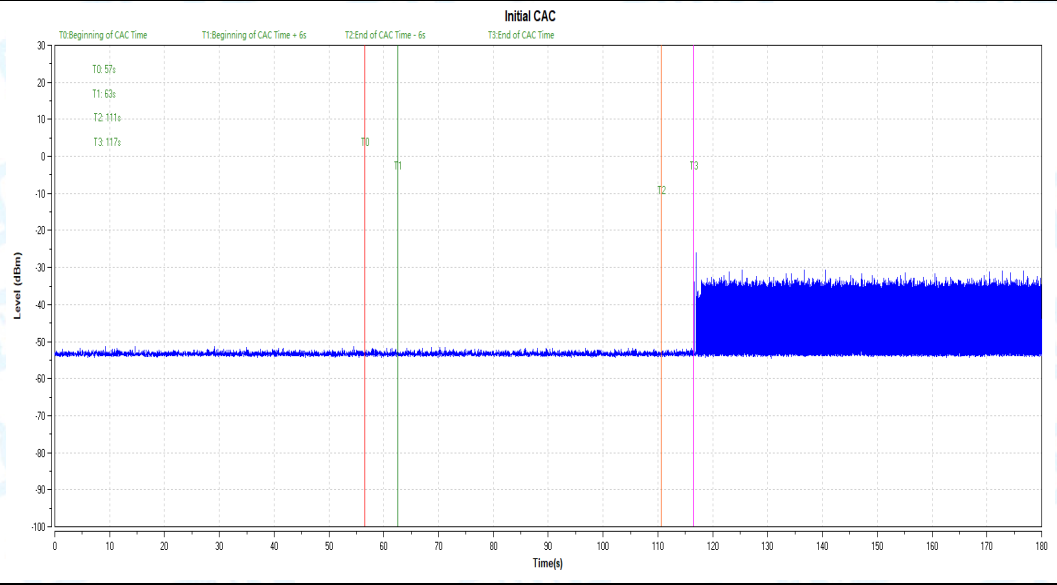

11AX80_5530

Beginning of Channel Availability Check Time

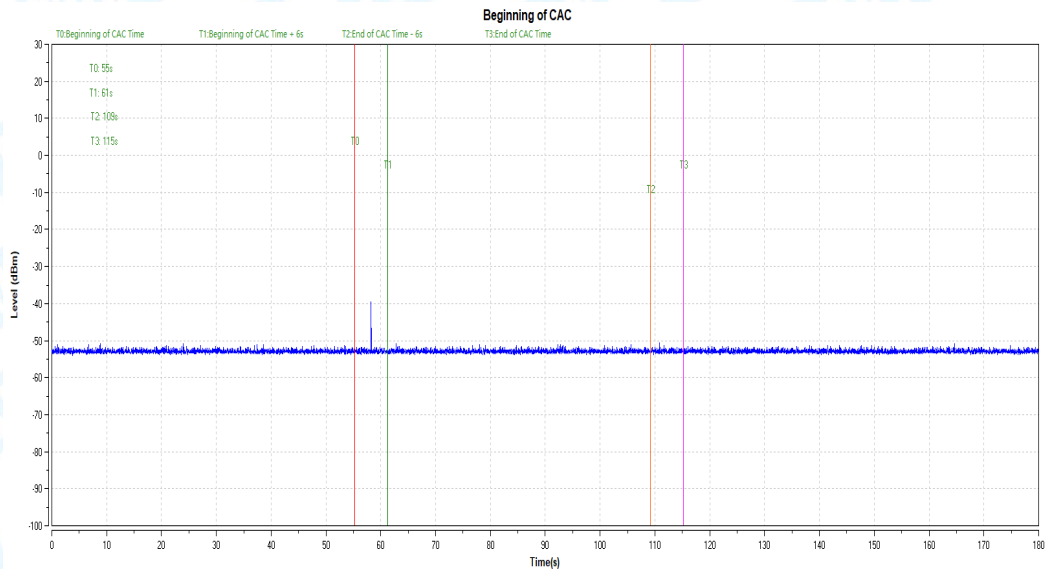

11AX80_5290

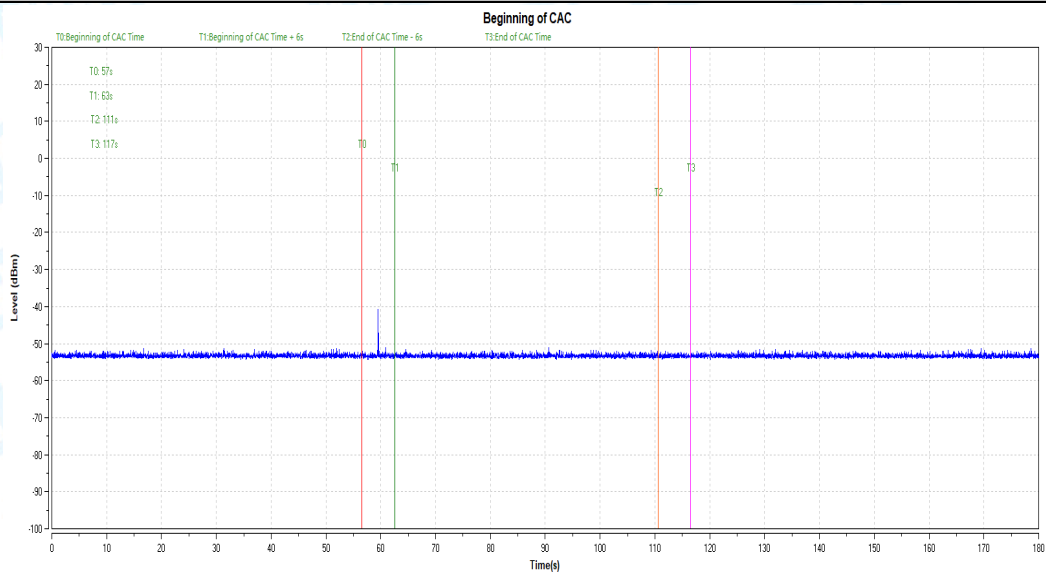

11AX80_5530

End of Channel Availability Check Time

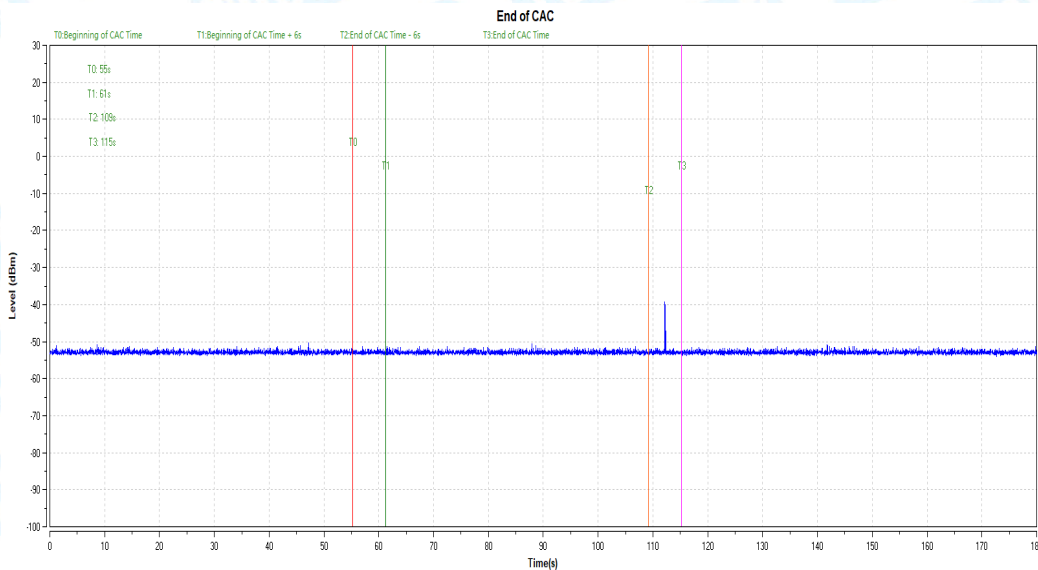

11AX80_5290

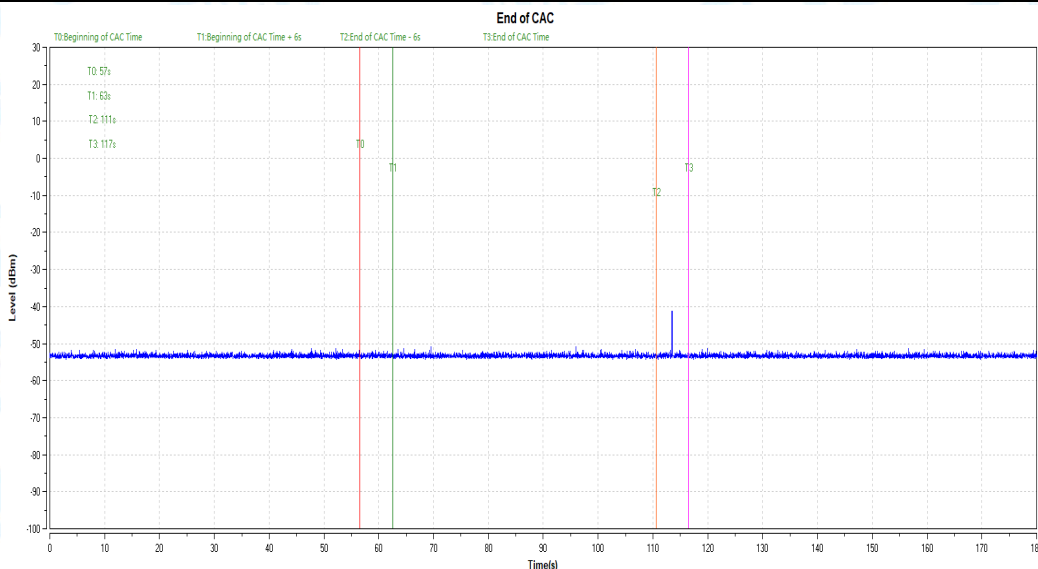

11AX80_5530

8.5. In-Service(Pd)

Test Result

TestMode	Frequency[MHz]	Radar Type	Pass Times	Fail Times	Probability (%)	Limit (%)	Verdict
11AX80	5290	Type1	27	3	90.00	60	PASS
		Type2	27	3	90.00	60	PASS
		Type3	26	4	86.67	60	PASS
		Type4	28	2	93.33	60	PASS
		Type 1-4	---	---	90.00	80	PASS
		Type5	25	5	83.33	80	PASS
11AX80	5530	Type1	26	4	86.67	60	PASS
		Type2	27	3	90.00	60	PASS
		Type3	27	3	90.00	60	PASS
		Type4	28	2	93.33	60	PASS
		Type 1-4	---	---	90.00	80	PASS
		Type5	27	3	90.00	80	PASS
		Type6	28	2	93.33	70	PASS

Test Mode	Frequency [MHz]	Radar Type	Trial ID	Pulse width(μs)	PRI(μs)	Pulses per Burst	Detection (1: Yes; 0: No)
11AX80	5290	Type1	0	1.0	938.0	57	1
		Type1	1	1.0	698.0	76	1
		Type1	2	1.0	618.0	86	1
		Type1	3	1.0	538.0	99	1
		Type1	4	1.0	878.0	61	1
		Type1	5	1.0	3066.0	18	1
		Type1	6	1.0	638.0	83	1
		Type1	7	1.0	918.0	58	1
		Type1	8	1.0	838.0	63	1
		Type1	9	1.0	858.0	62	1
		Type1	10	1.0	798.0	67	1
		Type1	11	1.0	718.0	74	1
		Type1	12	1.0	578.0	92	1
		Type1	13	1.0	598.0	89	1
		Type1	14	1.0	558.0	95	1
		Type1	15	1.0	2536.0	21	1
		Type1	16	1.0	966.0	55	1
		Type1	17	1.0	827.0	64	1
		Type1	18	1.0	2501.0	22	1
		Type1	19	1.0	2595.0	21	1
		Type1	20	1.0	1114.0	48	1
		Type1	21	1.0	1302.0	41	0
		Type1	22	1.0	3045.0	18	1
		Type1	23	1.0	1624.0	33	0
		Type1	24	1.0	2878.0	19	1
		Type1	25	1.0	1027.0	52	1
		Type1	26	1.0	2485.0	22	0
		Type1	27	1.0	1600.0	33	1
		Type1	28	1.0	1172.0	46	1
		Type1	29	1.0	1177.0	45	1
		Type2	0	3.2	179.0	26	1
		Type2	1	1.1	207.0	23	1
		Type2	2	2.1	230.0	24	1
		Type2	3	4.8	200.0	29	1
		Type2	4	3.9	214.0	28	1
		Type2	5	2.9	222.0	26	1
		Type2	6	3.2	204.0	26	0
		Type2	7	2.5	192.0	25	1
		Type2	8	3.1	164.0	26	1
		Type2	9	1.2	156.0	23	0
		Type2	10	3.9	210.0	27	1
		Type2	11	4.6	201.0	29	1
		Type2	12	3.2	162.0	26	1
		Type2	13	2.2	197.0	25	1
		Type2	14	4.5	163.0	29	1
		Type2	15	3.0	203.0	26	0
Type2	16	5.0	168.0	29	1		
Type2	17	2.4	217.0	25	1		
Type2	18	2.9	191.0	26	1		
Type2	19	2.3	166.0	25	1		
Type2	20	3.7	150.0	27	1		
Type2	21	2.2	176.0	25	1		
Type2	22	4.9	195.0	29	1		

Type2	23	2.9	202.0	26	1
Type2	24	2.5	178.0	25	1
Type2	25	1.1	206.0	23	1
Type2	26	3.8	155.0	27	1
Type2	27	4.7	157.0	29	1
Type2	28	2.4	224.0	25	1
Type2	29	4.2	159.0	28	1
Type3	0	8.2	355.0	17	1
Type3	1	6.1	487.0	16	1
Type3	2	7.1	344.0	16	1
Type3	3	9.8	288.0	18	0
Type3	4	8.9	230.0	18	1
Type3	5	7.9	432.0	17	1
Type3	6	8.2	207.0	17	1
Type3	7	7.5	443.0	17	1
Type3	8	8.1	439.0	17	1
Type3	9	6.2	223.0	16	1
Type3	10	8.9	208.0	18	1
Type3	11	9.6	463.0	18	1
Type3	12	8.2	441.0	17	1
Type3	13	7.2	323.0	16	1
Type3	14	9.5	297.0	18	1
Type3	15	8.0	412.0	17	1
Type3	16	10.0	324.0	18	1
Type3	17	7.4	271.0	17	0
Type3	18	7.9	349.0	17	1
Type3	19	7.3	409.0	16	1
Type3	20	8.7	373.0	18	0
Type3	21	7.2	254.0	16	0
Type3	22	9.9	274.0	18	1
Type3	23	7.9	278.0	17	1
Type3	24	7.5	317.0	17	1
Type3	25	6.1	260.0	16	1
Type3	26	8.8	211.0	18	1
Type3	27	9.7	272.0	18	1
Type3	28	7.4	264.0	17	1
Type3	29	9.2	284.0	18	1
Type4	0	16.0	355.0	14	1
Type4	1	11.3	487.0	12	1
Type4	2	13.5	344.0	13	1
Type4	3	19.4	288.0	16	1
Type4	4	17.5	230.0	15	1
Type4	5	15.3	432.0	14	1
Type4	6	15.9	207.0	14	1
Type4	7	14.3	443.0	13	1
Type4	8	15.8	439.0	14	1
Type4	9	11.5	223.0	12	1
Type4	10	17.4	208.0	15	1
Type4	11	19.0	463.0	16	1
Type4	12	16.0	441.0	14	1
Type4	13	13.8	323.0	13	1
Type4	14	18.9	297.0	16	1
Type4	15	15.5	412.0	14	1
Type4	16	19.9	324.0	16	1
Type4	17	14.1	271.0	13	1
Type4	18	15.2	349.0	14	1

	Type4	19	13.8	409.0	13	1
	Type4	20	17.1	373.0	15	1
	Type4	21	13.8	254.0	13	1
	Type4	22	19.8	274.0	16	1
	Type4	23	15.3	278.0	14	0
	Type4	24	14.5	317.0	13	1
	Type4	25	11.3	260.0	12	1
	Type4	26	17.3	211.0	15	0
	Type4	27	19.2	272.0	16	1
	Type4	28	14.2	264.0	13	1
	Type4	29	18.2	284.0	15	1

TestMode	Frequency [MHz]	Radar Type	Trial ID	Number Of Bursts	Waveform Length (s)	Radar Frequency	Detection (1: Yes; 0: No)
AX80	5290	Type5	0	15	12	5290	1
		Type5	1	8	12	5290	1
		Type5	2	11	12	5290	1
		Type5	3	20	12	5290	1
		Type5	4	17	12	5290	0
		Type5	5	14	12	5290	1
		Type5	6	15	12	5290	1
		Type5	7	12	12	5290	1
		Type5	8	14	12	5290	1
		Type5	9	8	12	5290	1
		Type5	10	17	12	5258.736	0
		Type5	11	19	12	5259.936	1
		Type5	12	15	12	5257.536	1
		Type5	13	12	12	5256.336	1
		Type5	14	19	12	5259.536	1
		Type5	15	14	12	5257.136	0
		Type5	16	20	12	5260.336	1
		Type5	17	12	12	5256.336	1
		Type5	18	14	12	5257.136	1
		Type5	19	12	12	5256.336	1
		Type5	20	16	12	5321.664	1
		Type5	21	12	12	5324.064	1
		Type5	22	20	12	5319.664	1
		Type5	23	14	12	5322.864	1
		Type5	24	13	12	5323.264	1
		Type5	25	8	12	5325.664	0
		Type5	26	17	12	5321.264	1
		Type5	27	19	12	5320.064	1
		Type5	28	12	12	5323.664	1
Type5	29	18	12	5320.864	0		

TestMode	Frequency[M Hz]	Radar Type	Trial ID	Pulse width (μs)	PRI (μs)	Pulses per Hop	Detection (1: Yes; 0: No)
11AX80	5290	Type6	0	1	333.3	9	1
		Type6	1	1	333.3	9	1
		Type6	2	1	333.3	9	1
		Type6	3	1	333.3	9	1
		Type6	4	1	333.3	9	1
		Type6	5	1	333.3	9	1
		Type6	6	1	333.3	9	1
		Type6	7	1	333.3	9	0
		Type6	8	1	333.3	9	1
		Type6	9	1	333.3	9	1
		Type6	10	1	333.3	9	1
		Type6	11	1	333.3	9	1
		Type6	12	1	333.3	9	1
		Type6	13	1	333.3	9	1
		Type6	14	1	333.3	9	1
		Type6	15	1	333.3	9	1
		Type6	16	1	333.3	9	1
		Type6	17	1	333.3	9	1
		Type6	18	1	333.3	9	1
		Type6	19	1	333.3	9	1
		Type6	20	1	333.3	9	1
		Type6	21	1	333.3	9	1
		Type6	22	1	333.3	9	1
		Type6	23	1	333.3	9	1
		Type6	24	1	333.3	9	1
		Type6	25	1	333.3	9	1
		Type6	26	1	333.3	9	1
		Type6	27	1	333.3	9	1
		Type6	28	1	333.3	9	1
Type6	29	1	333.3	9	1		

Test Mode	Frequency [MHz]	Radar Type	Trial ID	Pulse width(μs)	PRI(μs)	Pulses per Burst	Detection (1: Yes; 0: No)
11AX80	5530	Type1	0	1.0	938.0	57	1
		Type1	1	1.0	698.0	76	1
		Type1	2	1.0	618.0	86	1
		Type1	3	1.0	538.0	99	0
		Type1	4	1.0	878.0	61	1
		Type1	5	1.0	3066.0	18	1
		Type1	6	1.0	638.0	83	1
		Type1	7	1.0	918.0	58	1
		Type1	8	1.0	838.0	63	0
		Type1	9	1.0	858.0	62	1
		Type1	10	1.0	798.0	67	1
		Type1	11	1.0	718.0	74	1
		Type1	12	1.0	578.0	92	1
		Type1	13	1.0	598.0	89	0
		Type1	14	1.0	558.0	95	1
		Type1	15	1.0	2536.0	21	0
		Type1	16	1.0	966.0	55	1
		Type1	17	1.0	827.0	64	1
		Type1	18	1.0	2501.0	22	1
		Type1	19	1.0	2595.0	21	1
		Type1	20	1.0	1114.0	48	1
		Type1	21	1.0	1302.0	41	1
		Type1	22	1.0	3045.0	18	1
		Type1	23	1.0	1624.0	33	1
		Type1	24	1.0	2878.0	19	1
		Type1	25	1.0	1027.0	52	1
		Type1	26	1.0	2485.0	22	1
		Type1	27	1.0	1600.0	33	1
		Type1	28	1.0	1172.0	46	1
		Type1	29	1.0	1177.0	45	1
		Type2	0	3.2	179.0	26	1
		Type2	1	1.1	207.0	23	1
		Type2	2	2.1	230.0	24	1
		Type2	3	4.8	200.0	29	1
		Type2	4	3.9	214.0	28	0
		Type2	5	2.9	222.0	26	1
		Type2	6	3.2	204.0	26	1
		Type2	7	2.5	192.0	25	0
		Type2	8	3.1	164.0	26	1
		Type2	9	1.2	156.0	23	1
		Type2	10	3.9	210.0	27	1
		Type2	11	4.6	201.0	29	1
		Type2	12	3.2	162.0	26	0
		Type2	13	2.2	197.0	25	1
		Type2	14	4.5	163.0	29	1
		Type2	15	3.0	203.0	26	1
Type2	16	5.0	168.0	29	1		
Type2	17	2.4	217.0	25	1		
Type2	18	2.9	191.0	26	1		
Type2	19	2.3	166.0	25	1		
Type2	20	3.7	150.0	27	1		
Type2	21	2.2	176.0	25	1		
Type2	22	4.9	195.0	29	1		
Type2	23	2.9	202.0	26	1		

Type2	24	2.5	178.0	25	1
Type2	25	1.1	206.0	23	1
Type2	26	3.8	155.0	27	1
Type2	27	4.7	157.0	29	1
Type2	28	2.4	224.0	25	1
Type2	29	4.2	159.0	28	1
Type3	0	8.2	355.0	17	1
Type3	1	6.1	487.0	16	1
Type3	2	7.1	344.0	16	1
Type3	3	9.8	288.0	18	1
Type3	4	8.9	230.0	18	0
Type3	5	7.9	432.0	17	1
Type3	6	8.2	207.0	17	1
Type3	7	7.5	443.0	17	0
Type3	8	8.1	439.0	17	1
Type3	9	6.2	223.0	16	1
Type3	10	8.9	208.0	18	0
Type3	11	9.6	463.0	18	1
Type3	12	8.2	441.0	17	1
Type3	13	7.2	323.0	16	1
Type3	14	9.5	297.0	18	1
Type3	15	8.0	412.0	17	1
Type3	16	10.0	324.0	18	1
Type3	17	7.4	271.0	17	1
Type3	18	7.9	349.0	17	1
Type3	19	7.3	409.0	16	1
Type3	20	8.7	373.0	18	1
Type3	21	7.2	254.0	16	1
Type3	22	9.9	274.0	18	1
Type3	23	7.9	278.0	17	1
Type3	24	7.5	317.0	17	1
Type3	25	6.1	260.0	16	1
Type3	26	8.8	211.0	18	1
Type3	27	9.7	272.0	18	1
Type3	28	7.4	264.0	17	1
Type3	29	9.2	284.0	18	1
Type4	0	16.0	355.0	14	1
Type4	1	11.3	487.0	12	1
Type4	2	13.5	344.0	13	1
Type4	3	19.4	288.0	16	1
Type4	4	17.5	230.0	15	1
Type4	5	15.3	432.0	14	1
Type4	6	15.9	207.0	14	1
Type4	7	14.3	443.0	13	1
Type4	8	15.8	439.0	14	0
Type4	9	11.5	223.0	12	1
Type4	10	17.4	208.0	15	1
Type4	11	19.0	463.0	16	1
Type4	12	16.0	441.0	14	1
Type4	13	13.8	323.0	13	0
Type4	14	18.9	297.0	16	1
Type4	15	15.5	412.0	14	1
Type4	16	19.9	324.0	16	1
Type4	17	14.1	271.0	13	1
Type4	18	15.2	349.0	14	1
Type4	19	13.8	409.0	13	1

	Type4	20	17.1	373.0	15	1
	Type4	21	13.8	254.0	13	1
	Type4	22	19.8	274.0	16	1
	Type4	23	15.3	278.0	14	1
	Type4	24	14.5	317.0	13	1
	Type4	25	11.3	260.0	12	1
	Type4	26	17.3	211.0	15	1
	Type4	27	19.2	272.0	16	1
	Type4	28	14.2	264.0	13	1
	Type4	29	18.2	284.0	15	1

TestMode	Frequency [MHz]	Radar Type	Trial ID	Number Of Bursts	Waveform Length (s)	Radar Frequency	Detection (1: Yes; 0: No)
AX80	5530	Type5	0	15	12	5290	1
		Type5	1	8	12	5290	1
		Type5	2	11	12	5290	1
		Type5	3	20	12	5290	0
		Type5	4	17	12	5290	1
		Type5	5	14	12	5290	1
		Type5	6	15	12	5290	1
		Type5	7	12	12	5290	1
		Type5	8	14	12	5290	1
		Type5	9	8	12	5290	1
		Type5	10	17	12	5258.736	1
		Type5	11	19	12	5259.936	1
		Type5	12	15	12	5257.536	1
		Type5	13	12	12	5256.336	1
		Type5	14	19	12	5259.536	1
		Type5	15	14	12	5257.136	1
		Type5	16	20	12	5260.336	1
		Type5	17	12	12	5256.336	1
		Type5	18	14	12	5257.136	1
		Type5	19	12	12	5256.336	0
		Type5	20	16	12	5321.664	1
		Type5	21	12	12	5324.064	1
		Type5	22	20	12	5319.664	1
		Type5	23	14	12	5322.864	1
		Type5	24	13	12	5323.264	1
		Type5	25	8	12	5325.664	0
		Type5	26	17	12	5321.264	1
		Type5	27	19	12	5320.064	1
		Type5	28	12	12	5323.664	1
Type5	29	18	12	5320.864	1		

Test Mode	Frequency [MHz]	Radar Type	Trial ID	Pulse width (µs)	PRI (µs)	Pulses per Hop	Detection (1: Yes; 0: No)
11AX80	5530	Type6	0	1	333.3	9	1
		Type6	1	1	333.3	9	1
		Type6	2	1	333.3	9	1
		Type6	3	1	333.3	9	1
		Type6	4	1	333.3	9	1
		Type6	5	1	333.3	9	1
		Type6	6	1	333.3	9	1
		Type6	7	1	333.3	9	1
		Type6	8	1	333.3	9	1
		Type6	9	1	333.3	9	1
		Type6	10	1	333.3	9	1
		Type6	11	1	333.3	9	1
		Type6	12	1	333.3	9	1
		Type6	13	1	333.3	9	1
		Type6	14	1	333.3	9	1
		Type6	15	1	333.3	9	1
		Type6	16	1	333.3	9	1
		Type6	17	1	333.3	9	1
		Type6	18	1	333.3	9	1
		Type6	19	1	333.3	9	1
		Type6	20	1	333.3	9	0
		Type6	21	1	333.3	9	1
		Type6	22	1	333.3	9	1
		Type6	23	1	333.3	9	1
		Type6	24	1	333.3	9	1
		Type6	25	1	333.3	9	1
		Type6	26	1	333.3	9	1
		Type6	27	1	333.3	9	0
		Type6	28	1	333.3	9	1
		Type6	29	1	333.3	9	1

8.6. Channel Move Time and Channel Closing Transmission Time

Test Mode	Frequency[MHz]	CCTT[ms]	Limit[ms]	CMT[ms]	Limit[ms]	Verdict
11AX80	5290	200+36.4	200+60	1330.9	10000	PASS
	5530	200+14.3	200+60	1035.8	10000	PASS

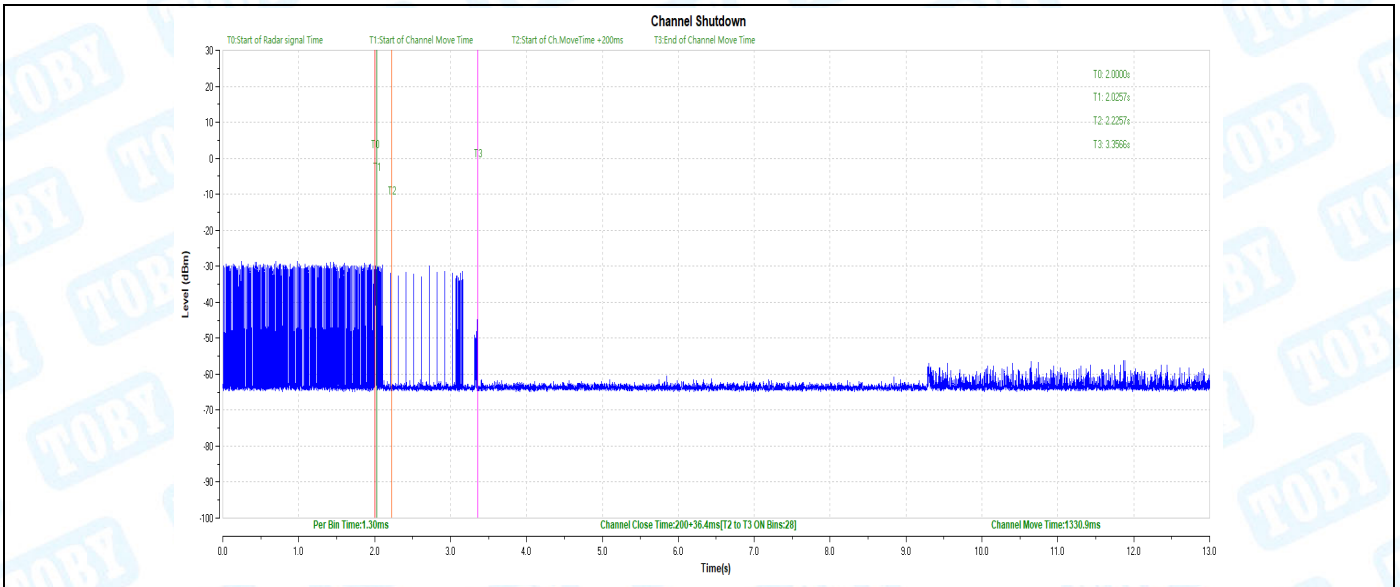

11AX80_5290

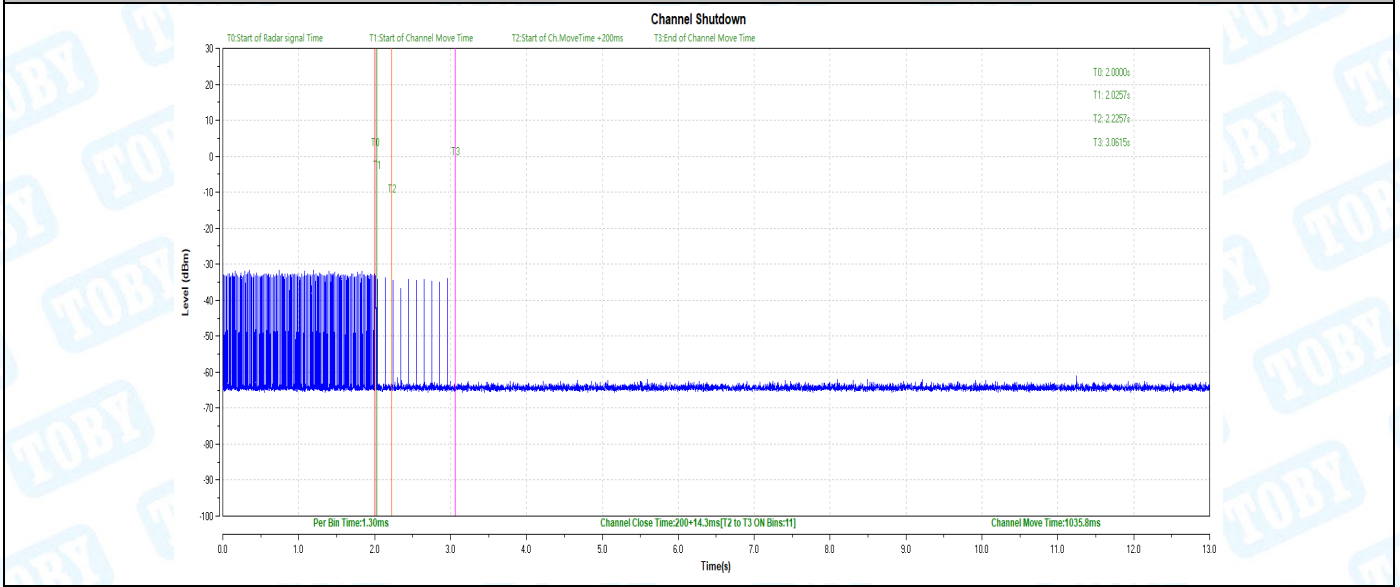

11AX80_5530

8.7. Non-occupancy Period

During the 30 minutes observation time, UUT did not make any transmissions on a channel after a radar signal was detected on that channel by either the Channel Availability Check or the In-Service Monitoring.

Non-Occupancy Period Result				
Modulation Mode	Freq. (MHz)	Non-Occupancy Period		
		Measured	Limit	Result
AX80	5290	>30min	30min	Complied
	5530	>30min	30min	Complied

11ax 80MHz Mode 5290MHz

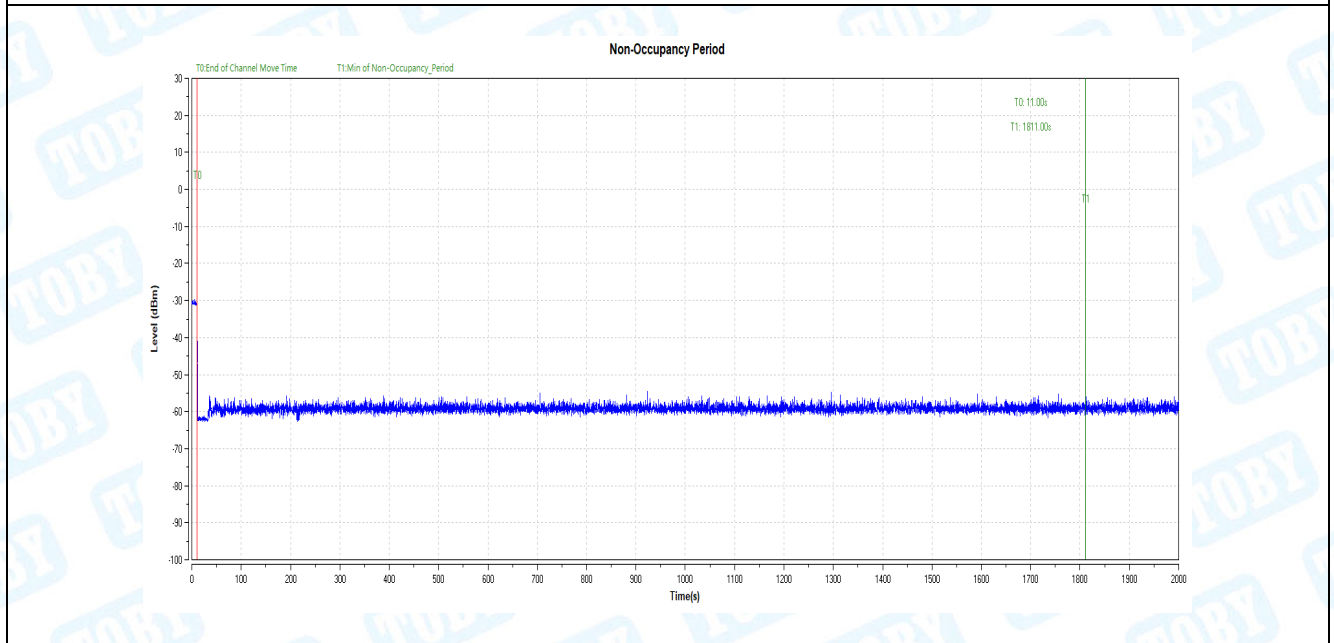

11ax 80MHz Mode 5530MHz

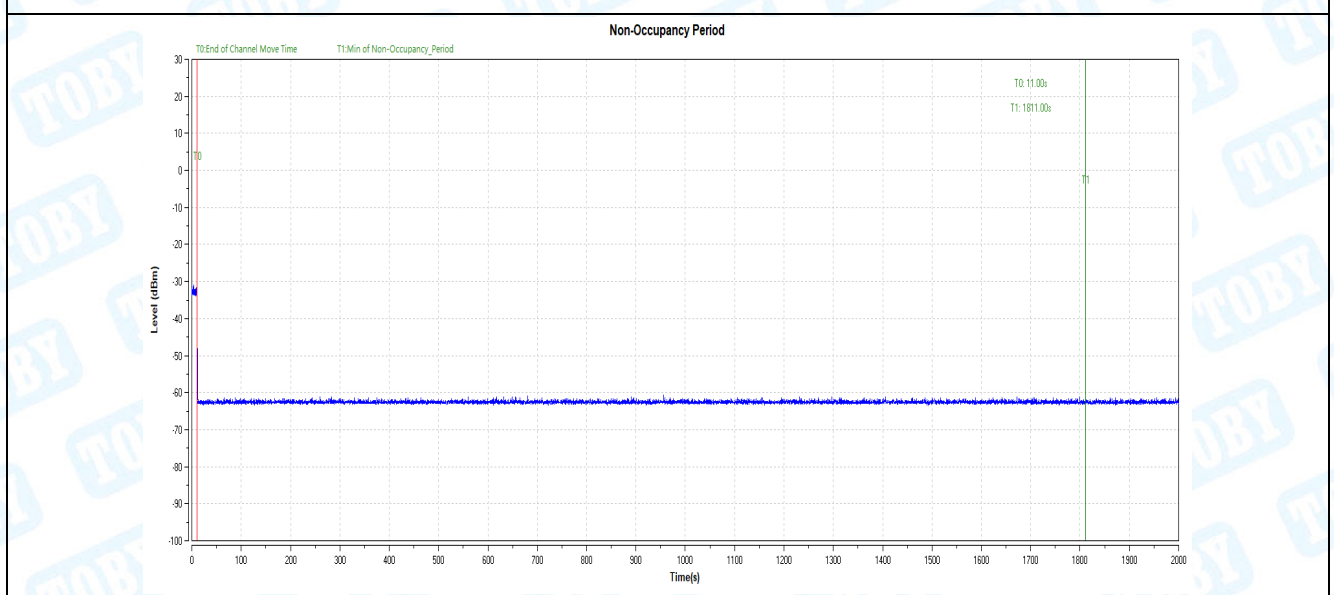

8.8. Uniform Spreading

The intention of the uniform spreading is to provide, on aggregate, a uniform loading of the spectrum. The UUT using the bands 5250 to 5350MHz and 5470 to 5600 MHz channels so that the probability of selecting a given channel shall be the same for channels. The UUT will select channel by random mode and remember this channel when detect radar signal, so that will select unused channel by random mode.

8.9. U-NII Detection Bandwidth

Test Result

Test Mode	Frequency [MHz]	FL[MHz]	FH[MHz]	Detection Bandwidth [MHz]	OCB [MHz]	Ratio [%]	Limit [%]	Verdict
11A	5260	5251	5269	18	16.852	106.81	≥100	PASS
11A	5500	5491	5509	18	16.520	106.81	≥100	PASS
11N40	5270	5251	5289	38	36.048	105.42	≥100	PASS
11 N40	5510	5529	5491	38	35.896	105.86	≥100	PASS
11AX80	5290	5251	5329	78	75.328	103.55	≥100	PASS
11AX80	5530	5491	5569	78	75.488	103.33	≥100	PASS

Test Mode	Frequency [MHz]	Radar Freq.	Trial 1	Trial 2	Trial 3	Trial 4	Trial 5	Trial 6	Trial 7	Trial 8	Trial 9	Trial 10	Ratio (%)	
11A	5260	5250	0	0	0	0	0	0	0	0	0	0	0	
		5251	1	1	1	1	1	1	1	1	0	1	1	90
		5252	1	1	1	1	1	1	1	1	1	1	1	100
		5253	1	1	1	1	1	1	1	1	1	1	1	100
		5254	1	1	1	1	1	1	1	1	1	1	1	100
		5255	1	1	1	1	1	1	1	1	1	1	1	100
		5260	1	1	1	1	1	1	1	1	1	1	1	100
		5265	1	1	1	1	1	1	1	1	1	1	1	100
		5266	1	1	1	1	1	1	1	1	1	1	1	100
		5267	1	1	1	1	1	1	1	1	1	1	1	100
		5268	1	1	1	1	1	1	1	1	1	1	1	100
		5269	1	1	1	0	1	1	1	1	1	1	1	90
	5270	0	0	0	0	0	0	0	0	0	0	0	0	
	5500	5490	0	0	0	0	0	0	0	0	0	0	0	0
		5491	1	1	1	1	1	1	1	1	0	1	1	90
		5492	1	1	1	1	1	1	1	1	1	1	1	100
		5493	1	1	1	1	1	1	1	1	1	1	1	100
		5494	1	1	1	1	1	1	1	1	1	1	1	100
		5495	1	1	1	1	1	1	1	1	1	1	1	100
		5500	1	1	1	1	1	1	1	1	1	1	1	100
		5505	1	1	1	1	1	1	1	1	1	1	1	100
		5506	1	1	1	1	1	1	1	1	1	1	1	100
		5507	1	1	1	1	1	1	1	1	1	1	1	100
5508		1	1	1	1	1	1	1	1	1	1	1	100	
5509	1	1	0	1	1	1	1	1	1	1	1	90		
5510	0	0	0	0	0	0	0	0	0	0	0	0		

Test Mode	Frequency [MHz]	Radar Freq.	Trial 1	Trial 2	Trial 3	Trial 4	Trial 5	Trial 6	Trial 7	Trial 8	Trial 9	Trial 10	Ratio (%)	
11N40	5270	5250	0	0	0	0	0	0	0	0	0	0	0	
		5251	1	1	1	1	1	1	1	1	0	1	1	90
		5252	1	1	1	1	1	1	1	1	1	1	1	100
		5253	1	1	1	1	1	1	1	1	1	1	1	100
		5254	1	1	1	1	1	1	1	1	1	1	1	100
		5255	1	1	1	1	1	1	1	1	1	1	1	100
		5260	1	1	1	1	1	1	1	1	1	1	1	100
		5265	1	1	1	1	1	1	1	1	1	1	1	100
		5270	1	1	1	1	1	1	1	1	1	1	1	100
		5275	1	1	1	1	1	1	1	1	1	1	1	100
		5280	1	1	1	1	1	1	1	1	1	1	1	100
		5285	1	1	1	1	1	1	1	1	1	1	1	100
		5286	1	1	1	1	1	1	1	1	1	1	1	100
		5287	1	1	1	1	1	1	1	1	1	1	1	100
		5288	1	1	1	1	1	1	1	1	1	1	1	100
	5289	1	1	1	1	1	1	1	1	1	0	1	90	
	5290	0	0	0	0	0	0	0	0	0	0	0	0	
	5510	5490	0	0	0	0	0	0	0	0	0	0	0	0
		5491	1	1	1	0	1	1	1	1	1	1	1	90
		5492	1	1	1	1	1	1	1	1	1	1	1	100
		5493	1	1	1	1	1	1	1	1	1	1	1	100
		5494	1	1	1	1	1	1	1	1	1	1	1	100
		5495	1	1	1	1	1	1	1	1	1	1	1	100
		5500	1	1	1	1	1	1	1	1	1	1	1	100
		5505	1	1	1	1	1	1	1	1	1	1	1	100
		5510	1	1	1	1	1	1	1	1	1	1	1	100
		5515	1	1	1	1	1	1	1	1	1	1	1	100
		5520	1	1	1	1	1	1	1	1	1	1	1	100
		5525	1	1	1	1	1	1	1	1	1	1	1	100
		5526	1	1	1	1	1	1	1	1	1	1	1	100
5527		1	1	1	1	1	1	1	1	1	1	1	100	
5528		1	1	1	1	1	1	1	1	1	1	1	100	
5529	1	1	1	1	1	1	1	1	1	0	1	90		
5520	0	0	0	0	0	0	0	0	0	0	0	0		

Test Mode	Frequency [MHz]	Radar Freq.	Trial 1	Trial 2	Trial 3	Trial 4	Trial 5	Trial 6	Trial 7	Trial 8	Trial 9	Trial 10	Ratio (%)	
11AX80	5290	5250	0	0	0	0	0	0	0	0	0	0	0	
		5251	1	0	1	1	1	1	1	1	1	1	1	90
		5252	1	1	1	1	1	1	1	1	1	1	1	100
		5253	1	1	1	1	1	1	1	1	1	1	1	100
		5254	1	1	1	1	1	1	1	1	1	1	1	100
		5255	1	1	1	1	1	1	1	1	1	1	1	100
		5260	1	1	1	1	1	1	1	1	1	1	1	100
		5265	1	1	1	1	1	1	1	1	1	1	1	100
		5270	1	1	1	1	1	1	1	1	1	1	1	100
		5275	1	1	1	1	1	1	1	1	1	1	1	100
		5280	1	1	1	1	1	1	1	1	1	1	1	100
		5285	1	1	1	1	1	1	1	1	1	1	1	100
		5290	1	1	1	1	1	1	1	1	1	1	1	100
		5295	1	1	1	1	1	1	1	1	1	1	1	100
		5300	1	1	1	1	1	1	1	1	1	1	1	100
		5305	1	1	1	1	1	1	1	1	1	1	1	100
		5310	1	1	1	1	1	1	1	1	1	1	1	100
		5315	1	1	1	1	1	1	1	1	1	1	1	100
		5320	1	1	1	1	1	1	1	1	1	1	1	100
		5325	1	1	1	1	1	1	1	1	1	1	1	100
		5326	1	1	1	1	1	1	1	1	1	1	1	100
	5327	1	1	1	1	1	1	1	1	1	1	1	100	
	5328	1	1	1	1	1	1	1	1	1	1	1	100	
	5329	1	1	1	1	1	1	1	1	1	1	0	90	
	5330	0	0	0	0	0	0	0	0	0	0	0	0	
	5530	5490	0	0	0	0	0	0	0	0	0	0	0	0
		5491	1	0	1	1	1	1	1	1	1	1	1	90
		5492	1	1	1	1	1	1	1	1	1	1	1	100
		5493	1	1	1	1	1	1	1	1	1	1	1	100
		5494	1	1	1	1	1	1	1	1	1	1	1	100
		5495	1	1	1	1	1	1	1	1	1	1	1	100
		5500	1	1	1	1	1	1	1	1	1	1	1	100
		5505	1	1	1	1	1	1	1	1	1	1	1	100
5510		1	1	1	1	1	1	1	1	1	1	1	100	
5515		1	1	1	1	1	1	1	1	1	1	1	100	
5520		1	1	1	1	1	1	1	1	1	1	1	100	
5525		1	1	1	1	1	1	1	1	1	1	1	100	
5530	1	1	1	1	1	1	1	1	1	1	1	100		
5535	1	1	1	1	1	1	1	1	1	1	1	100		
5540	1	1	1	1	1	1	1	1	1	1	1	100		

	5545	1	1	1	1	1	1	1	1	1	1	1	100
	5550	1	1	1	1	1	1	1	1	1	1	1	100
	5555	1	1	1	1	1	1	1	1	1	1	1	100
	5560	1	1	1	1	1	1	1	1	1	1	1	100
	5565	1	1	1	1	1	1	1	1	1	1	1	100
	5566	1	1	1	1	1	1	1	1	1	1	1	100
	5567	1	1	1	1	1	1	1	1	1	1	1	100
	5568	1	1	1	1	1	1	1	1	1	1	1	100
	5569	1	1	1	1	1	0	1	1	1	1	1	90
	5560	0	0	0	0	0	0	0	0	0	0	0	0

Test Graphs

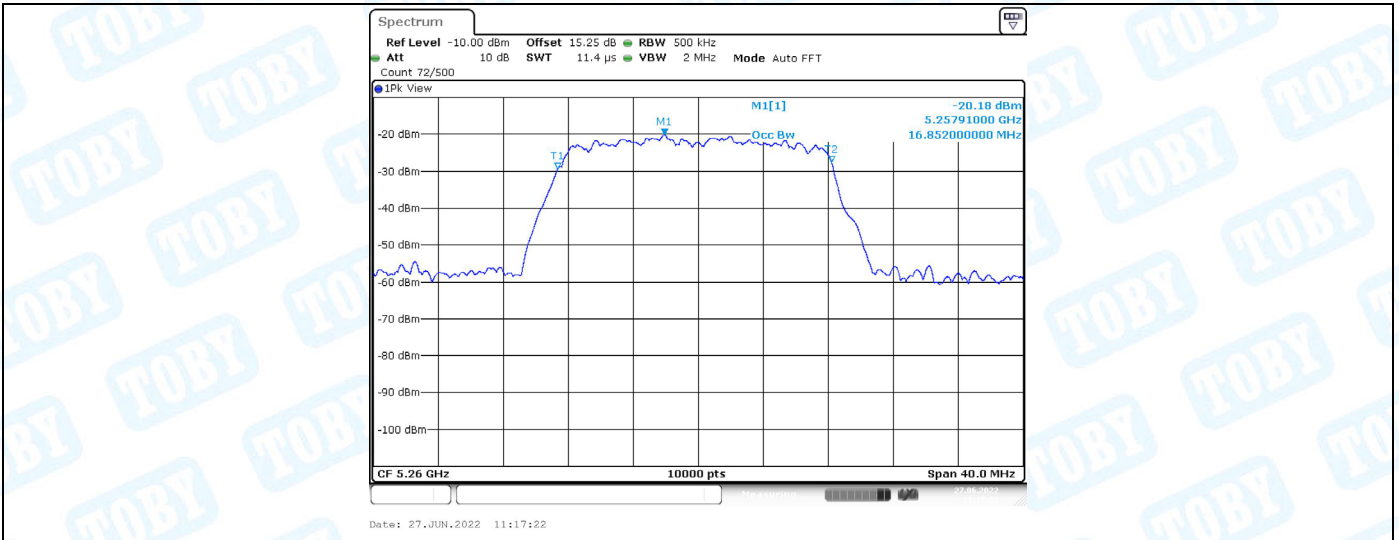

11A_5260

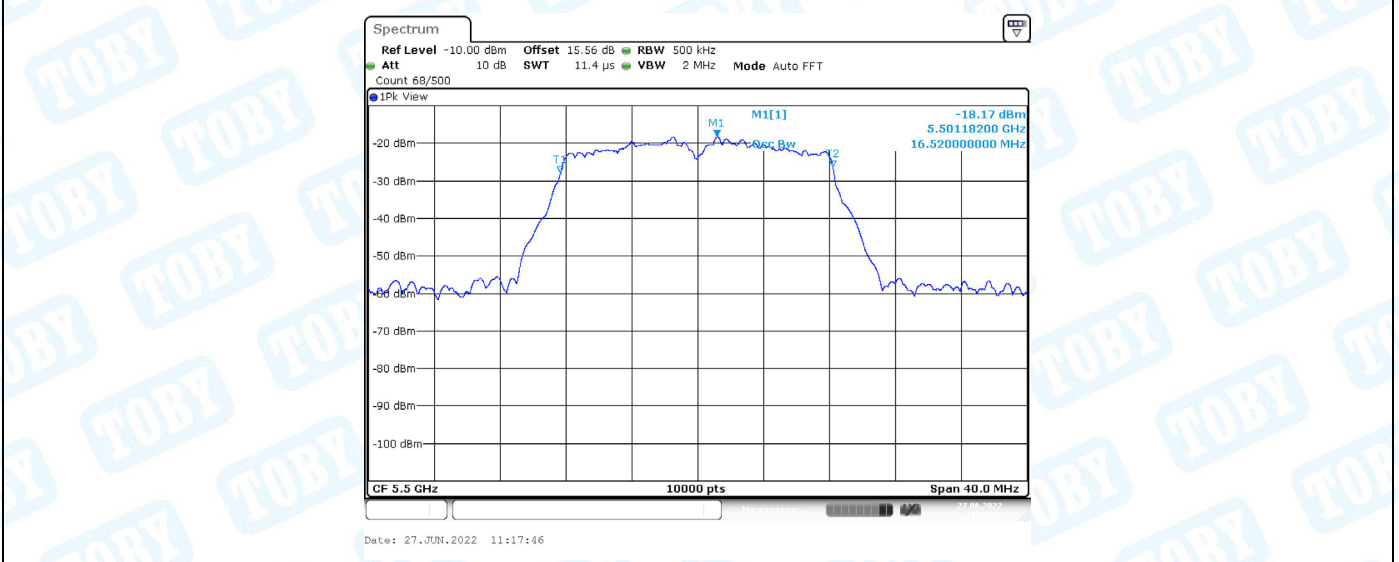

11A_5500

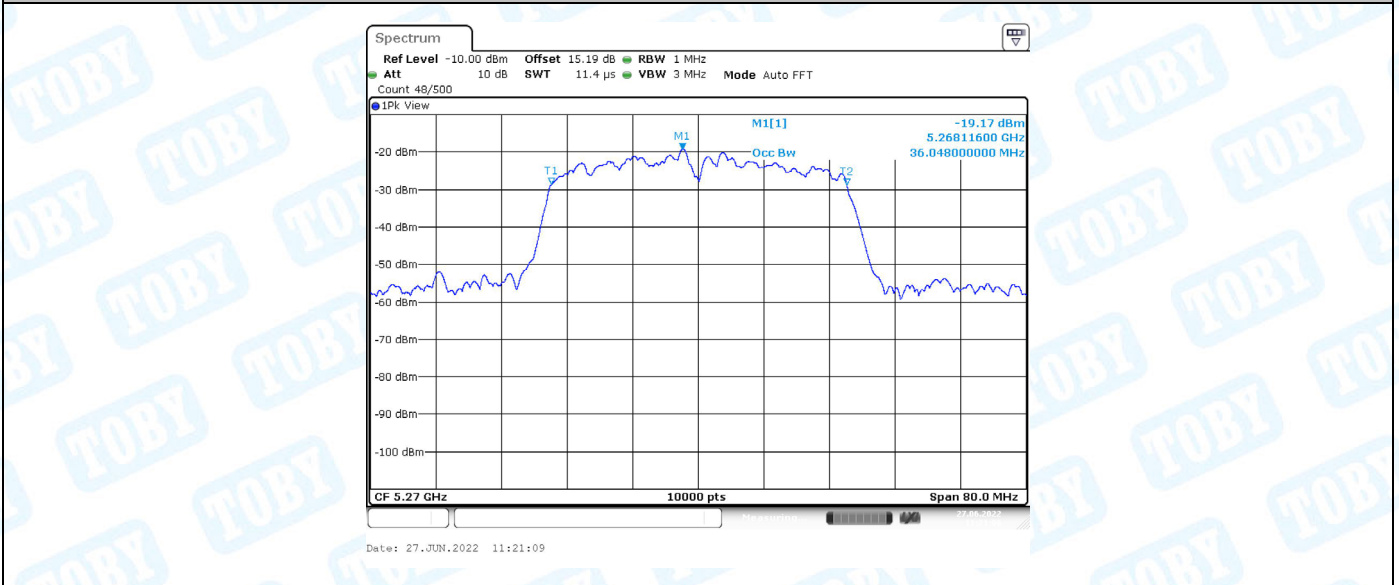

11N40_5270

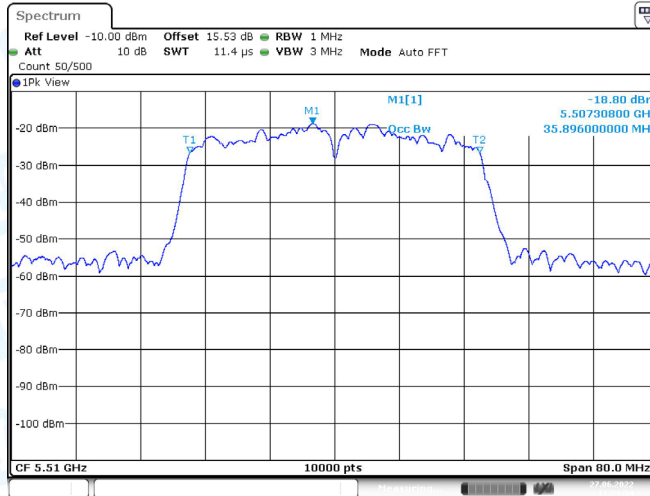

Date: 27 JUN 2022 11:21:35

11N40_5510

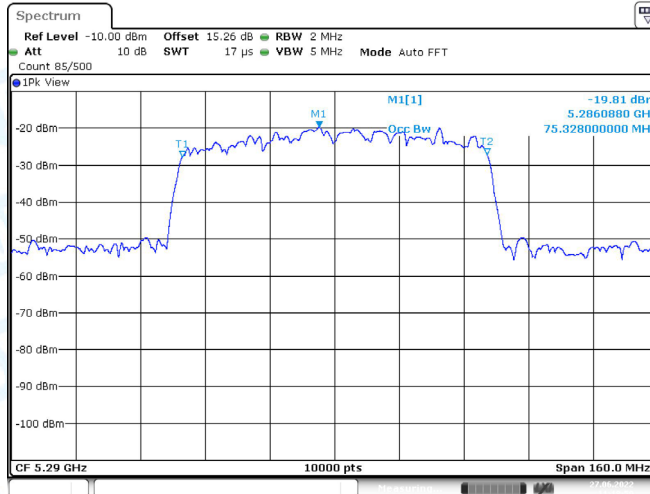

Date: 27 JUN 2022 11:18:59

11AX80_5290

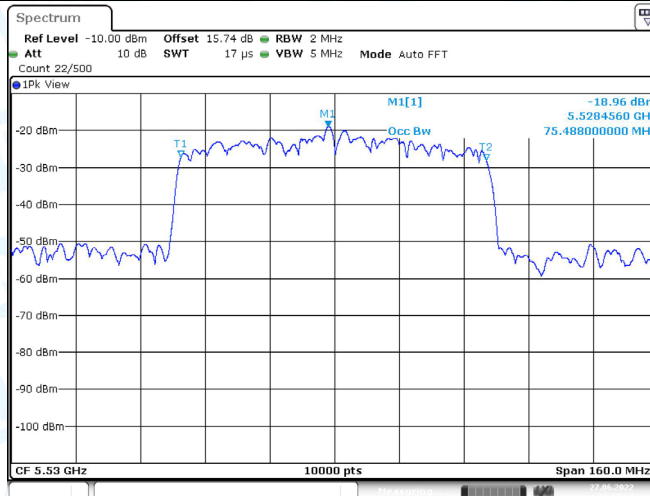

Date: 27 JUN 2022 11:19:25

11AX80_5530

----END OF REPORT----