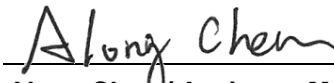

FCC Test Report

FCC ID : 2AAS9-BW1257
Equipment : Tri-Band Wi-Fi AC3000 Indoor Access Point
Model No. : BW1257
Brand Name : BROWAN
Applicant : BROWAN COMMUNICATIONS Co., Ltd.
Address : No.15-1, Zhoughua Rd, Hsinchu Industrial Park, Hukou, Hsinchu, Taiwan, R.O.C. 333
Standard : 47 CFR FCC Part 15.407
Received Date : Dec. 18, 2018
Tested Date : Dec. 24 ~ Apr. 03, 2019

We, International Certification Corp., would like to declare that the tested sample has been evaluated and in compliance with the requirement of the above standards. The test results contained in this report refer exclusively to the product. It may be duplicated completely for legal use with the approval of the applicant. It shall not be reproduced except in full without the written approval of our laboratory.

Reviewed by:

Along Chen / Assistant Manager

Approved by:

Gary Chang / Manager



Table of Contents

1	GENERAL DESCRIPTION	5
1.1	Information.....	5
1.2	Local Support Equipment List	8
1.3	Test Setup Chart	8
1.4	The Equipment List	12
1.5	Testing Applied Standards	14
1.6	Deviation from Test Standard and Measurement Procedure.....	14
1.7	Measurement Uncertainty	14
2	TEST CONFIGURATION.....	15
2.1	Testing Condition	15
2.2	The Worst Test Modes and Channel Details	15
3	TRANSMITTER TEST RESULTS	18
3.1	Conducted Emissions.....	18
3.2	Emission Bandwidth	35
3.3	RF Output Power.....	50
3.4	Peak Power Spectral Density.....	55
3.5	Transmitter Radiated and Band Edge Emissions	71
3.6	Frequency Stability.....	150
4	TEST LABORATORY INFORMATION	152

Release Record

Report No.	Version	Description	Issued Date
FR8D1801AN	Rev. 01	Initial issue	Jun. 19, 2019

Summary of Test Results

FCC Rules	Test Items	Measured	Result
15.207	Conducted Emissions	[dBuV]: 19.915MHz 48.48 (Margin -1.52dB) - AV	Pass
15.407(b) 15.209	Radiated Emissions	[dBuV/m at 3m]: 5150.00MHz 53.00 (Margin -1.00 dB) - AV	Pass
15.407(a)	Emission Bandwidth	Meet the requirement of limit	Pass
15.407(e)	6dB bandwidth	Meet the requirement of limit	Pass
15.407(a)	RF Output Power	Max Power [dBm]: Non-beamforming mode 5150-5250MHz: 25.11 5725-5850MHz: 29.88 Beamforming mode 5150-5250MHz: 24.29 5725-5850MHz: 25.07	Pass
15.407(a)	Peak Power Spectral Density	Meet the requirement of limit	Pass
15.407(g)	Frequency Stability	Meet the requirement of limit	Pass
15.203	Antenna Requirement	Meet the requirement of limit	Pass

Declaration of Conformity:

The test results with all measurement uncertainty excluded are presented in accordance with the regulation limits or requirements declared by manufacturers.

Comments and Explanations:

The declared values of gain for EUT presented in the report are provided by the manufacturer, and the manufacturer takes all the responsibilities for the accuracy of the gain.

1 General Description

1.1 Information

1.1.1 Specification of the Equipment under Test (EUT)

RF General Information					
Frequency Range (MHz)	IEEE Std. 802.11	Ch. Freq. (MHz)	Channel Number	Transmit Chains (N _{TX})	Data Rate / MCS
5150-5250	a	5180-5240	36-48 [4]	2	6-54 Mbps
5150-5250	n (HT20)	5180-5240	36-48 [4]	2	MCS 0-15
5150-5250	n (HT40)	5190-5230	38-46 [2]	2	MCS 0-15
5150-5250	ac (VHT20)	5180-5240	36-48 [4]	2	MCS 0-9
5150-5250	ac (VHT40)	5190-5230	38-46 [2]	2	MCS 0-9
5150-5250	ac (VHT80)	5210	42 [1]	2	MCS 0-9

Note 1: RF output power specifies that Maximum Conducted Output Power.
 Note 2: 802.11a/n/ac uses a combination of OFDM-BPSK, QPSK, 16QAM, 64QAM, 256QAM modulation.
 Note 3: 802.11ac supports beamforming function.

RF General Information					
Frequency Range (MHz)	IEEE Std. 802.11	Ch. Freq. (MHz)	Channel Number	Transmit Chains (N _{TX})	Data Rate / MCS
5725-5850	a	5745-5825	149-165 [5]	4	6-54 Mbps
5725-5850	n (HT20)	5745-5825	149-165 [5]	4	MCS 0-31
5725-5850	n (HT40)	5755-5795	151-159 [2]	4	MCS 0-31
5725-5850	ac (VHT20)	5745-5825	149-165 [5]	4	MCS 0-9
5725-5850	ac (VHT40)	5755-5795	151-159 [2]	4	MCS 0-9
5725-5850	ac (VHT80)	5775	155 [1]	4	MCS 0-9

Note 1: RF output power specifies that Maximum Conducted Output Power.
 Note 2: 802.11a/n/ac uses a combination of OFDM-BPSK, QPSK, 16QAM, 64QAM, 256QAM modulation.
 Note 3: 802.11ac supports beamforming function.

1.1.2 Antenna Details

Ant. No.	Type	Connector	Operating Frequencies (MHz) / Antenna Gain (dBi)		
			2400~2483.5	5150~5250	5725~5850
1	Dipole	R-SMA	3.4	3.3	4.3
2	Dipole	R-SMA	2.8	2.7	3.4

Note: The antenna with highest gain was selected for final testing in this test report.

1.1.3 Power Supply Type of Equipment under Test (EUT)

Power Supply Type	12Vdc from adapter 55Vdc from POE
--------------------------	--------------------------------------

Note: The POE power supplies are not bundled in market.

1.1.4 Accessories

Accessories		
No.	Equipment	Description
1	Adapter	Brand: APD Model: WA-36A12FU Power Rating: I/P: 100-240Vac, 50-60Hz, 0.9A Max O/P: 12Vdc, 3A Power Line: 1.2m non-shielded without core
2	RJ45 (EEKSONG)	1.95m non-shielded without core
3	Core	Brand: King core Mode:KCF-130

1.1.5 Channel List

For Frequency band 5150-5250 MHz			
802.11 a / HT20 / VHT20		HT40 / VHT40	
Channel	Frequency(MHz)	Channel	Frequency(MHz)
36	5180	38	5190
40	5200	46	5230
44	5220	VHT80	
48	5240	42	5210

For Frequency band 5725~5850 MHz			
802.11 a / HT20 / VHT20		HT40 / VHT40	
Channel	Frequency(MHz)	Channel	Frequency(MHz)
149	5745	151	5755
153	5765	159	5795
157	5785	VHT80	
161	5805	155	5775
165	5825	---	---

1.1.6 Test Tool and Duty Cycle

Test Tool	Non-beamforming: QRCT, V3.0.298.0 Beamforming: iperf				
Duty Cycle and Duty Factor	Mode	Non-beamforming		Beamforming	
		Duty cycle (%)	Duty factor (dB)	Duty cycle (%)	Duty factor (dB)
	11a	97.65%	0.10	---	---
	VHT20	99.53%	0.02	92.34%	0.35
	VHT40	98.60%	0.06	85.36%	0.69
VHT80	96.25%	0.17	88.89%	0.51	

1.1.7 Power Index of Test Tool

For Frequency band 5150-5250 MHz			
Modulation Mode	Test Frequency (MHz)	Power Index	
		Non-Beamforming	Beamforming
11a	5180	18.5	---
11a	5200	23	---
11a	5240	24	---
VHT20	5180	19	20
VHT20	5200	24	24
VHT20	5240	24	24
VHT40	5190	16	17
VHT40	5230	21.5	23
VHT80	5210	15	16

For Frequency band 5725~5850 MHz			
Modulation Mode	Test Frequency (MHz)	Power Index	
		Non-Beamforming	Beamforming
11a	5745	24	---
11a	5785	24	---
11a	5825	24	---
VHT20	5745	24	23
VHT20	5785	24	23
VHT20	5825	24	23
VHT40	5755	23	24
VHT40	5795	24	24
VHT80	5775	20	23

1.2 Local Support Equipment List

Support Equipment List					
No.	Equipment	Brand	Model	FCC ID	Remarks
1	Notebook	Latitude E5470	R33002	DoC	---
2	Notebook	Latitude E6430	R33002	DoC	---
3	USB Flash	Kingston	DTSE9	---	---
4	Tri-Band Wi-Fi AC3000 Indoor Access Point	Browan	BW1257	---	Provided by applicant.

1.3 Test Setup Chart

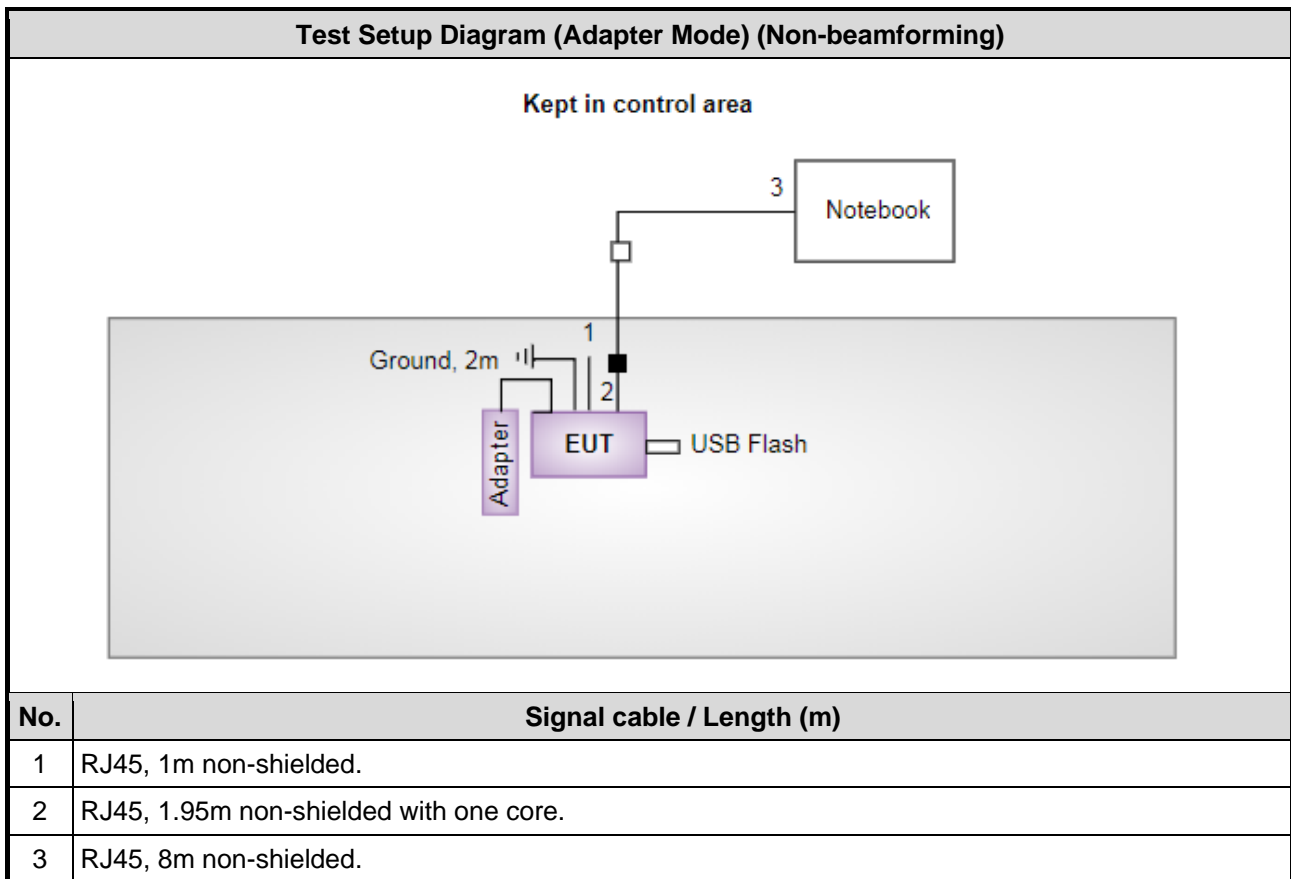

Test Setup Diagram (POE Mode) (Non-beamforming)

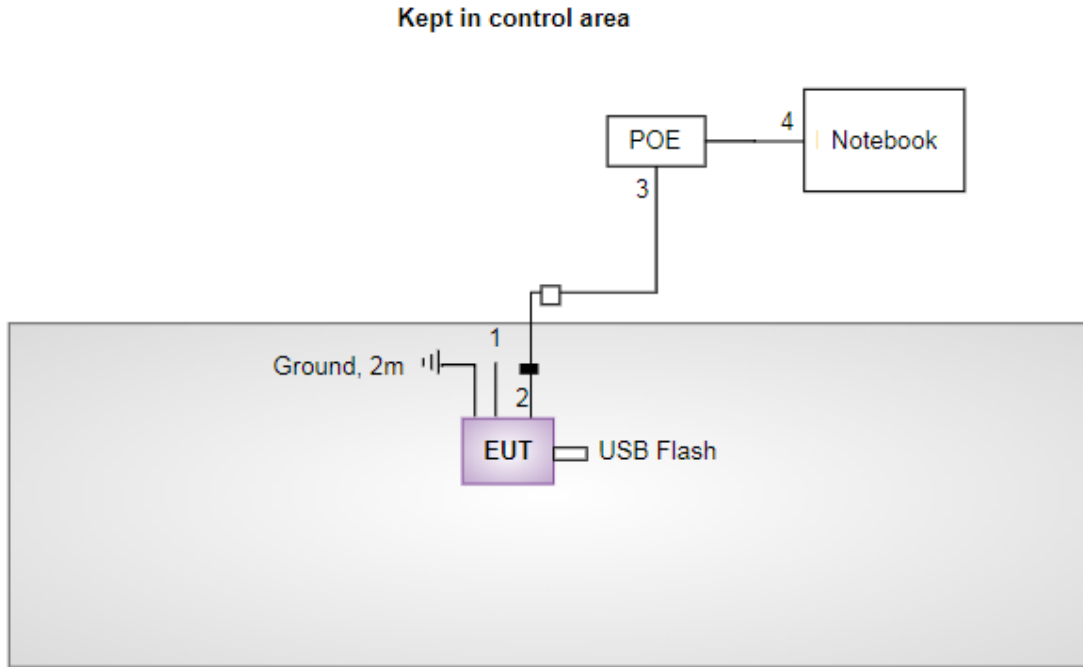

No.	Signal cable / Length (m)
1	RJ45, 1m non-shielded.
2	RJ45, 1.95m non-shielded with one core.
3	RJ45, 8m non-shielded.
4	RJ45, 1m non-shielded.

Test Setup Diagram (Adapter Mode) (Beamforming)

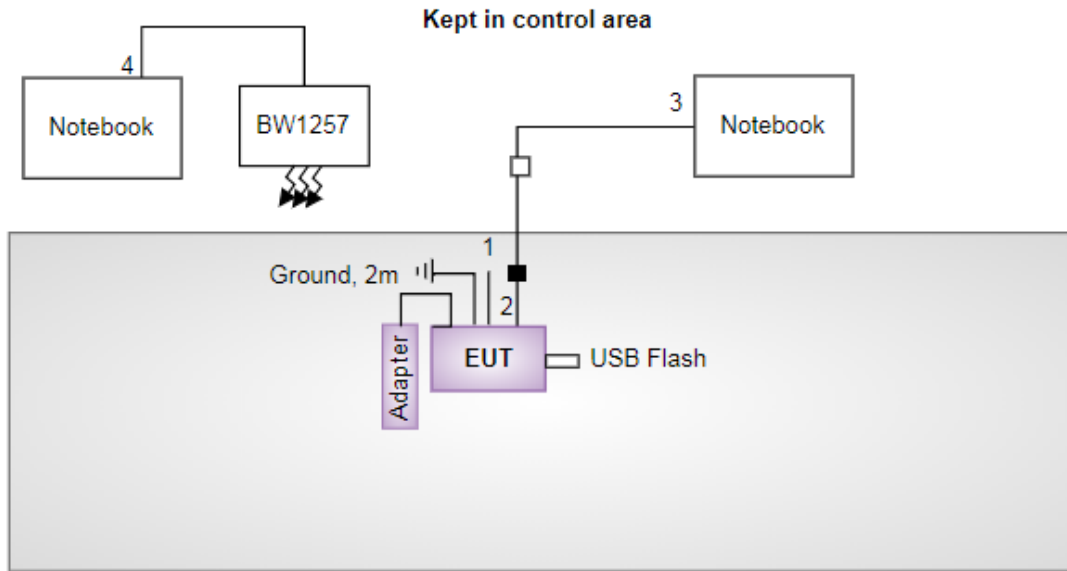

No.	Signal cable / Length (m)
1	RJ45, 1m non-shielded.
2	RJ45, 1.95m non-shielded with one core.
3	RJ45, 8m non-shielded.
4	RJ45, 1m non-shielded.

Test Setup Diagram (POE Mode) (Beamforming)

Kept in control area

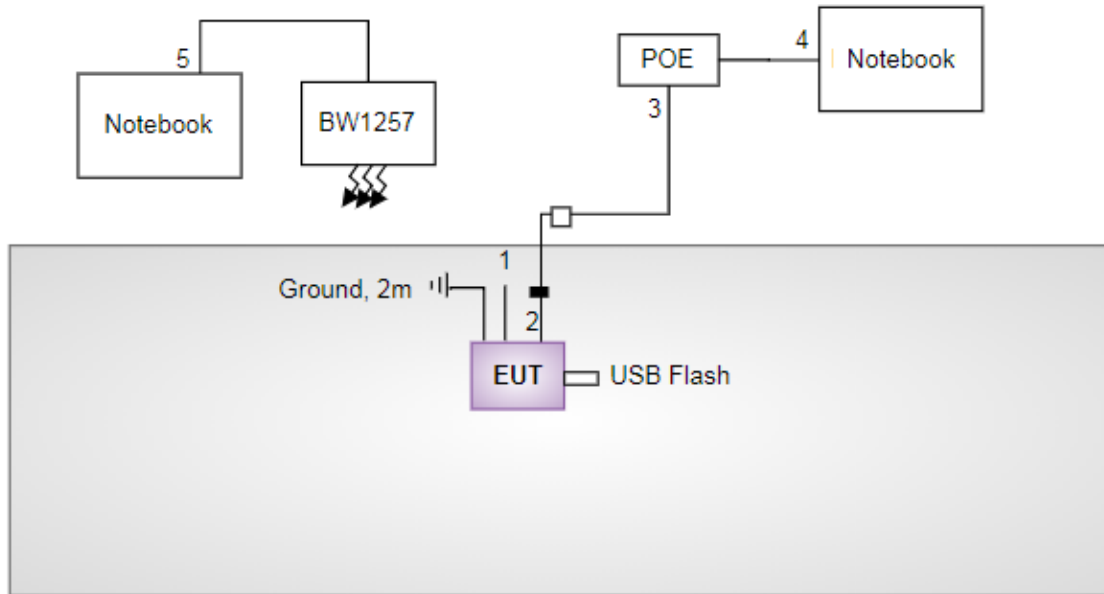

No.	Signal cable / Length (m)
1	RJ45, 1m non-shielded.
2	RJ45, 1.95m non-shielded with one core.
3	RJ45, 8m non-shielded.
4-5	RJ45, 1m non-shielded.

1.4 The Equipment List

Test Item	Conducted Emission				
Test Site	Conduction room 1 / (CO01-WS)				
Tested Date	Mar. 19, 2019				
Instrument	Manufacturer	Model No.	Serial No.	Calibration Date	Calibration Until
Receiver	R&S	ESR3	101657	Jan. 08, 2019	Jan. 07, 2020
LISN	R&S	ENV216	101579	Mar. 08, 2019	Mar. 07, 2020
RF Cable-CON	Woken	CFD200-NL	CFD200-NL-001	Oct. 23, 2018	Oct. 23, 2019
Measurement Software	AUDIX	e3	6.120210k	NA	NA
Note: Calibration Interval of instruments listed above is one year.					

Test Item	Radiated Emission				
Test Site	966 chamber 3 / (03CH03-WS)				
Tested Date	Mar. 19, 2019				
Instrument	Manufacturer	Model No.	Serial No.	Calibration Date	Calibration Until
Spectrum Analyzer	R&S	FSV40	101499	Jan. 07, 2019	Jan. 06, 2020
Receiver	R&S	ESR3	101658	Dec. 11, 2018	Dec. 10, 2019
Bilog Antenna	SCHWARZBECK	VULB9168	VULB9168-685	Apr. 19, 2018	Apr. 18, 2019
Horn Antenna 1G-18G	SCHWARZBECK	BBHA 9120 D	BBHA 9120 D 1206	Jan. 07, 2019	Jan. 06, 2020
Horn Antenna 18G-40G	SCHWARZBECK	BBHA 9170	BBHA 9170517	Nov. 15, 2018	Nov. 14, 2019
Loop Antenna	R&S	HFH2-Z2	100330	Nov. 09, 2018	Nov. 08, 2019
Loop Antenna Cable	KOAX KABEL	101354-BW	101354-BW	Oct. 08, 2018	Oct. 07, 2019
Preamplifier	EMC	EMC02325	980187	Aug. 24, 2018	Aug. 23, 2019
Preamplifier	Agilent	83017A	MY53270014	Aug. 09, 2018	Aug. 08, 2019
Preamplifier	EMC	EMC184045B	980192	Aug. 09, 2018	Aug. 08, 2019
RF cable-3M	HUBER+SUHNER	SUCOFLEX104	MY22620/4	Oct. 01, 2018	Sep. 30, 2019
RF cable-8M	EMC	EMC104-SM-SM-8000	181107	Oct. 01, 2018	Sep. 30, 2019
RF cable-1M	HUBER+SUHNER	SUCOFLEX104	MY22624/4	Oct. 01, 2018	Sep. 30, 2019
LF cable-0.8M	EMC	EMC8D-NM-NM-800	EMC8D-NM-NM-800-001	Oct. 01, 2018	Sep. 30, 2019
LF cable-3M	EMC	EMC8D-NM-NM-3000	131103	Oct. 01, 2018	Sep. 30, 2019
LF cable-13M	EMC	EMC8D-NM-NM-13000	131104	Oct. 01, 2018	Sep. 30, 2019
Measurement Software	AUDIX	e3	6.120210g	NA	NA
Note: Calibration Interval of instruments listed above is one year.					

Test Item	Radiated Emission				
Test Site	966 chamber 3 / (03CH03-WS)				
Tested Date	Dec. 24, 2018				
Instrument	Manufacturer	Model No.	Serial No.	Calibration Date	Calibration Until
Spectrum Analyzer	R&S	FSV40	101499	Jan. 03, 2018	Jan. 02, 2019
Receiver	R&S	ESR3	101658	Dec. 11, 2018	Dec. 10, 2019
Bilog Antenna	SCHWARZBECK	VULB9168	VULB9168-685	Apr. 19, 2018	Apr. 18, 2019
Horn Antenna 1G-18G	SCHWARZBECK	BBHA 9120 D	BBHA 9120 D 1206	Jan. 18, 2018	Jan. 17, 2019
Horn Antenna 18G-40G	SCHWARZBECK	BBHA 9170	BBHA 9170517	Nov. 15, 2018	Nov. 14, 2019
Loop Antenna	R&S	HFH2-Z2	100330	Nov. 09, 2018	Nov. 08, 2019
Loop Antenna Cable	KOAX KABEL	101354-BW	101354-BW	Oct. 08, 2018	Oct. 07, 2019
Preamplifier	EMC	EMC02325	980187	Aug. 24, 2018	Aug. 23, 2019
Preamplifier	Agilent	83017A	MY53270014	Aug. 09, 2018	Aug. 08, 2019
Preamplifier	EMC	EMC184045B	980192	Aug. 09, 2018	Aug. 08, 2019
RF cable-3M	HUBER+SUHNER	SUCOFLEX104	MY22620/4	Oct. 01, 2018	Sep. 30, 2019
RF cable-8M	EMC	EMC104-SM-SM-80 00	181107	Oct. 01, 2018	Sep. 30, 2019
RF cable-1M	HUBER+SUHNER	SUCOFLEX104	MY22624/4	Oct. 01, 2018	Sep. 30, 2019
LF cable-0.8M	EMC	EMC8D-NM-NM-800	EMC8D-NM-NM-800 -001	Oct. 01, 2018	Sep. 30, 2019
LF cable-3M	EMC	EMC8D-NM-NM-300 0	131103	Oct. 01, 2018	Sep. 30, 2019
LF cable-13M	EMC	EMC8D-NM-NM-130 00	131104	Oct. 01, 2018	Sep. 30, 2019
Measurement Software	AUDIX	e3	6.120210g	NA	NA
Note: Calibration Interval of instruments listed above is one year.					

Test Item	RF Conducted				
Test Site	(TH01-WS)				
Tested Date	Apr. 02 ~ Apr. 03, 2019				
Instrument	Manufacturer	Model No.	Serial No.	Calibration Date	Calibration Until
Spectrum Analyzer	R&S	FSV40	101063	Apr. 16, 2018	Apr. 15, 2019
Power Meter	Anritsu	ML2495A	1241002	Oct. 09, 2018	Oct. 08, 2019
Power Sensor	Anritsu	MA2411B	1207366	Oct. 09, 2018	Oct. 08, 2019
TEMP&HUMIDITY CHAMBER	GIANT FORCE	GCT-225-40-SP-SD	MAF1212-002	Dec. 05, 2018	Dec. 04, 2019
DC POWER SOURCE	GW INSTEK	GPC-6030D	EM892433	Oct. 25, 2018	Oct. 24, 2019
AC POWER SOURCE	APC	AFC-500W	F312060012	Nov. 29, 2018	Nov. 28, 2019
Measurement Software	Sporton	SENSE-15247_DTS	V5.9	NA	NA
Note: Calibration Interval of instruments listed above is one year.					

1.5 Testing Applied Standards

According to the specification of EUT, the EUT must comply with following standards and KDB documents.

47 CFR FCC Part 15.407

ANSI C63.10-2013

FCC KDB 789033 D02 General UNII Test Procedures New Rules v02r01

FCC KDB 662911 D01 Multiple Transmitter Output v02r01

FCC KDB 412172 D01 Determining ERP and EIRP v01r01

1.6 Deviation from Test Standard and Measurement Procedure

None

1.7 Measurement Uncertainty

ISO/IEC 17025 requires that an estimate of the measurement uncertainties associated with the emissions test results be included in the report. The measurement uncertainties given below are based on a 95% confidence level (based on a coverage factor ($k=2$))

Measurement Uncertainty	
Parameters	Uncertainty
Bandwidth	± 34.130 Hz
Conducted power	± 0.808 dB
Frequency error	$\pm 1 \times 10^{-9}$
Power density	± 0.583 dB
Conducted emission	± 2.715 dB
AC conducted emission	± 2.92 dB
Radiated emission ≤ 1 GHz	± 3.96 dB
Radiated emission > 1 GHz	± 4.51 dB
Time	$\pm 0.1\%$
Temperature	± 0.4 °C

2 Test Configuration

2.1 Testing Condition

Test Item	Test Site	Ambient Condition	Tested By
AC Conduction	CO01-WS	21°C / 62%	Akun Chung
Radiated Emissions	03CH03-WS	24°C / 61-65%	Roger Lu Akun Chung
RF Conducted	TH01-WS	21°C / 63%	Roger Lu

- FCC Designation No.: TW0009
- FCC site registration No.: 207696
- ISED#: 10807A
- CAB identifier: TW2732

2.2 The Worst Test Modes and Channel Details

Non-beamforming mode

For Frequency band 5150-5250 MHz				
Test item	Modulation Mode	Test Frequency (MHz)	Data Rate (Mbps) / MCS	Test Configuration
Conducted Emissions	11a	5240	6 Mbps	1, 2
Radiated Emissions ≤ 1 GHz	11a	5240	6 Mbps	1, 2
Radiated Emissions > 1 GHz	11a VHT20 VHT40 VHT80	5180 / 5200 / 5240 5180 / 5200 / 5240 5190 / 5230 5210	6 Mbps MCS 0 MCS 0 MCS 0	2
RF Output Power	11a HT20 HT40 VHT20 VHT40 VHT80	5180 / 5200 / 5240 5180 / 5200 / 5240 5190 / 5230 5180 / 5200 / 5240 5190 / 5230 5210	6 Mbps MCS 0 MCS 0 MCS 0 MCS 0 MCS 0	1
Emission Bandwidth Peak Power Spectral Density	11a VHT20 VHT40 VHT80	5180 / 5200 / 5240 5180 / 5200 / 5240 5190 / 5230 5210	6 Mbps MCS 0 MCS 0 MCS 0	1
Frequency Stability	Un-modulation	5200	---	1

NOTE:

1. The EUT was pretested with 3 orientations placed on the table for the radiated emission measurement – X, Y, and Z-plane. The **X-plane** results were found as the worst case and were shown in this report.
2. The EUT had been tested by following test configurations.
 - 1) Configuration 1 : Adapter mode
 - 2) Configuration 2 : POE mode

For Frequency band 5725-5850 MHz				
Test item	Modulation Mode	Test Frequency (MHz)	Data Rate (Mbps) / MCS	Test Configuration
Conducted Emissions	11a	5785	6 Mbps	1, 2
Radiated Emissions ≤1GHz	11a	5785	6 Mbps	1, 2
Radiated Emissions >1GHz	11a VHT20 VHT40 VHT80	5745 / 5785 / 5825 5745 / 5785 / 5825 5755 / 5795 5775	6 Mbps MCS 0 MCS 0 MCS 0	2
RF Output Power	11a HT20 HT40 VHT20 VHT40 VHT80	5745 / 5785 / 5825 5745 / 5785 / 5825 5755 / 5795 5745 / 5785 / 5825 5755 / 5795 5775	6 Mbps MCS 0 MCS 0 MCS 0 MCS 0 MCS 0	1
Radiated Emissions >1GHz Emission Bandwidth 6dB bandwidth Peak Power Spectral Density	11a VHT20 VHT40 VHT80	5745 / 5785 / 5825 5745 / 5785 / 5825 5755 / 5795 5775	6 Mbps MCS 0 MCS 0 MCS 0	1
Frequency Stability	Un-modulation	5785	---	1
NOTE:				
1. The EUT was pretested with 3 orientations placed on the table for the radiated emission measurement – X, Y, and Z-plane. The X-plane results were found as the worst case and were shown in this report.				
2. The EUT had been tested by following test configurations.				
1) Configuration 1 : Adapter mode				
2) Configuration 2 : POE mode				

Beamforming mode

For Frequency band 5150-5250 MHz				
Test item	Modulation Mode	Test Frequency (MHz)	Data Rate (Mbps) / MCS	Test Configuration
Conducted Emissions	VHT20	5200	MCS 0	1, 2
Radiated Emissions ≤1GHz	VHT20	5200	MCS 0	1, 2
Radiated Emissions >1GHz	VHT20 VHT40 VHT80	5180 / 5200 / 5240 5190 / 5230 5210	MCS 0 MCS 0 MCS 0	2
RF Output Power	VHT20 VHT40 VHT80	5180 / 5200 / 5240 5190 / 5230 5210	MCS 0 MCS 0 MCS 0	1
Emission Bandwidth Peak Power Spectral Density	VHT20 VHT40 VHT80	5180 / 5200 / 5240 5190 / 5230 5210	MCS 0 MCS 0 MCS 0	1

NOTE:

- The EUT was pretested with 3 orientations placed on the table for the radiated emission measurement – X, Y, and Z-plane. The **X-plane** results were found as the worst case and were shown in this report.
- The EUT had been tested by following test configurations.
 - Configuration 1 : Adapter mode
 - Configuration 2 : POE mode

For Frequency band 5725-5850 MHz				
Test item	Modulation Mode	Test Frequency (MHz)	Data Rate (Mbps) / MCS	Test Configuration
Conducted Emissions	VHT40	5755	MCS 0	1, 2
Radiated Emissions ≤1GHz	VHT40	5755	MCS 0	1, 2
Radiated Emissions >1GHz	VHT20 VHT40 VHT80	5745 / 5785 / 5825 5755 / 5795 5775	MCS 0 MCS 0 MCS 0	2
RF Output Power	VHT20 VHT40 VHT80	5745 / 5785 / 5825 5755 / 5795 5775	MCS 0 MCS 0 MCS 0	1
Emission Bandwidth 6dB bandwidth Peak Power Spectral Density	VHT20 VHT40 VHT80	5745 / 5785 / 5825 5755 / 5795 5775	MCS 0 MCS 0 MCS 0	1

NOTE:

- The EUT was pretested with 3 orientations placed on the table for the radiated emission measurement – X, Y, and Z-plane. The **X-plane** results were found as the worst case and were shown in this report.
- The EUT had been tested by following test configurations.
 - Configuration 1 : Adapter mode
 - Configuration 2 : POE mode

3 Transmitter Test Results

3.1 Conducted Emissions

3.1.1 Limit of Conducted Emissions

Conducted Emissions Limit		
Frequency Emission (MHz)	Quasi-Peak	Average
0.15-0.5	66 - 56 *	56 - 46 *
0.5-5	56	46
5-30	60	50

Note 1: * Decreases with the logarithm of the frequency.

3.1.2 Test Procedures

1. The device is placed on a test table, raised 80 cm above the reference ground plane. The vertical conducting plane is located 40 cm to the rear of the device.
2. The device is connected to line impedance stabilization network (LISN) and other accessories are connected to other LISN. Measured levels of AC power line conducted emission are across the 50 Ω LISN port.
3. AC conducted emission measurements is made over frequency range from 150 kHz to 30 MHz.
4. This measurement was performed with AC 120V / 60Hz.

3.1.3 Test Setup

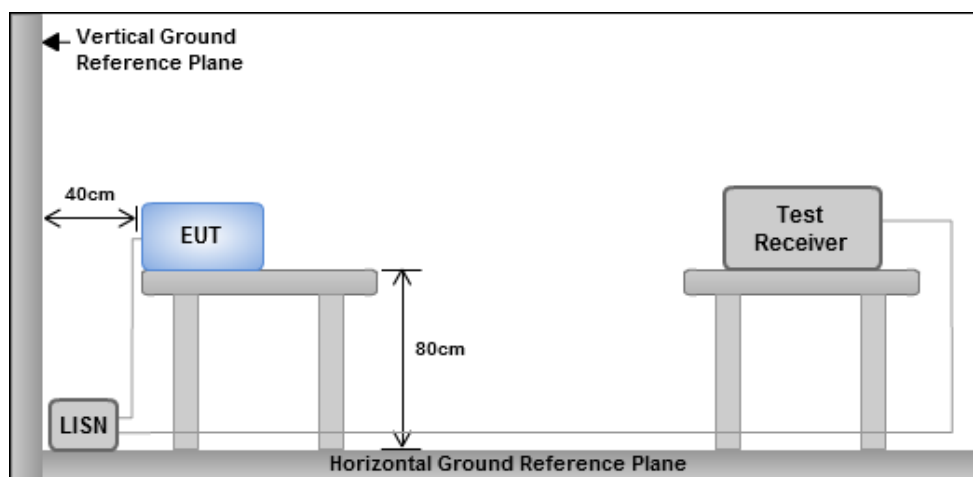

Note: 1. Support units were connected to second LISN.

2. Both of LISNs (AMN) are 80 cm from EUT and at least 80 cm from other units and other metal planes

3.1.4 Test Result of Conducted Emissions

Non-beamforming mode

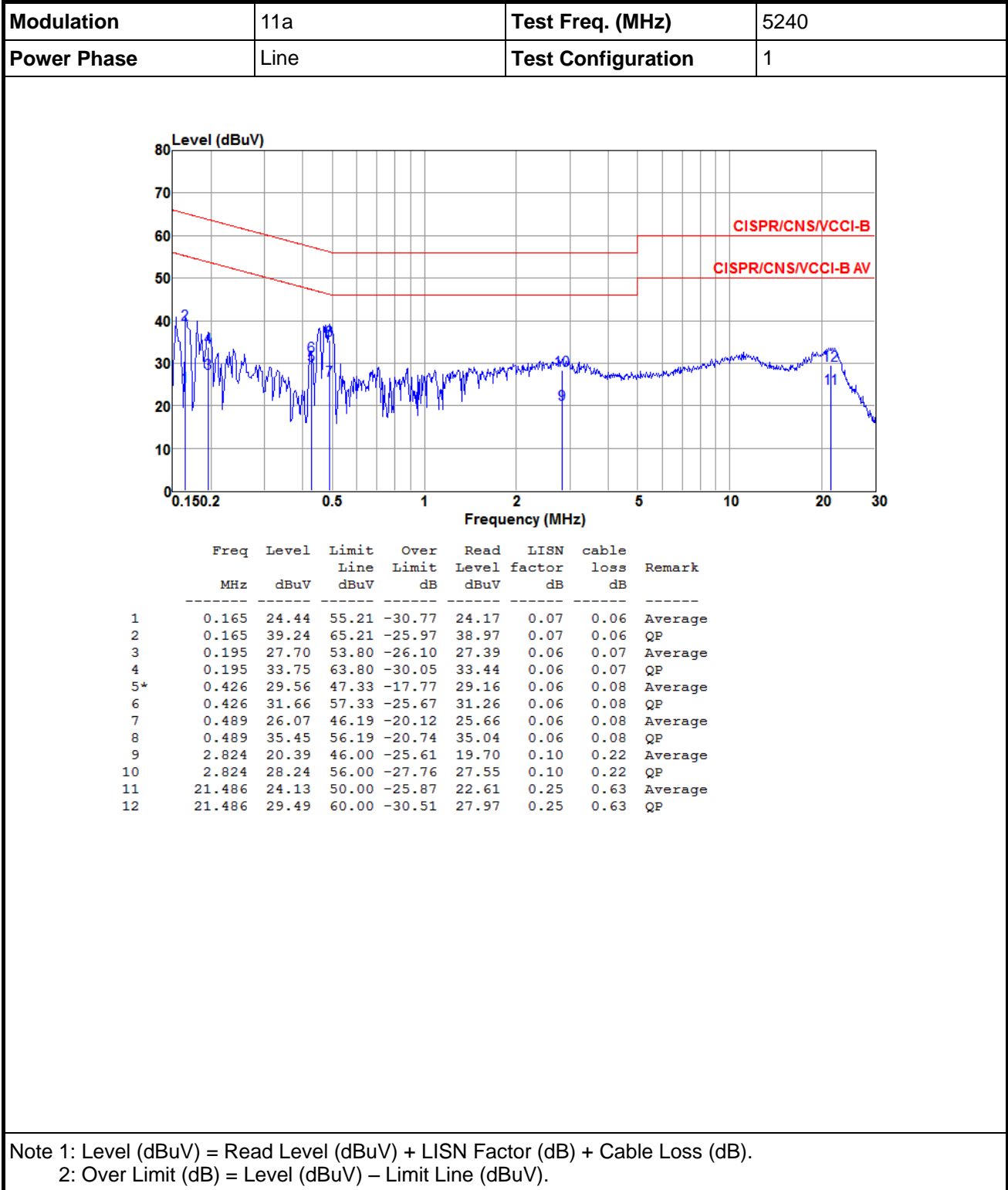

Modulation	11a	Test Freq. (MHz)	5240
Power Phase	Neutral	Test Configuration	1

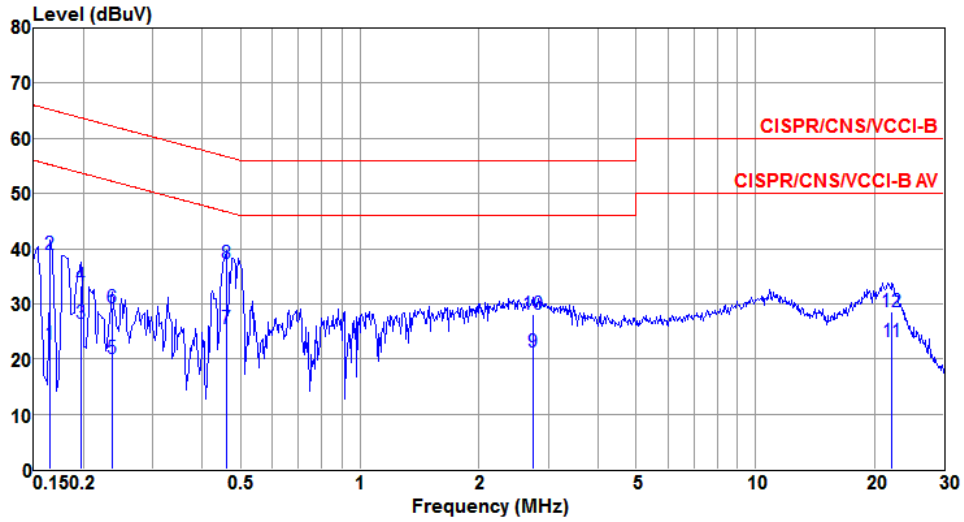

	Freq	Level	Limit	Over	Read	LISN	cable	Remark
	MHz	dBuV	Line	Limit	Level	factor	loss	
			dBuV	dB	dBuV	dB	dB	
1	0.165	22.67	55.21	-32.54	22.44	0.05	0.06	Average
2	0.165	39.06	65.21	-26.15	38.83	0.05	0.06	QP
3	0.198	26.32	53.71	-27.39	26.07	0.04	0.07	Average
4	0.198	33.37	63.71	-30.34	33.12	0.04	0.07	QP
5	0.237	19.99	52.22	-32.23	19.74	0.04	0.07	Average
6	0.237	29.38	62.22	-32.84	29.13	0.04	0.07	QP
7	0.459	25.56	46.71	-21.15	25.29	0.05	0.08	Average
8*	0.459	37.22	56.71	-19.49	36.95	0.05	0.08	QP
9	2.736	21.16	46.00	-24.84	20.62	0.08	0.21	Average
10	2.736	28.09	56.00	-27.91	27.55	0.08	0.21	QP
11	22.180	23.10	50.00	-26.90	21.64	0.28	0.64	Average
12	22.180	28.65	60.00	-31.35	27.19	0.28	0.64	QP

Note 1: Level (dBuV) = Read Level (dBuV) + LISN Factor (dB) + Cable Loss (dB).
 2: Over Limit (dB) = Level (dBuV) – Limit Line (dBuV).

Modulation	11a	Test Freq. (MHz)	5785
Power Phase	Line	Test Configuration	1

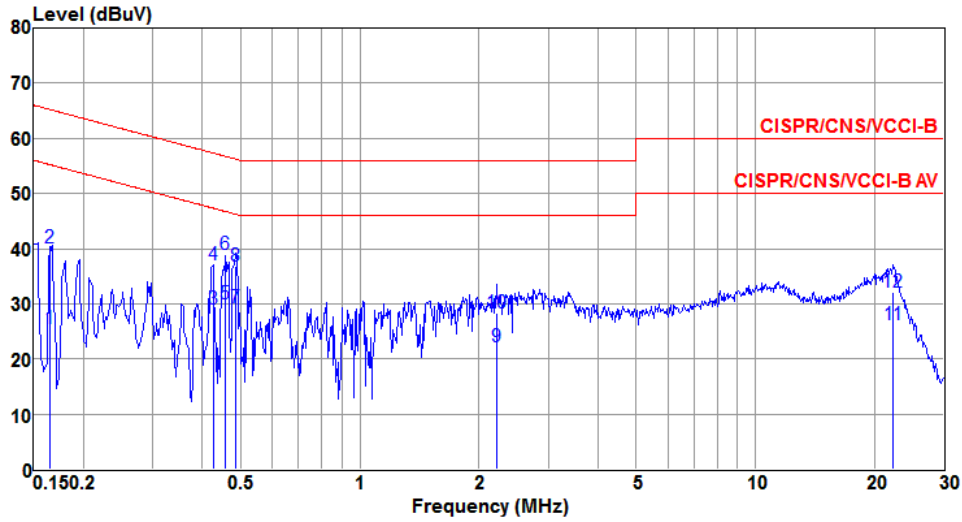

	Freq MHz	Level dBuV	Limit Line dBuV	Over Limit dB	Read Level dBuV	LISN factor dB	cable loss dB	Remark
1	0.165	25.45	55.21	-29.76	25.18	0.07	0.06	Average
2	0.165	40.07	65.21	-25.14	39.80	0.07	0.06	QP
3	0.426	29.01	47.33	-18.32	28.61	0.06	0.08	Average
4	0.426	37.11	57.33	-20.22	36.71	0.06	0.08	QP
5*	0.456	30.03	46.76	-16.73	29.62	0.06	0.08	Average
6	0.456	38.98	56.76	-17.78	38.57	0.06	0.08	QP
7	0.484	29.21	46.27	-17.06	28.80	0.06	0.08	Average
8	0.484	36.93	56.27	-19.34	36.52	0.06	0.08	QP
9	2.213	22.28	46.00	-23.72	21.65	0.09	0.18	Average
10	2.213	28.27	56.00	-27.73	27.64	0.09	0.18	QP
11	22.298	26.28	50.00	-23.72	24.74	0.25	0.64	Average
12	22.298	32.06	60.00	-27.94	30.52	0.25	0.64	QP

Note 1: Level (dBuV) = Read Level (dBuV) + LISN Factor (dB) + Cable Loss (dB).
 2: Over Limit (dB) = Level (dBuV) – Limit Line (dBuV).

Modulation	11a	Test Freq. (MHz)	5785
Power Phase	Neutral	Test Configuration	1

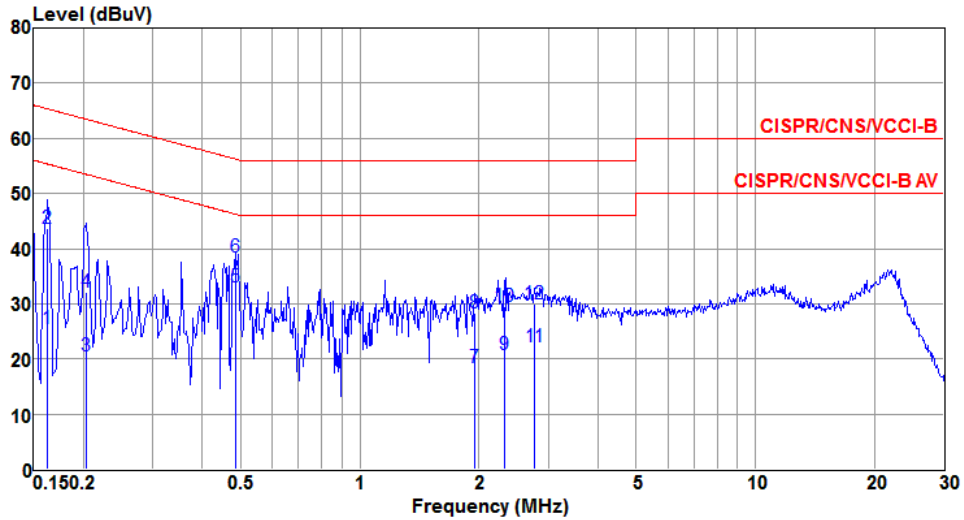

	Freq	Level	Limit	Over	Read	LISN	cable	Remark
	MHz	dBuV	Line	Limit	Level	factor	loss	
			dBuV	dB	dBuV	dB	dB	
1	0.162	25.42	55.34	-29.92	25.19	0.05	0.06	Average
2	0.162	43.67	65.34	-21.67	43.44	0.05	0.06	QP
3	0.204	20.52	53.45	-32.93	20.27	0.04	0.07	Average
4	0.204	32.14	63.45	-31.31	31.89	0.04	0.07	QP
5*	0.484	33.02	46.27	-13.25	32.75	0.05	0.08	Average
6	0.484	38.48	56.27	-17.79	38.21	0.05	0.08	QP
7	1.949	18.41	46.00	-27.59	17.93	0.07	0.16	Average
8	1.949	28.26	56.00	-27.74	27.78	0.07	0.16	QP
9	2.321	20.78	46.00	-25.22	20.27	0.07	0.19	Average
10	2.321	29.52	56.00	-26.48	29.01	0.07	0.19	QP
11	2.765	22.08	46.00	-23.92	21.53	0.08	0.22	Average
12	2.765	30.01	56.00	-25.99	29.46	0.08	0.22	QP

Note 1: Level (dBuV) = Read Level (dBuV) + LISN Factor (dB) + Cable Loss (dB).
 2: Over Limit (dB) = Level (dBuV) – Limit Line (dBuV).

Modulation	11a	Test Freq. (MHz)	5240
Power Phase	Line	Test Configuration	2

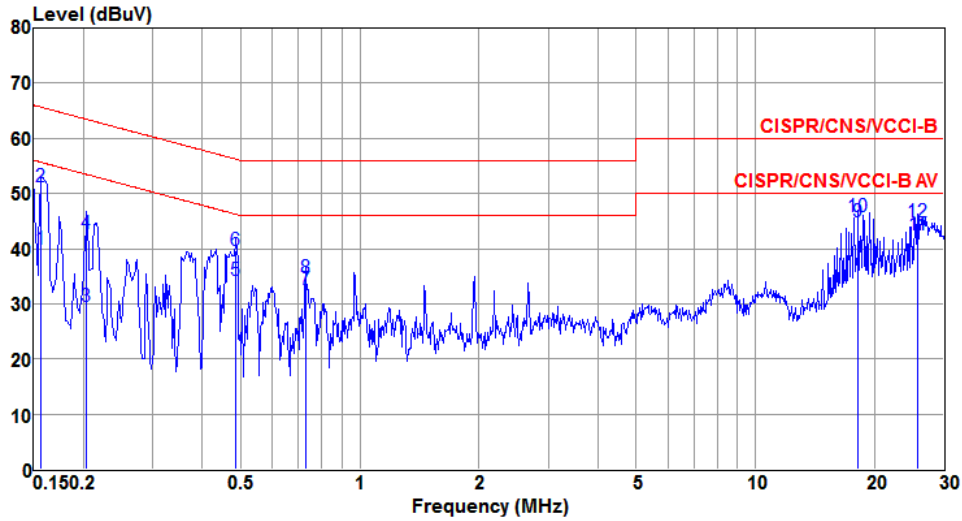

	Freq MHz	Level dBUV	Limit Line dBUV	Over Limit dB	Read Level dBUV	LISN factor dB	cable loss dB	Remark
1	0.156	39.96	55.69	-15.73	39.84	0.07	0.05	Average
2	0.156	51.30	65.69	-14.39	51.18	0.07	0.05	QP
3	0.204	29.45	53.45	-24.00	29.32	0.06	0.07	Average
4	0.204	42.83	63.45	-20.62	42.70	0.06	0.07	QP
5	0.486	34.16	46.23	-12.07	34.02	0.06	0.08	Average
6	0.486	39.69	56.23	-16.54	39.55	0.06	0.08	QP
7	0.727	32.49	46.00	-13.51	32.33	0.07	0.09	Average
8	0.727	34.66	56.00	-21.34	34.50	0.07	0.09	QP
9*	18.220	44.81	50.00	-5.19	43.99	0.23	0.59	Average
10	18.220	45.71	60.00	-14.29	44.89	0.23	0.59	QP
11	25.749	42.38	50.00	-7.62	41.42	0.26	0.70	Average
12	25.749	44.79	60.00	-15.21	43.83	0.26	0.70	QP

Note 1: Level (dBUV) = Read Level (dBUV) + LISN Factor (dB) + Cable Loss (dB).
 2: Over Limit (dB) = Level (dBUV) – Limit Line (dBUV).

Modulation	11a	Test Freq. (MHz)	5240
Power Phase	Neutral	Test Configuration	2

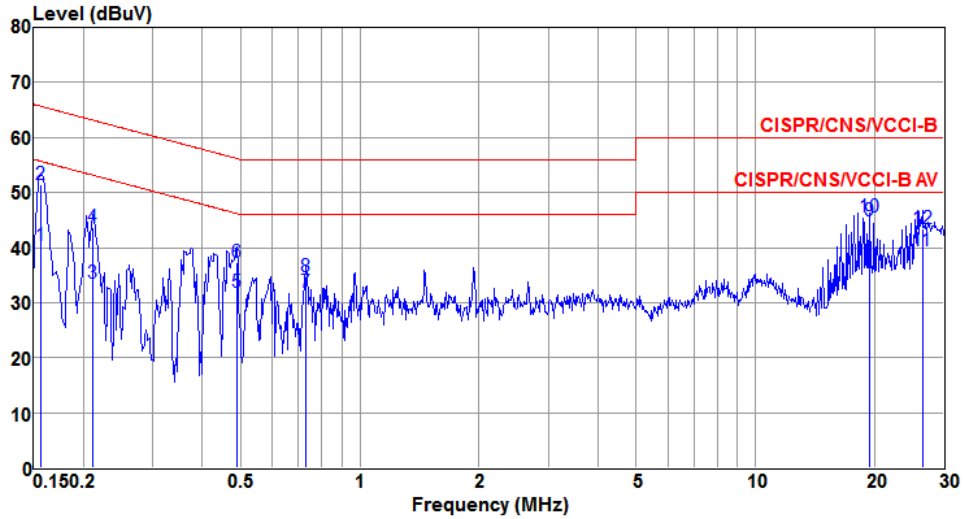

	Freq	Level	Limit	Over	Read	LISN	cable	
	MHz	dBuV	Line	Limit	Level	factor	loss	Remark
			dBuV	dB	dBuV	dB	dB	
1	0.156	40.46	55.69	-15.23	40.36	0.05	0.05	Average
2	0.156	51.56	65.69	-14.13	51.46	0.05	0.05	QP
3	0.211	33.61	53.18	-19.57	33.50	0.04	0.07	Average
4	0.211	43.61	63.18	-19.57	43.50	0.04	0.07	QP
5	0.489	31.97	46.19	-14.22	31.84	0.05	0.08	Average
6	0.489	37.32	56.19	-18.87	37.19	0.05	0.08	QP
7	0.731	31.76	46.00	-14.24	31.61	0.06	0.09	Average
8	0.731	34.67	56.00	-21.33	34.52	0.06	0.09	QP
9*	19.434	44.96	50.00	-5.04	44.10	0.26	0.60	Average
10	19.434	45.64	60.00	-14.36	44.78	0.26	0.60	QP
11	26.482	39.31	50.00	-10.69	38.28	0.31	0.72	Average
12	26.482	43.43	60.00	-16.57	42.40	0.31	0.72	QP

Note 1: Level (dBUV) = Read Level (dBUV) + LISN Factor (dB) + Cable Loss (dB).
 2: Over Limit (dB) = Level (dBUV) – Limit Line (dBUV).

Modulation	11a	Test Freq. (MHz)	5785
Power Phase	Line	Test Configuration	2

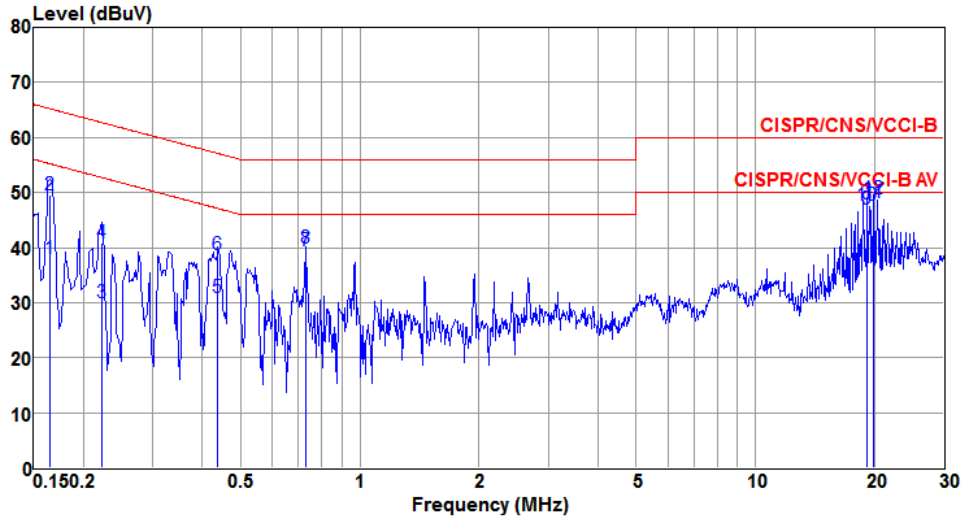

	Freq MHz	Level dBUV	Limit Line dBUV	Over Limit dB	Read Level dBUV	LISN factor dB	cable loss dB	Remark
1	0.165	38.11	55.21	-17.10	37.98	0.07	0.06	Average
2	0.165	49.60	65.21	-15.61	49.47	0.07	0.06	QP
3	0.222	29.98	52.74	-22.76	29.85	0.06	0.07	Average
4	0.222	40.95	62.74	-21.79	40.82	0.06	0.07	QP
5	0.437	30.88	47.11	-16.23	30.74	0.06	0.08	Average
6	0.437	38.66	57.11	-18.45	38.52	0.06	0.08	QP
7	0.727	39.32	46.00	-6.68	39.16	0.07	0.09	Average
8	0.727	39.90	56.00	-16.10	39.74	0.07	0.09	QP
9	19.182	47.08	50.00	-2.92	46.25	0.24	0.59	Average
10	19.182	47.74	60.00	-12.26	46.91	0.24	0.59	QP
11*	19.911	48.26	50.00	-1.74	47.42	0.24	0.60	Average
12	19.911	48.84	60.00	-11.16	48.00	0.24	0.60	QP

Note 1: Level (dBUV) = Read Level (dBUV) + LISN Factor (dB) + Cable Loss (dB).
 2: Over Limit (dB) = Level (dBUV) – Limit Line (dBUV).

Modulation	11a	Test Freq. (MHz)	5785
Power Phase	Neutral	Test Configuration	2

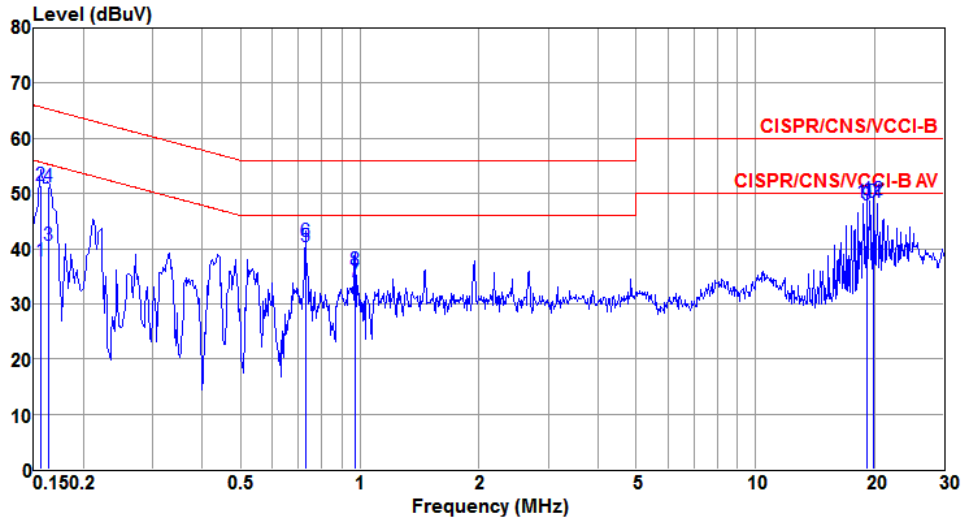

	Freq	Level	Limit	Over	Read	LISN	cable	Remark
	MHz	dBuV	Line	Limit	Level	factor	loss	
			dBuV	dB	dBuV	dB	dB	
1	0.156	37.75	55.67	-17.92	37.65	0.05	0.05	Average
2	0.156	51.51	65.67	-14.16	51.41	0.05	0.05	QP
3	0.163	40.56	55.29	-14.73	40.45	0.05	0.06	Average
4	0.163	51.17	65.29	-14.12	51.06	0.05	0.06	QP
5	0.727	40.32	46.00	-5.68	40.17	0.06	0.09	Average
6	0.727	41.31	56.00	-14.69	41.16	0.06	0.09	QP
7	0.974	33.91	46.00	-12.09	33.75	0.06	0.10	Average
8	0.974	36.08	56.00	-19.92	35.92	0.06	0.10	QP
9	19.185	47.86	50.00	-2.14	47.01	0.26	0.59	Average
10	19.185	48.43	60.00	-11.57	47.58	0.26	0.59	QP
11*	19.915	48.48	50.00	-1.52	47.62	0.26	0.60	Average
12	19.915	48.77	60.00	-11.23	47.91	0.26	0.60	QP

Note 1: Level (dBuV) = Read Level (dBuV) + LISN Factor (dB) + Cable Loss (dB).
 2: Over Limit (dB) = Level (dBuV) – Limit Line (dBuV).

Beamforming mode

Modulation	VHT20	Test Freq. (MHz)	5200
Power Phase	Line	Test Configuration	1

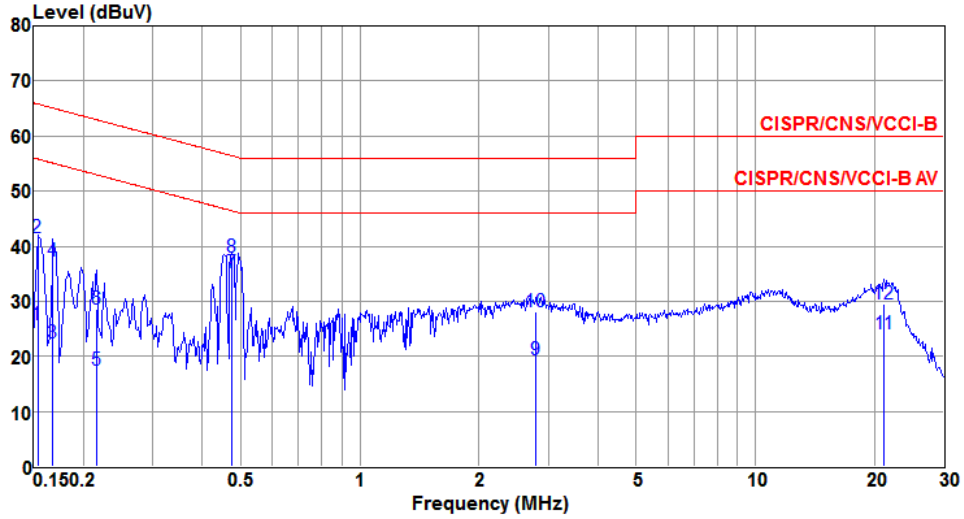

	Freq MHz	Level dBuV	Limit Line dBuV	Over Limit dB	Read Level dBuV	LISN factor dB	cable loss dB	Remark
1	0.153	25.76	55.82	-30.06	25.51	0.07	0.05	Average
2	0.153	41.50	65.82	-24.32	41.25	0.07	0.05	QP
3	0.168	22.35	55.08	-32.73	22.07	0.07	0.06	Average
4	0.168	37.33	65.08	-27.75	37.05	0.07	0.06	QP
5	0.216	17.41	52.96	-35.55	17.08	0.06	0.07	Average
6	0.216	28.57	62.96	-34.39	28.24	0.06	0.07	QP
7*	0.474	35.24	46.45	-11.21	34.83	0.06	0.08	Average
8	0.474	37.99	56.45	-18.46	37.58	0.06	0.08	QP
9	2.794	19.28	46.00	-26.72	18.59	0.10	0.22	Average
10	2.794	28.11	56.00	-27.89	27.42	0.10	0.22	QP
11	21.147	24.01	50.00	-25.99	22.50	0.25	0.62	Average
12	21.147	29.42	60.00	-30.58	27.91	0.25	0.62	QP

Note 1: Level (dBuV) = Read Level (dBuV) + LISN Factor (dB) + Cable Loss (dB).
 2: Over Limit (dB) = Level (dBuV) – Limit Line (dBuV).

Modulation	VHT20	Test Freq. (MHz)	5200
Power Phase	Neutral	Test Configuration	1

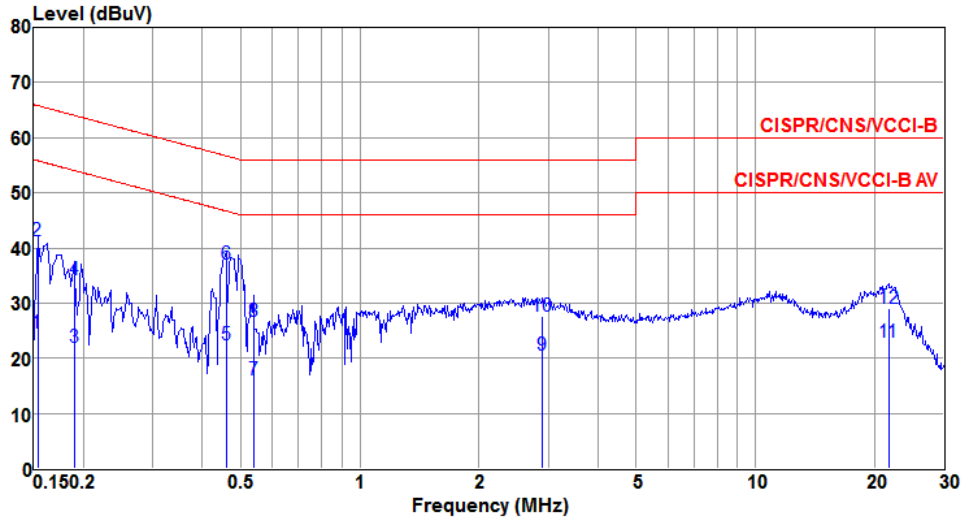

	Freq	Level	Limit	Over	Read	LISN	cable	
	MHz	dBuV	Line	Limit	Level	factor	loss	Remark
			dBuV	dB	dBuV	dB	dB	
1	0.153	24.54	55.82	-31.28	24.33	0.05	0.05	Average
2	0.153	41.28	65.82	-24.54	41.07	0.05	0.05	QP
3	0.189	21.96	54.06	-32.10	21.72	0.04	0.07	Average
4	0.189	34.30	64.06	-29.76	34.06	0.04	0.07	QP
5	0.459	22.51	46.71	-24.20	22.24	0.05	0.08	Average
6*	0.459	37.03	56.71	-19.68	36.76	0.05	0.08	QP
7	0.538	16.12	46.00	-29.88	15.82	0.05	0.09	Average
8	0.538	26.65	56.00	-29.35	26.35	0.05	0.09	QP
9	2.900	20.45	46.00	-25.55	19.89	0.08	0.22	Average
10	2.900	27.62	56.00	-28.38	27.06	0.08	0.22	QP
11	21.715	22.92	50.00	-27.08	21.50	0.27	0.63	Average
12	21.715	29.05	60.00	-30.95	27.63	0.27	0.63	QP

Note 1: Level (dBuV) = Read Level (dBuV) + LISN Factor (dB) + Cable Loss (dB).
 2: Over Limit (dB) = Level (dBuV) – Limit Line (dBuV).

Modulation	VHT40	Test Freq. (MHz)	5755
Power Phase	Line	Test Configuration	1

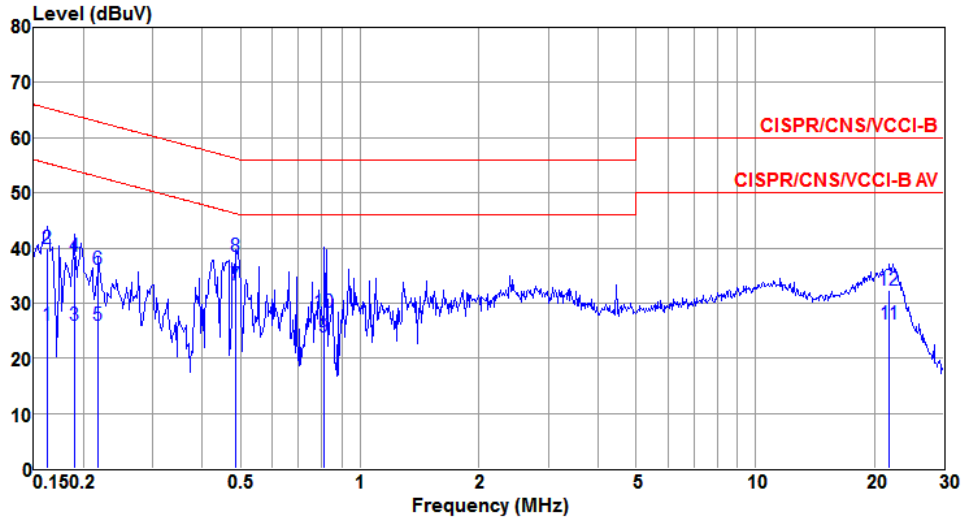

	Freq	Level	Limit	Over	Read	LISN	cable	Remark
	MHz	dBuV	Line	Limit	Level	factor	loss	
			dBuV	dB	dBuV	dB	dB	
1	0.162	26.00	55.34	-29.34	25.73	0.07	0.06	Average
2	0.162	39.83	65.34	-25.51	39.56	0.07	0.06	QP
3	0.189	26.04	54.06	-28.02	25.73	0.06	0.07	Average
4	0.189	38.37	64.06	-25.69	38.06	0.06	0.07	QP
5	0.219	25.88	52.88	-27.00	25.55	0.06	0.07	Average
6	0.219	36.03	62.88	-26.85	35.70	0.06	0.07	QP
7*	0.484	33.36	46.27	-12.91	32.95	0.06	0.08	Average
8	0.484	38.47	56.27	-17.80	38.06	0.06	0.08	QP
9	0.813	23.76	46.00	-22.24	23.29	0.08	0.10	Average
10	0.813	28.33	56.00	-27.67	27.86	0.08	0.10	QP
11	21.830	26.29	50.00	-23.71	24.77	0.25	0.63	Average
12	21.830	32.34	60.00	-27.66	30.82	0.25	0.63	QP

Note 1: Level (dBuV) = Read Level (dBuV) + LISN Factor (dB) + Cable Loss (dB).
 2: Over Limit (dB) = Level (dBuV) – Limit Line (dBuV).

Modulation	VHT40	Test Freq. (MHz)	5755
Power Phase	Neutral	Test Configuration	1

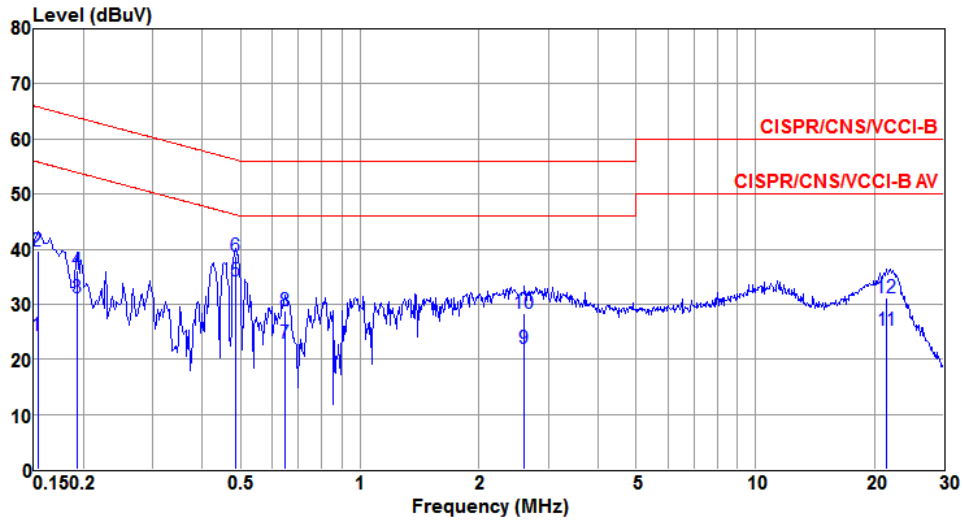

	Freq	Level	Limit	Over	Read	LISN	cable	
	MHz	dBuV	Line	Limit	Level	factor	loss	Remark
			dBuV	dB	dBuV	dB	dB	
1	0.153	24.31	55.82	-31.51	24.10	0.05	0.05	Average
2	0.153	39.59	65.82	-26.23	39.38	0.05	0.05	QP
3	0.192	31.26	53.93	-22.67	31.01	0.04	0.07	Average
4	0.192	36.04	63.93	-27.89	35.79	0.04	0.07	QP
5*	0.486	34.24	46.23	-11.99	33.97	0.05	0.08	Average
6	0.486	38.65	56.23	-17.58	38.38	0.05	0.08	QP
7	0.647	22.97	46.00	-23.03	22.64	0.06	0.09	Average
8	0.647	28.78	56.00	-27.22	28.45	0.06	0.09	QP
9	2.608	22.04	46.00	-23.96	21.50	0.08	0.21	Average
10	2.608	28.39	56.00	-27.61	27.85	0.08	0.21	QP
11	21.486	25.34	50.00	-24.66	23.93	0.27	0.63	Average
12	21.486	31.04	60.00	-28.96	29.63	0.27	0.63	QP

Note 1: Level (dBuV) = Read Level (dBuV) + LISN Factor (dB) + Cable Loss (dB).
 2: Over Limit (dB) = Level (dBuV) – Limit Line (dBuV).

Modulation	VHT20	Test Freq. (MHz)	5200
Power Phase	Line	Test Configuration	2

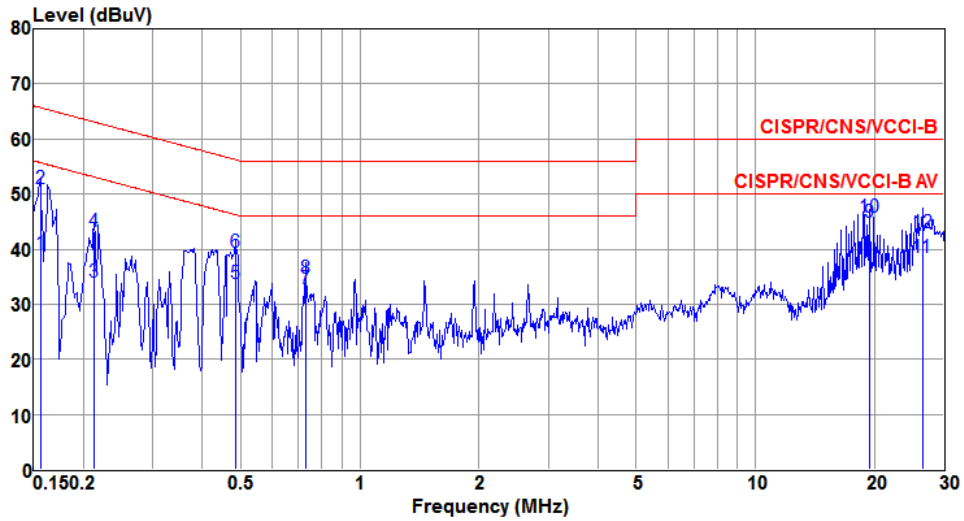

	Freq MHz	Level dBuV	Limit Line dBuV	Over Limit dB	Read Level dBuV	LISN factor dB	cable loss dB	Remark
1	0.156	39.22	55.69	-16.47	39.10	0.07	0.05	Average
2	0.156	50.97	65.69	-14.72	50.85	0.07	0.05	QP
3	0.213	33.95	53.10	-19.15	33.82	0.06	0.07	Average
4	0.213	43.23	63.10	-19.87	43.10	0.06	0.07	QP
5	0.484	33.67	46.27	-12.60	33.53	0.06	0.08	Average
6	0.484	39.47	56.27	-16.80	39.33	0.06	0.08	QP
7	0.727	32.70	46.00	-13.30	32.54	0.07	0.09	Average
8	0.727	34.80	56.00	-21.20	34.64	0.07	0.09	QP
9*	19.434	44.94	50.00	-5.06	44.10	0.24	0.60	Average
10	19.434	45.75	60.00	-14.25	44.91	0.24	0.60	QP
11	26.481	38.41	50.00	-11.59	37.42	0.27	0.72	Average
12	26.481	42.86	60.00	-17.14	41.87	0.27	0.72	QP

Note 1: Level (dBuV) = Read Level (dBuV) + LISN Factor (dB) + Cable Loss (dB).
 2: Over Limit (dB) = Level (dBuV) – Limit Line (dBuV).

Modulation	VHT20	Test Freq. (MHz)	5200
Power Phase	Neutral	Test Configuration	2

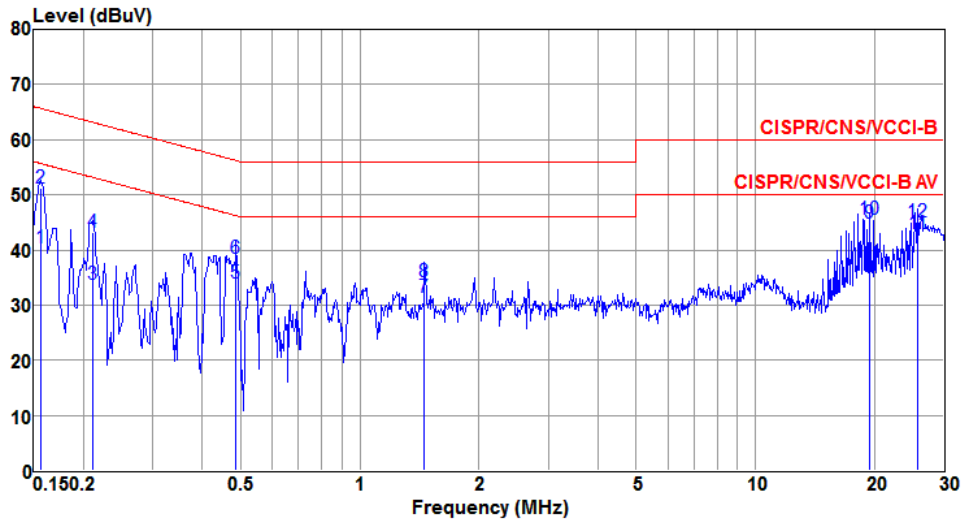

	Freq	Level	Limit	Over	Read	LISN	cable	
	MHz	dBuV	Line	Limit	Level	factor	loss	Remark
			dBuV	dB	dBuV	dB	dB	
1	0.156	40.36	55.65	-15.29	40.26	0.05	0.05	Average
2	0.156	51.12	65.65	-14.53	51.02	0.05	0.05	QP
3	0.211	33.76	53.18	-19.42	33.65	0.04	0.07	Average
4	0.211	43.30	63.18	-19.88	43.19	0.04	0.07	QP
5	0.486	33.94	46.23	-12.29	33.81	0.05	0.08	Average
6	0.486	38.58	56.23	-17.65	38.45	0.05	0.08	QP
7	1.456	31.45	46.00	-14.55	31.25	0.07	0.13	Average
8	1.456	34.20	56.00	-21.80	34.00	0.07	0.13	QP
9*	19.434	44.80	50.00	-5.20	43.94	0.26	0.60	Average
10	19.434	45.57	60.00	-14.43	44.71	0.26	0.60	QP
11	25.750	42.85	50.00	-7.15	41.85	0.30	0.70	Average
12	25.750	45.04	60.00	-14.96	44.04	0.30	0.70	QP

Note 1: Level (dBuV) = Read Level (dBuV) + LISN Factor (dB) + Cable Loss (dB).
 2: Over Limit (dB) = Level (dBuV) – Limit Line (dBuV).

Modulation	VHT40	Test Freq. (MHz)	5755
Power Phase	Line	Test Configuration	2

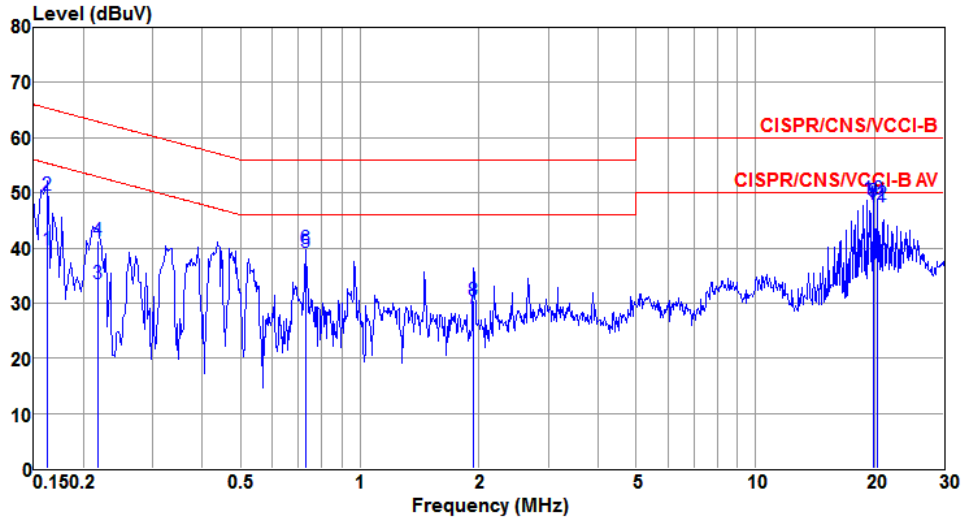

	Freq MHz	Level dBuV	Limit Line dBuV	Over Limit dB	Read Level dBuV	LISN factor dB	cable loss dB	Remark
1	0.162	39.77	55.34	-15.57	39.64	0.07	0.06	Average
2	0.162	49.66	65.34	-15.68	49.53	0.07	0.06	QP
3	0.219	33.49	52.88	-19.39	33.36	0.06	0.07	Average
4	0.219	41.20	62.88	-21.68	41.07	0.06	0.07	QP
5	0.727	39.24	46.00	-6.76	39.08	0.07	0.09	Average
6	0.727	39.92	56.00	-16.08	39.76	0.07	0.09	QP
7	1.939	29.13	46.00	-16.87	28.88	0.09	0.16	Average
8	1.939	30.51	56.00	-25.49	30.26	0.09	0.16	QP
9*	19.912	48.44	50.00	-1.56	47.60	0.24	0.60	Average
10	19.912	48.86	60.00	-11.14	48.02	0.24	0.60	QP
11	20.397	47.47	50.00	-2.53	46.62	0.24	0.61	Average
12	20.397	47.97	60.00	-12.03	47.12	0.24	0.61	QP

Note 1: Level (dBuV) = Read Level (dBuV) + LISN Factor (dB) + Cable Loss (dB).
 2: Over Limit (dB) = Level (dBuV) – Limit Line (dBuV).

Modulation	VHT40	Test Freq. (MHz)	5755
Power Phase	Neutral	Test Configuration	2

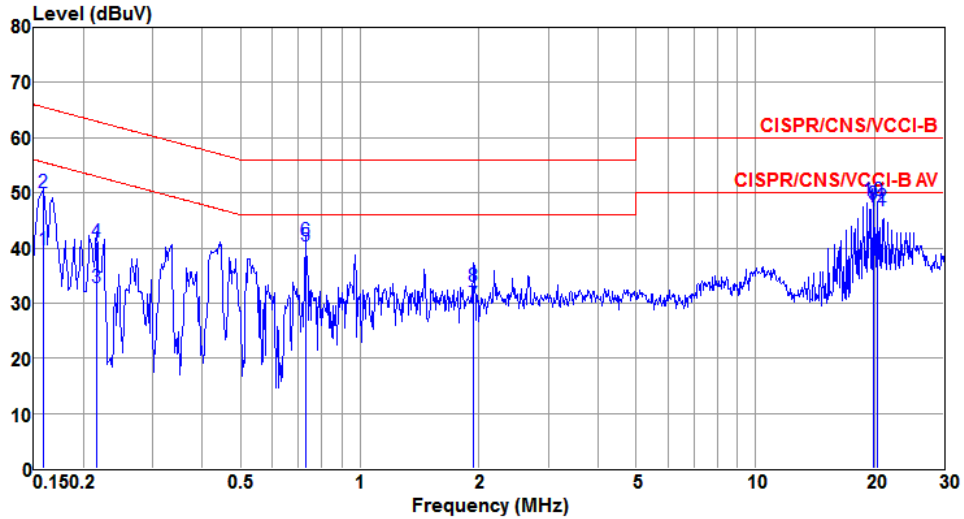

	Freq	Level	Limit	Over	Read	LISN	cable	
	MHz	dBuV	Line	Limit	Level	factor	loss	Remark
			dBuV	dB	dBuV	dB	dB	
1	0.159	39.63	55.52	-15.89	39.53	0.05	0.05	Average
2	0.159	49.94	65.52	-15.58	49.84	0.05	0.05	QP
3	0.216	32.79	52.96	-20.17	32.68	0.04	0.07	Average
4	0.216	41.17	62.96	-21.79	41.06	0.04	0.07	QP
5	0.727	40.47	46.00	-5.53	40.32	0.06	0.09	Average
6	0.727	41.37	56.00	-14.63	41.22	0.06	0.09	QP
7	1.939	29.70	46.00	-16.30	29.47	0.07	0.16	Average
8	1.939	33.10	56.00	-22.90	32.87	0.07	0.16	QP
9*	19.912	47.83	50.00	-2.17	46.97	0.26	0.60	Average
10	19.912	48.63	60.00	-11.37	47.77	0.26	0.60	QP
11	20.395	46.65	50.00	-3.35	45.78	0.26	0.61	Average
12	20.395	47.44	60.00	-12.56	46.57	0.26	0.61	QP

Note 1: Level (dBuV) = Read Level (dBuV) + LISN Factor (dB) + Cable Loss (dB).
 2: Over Limit (dB) = Level (dBuV) – Limit Line (dBuV).

3.2 Emission Bandwidth

3.2.1 Limit of Emission bandwidth

Within the 5.725-5.85 GHz band, the minimum 6 dB bandwidth of U-NII devices shall be at least 500 kHz.

3.2.2 Test Procedures

26dB Bandwidth

1. Set RBW = approximately 1% of the emission bandwidth.
2. Set the VBW > RBW, Detector = Peak.
3. Trace mode = max hold.
4. Measure the maximum width of the emission that is 26 dB down from the peak of the emission.

Occupied Bandwidth

1. Set RBW = 1 % to 5 % of the OBW.
2. Set VBW \geq 3 RBW.
3. Sample detection and single sweep mode shall be used.
4. Use the 99 % power bandwidth function of the instrument.

6dB Bandwidth

1. Set RBW = 100kHz, VBW = 300kHz.
2. Detector = Peak, Trace mode = max hold.
3. Allow the trace to stabilize.
4. Measure the maximum width of the emission that is constrained by the frequencies associated with the two outermost amplitude points (upper and lower frequencies) that are attenuated by 6 dB relative to the maximum level measured in the fundamental emission.

3.2.3 Test Setup

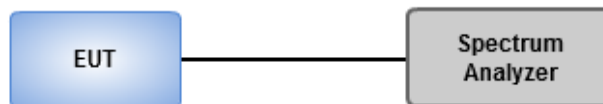

3.2.4 Test Result of Emission Bandwidth

Non-beamforming mode

Summary

Mode	Max-N dB (Hz)	Max-OBW (Hz)	ITU-Code	Min-N dB (Hz)	Min-OBW (Hz)
5.15-5.25GHz	-	-	-	-	-
802.11a_Nss1,(6Mbps)_2TX	39.493M	23.661M	23M7D1D	18.841M	16.425M
802.11ac VHT20_Nss1,(MCS0)_2TX	47.899M	30.97M	31M0D1D	20.435M	17.583M
802.11ac VHT40_Nss1,(MCS0)_2TX	65.362M	36.324M	36M3D1D	39.275M	35.89M
802.11ac VHT80_Nss1,(MCS0)_2TX	83.188M	75.832M	75M8D1D	83.188M	75.543M
5.725-5.85GHz	-	-	-	-	-
802.11a_Nss1,(6Mbps)_4TX	16.304M	16.715M	16M7D1D	15.435M	16.425M
802.11ac VHT20_Nss1,(MCS0)_4TX	17.609M	17.8M	17M8D1D	15.652M	17.583M
802.11ac VHT40_Nss1,(MCS0)_4TX	35.072M	36.179M	36M2D1D	31.159M	35.89M
802.11ac VHT80_Nss1,(MCS0)_4TX	76.522M	75.832M	75M8D1D	74.783M	75.543M

Max-N dB = Maximum6dB downbandwidth for 5.725-5.85GHz band / Maximum26dB downbandwidth for other band;

Max-OBW = Maximum99% occupied bandwidth;

Min-N dB = Minimum6dB downbandwidth for 5.725-5.85GHz band / Maximum26dB downbandwidth for other band;

Min-OBW = Minimum99% occupied bandwidth;

Result

Mode	Result	Limit (Hz)	Port 1- N dB (Hz)	Port 1 -OBW (Hz)	Port 2 -N dB (Hz)	Port 2 -OBW (Hz)	Port 3 -N dB (Hz)	Port 3 -OBW (Hz)	Port 4 -N dB (Hz)	Port 4 -OBW (Hz)
802.11a_Nss1,(6Mbps)_2TX	-	-	-	-	-	-	-	-	-	-
5180MHz	Pass	Inf	18.841M	16.425M	20M	16.425M				
5200MHz	Pass	Inf	37.754M	18.234M	39.493M	23.661M				
5240MHz	Pass	Inf	36.739M	17.511M	36.667M	19.754M				
802.11a_Nss1,(6Mbps)_4TX	-	-	-	-	-	-	-	-	-	-
5745MHz	Pass	500k	16.304M	16.425M	16.304M	16.498M	15.435M	16.425M	16.304M	16.715M
5785MHz	Pass	500k	15.942M	16.425M	15.942M	16.425M	15.435M	16.425M	16.304M	16.57M
5825MHz	Pass	500k	16.304M	16.425M	16.304M	16.425M	15.652M	16.425M	16.304M	16.643M
802.11ac VHT20_Nss1,(MCS0)_2TX	-	-	-	-	-	-	-	-	-	-
5180MHz	Pass	Inf	20.435M	17.583M	22.319M	17.656M				
5200MHz	Pass	Inf	44.42M	23.806M	47.899M	30.97M				
5240MHz	Pass	Inf	37.246M	18.452M	42.319M	19.971M				
802.11ac VHT20_Nss1,(MCS0)_4TX	-	-	-	-	-	-	-	-	-	-
5745MHz	Pass	500k	15.652M	17.583M	17.609M	17.656M	15.652M	17.583M	17.609M	17.8M
5785MHz	Pass	500k	17.609M	17.656M	17.174M	17.583M	16.304M	17.583M	17.174M	17.8M
5825MHz	Pass	500k	17.609M	17.656M	17.609M	17.656M	16.667M	17.583M	17.609M	17.656M
802.11ac VHT40_Nss1,(MCS0)_2TX	-	-	-	-	-	-	-	-	-	-
5190MHz	Pass	Inf	39.275M	35.89M	39.42M	35.89M				
5230MHz	Pass	Inf	55.942M	36.179M	65.362M	36.324M				
802.11ac VHT40_Nss1,(MCS0)_4TX	-	-	-	-	-	-	-	-	-	-
5755MHz	Pass	500k	33.913M	35.89M	33.913M	35.89M	35.072M	35.89M	34.493M	36.035M
5795MHz	Pass	500k	31.159M	35.89M	32.029M	35.89M	33.768M	36.035M	31.449M	36.179M
802.11ac VHT80_Nss1,(MCS0)_2TX	-	-	-	-	-	-	-	-	-	-
5210MHz	Pass	Inf	83.188M	75.832M	83.188M	75.543M				
802.11ac VHT80_Nss1,(MCS0)_4TX	-	-	-	-	-	-	-	-	-	-
5775MHz	Pass	500k	74.783M	75.832M	75.942M	75.543M	76.232M	75.832M	76.522M	75.543M

Port X-N dB = Port XdB downbandwidth for 5.725-5.85GHz band / 26dB downbandwidth for other band

Port X-OBW = Port X99% occupied bandwidth;

802.11a_Nss1,(6Mbps)_2TX

EBW

5180MHz

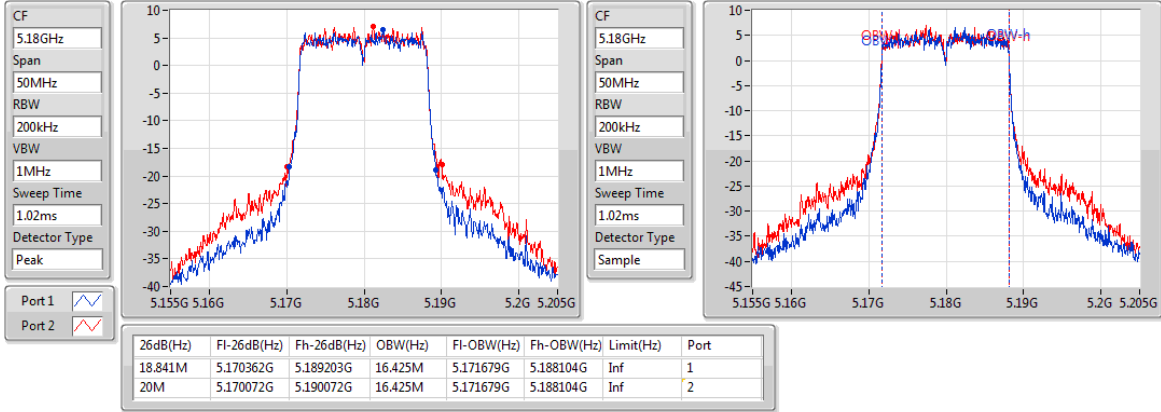

802.11a_Nss1,(6Mbps)_2TX

EBW

5200MHz

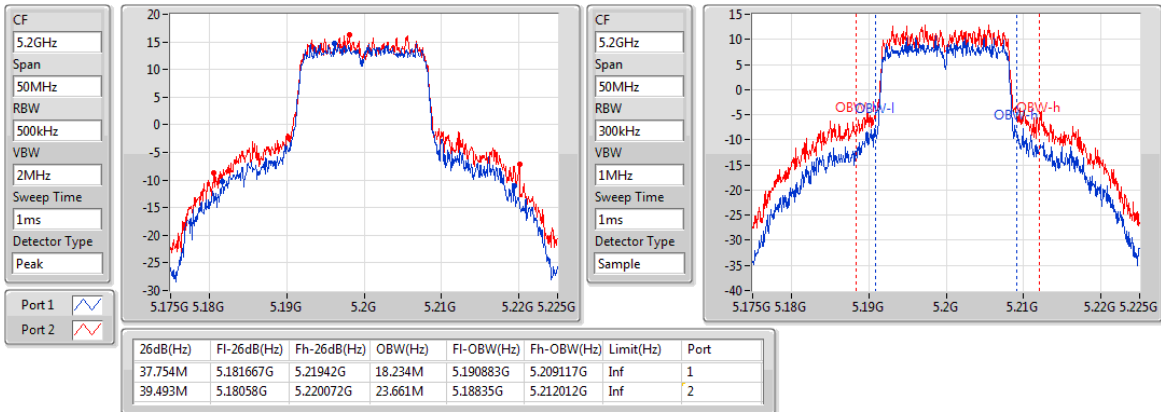

802.11a_Nss1,(6Mbps)_2TX

EBW

5240MHz

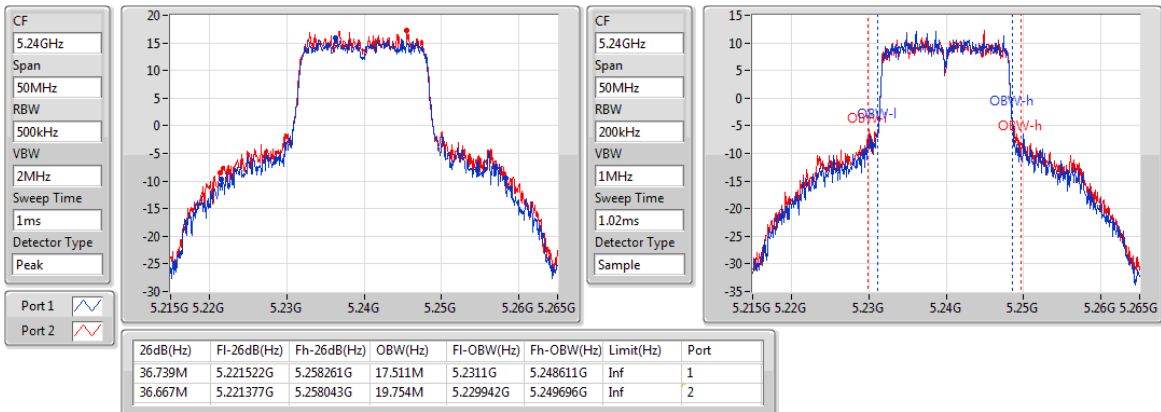

802.11a_Nss1,(6Mbps)_4TX

EBW

5745MHz

CF
5.745GHz
Span
50MHz
RBW
100kHz
VBW
300kHz
Sweep Time
1.08ms
Detector Type
Peak

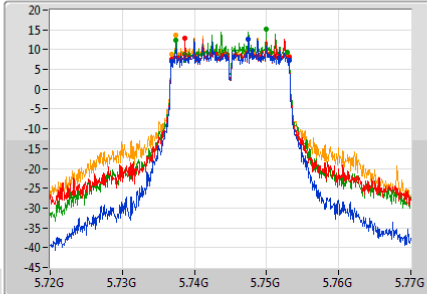

CF
5.745GHz
Span
50MHz
RBW
200kHz
VBW
1MHz
Sweep Time
1.02ms
Detector Type
Sample

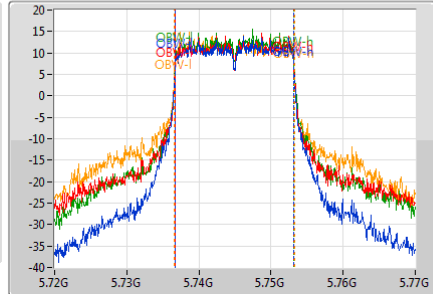

6dB(Hz)	Fl-6dB(Hz)	Fh-6dB(Hz)	OBW(Hz)	Fl-OBW(Hz)	Fh-OBW(Hz)	Limit(Hz)	Port
16.304M	5.736812G	5.753116G	16.425M	5.736751G	5.753177G	500k	1
16.304M	5.736812G	5.753116G	16.498M	5.736679G	5.753177G	500k	2
15.435M	5.737391G	5.752826G	16.425M	5.736751G	5.753177G	500k	3
16.304M	5.736812G	5.753116G	16.715M	5.736534G	5.753249G	500k	4

802.11a_Nss1,(6Mbps)_4TX

EBW

5785MHz

CF
5.785GHz
Span
50MHz
RBW
100kHz
VBW
300kHz
Sweep Time
1.08ms
Detector Type
Peak

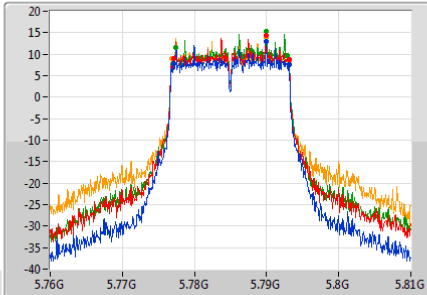

CF
5.785GHz
Span
50MHz
RBW
200kHz
VBW
1MHz
Sweep Time
1.02ms
Detector Type
Sample

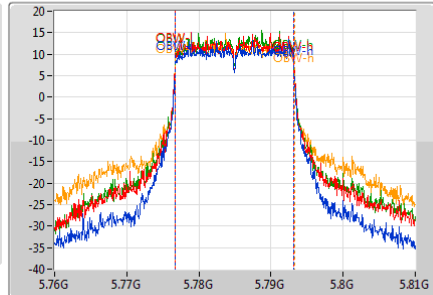

6dB(Hz)	Fl-6dB(Hz)	Fh-6dB(Hz)	OBW(Hz)	Fl-OBW(Hz)	Fh-OBW(Hz)	Limit(Hz)	Port
15.942M	5.777174G	5.793116G	16.425M	5.776751G	5.793177G	500k	1
15.942M	5.777174G	5.793116G	16.425M	5.776751G	5.793177G	500k	2
15.435M	5.777391G	5.792826G	16.425M	5.776751G	5.793177G	500k	3
16.304M	5.776812G	5.793116G	16.57M	5.776679G	5.793249G	500k	4

802.11a_Nss1,(6Mbps)_4TX

EBW

5825MHz

CF
5.825GHz
Span
50MHz
RBW
100kHz
VBW
300kHz
Sweep Time
1.08ms
Detector Type
Peak

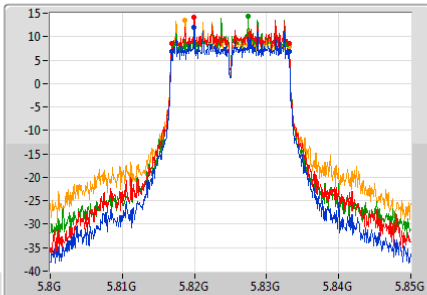

CF
5.825GHz
Span
50MHz
RBW
200kHz
VBW
1MHz
Sweep Time
1.02ms
Detector Type
Sample

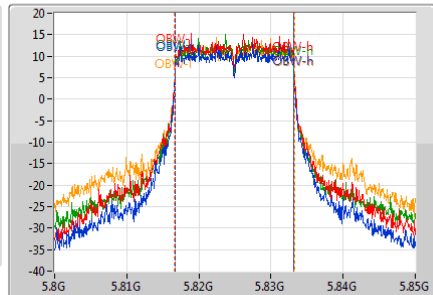

6dB(Hz)	Fl-6dB(Hz)	Fh-6dB(Hz)	OBW(Hz)	Fl-OBW(Hz)	Fh-OBW(Hz)	Limit(Hz)	Port
16.304M	5.816812G	5.833116G	16.425M	5.816751G	5.833177G	500k	1
16.304M	5.816812G	5.833116G	16.425M	5.816751G	5.833177G	500k	2
15.652M	5.817174G	5.832826G	16.425M	5.816751G	5.833177G	500k	3
16.304M	5.816812G	5.833116G	16.643M	5.816606G	5.833249G	500k	4

802.11ac VHT20_Nss1,(MCS0)_2TX

EBW

5180MHz

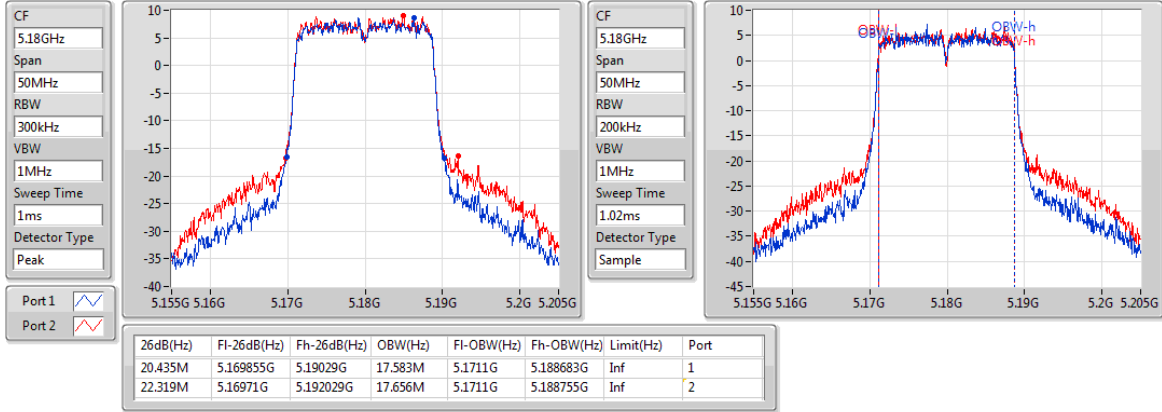

802.11ac VHT20_Nss1,(MCS0)_2TX

EBW

5200MHz

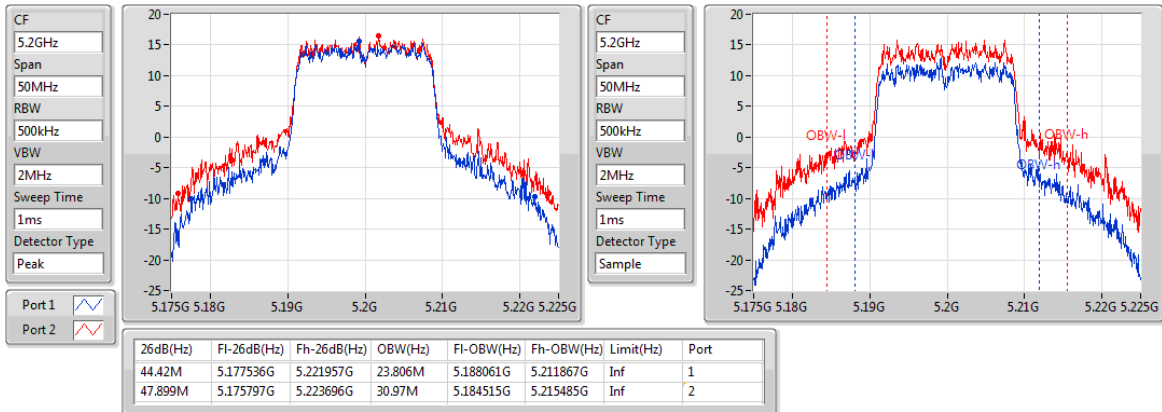

802.11ac VHT20_Nss1,(MCS0)_2TX

EBW

5240MHz

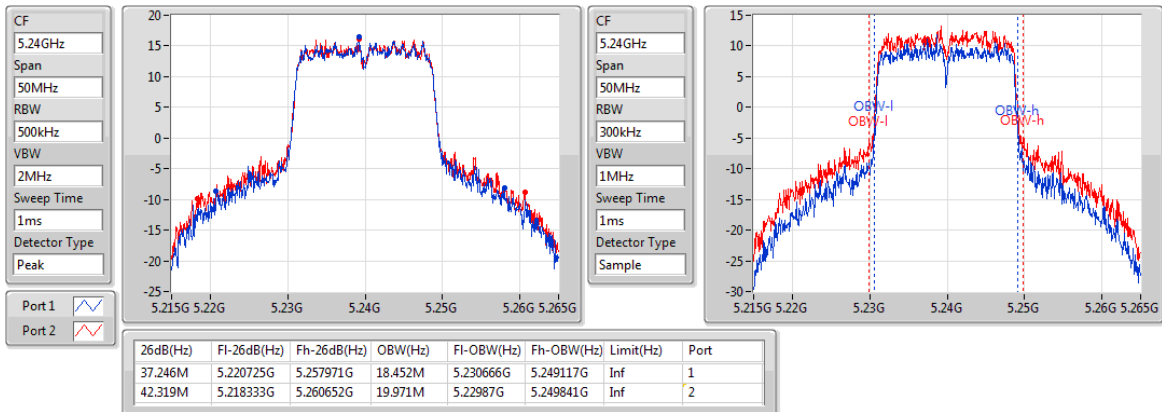

802.11ac VHT20_Nss1,(MCS0)_4TX

EBW

5745MHz

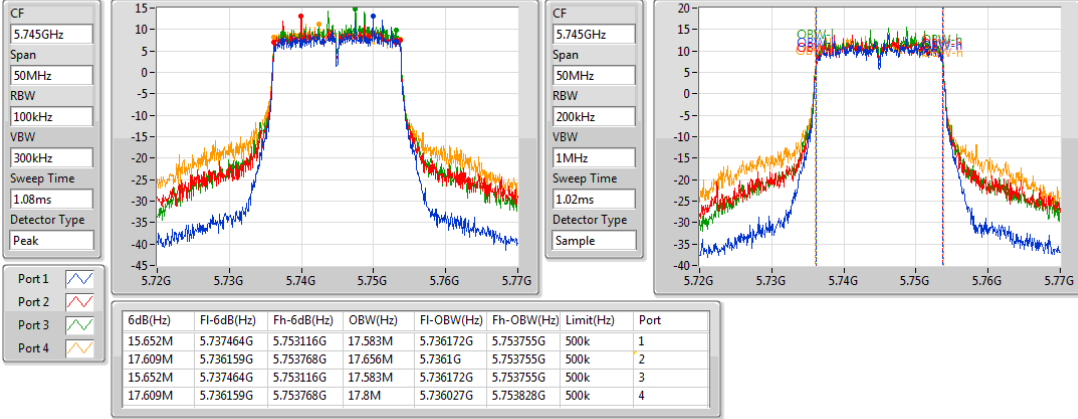

802.11ac VHT20_Nss1,(MCS0)_4TX

EBW

5785MHz

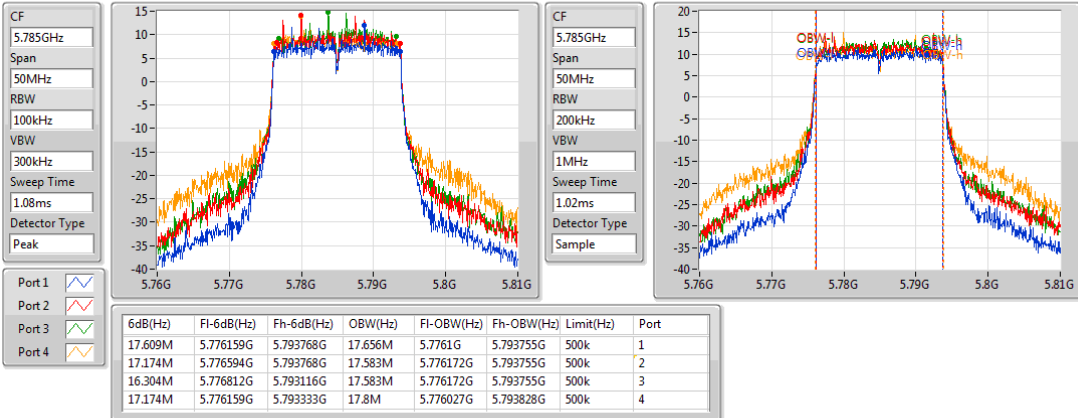

802.11ac VHT20_Nss1,(MCS0)_4TX

EBW

5825MHz

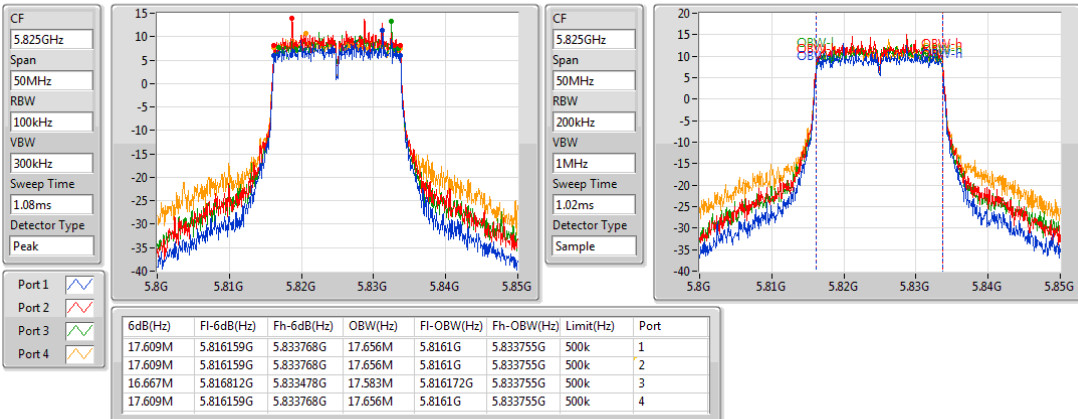

802.11ac VHT40_Nss1,(MCS0)_2TX

EBW

5190MHz

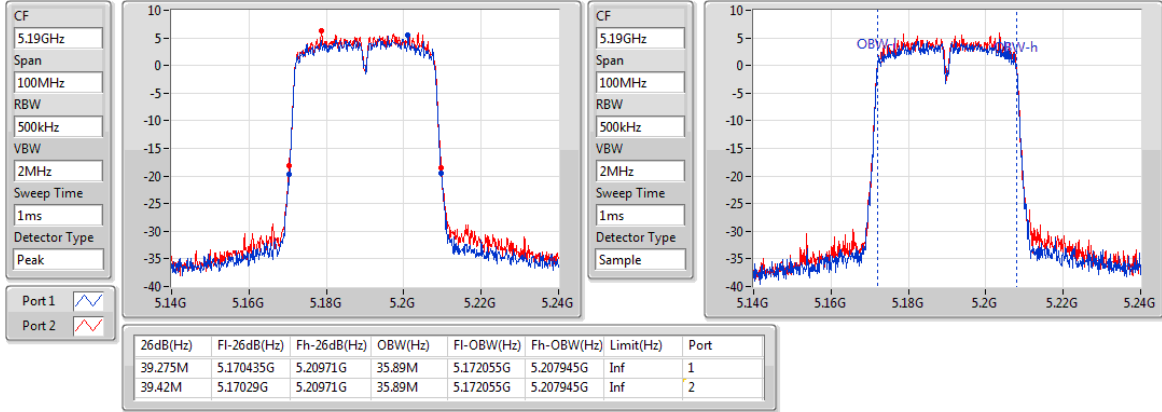

802.11ac VHT40_Nss1,(MCS0)_2TX

EBW

5230MHz

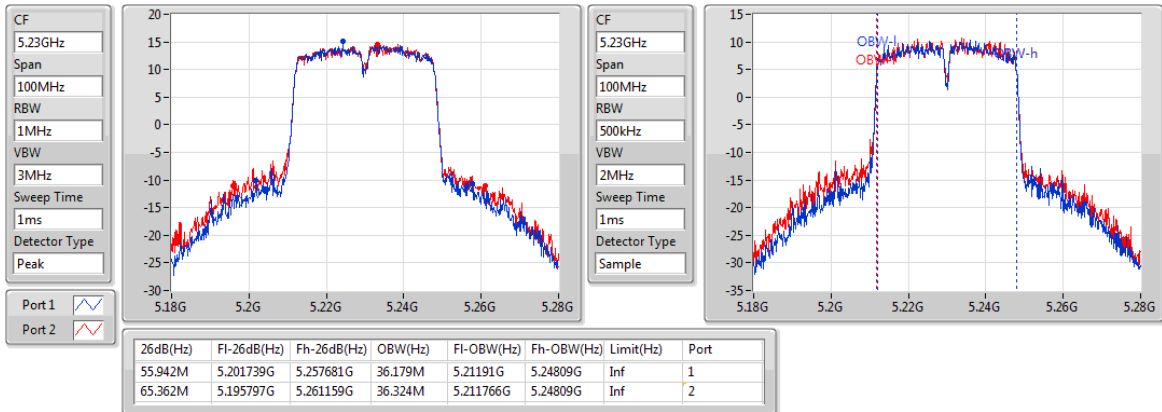

802.11ac VHT40_Nss1,(MCS0)_4TX

EBW

5755MHz

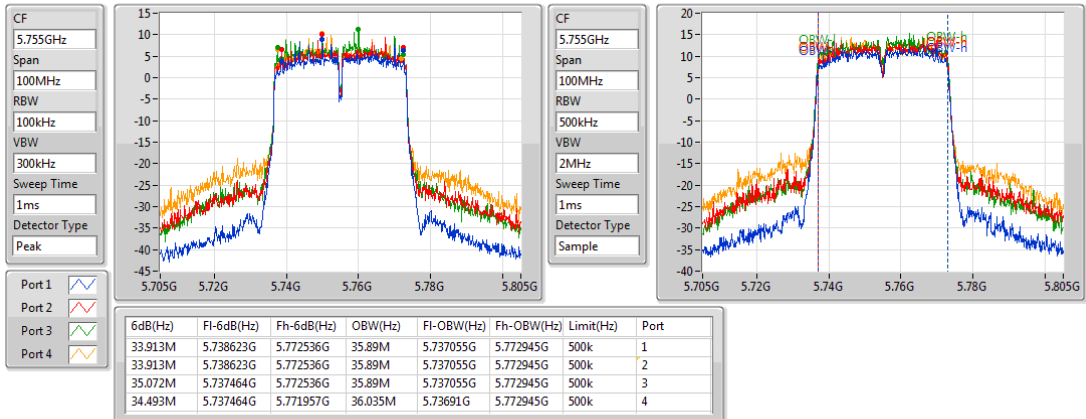

802.11ac VHT40_Nss1,(MCS0)_4TX

EBW

5795MHz

CF
5.795GHz
Span
100MHz
RBW
100kHz
VBW
300kHz
Sweep Time
1ms
Detector Type
Peak

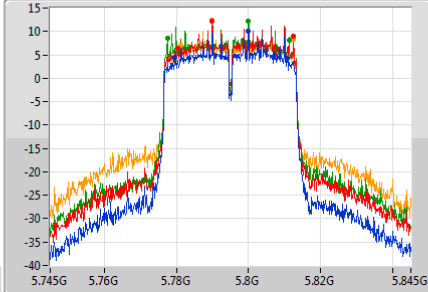

CF
5.795GHz
Span
100MHz
RBW
500kHz
VBW
2MHz
Sweep Time
1ms
Detector Type
Sample

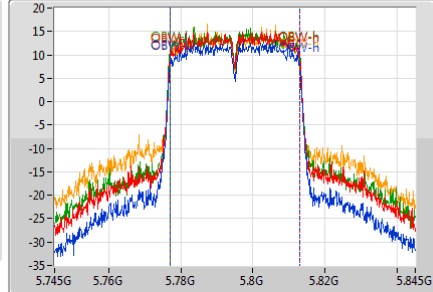

6dB(Hz)	Fl-6dB(Hz)	Fh-6dB(Hz)	OBW(Hz)	Fl-OBW(Hz)	Fh-OBW(Hz)	Limit(Hz)	Port
31.159M	5.779638G	5.810797G	35.89M	5.777055G	5.812945G	500k	1
32.029M	5.780507G	5.812536G	35.89M	5.777055G	5.812945G	500k	2
33.768M	5.777464G	5.811232G	36.035M	5.77691G	5.812945G	500k	3
31.449M	5.781087G	5.812536G	36.179M	5.77691G	5.81309G	500k	4

802.11ac VHT80_Nss1,(MCS0)_2TX

EBW

5210MHz

CF
5.21GHz
Span
200MHz
RBW
1MHz
VBW
3MHz
Sweep Time
1ms
Detector Type
Peak

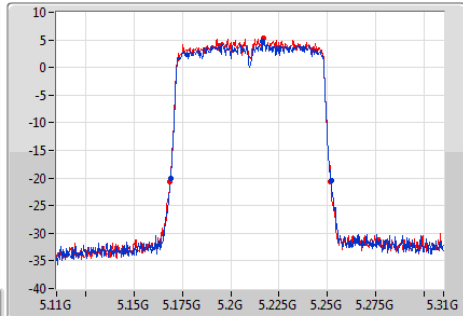

CF
5.21GHz
Span
200MHz
RBW
1MHz
VBW
3MHz
Sweep Time
1ms
Detector Type
Sample

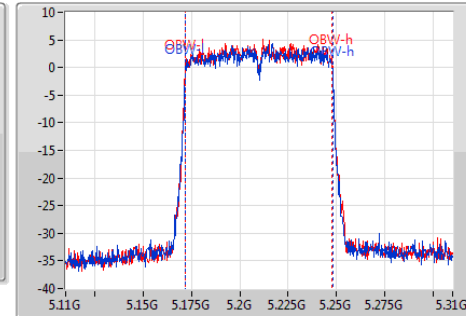

26dB(Hz)	Fl-26dB(Hz)	Fh-26dB(Hz)	OBW(Hz)	Fl-OBW(Hz)	Fh-OBW(Hz)	Limit(Hz)	Port
83.188M	5.168841G	5.252029G	75.832M	5.172084G	5.247916G	Inf	1
83.188M	5.168551G	5.251739G	75.543M	5.172084G	5.247627G	Inf	2

802.11ac VHT80_Nss1,(MCS0)_4TX

EBW

5775MHz

CF
5.775GHz
Span
200MHz
RBW
100kHz
VBW
300kHz
Sweep Time
2ms
Detector Type
Peak

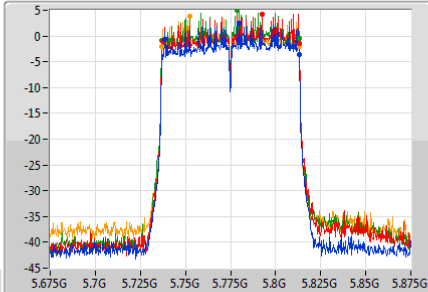

CF
5.775GHz
Span
200MHz
RBW
1MHz
VBW
3MHz
Sweep Time
1ms
Detector Type
Sample



6dB(Hz)	Fl-6dB(Hz)	Fh-6dB(Hz)	OBW(Hz)	Fl-OBW(Hz)	Fh-OBW(Hz)	Limit(Hz)	Port
74.783M	5.738478G	5.813261G	75.832M	5.737084G	5.812916G	500k	1
75.942M	5.737319G	5.813261G	75.543M	5.737373G	5.812916G	500k	2
76.232M	5.737029G	5.813261G	75.832M	5.737084G	5.812916G	500k	3
76.522M	5.736739G	5.813261G	75.543M	5.737084G	5.812627G	500k	4

Beamforming mode

Summary

Mode	Max-N dB (Hz)	Max-OBW (Hz)	ITU-Code	Min-N dB (Hz)	Min-OBW (Hz)
5.15-5.25GHz	-	-	-	-	-
802.11ac VHT20-BF_Nss1,(MCS0)_2TX	46.159M	28.944M	28M9D1D	21.232M	17.656M
802.11ac VHT40-BF_Nss1,(MCS0)_2TX	77.826M	37.048M	37M0D1D	38.261M	35.89M
802.11ac VHT80-BF_Nss1,(MCS0)_2TX	82.899M	75.832M	75M8D1D	82.319M	75.253M
5.725-5.85GHz	-	-	-	-	-
802.11ac VHT20-BF_Nss1,(MCS0)_4TX	17.681M	17.656M	17M7D1D	15.942M	17.438M
802.11ac VHT40-BF_Nss1,(MCS0)_4TX	35.797M	36.179M	36M2D1D	30.145M	35.89M
802.11ac VHT80-BF_Nss1,(MCS0)_4TX	75.652M	75.832M	75M8D1D	75.652M	75.253M

Max-N dB = Maximum6dB downbandwidth for 5.725-5.85GHz band / Maximum26dB downbandwidth for other band;

Max-OBW = Maximum99% occupied bandwidth;

Min-N dB = Minimum6dB downbandwidth for 5.725-5.85GHz band / Maximum26dB downbandwidth for other band;

Min-OBW = Minimum99% occupied bandwidth;

Result

Mode	Result	Limit (Hz)	Port 1 -N dB (Hz)	Port 1 -OBW (Hz)	Port 2 -N dB (Hz)	Port 2 -OBW (Hz)	Port 3 -N dB (Hz)	Port 3 -OBW (Hz)	Port 4 -N dB (Hz)	Port 4 -OBW (Hz)
802.11ac VHT20-BF_Nss1,(MCS0)_2TX	-	-	-	-	-	-	-	-	-	-
5180MHz	Pass	Inf	21.232M	17.656M	25.652M	17.728M				
5200MHz	Pass	Inf	42.826M	24.602M	46.159M	28.944M				
5240MHz	Pass	Inf	27.826M	17.728M	36.957M	18.452M				
802.11ac VHT20-BF_Nss1,(MCS0)_4TX	-	-	-	-	-	-	-	-	-	-
5745MHz	Pass	500k	17.174M	17.583M	17.391M	17.583M	16.159M	17.583M	15.942M	17.438M
5785MHz	Pass	500k	17.029M	17.583M	17.681M	17.656M	16.812M	17.583M	17.319M	17.656M
5825MHz	Pass	500k	17.536M	17.656M	17.101M	17.583M	17.391M	17.511M	16.232M	17.583M
802.11ac VHT40-BF_Nss1,(MCS0)_2TX	-	-	-	-	-	-	-	-	-	-
5190MHz	Pass	Inf	38.841M	35.89M	38.261M	36.035M				
5230MHz	Pass	Inf	40M	36.324M	77.826M	37.048M				
802.11ac VHT40-BF_Nss1,(MCS0)_4TX	-	-	-	-	-	-	-	-	-	-
5755MHz	Pass	500k	35.072M	35.89M	31.014M	36.035M	35.797M	36.179M	35.797M	36.179M
5795MHz	Pass	500k	33.913M	35.89M	35.797M	36.179M	30.145M	36.035M	35.362M	36.035M
802.11ac VHT80-BF_Nss1,(MCS0)_2TX	-	-	-	-	-	-	-	-	-	-
5210MHz	Pass	Inf	82.899M	75.832M	82.319M	75.253M				
802.11ac VHT80-BF_Nss1,(MCS0)_4TX	-	-	-	-	-	-	-	-	-	-
5775MHz	Pass	500k	75.652M	75.253M	75.652M	75.832M	75.652M	75.832M	75.652M	75.832M

Port X-N dB = Port X6dB downbandwidth for 5.725-5.85GHz band / 26dB downbandwidth for other band

Port X-OBW = Port X99% occupied bandwidth;

802.11ac VHT20-BF_Nss1,(MCS0)_2TX

EBW

5180MHz

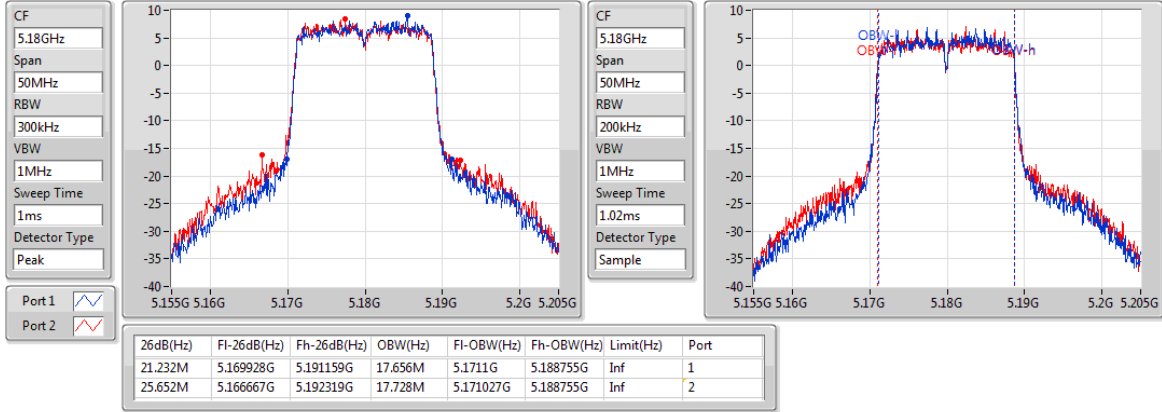

802.11ac VHT20-BF_Nss1,(MCS0)_2TX

EBW

5200MHz

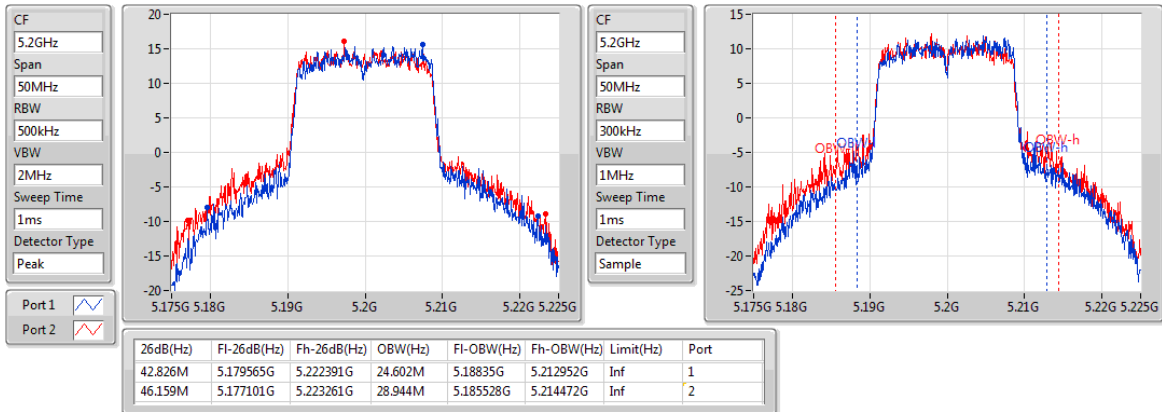

802.11ac VHT20-BF_Nss1,(MCS0)_2TX

EBW

5240MHz

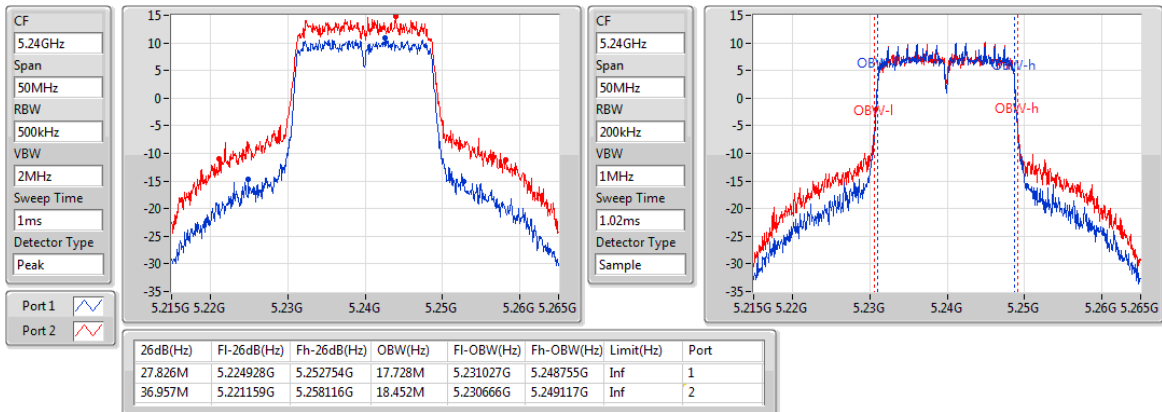

802.11ac VHT20-BF_Nss1,(MCS0)_4TX

EBW

5745MHz

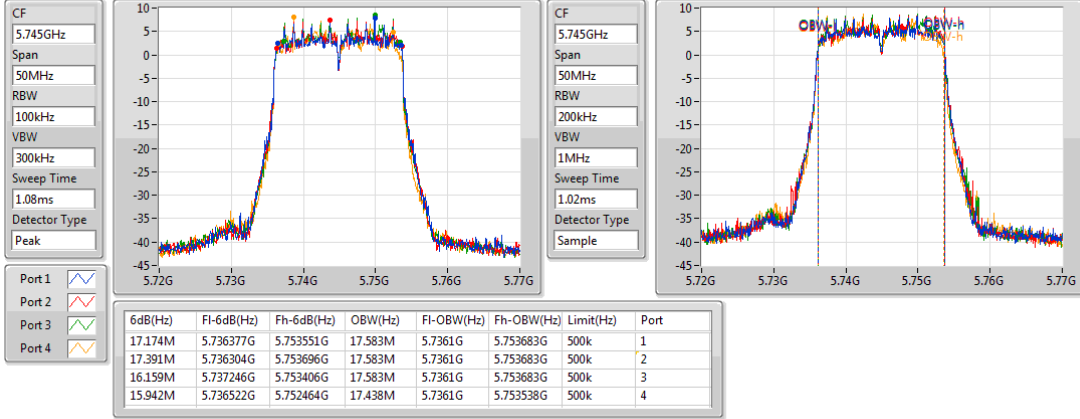

802.11ac VHT20-BF_Nss1,(MCS0)_4TX

EBW

5785MHz

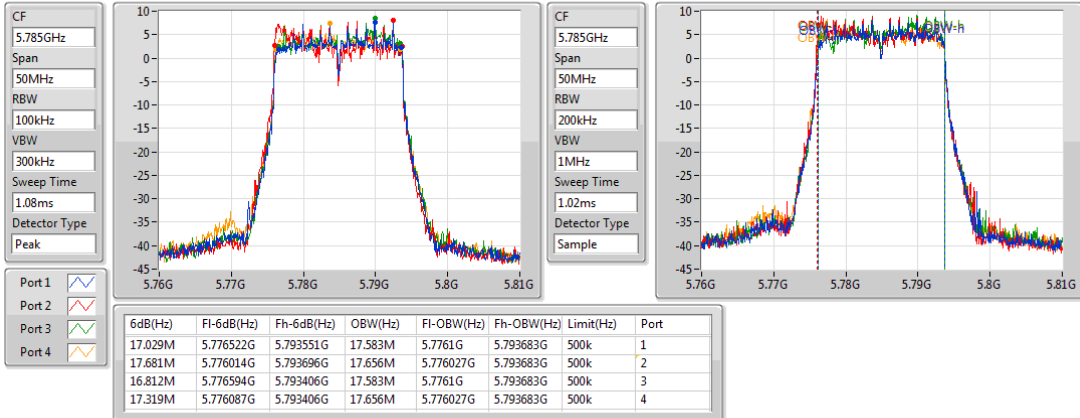

802.11ac VHT20-BF_Nss1,(MCS0)_4TX

EBW

5825MHz

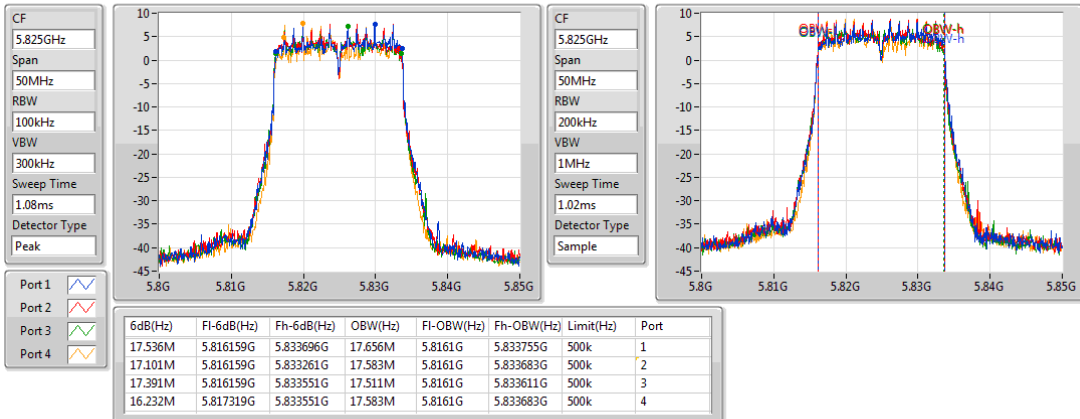

802.11ac VHT40-BF_Nss1,(MCS0)_2TX

EBW

5190MHz

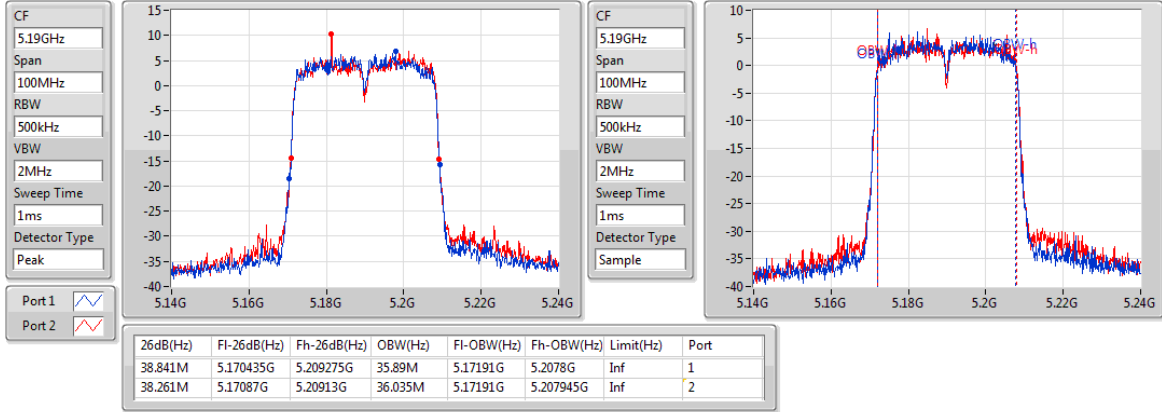

802.11ac VHT40-BF_Nss1,(MCS0)_2TX

EBW

5230MHz

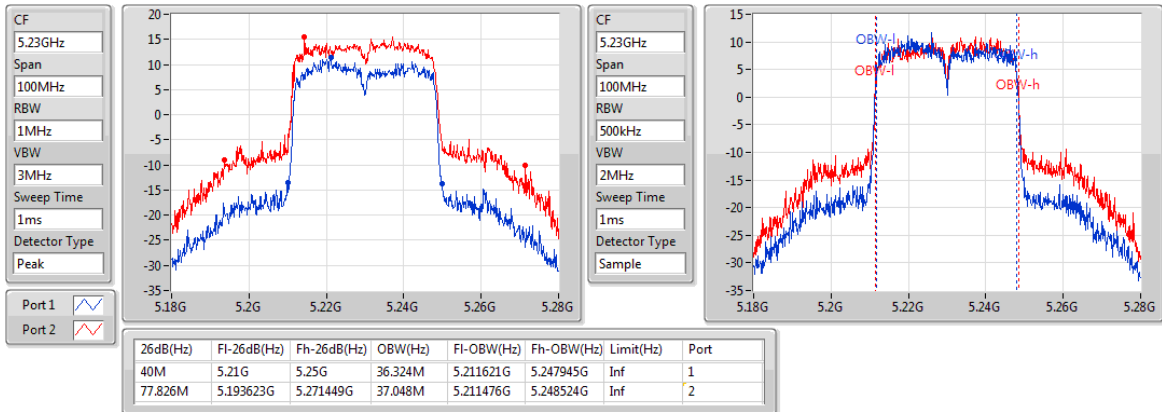

802.11ac VHT40-BF_Nss1,(MCS0)_4TX

EBW

5755MHz

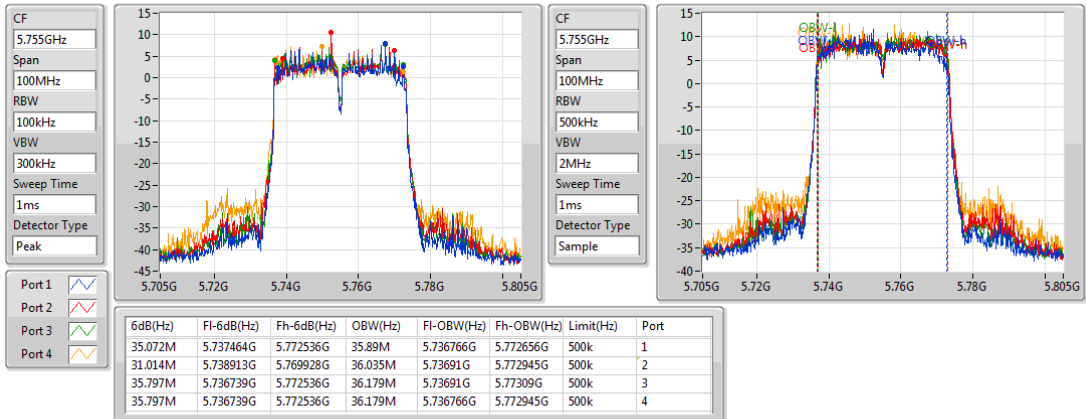

802.11ac VHT40-BF_Nss1,(MCS0)_4TX

EBW

5795MHz

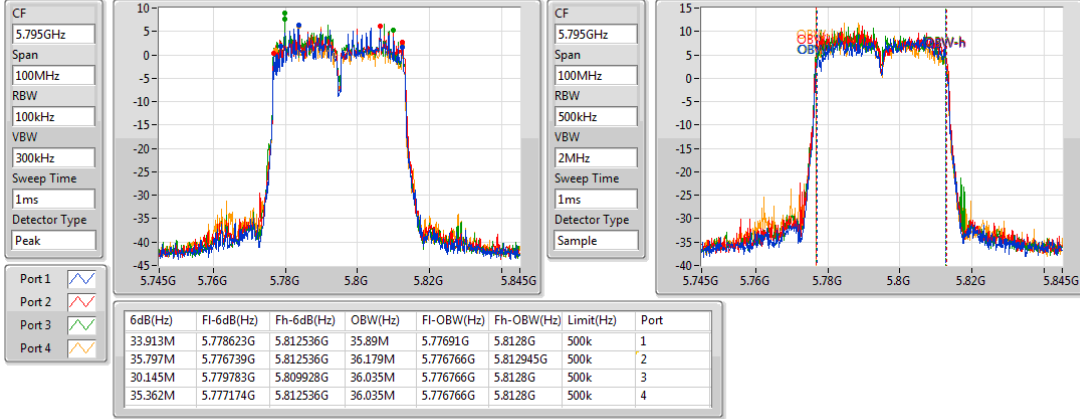

802.11ac VHT80-BF_Nss1,(MCS0)_2TX

EBW

5210MHz

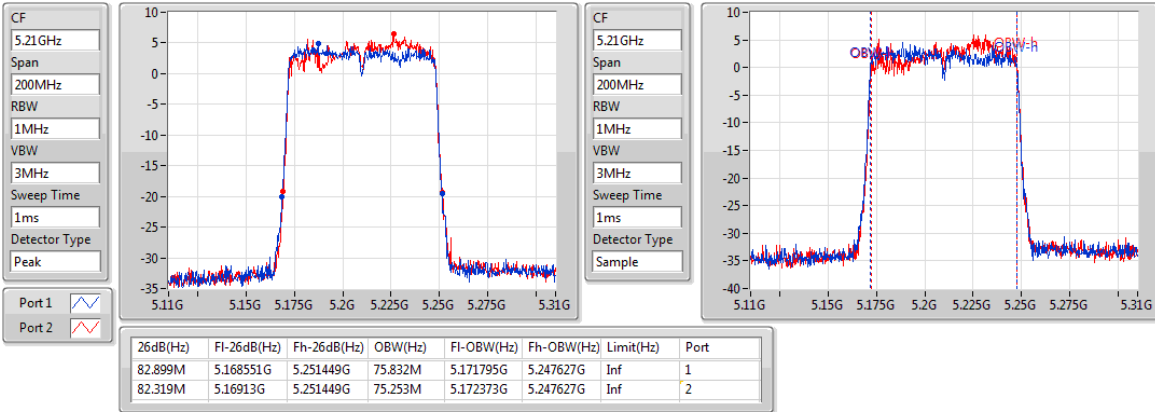

802.11ac VHT80-BF_Nss1,(MCS0)_4TX

EBW

5775MHz

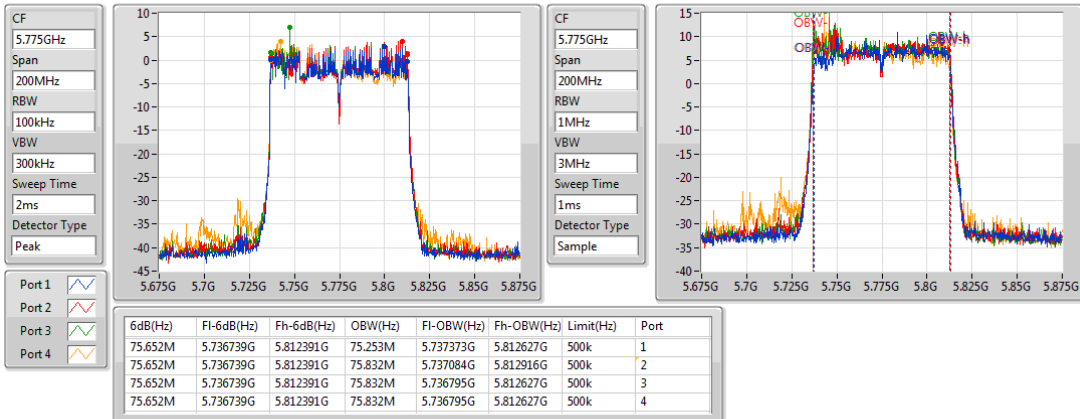

3.3 RF Output Power

3.3.1 Limit of RF Output Power

Frequency band 5150-5250 MHz		
Operating Mode		Limit
<input type="checkbox"/>	Outdoor access point	Conducted Power: 1 W The maximum e.i.r.p. at any elevation angle above 30 degrees as measured from the horizon must not exceed 125 mW (21 dBm)
<input checked="" type="checkbox"/>	Indoor access point	Conducted Power: 1 W
<input type="checkbox"/>	Fixed point-to-point access points	Conducted Power: 1 W
<input type="checkbox"/>	Client devices	Conducted Power: 250 mW

Frequency Band (MHz)	Limit
<input checked="" type="checkbox"/> 5725 ~ 5850	1 W

Note: "B" is the 26dB emission bandwidth in MHz.

3.3.2 Test Procedures

Method PM-G (Measurement using a gated RF average power meter)

Measurements is performed using a wideband gated RF power meter provided that the gate parameters are adjusted such that the power is measured only when the EUT is transmitting at its maximum power control level. Since the measurement is made only during the ON time of the transmitter, no duty cycle correction factor is required.

3.3.3 Test Setup

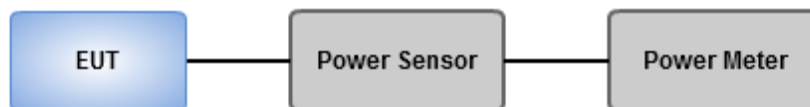

3.3.4 Test Result of Maximum Conducted Output Power

Non-beamforming mode

Summary

Mode	Total Power (dBm)	Total Power (W)	EIRP (dBm)	EIRP (W)
5.15-5.25GHz	-	-	-	-
802.11a_Nss1,(6Mbps)_2TX	25.11	0.32434	28.41	0.69343
802.11ac VHT20_Nss1,(MCS0)_2TX	25.07	0.32137	28.37	0.68707
802.11ac VHT40_Nss1,(MCS0)_2TX	23.39	0.21827	26.69	0.46666
802.11ac VHT80_Nss1,(MCS0)_2TX	16.73	0.04710	20.03	0.10069
5.725-5.85GHz	-	-	-	-
802.11a_Nss1,(6Mbps)_4TX	29.88	0.97275	34.18	2.61818
802.11ac VHT20_Nss1,(MCS0)_4TX	29.78	0.95060	34.08	2.55859
802.11ac VHT40_Nss1,(MCS0)_4TX	29.85	0.96605	34.15	2.60016
802.11ac VHT80_Nss1,(MCS0)_4TX	26.15	0.41210	30.45	1.10917

Result

Mode	Result	DG (dBi)	Port 1 (dBm)	Port 2 (dBm)	Port 3 (dBm)	Port 4 (dBm)	Total Power (dBm)	Power Limit (dBm)	EIRP (dBm)	EIRP Limit (dBm)
802.11a_Nss1,(6Mbps) _2TX	-	-	-	-	-	-	-	-	-	-
5180MHz	Pass	3.30	17.03	17.57			20.32	30.00	23.62	36.00
5200MHz	Pass	3.30	21.17	21.17			24.18	30.00	27.48	36.00
5240MHz	Pass	3.30	22.06	22.14			25.11	30.00	28.41	36.00
802.11a_Nss1,(6Mbps) _4TX	-	-	-	-	-	-	-	-	-	-
5745MHz	Pass	4.30	23.22	23.64	24.64	23.60	29.83	30.00	34.13	36.00
5785MHz	Pass	4.30	22.90	24.36	24.44	23.57	29.88	30.00	34.18	36.00
5825MHz	Pass	4.30	22.67	24.37	24.22	23.46	29.75	30.00	34.05	36.00
802.11ac VHT20_Nss1,(MCS0) _2TX	-	-	-	-	-	-	-	-	-	-
5180MHz	Pass	3.30	17.57	17.82			20.71	30.00	24.01	36.00
5200MHz	Pass	3.30	21.95	22.17			25.07	30.00	28.37	36.00
5240MHz	Pass	3.30	22.02	22.10			25.07	30.00	28.37	36.00
802.11ac VHT20_Nss1,(MCS0) _4TX	-	-	-	-	-	-	-	-	-	-
5745MHz	Pass	4.30	22.99	23.46	24.17	23.50	29.57	30.00	33.87	36.00
5785MHz	Pass	4.30	22.74	24.24	24.42	23.43	29.78	30.00	34.08	36.00
5825MHz	Pass	4.30	22.49	24.21	23.98	23.24	29.55	30.00	33.85	36.00
802.11ac VHT40_Nss1,(MCS0) _2TX	-	-	-	-	-	-	-	-	-	-
5190MHz	Pass	3.30	14.90	15.27			18.10	30.00	21.40	36.00
5230MHz	Pass	3.30	20.32	20.43			23.39	30.00	26.69	36.00
802.11ac VHT40_Nss1,(MCS0)_4TX	-	-	-	-	-	-	-	-	-	-
5755MHz	Pass	4.30	21.97	23.04	23.66	23.03	28.99	30.00	33.29	36.00
5795MHz	Pass	4.30	22.61	24.42	24.41	23.65	29.85	30.00	34.15	36.00
802.11ac VHT80_Nss1,(MCS0) _2TX	-	-	-	-	-	-	-	-	-	-
5210MHz	Pass	3.30	13.55	13.89			16.73	30.00	20.03	36.00
802.11ac VHT80_Nss1,(MCS0)_4TX	-	-	-	-	-	-	-	-	-	-
5775MHz	Pass	4.30	18.84	20.55	20.87	20.01	26.15	30.00	30.45	36.00

DG = Directional Gain; **Port X** = Port X output power

Beamforming mode

Summary

Mode	Total Power (dBm)	Total Power (W)	EIRP (dBm)	EIRP (W)
5.15-5.25GHz	-	-	-	-
802.11ac VHT20-BF_Nss1,(MCS0)_2TX	24.29	0.26853	30.60	1.14815
802.11ac VHT40-BF_Nss1,(MCS0)_2TX	23.37	0.21727	29.68	0.92897
802.11ac VHT80-BF_Nss1,(MCS0)_2TX	16.29	0.04256	22.60	0.18197
5.725-5.85GHz	-	-	-	-
802.11ac VHT20-BF_Nss1,(MCS0)_4TX	25.06	0.32063	35.38	3.45144
802.11ac VHT40-BF_Nss1,(MCS0)_4TX	25.07	0.32137	35.39	3.45939
802.11ac VHT80-BF_Nss1,(MCS0)_4TX	24.72	0.29648	35.04	3.19154

Note:

5150-5250 MHz

- Directional gain = $3.3 + 10 \cdot \log(2/1) = 6.31 \text{ dBi} > 6 \text{ dBi}$.
Limit shall be reduced to $30 \text{ dBm} - (6.31 \text{ dBi} - 6 \text{ dBi}) = 29.69 \text{ dBm}$.

5725 ~ 5850 MHz

- Directional gain = $4.3 + 10 \cdot \log(4/1) = 10.32 \text{ dBi} > 6 \text{ dBi}$.
Limit shall be reduced to $30 \text{ dBm} - (10.32 \text{ dBi} - 6 \text{ dBi}) = 25.68 \text{ dBm}$.

Result

Mode	Result	DG (dBi)	Port 1 (dBm)	Port 2 (dBm)	Port 3 (dBm)	Port 4 (dBm)	Total Power (dBm)	Power Limit (dBm)	EIRP (dBm)	EIRP Limit (dBm)
802.11ac VHT20-BF_Nss1,(MCS0)_ 2TX	-	-	-	-	-	-	-	-	-	-
5180MHz	Pass	6.31	17.84	17.50			20.68	29.69	26.99	36.00
5200MHz	Pass	6.31	21.39	21.16			24.29	29.69	30.60	36.00
5240MHz	Pass	6.31	21.23	21.19			24.22	29.69	30.53	36.00
802.11ac VHT20-BF_Nss1,(MCS0)_ 4TX	-	-	-	-	-	-	-	-	-	-
5745MHz	Pass	10.32	19.29	18.88	19.03	18.33	24.92	25.68	35.24	36.00
5785MHz	Pass	10.32	19.33	18.97	19.01	18.85	25.06	25.68	35.38	36.00
5825MHz	Pass	10.32	19.02	19.15	19.17	18.78	25.05	25.68	35.37	36.00
802.11ac VHT40-BF_Nss1,(MCS0)_ 2TX	-	-	-	-	-	-	-	-	-	-
5190MHz	Pass	6.31	15.03	14.59			17.83	29.69	24.14	36.00
5230MHz	Pass	6.31	20.12	20.58			23.37	29.69	29.68	36.00
802.11ac VHT40-BF_Nss1,(MCS0)_ 4TX	-	-	-	-	-	-	-	-	-	-
5755MHz	Pass	10.32	18.40	18.71	19.80	19.16	25.07	25.68	35.39	36.00
5795MHz	Pass	10.32	18.47	18.75	19.65	19.10	25.04	25.68	35.36	36.00
802.11ac VHT80-BF_Nss1,(MCS0)_ 2TX	-	-	-	-	-	-	-	-	-	-
5210MHz	Pass	6.31	13.21	13.35			16.29	29.69	22.60	36.00
802.11ac VHT80-BF_Nss1,(MCS0)_ 4TX	-	-	-	-	-	-	-	-	-	-
5775MHz	Pass	10.32	18.62	18.61	18.72	18.85	24.72	25.68	35.04	36.00

DG = Directional Gain; **Port X** = Port X output power

3.4 Peak Power Spectral Density

3.4.1 Limit of Peak Power Spectral Density

Frequency band 5150-5250 MHz		
Operating Mode		Limit
<input type="checkbox"/>	Outdoor access point	17 dBm / MHz
<input checked="" type="checkbox"/>	Indoor access point	17 dBm / MHz
<input type="checkbox"/>	Fixed point-to-point access points	17 dBm / MHz
<input type="checkbox"/>	Client devices	11 dBm / MHz

Frequency Band (MHz)	Limit
<input checked="" type="checkbox"/> 5725 ~ 5850	30 dBm /500 kHz

3.4.2 Test Procedures

For 5150 ~ 5250 MHz

Duty cycle \geq 98 %

1. Set RBW = 1 MHz, VBW = 3 MHz, Sweep time = auto, Detector = RMS.
2. Trace average 100 traces.
3. Use the peak marker function to determine the maximum amplitude level.

Duty cycle $<$ 98 %

1. Set RBW = 1 MHz, VBW = 3 MHz, Detector = RMS.
2. Set sweep time $\geq 10 * (\text{number of points in sweep}) * (\text{total on/off period of the transmitted signal})$.
3. Perform a single sweep.
4. Use the peak marker function to determine the maximum amplitude level.
5. Add $10 \log(1/x)$, where x is the duty cycle.

For 5725 ~ 5850 MHz

Duty cycle \geq 98 %

1. Set RBW = 500 kHz, VBW = 3 MHz, Sweep time = auto, Detector = RMS.
2. Trace average 100 traces.
3. Use the peak marker function to determine the maximum amplitude level.

Duty cycle $<$ 98 %

1. Set RBW = 500 kHz, VBW = 3 MHz, Detector = RMS.
2. Set sweep time $\geq 10 * (\text{number of points in sweep}) * (\text{total on/off period of the transmitted signal})$.
3. Perform a single sweep.
4. Use the peak marker function to determine the maximum amplitude level.
5. Add $10 \log(1/x)$, where x is the duty cycle.

3.4.3 Test Setup

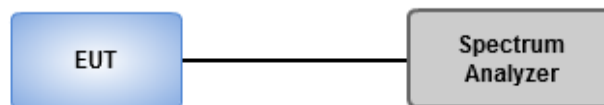

3.4.4 Test Result of Peak Power Spectral Density

Non-beamforming mode

Summary

Mode	PD (dBm/RBW)	EIRP PD (dBm/RBW)
5.15-5.25GHz	-	-
802.11a_Nss1,(6Mbps)_2TX	12.16	18.47
802.11ac VHT20_Nss1,(MCS0)_2TX	12.26	18.57
802.11ac VHT40_Nss1,(MCS0)_2TX	7.66	13.97
802.11ac VHT80_Nss1,(MCS0)_2TX	-2.34	3.97
5.725-5.85GHz	-	-
802.11a_Nss1,(6Mbps)_4TX	16.03	26.35
802.11ac VHT20_Nss1,(MCS0)_4TX	15.68	26.00
802.11ac VHT40_Nss1,(MCS0)_4TX	13.12	23.44
802.11ac VHT80_Nss1,(MCS0)_4TX	5.62	15.94

RBW = 500kHz for 5.725-5.85GHz band / 1MHz for other band;

Note:

5150-5250 MHz

1. D.F is duty factor.
2. Test result is bin-by-bin summing measured value of each TX port.
3. Directional gain = $3.3+10 \cdot \log(2/1) = 6.31$ dBi
Limit shall be reduced to 17 dBm – (6.31 dBi – 6 dBi) = 16.69 dBm.

5725 ~ 5850 MHz

1. D.F is duty factor.
2. Test result is bin-by-bin summing measured value of each TX port.
3. Directional gain = $4.3+10 \cdot \log(4/1) = 10.32$ dBi
Limit shall be reduced to 30 dBm – (10.32 dBi – 6 dBi) = 25.68 dBm.

Result

Mode	Result	DG (dBi)	Port 1 (dBm/ RBW)	Port 2 (dBm/ RBW)	Port 3 (dBm/ RBW)	Port 4 (dBm/ RBW)	PD (dBm/ RBW)	PD Limit (dBm/ RBW)	EIRP PD (dBm/ RBW)	EIRP PD Limit (dBm/ RBW)
802.11a_Nss1,(6Mbps)_2TX	-	-	-	-	-	-	-	-	-	-
5180MHz	Pass	6.31	4.07	4.53			7.32	16.69	13.63	23.00
5200MHz	Pass	6.31	8.05	8.30			11.16	16.69	17.47	23.00
5240MHz	Pass	6.31	9.16	9.14			12.16	16.69	18.47	23.00
802.11a_Nss1,(6Mbps)_4TX	-	-	-	-	-	-	-	-	-	-
5745MHz	Pass	10.32	9.11	9.55	10.88	10.20	15.84	25.68	26.16	36.00
5785MHz	Pass	10.32	8.94	10.24	11.14	10.07	16.03	25.68	26.35	36.00
5825MHz	Pass	10.32	8.21	10.29	10.30	9.60	15.55	25.68	25.87	36.00
802.11ac VHT20_Nss1,(MCS0)_2TX	-	-	-	-	-	-	-	-	-	-
5180MHz	Pass	6.31	4.69	5.11			7.72	16.69	14.03	23.00
5200MHz	Pass	6.31	8.93	9.40			12.01	16.69	18.32	23.00
5240MHz	Pass	6.31	9.26	9.31			12.26	16.69	18.57	23.00
802.11ac VHT20_Nss1,(MCS0)_4TX	-	-	-	-	-	-	-	-	-	-
5745MHz	Pass	10.32	8.86	9.90	11.11	10.29	15.53	25.68	25.85	36.00
5785MHz	Pass	10.32	8.85	10.11	10.98	10.10	15.68	25.68	26.00	36.00
5825MHz	Pass	10.32	8.08	10.20	10.16	9.71	15.14	25.68	25.46	36.00
802.11ac VHT40_Nss1,(MCS0)_2TX	-	-	-	-	-	-	-	-	-	-
5190MHz	Pass	6.31	-0.69	-0.05			2.32	16.69	8.63	23.00
5230MHz	Pass	6.31	4.80	5.32			7.66	16.69	13.97	23.00
802.11ac VHT40_Nss1,(MCS0)_4TX	-	-	-	-	-	-	-	-	-	-
5755MHz	Pass	10.32	5.46	6.24	7.31	6.66	11.96	25.68	22.28	36.00
5795MHz	Pass	10.32	5.88	7.87	8.22	7.51	13.12	25.68	23.44	36.00
802.11ac VHT80_Nss1,(MCS0)_2TX	-	-	-	-	-	-	-	-	-	-
5210MHz	Pass	6.31	-5.56	-5.13			-2.34	16.69	3.97	23.00
802.11ac VHT80_Nss1,(MCS0)_4TX	-	-	-	-	-	-	-	-	-	-
5775MHz	Pass	10.32	-1.50	0.19	0.64	0.00	5.62	25.68	15.94	36.00

DG = Directional Gain; **RBW** = 500kHz for 5.725-5.85GHz band / 1MHz for other band;

PD = trace bin-by-bin of each transmits port summing can be performed maximum power density; **Port X** = Port X power density;

802.11a_Nss1,(6Mbps)_2TX

PSD

5180MHz

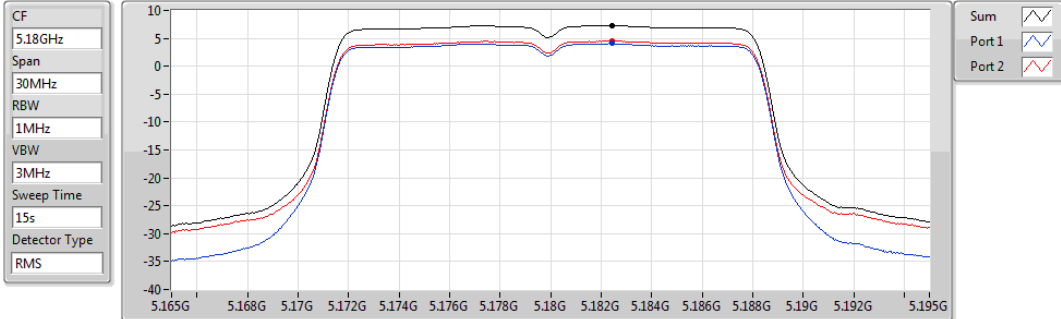

Sum	PD	Port 1	Port 2
(dBm/100kHz)	(dBm/100kHz)	(dBm/100kHz)	(dBm/100kHz)
7.32	7.32	4.07	4.53

802.11a_Nss1,(6Mbps)_2TX

PSD

5200MHz

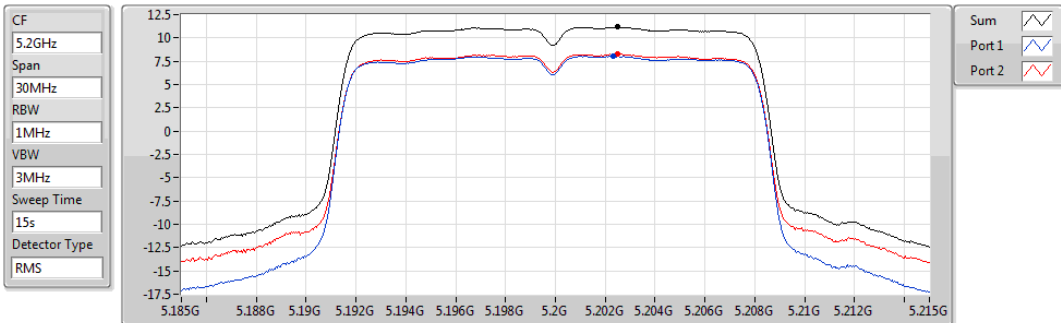

Sum	PD	Port 1	Port 2
(dBm/100kHz)	(dBm/100kHz)	(dBm/100kHz)	(dBm/100kHz)
11.16	11.16	8.05	8.30

802.11a_Nss1,(6Mbps)_2TX

PSD

5240MHz

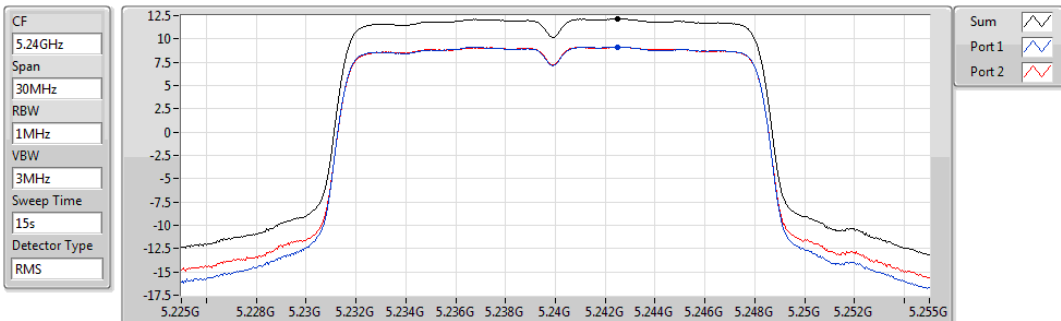

Sum	PD	Port 1	Port 2
(dBm/100kHz)	(dBm/100kHz)	(dBm/100kHz)	(dBm/100kHz)
12.16	12.16	9.16	9.14

802.11a_Nss1,(6Mbps)_4TX

PSD

5745MHz

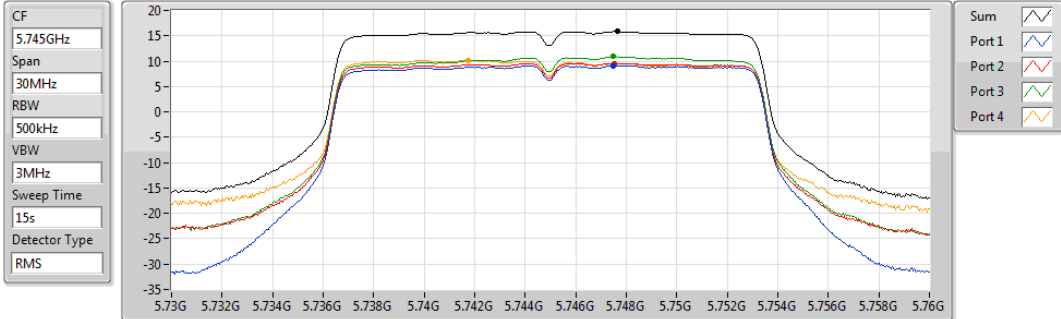

Sum	PD	Port 1	Port 2	Port 3	Port 4
(dBm/RBW)	(dBm/RBW)	(dBm/RBW)	(dBm/RBW)	(dBm/RBW)	(dBm/RBW)
15.84	15.84	9.11	9.55	10.88	10.20

802.11a_Nss1,(6Mbps)_4TX

PSD

5785MHz

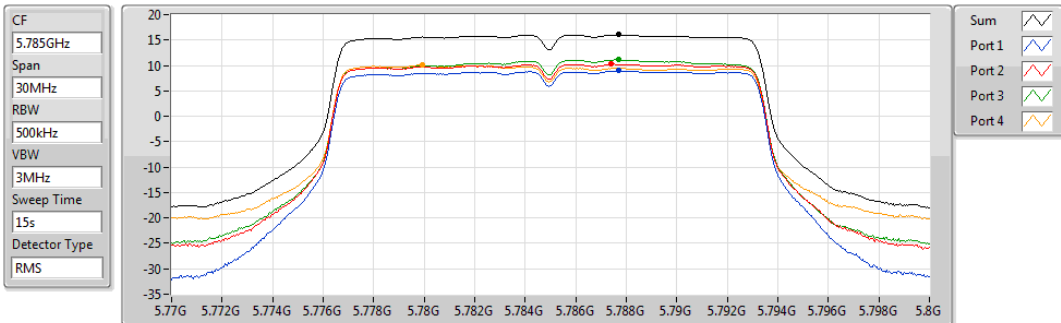

Sum	PD	Port 1	Port 2	Port 3	Port 4
(dBm/RBW)	(dBm/RBW)	(dBm/RBW)	(dBm/RBW)	(dBm/RBW)	(dBm/RBW)
16.03	16.03	8.94	10.24	11.14	10.07

802.11a_Nss1,(6Mbps)_4TX

PSD

5825MHz

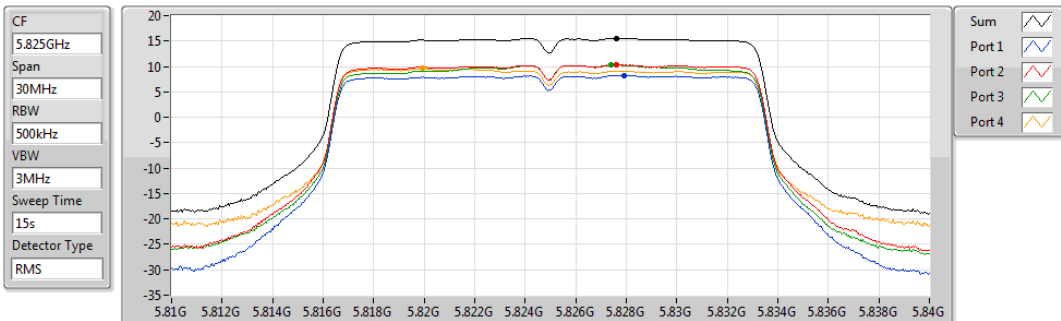

Sum	PD	Port 1	Port 2	Port 3	Port 4
(dBm/RBW)	(dBm/RBW)	(dBm/RBW)	(dBm/RBW)	(dBm/RBW)	(dBm/RBW)
15.55	15.55	8.21	10.29	10.30	9.60

802.11ac VHT20_Nss1,(MCS0)_2TX

PSD

5180MHz

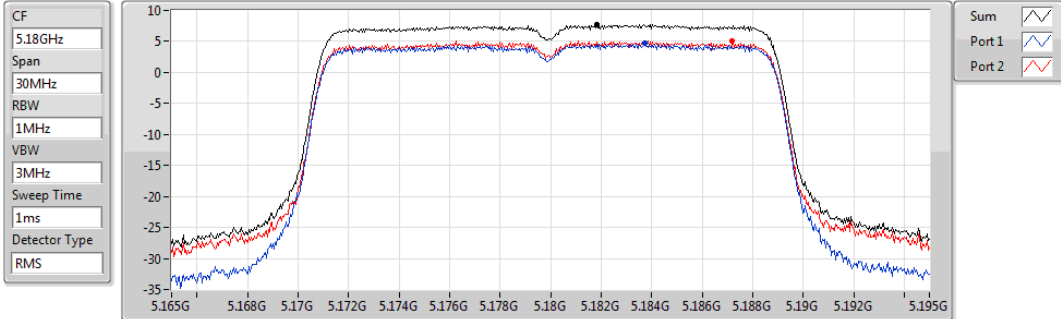

Sum	PD	Port 1	Port 2
(dBm/RBW)	(dBm/RBW)	(dBm/RBW)	(dBm/RBW)
7.72	7.72	4.69	5.11

802.11ac VHT20_Nss1,(MCS0)_2TX

PSD

5200MHz

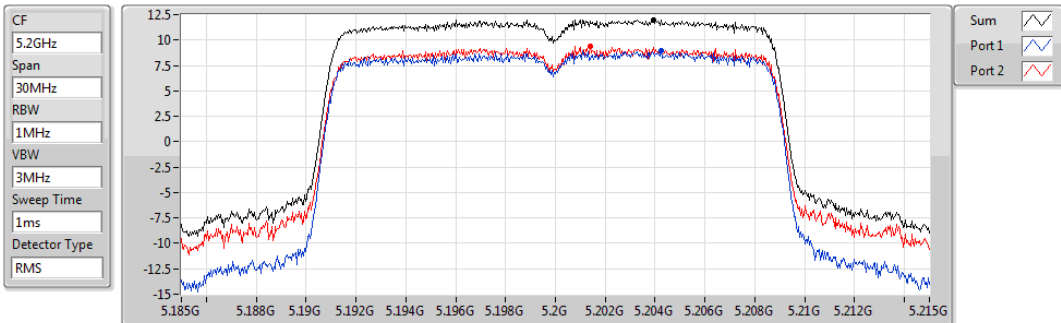

Sum	PD	Port 1	Port 2
(dBm/RBW)	(dBm/RBW)	(dBm/RBW)	(dBm/RBW)
12.01	12.01	8.93	9.40

802.11ac VHT20_Nss1,(MCS0)_2TX

PSD

5240MHz

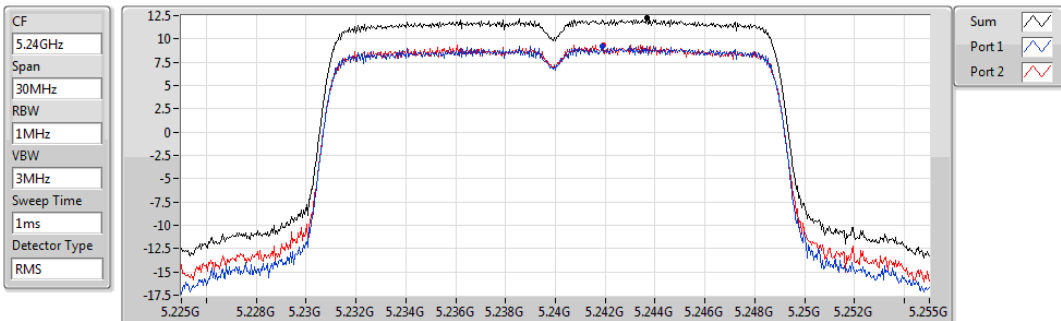

Sum	PD	Port 1	Port 2
(dBm/RBW)	(dBm/RBW)	(dBm/RBW)	(dBm/RBW)
12.26	12.26	9.26	9.31

802.11ac VHT20_Nss1,(MCS0)_4TX

PSD

5745MHz

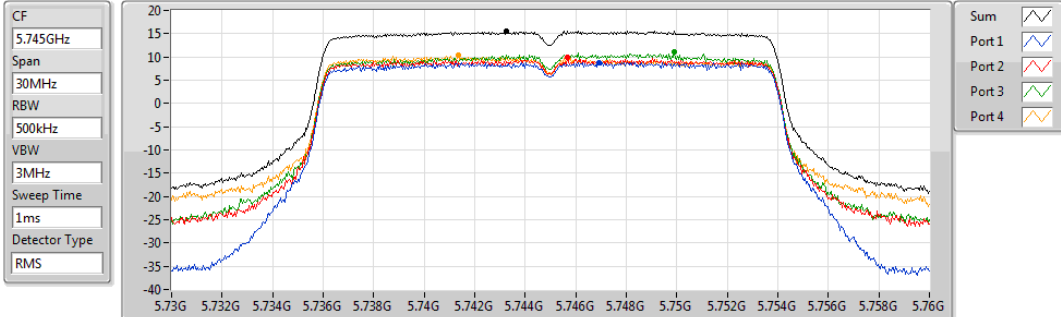

Sum	PD	Port 1	Port 2	Port 3	Port 4
(dBm/RBW)	(dBm/RBW)	(dBm/RBW)	(dBm/RBW)	(dBm/RBW)	(dBm/RBW)
15.53	15.53	8.86	9.90	11.11	10.29

802.11ac VHT20_Nss1,(MCS0)_4TX

PSD

5785MHz

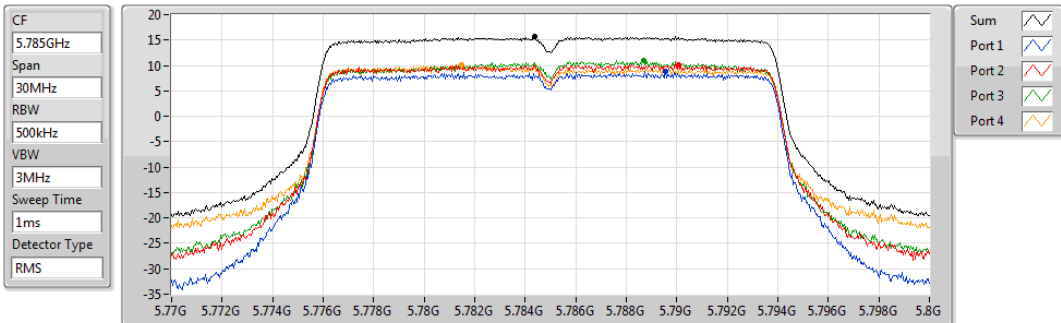

Sum	PD	Port 1	Port 2	Port 3	Port 4
(dBm/RBW)	(dBm/RBW)	(dBm/RBW)	(dBm/RBW)	(dBm/RBW)	(dBm/RBW)
15.68	15.68	8.85	10.11	10.98	10.10

802.11ac VHT20_Nss1,(MCS0)_4TX

PSD

5825MHz

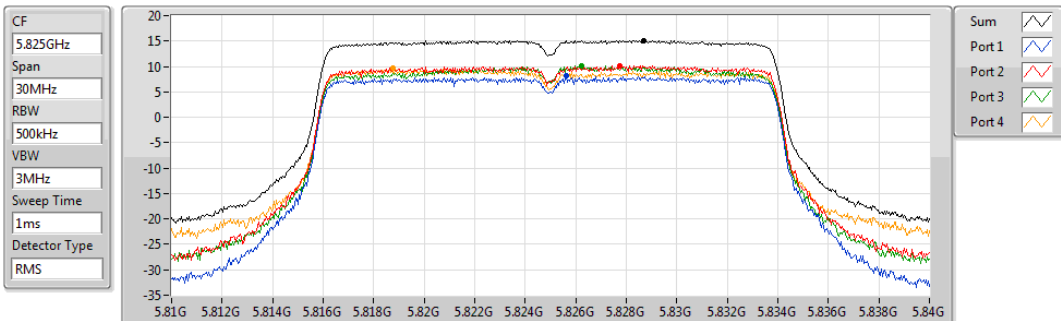

Sum	PD	Port 1	Port 2	Port 3	Port 4
(dBm/RBW)	(dBm/RBW)	(dBm/RBW)	(dBm/RBW)	(dBm/RBW)	(dBm/RBW)
15.14	15.14	8.08	10.20	10.16	9.71

802.11ac VHT40_Nss1,(MCS0)_2TX

PSD

5190MHz

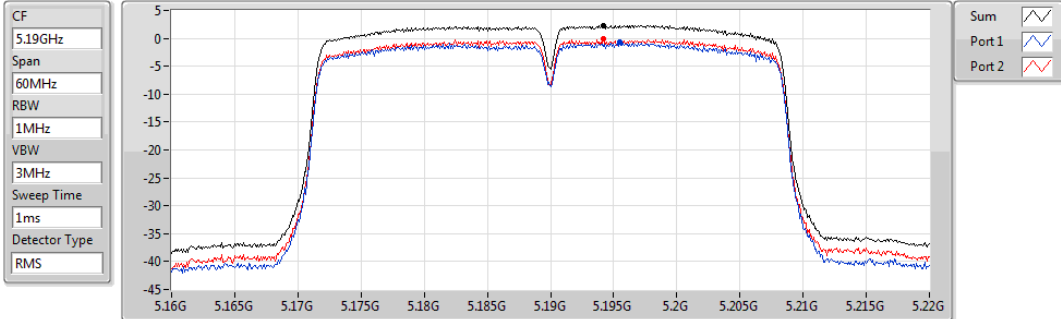

Sum	PD	Port 1	Port 2
(dBm/RBW)	(dBm/RBW)	(dBm/RBW)	(dBm/RBW)
2.32	2.32	-0.69	-0.05

802.11ac VHT40_Nss1,(MCS0)_2TX

PSD

5230MHz

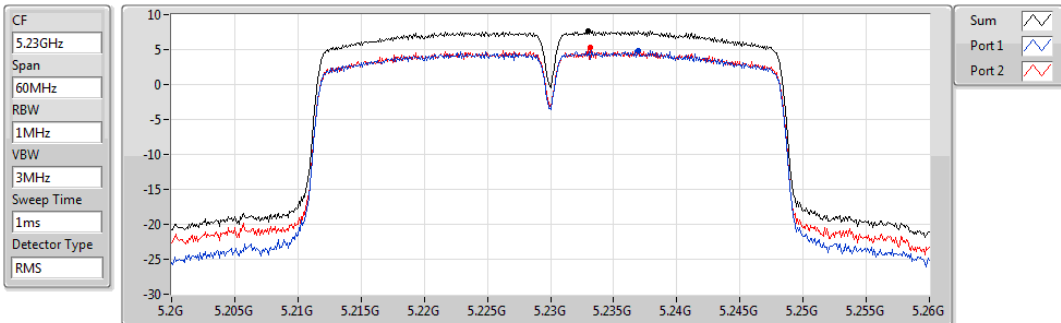

Sum	PD	Port 1	Port 2
(dBm/RBW)	(dBm/RBW)	(dBm/RBW)	(dBm/RBW)
7.66	7.66	4.80	5.32

802.11ac VHT40_Nss1,(MCS0)_4TX

PSD

5755MHz

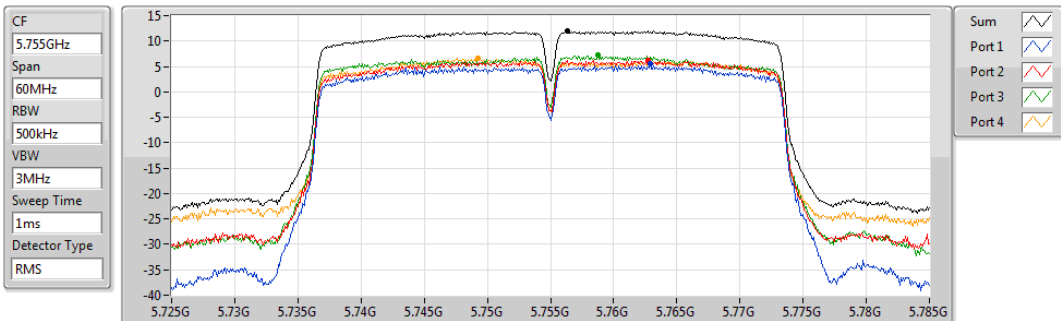

Sum	PD	Port 1	Port 2	Port 3	Port 4
(dBm/RBW)	(dBm/RBW)	(dBm/RBW)	(dBm/RBW)	(dBm/RBW)	(dBm/RBW)
11.96	11.96	5.46	6.24	7.31	6.66

802.11ac VHT40_Nss1,(MCS0)_4TX

PSD

5795MHz

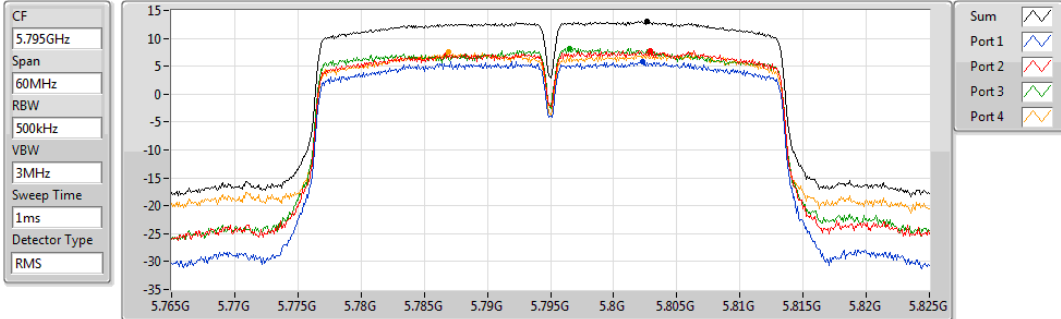

Sum	PD	Port 1	Port 2	Port 3	Port 4
(dBm/RBW)	(dBm/RBW)	(dBm/RBW)	(dBm/RBW)	(dBm/RBW)	(dBm/RBW)
13.12	13.12	5.88	7.87	8.22	7.51

802.11ac VHT80_Nss1,(MCS0)_2TX

PSD

5210MHz

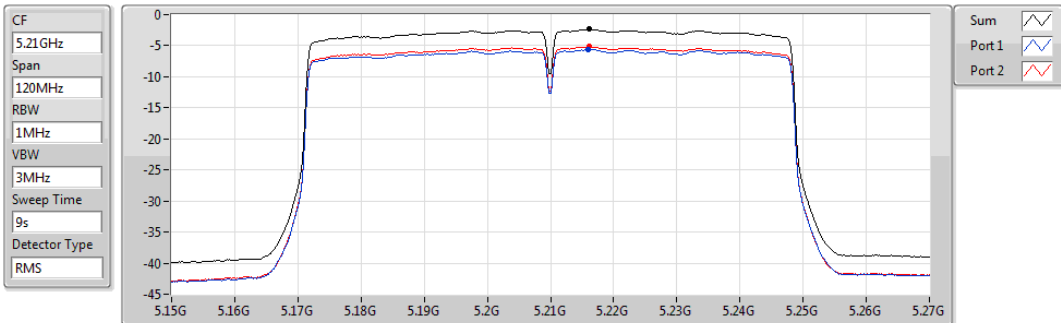

Sum	PD	Port 1	Port 2
(dBm/RBW)	(dBm/RBW)	(dBm/RBW)	(dBm/RBW)
-2.34	-2.34	-5.56	-5.13

802.11ac VHT80_Nss1,(MCS0)_4TX

PSD

5775MHz

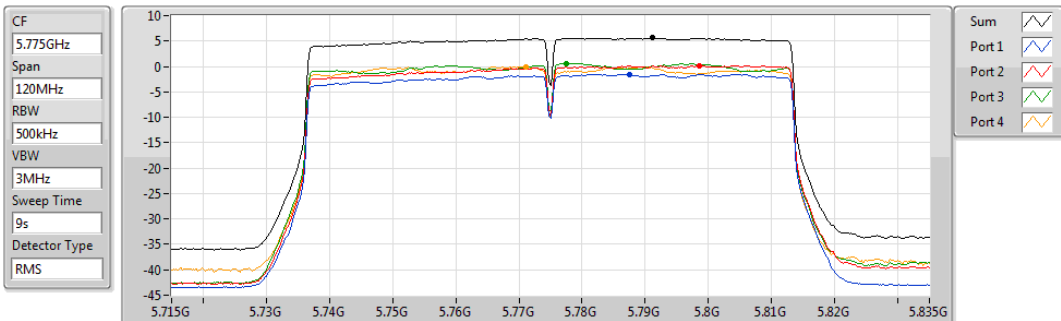

Sum	PD	Port 1	Port 2	Port 3	Port 4
(dBm/RBW)	(dBm/RBW)	(dBm/RBW)	(dBm/RBW)	(dBm/RBW)	(dBm/RBW)
5.62	5.62	-1.50	0.19	0.64	0.00

Beamforming mode

Summary

Mode	PD (dBm/RBW)	EIRP PD (dBm/RBW)
5.15-5.25GHz	-	-
802.11ac VHT20-BF_Nss1,(MCS0)_2TX	10.33	16.64
802.11ac VHT40-BF_Nss1,(MCS0)_2TX	7.65	13.96
802.11ac VHT80-BF_Nss1,(MCS0)_2TX	-2.47	3.84
5.725-5.85GHz	-	-
802.11ac VHT20-BF_Nss1,(MCS0)_4TX	9.47	19.79
802.11ac VHT40-BF_Nss1,(MCS0)_4TX	6.89	17.21
802.11ac VHT80-BF_Nss1,(MCS0)_4TX	3.08	13.40

RBW = 500kHz for 5.725-5.85GHz band / 1MHz for other band;

Note:

5150-5250 MHz

4. D.F is duty factor.
5. Test result is bin-by-bin summing measured value of each TX port.
6. Directional gain = $3.3+10 \cdot \log(2/1) = 6.31$ dBi
Limit shall be reduced to 17 dBm – (6.31 dBi – 6 dBi) = 16.69 dBm.

5725 ~ 5850 MHz

4. D.F is duty factor.
5. Test result is bin-by-bin summing measured value of each TX port.
6. Directional gain = $4.3+10 \cdot \log(4/1) = 10.32$ dBi
Limit shall be reduced to 30 dBm – (10.32 dBi – 6 dBi) = 25.68 dBm.

Result

Mode	Result	DG (dBi)	Port 1 (dBm/ RBW)	Port 2 (dBm/ RBW)	Port 3 (dBm/ RBW)	Port 4 (dBm/ RBW)	PD (dBm/ RBW)	PD Limit (dBm/ RBW)	EIRP PD (dBm/ RBW)	EIRP PD Limit (dBm/ RBW)
802.11ac VHT20-BF_Nss1,(MCS0)_2T X	-	-	-	-	-	-	-	-	-	-
5180MHz	Pass	6.31	4.24	4.15			6.94	16.69	13.25	23.00
5200MHz	Pass	6.31	7.43	7.46			10.21	16.69	16.52	23.00
5240MHz	Pass	6.31	7.62	7.32			10.33	16.69	16.64	23.00
802.11ac VHT20-BF_Nss1,(MCS0)_4T X	-	-	-	-	-	-	-	-	-	-
5745MHz	Pass	10.32	3.28	4.53	4.07	4.49	9.37	25.68	19.69	36.00
5785MHz	Pass	10.32	3.83	4.47	3.81	4.84	9.47	25.68	19.79	36.00
5825MHz	Pass	10.32	3.19	3.68	3.54	3.96	9.33	25.68	19.65	36.00
802.11ac VHT40-BF_Nss1,(MCS0)_2T X	-	-	-	-	-	-	-	-	-	-
5190MHz	Pass	6.31	-0.78	-0.84			1.89	16.69	8.20	23.00
5230MHz	Pass	6.31	4.78	5.26			7.65	16.69	13.96	23.00
802.11ac VHT40-BF_Nss1,(MCS0)_4T X	-	-	-	-	-	-	-	-	-	-
5755MHz	Pass	10.32	1.66	1.95	1.26	2.18	6.89	25.68	17.21	36.00
5795MHz	Pass	10.32	0.51	1.39	1.22	1.74	6.65	25.68	16.97	36.00
802.11ac VHT80-BF_Nss1,(MCS0)_2T X	-	-	-	-	-	-	-	-	-	-
5210MHz	Pass	6.31	-4.75	-5.86			-2.47	16.69	3.84	23.00
802.11ac VHT80-BF_Nss1,(MCS0)_4T X	-	-	-	-	-	-	-	-	-	-
5775MHz	Pass	10.32	-2.79	-2.27	-2.47	-2.31	3.08	25.68	13.40	36.00

DG = Directional Gain; **RBW** = 500kHz for 5.725-5.85GHz band / 1MHz for other band;

PD = trace bin-by-bin of each transmits port summing can be performed maximum power density; **Port X** = Port Xpower density;

802.11ac VHT20-BF_Nss1,(MCS0)_2TX

PSD

5180MHz

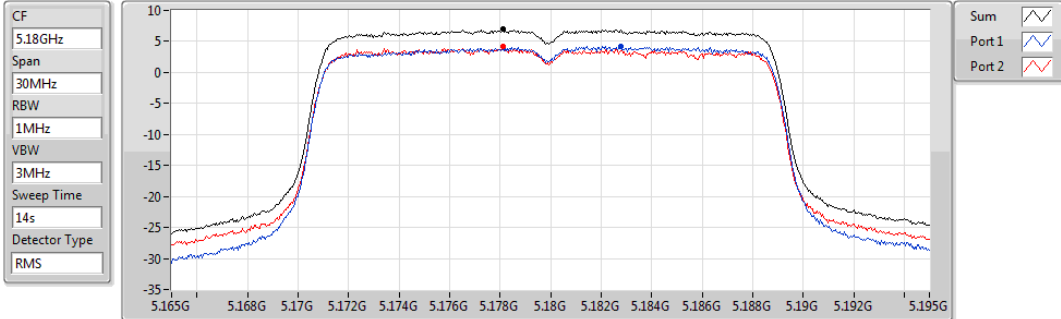

Sum	PD	Port 1	Port 2
(dBm/RBW)	(dBm/RBW)	(dBm/RBW)	(dBm/RBW)
6.94	6.94	4.24	4.15

802.11ac VHT20-BF_Nss1,(MCS0)_2TX

PSD

5200MHz

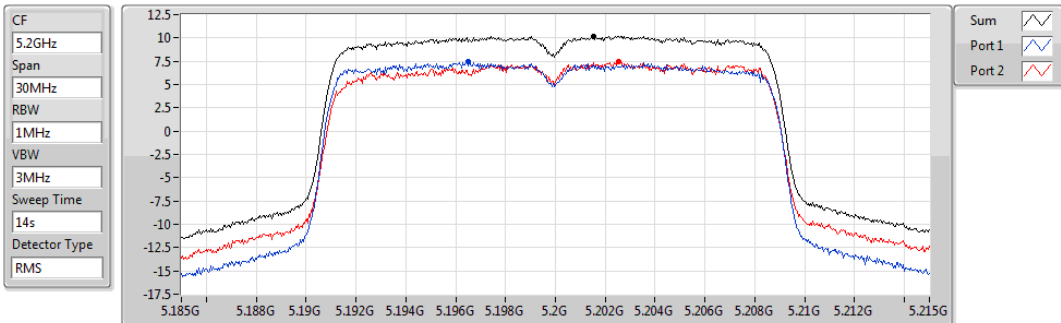

Sum	PD	Port 1	Port 2
(dBm/RBW)	(dBm/RBW)	(dBm/RBW)	(dBm/RBW)
10.21	10.21	7.43	7.46

802.11ac VHT20-BF_Nss1,(MCS0)_2TX

PSD

5240MHz

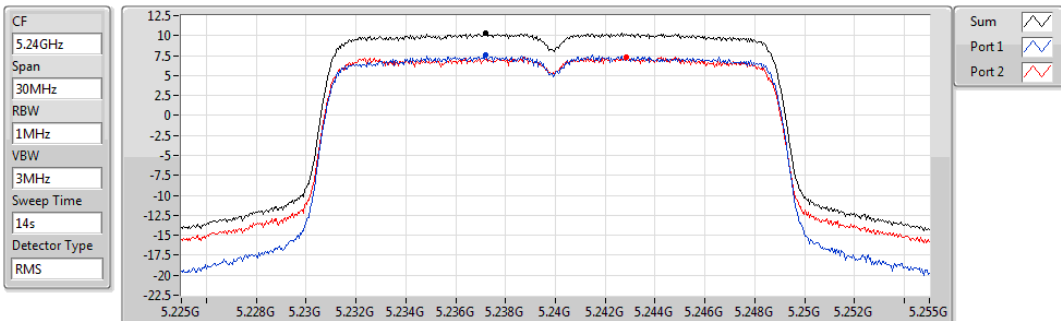

Sum	PD	Port 1	Port 2
(dBm/RBW)	(dBm/RBW)	(dBm/RBW)	(dBm/RBW)
10.33	10.33	7.62	7.32

802.11ac VHT20-BF_Nss1,(MCS0)_4TX

PSD

5745MHz

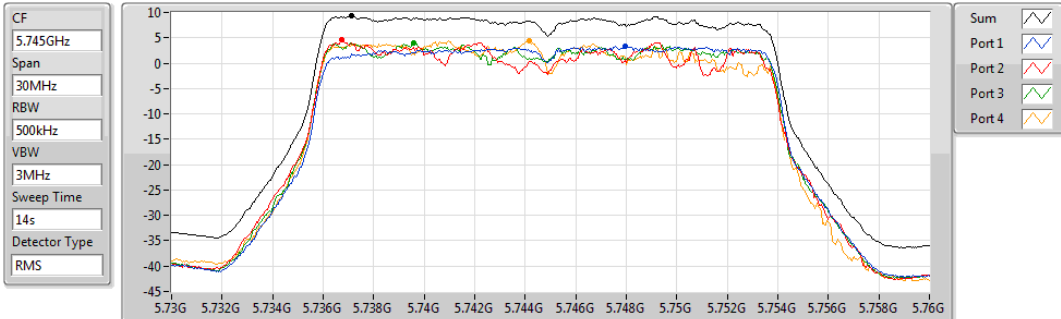

Sum	PD	Port 1	Port 2	Port 3	Port 4
(dBm/RBW)	(dBm/RBW)	(dBm/RBW)	(dBm/RBW)	(dBm/RBW)	(dBm/RBW)
9.37	9.37	3.28	4.53	4.07	4.49

802.11ac VHT20-BF_Nss1,(MCS0)_4TX

PSD

5785MHz

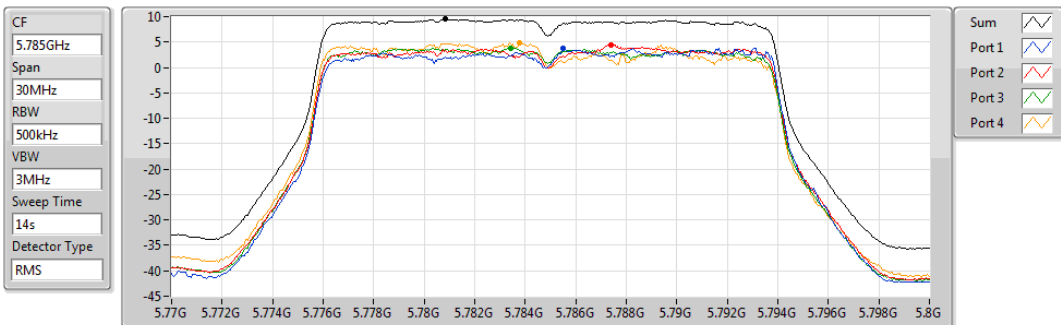

Sum	PD	Port 1	Port 2	Port 3	Port 4
(dBm/RBW)	(dBm/RBW)	(dBm/RBW)	(dBm/RBW)	(dBm/RBW)	(dBm/RBW)
9.47	9.47	3.83	4.47	3.81	4.84

802.11ac VHT20-BF_Nss1,(MCS0)_4TX

PSD

5825MHz

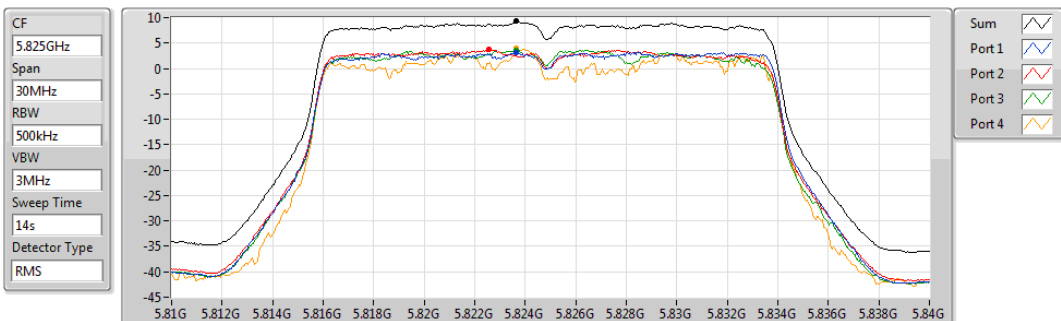

Sum	PD	Port 1	Port 2	Port 3	Port 4
(dBm/RBW)	(dBm/RBW)	(dBm/RBW)	(dBm/RBW)	(dBm/RBW)	(dBm/RBW)
9.33	9.33	3.19	3.68	3.54	3.96

802.11ac VHT40-BF_Nss1,(MCS0)_2TX

PSD

5190MHz

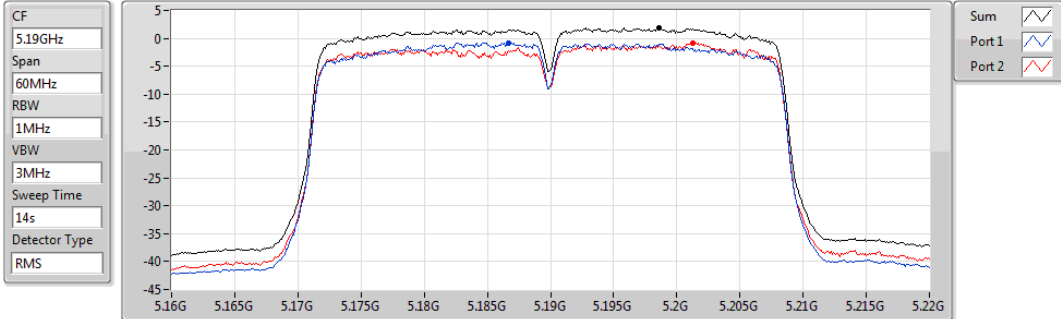

Sum	PD	Port 1	Port 2
(dBm/RBW)	(dBm/RBW)	(dBm/RBW)	(dBm/RBW)
1.89	1.89	-0.78	-0.84

802.11ac VHT40-BF_Nss1,(MCS0)_2TX

PSD

5230MHz

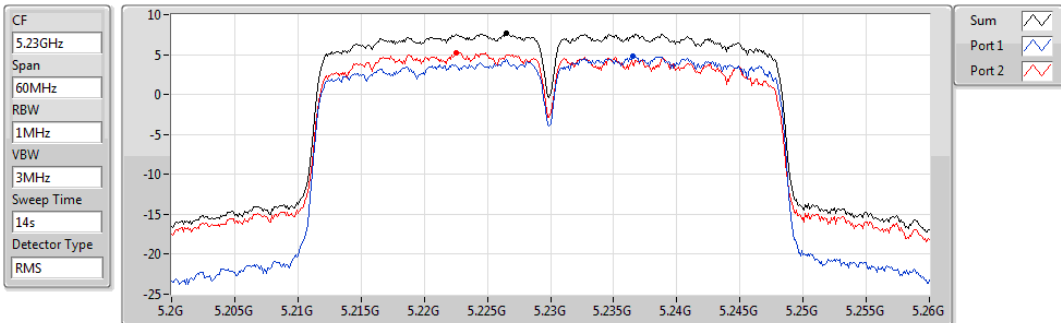

Sum	PD	Port 1	Port 2
(dBm/RBW)	(dBm/RBW)	(dBm/RBW)	(dBm/RBW)
7.65	7.65	4.78	5.26

802.11ac VHT40-BF_Nss1,(MCS0)_4TX

PSD

5755MHz

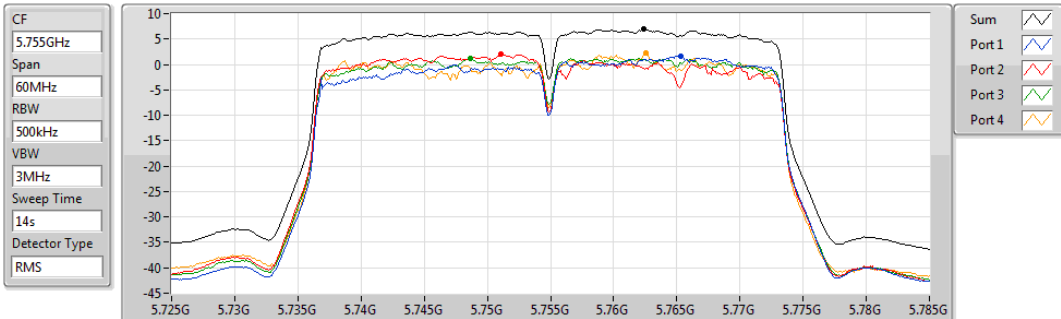

Sum	PD	Port 1	Port 2	Port 3	Port 4
(dBm/RBW)	(dBm/RBW)	(dBm/RBW)	(dBm/RBW)	(dBm/RBW)	(dBm/RBW)
6.89	6.89	1.66	1.95	1.26	2.18

802.11ac VHT40-BF_Nss1,(MCS0)_4TX

PSD

5795MHz

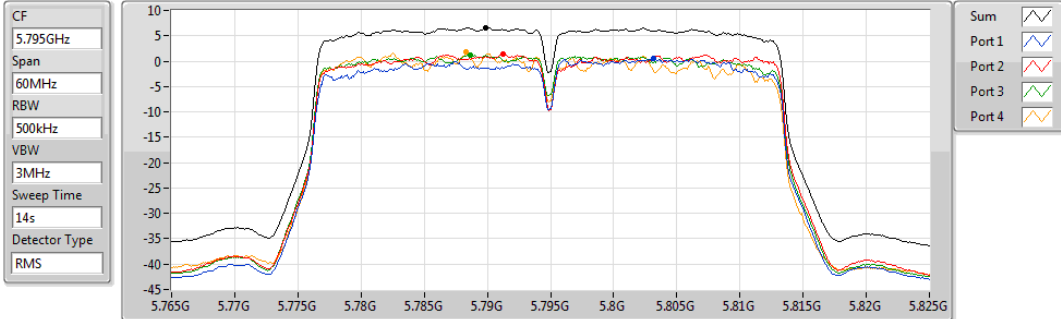

Sum	PD	Port 1	Port 2	Port 3	Port 4
(dBm/RBW)	(dBm/RBW)	(dBm/RBW)	(dBm/RBW)	(dBm/RBW)	(dBm/RBW)
6.65	6.65	0.51	1.39	1.22	1.74

802.11ac VHT80-BF_Nss1,(MCS0)_2TX

PSD

5210MHz

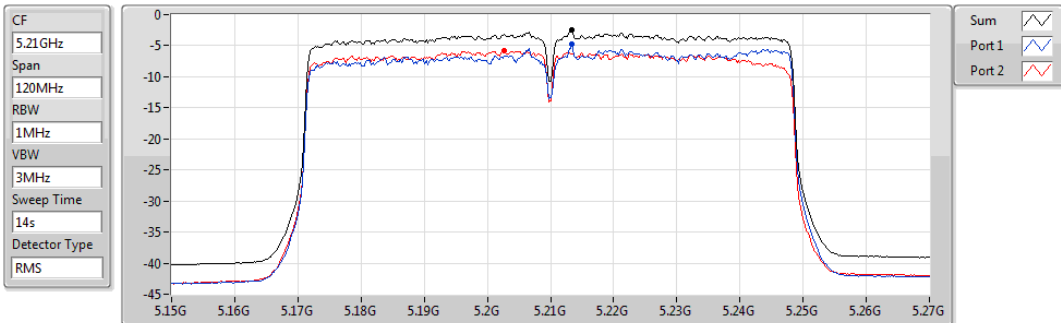

Sum	PD	Port 1	Port 2
(dBm/RBW)	(dBm/RBW)	(dBm/RBW)	(dBm/RBW)
-2.47	-2.47	-4.75	-5.86

802.11ac VHT80-BF_Nss1,(MCS0)_4TX

PSD

5775MHz

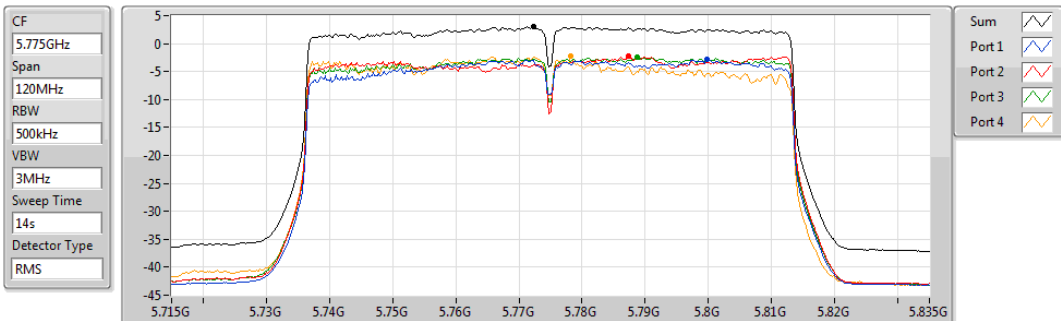

Sum	PD	Port 1	Port 2	Port 3	Port 4
(dBm/RBW)	(dBm/RBW)	(dBm/RBW)	(dBm/RBW)	(dBm/RBW)	(dBm/RBW)
3.08	3.08	-2.79	-2.27	-2.47	-2.31

3.5 Transmitter Radiated and Band Edge Emissions

3.5.1 Limit of Transmitter Radiated and Band Edge Emissions

Restricted Band Emissions Limit			
Frequency Range (MHz)	Field Strength (uV/m)	Field Strength (dBuV/m)	Measure Distance (m)
0.009~0.490	2400/F(kHz)	48.5 - 13.8	300
0.490~1.705	24000/F(kHz)	33.8 - 23	30
1.705~30.0	30	29	30
30~88	100	40	3
88~216	150	43.5	3
216~960	200	46	3
Above 960	500	54	3

Note 1:
Qusai-Peak value is measured for frequency below 1GHz except for 9–90 kHz, 110–490 kHz frequency band. Peak and average value are measured for frequency above 1GHz. The limit on average radio frequency emission is as above table. The limit on peak radio frequency emissions is 20 dB above the maximum permitted average emission limit

Note 2:
Measurements may be performed at a distance other than what is specified provided. When performing measurements at a distance other than that specified, the results shall be extrapolated to the specified distance using an extrapolation factor as below, Frequency at or above 30 MHz: 20 dB/decade Frequency below 30 MHz: 40 dB/decade.

Un-restricted band emissions above 1GHz Limit	
Operating Band	Limit
5.15 - 5.25 GHz	e.i.r.p. -27 dBm [68.2 dBuV/m@3m]
5.725 - 5.850 GHz	All emissions shall be limited to a level of -27 dBm/MHz at 75 MHz or more above or below the band edge increasing linearly to 10 dBm/MHz at 25 MHz above or below the band edge, and from 25 MHz above or below the band edge increasing linearly to a level of 15.6 dBm/MHz at 5 MHz above or below the band edge, and from 5 MHz above or below the band edge increasing linearly to a level of 27 dBm/MHz at the band edge.

Note 1: Measurements may be performed at a distance other than the limit distance provided they are not performed in the near field and the emissions to be measured can be detected by the measurement equipment. When performing measurements at a distance other than that specified, the results shall be extrapolated to the specified distance using an extrapolation factor of 20 dB/decade (inverse of linear distance for field-strength measurements, inverse of linear distance-squared for power-density measurements).

3.5.2 Test Procedures

1. Measurement is made at a semi-anechoic chamber that incorporates a turntable allowing a EUT rotation of 360°. A continuously-rotating, remotely-controlled turntable is installed at the test site to support the EUT and facilitate determination of the direction of maximum radiation for each EUT emission frequency. The EUT is placed at test table. For emissions testing at or below 1 GHz, the table height is 80 cm above the reference ground plane. For emission measurements above 1 GHz, the table height is 1.5 m
2. Measurement is made with the antenna positioned in both the horizontal and vertical planes of polarization. The measurement antenna is varied in height (1m ~ 4m) above the reference ground plane to obtain the maximum signal strength. Distance between EUT and antenna is 3 m.
3. This investigation is performed with the EUT rotated 360°, the antenna height scanned between 1 m and 4 m, and the antenna rotated to repeat the measurements for both the horizontal and vertical antenna polarizations.

Note:

1. 120kHz measurement bandwidth of test receiver and Quasi-peak detector is for radiated emission below 1GHz.
2. RBW=1MHz, VBW=3MHz and Peak detector is for peak measured value of radiated emission above 1GHz.
3. RBW=1MHz, VBW=1/T and Peak detector is for average measured value of radiated emission above 1GHz.

3.5.3 Test Setup

Radiated Emissions below 1 GHz

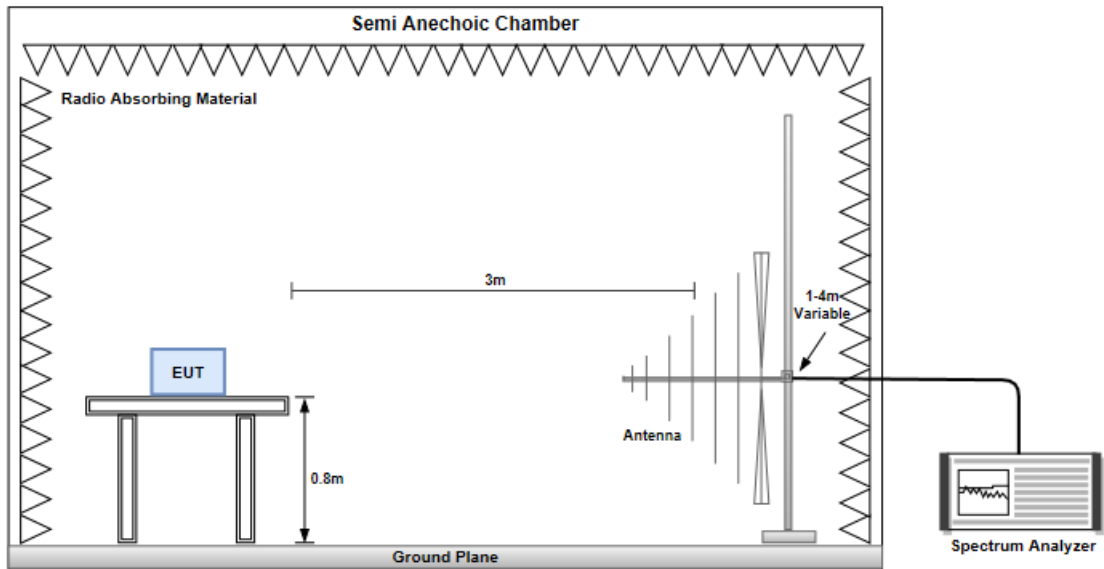

Radiated Emissions above 1 GHz

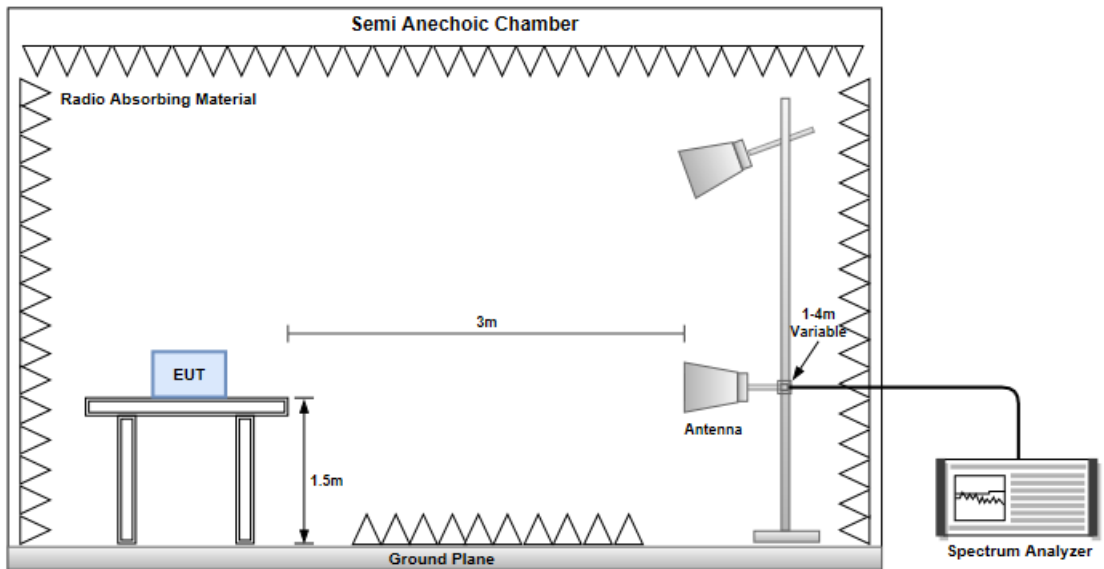

Non- beamforming mode

3.5.4 Transmitter Radiated Unwanted Emissions (Below 1GHz)

Modulation	11a	Test Freq. (MHz)	5240
Polarization	Horizontal	Test Configuration	1

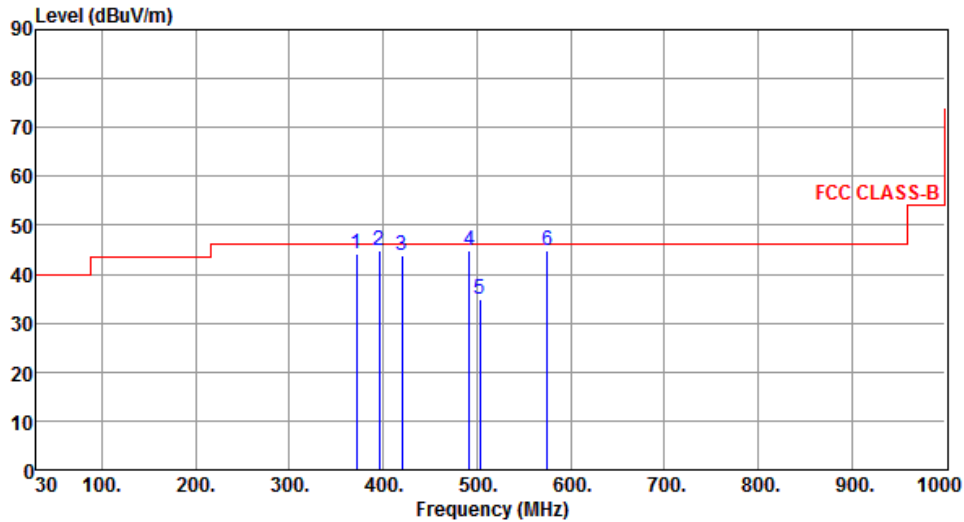

	Freq. MHz	Emission level dBuV/m	Limit dBuV/m	Margin dB	SA reading dBuV	Factor dB	Remark	ANT High cm	Turn Table deg
1	371.84	44.28	46.00	-1.72	50.00	-5.72	QP	100	115
2	396.28	44.91	46.00	-1.09	49.93	-5.02	QP	100	127
3	419.87	43.93	46.00	-2.07	48.34	-4.41	QP	100	124
4	491.89	44.79	46.00	-1.21	47.73	-2.94	QP	172	130
5	503.67	34.74	46.00	-11.26	37.46	-2.72	QP	185	63
6	574.82	44.71	46.00	-1.29	45.76	-1.05	QP	136	137

Note 1: Emission Level (dBuV/m) = SA Reading (dBuV/m) + Factor* (dB)

*Factor includes antenna factor , cable loss and amplifier gain

Note 2: Margin (dB) = Emission level (dBuV/m) – Limit (dBuV/m).

Note 3: All spurious emissions below 30MHz are more than 20 dB below the limit.

Modulation	11a	Test Freq. (MHz)	5240
Polarization	Vertical	Test Configuration	1

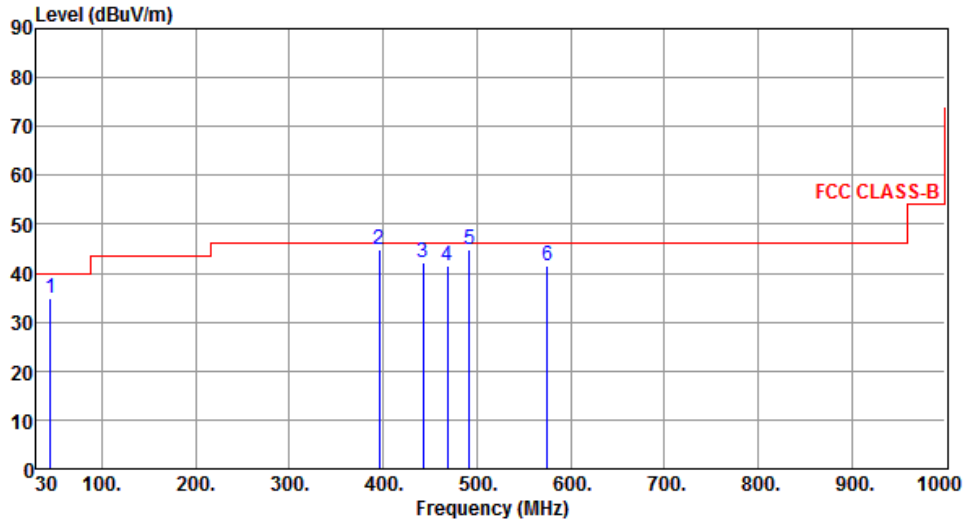

	Freq. MHz	Emission level dBuV/m	Limit dBuV/m	Margin dB	SA reading dBuV	Factor dB	Remark	ANT High cm	Turn Table deg
1	45.21	34.99	40.00	-5.01	43.09	-8.10	QP	100	118
2	396.17	44.96	46.00	-1.04	49.99	-5.03	QP	110	179
3	442.89	42.17	46.00	-3.83	45.99	-3.82	Peak	---	---
4	468.24	41.51	46.00	-4.49	44.83	-3.32	QP	100	123
5	491.87	44.83	46.00	-1.17	47.77	-2.94	QP	100	127
6	575.07	41.58	46.00	-4.42	42.63	-1.05	Peak	---	---

Note 1: Emission Level (dBuV/m) = SA Reading (dBuV/m) + Factor* (dB)

*Factor includes antenna factor , cable loss and amplifier gain

Note 2: Margin (dB) = Emission level (dBuV/m) – Limit (dBuV/m).

Note 3: All spurious emissions below 30MHz are more than 20 dB below the limit.

Modulation	11a	Test Freq. (MHz)	5785
Polarization	Horizontal	Test Configuration	1

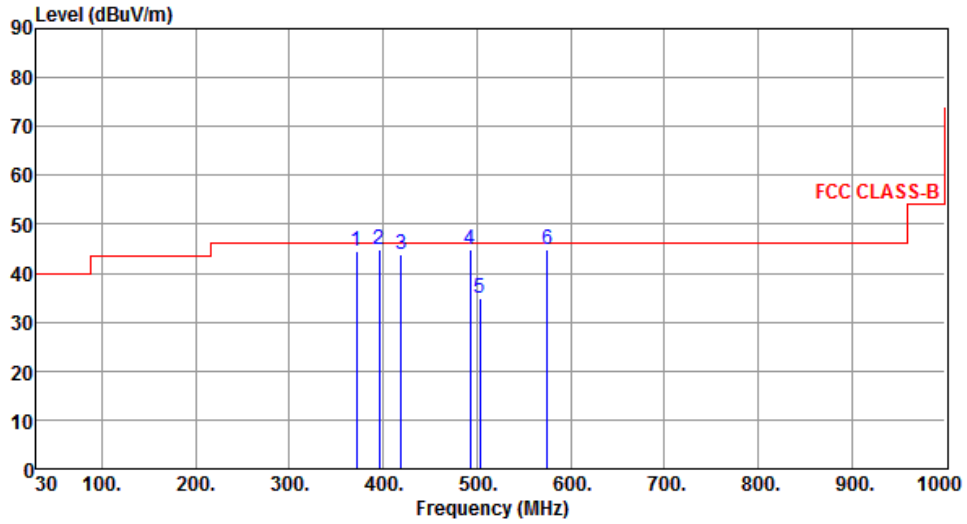

	Freq. MHz	Emission level dBuV/m	Limit dBuV/m	Margin dB	SA reading dBuV	Factor dB	Remark	ANT High cm	Turn Table deg
1	371.58	44.56	46.00	-1.44	50.28	-5.72	QP	100	127
2	395.87	44.92	46.00	-1.08	49.96	-5.04	QP	100	126
3	419.17	43.96	46.00	-2.04	48.39	-4.43	QP	100	123
4	493.27	44.81	46.00	-1.19	47.72	-2.91	QP	171	121
5	502.89	34.87	46.00	-11.13	37.62	-2.75	QP	182	63
6	575.19	44.71	46.00	-1.29	45.76	-1.05	QP	140	133

Note 1: Emission Level (dBuV/m) = SA Reading (dBuV/m) + Factor* (dB)

*Factor includes antenna factor , cable loss and amplifier gain

Note 2: Margin (dB) = Emission level (dBuV/m) – Limit (dBuV/m).

Note 3: All spurious emissions below 30MHz are more than 20 dB below the limit.

Modulation	11a	Test Freq. (MHz)	5785
Polarization	Vertical	Test Configuration	1

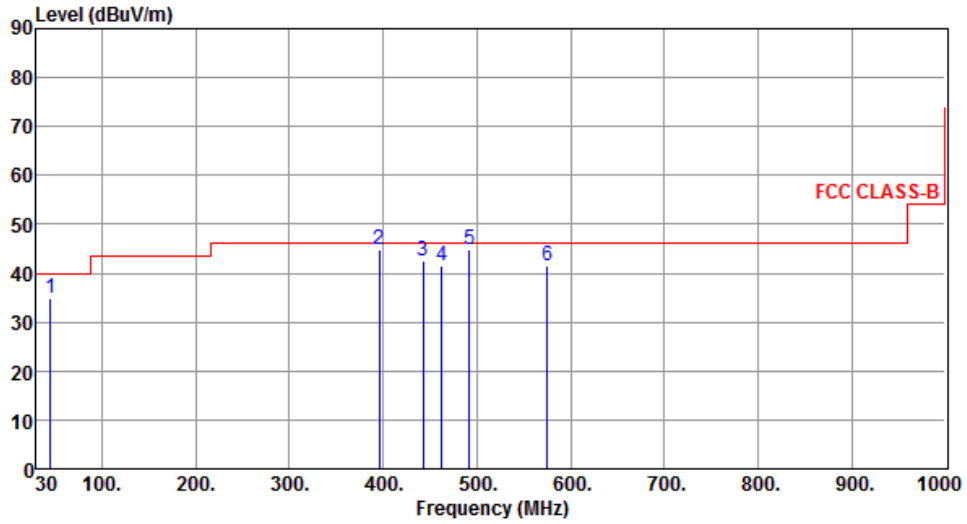

	Freq. MHz	Emission level dBuV/m	Limit dBuV/m	Margin dB	SA reading dBuV	Factor dB	Remark	ANT High cm	Turn Table deg
1	44.87	34.92	40.00	-5.08	43.04	-8.12	QP	100	121
2	395.80	44.91	46.00	-1.09	49.95	-5.04	QP	115	184
3	442.87	42.35	46.00	-3.65	46.17	-3.82	Peak	---	---
4	462.81	41.57	46.00	-4.43	44.99	-3.42	QP	100	127
5	491.87	44.74	46.00	-1.26	47.68	-2.94	QP	100	120
6	575.60	41.58	46.00	-4.42	42.61	-1.03	Peak	---	---

Note 1: Emission Level (dBuV/m) = SA Reading (dBuV/m) + Factor* (dB)

*Factor includes antenna factor , cable loss and amplifier gain

Note 2: Margin (dB) = Emission level (dBuV/m) – Limit (dBuV/m).

Note 3: All spurious emissions below 30MHz are more than 20 dB below the limit.

Modulation	11a	Test Freq. (MHz)	5240
Polarization	Horizontal	Test Configuration	2

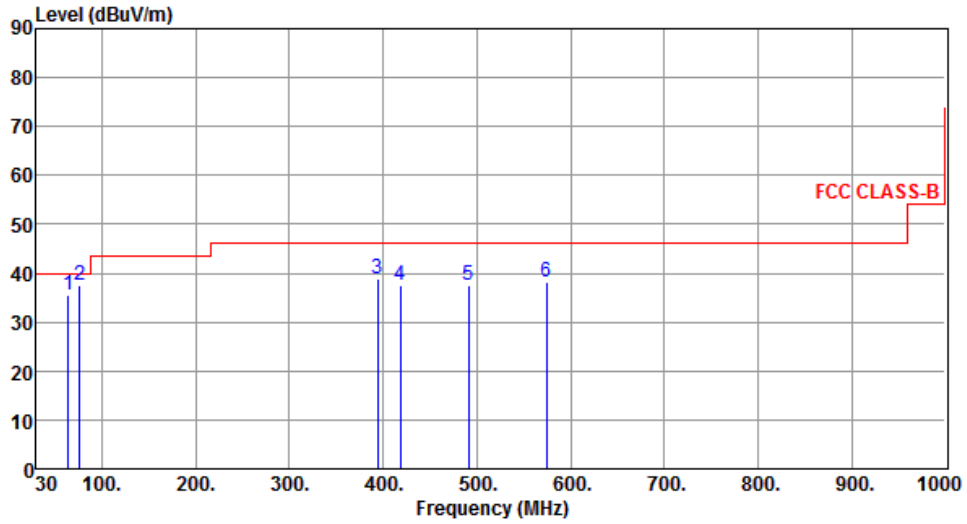

	Freq. MHz	Emission level dBuV/m	Limit dBuV/m	Margin dB	SA reading dBuV	Factor dB	Remark	ANT High cm	Turn Table deg
1	64.25	35.47	40.00	-4.53	44.91	-9.44	QP	100	57
2	76.24	37.47	40.00	-2.53	49.47	-12.00	QP	132	158
3	394.58	38.99	46.00	-7.01	44.07	-5.08	Peak	---	---
4	418.52	37.40	46.00	-8.60	41.84	-4.44	Peak	---	---
5	491.58	37.60	46.00	-8.40	40.54	-2.94	Peak	---	---
6	574.77	38.10	46.00	-7.90	39.16	-1.06	Peak	---	---

Note 1: Emission Level (dBuV/m) = SA Reading (dBuV/m) + Factor* (dB)

*Factor includes antenna factor , cable loss and amplifier gain

Note 2: Margin (dB) = Emission level (dBuV/m) – Limit (dBuV/m).

Note 3: All spurious emissions below 30MHz are more than 20 dB below the limit.

Modulation	11a	Test Freq. (MHz)	5240
Polarization	Vertical	Test Configuration	2

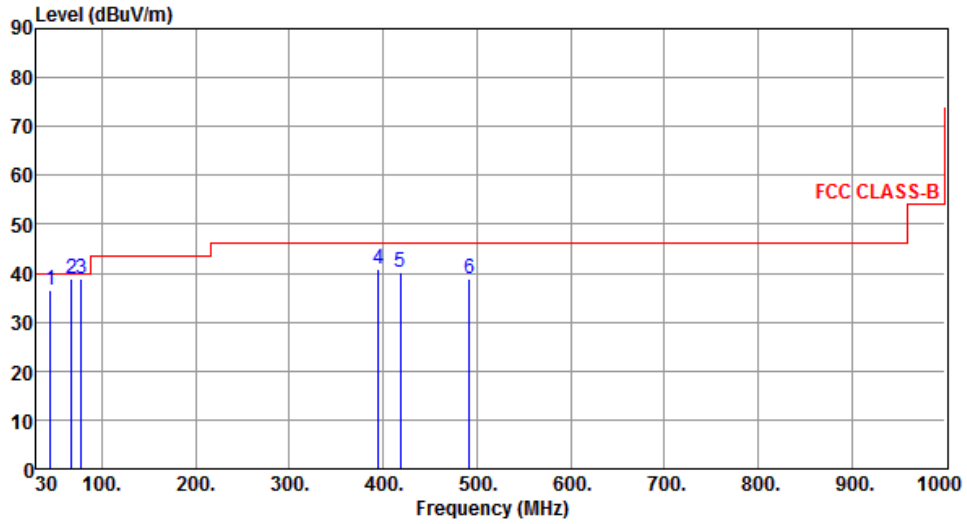

	Freq. MHz	Emission level dBuV/m	Limit dBuV/m	Margin dB	SA reading dBuV	Factor dB	Remark	ANT High cm	Turn Table deg
1	45.43	36.47	40.00	-3.53	44.56	-8.09	QP	100	97
2	67.69	38.97	40.00	-1.03	49.05	-10.08	QP	100	5
3	78.30	38.86	40.00	-1.14	51.30	-12.44	QP	162	183
4	394.85	40.69	46.00	-5.31	45.75	-5.06	Peak	---	---
5	418.57	40.32	46.00	-5.68	44.76	-4.44	Peak	---	---
6	491.88	38.74	46.00	-7.26	41.68	-2.94	Peak	---	---

Note 1: Emission Level (dBuV/m) = SA Reading (dBuV/m) + Factor* (dB)

*Factor includes antenna factor , cable loss and amplifier gain

Note 2: Margin (dB) = Emission level (dBuV/m) – Limit (dBuV/m).

Note 3: All spurious emissions below 30MHz are more than 20 dB below the limit.

Modulation	11a	Test Freq. (MHz)	5785
Polarization	Horizontal	Test Configuration	2

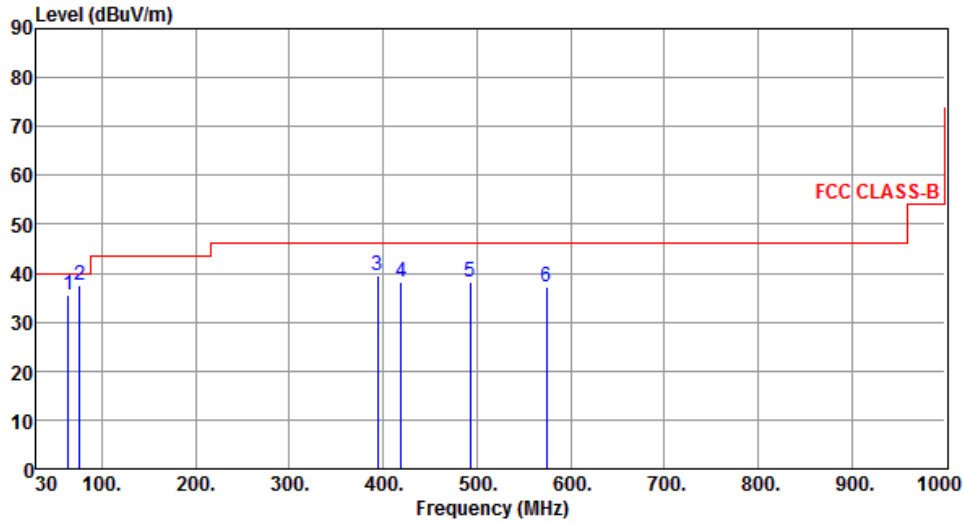

	Freq. MHz	Emission level dBuV/m	Limit dBuV/m	Margin dB	SA reading dBuV	Factor dB	Remark	ANT High cm	Turn Table deg
1	64.27	35.45	40.00	-4.55	44.89	-9.44	QP	100	59
2	76.42	37.57	40.00	-2.43	49.60	-12.03	QP	129	162
3	394.52	39.41	46.00	-6.59	44.49	-5.08	Peak	---	---
4	419.23	38.05	46.00	-7.95	42.48	-4.43	Peak	---	---
5	493.21	38.21	46.00	-7.79	41.12	-2.91	Peak	---	---
6	574.23	37.05	46.00	-8.95	38.12	-1.07	Peak	---	---

Note 1: Emission Level (dBuV/m) = SA Reading (dBuV/m) + Factor* (dB)

*Factor includes antenna factor , cable loss and amplifier gain

Note 2: Margin (dB) = Emission level (dBuV/m) – Limit (dBuV/m).

Note 3: All spurious emissions below 30MHz are more than 20 dB below the limit.

Modulation	11a	Test Freq. (MHz)	5785
Polarization	Vertical	Test Configuration	2

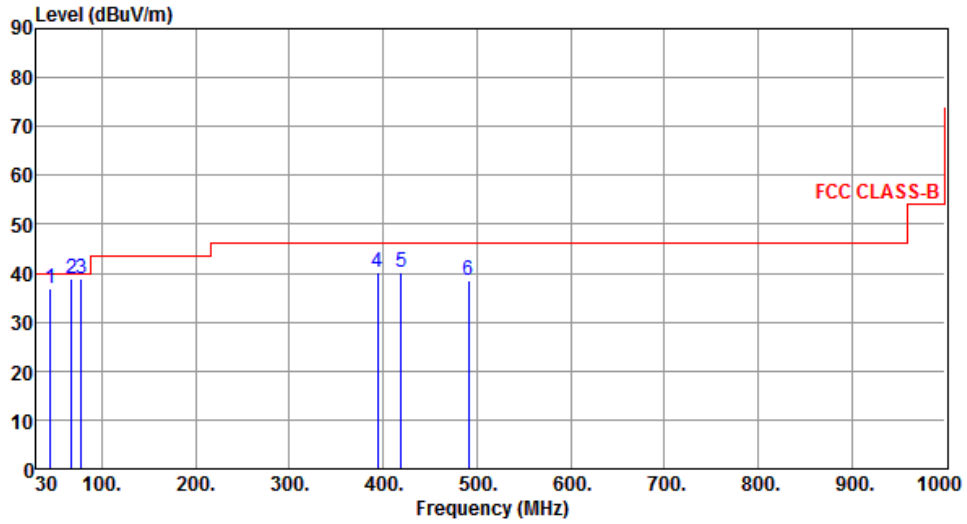

	Freq. MHz	Emission level dBuV/m	Limit dBuV/m	Margin dB	SA reading dBuV	Factor dB	Remark	ANT High cm	Turn Table deg
1	45.24	36.74	40.00	-3.26	44.84	-8.10	QP	100	92
2	67.82	38.95	40.00	-1.05	49.06	-10.11	QP	100	2
3	78.25	38.87	40.00	-1.13	51.31	-12.44	QP	158	178
4	394.57	40.21	46.00	-5.79	45.29	-5.08	Peak	---	---
5	419.28	40.23	46.00	-5.77	44.66	-4.43	Peak	---	---
6	491.25	38.58	46.00	-7.42	41.52	-2.94	Peak	---	---

Note 1: Emission Level (dBuV/m) = SA Reading (dBuV/m) + Factor* (dB)

*Factor includes antenna factor , cable loss and amplifier gain

Note 2: Margin (dB) = Emission level (dBuV/m) – Limit (dBuV/m).

Note 3: All spurious emissions below 30MHz are more than 20 dB below the limit.

3.5.5 Transmitter Radiated Unwanted Emissions (Above 1GHz) for 11a

Modulation	11a	Test Freq. (MHz)	5180
Polarization	Horizontal	Test Configuration	2

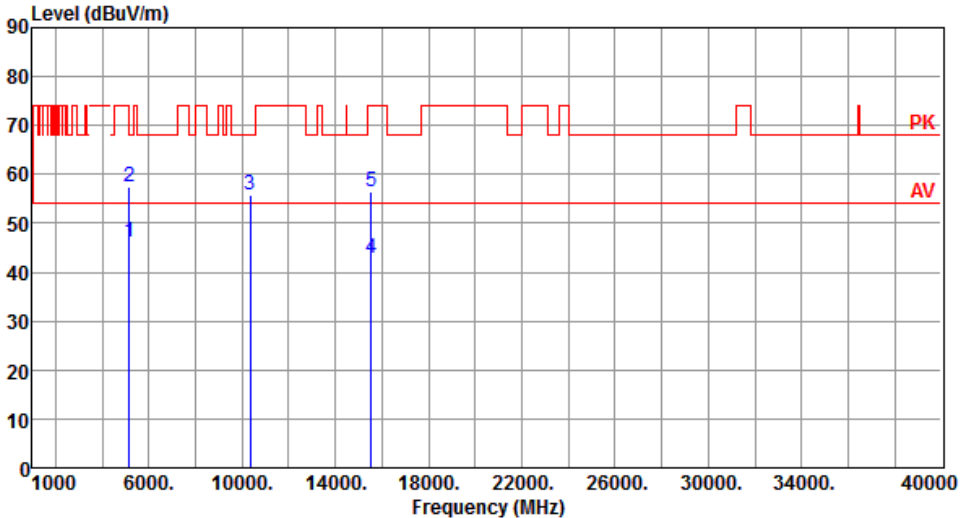

	Freq. MHz	Emission level dBuV/m	Limit dBuV/m	Margin dB	SA reading dBuV	Factor dB	Remark	ANT High cm	Turn Table deg
1	5150.00	46.13	54.00	-7.87	40.18	5.95	Average	251	251
2	5150.00	57.54	74.00	-16.46	51.59	5.95	Peak	251	251
3	10360.00	55.89	68.20	-12.31	40.79	15.10	Peak	100	247
4	15540.00	42.69	54.00	-11.31	27.04	15.65	Average	100	259
5	15540.00	56.58	74.00	-17.42	40.93	15.65	Peak	100	259

Note 1: Emission Level (dBuV/m) = SA Reading (dBuV/m) + Factor* (dB)
*Factor includes antenna factor , cable loss and amplifier gain
Note 2: Margin (dB) = Emission level (dBuV/m) – Limit (dBuV/m).

Modulation	11a	Test Freq. (MHz)	5180
Polarization	Vertical	Test Configuration	2

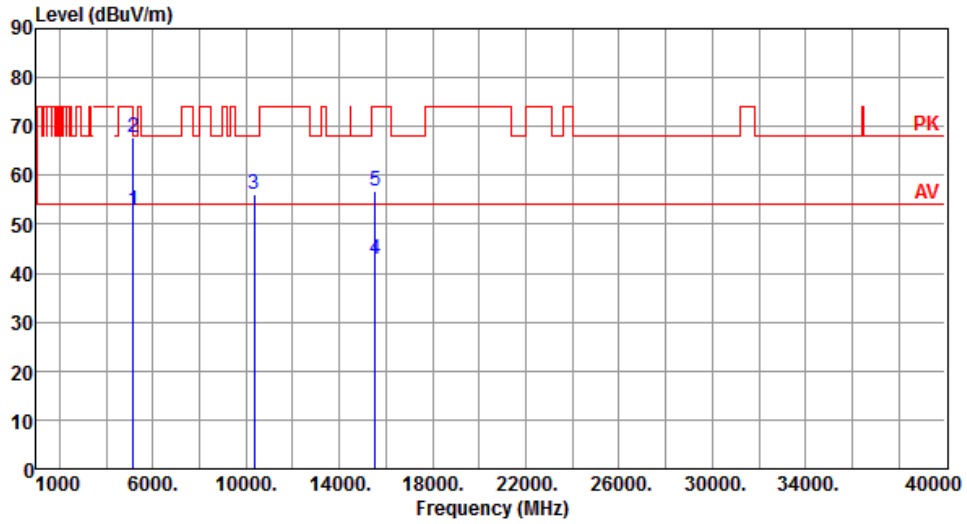

	Freq. MHz	Emission level dBuV/m	Limit dBuV/m	Margin dB	SA reading dBuV	Factor dB	Remark	ANT High cm	Turn Table deg
1	5150.00	52.68	54.00	-1.32	46.73	5.95	Average	199	258
2	5150.00	67.80	74.00	-6.20	61.85	5.95	Peak	199	258
3	10360.00	56.02	68.20	-12.18	40.92	15.10	Peak	100	147
4	15540.00	42.69	54.00	-11.31	27.04	15.65	Average	100	147
5	15540.00	56.95	74.00	-17.05	41.30	15.65	Peak	100	147

Note 1: Emission Level (dBuV/m) = SA Reading (dBuV/m) + Factor* (dB)

*Factor includes antenna factor , cable loss and amplifier gain

Note 2: Margin (dB) = Emission level (dBuV/m) – Limit (dBuV/m).

Modulation	11a	Test Freq. (MHz)	5200
Polarization	Horizontal	Test Configuration	2

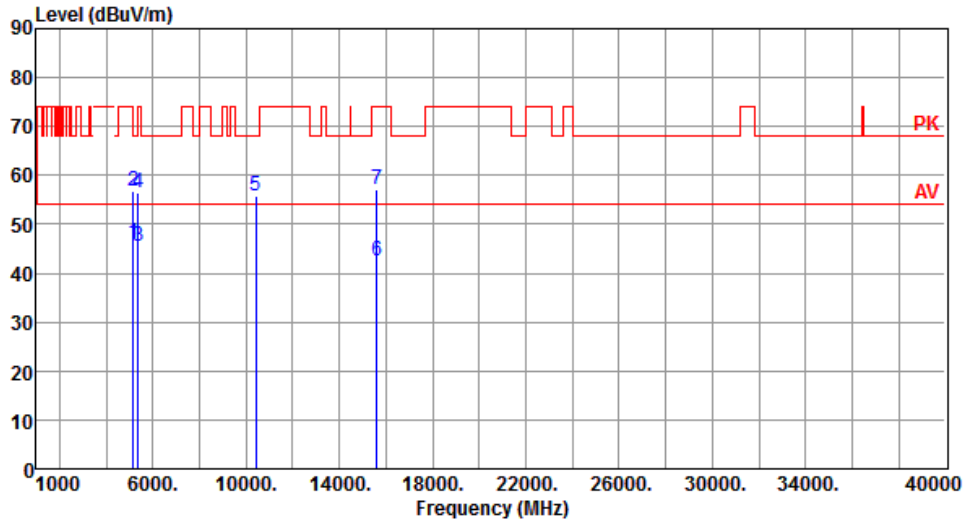

	Freq. MHz	Emission level dBuV/m	Limit dBuV/m	Margin dB	SA reading dBuV	Factor dB	Remark	ANT High cm	Turn Table deg
1	5150.00	46.07	54.00	-7.93	40.12	5.95	Average	279	226
2	5150.00	56.91	74.00	-17.09	50.96	5.95	Peak	279	226
3	5350.00	45.39	54.00	-8.61	39.99	5.40	Average	279	226
4	5350.00	56.59	74.00	-17.41	51.19	5.40	Peak	279	226
5	10400.00	55.70	68.20	-12.50	40.37	15.33	Peak	100	243
6	15600.00	42.65	54.00	-11.35	27.16	15.49	Average	100	251
7	15600.00	56.97	74.00	-17.03	41.48	15.49	Peak	100	251

Note 1: Emission Level (dBuV/m) = SA Reading (dBuV/m) + Factor* (dB)

*Factor includes antenna factor , cable loss and amplifier gain

Note 2: Margin (dB) = Emission level (dBuV/m) – Limit (dBuV/m).

Modulation	11a	Test Freq. (MHz)	5200
Polarization	Vertical	Test Configuration	2

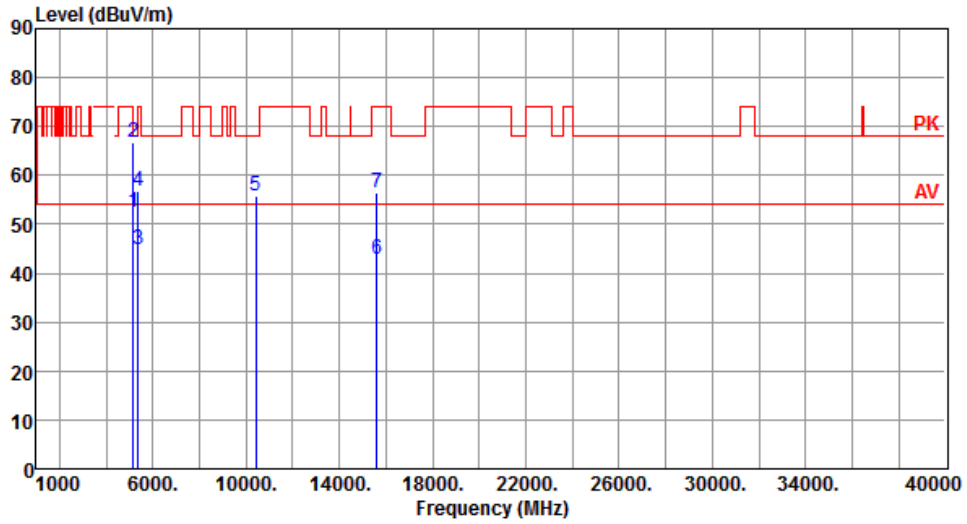

	Freq. MHz	Emission level dBuV/m	Limit dBuV/m	Margin dB	SA reading dBuV	Factor dB	Remark	ANT High cm	Turn Table deg
1	5150.00	52.61	54.00	-1.39	46.66	5.95	Average	197	257
2	5150.00	66.91	74.00	-7.09	60.96	5.95	Peak	197	257
3	5350.00	44.69	54.00	-9.31	39.29	5.40	Average	197	257
4	5350.00	56.70	74.00	-17.30	51.30	5.40	Peak	197	257
5	10400.00	55.79	68.20	-12.41	40.46	15.33	Peak	100	149
6	15600.00	42.86	54.00	-11.14	27.37	15.49	Average	100	154
7	15600.00	56.47	74.00	-17.53	40.98	15.49	Peak	100	154

Note 1: Emission Level (dBuV/m) = SA Reading (dBuV/m) + Factor* (dB)

*Factor includes antenna factor , cable loss and amplifier gain

Note 2: Margin (dB) = Emission level (dBuV/m) – Limit (dBuV/m).

Modulation	11a	Test Freq. (MHz)	5240
Polarization	Horizontal	Test Configuration	2

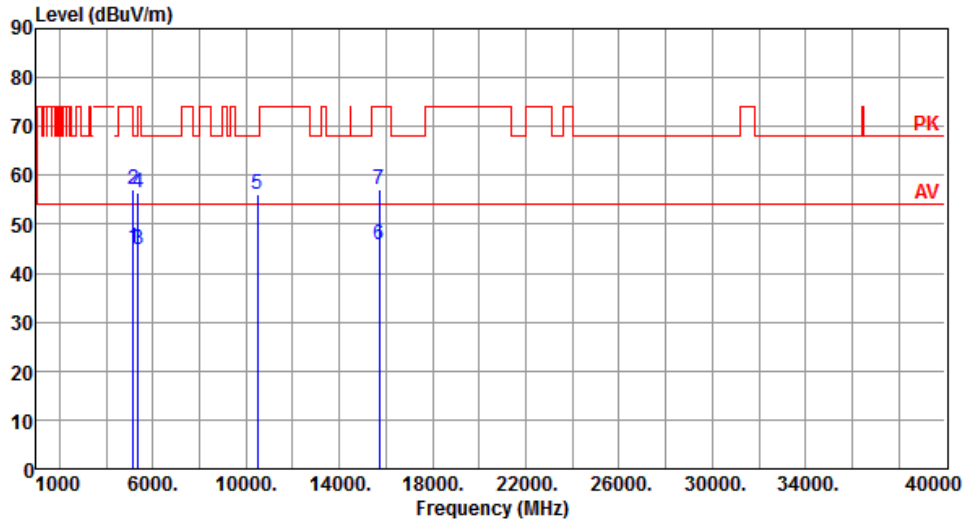

	Freq. MHz	Emission level dBuV/m	Limit dBuV/m	Margin dB	SA reading dBuV	Factor dB	Remark	ANT High cm	Turn Table deg
1	5150.00	45.13	54.00	-8.87	39.18	5.95	Average	263	251
2	5150.00	57.24	74.00	-16.76	51.29	5.95	Peak	263	251
3	5350.00	44.69	54.00	-9.31	39.29	5.40	Average	263	251
4	5350.00	56.56	74.00	-17.44	51.16	5.40	Peak	263	251
5	10480.00	56.02	68.20	-12.18	40.71	15.31	Peak	100	244
6	15720.00	45.92	54.00	-8.08	30.69	15.23	Average	100	214
7	15720.00	57.03	74.00	-16.97	41.80	15.23	Peak	100	214

Note 1: Emission Level (dBuV/m) = SA Reading (dBuV/m) + Factor* (dB)

*Factor includes antenna factor , cable loss and amplifier gain

Note 2: Margin (dB) = Emission level (dBuV/m) – Limit (dBuV/m).

Modulation	11a	Test Freq. (MHz)	5240
Polarization	Vertical	Test Configuration	2

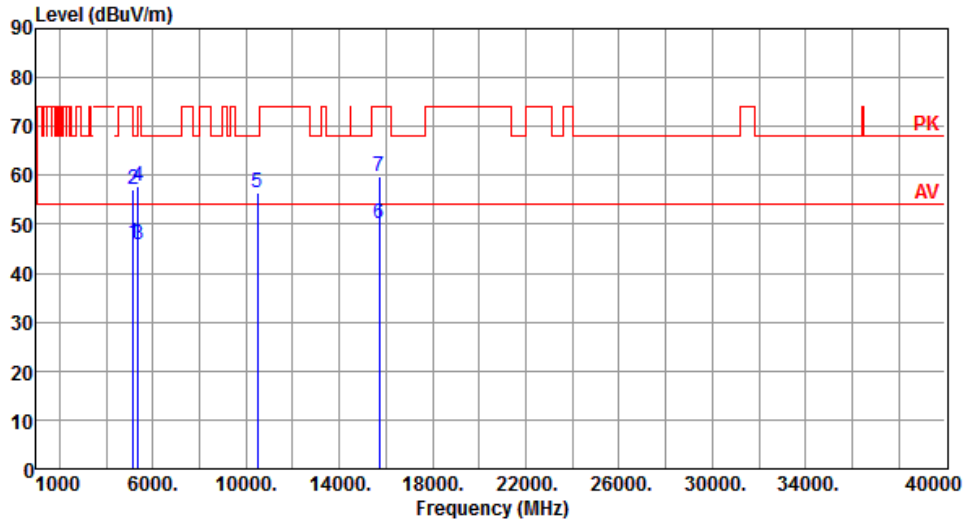

	Freq. MHz	Emission level dBuV/m	Limit dBuV/m	Margin dB	SA reading dBuV	Factor dB	Remark	ANT High cm	Turn Table deg
1	5150.00	46.12	54.00	-7.88	40.17	5.95	Average	177	258
2	5150.00	57.24	74.00	-16.76	51.29	5.95	Peak	177	258
3	5350.00	45.69	54.00	-8.31	40.29	5.40	Average	177	258
4	5350.00	57.66	74.00	-16.34	52.26	5.40	Peak	177	258
5	10480.00	56.44	68.20	-11.76	41.13	15.31	Peak	100	155
6	15720.00	50.21	54.00	-3.79	34.98	15.23	Average	100	174
7	15720.00	59.73	74.00	-14.27	44.50	15.23	Peak	100	174

Note 1: Emission Level (dBuV/m) = SA Reading (dBuV/m) + Factor* (dB)

*Factor includes antenna factor , cable loss and amplifier gain

Note 2: Margin (dB) = Emission level (dBuV/m) – Limit (dBuV/m).

Modulation	11a	Test Freq. (MHz)	5745
Polarization	Horizontal	Test Configuration	2

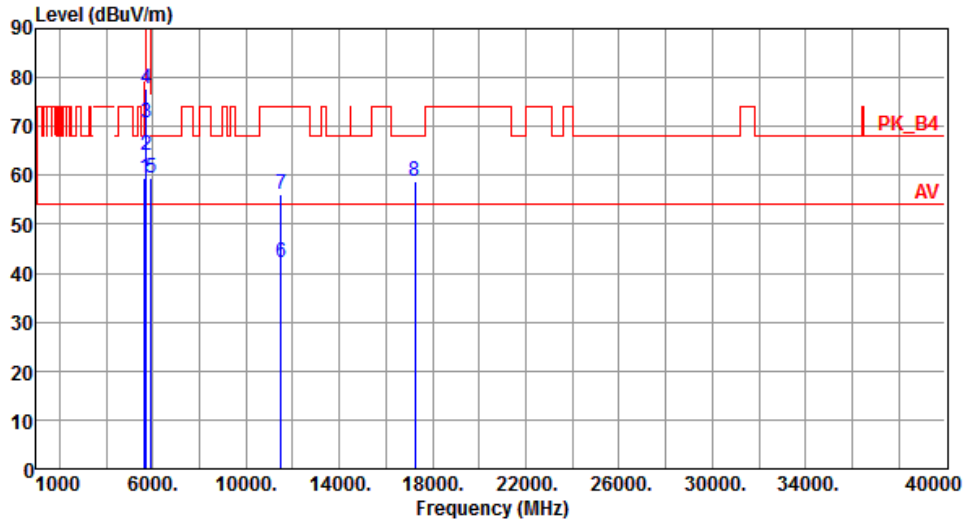

	Freq. MHz	Emission level dBuV/m	Limit dBuV/m	Margin dB	SA reading dBuV	Factor dB	Remark	ANT High cm	Turn Table deg
1	5650.00	59.54	68.20	-8.66	53.63	5.91	Peak	100	44
2	5700.00	64.03	105.20	-41.17	57.80	6.23	Peak	100	44
3	5720.00	70.62	110.80	-40.18	64.34	6.28	Peak	100	44
4	5725.00	77.84	122.20	-44.36	71.55	6.29	Peak	100	44
5	5925.00	59.50	68.20	-8.70	52.68	6.82	Peak	100	44
6	11490.00	42.30	54.00	-11.70	26.85	15.45	Average	100	62
7	11490.00	56.02	74.00	-17.98	40.57	15.45	Peak	100	62
8	17235.00	58.82	68.20	-9.38	41.84	16.98	Peak	100	57

Note 1: Emission Level (dBuV/m) = SA Reading (dBuV/m) + Factor* (dB)

*Factor includes antenna factor , cable loss and amplifier gain

Note 2: Margin (dB) = Emission level (dBuV/m) – Limit (dBuV/m).

Modulation	11a	Test Freq. (MHz)	5745
Polarization	Vertical	Test Configuration	2

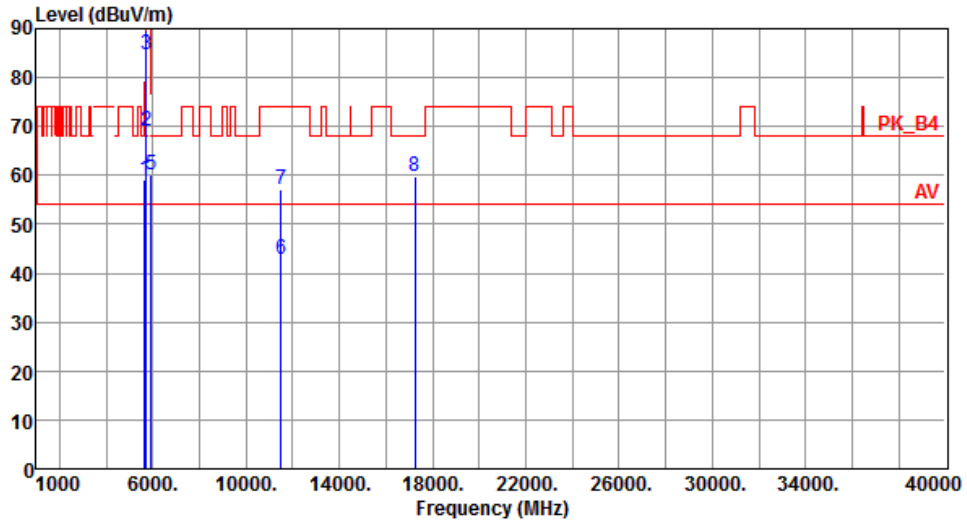

	Freq. MHz	Emission level dBuV/m	Limit dBuV/m	Margin dB	SA reading dBuV	Factor dB	Remark	ANT High cm	Turn Table deg
1	5650.00	59.08	68.20	-9.12	53.17	5.91	Peak	100	72
2	5700.00	69.05	105.20	-36.15	62.82	6.23	Peak	100	72
3	5720.00	84.81	110.80	-25.99	78.53	6.28	Peak	100	72
4	5725.00	89.82	122.20	-32.38	83.53	6.29	Peak	100	72
5	5925.00	59.97	68.20	-8.23	53.15	6.82	Peak	100	72
6	11490.00	42.70	54.00	-11.30	27.25	15.45	Average	10	35
7	11490.00	57.00	74.00	-17.00	41.55	15.45	Peak	10	35
8	17235.00	59.93	68.20	-8.27	42.95	16.98	Peak	10	70

Note 1: Emission Level (dBuV/m) = SA Reading (dBuV/m) + Factor* (dB)

*Factor includes antenna factor , cable loss and amplifier gain

Note 2: Margin (dB) = Emission level (dBuV/m) – Limit (dBuV/m).

Modulation	11a	Test Freq. (MHz)	5785
Polarization	Horizontal	Test Configuration	2

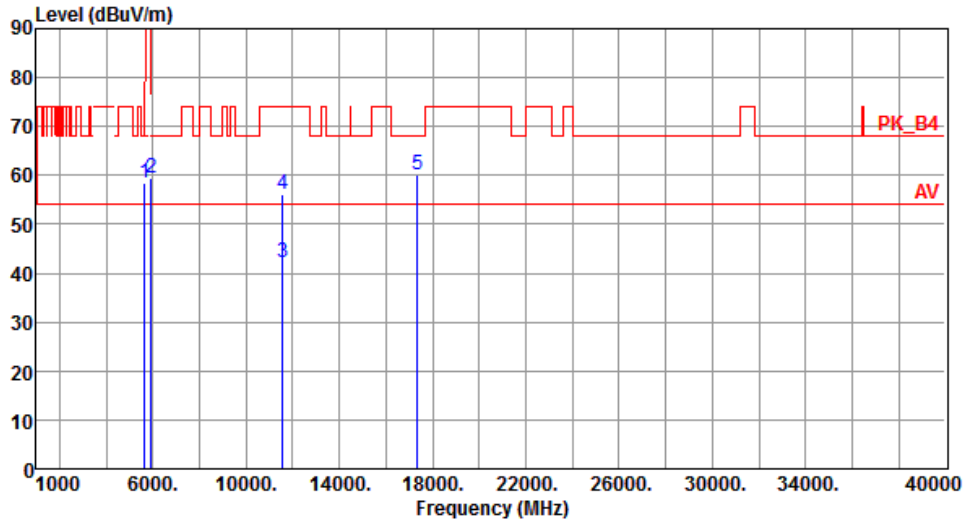

	Freq. MHz	Emission level dBuV/m	Limit dBuV/m	Margin dB	SA reading dBuV	Factor dB	Remark	ANT High cm	Turn Table deg
1	5650.00	58.51	68.20	-9.69	52.60	5.91	Peak	100	42
2	5925.00	59.53	68.20	-8.67	52.71	6.82	Peak	100	42
3	11570.00	42.18	54.00	-11.82	26.88	15.30	Average	100	68
4	11570.00	56.23	74.00	-17.77	40.93	15.30	Peak	100	68
5	17355.00	60.19	68.20	-8.01	42.58	17.61	Peak	100	59

Note 1: Emission Level (dBuV/m) = SA Reading (dBuV/m) + Factor* (dB)

*Factor includes antenna factor , cable loss and amplifier gain

Note 2: Margin (dB) = Emission level (dBuV/m) – Limit (dBuV/m).

Modulation	11a	Test Freq. (MHz)	5785
Polarization	Vertical	Test Configuration	2

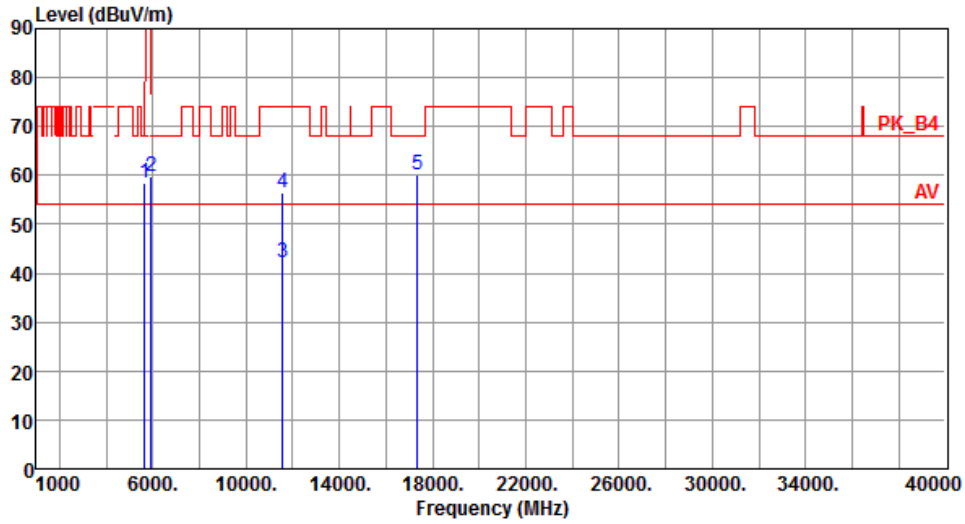

	Freq. MHz	Emission level dBuV/m	Limit dBuV/m	Margin dB	SA reading dBuV	Factor dB	Remark	ANT High cm	Turn Table deg
1	5650.00	58.44	68.20	-9.76	52.53	5.91	Peak	100	69
2	5925.00	59.78	68.20	-8.42	52.96	6.82	Peak	100	69
3	11570.00	42.29	54.00	-11.71	26.99	15.30	Average	100	31
4	11570.00	56.33	74.00	-17.67	41.03	15.30	Peak	100	31
5	17355.00	60.27	68.20	-7.93	42.66	17.61	Peak	100	63

Note 1: Emission Level (dBuV/m) = SA Reading (dBuV/m) + Factor* (dB)

*Factor includes antenna factor , cable loss and amplifier gain

Note 2: Margin (dB) = Emission level (dBuV/m) – Limit (dBuV/m).

Modulation	11a	Test Freq. (MHz)	5825
Polarization	Horizontal	Test Configuration	2

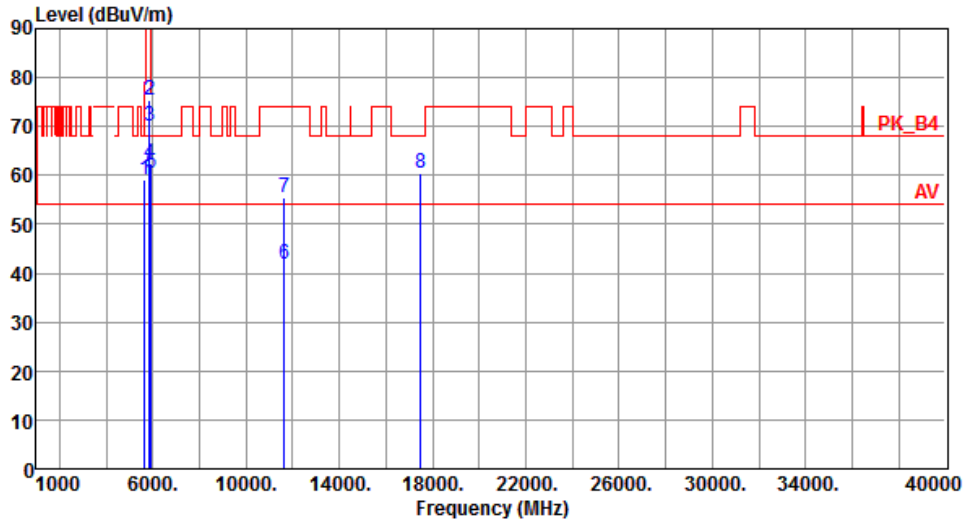

	Freq. MHz	Emission level dBuV/m	Limit dBuV/m	Margin dB	SA reading dBuV	Factor dB	Remark	ANT High cm	Turn Table deg
1	5650.00	59.24	68.20	-8.96	53.33	5.91	Peak	100	46
2	5850.00	75.51	122.20	-46.69	68.84	6.67	Peak	100	46
3	5855.00	70.01	110.80	-40.79	63.33	6.68	Peak	100	46
4	5875.00	62.60	105.20	-42.60	55.88	6.72	Peak	100	46
5	5925.00	60.29	68.20	-7.91	53.47	6.82	Peak	100	46
6	11650.00	41.81	54.00	-12.19	26.75	15.06	Average	100	69
7	11650.00	55.52	74.00	-18.48	40.46	15.06	Peak	100	69
8	17475.00	60.60	68.20	-7.60	42.37	18.23	Peak	100	55

Note 1: Emission Level (dBuV/m) = SA Reading (dBuV/m) + Factor* (dB)

*Factor includes antenna factor , cable loss and amplifier gain

Note 2: Margin (dB) = Emission level (dBuV/m) – Limit (dBuV/m).

Modulation	11a	Test Freq. (MHz)	5825
Polarization	Vertical	Test Configuration	2

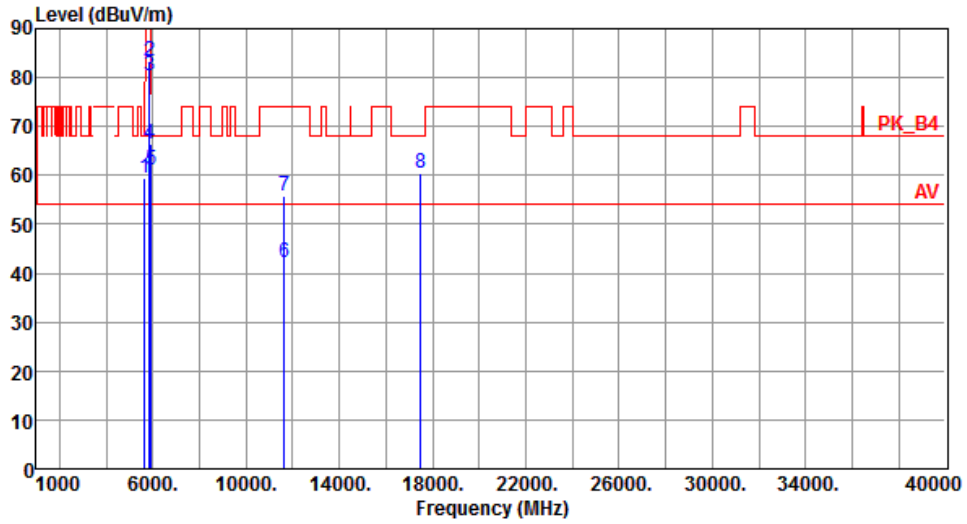

	Freq. MHz	Emission level dBuV/m	Limit dBuV/m	Margin dB	SA reading dBuV	Factor dB	Remark	ANT High cm	Turn Table deg
1	5650.00	59.38	68.20	-8.82	53.47	5.91	Peak	100	69
2	5850.00	83.39	122.20	-38.81	76.72	6.67	Peak	100	69
3	5855.00	80.26	110.80	-30.54	73.58	6.68	Peak	100	69
4	5875.00	66.26	105.20	-38.94	59.54	6.72	Peak	100	69
5	5925.00	61.07	68.20	-7.13	54.25	6.82	Peak	100	69
6	11650.00	42.02	54.00	-11.98	26.96	15.06	Average	100	33
7	11650.00	55.77	74.00	-18.23	40.71	15.06	Peak	100	33
8	17475.00	60.55	68.20	-7.65	42.32	18.23	Peak	100	72

Note 1: Emission Level (dBuV/m) = SA Reading (dBuV/m) + Factor* (dB)

*Factor includes antenna factor , cable loss and amplifier gain

Note 2: Margin (dB) = Emission level (dBuV/m) – Limit (dBuV/m).

3.5.6 Transmitter Radiated Unwanted Emissions (Above 1GHz) for VHT20

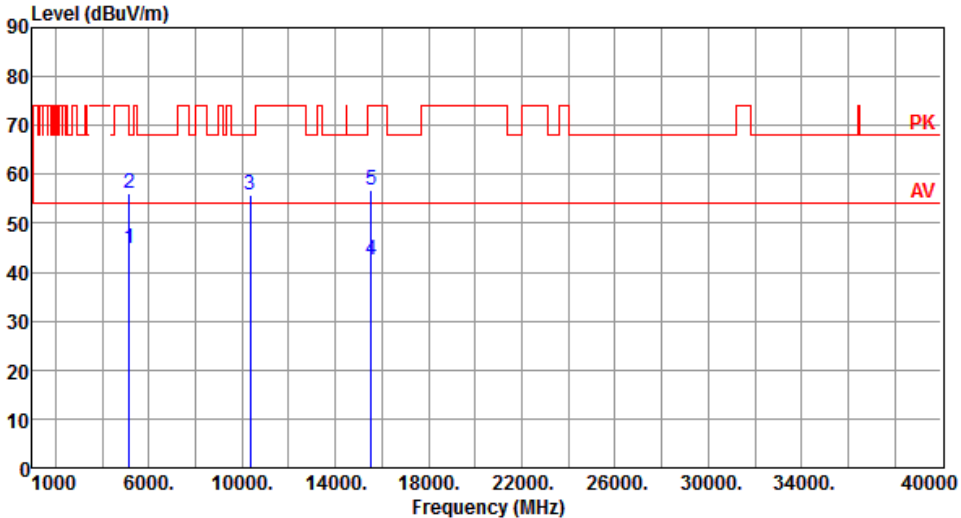
Modulation	VHT20	Test Freq. (MHz)	5180																																																																									
Polarization	Horizontal	Test Configuration	2																																																																									
																																																																												
	<table border="1"> <thead> <tr> <th>Freq.</th> <th>Emission level</th> <th>Limit</th> <th>Margin</th> <th>SA reading</th> <th>Factor</th> <th>Remark</th> <th>ANT High</th> <th>Turn Table</th> </tr> <tr> <th>MHz</th> <th>dBuV/m</th> <th>dBuV/m</th> <th>dB</th> <th>dBuV</th> <th>dB</th> <th></th> <th>cm</th> <th>deg</th> </tr> </thead> <tbody> <tr> <td>1</td> <td>5150.00</td> <td>44.80</td> <td>54.00</td> <td>-9.20</td> <td>38.85</td> <td>5.95</td> <td>Average</td> <td>283</td> <td>226</td> </tr> <tr> <td>2</td> <td>5150.00</td> <td>56.13</td> <td>74.00</td> <td>-17.87</td> <td>50.18</td> <td>5.95</td> <td>Peak</td> <td>283</td> <td>226</td> </tr> <tr> <td>3</td> <td>10360.00</td> <td>55.95</td> <td>68.20</td> <td>-12.25</td> <td>40.85</td> <td>15.10</td> <td>Peak</td> <td>100</td> <td>159</td> </tr> <tr> <td>4</td> <td>15540.00</td> <td>42.42</td> <td>54.00</td> <td>-11.58</td> <td>26.77</td> <td>15.65</td> <td>Average</td> <td>100</td> <td>181</td> </tr> <tr> <td>5</td> <td>15540.00</td> <td>56.92</td> <td>74.00</td> <td>-17.08</td> <td>41.27</td> <td>15.65</td> <td>Peak</td> <td>100</td> <td>181</td> </tr> </tbody> </table>	Freq.	Emission level	Limit	Margin	SA reading	Factor	Remark	ANT High	Turn Table	MHz	dBuV/m	dBuV/m	dB	dBuV	dB		cm	deg	1	5150.00	44.80	54.00	-9.20	38.85	5.95	Average	283	226	2	5150.00	56.13	74.00	-17.87	50.18	5.95	Peak	283	226	3	10360.00	55.95	68.20	-12.25	40.85	15.10	Peak	100	159	4	15540.00	42.42	54.00	-11.58	26.77	15.65	Average	100	181	5	15540.00	56.92	74.00	-17.08	41.27	15.65	Peak	100	181							
Freq.	Emission level	Limit	Margin	SA reading	Factor	Remark	ANT High	Turn Table																																																																				
MHz	dBuV/m	dBuV/m	dB	dBuV	dB		cm	deg																																																																				
1	5150.00	44.80	54.00	-9.20	38.85	5.95	Average	283	226																																																																			
2	5150.00	56.13	74.00	-17.87	50.18	5.95	Peak	283	226																																																																			
3	10360.00	55.95	68.20	-12.25	40.85	15.10	Peak	100	159																																																																			
4	15540.00	42.42	54.00	-11.58	26.77	15.65	Average	100	181																																																																			
5	15540.00	56.92	74.00	-17.08	41.27	15.65	Peak	100	181																																																																			
<p>Note 1: Emission Level (dBuV/m) = SA Reading (dBuV/m) + Factor* (dB) *Factor includes antenna factor , cable loss and amplifier gain Note 2: Margin (dB) = Emission level (dBuV/m) – Limit (dBuV/m).</p>																																																																												

Modulation	VHT20	Test Freq. (MHz)	5180
Polarization	Vertical	Test Configuration	2

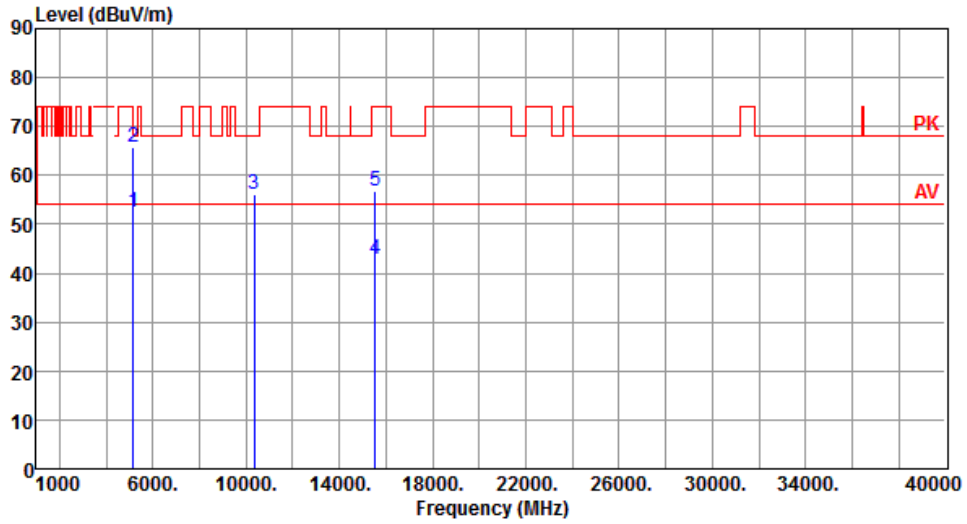

	Freq. MHz	Emission level dBuV/m	Limit dBuV/m	Margin dB	SA reading dBuV	Factor dB	Remark	ANT High cm	Turn Table deg
1	5150.00	52.54	54.00	-1.46	46.59	5.95	Average	184	277
2	5150.00	65.80	74.00	-8.20	59.85	5.95	Peak	184	277
3	10360.00	56.19	68.20	-12.01	41.09	15.10	Peak	100	152
4	15540.00	42.69	54.00	-11.31	27.04	15.65	Average	100	195
5	15540.00	56.64	74.00	-17.36	40.99	15.65	Peak	100	195

Note 1: Emission Level (dBuV/m) = SA Reading (dBuV/m) + Factor* (dB)

*Factor includes antenna factor , cable loss and amplifier gain

Note 2: Margin (dB) = Emission level (dBuV/m) – Limit (dBuV/m).

Modulation	VHT20	Test Freq. (MHz)	5200
Polarization	Horizontal	Test Configuration	2

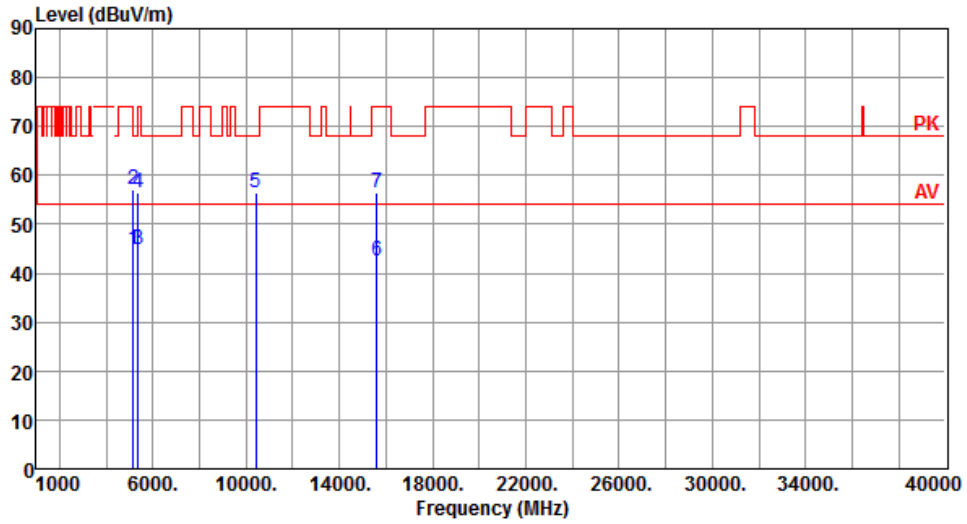

	Freq. MHz	Emission level dBuV/m	Limit dBuV/m	Margin dB	SA reading dBuV	Factor dB	Remark	ANT High cm	Turn Table deg
1	5150.00	44.72	54.00	-9.28	38.77	5.95	Average	326	227
2	5150.00	57.24	74.00	-16.76	51.29	5.95	Peak	326	227
3	5350.00	44.71	54.00	-9.29	39.31	5.40	Average	326	227
4	5350.00	56.51	74.00	-17.49	51.11	5.40	Peak	326	227
5	10400.00	56.54	68.20	-11.66	41.21	15.33	Peak	100	152
6	15600.00	42.59	54.00	-11.41	27.10	15.49	Average	100	183
7	15600.00	56.37	74.00	-17.63	40.88	15.49	Peak	100	183

Note 1: Emission Level (dBuV/m) = SA Reading (dBuV/m) + Factor* (dB)

*Factor includes antenna factor , cable loss and amplifier gain

Note 2: Margin (dB) = Emission level (dBuV/m) – Limit (dBuV/m).

Modulation	VHT20	Test Freq. (MHz)	5200
Polarization	Vertical	Test Configuration	2

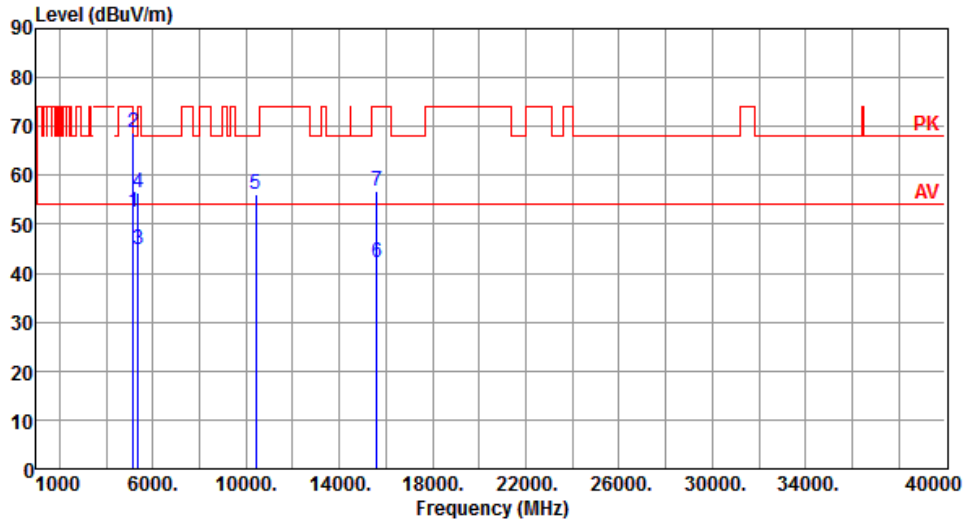

	Freq. MHz	Emission level dBuV/m	Limit dBuV/m	Margin dB	SA reading dBuV	Factor dB	Remark	ANT High cm	Turn Table deg
1	5150.00	52.43	54.00	-1.57	46.48	5.95	Average	223	255
2	5150.00	68.80	74.00	-5.20	62.85	5.95	Peak	223	255
3	5350.00	44.69	54.00	-9.31	39.29	5.40	Average	223	258
4	5350.00	56.49	74.00	-17.51	51.09	5.40	Peak	223	258
5	10400.00	56.21	68.20	-11.99	40.88	15.33	Peak	100	151
6	15600.00	42.24	54.00	-11.76	26.75	15.49	Average	100	192
7	15600.00	56.68	74.00	-17.32	41.19	15.49	Peak	100	192

Note 1: Emission Level (dBuV/m) = SA Reading (dBuV/m) + Factor* (dB)

*Factor includes antenna factor , cable loss and amplifier gain

Note 2: Margin (dB) = Emission level (dBuV/m) – Limit (dBuV/m).

Modulation	VHT20	Test Freq. (MHz)	5240
Polarization	Horizontal	Test Configuration	2

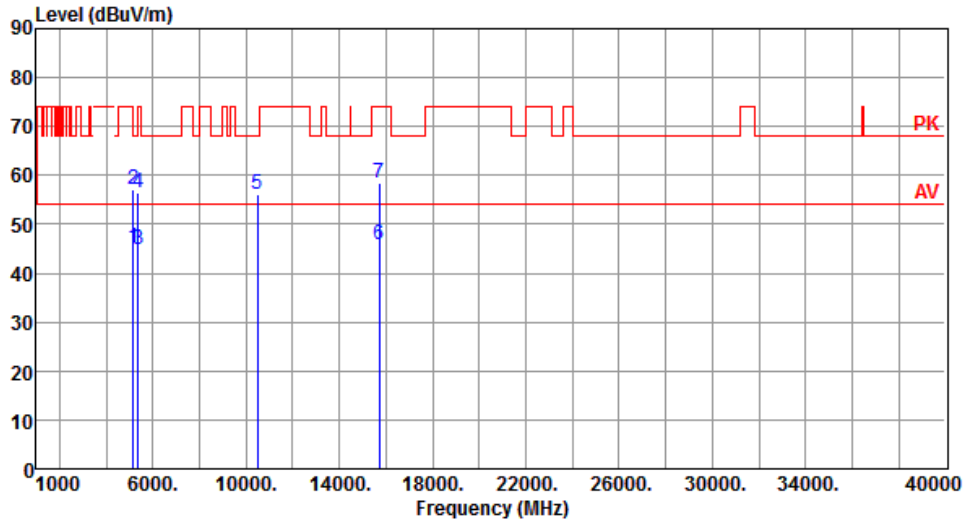

	Freq. MHz	Emission level dBuV/m	Limit dBuV/m	Margin dB	SA reading dBuV	Factor dB	Remark	ANT High cm	Turn Table deg
1	5150.00	45.06	54.00	-8.94	39.11	5.95	Average	279	228
2	5150.00	57.12	74.00	-16.88	51.17	5.95	Peak	279	228
3	5350.00	44.69	54.00	-9.31	39.29	5.40	Average	279	228
4	5350.00	56.29	74.00	-17.71	50.89	5.40	Peak	279	228
5	10480.00	55.99	68.20	-12.21	40.68	15.31	Peak	100	154
6	15720.00	45.76	54.00	-8.24	30.53	15.23	Average	100	185
7	15720.00	58.46	74.00	-15.54	43.23	15.23	Peak	100	185

Note 1: Emission Level (dBuV/m) = SA Reading (dBuV/m) + Factor* (dB)

*Factor includes antenna factor , cable loss and amplifier gain

Note 2: Margin (dB) = Emission level (dBuV/m) – Limit (dBuV/m).

Modulation	VHT20	Test Freq. (MHz)	5240
Polarization	Vertical	Test Configuration	2

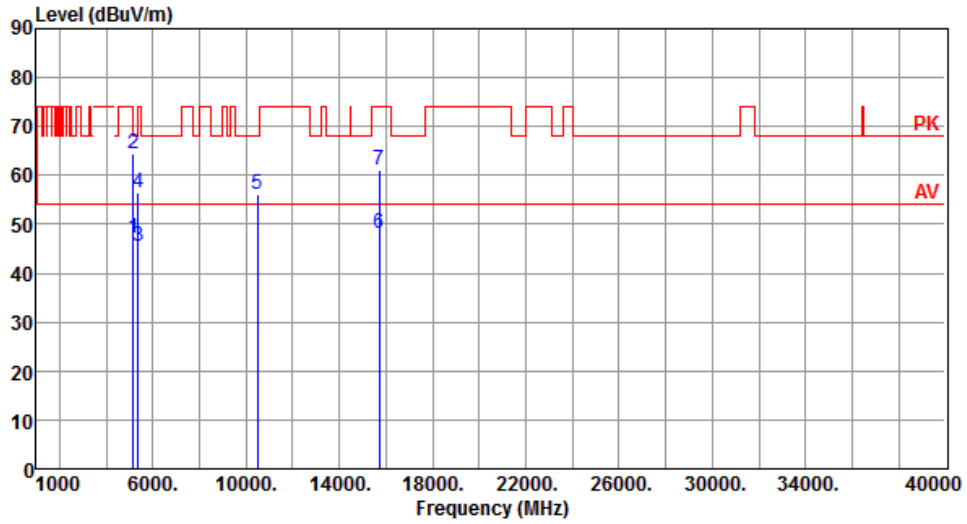

	Freq. MHz	Emission level dBuV/m	Limit dBuV/m	Margin dB	SA reading dBuV	Factor dB	Remark	ANT High cm	Turn Table deg
1	5150.00	47.24	54.00	-6.76	41.29	5.95	Average	195	263
2	5150.00	64.55	74.00	-9.45	58.60	5.95	Peak	195	263
3	5350.00	45.33	54.00	-8.67	39.93	5.40	Average	195	263
4	5350.00	56.52	74.00	-17.48	51.12	5.40	Peak	195	263
5	10480.00	56.02	68.20	-12.18	40.71	15.31	Peak	100	146
6	15720.00	48.32	54.00	-5.68	33.09	15.23	Average	100	192
7	15720.00	61.02	74.00	-12.98	45.79	15.23	Peak	100	192

Note 1: Emission Level (dBuV/m) = SA Reading (dBuV/m) + Factor* (dB)

*Factor includes antenna factor , cable loss and amplifier gain

Note 2: Margin (dB) = Emission level (dBuV/m) – Limit (dBuV/m).

Modulation	VHT20	Test Freq. (MHz)	5745
Polarization	Horizontal	Test Configuration	2

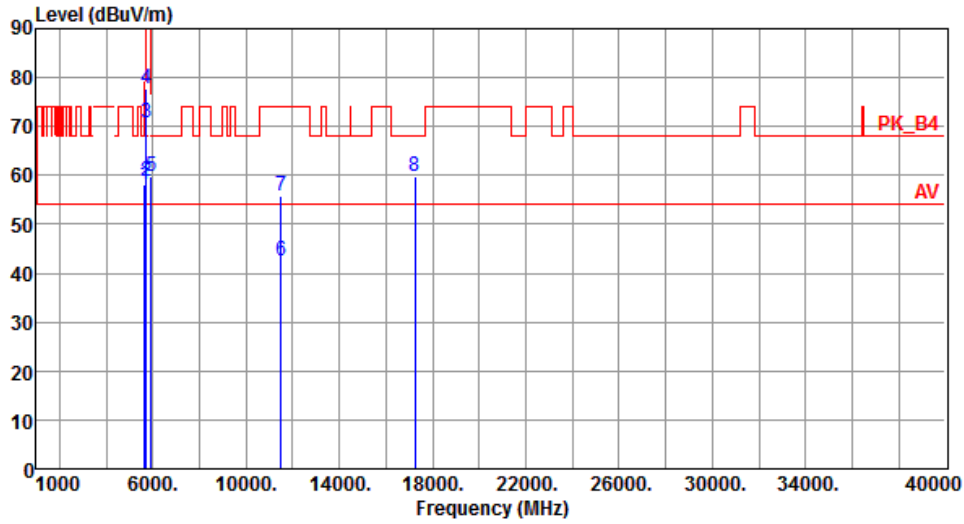

	Freq. MHz	Emission level dBuV/m	Limit dBuV/m	Margin dB	SA reading dBuV	Factor dB	Remark	ANT High cm	Turn Table deg
1	5650.00	57.97	68.20	-10.23	52.06	5.91	Peak	100	73
2	5700.00	58.70	105.20	-46.50	52.47	6.23	Peak	100	73
3	5720.00	70.80	110.80	-40.00	64.52	6.28	Peak	100	73
4	5725.00	77.83	122.20	-44.37	71.54	6.29	Peak	100	73
5	5925.00	59.93	68.20	-8.27	53.11	6.82	Peak	100	73
6	11490.00	42.60	54.00	-11.40	27.15	15.45	Average	100	69
7	11490.00	55.71	74.00	-18.29	40.26	15.45	Peak	100	69
8	17235.00	59.68	68.20	-8.52	42.70	16.98	Peak	100	57

Note 1: Emission Level (dBuV/m) = SA Reading (dBuV/m) + Factor* (dB)

*Factor includes antenna factor , cable loss and amplifier gain

Note 2: Margin (dB) = Emission level (dBuV/m) – Limit (dBuV/m).

Modulation	VHT20	Test Freq. (MHz)	5745
Polarization	Vertical	Test Configuration	2

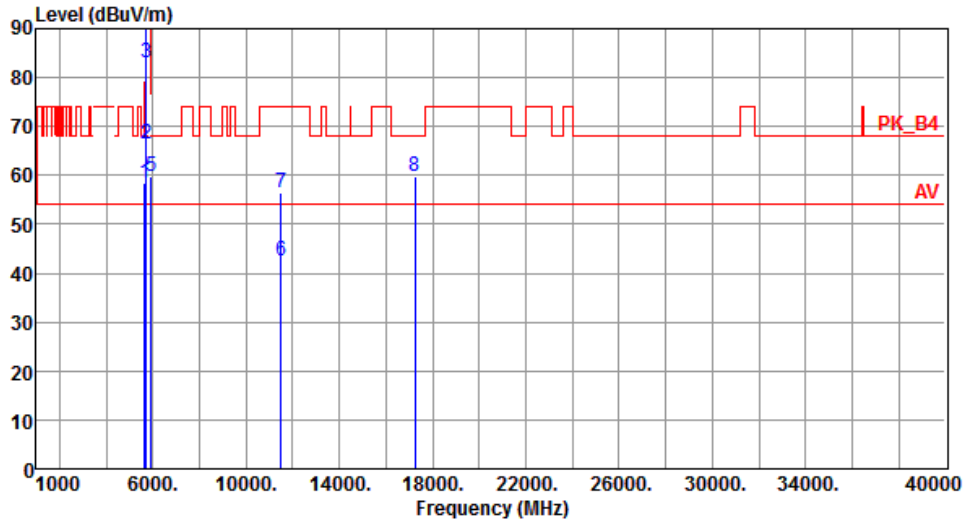

	Freq. MHz	Emission level dBuV/m	Limit dBuV/m	Margin dB	SA reading dBuV	Factor dB	Remark	ANT High cm	Turn Table deg
1	5650.00	58.53	68.20	-9.67	52.62	5.91	Peak	100	73
2	5700.00	66.52	105.20	-38.68	60.29	6.23	Peak	100	73
3	5720.00	82.98	110.80	-27.82	76.70	6.28	Peak	100	73
4	5725.00	90.37	122.20	-31.83	84.08	6.29	Peak	100	73
5	5925.00	59.67	68.20	-8.53	52.85	6.82	Peak	100	73
6	11490.00	42.54	54.00	-11.46	27.09	15.45	Average	100	34
7	11490.00	56.52	74.00	-17.48	41.07	15.45	Peak	100	34
8	17235.00	59.81	68.20	-8.39	42.83	16.98	Peak	100	71

Note 1: Emission Level (dBuV/m) = SA Reading (dBuV/m) + Factor* (dB)

*Factor includes antenna factor , cable loss and amplifier gain

Note 2: Margin (dB) = Emission level (dBuV/m) – Limit (dBuV/m).

Modulation	VHT20	Test Freq. (MHz)	5785
Polarization	Horizontal	Test Configuration	2

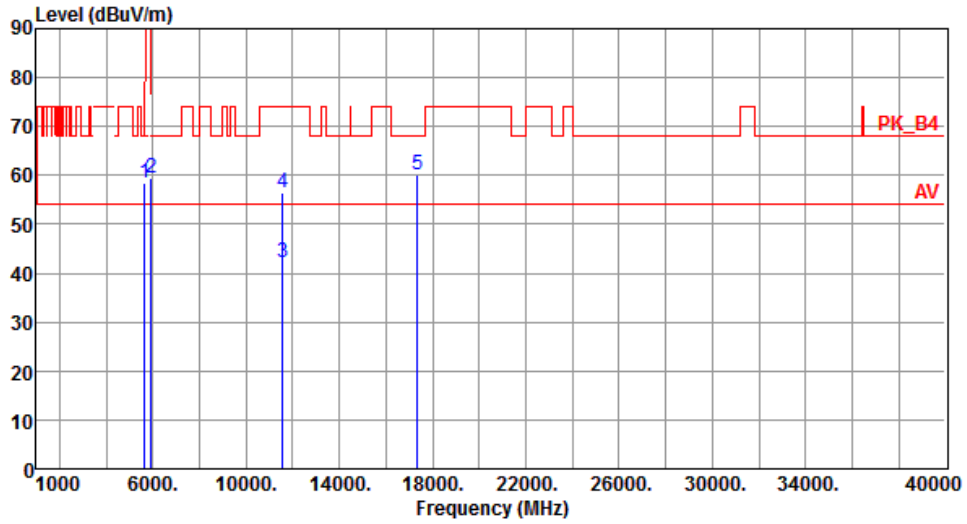

	Freq. MHz	Emission level dBuV/m	Limit dBuV/m	Margin dB	SA reading dBuV	Factor dB	Remark	ANT High cm	Turn Table deg
1	5650.00	58.54	68.20	-9.66	52.63	5.91	Peak	100	39
2	5925.00	59.56	68.20	-8.64	52.74	6.82	Peak	100	39
3	11570.00	42.34	54.00	-11.66	27.04	15.30	Average	100	68
4	11570.00	56.32	74.00	-17.68	41.02	15.30	Peak	100	68
5	17355.00	60.26	68.20	-7.94	42.65	17.61	Peak	100	59

Note 1: Emission Level (dBuV/m) = SA Reading (dBuV/m) + Factor* (dB)

*Factor includes antenna factor , cable loss and amplifier gain

Note 2: Margin (dB) = Emission level (dBuV/m) – Limit (dBuV/m).

Modulation	VHT20	Test Freq. (MHz)	5785
Polarization	Vertical	Test Configuration	2

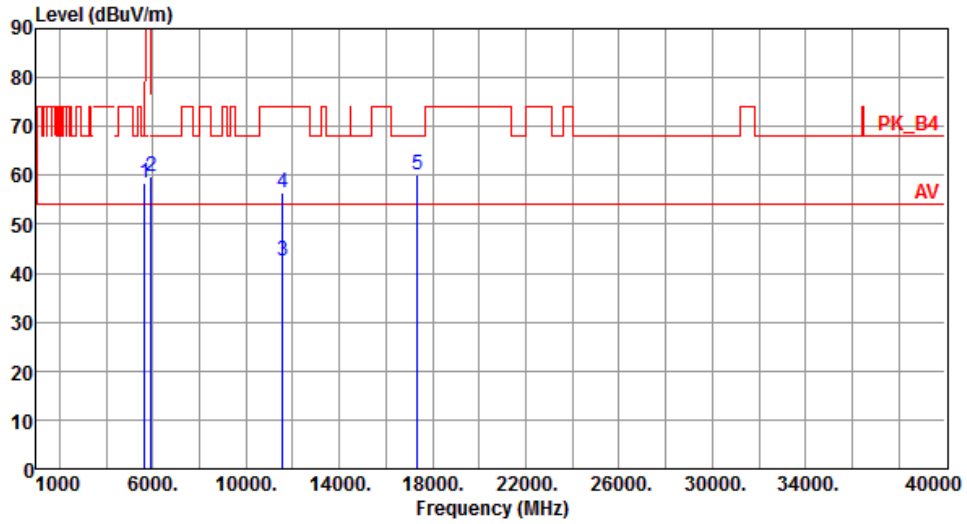

	Freq. MHz	Emission level dBuV/m	Limit dBuV/m	Margin dB	SA reading dBuV	Factor dB	Remark	ANT High cm	Turn Table deg
1	5650.00	58.44	68.20	-9.76	52.53	5.91	Peak	100	68
2	5925.00	59.71	68.20	-8.49	52.89	6.82	Peak	100	68
3	11570.00	42.52	54.00	-11.48	27.22	15.30	Average	100	38
4	11570.00	56.31	74.00	-17.69	41.01	15.30	Peak	100	38
5	17355.00	60.20	68.20	-8.00	42.59	17.61	Peak	100	76

Note 1: Emission Level (dBuV/m) = SA Reading (dBuV/m) + Factor* (dB)

*Factor includes antenna factor , cable loss and amplifier gain

Note 2: Margin (dB) = Emission level (dBuV/m) – Limit (dBuV/m).

Modulation	VHT20	Test Freq. (MHz)	5825
Polarization	Horizontal	Test Configuration	2

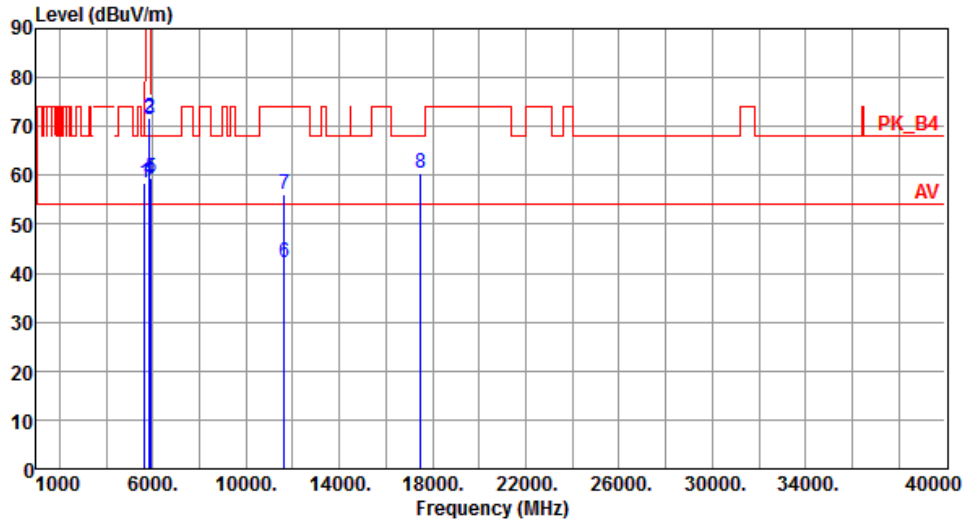

	Freq. MHz	Emission level dBuV/m	Limit dBuV/m	Margin dB	SA reading dBuV	Factor dB	Remark	ANT High cm	Turn Table deg
1	5650.00	58.52	68.20	-9.68	52.61	5.91	Peak	100	47
2	5850.00	71.70	122.20	-50.50	65.03	6.67	Peak	100	47
3	5855.00	71.40	110.80	-39.40	64.72	6.68	Peak	100	47
4	5875.00	59.13	105.20	-46.07	52.41	6.72	Peak	100	47
5	5925.00	59.50	68.20	-8.70	52.68	6.82	Peak	100	47
6	11650.00	42.05	54.00	-11.95	26.99	15.06	Average	100	67
7	11650.00	56.19	74.00	-17.81	41.13	15.06	Peak	100	67
8	17475.00	60.59	68.20	-7.61	42.36	18.23	Peak	100	54

Note 1: Emission Level (dBuV/m) = SA Reading (dBuV/m) + Factor* (dB)

*Factor includes antenna factor , cable loss and amplifier gain

Note 2: Margin (dB) = Emission level (dBuV/m) – Limit (dBuV/m).

Modulation	VHT20	Test Freq. (MHz)	5825
Polarization	Vertical	Test Configuration	2

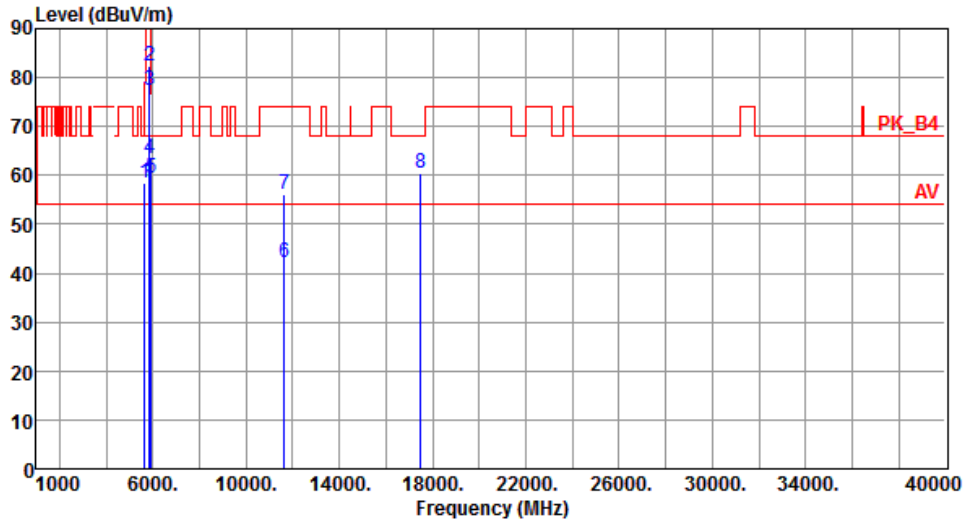

	Freq. MHz	Emission level dBuV/m	Limit dBuV/m	Margin dB	SA reading dBuV	Factor dB	Remark	ANT High cm	Turn Table deg
1	5650.00	58.51	68.20	-9.69	52.60	5.91	Peak	100	70
2	5850.00	82.47	122.20	-39.73	75.80	6.67	Peak	100	70
3	5855.00	77.33	110.80	-33.47	70.65	6.68	Peak	100	70
4	5875.00	63.46	105.20	-41.74	56.74	6.72	Peak	100	70
5	5925.00	59.47	68.20	-8.73	52.65	6.82	Peak	100	70
6	11650.00	42.11	54.00	-11.89	27.05	15.06	Average	100	37
7	11650.00	56.10	74.00	-17.90	41.04	15.06	Peak	100	37
8	17475.00	60.43	68.20	-7.77	42.20	18.23	Peak	100	71

Note 1: Emission Level (dBuV/m) = SA Reading (dBuV/m) + Factor* (dB)

*Factor includes antenna factor , cable loss and amplifier gain

Note 2: Margin (dB) = Emission level (dBuV/m) – Limit (dBuV/m).

3.5.7 Transmitter Radiated Unwanted Emissions (Above 1GHz) for VHT40

Modulation	VHT40	Test Freq. (MHz)	5190
Polarization	Horizontal	Test Configuration	2

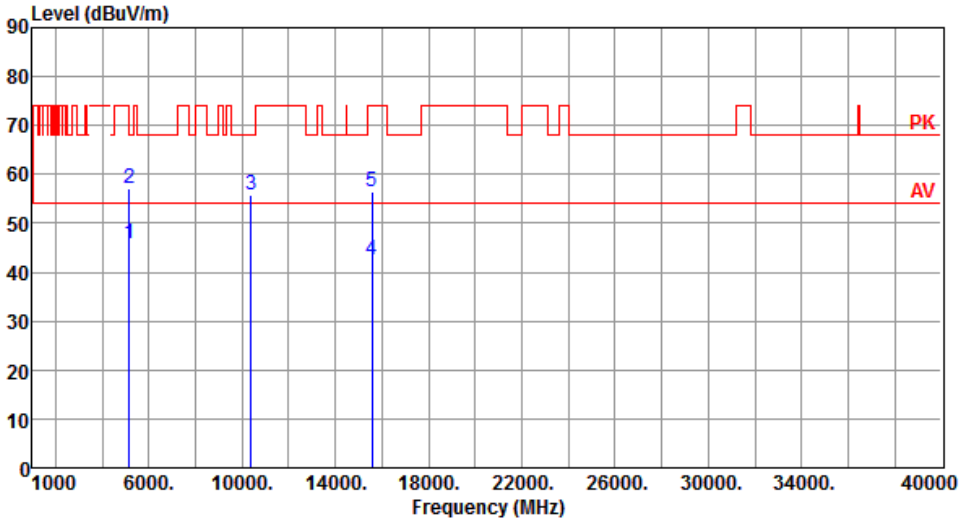

	Freq. MHz	Emission level dBuV/m	Limit dBuV/m	Margin dB	SA reading dBuV	Factor dB	Remark	ANT High cm	Turn Table deg
1	5150.00	45.99	54.00	-8.01	40.04	5.95	Average	273	225
2	5150.00	57.11	74.00	-16.89	51.16	5.95	Peak	273	225
3	10380.00	55.73	68.20	-12.47	40.51	15.22	Peak	100	258
4	15570.00	42.66	54.00	-11.34	27.09	15.57	Average	100	256
5	15570.00	56.33	74.00	-17.67	40.76	15.57	Peak	100	256

Note 1: Emission Level (dBuV/m) = SA Reading (dBuV/m) + Factor* (dB)
*Factor includes antenna factor , cable loss and amplifier gain
Note 2: Margin (dB) = Emission level (dBuV/m) – Limit (dBuV/m).

Modulation	VHT40	Test Freq. (MHz)	5190
Polarization	Vertical	Test Configuration	2

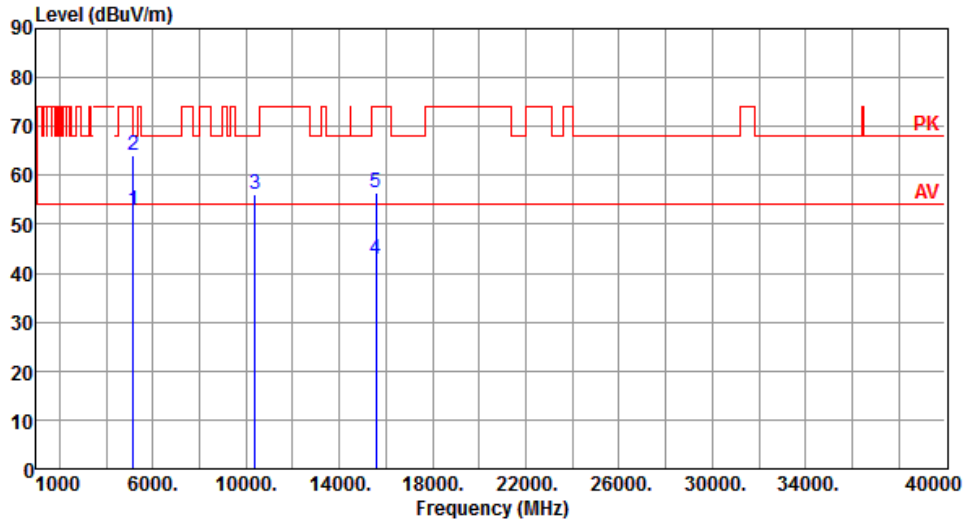

	Freq. MHz	Emission level dBuV/m	Limit dBuV/m	Margin dB	SA reading dBuV	Factor dB	Remark	ANT High cm	Turn Table deg
1	5150.00	52.74	54.00	-1.26	46.79	5.95	Average	180	268
2	5150.00	64.10	74.00	-9.90	58.15	5.95	Peak	180	268
3	10380.00	56.12	68.20	-12.08	40.90	15.22	Peak	100	148
4	15570.00	42.68	54.00	-11.32	27.11	15.57	Average	100	158
5	15570.00	56.55	74.00	-17.45	40.98	15.57	Peak	100	158

Note 1: Emission Level (dBuV/m) = SA Reading (dBuV/m) + Factor* (dB)

*Factor includes antenna factor , cable loss and amplifier gain

Note 2: Margin (dB) = Emission level (dBuV/m) – Limit (dBuV/m).

Modulation	VHT40	Test Freq. (MHz)	5230
Polarization	Horizontal	Test Configuration	2

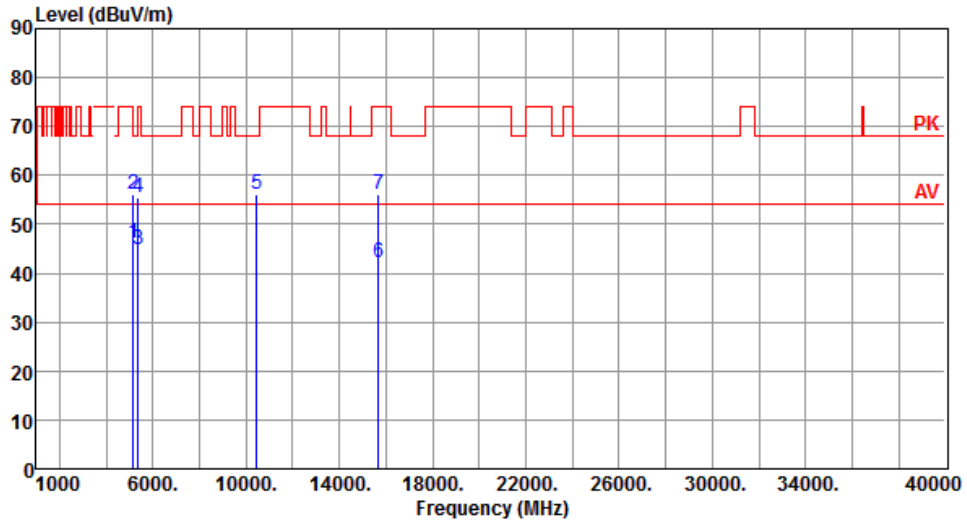

	Freq. MHz	Emission level dBuV/m	Limit dBuV/m	Margin dB	SA reading dBuV	Factor dB	Remark	ANT High cm	Turn Table deg
1	5150.00	46.09	54.00	-7.91	40.14	5.95	Average	252	259
2	5150.00	56.12	74.00	-17.88	50.17	5.95	Peak	252	259
3	5350.00	44.92	54.00	-9.08	39.52	5.40	Average	252	259
4	5350.00	55.40	74.00	-18.60	50.00	5.40	Peak	252	259
5	10460.00	56.14	68.20	-12.06	40.82	15.32	Peak	100	244
6	15690.00	42.10	54.00	-11.90	26.75	15.35	Average	100	251
7	15690.00	56.07	74.00	-17.93	40.72	15.35	Peak	100	251

Note 1: Emission Level (dBuV/m) = SA Reading (dBuV/m) + Factor* (dB)

*Factor includes antenna factor , cable loss and amplifier gain

Note 2: Margin (dB) = Emission level (dBuV/m) – Limit (dBuV/m).

Modulation	VHT40	Test Freq. (MHz)	5230
Polarization	Vertical	Test Configuration	2

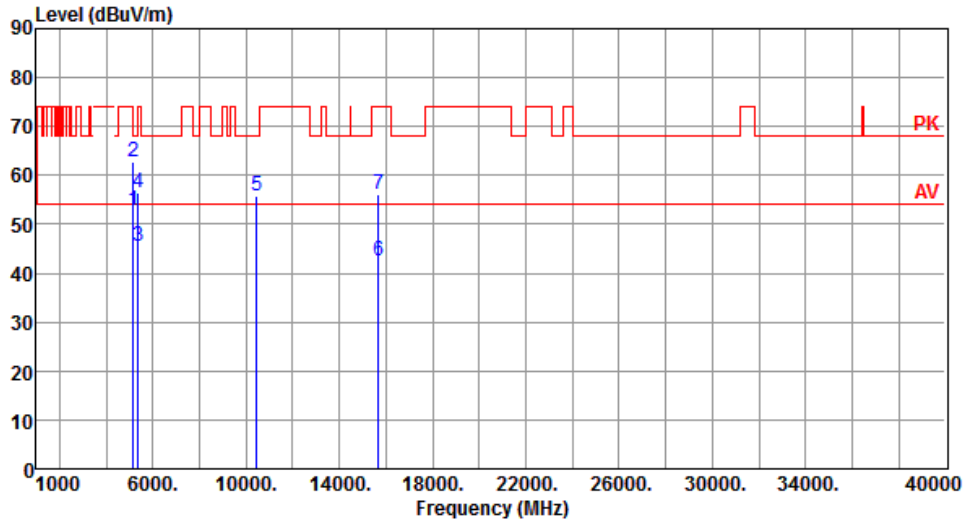

	Freq. MHz	Emission level dBuV/m	Limit dBuV/m	Margin dB	SA reading dBuV	Factor dB	Remark	ANT High cm	Turn Table deg
1	5150.00	52.70	54.00	-1.30	46.75	5.95	Average	196	260
2	5150.00	62.62	74.00	-11.38	56.67	5.95	Peak	196	260
3	5350.00	45.56	54.00	-8.44	40.16	5.40	Average	196	260
4	5350.00	56.59	74.00	-17.41	51.19	5.40	Peak	196	260
5	10460.00	55.77	68.20	-12.43	40.45	15.32	Peak	100	147
6	15690.00	42.47	54.00	-11.53	27.12	15.35	Average	100	151
7	15690.00	56.18	74.00	-17.82	40.83	15.35	Peak	100	151

Note 1: Emission Level (dBuV/m) = SA Reading (dBuV/m) + Factor* (dB)

*Factor includes antenna factor , cable loss and amplifier gain

Note 2: Margin (dB) = Emission level (dBuV/m) – Limit (dBuV/m).

Modulation	VHT40	Test Freq. (MHz)	5755
Polarization	Horizontal	Test Configuration	2

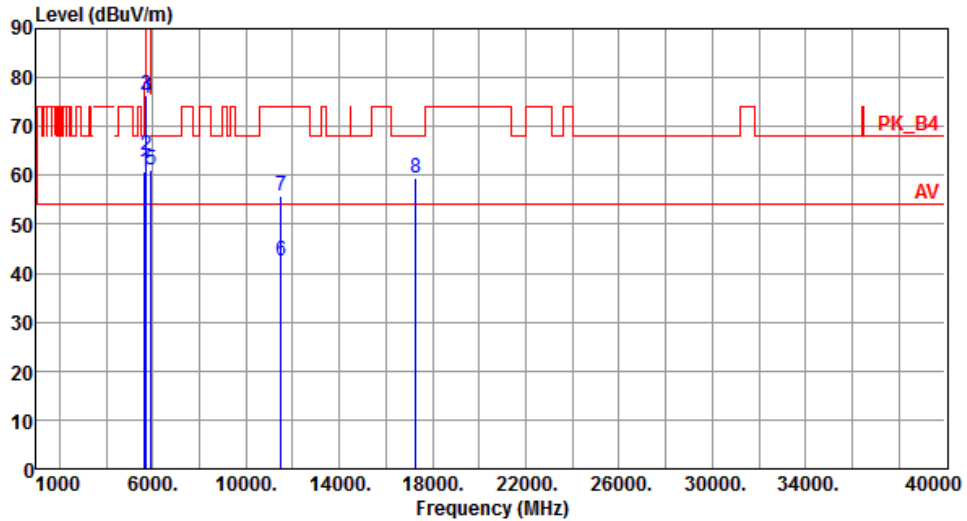

	Freq. MHz	Emission level dBuV/m	Limit dBuV/m	Margin dB	SA reading dBuV	Factor dB	Remark	ANT High cm	Turn Table deg
1	5650.00	60.82	68.20	-7.38	54.91	5.91	Peak	100	42
2	5700.00	64.12	105.20	-41.08	57.89	6.23	Peak	100	42
3	5720.00	76.33	110.80	-34.47	70.05	6.28	Peak	100	42
4	5725.00	75.83	122.20	-46.37	69.54	6.29	Peak	100	42
5	5925.00	60.96	68.20	-7.24	54.14	6.82	Peak	100	42
6	11510.00	42.59	54.00	-11.41	27.14	15.45	Average	100	63
7	11510.00	55.68	74.00	-18.32	40.23	15.45	Peak	100	63
8	17265.00	59.44	68.20	-8.76	42.33	17.11	Peak	100	56

Note 1: Emission Level (dBuV/m) = SA Reading (dBuV/m) + Factor* (dB)

*Factor includes antenna factor , cable loss and amplifier gain

Note 2: Margin (dB) = Emission level (dBuV/m) – Limit (dBuV/m).

Modulation	VHT40	Test Freq. (MHz)	5755
Polarization	Vertical	Test Configuration	2

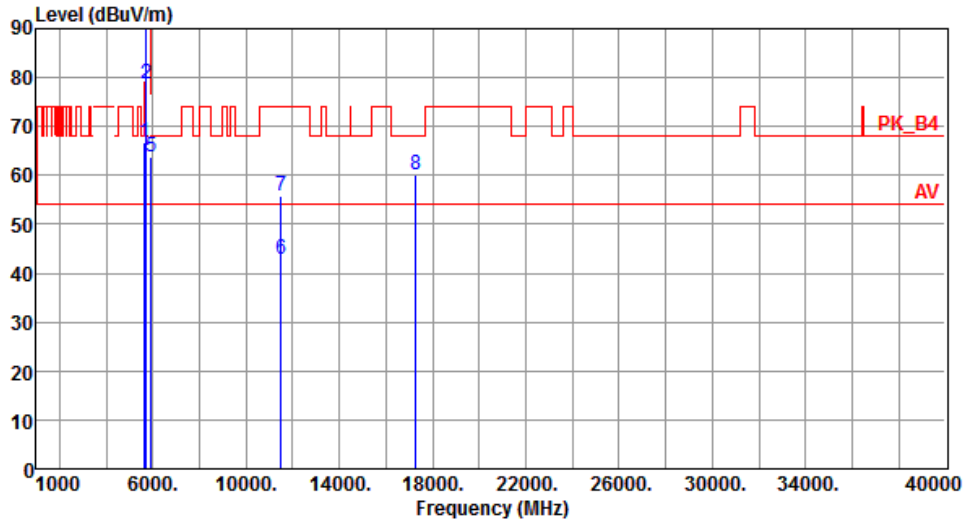

	Freq. MHz	Emission level dBuV/m	Limit dBuV/m	Margin dB	SA reading dBuV	Factor dB	Remark	ANT High cm	Turn Table deg
1	5650.00	66.82	68.20	-1.38	60.91	5.91	Peak	100	73
2	5700.00	78.73	105.20	-26.47	72.50	6.23	Peak	100	73
3	5720.00	91.55	110.80	-19.25	85.27	6.28	Peak	100	73
4	5725.00	93.47	122.20	-28.73	87.18	6.29	Peak	100	73
5	5925.00	63.91	68.20	-4.29	57.09	6.82	Peak	100	73
6	11510.00	42.71	54.00	-11.29	27.26	15.45	Average	100	37
7	11510.00	55.69	74.00	-18.31	40.24	15.45	Peak	100	37
8	17265.00	59.99	68.20	-8.21	42.88	17.11	Peak	100	72

Note 1: Emission Level (dBuV/m) = SA Reading (dBuV/m) + Factor* (dB)

*Factor includes antenna factor , cable loss and amplifier gain

Note 2: Margin (dB) = Emission level (dBuV/m) – Limit (dBuV/m).

Modulation	VHT40	Test Freq. (MHz)	5795
Polarization	Horizontal	Test Configuration	2

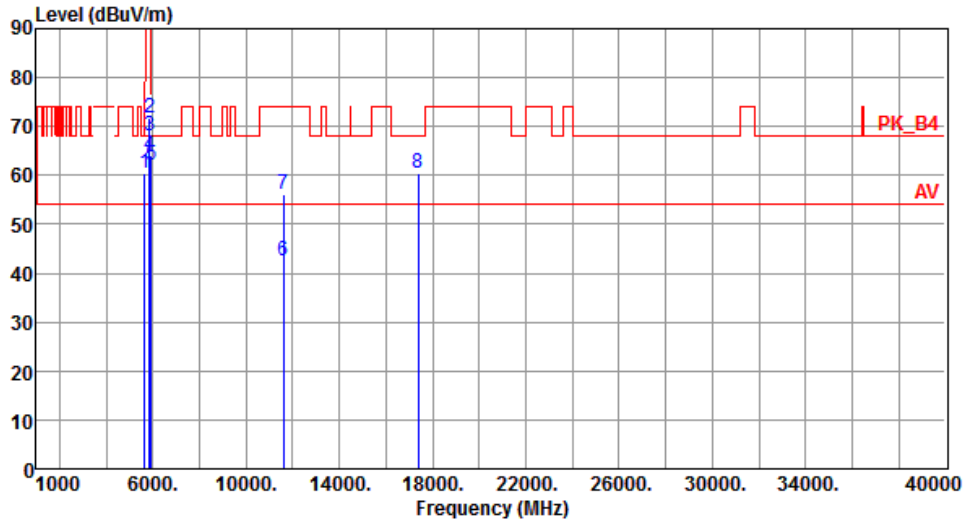

	Freq. MHz	Emission level dBuV/m	Limit dBuV/m	Margin dB	SA reading dBuV	Factor dB	Remark	ANT High cm	Turn Table deg
1	5650.00	60.56	68.20	-7.64	54.65	5.91	Peak	100	42
2	5850.00	71.67	122.20	-50.53	65.00	6.67	Peak	100	42
3	5855.00	67.92	110.80	-42.88	61.24	6.68	Peak	100	42
4	5875.00	64.08	105.20	-41.12	57.36	6.72	Peak	100	42
5	5925.00	61.95	68.20	-6.25	55.13	6.82	Peak	100	42
6	11590.00	42.36	54.00	-11.64	27.10	15.26	Average	100	64
7	11590.00	56.28	74.00	-17.72	41.02	15.26	Peak	100	64
8	17385.00	60.49	68.20	-7.71	42.68	17.81	Peak	100	52

Note 1: Emission Level (dBuV/m) = SA Reading (dBuV/m) + Factor* (dB)

*Factor includes antenna factor , cable loss and amplifier gain

Note 2: Margin (dB) = Emission level (dBuV/m) – Limit (dBuV/m).

Modulation	VHT40	Test Freq. (MHz)	5795
Polarization	Vertical	Test Configuration	2

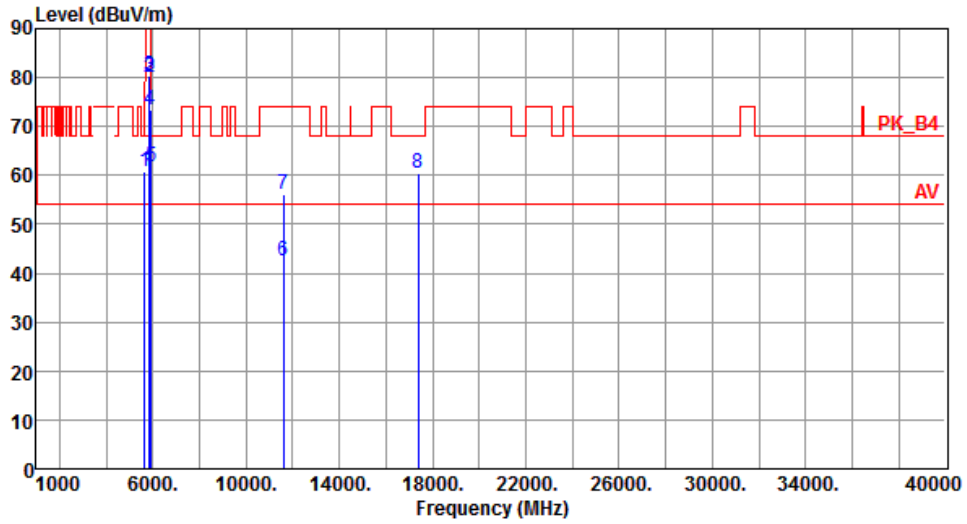

	Freq. MHz	Emission level dBuV/m	Limit dBuV/m	Margin dB	SA reading dBuV	Factor dB	Remark	ANT High cm	Turn Table deg
1	5650.00	60.86	68.20	-7.34	54.95	5.91	Peak	107	71
2	5850.00	80.05	122.20	-42.15	73.38	6.67	Peak	107	71
3	5855.00	80.22	110.80	-30.58	73.54	6.68	Peak	107	71
4	5875.00	73.54	105.20	-31.66	66.82	6.72	Peak	107	71
5	5925.00	61.70	68.20	-6.50	54.88	6.82	Peak	107	71
6	11590.00	42.48	54.00	-11.52	27.22	15.26	Average	100	37
7	11590.00	56.28	74.00	-17.72	41.02	15.26	Peak	100	37
8	17385.00	60.35	68.20	-7.85	42.54	17.81	Peak	100	74

Note 1: Emission Level (dBuV/m) = SA Reading (dBuV/m) + Factor* (dB)

*Factor includes antenna factor , cable loss and amplifier gain

Note 2: Margin (dB) = Emission level (dBuV/m) – Limit (dBuV/m).

3.5.8 Transmitter Radiated Unwanted Emissions (Above 1GHz) for VHT80

Modulation	VHT80	Test Freq. (MHz)	5210
Polarization	Horizontal	Test Configuration	2

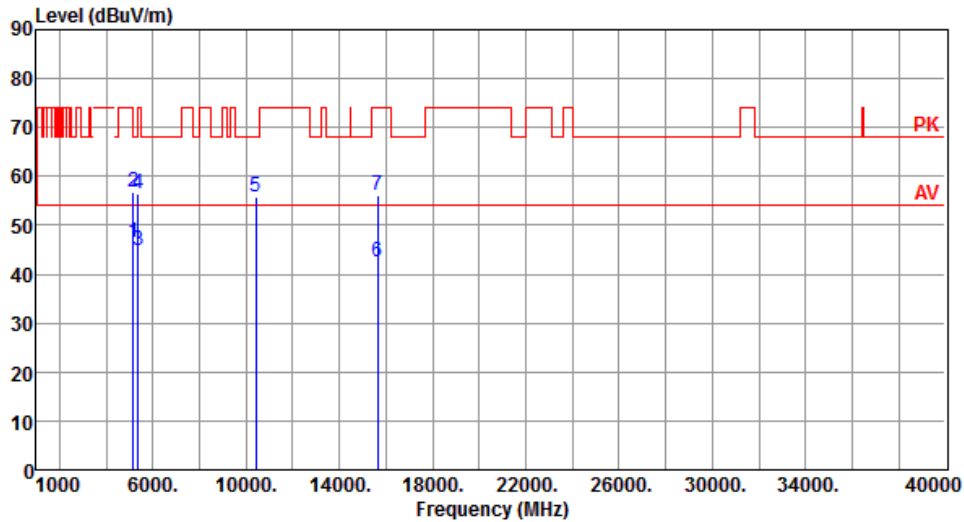

	Freq. MHz	Emission level dBuV/m	Limit dBuV/m	Margin dB	SA reading dBuV	Factor dB	Remark	ANT High cm	Turn Table deg
1	5150.00	46.42	54.00	-7.58	40.47	5.95	Average	276	227
2	5150.00	56.76	74.00	-17.24	50.81	5.95	Peak	276	227
3	5350.00	44.69	54.00	-9.31	39.29	5.40	Average	276	227
4	5350.00	56.56	74.00	-17.44	51.16	5.40	Peak	276	227
5	10420.00	55.77	68.20	-12.43	40.45	15.32	Peak	100	241
6	15630.00	42.46	54.00	-11.54	27.02	15.44	Average	100	252
7	15630.00	56.15	74.00	-17.85	40.71	15.44	Peak	100	252

Note 1: Emission Level (dBuV/m) = SA Reading (dBuV/m) + Factor* (dB)

*Factor includes antenna factor , cable loss and amplifier gain

Note 2: Margin (dB) = Emission level (dBuV/m) – Limit (dBuV/m).

Modulation	VHT80	Test Freq. (MHz)	5210
Polarization	Vertical	Test Configuration	2

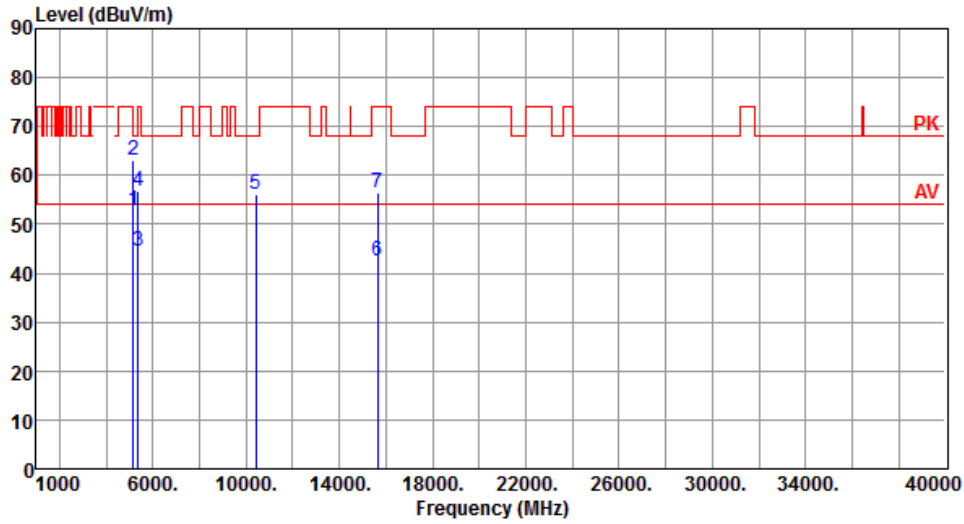

	Freq. MHz	Emission level dBuV/m	Limit dBuV/m	Margin dB	SA reading dBuV	Factor dB	Remark	ANT High cm	Turn Table deg
1	5150.00	52.74	54.00	-1.26	46.79	5.95	Average	203	260
2	5150.00	63.25	74.00	-10.75	57.30	5.95	Peak	203	260
3	5350.00	44.56	54.00	-9.44	39.16	5.40	Average	203	260
4	5350.00	56.81	74.00	-17.19	51.41	5.40	Peak	203	260
5	10420.00	56.06	68.20	-12.14	40.74	15.32	Peak	100	141
6	15630.00	42.46	54.00	-11.54	27.02	15.44	Average	100	155
7	15630.00	56.37	74.00	-17.63	40.93	15.44	Peak	100	155

Note 1: Emission Level (dBuV/m) = SA Reading (dBuV/m) + Factor* (dB)

*Factor includes antenna factor , cable loss and amplifier gain

Note 2: Margin (dB) = Emission level (dBuV/m) – Limit (dBuV/m).

Modulation	VHT80	Test Freq. (MHz)	5775
Polarization	Horizontal	Test Configuration	2

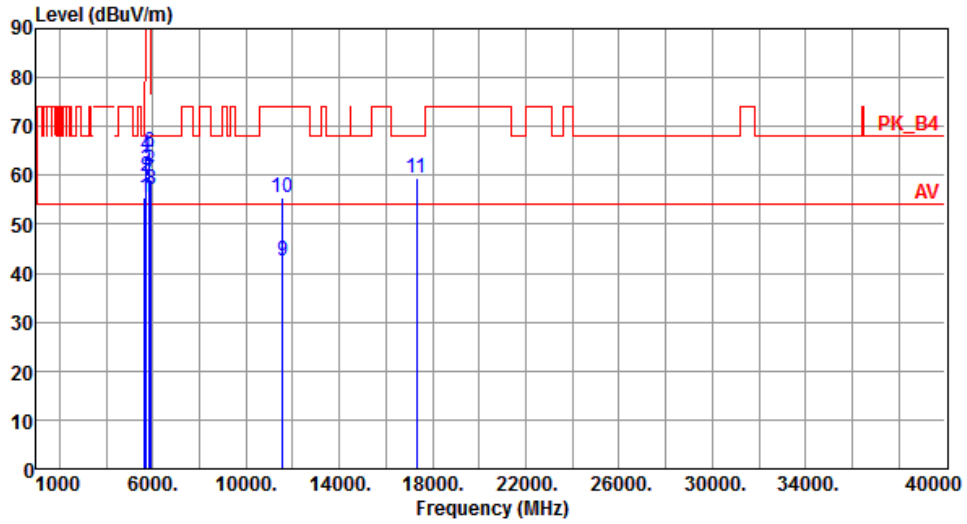

	Freq. MHz	Emission level dBuV/m	Limit dBuV/m	Margin dB	SA reading dBuV	Factor dB	Remark	ANT High cm	Turn Table deg
1	5650.00	55.42	68.20	-12.78	49.51	5.91	Peak	100	39
2	5700.00	59.74	105.20	-45.46	53.51	6.23	Peak	100	39
3	5720.00	60.97	110.80	-49.83	54.69	6.28	Peak	100	39
4	5720.00	64.18	110.80	-46.62	57.90	6.28	Peak	100	39
5	5850.00	62.06	122.20	-60.14	55.39	6.67	Peak	100	39
6	5855.00	64.74	110.80	-46.06	58.06	6.68	Peak	100	39
7	5875.00	59.00	105.20	-46.20	52.28	6.72	Peak	100	39
8	5925.00	57.03	68.20	-11.17	50.21	6.82	Peak	100	39
9	11550.00	42.67	54.00	-11.33	27.32	15.35	Average	100	66
10	11550.00	55.47	74.00	-18.53	40.12	15.35	Peak	100	66
11	17325.00	59.60	68.20	-8.60	42.18	17.42	Peak	100	50

Note 1: Emission Level (dBuV/m) = SA Reading (dBuV/m) + Factor* (dB)

*Factor includes antenna factor , cable loss and amplifier gain

Note 2: Margin (dB) = Emission level (dBuV/m) – Limit (dBuV/m).

Modulation	VHT80	Test Freq. (MHz)	5775
Polarization	Vertical	Test Configuration	2

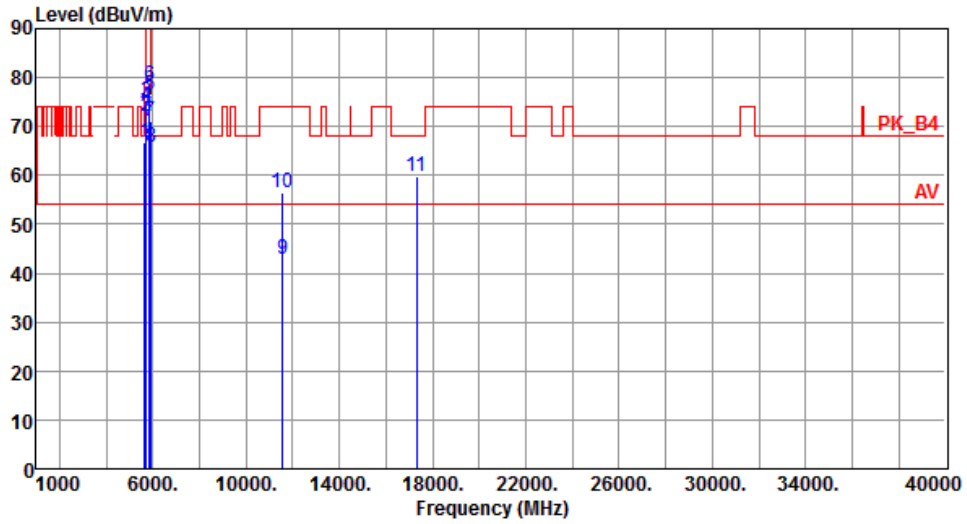

	Freq. MHz	Emission level dBuV/m	Limit dBuV/m	Margin dB	SA reading dBuV	Factor dB	Remark	ANT High cm	Turn Table deg
1	5650.00	66.85	68.20	-1.35	60.94	5.91	Peak	100	71
2	5700.00	71.95	105.20	-33.25	65.72	6.23	Peak	100	71
3	5720.00	75.10	110.80	-35.70	68.82	6.28	Peak	100	71
4	5725.00	74.09	122.20	-48.11	67.80	6.29	Peak	100	71
5	5850.00	76.41	122.20	-45.79	69.74	6.67	Peak	100	71
6	5855.00	78.37	110.80	-32.43	71.69	6.68	Peak	100	71
7	5875.00	71.10	105.20	-34.10	64.38	6.72	Peak	100	71
8	5925.00	65.90	68.20	-2.30	59.08	6.82	Peak	100	71
9	11550.00	42.69	54.00	-11.31	27.34	15.35	Average	100	35
10	11550.00	56.34	74.00	-17.66	40.99	15.35	Peak	100	35
11	17325.00	59.88	68.20	-8.32	42.46	17.42	Peak	100	69

Note 1: Emission Level (dBuV/m) = SA Reading (dBuV/m) + Factor* (dB)

*Factor includes antenna factor , cable loss and amplifier gain

Note 2: Margin (dB) = Emission level (dBuV/m) – Limit (dBuV/m).

Beamforming mode

3.5.9 Transmitter Radiated Unwanted Emissions (Below 1GHz)

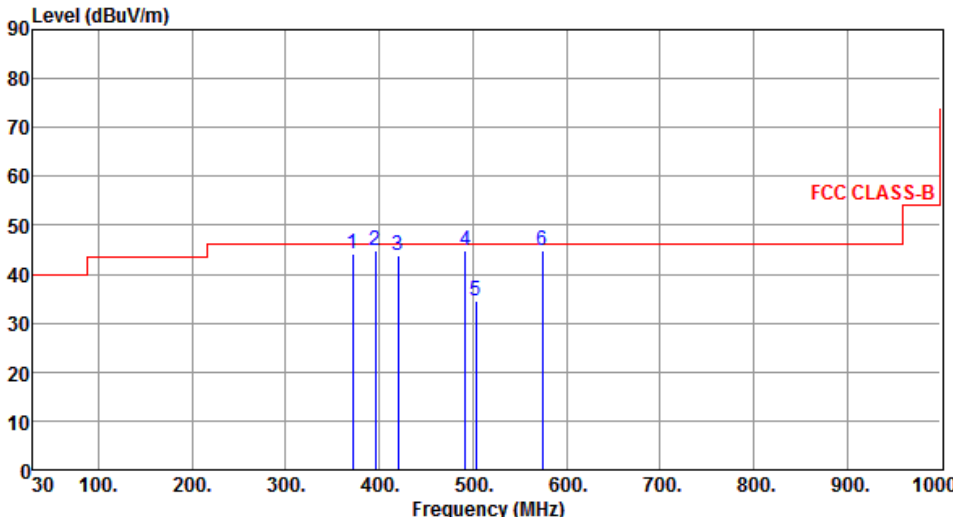
Modulation	VHT20	Test Freq. (MHz)	5200																																																																						
Polarization	Horizontal	Test Configuration	1																																																																						
 <p>The graph plots Level (dBuV/m) on the y-axis (0 to 90) against Frequency (MHz) on the x-axis (30 to 1000). A red step function represents the FCC CLASS-B limit, which is 40 dBuV/m from 30 to 100 MHz, 45 dBuV/m from 100 to 200 MHz, 46 dBuV/m from 200 to 1000 MHz, and 55 dBuV/m from 1000 MHz to 1000 MHz. Six blue vertical lines represent emission levels at specific frequencies: 1 (371.78 MHz), 2 (396.30 MHz), 3 (419.79 MHz), 4 (491.89 MHz), 5 (503.52 MHz), and 6 (574.77 MHz). The emission levels are 44.31, 44.88, 43.95, 44.75, 34.62, and 44.68 dBuV/m respectively. The SA readings are 50.03, 49.90, 48.36, 47.69, 37.35, and 45.74 dBuV. The factors are -5.72, -5.02, -4.41, -2.94, -2.73, and -1.06 dB. The margins are -1.69, -1.12, -2.05, -1.25, -11.38, and -1.32 dB.</p>																																																																									
	<table border="1"> <thead> <tr> <th></th> <th>Freq. MHz</th> <th>Emission level dBuV/m</th> <th>Limit dBuV/m</th> <th>Margin dB</th> <th>SA reading dBuV</th> <th>Factor dB</th> <th>Remark</th> <th>ANT High cm</th> <th>Turn Table deg</th> </tr> </thead> <tbody> <tr> <td>1</td> <td>371.78</td> <td>44.31</td> <td>46.00</td> <td>-1.69</td> <td>50.03</td> <td>-5.72</td> <td>QP</td> <td>100</td> <td>116</td> </tr> <tr> <td>2</td> <td>396.30</td> <td>44.88</td> <td>46.00</td> <td>-1.12</td> <td>49.90</td> <td>-5.02</td> <td>QP</td> <td>100</td> <td>129</td> </tr> <tr> <td>3</td> <td>419.79</td> <td>43.95</td> <td>46.00</td> <td>-2.05</td> <td>48.36</td> <td>-4.41</td> <td>QP</td> <td>100</td> <td>126</td> </tr> <tr> <td>4</td> <td>491.89</td> <td>44.75</td> <td>46.00</td> <td>-1.25</td> <td>47.69</td> <td>-2.94</td> <td>QP</td> <td>169</td> <td>129</td> </tr> <tr> <td>5</td> <td>503.52</td> <td>34.62</td> <td>46.00</td> <td>-11.38</td> <td>37.35</td> <td>-2.73</td> <td>QP</td> <td>182</td> <td>65</td> </tr> <tr> <td>6</td> <td>574.77</td> <td>44.68</td> <td>46.00</td> <td>-1.32</td> <td>45.74</td> <td>-1.06</td> <td>QP</td> <td>135</td> <td>139</td> </tr> </tbody> </table>		Freq. MHz	Emission level dBuV/m	Limit dBuV/m	Margin dB	SA reading dBuV	Factor dB	Remark	ANT High cm	Turn Table deg	1	371.78	44.31	46.00	-1.69	50.03	-5.72	QP	100	116	2	396.30	44.88	46.00	-1.12	49.90	-5.02	QP	100	129	3	419.79	43.95	46.00	-2.05	48.36	-4.41	QP	100	126	4	491.89	44.75	46.00	-1.25	47.69	-2.94	QP	169	129	5	503.52	34.62	46.00	-11.38	37.35	-2.73	QP	182	65	6	574.77	44.68	46.00	-1.32	45.74	-1.06	QP	135	139		
	Freq. MHz	Emission level dBuV/m	Limit dBuV/m	Margin dB	SA reading dBuV	Factor dB	Remark	ANT High cm	Turn Table deg																																																																
1	371.78	44.31	46.00	-1.69	50.03	-5.72	QP	100	116																																																																
2	396.30	44.88	46.00	-1.12	49.90	-5.02	QP	100	129																																																																
3	419.79	43.95	46.00	-2.05	48.36	-4.41	QP	100	126																																																																
4	491.89	44.75	46.00	-1.25	47.69	-2.94	QP	169	129																																																																
5	503.52	34.62	46.00	-11.38	37.35	-2.73	QP	182	65																																																																
6	574.77	44.68	46.00	-1.32	45.74	-1.06	QP	135	139																																																																
<p>Note 1: Emission Level (dBuV/m) = SA Reading (dBuV/m) + Factor* (dB) *Factor includes antenna factor , cable loss and amplifier gain Note 2: Margin (dB) = Emission level (dBuV/m) – Limit (dBuV/m). Note 3: All spurious emissions below 30MHz are more than 20 dB below the limit.</p>																																																																									

Modulation	VHT20	Test Freq. (MHz)	5200
Polarization	Vertical	Test Configuration	1

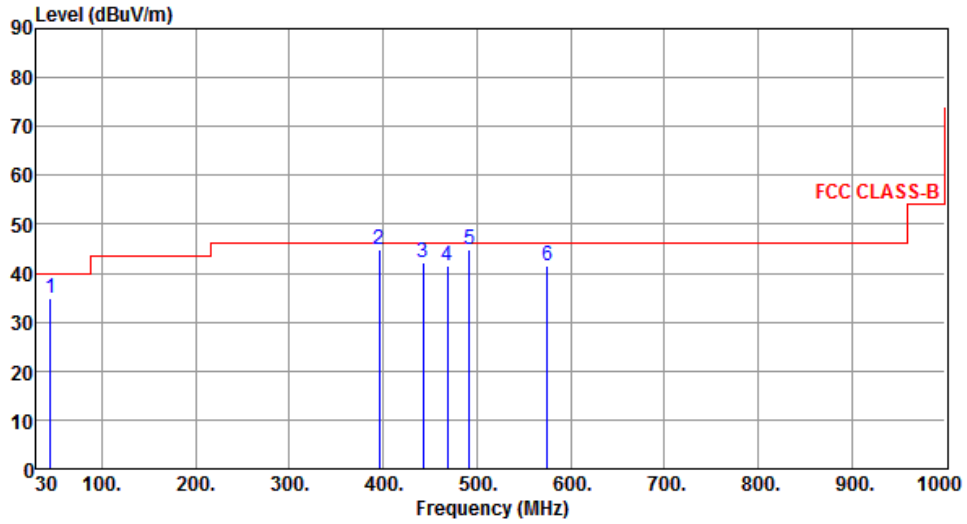

	Freq. MHz	Emission level dBuV/m	Limit dBuV/m	Margin dB	SA reading dBuV	Factor dB	Remark	ANT High cm	Turn Table deg
1	45.33	34.95	40.00	-5.05	43.05	-8.10	QP	100	119
2	396.21	44.91	46.00	-1.09	49.93	-5.02	QP	105	181
3	442.85	42.23	46.00	-3.77	46.05	-3.82	Peak	---	---
4	468.33	41.62	46.00	-4.38	44.94	-3.32	QP	100	125
5	491.79	44.80	46.00	-1.20	47.74	-2.94	QP	100	128
6	575.12	41.62	46.00	-4.38	42.67	-1.05	Peak	---	---

Note 1: Emission Level (dBuV/m) = SA Reading (dBuV/m) + Factor* (dB)

*Factor includes antenna factor , cable loss and amplifier gain

Note 2: Margin (dB) = Emission level (dBuV/m) – Limit (dBuV/m).

Note 3: All spurious emissions below 30MHz are more than 20 dB below the limit.

Modulation	VHT40	Test Freq. (MHz)	5755
Polarization	Horizontal	Test Configuration	1

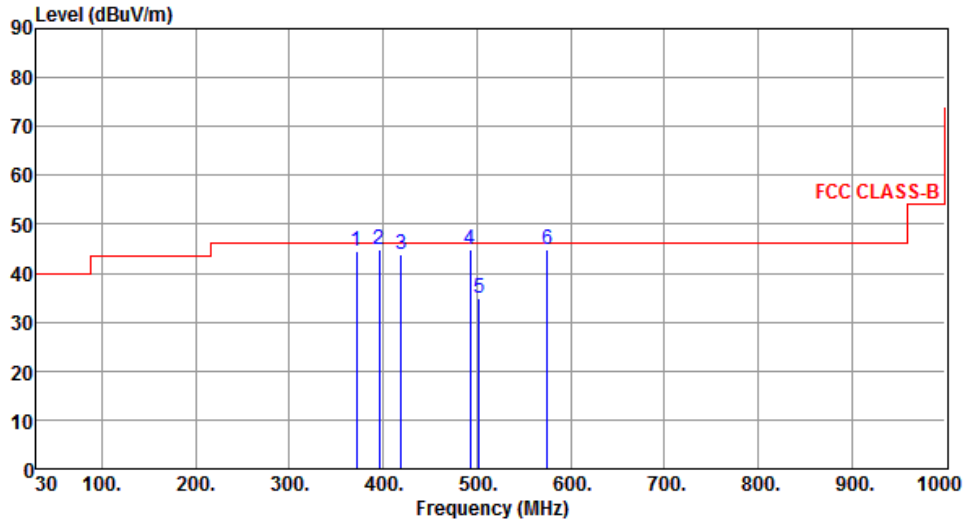

	Freq. MHz	Emission level dBuV/m	Limit dBuV/m	Margin dB	SA reading dBuV	Factor dB	Remark	ANT High cm	Turn Table deg
1	371.62	44.58	46.00	-1.42	50.30	-5.72	QP	100	127
2	395.79	44.88	46.00	-1.12	49.92	-5.04	QP	100	125
3	419.12	43.92	46.00	-2.08	48.35	-4.43	QP	100	124
4	493.31	44.78	46.00	-1.22	47.69	-2.91	QP	169	123
5	502.72	34.88	46.00	-11.12	37.63	-2.75	QP	179	62
6	575.22	44.75	46.00	-1.25	45.79	-1.04	QP	139	138

Note 1: Emission Level (dBuV/m) = SA Reading (dBuV/m) + Factor* (dB)

*Factor includes antenna factor , cable loss and amplifier gain

Note 2: Margin (dB) = Emission level (dBuV/m) – Limit (dBuV/m).

Note 3: All spurious emissions below 30MHz are more than 20 dB below the limit.

Modulation	VHT40	Test Freq. (MHz)	5755
Polarization	Vertical	Test Configuration	1

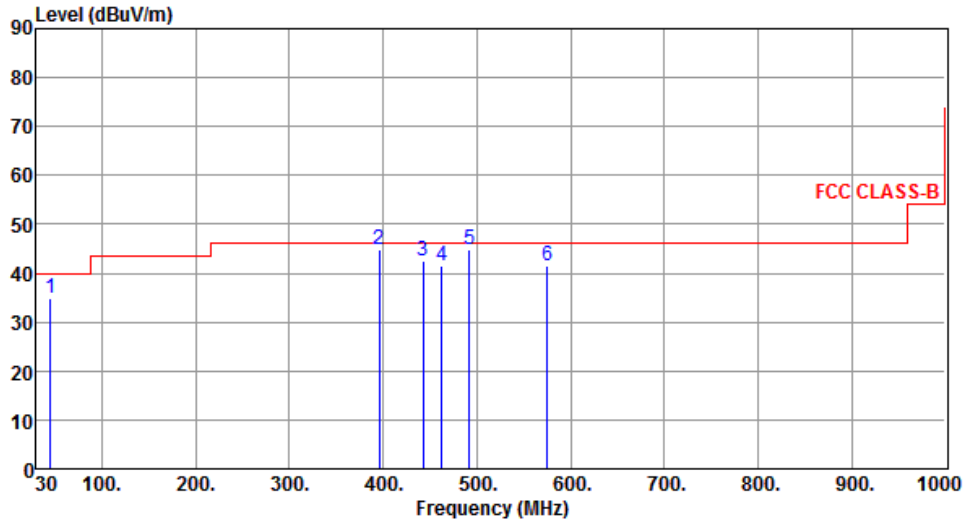

	Freq. MHz	Emission level dBuV/m	Limit dBuV/m	Margin dB	SA reading dBuV	Factor dB	Remark	ANT High cm	Turn Table deg
1	44.85	34.85	40.00	-5.15	42.97	-8.12	QP	100	122
2	395.75	44.86	46.00	-1.14	49.90	-5.04	QP	112	179
3	442.75	42.42	46.00	-3.58	46.24	-3.82	Peak	---	---
4	462.77	41.65	46.00	-4.35	45.07	-3.42	QP	100	130
5	491.79	44.68	46.00	-1.32	47.62	-2.94	QP	100	119
6	575.55	41.63	46.00	-4.37	42.67	-1.04	Peak	---	---

Note 1: Emission Level (dBuV/m) = SA Reading (dBuV/m) + Factor* (dB)

*Factor includes antenna factor , cable loss and amplifier gain

Note 2: Margin (dB) = Emission level (dBuV/m) – Limit (dBuV/m).

Note 3: All spurious emissions below 30MHz are more than 20 dB below the limit.

Modulation	VHT20	Test Freq. (MHz)	5200
Polarization	Horizontal	Test Configuration	2

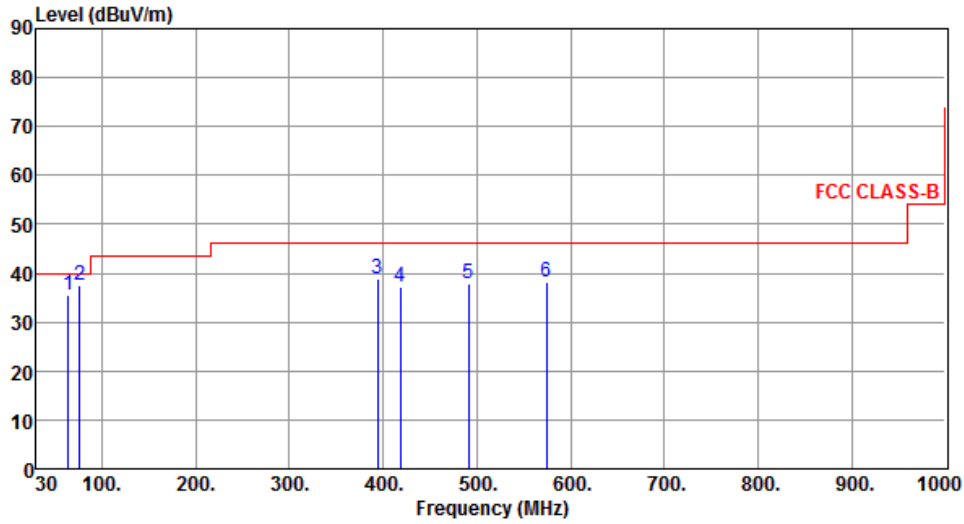

	Freq. MHz	Emission level dBuV/m	Limit dBuV/m	Margin dB	SA reading dBuV	Factor dB	Remark	ANT High cm	Turn Table deg
1	64.31	35.52	40.00	-4.48	44.97	-9.45	QP	100	60
2	76.36	37.53	40.00	-2.47	49.55	-12.02	QP	135	160
3	394.49	38.85	46.00	-7.15	43.93	-5.08	Peak	---	---
4	418.49	37.26	46.00	-8.74	41.70	-4.44	Peak	---	---
5	491.42	37.86	46.00	-8.14	40.80	-2.94	Peak	---	---
6	574.69	38.24	46.00	-7.76	39.30	-1.06	Peak	---	---

Note 1: Emission Level (dBuV/m) = SA Reading (dBuV/m) + Factor* (dB)

*Factor includes antenna factor , cable loss and amplifier gain

Note 2: Margin (dB) = Emission level (dBuV/m) – Limit (dBuV/m).

Note 3: All spurious emissions below 30MHz are more than 20 dB below the limit.

Modulation	VHT20	Test Freq. (MHz)	5200
Polarization	Vertical	Test Configuration	2

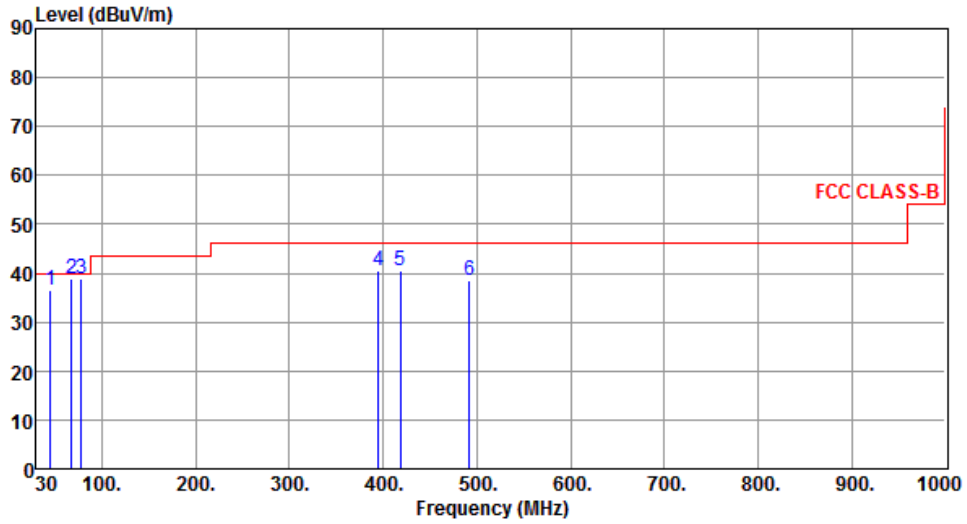

	Freq. MHz	Emission level dBuV/m	Limit dBuV/m	Margin dB	SA reading dBuV	Factor dB	Remark	ANT High cm	Turn Table deg
1	45.41	36.55	40.00	-3.45	44.64	-8.09	QP	100	95
2	67.58	38.95	40.00	-1.05	49.01	-10.06	QP	100	6
3	78.21	38.84	40.00	-1.16	51.27	-12.43	QP	155	187
4	394.75	40.53	46.00	-5.47	45.60	-5.07	Peak	---	---
5	418.62	40.45	46.00	-5.55	44.89	-4.44	Peak	---	---
6	491.79	38.63	46.00	-7.37	41.57	-2.94	Peak	---	---

Note 1: Emission Level (dBuV/m) = SA Reading (dBuV/m) + Factor* (dB)

*Factor includes antenna factor , cable loss and amplifier gain

Note 2: Margin (dB) = Emission level (dBuV/m) – Limit (dBuV/m).

Note 3: All spurious emissions below 30MHz are more than 20 dB below the limit.

Modulation	VHT40	Test Freq. (MHz)	5755
Polarization	Horizontal	Test Configuration	2

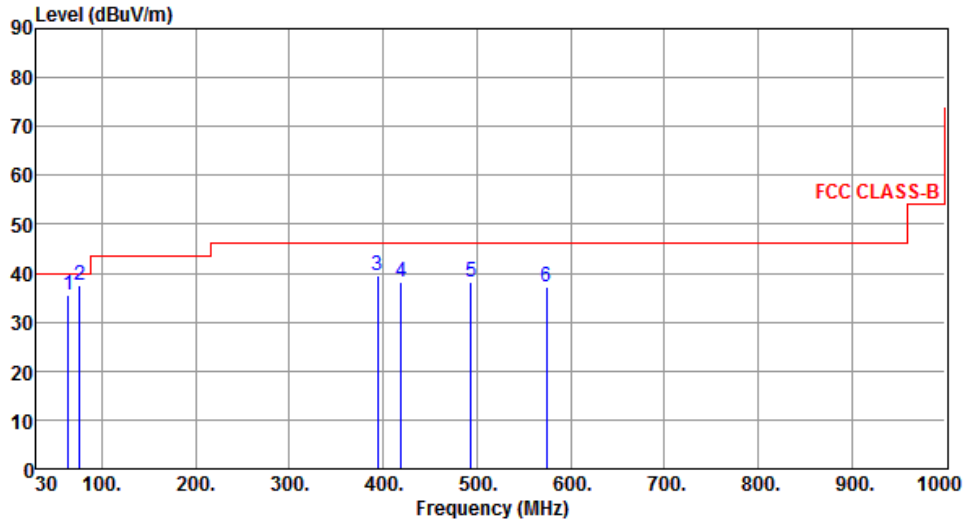

	Freq. MHz	Emission level dBuV/m	Limit dBuV/m	Margin dB	SA reading dBuV	Factor dB	Remark	ANT High cm	Turn Table deg
1	64.33	35.62	40.00	-4.38	45.07	-9.45	QP	100	62
2	76.39	37.58	40.00	-2.42	49.60	-12.02	QP	130	165
3	394.49	39.53	46.00	-6.47	44.61	-5.08	Peak	---	---
4	419.31	38.12	46.00	-7.88	42.55	-4.43	Peak	---	---
5	493.39	38.25	46.00	-7.75	41.16	-2.91	Peak	---	---
6	574.33	37.25	46.00	-8.75	38.32	-1.07	Peak	---	---

Note 1: Emission Level (dBuV/m) = SA Reading (dBuV/m) + Factor* (dB)

*Factor includes antenna factor , cable loss and amplifier gain

Note 2: Margin (dB) = Emission level (dBuV/m) – Limit (dBuV/m).

Note 3: All spurious emissions below 30MHz are more than 20 dB below the limit.

Modulation	VHT40	Test Freq. (MHz)	5755
Polarization	Vertical	Test Configuration	2

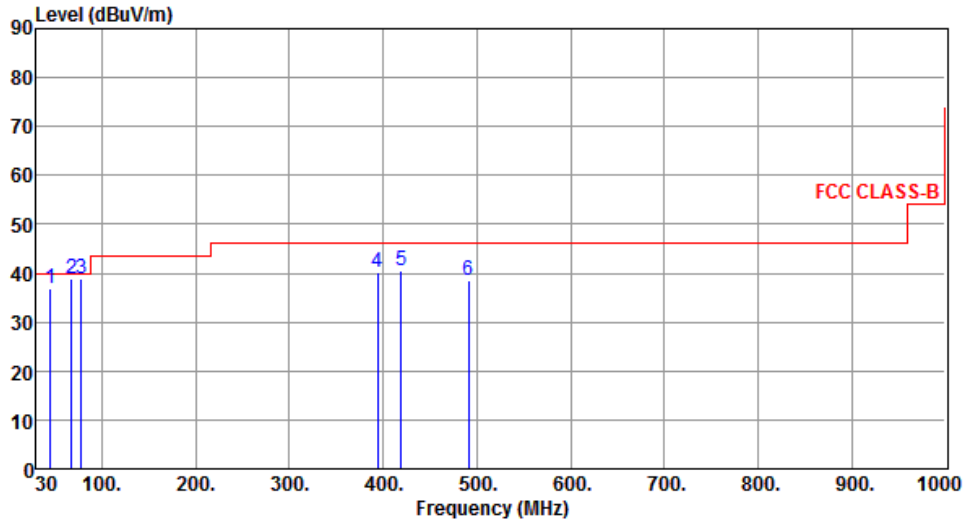

	Freq. MHz	Emission level dBuV/m	Limit dBuV/m	Margin dB	SA reading dBuV	Factor dB	Remark	ANT High cm	Turn Table deg
1	45.33	36.78	40.00	-3.22	44.88	-8.10	QP	100	89
2	67.79	38.96	40.00	-1.04	49.06	-10.10	QP	100	3
3	78.33	38.88	40.00	-1.12	51.33	-12.45	QP	160	179
4	394.42	40.33	46.00	-5.67	45.41	-5.08	Peak	---	---
5	419.33	40.51	46.00	-5.49	44.93	-4.42	Peak	---	---
6	491.33	38.42	46.00	-7.58	41.36	-2.94	Peak	---	---

Note 1: Emission Level (dBuV/m) = SA Reading (dBuV/m) + Factor* (dB)

*Factor includes antenna factor , cable loss and amplifier gain

Note 2: Margin (dB) = Emission level (dBuV/m) – Limit (dBuV/m).

Note 3: All spurious emissions below 30MHz are more than 20 dB below the limit.

3.5.10 Transmitter Radiated Unwanted Emissions (Above 1GHz) for VHT20

Modulation	VHT20	Test Freq. (MHz)	5180
Polarization	Horizontal	Test Configuration	2

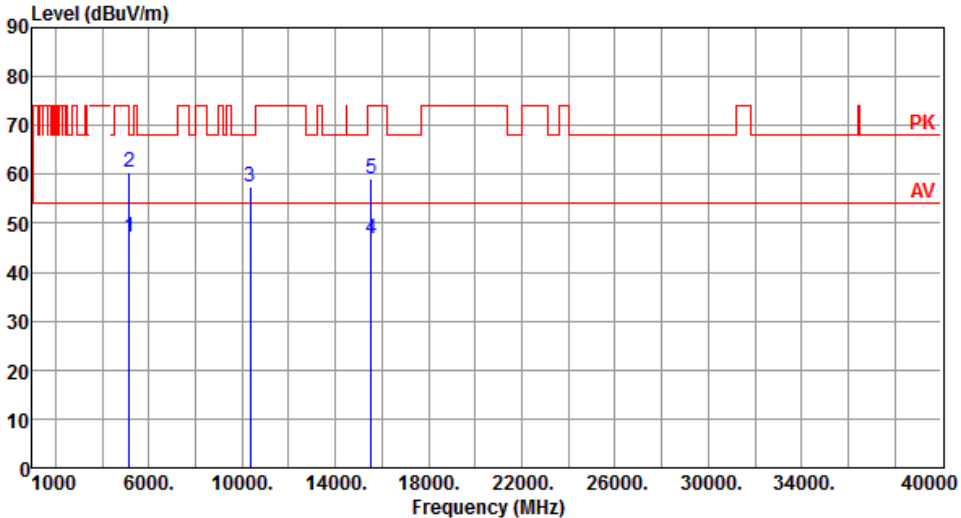

	Freq. MHz	Emission level dBuV/m	Limit dBuV/m	Margin dB	SA reading dBuV	Factor dB	Remark	ANT High cm	Turn Table deg
1	5150.00	47.27	54.00	-6.73	41.32	5.95	Average	248	255
2	5150.00	60.31	74.00	-13.69	54.36	5.95	Peak	248	255
3	10360.00	57.51	68.20	-10.69	42.41	15.10	Peak	100	25
4	15540.00	46.80	54.00	-7.20	31.15	15.65	Average	100	40
5	15540.00	59.14	74.00	-14.86	43.49	15.65	Peak	100	40

Note 1: Emission Level (dBuV/m) = SA Reading (dBuV/m) + Factor* (dB)
*Factor includes antenna factor , cable loss and amplifier gain
Note 2: Margin (dB) = Emission level (dBuV/m) – Limit (dBuV/m).

Modulation	VHT20	Test Freq. (MHz)	5180
Polarization	Vertical	Test Configuration	2

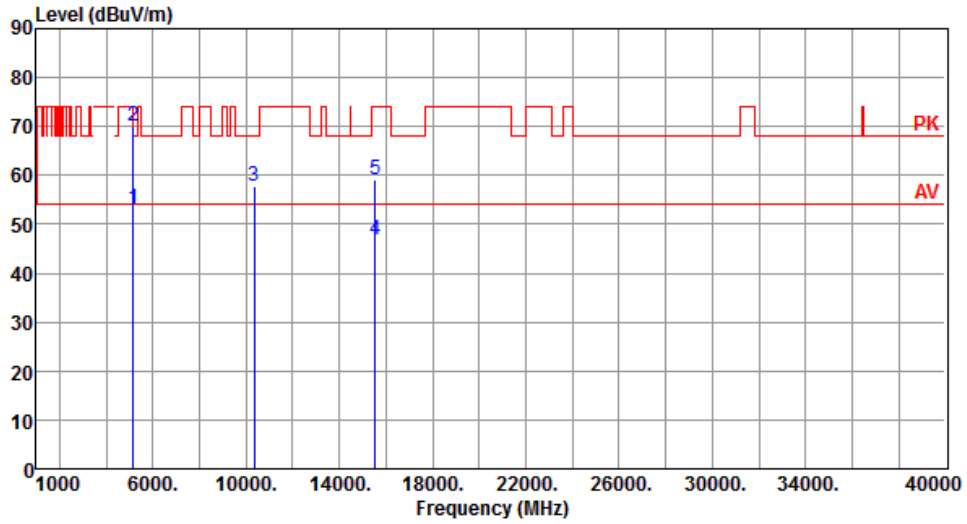

	Freq. MHz	Emission level dBuV/m	Limit dBuV/m	Margin dB	SA reading dBuV	Factor dB	Remark	ANT High cm	Turn Table deg
1	5150.00	53.00	54.00	-1.00	47.05	5.95	Average	210	247
2	5150.00	70.12	74.00	-3.88	64.17	5.95	Peak	210	247
3	10360.00	57.66	68.20	-10.54	42.56	15.10	Peak	100	30
4	15540.00	46.87	54.00	-7.13	31.22	15.65	Average	100	25
5	15540.00	59.19	74.00	-14.81	43.54	15.65	Peak	100	25

Note 1: Emission Level (dBuV/m) = SA Reading (dBuV/m) + Factor* (dB)

*Factor includes antenna factor , cable loss and amplifier gain

Note 2: Margin (dB) = Emission level (dBuV/m) – Limit (dBuV/m).

Modulation	VHT20	Test Freq. (MHz)	5200
Polarization	Horizontal	Test Configuration	2

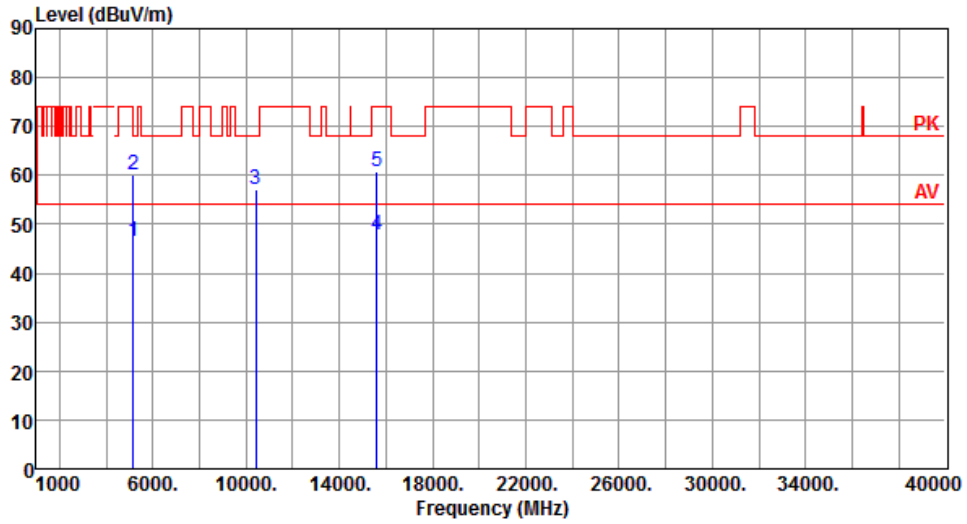

	Freq. MHz	Emission level dBuV/m	Limit dBuV/m	Margin dB	SA reading dBuV	Factor dB	Remark	ANT High cm	Turn Table deg
1	5150.00	46.53	54.00	-7.47	40.58	5.95	Average	245	256
2	5150.00	60.07	74.00	-13.93	54.12	5.95	Peak	245	256
3	10400.00	57.25	68.20	-10.95	41.92	15.33	Peak	100	50
4	15600.00	47.80	54.00	-6.20	32.31	15.49	Average	100	219
5	15600.00	60.83	74.00	-13.17	45.34	15.49	Peak	100	219

Note 1: Emission Level (dBuV/m) = SA Reading (dBuV/m) + Factor* (dB)

*Factor includes antenna factor , cable loss and amplifier gain

Note 2: Margin (dB) = Emission level (dBuV/m) – Limit (dBuV/m).

Modulation	VHT20	Test Freq. (MHz)	5200
Polarization	Vertical	Test Configuration	2

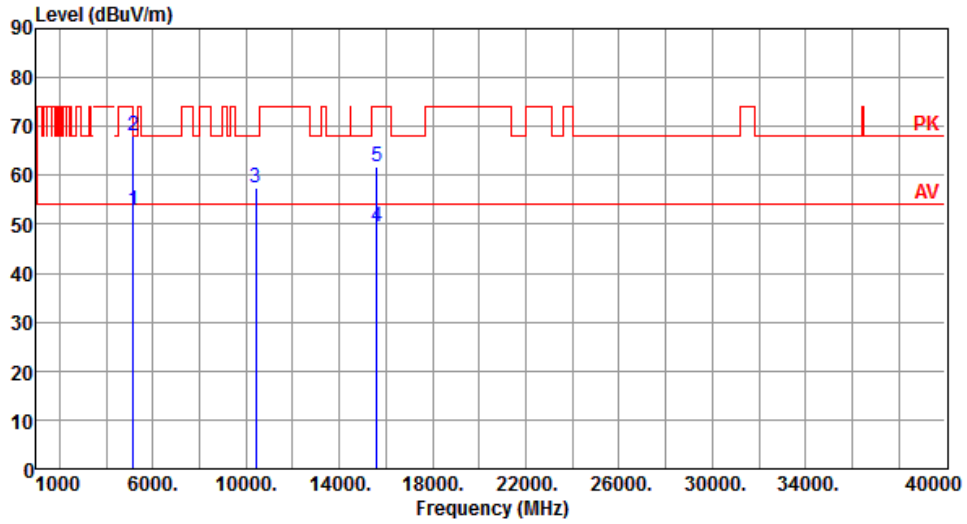

	Freq. MHz	Emission level dBuV/m	Limit dBuV/m	Margin dB	SA reading dBuV	Factor dB	Remark	ANT High cm	Turn Table deg
1	5150.00	52.97	54.00	-1.03	47.02	5.95	Average	201	245
2	5150.00	67.96	74.00	-6.04	62.01	5.95	Peak	201	245
3	10400.00	57.61	68.20	-10.59	42.28	15.33	Peak	100	20
4	15600.00	49.40	54.00	-4.60	33.91	15.49	Average	100	196
5	15600.00	61.73	74.00	-12.27	46.24	15.49	Peak	100	196

Note 1: Emission Level (dBuV/m) = SA Reading (dBuV/m) + Factor* (dB)

*Factor includes antenna factor , cable loss and amplifier gain

Note 2: Margin (dB) = Emission level (dBuV/m) – Limit (dBuV/m).

Modulation	VHT20	Test Freq. (MHz)	5240
Polarization	Horizontal	Test Configuration	2

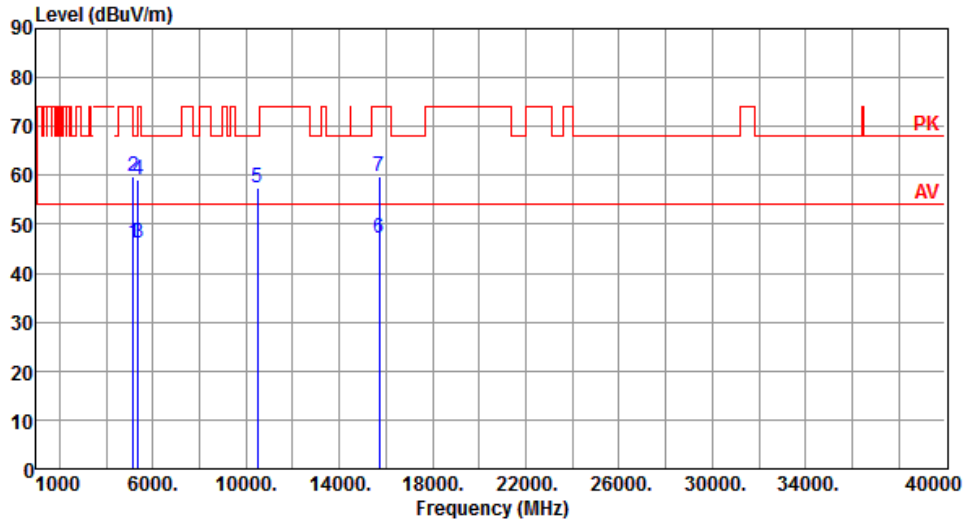

	Freq. MHz	Emission level dBuV/m	Limit dBuV/m	Margin dB	SA reading dBuV	Factor dB	Remark	ANT High cm	Turn Table deg
1	5150.00	46.26	54.00	-7.74	40.31	5.95	Average	249	254
2	5150.00	59.80	74.00	-14.20	53.85	5.95	Peak	249	254
3	5350.00	46.25	54.00	-7.75	40.85	5.40	Average	249	254
4	5350.00	59.14	74.00	-14.86	53.74	5.40	Peak	249	254
5	10480.00	57.54	68.20	-10.66	42.23	15.31	Peak	100	30
6	15720.00	47.09	54.00	-6.91	31.86	15.23	Average	100	216
7	15720.00	59.80	74.00	-14.20	44.57	15.23	Peak	100	216

Note 1: Emission Level (dBuV/m) = SA Reading (dBuV/m) + Factor* (dB)

*Factor includes antenna factor , cable loss and amplifier gain

Note 2: Margin (dB) = Emission level (dBuV/m) – Limit (dBuV/m).

Modulation	VHT20	Test Freq. (MHz)	5240
Polarization	Vertical	Test Configuration	2

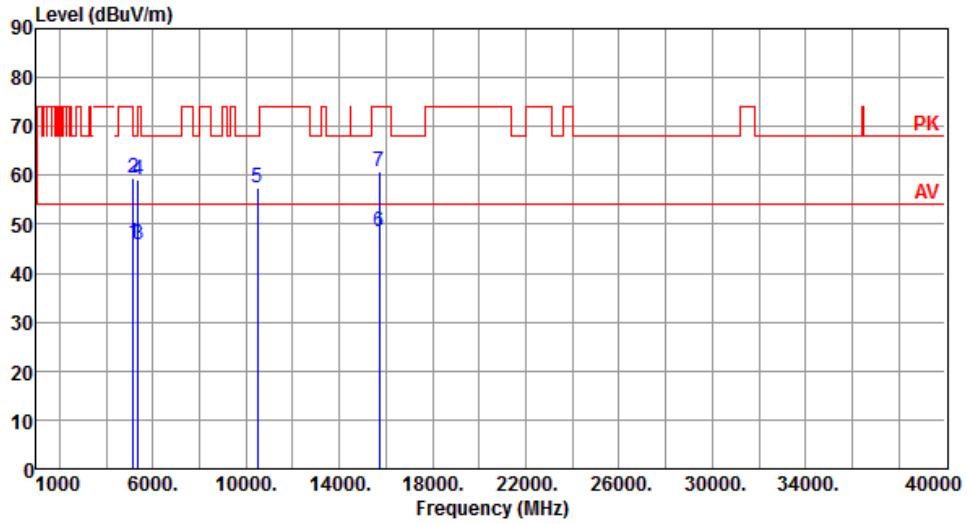

	Freq. MHz	Emission level dBuV/m	Limit dBuV/m	Margin dB	SA reading dBuV	Factor dB	Remark	ANT High cm	Turn Table deg
1	5150.00	46.17	54.00	-7.83	40.22	5.95	Average	219	254
2	5150.00	59.54	74.00	-14.46	53.59	5.95	Peak	219	254
3	5350.00	45.96	54.00	-8.04	40.56	5.40	Average	219	254
4	5350.00	58.98	74.00	-15.02	53.58	5.40	Peak	219	254
5	10480.00	57.46	68.20	-10.74	42.15	15.31	Peak	100	20
6	15720.00	48.48	54.00	-5.52	33.25	15.23	Average	100	192
7	15720.00	60.90	74.00	-13.10	45.67	15.23	Peak	100	192

Note 1: Emission Level (dBuV/m) = SA Reading (dBuV/m) + Factor* (dB)

*Factor includes antenna factor , cable loss and amplifier gain

Note 2: Margin (dB) = Emission level (dBuV/m) – Limit (dBuV/m).

Modulation	VHT20	Test Freq. (MHz)	5745
Polarization	Horizontal	Test Configuration	2

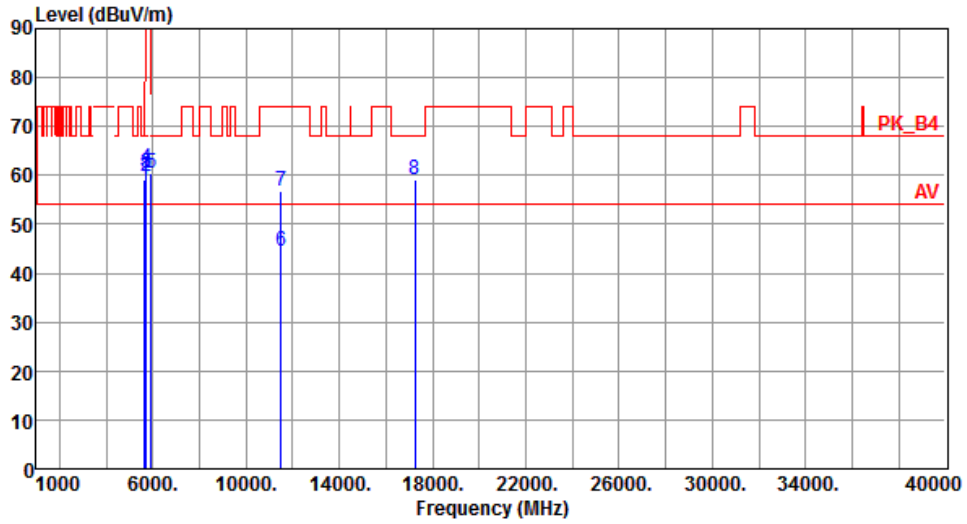

	Freq. MHz	Emission level dBuV/m	Limit dBuV/m	Margin dB	SA reading dBuV	Factor dB	Remark	ANT High cm	Turn Table deg
1	5650.00	59.05	68.20	-9.15	53.14	5.91	Peak	100	45
2	5700.00	59.80	105.20	-45.40	53.57	6.23	Peak	100	45
3	5720.00	60.52	110.80	-50.28	54.24	6.28	Peak	100	45
4	5725.00	61.41	122.20	-60.79	55.12	6.29	Peak	100	45
5	5925.00	60.44	68.20	-7.76	53.62	6.82	Peak	100	45
6	11490.00	44.67	54.00	-9.33	29.22	15.45	Average	100	20
7	11490.00	56.77	74.00	-17.23	41.32	15.45	Peak	100	20
8	17235.00	59.17	68.20	-9.03	42.19	16.98	Peak	100	30

Note 1: Emission Level (dBuV/m) = SA Reading (dBuV/m) + Factor* (dB)

*Factor includes antenna factor , cable loss and amplifier gain

Note 2: Margin (dB) = Emission level (dBuV/m) – Limit (dBuV/m).

Modulation	VHT20	Test Freq. (MHz)	5745
Polarization	Vertical	Test Configuration	2

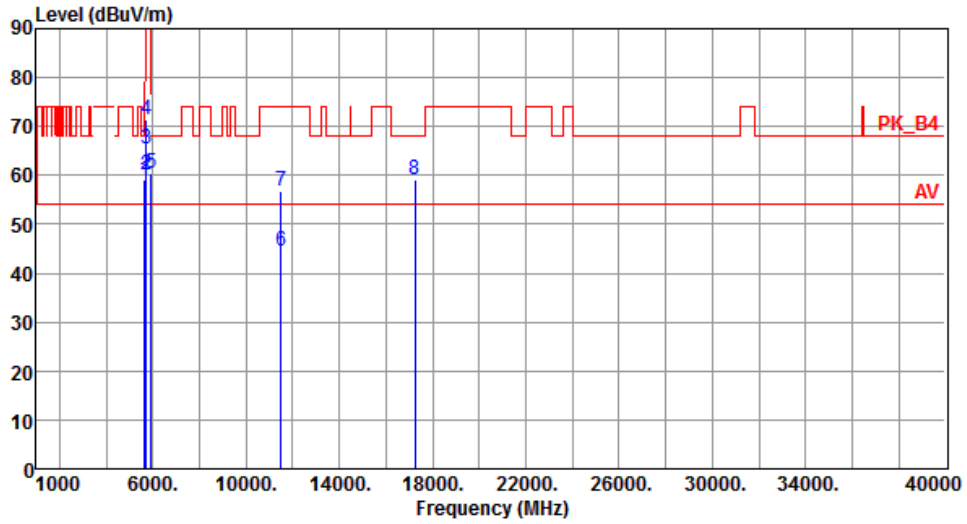

	Freq. MHz	Emission level dBuV/m	Limit dBuV/m	Margin dB	SA reading dBuV	Factor dB	Remark	ANT High cm	Turn Table deg
1	5650.00	59.16	68.20	-9.04	53.25	5.91	Peak	100	76
2	5700.00	60.07	105.20	-45.13	53.84	6.23	Peak	100	76
3	5720.00	65.43	110.80	-45.37	59.15	6.28	Peak	100	76
4	5725.00	71.33	122.20	-50.87	65.04	6.29	Peak	100	76
5	5925.00	60.36	68.20	-7.84	53.54	6.82	Peak	100	76
6	11490.00	44.58	54.00	-9.42	29.13	15.45	Average	100	30
7	11490.00	56.73	74.00	-17.27	41.28	15.45	Peak	100	30
8	17235.00	59.26	68.20	-8.94	42.28	16.98	Peak	100	50

Note 1: Emission Level (dBuV/m) = SA Reading (dBuV/m) + Factor* (dB)

*Factor includes antenna factor , cable loss and amplifier gain

Note 2: Margin (dB) = Emission level (dBuV/m) – Limit (dBuV/m).

Modulation	VHT20	Test Freq. (MHz)	5785
Polarization	Horizontal	Test Configuration	2

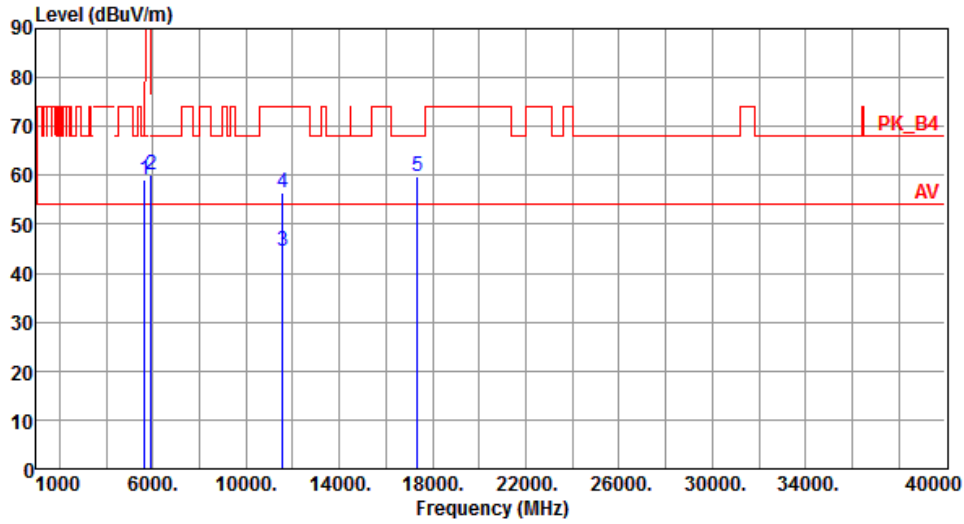

	Freq. MHz	Emission level dBuV/m	Limit dBuV/m	Margin dB	SA reading dBuV	Factor dB	Remark	ANT High cm	Turn Table deg
1	5650.00	59.15	68.20	-9.05	53.24	5.91	Peak	100	42
2	5925.00	60.27	68.20	-7.93	53.45	6.82	Peak	100	42
3	11570.00	44.42	54.00	-9.58	29.12	15.30	Average	100	30
4	11570.00	56.55	74.00	-17.45	41.25	15.30	Peak	100	30
5	17355.00	59.87	68.20	-8.33	42.26	17.61	Peak	100	60

Note 1: Emission Level (dBuV/m) = SA Reading (dBuV/m) + Factor* (dB)

*Factor includes antenna factor , cable loss and amplifier gain

Note 2: Margin (dB) = Emission level (dBuV/m) – Limit (dBuV/m).

Modulation	VHT20	Test Freq. (MHz)	5785
Polarization	Vertical	Test Configuration	2

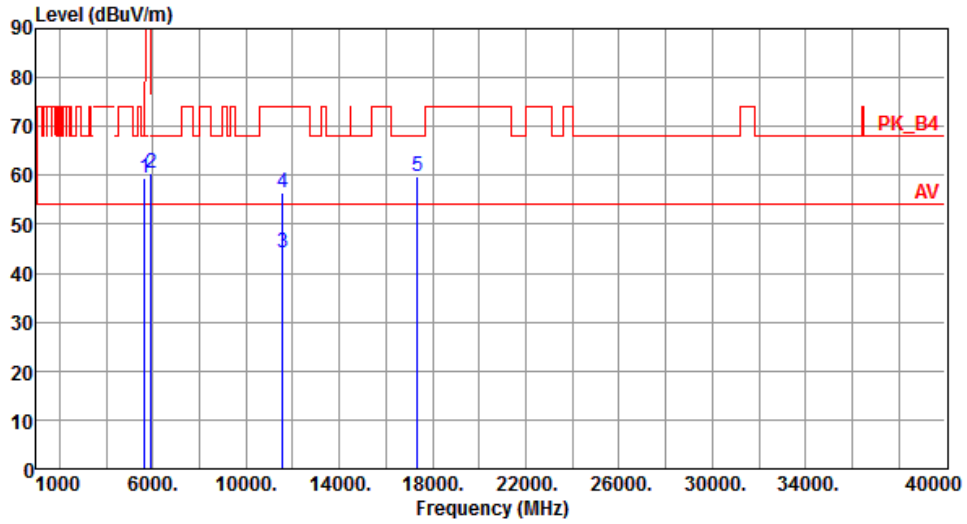

	Freq. MHz	Emission level dBuV/m	Limit dBuV/m	Margin dB	SA reading dBuV	Factor dB	Remark	ANT High cm	Turn Table deg
1	5650.00	59.56	68.20	-8.64	53.65	5.91	Peak	100	70
2	5925.00	60.36	68.20	-7.84	53.54	6.82	Peak	100	70
3	11570.00	44.33	54.00	-9.67	29.03	15.30	Average	100	20
4	11570.00	56.45	74.00	-17.55	41.15	15.30	Peak	100	20
5	17355.00	59.85	68.20	-8.35	42.24	17.61	Peak	100	50

Note 1: Emission Level (dBuV/m) = SA Reading (dBuV/m) + Factor* (dB)

*Factor includes antenna factor , cable loss and amplifier gain

Note 2: Margin (dB) = Emission level (dBuV/m) – Limit (dBuV/m).

Modulation	VHT20	Test Freq. (MHz)	5825
Polarization	Horizontal	Test Configuration	2

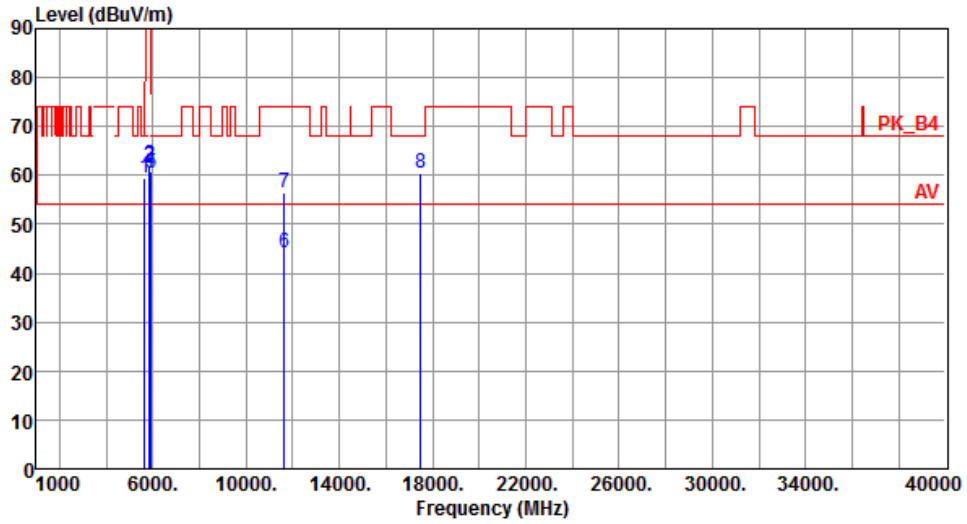

	Freq. MHz	Emission level dBuV/m	Limit dBuV/m	Margin dB	SA reading dBuV	Factor dB	Remark	ANT High cm	Turn Table deg
1	5650.00	59.50	68.20	-8.70	53.59	5.91	Peak	100	43
2	5850.00	62.06	122.20	-60.14	55.39	6.67	Peak	100	43
3	5855.00	61.89	110.80	-48.91	55.21	6.68	Peak	100	43
4	5875.00	60.74	105.20	-44.46	54.02	6.72	Peak	100	43
5	5925.00	60.51	68.20	-7.69	53.69	6.82	Peak	100	43
6	11650.00	44.21	54.00	-9.79	29.15	15.06	Average	100	40
7	11650.00	56.30	74.00	-17.70	41.24	15.06	Peak	100	40
8	17475.00	60.44	68.20	-7.76	42.21	18.23	Peak	100	85

Note 1: Emission Level (dBuV/m) = SA Reading (dBuV/m) + Factor* (dB)

*Factor includes antenna factor , cable loss and amplifier gain

Note 2: Margin (dB) = Emission level (dBuV/m) – Limit (dBuV/m).

Modulation	VHT20	Test Freq. (MHz)	5825
Polarization	Vertical	Test Configuration	2

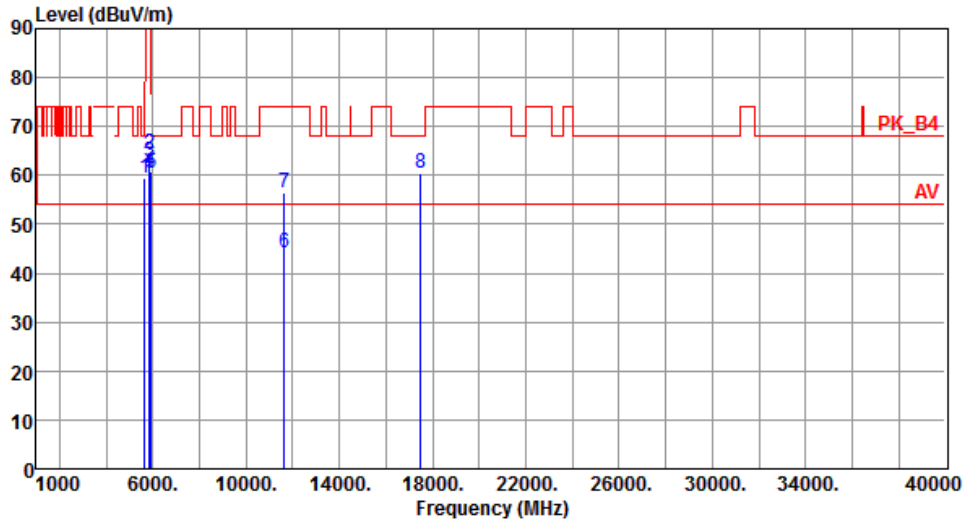

	Freq. MHz	Emission level dBuV/m	Limit dBuV/m	Margin dB	SA reading dBuV	Factor dB	Remark	ANT High cm	Turn Table deg
1	5650.00	59.56	68.20	-8.64	53.65	5.91	Peak	100	68
2	5850.00	64.41	122.20	-57.79	57.74	6.67	Peak	100	68
3	5855.00	62.77	110.80	-48.03	56.09	6.68	Peak	100	68
4	5875.00	60.85	105.20	-44.35	54.13	6.72	Peak	100	68
5	5925.00	60.36	68.20	-7.84	53.54	6.82	Peak	100	68
6	11650.00	44.23	54.00	-9.77	29.17	15.06	Average	100	50
7	11650.00	56.42	74.00	-17.58	41.36	15.06	Peak	100	50
8	17475.00	60.55	68.20	-7.65	42.32	18.23	Peak	100	90

Note 1: Emission Level (dBuV/m) = SA Reading (dBuV/m) + Factor* (dB)

*Factor includes antenna factor , cable loss and amplifier gain

Note 2: Margin (dB) = Emission level (dBuV/m) – Limit (dBuV/m).

3.5.11 Transmitter Radiated Unwanted Emissions (Above 1GHz) for VHT40

Modulation	VHT40	Test Freq. (MHz)	5190
Polarization	Horizontal	Test Configuration	2

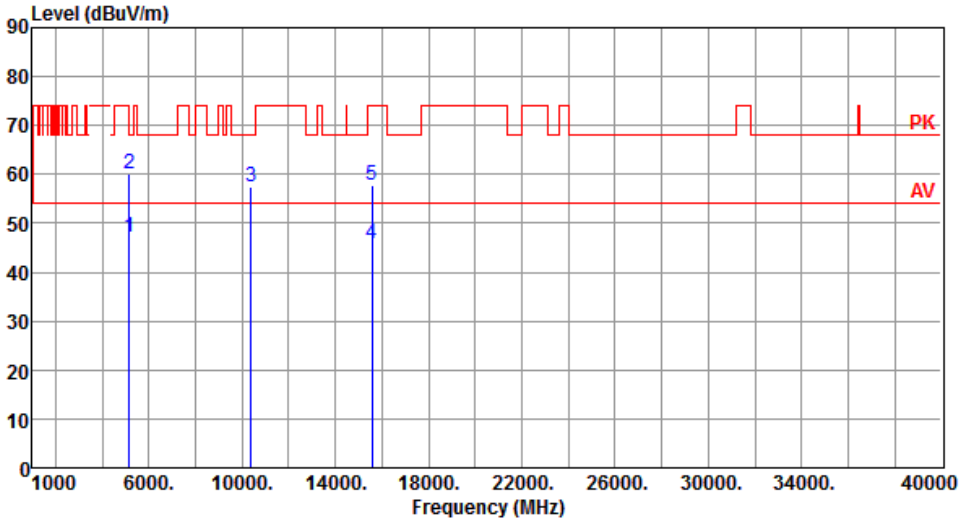

	Freq. MHz	Emission level dBuV/m	Limit dBuV/m	Margin dB	SA reading dBuV	Factor dB	Remark	ANT High cm	Turn Table deg
1	5150.00	47.16	54.00	-6.84	41.21	5.95	Average	241	253
2	5150.00	60.27	74.00	-13.73	54.32	5.95	Peak	241	253
3	10380.00	57.47	68.20	-10.73	42.25	15.22	Peak	100	40
4	15570.00	45.76	54.00	-8.24	30.19	15.57	Average	100	15
5	15570.00	57.78	74.00	-16.22	42.21	15.57	Peak	100	15

Note 1: Emission Level (dBuV/m) = SA Reading (dBuV/m) + Factor* (dB)
*Factor includes antenna factor , cable loss and amplifier gain
Note 2: Margin (dB) = Emission level (dBuV/m) – Limit (dBuV/m).

Modulation	VHT40	Test Freq. (MHz)	5190
Polarization	Vertical	Test Configuration	2

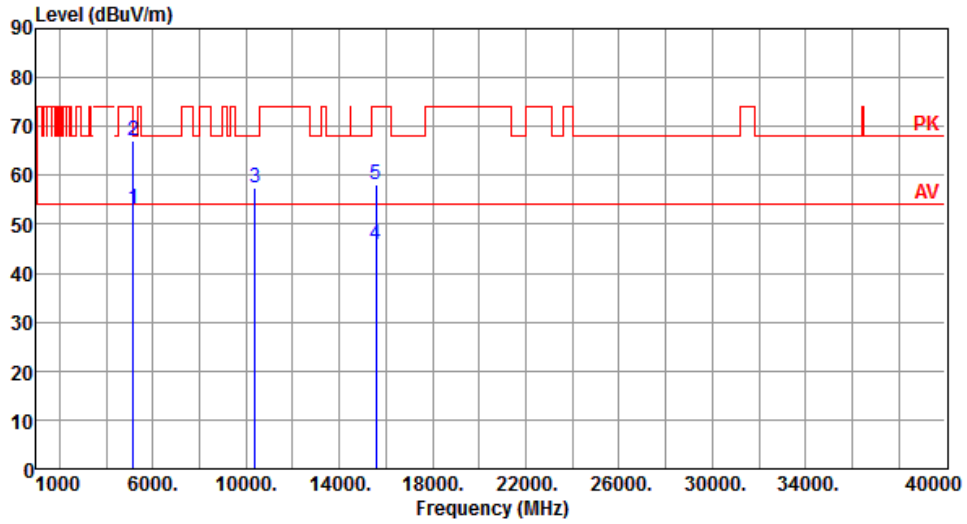

	Freq. MHz	Emission level dBuV/m	Limit dBuV/m	Margin dB	SA reading dBuV	Factor dB	Remark	ANT High cm	Turn Table deg
1	5150.00	52.98	54.00	-1.02	47.03	5.95	Average	220	254
2	5150.00	67.11	74.00	-6.89	61.16	5.95	Peak	220	254
3	10380.00	57.36	68.20	-10.84	42.14	15.22	Peak	100	30
4	15570.00	45.78	54.00	-8.22	30.21	15.57	Average	100	20
5	15570.00	57.95	74.00	-16.05	42.38	15.57	Peak	100	20

Note 1: Emission Level (dBuV/m) = SA Reading (dBuV/m) + Factor* (dB)

*Factor includes antenna factor , cable loss and amplifier gain

Note 2: Margin (dB) = Emission level (dBuV/m) – Limit (dBuV/m).

Modulation	VHT40	Test Freq. (MHz)	5230
Polarization	Horizontal	Test Configuration	2

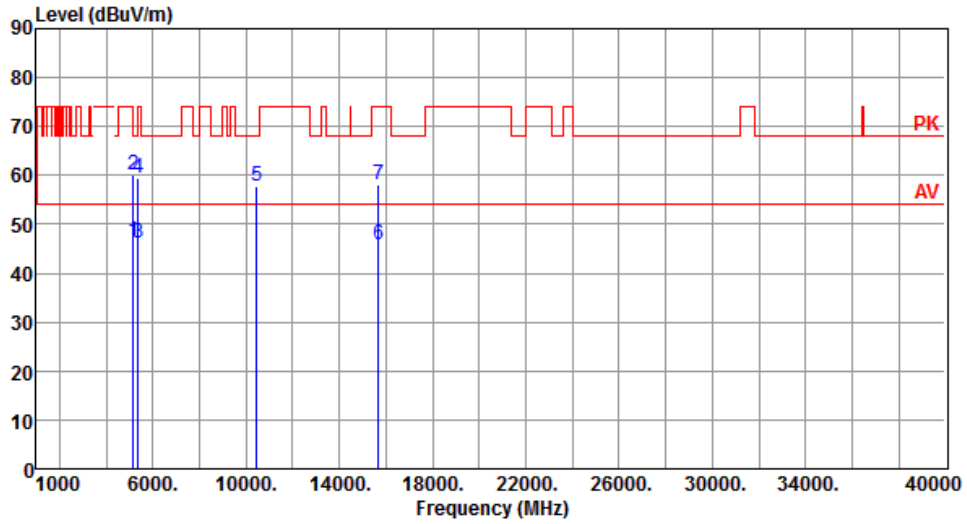

	Freq. MHz	Emission level dBuV/m	Limit dBuV/m	Margin dB	SA reading dBuV	Factor dB	Remark	ANT High cm	Turn Table deg
1	5150.00	46.49	54.00	-7.51	40.54	5.95	Average	248	250
2	5150.00	60.07	74.00	-13.93	54.12	5.95	Peak	248	250
3	5350.00	46.09	54.00	-7.91	40.69	5.40	Average	248	250
4	5350.00	59.55	74.00	-14.45	54.15	5.40	Peak	248	250
5	10460.00	57.68	68.20	-10.52	42.36	15.32	Peak	100	80
6	15690.00	45.70	54.00	-8.30	30.35	15.35	Average	100	80
7	15690.00	57.96	74.00	-16.04	42.61	15.35	Peak	100	80

Note 1: Emission Level (dBuV/m) = SA Reading (dBuV/m) + Factor* (dB)

*Factor includes antenna factor , cable loss and amplifier gain

Note 2: Margin (dB) = Emission level (dBuV/m) – Limit (dBuV/m).

Modulation	VHT40	Test Freq. (MHz)	5230
Polarization	Vertical	Test Configuration	2

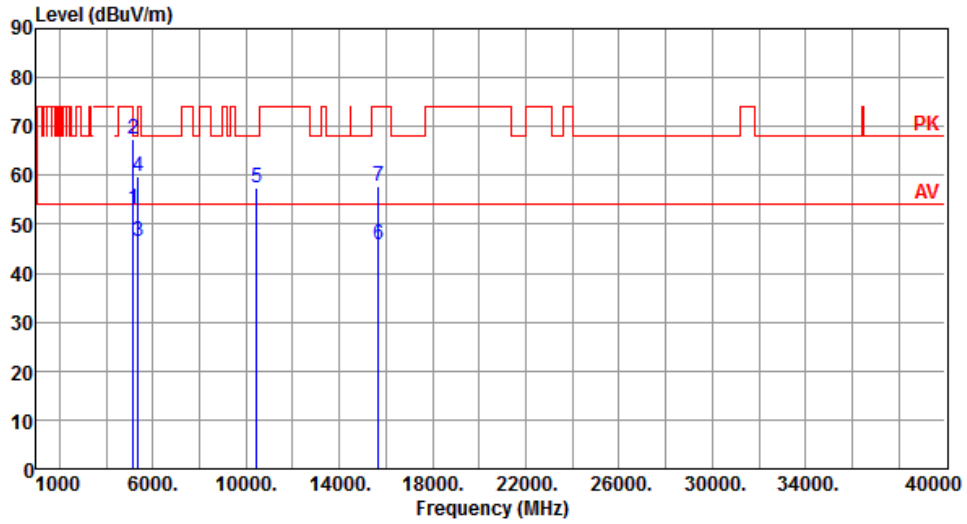

	Freq. MHz	Emission level dBuV/m	Limit dBuV/m	Margin dB	SA reading dBuV	Factor dB	Remark	ANT High cm	Turn Table deg
1	5150.00	52.98	54.00	-1.02	47.03	5.95	Average	217	249
2	5150.00	67.33	74.00	-6.67	61.38	5.95	Peak	217	249
3	5350.00	46.65	54.00	-7.35	41.25	5.40	Average	217	249
4	5350.00	59.65	74.00	-14.35	54.25	5.40	Peak	217	249
5	10460.00	57.56	68.20	-10.64	42.24	15.32	Peak	100	90
6	15690.00	45.76	54.00	-8.24	30.41	15.35	Average	100	100
7	15690.00	57.85	74.00	-16.15	42.50	15.35	Peak	100	100

Note 1: Emission Level (dBuV/m) = SA Reading (dBuV/m) + Factor* (dB)

*Factor includes antenna factor , cable loss and amplifier gain

Note 2: Margin (dB) = Emission level (dBuV/m) – Limit (dBuV/m).

Modulation	VHT40	Test Freq. (MHz)	5755
Polarization	Horizontal	Test Configuration	2

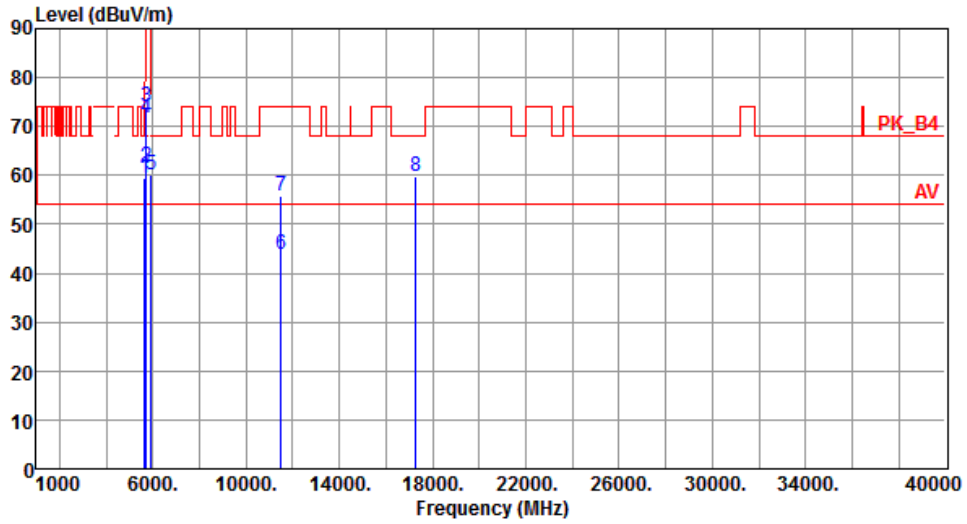

	Freq. MHz	Emission level dBuV/m	Limit dBuV/m	Margin dB	SA reading dBuV	Factor dB	Remark	ANT High cm	Turn Table deg
1	5650.00	59.60	68.20	-8.60	53.69	5.91	Peak	100	48
2	5700.00	61.86	105.20	-43.34	55.63	6.23	Peak	100	48
3	5720.00	73.92	110.80	-36.88	67.64	6.28	Peak	100	48
4	5725.00	71.65	122.20	-50.55	65.36	6.29	Peak	100	48
5	5925.00	60.17	68.20	-8.03	53.35	6.82	Peak	100	48
6	11510.00	43.69	54.00	-10.31	28.24	15.45	Average	100	25
7	11510.00	55.91	74.00	-18.09	40.46	15.45	Peak	100	25
8	17265.00	59.68	68.20	-8.52	42.57	17.11	Peak	100	70

Note 1: Emission Level (dBuV/m) = SA Reading (dBuV/m) + Factor* (dB)

*Factor includes antenna factor , cable loss and amplifier gain

Note 2: Margin (dB) = Emission level (dBuV/m) – Limit (dBuV/m).

Modulation	VHT40	Test Freq. (MHz)	5755
Polarization	Vertical	Test Configuration	2

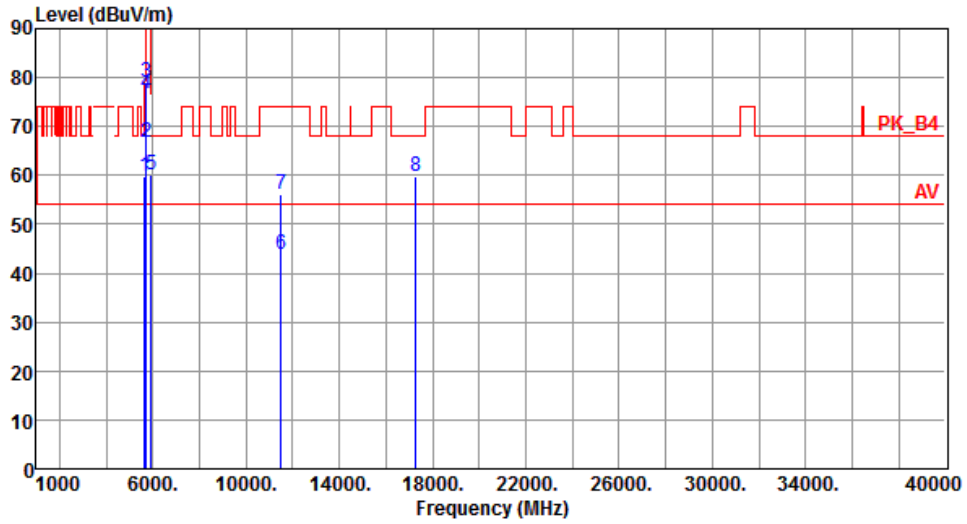

	Freq. MHz	Emission level dBuV/m	Limit dBuV/m	Margin dB	SA reading dBuV	Factor dB	Remark	ANT High cm	Turn Table deg
1	5650.00	59.63	68.20	-8.57	53.72	5.91	Peak	100	74
2	5700.00	66.71	105.20	-38.49	60.48	6.23	Peak	100	74
3	5720.00	79.17	110.80	-31.63	72.89	6.28	Peak	100	74
4	5725.00	76.62	122.20	-45.58	70.33	6.29	Peak	100	74
5	5925.00	60.06	68.20	-8.14	53.24	6.82	Peak	100	74
6	11510.00	43.70	54.00	-10.30	28.25	15.45	Average	100	30
7	11510.00	56.02	74.00	-17.98	40.57	15.45	Peak	100	30
8	17265.00	59.68	68.20	-8.52	42.57	17.11	Peak	100	90

Note 1: Emission Level (dBuV/m) = SA Reading (dBuV/m) + Factor* (dB)

*Factor includes antenna factor , cable loss and amplifier gain

Note 2: Margin (dB) = Emission level (dBuV/m) – Limit (dBuV/m).

Modulation	VHT40	Test Freq. (MHz)	5795
Polarization	Horizontal	Test Configuration	2

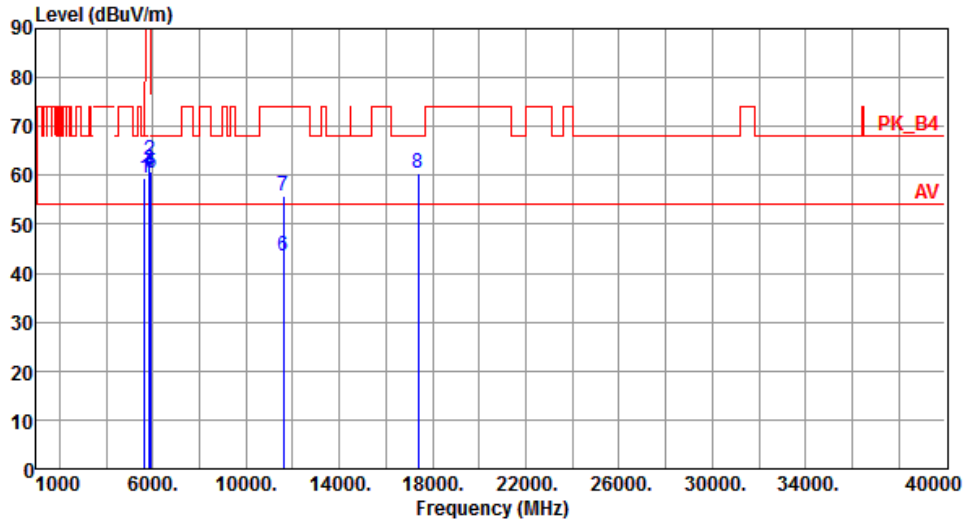

	Freq. MHz	Emission level dBuV/m	Limit dBuV/m	Margin dB	SA reading dBuV	Factor dB	Remark	ANT High cm	Turn Table deg
1	5650.00	59.33	68.20	-8.87	53.42	5.91	Peak	100	41
2	5850.00	63.03	122.20	-59.17	56.36	6.67	Peak	100	41
3	5855.00	61.04	110.80	-49.76	54.36	6.68	Peak	100	41
4	5875.00	60.74	105.20	-44.46	54.02	6.72	Peak	100	41
5	5925.00	60.46	68.20	-7.74	53.64	6.82	Peak	100	41
6	11590.00	43.47	54.00	-10.53	28.21	15.26	Average	100	60
7	11590.00	55.88	74.00	-18.12	40.62	15.26	Peak	100	60
8	17385.00	60.33	68.20	-7.87	42.52	17.81	Peak	100	30

Note 1: Emission Level (dBuV/m) = SA Reading (dBuV/m) + Factor* (dB)

*Factor includes antenna factor , cable loss and amplifier gain

Note 2: Margin (dB) = Emission level (dBuV/m) – Limit (dBuV/m).

Modulation	VHT40	Test Freq. (MHz)	5795
Polarization	Vertical	Test Configuration	2

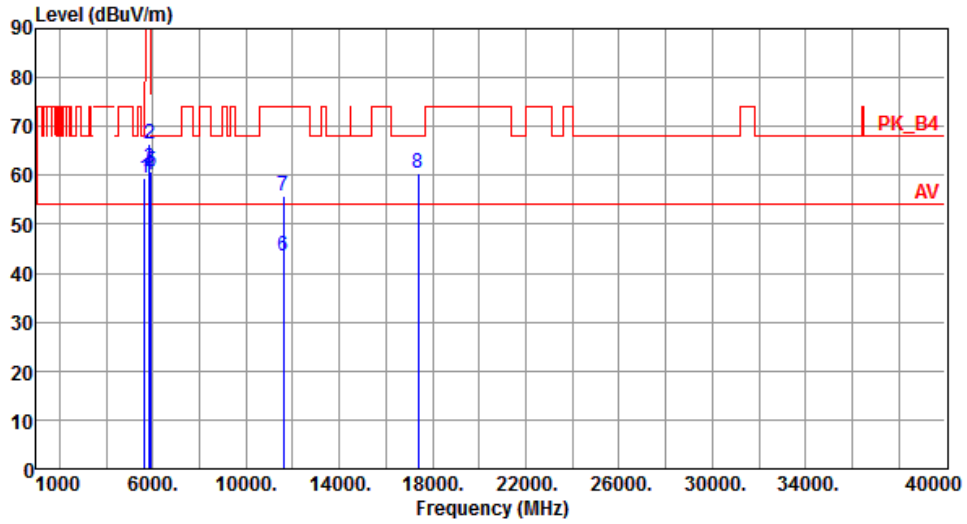

	Freq. MHz	Emission level dBuV/m	Limit dBuV/m	Margin dB	SA reading dBuV	Factor dB	Remark	ANT High cm	Turn Table deg
1	5650.00	59.47	68.20	-8.73	53.56	5.91	Peak	100	75
2	5850.00	66.26	122.20	-55.94	59.59	6.67	Peak	100	75
3	5855.00	61.53	110.80	-49.27	54.85	6.68	Peak	100	75
4	5875.00	60.27	105.20	-44.93	53.55	6.72	Peak	100	75
5	5925.00	60.67	68.20	-7.53	53.85	6.82	Peak	100	75
6	11590.00	43.52	54.00	-10.48	28.26	15.26	Average	100	30
7	11590.00	55.83	74.00	-18.17	40.57	15.26	Peak	100	30
8	17385.00	60.42	68.20	-7.78	42.61	17.81	Peak	100	20

Note 1: Emission Level (dBuV/m) = SA Reading (dBuV/m) + Factor* (dB)

*Factor includes antenna factor , cable loss and amplifier gain

Note 2: Margin (dB) = Emission level (dBuV/m) – Limit (dBuV/m).

3.5.12 Transmitter Radiated Unwanted Emissions (Above 1GHz) for VHT80

Modulation	VHT80	Test Freq. (MHz)	5210
Polarization	Horizontal	Test Configuration	2

	Freq. MHz	Emission level dBuV/m	Limit dBuV/m	Margin dB	SA reading dBuV	Factor dB	Remark	ANT High cm	Turn Table deg
1	5150.00	47.21	54.00	-6.79	41.26	5.95	Average	253	255
2	5150.00	60.51	74.00	-13.49	54.56	5.95	Peak	253	255
3	5350.00	46.25	54.00	-7.75	40.85	5.40	Average	253	255
4	5350.00	59.66	74.00	-14.34	54.26	5.40	Peak	253	255
5	10420.00	57.51	68.20	-10.69	42.19	15.32	Peak	100	80
6	15630.00	44.46	54.00	-9.54	29.02	15.44	Average	100	25
7	15630.00	57.85	74.00	-16.15	42.41	15.44	Peak	100	25

Note 1: Emission Level (dBuV/m) = SA Reading (dBuV/m) + Factor* (dB)
*Factor includes antenna factor , cable loss and amplifier gain
Note 2: Margin (dB) = Emission level (dBuV/m) – Limit (dBuV/m).

Modulation	VHT80	Test Freq. (MHz)	5210
Polarization	Vertical	Test Configuration	2

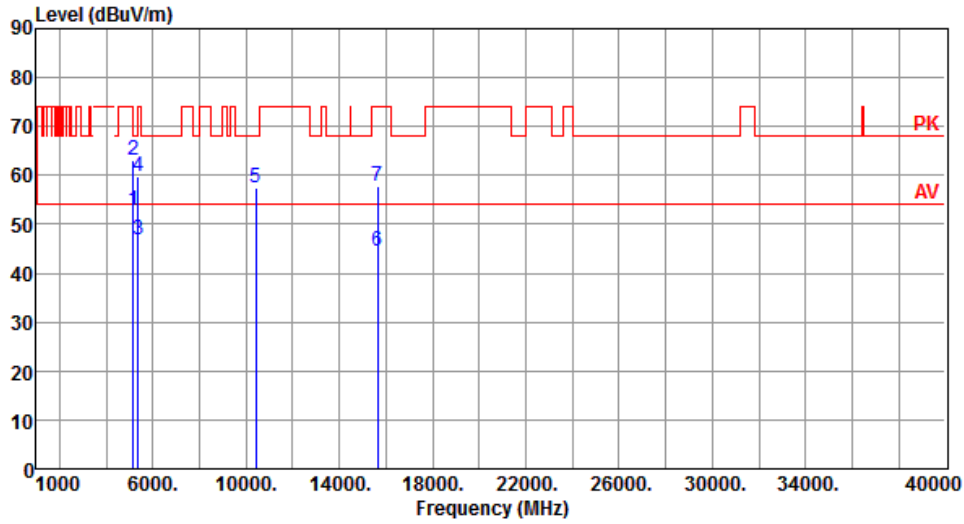

	Freq. MHz	Emission level dBuV/m	Limit dBuV/m	Margin dB	SA reading dBuV	Factor dB	Remark	ANT High cm	Turn Table deg
1	5150.00	52.97	54.00	-1.03	47.02	5.95	Average	202	254
2	5150.00	63.24	74.00	-10.76	57.29	5.95	Peak	202	254
3	5350.00	46.95	54.00	-7.05	41.55	5.40	Average	202	254
4	5350.00	59.91	74.00	-14.09	54.51	5.40	Peak	202	254
5	10420.00	57.46	68.20	-10.74	42.14	15.32	Peak	100	100
6	15630.00	44.58	54.00	-9.42	29.14	15.44	Average	100	30
7	15630.00	57.80	74.00	-16.20	42.36	15.44	Peak	100	30

Note 1: Emission Level (dBuV/m) = SA Reading (dBuV/m) + Factor* (dB)

*Factor includes antenna factor , cable loss and amplifier gain

Note 2: Margin (dB) = Emission level (dBuV/m) – Limit (dBuV/m).

Modulation	VHT80	Test Freq. (MHz)	5775
Polarization	Horizontal	Test Configuration	2

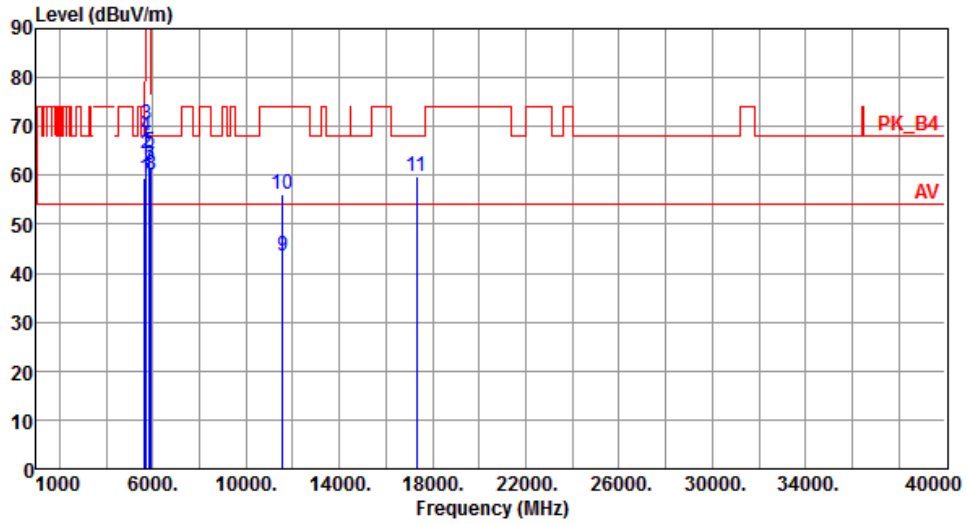

	Freq. MHz	Emission level dBUV/m	Limit dBUV/m	Margin dB	SA reading dBUV	Factor dB	Remark	ANT High cm	Turn Table deg
1	5650.00	59.47	68.20	-8.73	53.56	5.91	Peak	100	42
2	5700.00	64.55	105.20	-40.65	58.32	6.23	Peak	100	42
3	5720.00	70.52	110.80	-40.28	64.24	6.28	Peak	100	42
4	5725.00	68.08	122.20	-54.12	61.79	6.29	Peak	100	42
5	5850.00	64.88	122.20	-57.32	58.21	6.67	Peak	100	42
6	5855.00	62.04	110.80	-48.76	55.36	6.68	Peak	100	42
7	5875.00	61.74	105.20	-43.46	55.02	6.72	Peak	100	42
8	5925.00	60.13	68.20	-8.07	53.31	6.82	Peak	100	42
9	11550.00	43.50	54.00	-10.50	28.15	15.35	Average	100	60
10	11550.00	56.04	74.00	-17.96	40.69	15.35	Peak	100	60
11	17325.00	59.73	68.20	-8.47	42.31	17.42	Peak	100	30

Note 1: Emission Level (dBUV/m) = SA Reading (dBUV/m) + Factor* (dB)

*Factor includes antenna factor , cable loss and amplifier gain

Note 2: Margin (dB) = Emission level (dBUV/m) – Limit (dBUV/m).

Modulation	VHT80	Test Freq. (MHz)	5775
Polarization	Vertical	Test Configuration	2

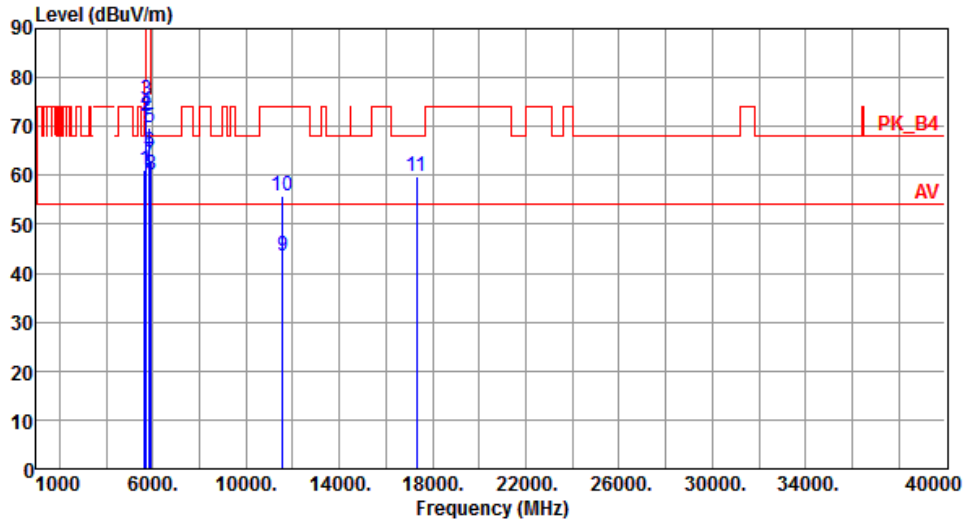

	Freq. MHz	Emission level dBuV/m	Limit dBuV/m	Margin dB	SA reading dBuV	Factor dB	Remark	ANT High cm	Turn Table deg
1	5650.00	60.94	68.20	-7.26	55.03	5.91	Peak	100	73
2	5700.00	72.12	105.20	-33.08	65.89	6.23	Peak	100	73
3	5720.00	75.40	110.80	-35.40	69.12	6.28	Peak	100	73
4	5725.00	73.11	122.20	-49.09	66.82	6.29	Peak	100	73
5	5850.00	69.72	122.20	-52.48	63.05	6.67	Peak	100	73
6	5855.00	64.65	110.80	-46.15	57.97	6.68	Peak	100	73
7	5875.00	62.84	105.20	-42.36	56.12	6.72	Peak	100	73
8	5925.00	60.27	68.20	-7.93	53.45	6.82	Peak	100	73
9	11550.00	43.47	54.00	-10.53	28.12	15.35	Average	100	50
10	11550.00	55.89	74.00	-18.11	40.54	15.35	Peak	100	50
11	17325.00	59.70	68.20	-8.50	42.28	17.42	Peak	100	20

Note 1: Emission Level (dBuV/m) = SA Reading (dBuV/m) + Factor* (dB)

*Factor includes antenna factor , cable loss and amplifier gain

Note 2: Margin (dB) = Emission level (dBuV/m) – Limit (dBuV/m).

3.6 Frequency Stability

3.6.1 Limit of Frequency Stability

Manufacturers of U-NII devices are responsible for ensuring frequency stability such that an emission is maintained within the band of operation under all conditions of normal operation as specified in the user's manual.

3.6.2 Test Procedures

1. The EUT is installed in an environment test chamber with external power source.
2. Set the chamber to operate at 20 centigrade and external power source to output at nominal voltage of EUT.
3. A sufficient stabilization period at each temperature is used prior to each frequency measurement.
4. When temperature is stabled, measure the frequency stability.
5. The test shall be performed under normal and extreme condition for temperature and voltage.

3.6.3 Test Setup

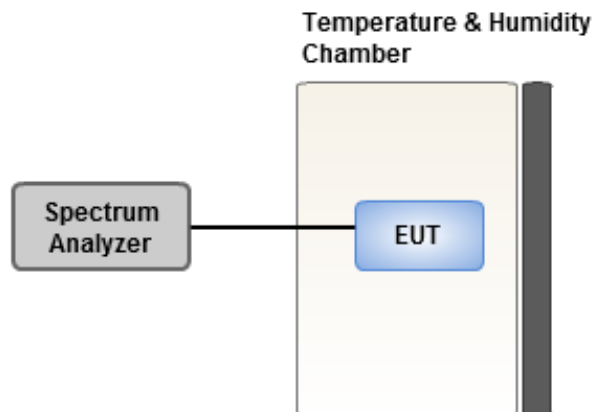

3.6.4 Test Result of Frequency Stability

Frequency: 5200 MHz	Frequency Drift (ppm)			
Temperature (°C)	0 minute	2 minutes	5 minutes	10 minutes
T20°CVmax	-10.52	-10.01	-10.79	-10.53
T20°CVmin	-9.70	-9.88	-9.17	-9.20
T50°CVnom	-15.82	-15.73	-15.57	-15.09
T40°CVnom	-13.77	-13.54	-14.20	-13.80
T30°CVnom	-12.44	-12.25	-12.70	-12.57
T20°CVnom	-10.51	-10.00	-10.55	-10.45
T10°CVnom	-8.09	-7.50	-7.80	-8.23
T0°CVnom	-5.98	-6.08	-5.65	-6.03
T-10°CVnom	-6.22	-6.43	-5.99	-5.90
T-20°CVnom	-5.41	-5.59	-5.11	-5.31
T-30°CVnom	-4.08	-4.35	-3.82	-3.31
Vnom [Vac]: 120	Vmax [Vac]: 138		Vmin [Vac]: 102	
Tnom [°C]: 20	Tmax [°C]: 50		Tmin [°C]: -30	

Frequency: 5785 MHz	Frequency Drift (ppm)			
Temperature (°C)	0 minute	2 minutes	5 minutes	10 minutes
T20°CVmax	0.41	1.06	0.29	0.53
T20°CVmin	0.33	0.31	0.11	0.62
T50°CVnom	-6.46	-5.98	-6.16	-6.21
T40°CVnom	-5.13	-4.70	-4.79	-5.35
T30°CVnom	-4.85	-4.56	-5.31	-4.37
T20°CVnom	-0.17	-0.10	-0.47	-0.53
T10°CVnom	2.49	2.48	2.60	2.48
T0°CVnom	2.31	2.72	2.86	2.70
T-10°CVnom	2.77	3.14	2.69	3.12
T-20°CVnom	3.44	4.20	3.59	3.68
T-30°CVnom	4.89	5.01	4.85	5.25
Vnom [Vac]: 120	Vmax [Vac]: 138		Vmin [Vac]: 102	
Tnom [°C]: 20	Tmax [°C]: 50		Tmin [°C]: -30	

4 Test laboratory information

Established in 2012, ICC provides foremost EMC & RF Testing and advisory consultation services by our skilled engineers and technicians. Our services employ a wide variety of advanced edge test equipment and one of the widest certification extents in the business.

International Certification Corp (EMC and Wireless Communication Laboratory), it is our definitive objective is to institute long term, trust-based associations with our clients. The expectation we set up with our clients is based on outstanding service, practical expertise and devotion to a certified value structure. Our passion is to grant our clients with best EMC / RF services by oriented knowledgeable and accommodating staff.

Our Test sites are located at Linkou District and Kwei Shan District. Location map can be found on our website <http://www.icertifi.com.tw>.

Linkou

Tel: 886-2-2601-1640

No. 30-2, Ding Fwu Tsuen, Lin
Kou District, New Taipei City,
Taiwan, R.O.C.

Kwei Shan

Tel: 886-3-271-8666

No. 3-1, Lane 6, Wen San 3rd St.,
Kwei Shan District, Tao Yuan City
333, Taiwan, R.O.C.

Kwei Shan Site II

Tel: 886-3-271-8640

No. 14-1, Lane 19, Wen San 3rd
St., Kwei Shan District, Tao Yuan
City 333, Taiwan, R.O.C.

If you have any suggestion, please feel free to contact us as below information.

Tel: 886-3-271-8666

Fax: 886-3-318-0155

Email: ICC_Service@icertifi.com.tw

==END==