

# FCC DFS Test Report

**FCC ID** : 2AAS9-2251XW  
**Equipment** : Dual Radio 802.11a/n+b/g/n Outdoor Access Point  
**Model No.** : BW2251  
**Brand Name** : BROWAN  
**Applicant** : BROWAN COMMUNICATIONS Co., Ltd.  
**Address** : No. 15-1, Zhonghua Rd., Hsinchu Industrial Park, Hukou, Hsinchu, Taiwan, R. O. C.  
**Manufacturer** : Gemtek Technology Co., Ltd.  
**Address** : No. 15-1, Zhonghua Rd., Hsinchu Industrial Park, Hukou, Hsinchu, Taiwan, R. O. C.  
**Standard** : 47 CFR FCC Part 15.407  
**Received Date** : Aug. 21, 2013  
**Tested Date** : Nov. 04 ~ Dec. 25, 2013  
**Operating Mode** : Master

We, International Certification Corp., would like to declare that the tested sample has been evaluated and in compliance with the requirement of the above standards. The test results contained in this report refer exclusively to the product. It may be duplicated completely for legal use with the approval of the applicant. It shall not be reproduced except in full without the written approval of our laboratory.

Approved & Reviewed by:

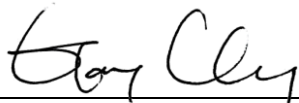

Gary Chang / Manager



Testing Laboratory  
2732

---

## Table of Contents

<b>1</b>	<b>GENERAL DESCRIPTION .....</b>	<b>5</b>
1.1	Information.....	5
1.2	Support Equipment List .....	5
1.3	The Equipment List .....	6
1.4	Testing Condition .....	6
1.5	Test Standards .....	6
<b>2</b>	<b>TECHNICAL REQUIREMENTS FOR DFS.....</b>	<b>7</b>
2.1	Applicability of DFS Requirements.....	7
2.2	DFS Detection Thresholds and Response Requirement .....	8
2.3	Radar Test Waveforms .....	9
<b>3</b>	<b>DFS TEST RESULT .....</b>	<b>12</b>
3.1	DFS Detection Threshold levels.....	12
3.2	UNII Detection Bandwidth .....	14
3.3	Channel Availability Check (CAC).....	18
3.4	Uniform Channel Spreading .....	21
3.5	In-Service Monitoring .....	22
3.6	Statistical Performance Check .....	28
<b>4</b>	<b>TEST LABORATORY INFORMATION .....</b>	<b>56</b>

---

## Release Record

Report No.	Version	Description	Issued Date
FZ390501	Rev. 01	Initial issue	Feb. 14, 2014

## Summary of Test Results

FCC Rules		Description of Test	Result
FCC 15.407	FCC 06-96	Non-Occupancy Period	Pass
FCC 15.407	FCC 06-96	DFS Detection Threshold	Pass
FCC 15.407	FCC 06-96	Channel Availability Check Time	Pass
FCC 15.407	FCC 06-96	Uniform Spreading	Pass
FCC 15.407	FCC 06-96	U-NII Detection Bandwidth	Pass
FCC 15.407	FCC 06-96	Channel Closing Transmission Time	Pass
FCC 15.407	FCC 06-96	Channel Move Time	Pass

# 1 General Description

## 1.1 Information

### 1.1.1 Specification of the Equipment under Test (EUT)

<b>Frequency Range (GHz)</b>	5.15~5.25, 5.25~5.35, 5.47~5.725, 5.725~5.85
<b>Wireless Function</b>	11a / n HT20 / n HT40
<b>Operating Mode at DFS Band</b>	Master
<b>Firmware / Software Version</b>	BW2251.BRO.2.0.05 FCC

### 1.1.2 Antenna Details

Ant. No.	Model	Type	Gain (dBi)	Connector
1	BA5071	Omni-directional	5	N type

### 1.1.3 Highest and Possible Lowest Power Level

Highest Power Level and Possible Lowest Power Level					
Frequency Band	Modulation Mode	Highest RF Output Power (dBm)	Highest EIRP (dBm)	Lowest RF Output Power (dBm)	Lowest EIRP (dBm)
5.3G	a	20.86	25.86	14.86	19.86
5.6G	a	21.04	26.04	15.04	20.04
5.3G	n(HT20)	21.19	26.19	15.19	20.19
5.6G	n(HT20)	21.17	26.17	15.17	20.17
5.3G	n(HT40)	23.63	28.63	17.63	22.63
5.6G	n(HT40)	23.95	28.95	17.95	22.95

Note 1: 5.3G: 5.25-5.35GHz band, 5.6G: 5.47-5.725GHz band

Note 2: EUT employ a TPC mechanism and TPC have the capability to operate at least 6 dB below highest RF output power.

## 1.2 Support Equipment List

Support Equipment List				
No.	Equipment	Brand Name	Model Name	FCC ID
1	Client	Buffalo	WLI-UC-AG300N	FDI-09102079-0
2	Notebook	DELL	LATITUDE-E6430	9ZFB4X1
3	Notebook	DELL	LATITUDE-E5420	B6FV9T1

### 1.3 The Equipment List

Test Site	DF01-WS				
Instrument	Manufacturer	Model No.	Serial No.	Calibration Date	Calibration Until
Spectrum Analyzer	R&S	FSV40	101499	Jan. 28, 2013	Jan. 27, 2014
Horn Antenna 1G-18G	ETS-LINDGREN	3115	00149268	Sep. 27, 2013	Sep. 26, 2014
RF Cable	HUBER+SUHNER	SUCOFLEX_104	MY15686/4	Dec. 23, 2013	Dec. 22, 2014
RF Cable	HUBER+SUHNER	SUCOFLEX_104	296081/4	Dec. 23, 2013	Dec. 22, 2014
RF Cable	HUBER+SUHNER	SUCOFLEX_104	500199/4	Dec. 23, 2013	Dec. 22, 2014
RF Cable	HUBER+SUHNER	SUCOFLEX_104	500202/4	Dec. 23, 2013	Dec. 22, 2014
RF Cable	HUBER+SUHNER	SUCOFLEX_104	296088/4	Dec. 23, 2013	Dec. 22, 2014
RF Cable	HUBER+SUHNER	SUCOFLEX_104	329023/4	Dec. 23, 2013	Dec. 22, 2014
RF Cable	HUBER+SUHNER	SUCOFLEX_104	329021/4	Dec. 23, 2013	Dec. 22, 2014
Vector signal generator	R&S	SMU200A	102098	Nov. 12, 2013	Nov. 11, 2014

Note: Calibration Interval of instruments listed above is one year.

### 1.4 Testing Condition

Test Item	Test Site	Ambient Condition	Tested By
DFS	DF01-WS	26°C / 66%	Alex Huang

### 1.5 Test Standards

According to the specification of EUT, the EUT must comply with following standards and KDB documents.

47 CFR FCC Part 15.407

FCC 06-96 A1

## 2 Technical Requirements for DFS

### 2.1 Applicability of DFS Requirements

#### 2.1.1 Applicability of DFS Requirements Prior to use of a Channel

Requirement	Operational Mode		
	Master	Client Without Radar Detection	Client With Radar Detection
Non-Occupancy Period	Yes	Not required	Yes
DFS Detection Threshold	Yes	Not required	Yes
Channel Availability Check Time	Yes	Not required	Not required
Uniform Spreading	Yes	Not required	Not required
U-NII Detection Bandwidth	Yes	Not required	Yes

#### 2.1.2 Applicability of DFS Requirements during Normal Operation

Requirement	Operational Mode		
	Master	Client Without Radar Detection	Client With Radar Detection
DFS Detection Threshold	Yes	Not required	Yes
Channel Closing Transmission Time	Yes	Yes	Yes
Channel Move Time	Yes	Yes	Yes
U-NII Detection Bandwidth	Yes	Not required	Yes

## 2.2 DFS Detection Thresholds and Response Requirement

Below table provides the DFS Detection Thresholds for Master Devices as well as Client Devices incorporating In-Service Monitoring.

### DFS Detection Thresholds for Master Devices and Client Devices With Radar Detection.

Maximum Transmit Power	Value (See Notes 1 and 2)
≥ 200 milliwatt	-64 dBm
< 200 milliwatt	-62 dBm

Note:

- 1) This is the level at the input of the receiver assuming a 0 dBi receive antenna.
- 2) Throughout these test procedures an additional 1 dB has been added to the amplitude of the test transmission waveforms to account for variations in measurement equipment. This will ensure that the test signal is at or above the detection threshold level to trigger a DFS response.

### DFS Response Requirement Values

Parameter	Value
Non-occupancy period	Minimum 30 minutes.
Channel Availability Check Time	60 seconds.
Channel Move Time	10 seconds. (See Note 1.)
Channel Closing Transmission Time	200 milliseconds + an aggregate of 60 milliseconds over remaining 10 second period. (See Notes 1 and 2.)
U-NII Detection Bandwidth	Minimum 80% of the U- NII 99% transmission power bandwidth. (See Note 3.)

Note:

- 1) The instant that the Channel Move Time and the Channel Closing Transmission Time begins is as follows:
  - For the Short Pulse Radar Test Signals this instant is the end of the Burst.
  - For the Frequency Hopping radar Test Signal, this instant is the end of the last radar Burst generated.
  - For the Long Pulse Radar Test Signal this instant is the end of the 12 second period defining the Radar Waveform.
- 2) The Channel Closing Transmission Time is comprised of 200 milliseconds starting at the beginning of the Channel Move Time plus any additional intermittent control signals required to facilitate a Channel move (an aggregate of 60 milliseconds) during the remainder of the 10 second period. The aggregate duration of control signals will not count quiet periods in between transmissions.
- 3) During the U-NII Detection Bandwidth detection test, radar type 1 is used and for each frequency step the minimum percentage of detection is 90 percent. Measurements are performed with no data traffic.



## 2.3 Radar Test Waveforms

This section provides the parameters for required test waveforms, minimum percentage of successful detections, and the minimum number of trials that must be used for determining DFS conformance. Step intervals of 0.1 microsecond for Pulse Width, 1 microsecond for PRI, 1 MHz for chirp width and 1 for the number of pulses will be utilized for the random determination of specific test waveforms.

### 2.3.1 Short Pulse Radar Test Waveforms

Radar Type	Pulse Width (µsec)	PRI (µsec)	Number of Pulses	Minimum Percentage of Successful Detection	Minimum Number of Trials
1	1	1428	18	60%	30
2	1-5	150-230	23-29	60%	30
3	6-10	200-500	16-18	60%	30
4	11-20	200-500	12-16	60%	30
Aggregate (Radar Types 1-4)				80%	120

A minimum of 30 unique waveforms are required for each of the Short Pulse Radar Types 2 through 4. For Short Pulse Radar Type 1, the same waveform is used a minimum of 30 times. If more than 30 waveforms are used for Short Pulse Radar Types 2 through 4, then each additional waveform must also be unique and not repeated from the previous waveforms. The aggregate is the average of the percentage of successful detections of Short Pulse Radar Types 1-4.

### 2.3.2 Long Pulse Radar Test Waveform

Radar Type	Pulse Width (µsec)	Chirp Width (MHz)	PRI (µsec)	Number of Pulses per Burst	Number of Bursts	Minimum Percentage of Successful Detection	Minimum Number of Trials
5	50-100	5-20	1000-2000	1-3	8-20	80%	30

The parameters for this waveform are randomly chosen. Thirty unique waveforms are required for the Long Pulse Radar Type waveforms. If more than 30 waveforms are used for the Long Pulse Radar Type waveforms, then each additional waveform must also be unique and not repeated from the previous waveforms.

### 2.3.3 Frequency Hopping Radar Test Waveform

Radar Type	Pulse Width (µsec)	PRI (µsec)	Pulses per Hop	Hopping Rate (kHz)	Hopping Sequence Length (msec)	Minimum Percentage of Successful Detection	Minimum Number of Trials
6	1	333	9	0.333	300	70%	30

For the Frequency Hopping Radar Type, the same Burst parameters are used for each waveform. The hopping sequence is different for each waveform and a 100-length segment is selected from the hopping sequence defined by the following algorithm

### 2.3.4 Radar waveform generation

A single R&S SMU200A Vector Signal Generator is used for the DFS signal generation. This instrument is capable of generating all the above waveforms with Pulse Sequencer Software. The R&S Pulse Sequencer Software comes as a stand-alone PC based software with preconfigured project files for DFS. It simplifies the generation of all required waveforms and offers a one box solution

### 2.3.5 Calibration Setup for DFS Detection Threshold levels

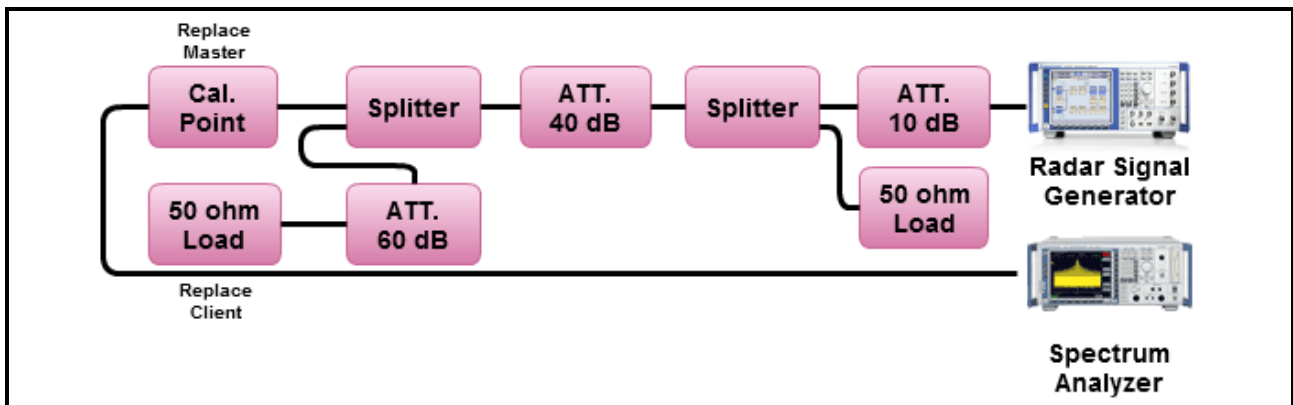

### 2.3.6 DFS Test Setup

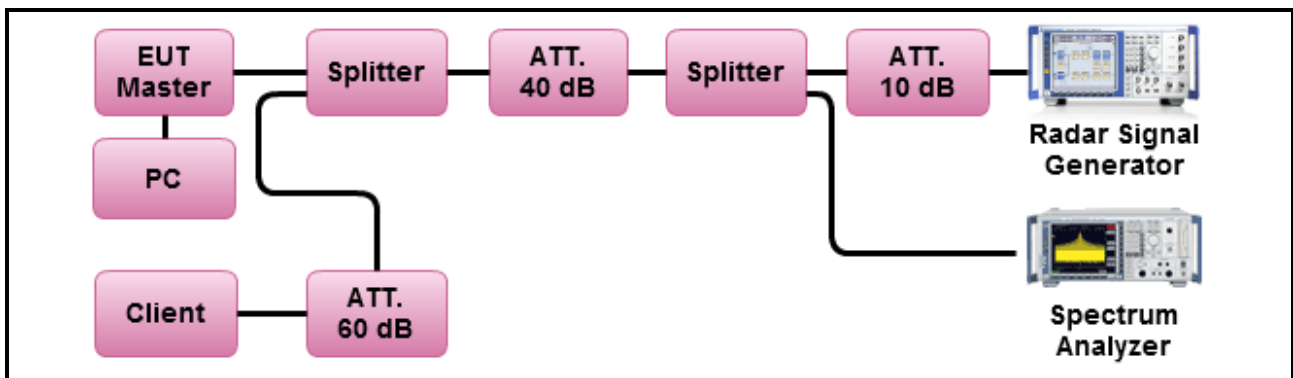

### 2.3.7 Channel Loading/Data Streaming

<input checked="" type="checkbox"/>	IP Based (Load Based) - stream the test file from the Master to the Client.
<input type="checkbox"/>	The client device is link with the master device and plays the WAV audio file from master device to client device. Test file download in NTIA website ( <a href="http://ntiacsd.ntia.doc.gov/dfs/">http://ntiacsd.ntia.doc.gov/dfs/</a> )
<input checked="" type="checkbox"/>	The client device is link with the master device and plays the MPEG file (6 1/2 Magic Hours) from master device to client device. Test file download in NTIA website ( <a href="http://ntiacsd.ntia.doc.gov/dfs/">http://ntiacsd.ntia.doc.gov/dfs/</a> )
<input type="checkbox"/>	Alternative streaming e.g., FTP with about 17 to 20% loading and submit proposal to FCC.
<input type="checkbox"/>	Frame Based - stream the test file from the Master to the Client.
<input type="checkbox"/>	fixed talk/listen ratio, set the ratio to 45%/55%

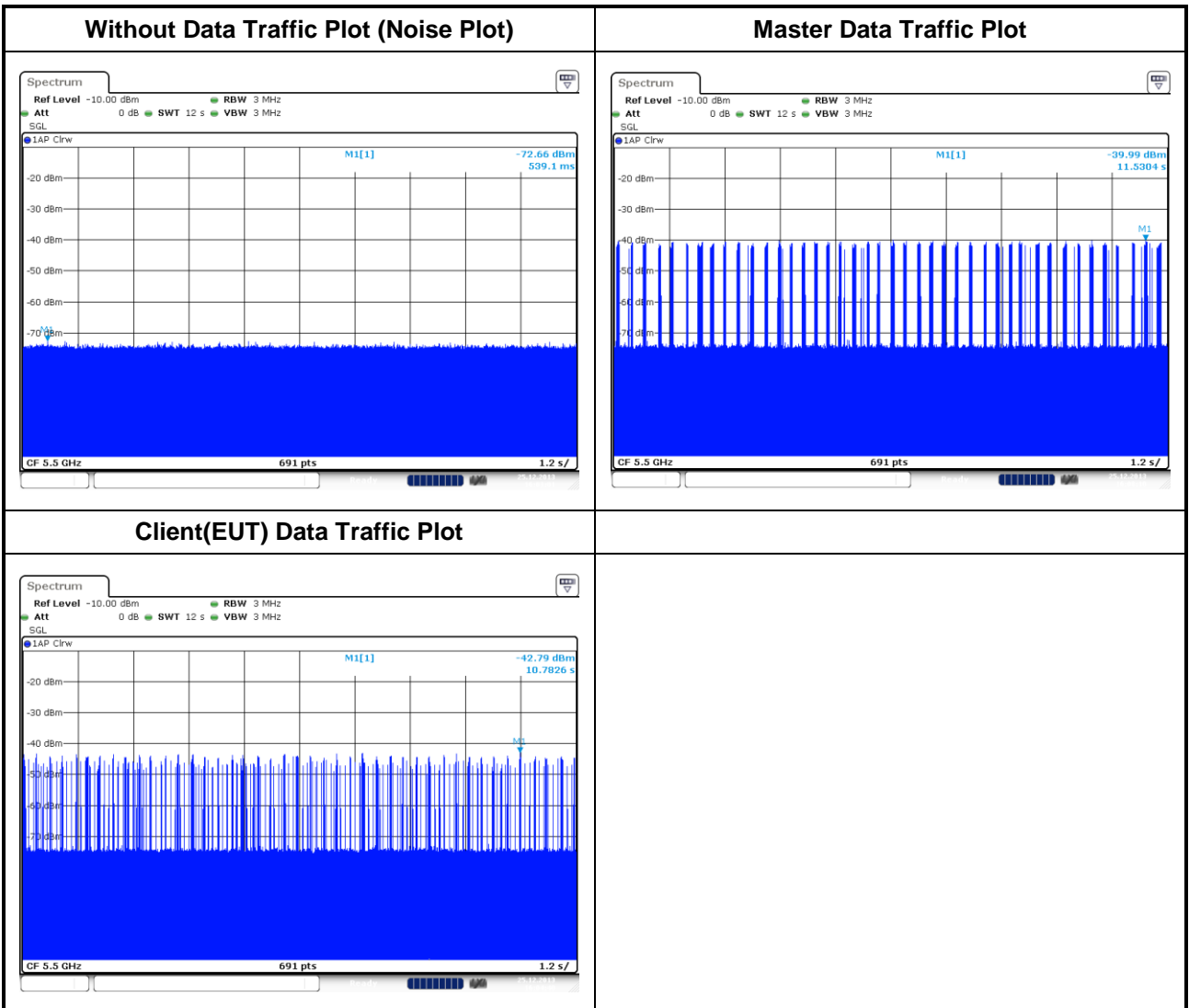

### 3 DFS test result

#### 3.1 DFS Detection Threshold levels

Master DFS Threshold Level	
DFS Threshold level: -58 dBm	<input checked="" type="checkbox"/> at the antenna connector(-58 dBm conducted)
	<input checked="" type="checkbox"/> in front of the antenna (-58 dBm e.i.r.p.)
The Interference <b>Radar Detection Threshold Level</b> is $(-64\text{dBm}) + (5 \text{ [dBi]}) + \{1 \text{ dB}\} = -58 \text{ dBm}$ . That had been taken into account the master output power range and antenna gain.	

### Calibration Plots

**Radar #1 DFS detection threshold level**

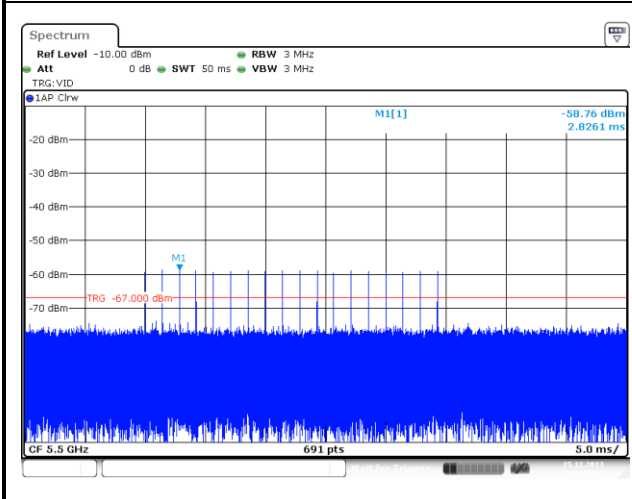

**Radar #4 DFS detection threshold level**

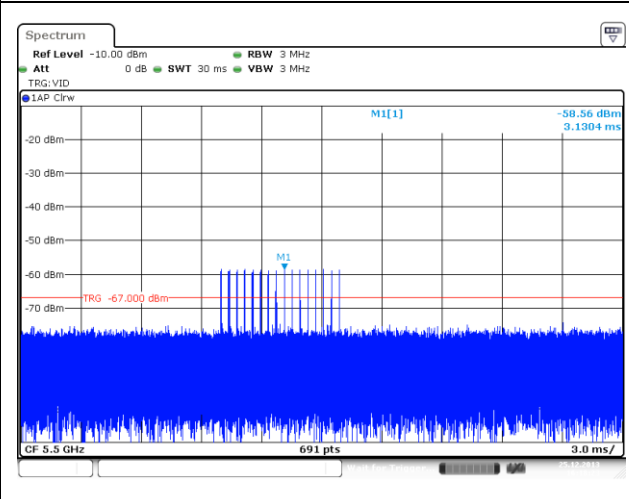

**Radar #2 DFS detection threshold level**

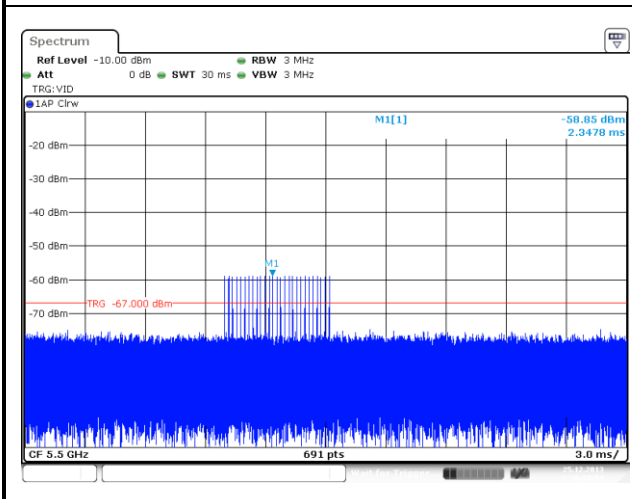

**Radar #5 DFS detection threshold level**

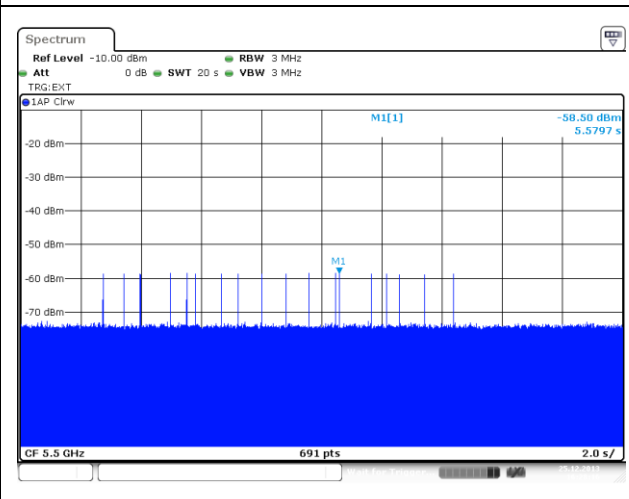

**Radar #3 DFS detection threshold level**

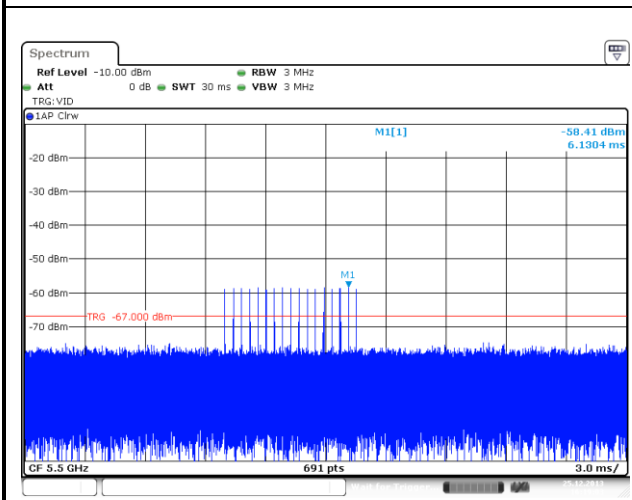

**Radar #6 DFS detection threshold level**

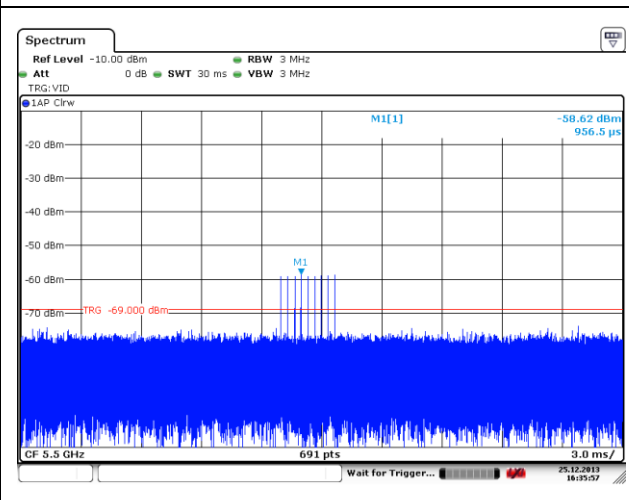

## 3.2 UNII Detection Bandwidth

### 3.2.1 UNII Detection Bandwidth Limit

Channel Bandwidth (MHz)	99% Power Bandwidth (MHz)	UNII Detection Bandwidth (MHz)
20	17.58	14.064
40	36.09	28.872

UNII Detection Bandwidth is minimum 80% of the 99% power bandwidth. A single radar Burst is generated for a minimum of 10 trials, and the response of the UUT is noted. The UUT must detect the Radar Waveform 90% or more of the time.

### 3.2.2 Test Procedures

#### Test Method

- Refer as FCC 06-96, clause 7.8.1 for UNII Detection Bandwidth test. During the U-NII Detection Bandwidth detection test, radar type 1 is used and for each frequency step the minimum percentage of detection is 90 percent. Measurements are performed with no data traffic. The EUT is set up as a standalone device (no associated Client and no traffic). The radar frequency is increased in 1 MHz steps, repeating the above test sequence, until the detection rate falls below 90%. The highest frequency at which detection is greater than or equal to 90% is denoted as  $F_H$ . The radar frequency is decreased in 1 MHz steps, repeating the above test sequence, until the detection rate falls below 90%. The lowest frequency at which detection is greater than or equal to 90% is denoted as  $F_L$ . UNII Detection Bandwidth =  $F_H - F_L$ .

#### Emission Bandwidth Plots

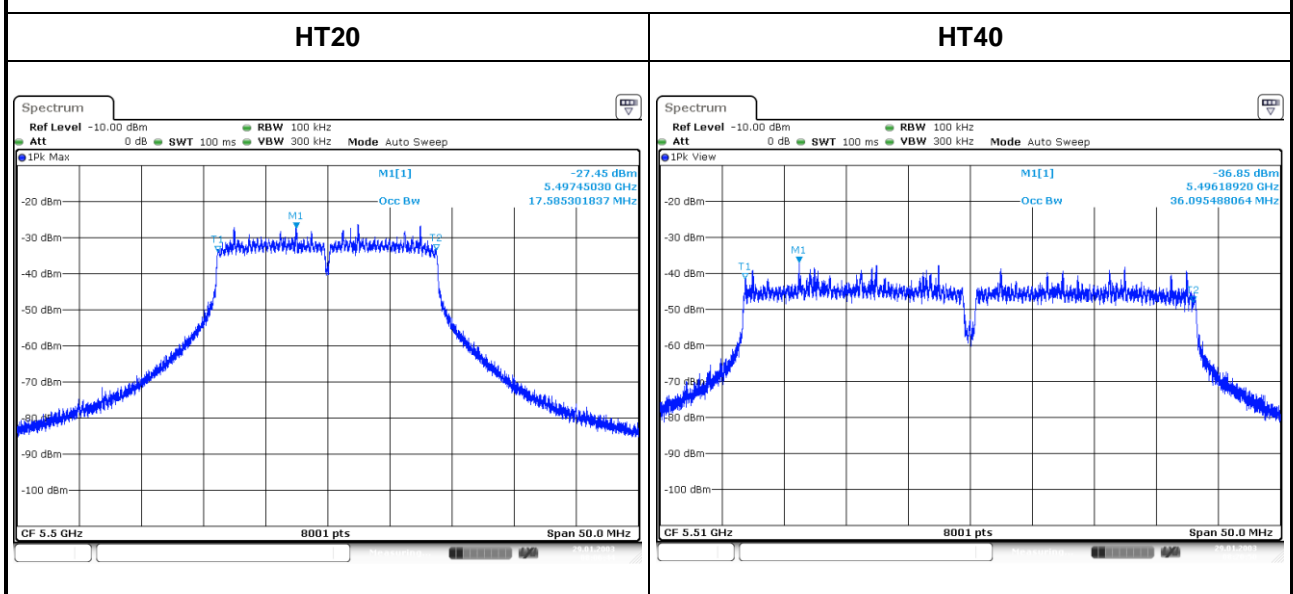

### 3.2.3 Test Result of UNII Detection Bandwidth

#### Channel Bandwidth 20MHz

UNII Detection Bandwidth Result												
Radar Type		1										
Channel Bandwidth (MHz)		20										
Radar Freq. (MHz)	DFS Detection Trials (1=Detection, 0= No Detection)										Detection Rate (%)	Detection Bandwidth(MHz)
	1	2	3	4	5	6	7	8	9	10		
5490	1	1	1	1	1	1	1	1	1	1	100	20
5491	1	1	1	1	1	1	1	1	1	1	100	
5492	1	1	1	1	1	1	1	1	1	1	100	
5493	1	1	1	1	1	1	1	1	1	1	100	
5494	1	1	1	1	1	1	1	1	1	1	100	
5495	1	1	1	1	1	1	1	1	1	1	100	
5496	1	1	1	1	1	1	1	1	1	1	100	
5497	1	1	1	1	1	1	1	1	1	1	100	
5498	1	1	1	1	1	1	1	1	1	1	100	
5499	1	1	1	1	1	1	1	1	1	1	100	
5500	1	1	1	1	1	1	1	1	1	1	100	
5501	1	1	1	1	1	1	1	1	1	1	100	
5502	1	1	1	1	1	1	1	1	1	1	100	
5503	1	1	1	1	1	1	1	1	1	1	100	
5504	1	1	1	1	1	1	1	1	1	1	100	
5505	1	1	1	1	1	1	1	1	1	1	100	
5506	1	1	1	1	1	1	1	1	1	1	100	
5507	1	1	1	1	1	1	1	1	1	1	100	
5508	1	1	1	1	1	1	1	1	1	1	100	
5509	1	1	1	1	1	1	1	1	1	1	100	
5510	1	1	1	1	1	1	1	1	1	1	100	
<b>Limit (MHz)</b>												<b>15</b>
<b>Result</b>												<b>Complied</b>

**Channel Bandwidth 40MHz**

UNII Detection Bandwidth Result												
Radar Type		1										
Channel Bandwidth (MHz)		40										
Radar Freq. (MHz)	DFS Detection Trials (1=Detection, 0= No Detection)										Detection Rate (%)	Detection Bandwidth (MHz)
	1	2	3	4	5	6	7	8	9	10		
5490	1	1	1	1	1	1	1	1	1	1	100	40
5491	1	1	1	1	1	1	1	1	1	1	100	
5492	1	1	1	1	1	1	1	1	1	1	100	
5493	1	1	1	1	1	1	1	1	1	1	100	
5494	1	1	1	1	1	1	1	1	1	1	100	
5495	1	1	1	1	1	1	1	1	1	1	100	
5496	1	1	1	1	1	1	1	1	1	1	100	
5497	1	1	1	1	1	1	1	1	1	1	100	
5498	1	1	1	1	1	1	1	1	1	1	100	
5499	1	1	1	1	1	1	1	1	1	1	100	
5500	1	1	1	1	1	1	1	1	1	1	100	
5501	1	1	1	1	1	1	1	1	1	1	100	
5502	1	1	1	1	1	1	1	1	1	1	100	
5503	1	1	1	1	1	1	1	1	1	1	100	
5504	1	1	1	1	1	1	1	1	1	1	100	
5505	1	1	1	1	1	1	1	1	1	1	100	
5506	1	1	1	1	1	1	1	1	1	1	100	
5507	1	1	1	1	1	1	1	1	1	1	100	
5508	1	1	1	1	1	1	1	1	1	1	100	
5509	1	1	1	1	1	1	1	1	1	1	100	
5510	1	1	1	1	1	1	1	1	1	1	100	
5511	1	1	1	1	1	1	1	1	1	1	100	
5512	1	1	1	1	1	1	1	1	1	1	100	
5513	1	1	1	1	1	1	1	1	1	1	100	
5514	1	1	1	1	1	1	1	1	1	1	100	
5515	1	1	1	1	1	1	1	1	1	1	100	
5516	1	1	1	1	1	1	1	1	1	1	100	
5517	1	1	1	1	1	1	1	1	1	1	100	
5518	1	1	1	1	1	1	1	1	1	1	100	
5519	1	1	1	1	1	1	1	1	1	1	100	
5520	1	1	1	1	1	1	1	1	1	1	100	
5521	1	1	1	1	1	1	1	1	1	1	100	
5522	1	1	1	1	1	1	1	1	1	1	100	
5523	1	1	1	1	1	1	1	1	1	1	100	
5524	1	1	1	1	1	1	1	1	1	1	100	
5525	1	1	1	1	1	1	1	1	1	1	100	
5526	1	1	1	1	1	1	1	1	1	1	100	
5527	1	1	1	1	1	1	1	1	1	1	100	



UNII Detection Bandwidth Result													
Radar Type		1											
Channel Bandwidth (MHz)		40											
Radar Freq. (MHz)	DFS Detection Trials (1=Detection, 0= No Detection)										Detection Rate (%)	Detection Bandwidth (MHz)	
	1	2	3	4	5	6	7	8	9	10			
5528	1	1	1	1	1	1	1	1	1	1	1	100	
5529	1	1	1	1	1	1	1	1	1	1	1	100	
5530	1	1	1	1	1	1	1	1	1	1	1	100	
Limit (MHz)												29	
Result												Complied	

### 3.3 Channel Availability Check (CAC)

#### 3.3.1 Channel Availability Check Limit

<b>Channel Availability Check Limit</b>	
<input checked="" type="checkbox"/>	The EUT shall perform a Channel Availability Check to ensure that there is no radar operating on the channel. After power-up sequence, receive at least 1 minute (60 sec) on the intended operating frequency.

#### 3.3.2 Test Procedures

<b>Test Method</b>	
<input checked="" type="checkbox"/>	Refer as FCC 06-96, clause 7.8.2.1 for Initial Channel Availability Check Time. The EUT does not emit beacon, control, or data signals on the test Channel until the power-up sequence has been completed and the UNII device checks for Radar Waveforms for one minute on the test Channel. This test does not use any Radar Waveforms.
<input checked="" type="checkbox"/>	Refer as FCC 06-96 clause 7.8.2.2 for Radar Burst at the Beginning of the Channel Availability Check Time. To verify successful radar detection on the selected Channel during a period equal to the Beginning of the Channel Availability Check Time.
<input checked="" type="checkbox"/>	Refer as FCC 06-96 clause 7.8.2.3 for Radar Burst at the End of the Channel Availability Check Time. To verify successful radar detection on the selected Channel during a period equal to the End of the Channel Availability Check Time.



### Channel Availability Check Time Result

Modulation Mode	Freq. (MHz)	Radar TypeSignal	Beginning CAC of Timing of radar burst (sec)	End CAC of Timing of radar burst (sec)	DFS Triggered (Yes/No)
HT20	5500	1	6	54	Yes
<b>Result</b>			<b>Complied</b>		

### Beginning CAC of 200s Timing Plot

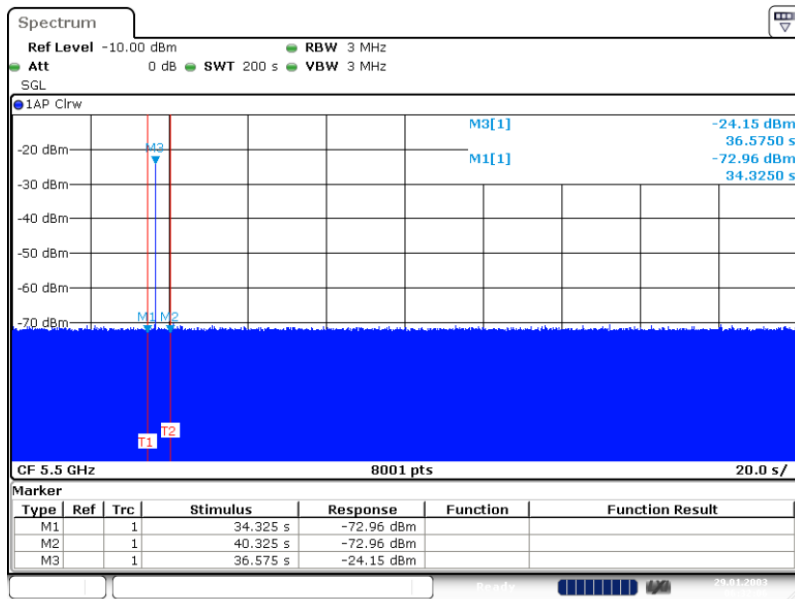

### End CAC of 200s Timing Plot

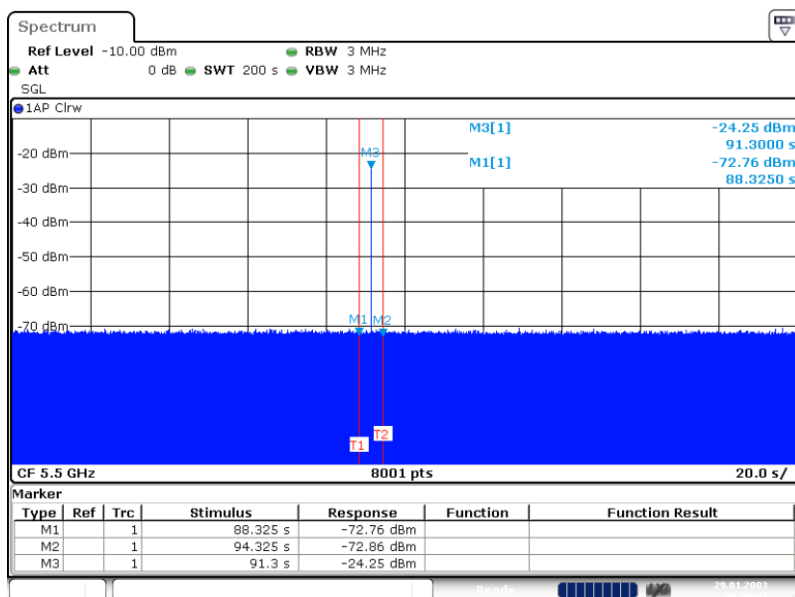

### 3.4 Uniform Channel Spreading

#### 3.4.1 Uniform Channel Spreading Limit

Uniform Channel Spreading Limit	
<input checked="" type="checkbox"/>	The spreading of U-NII device Operating Channels over the 5250-5350 MHz and/or 5470-5725 MHz bands to avoid dense clusters of devices operating on the same Channel

#### 3.4.2 Test Result

The channel is selected by random sequence and the channel will be marked after detecting radar signal. Only non-marked channel will be selected by random sequence.

### 3.5 In-Service Monitoring

#### 3.5.1 In-service Monitoring Limit

In-service Monitoring Limit	
Channel Move Time	10 sec
Channel Closing Transmission Time	200 ms + an aggregate of 60 ms over remaining 10 sec periods.
Non-occupancy period	Minimum 30 minutes

#### 3.5.2 Test Procedures

Test Method
<input checked="" type="checkbox"/> Refer as FCC 06-96, clause 7.8.3 verified during In-Service Monitoring; Channel Closing Transmission Time, Channel Move Time. Client Device will associate with the EUT. Observe the transmissions of the EUT at the end of the radar Burst on the Operating Channel for duration greater than 10 seconds. Measure and record the transmissions from the EUT during the observation time (Channel Move Time). Compare the Channel Move Time and Channel Closing Transmission Time limits.
<input checked="" type="checkbox"/> Refer as FCC 06-96, clause 8.3 verified during In-Service Monitoring; Channel Closing Transmission Time, Channel Move Time. One 10 sec plot needs to be reported for the Short Pulse Radar Types 1-4 and one for the Long Pulse Radar Type in a 22 sec plot. And zoom-in a 600 ms plot verified channel closing time for the aggregate transmission time starting from 200ms after the end of the radar signal to the completion of the channel move.
<input checked="" type="checkbox"/> Refer as FCC 06-96, clause 7.8.3 verified during In-Service Monitoring; Non-Occupancy Period. Client Device will associate with the EUT. Observe the transmissions of the EUT at the end of the radar Burst on the Operating Channel for duration greater than 10 seconds. Measure and record the transmissions from the EUT during the observation time (Non-Occupancy Period). Compare the Non-Occupancy Period limits.

### 3.5.3 Test Result of Channel Closing Transmission and Channel Move Time

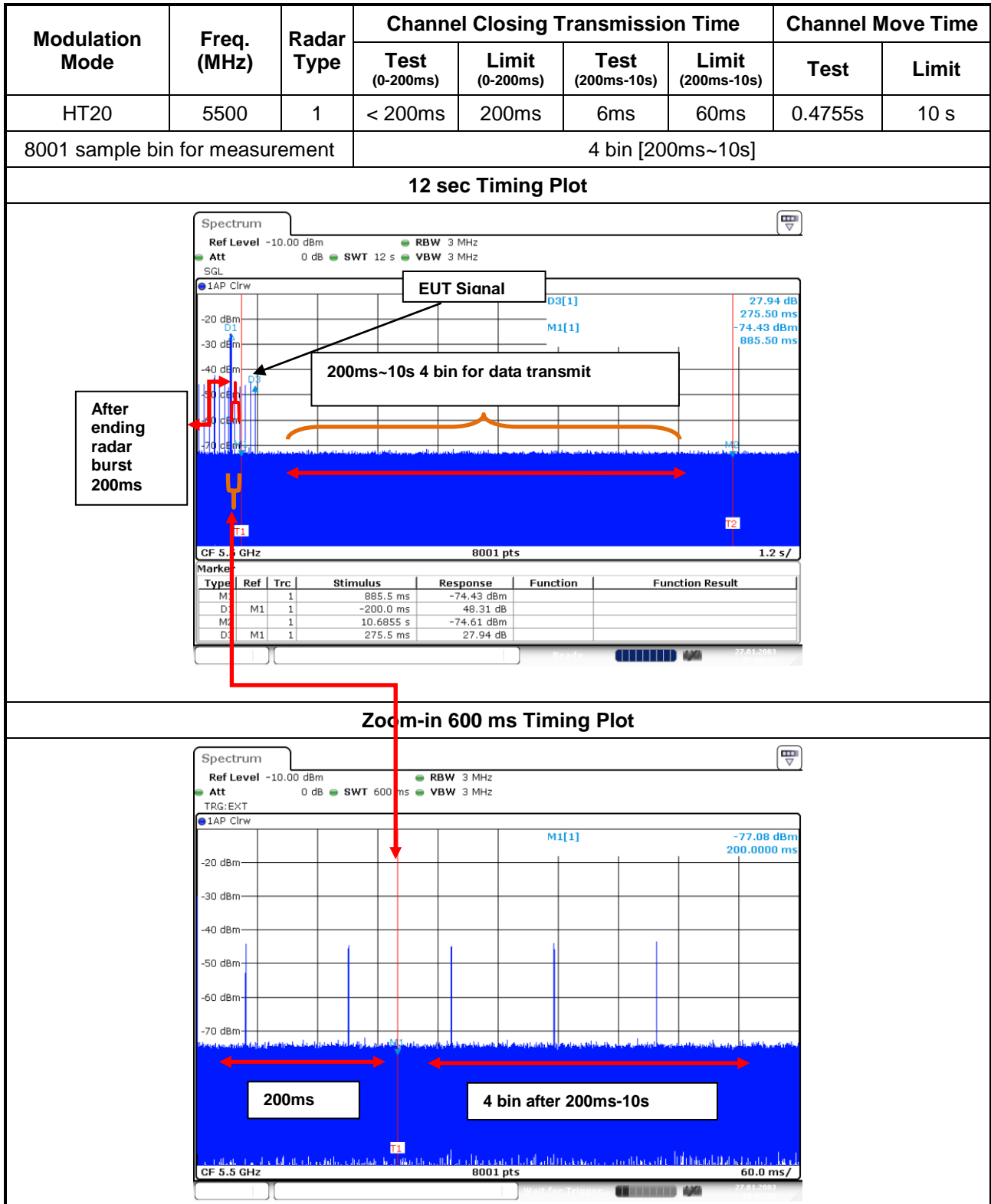

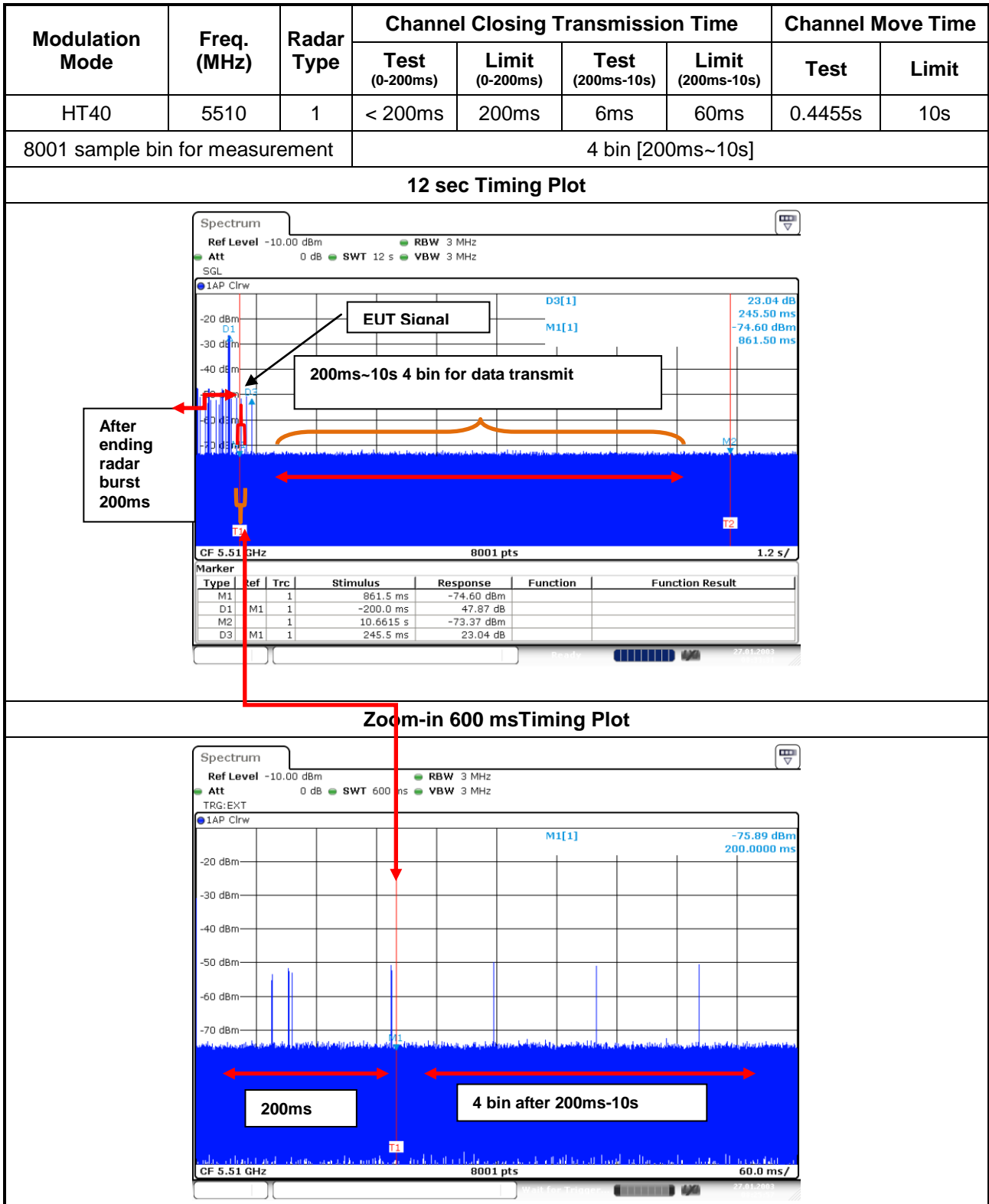



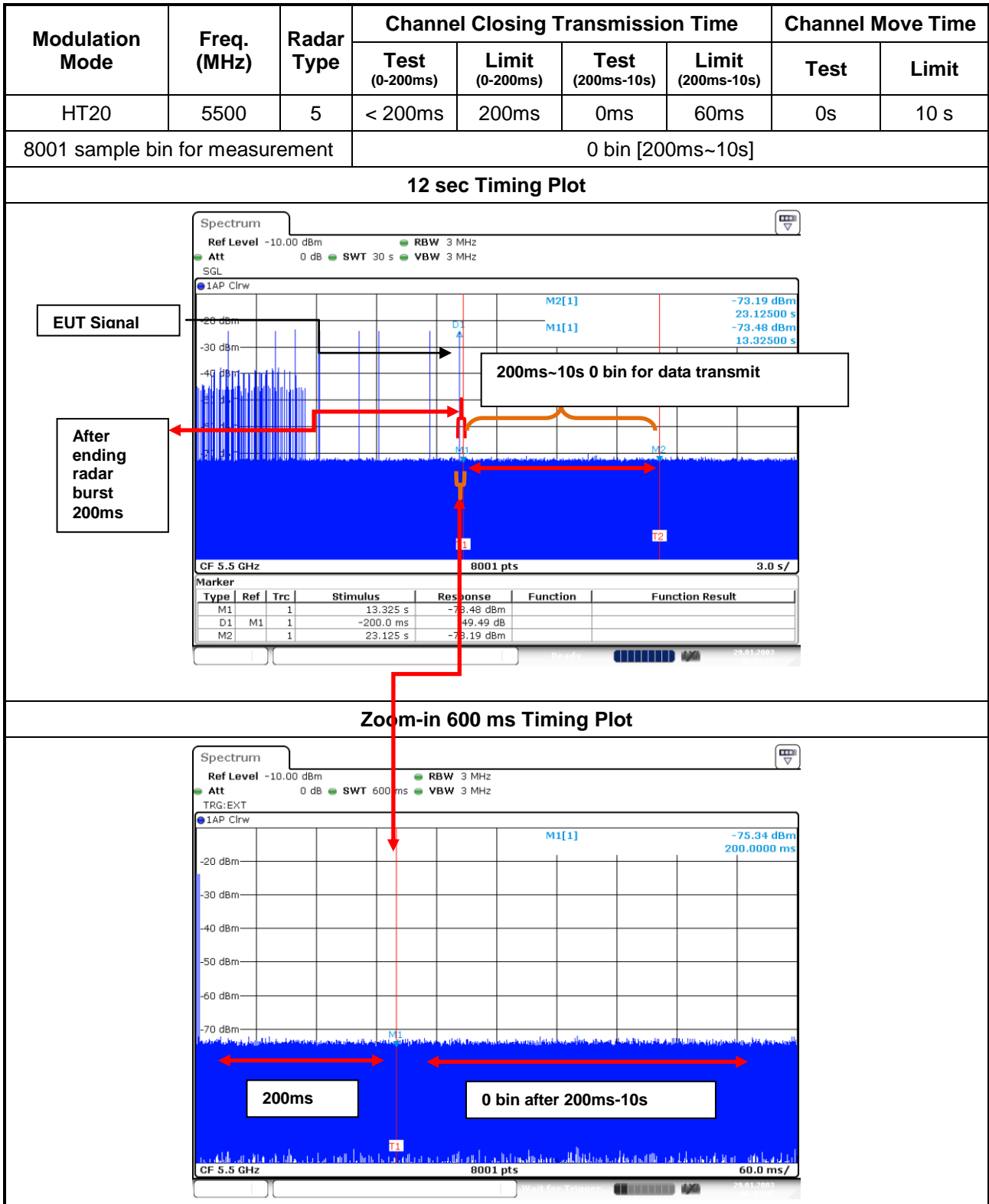

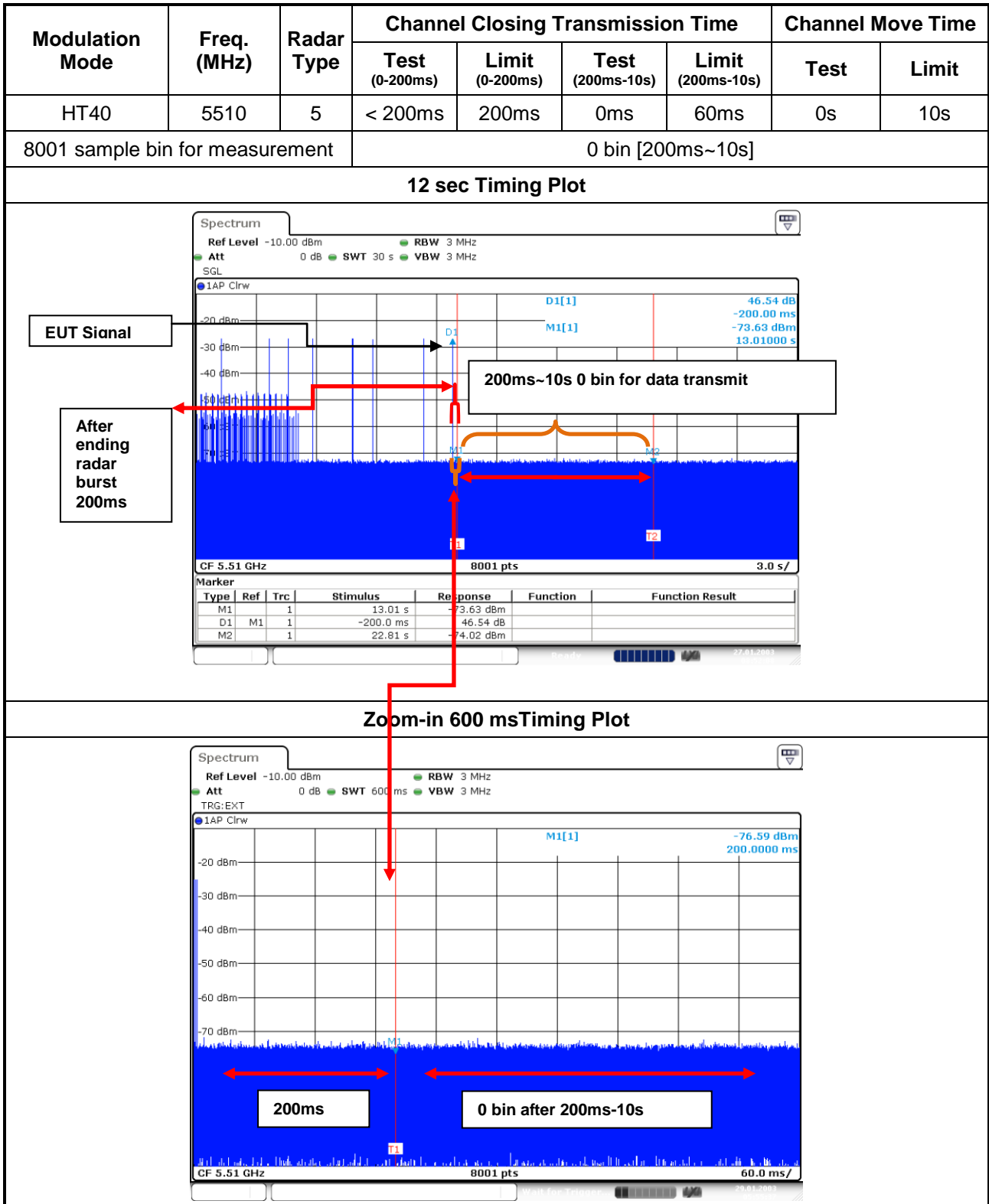

### 3.5.4 Test Result of Non-Occupancy

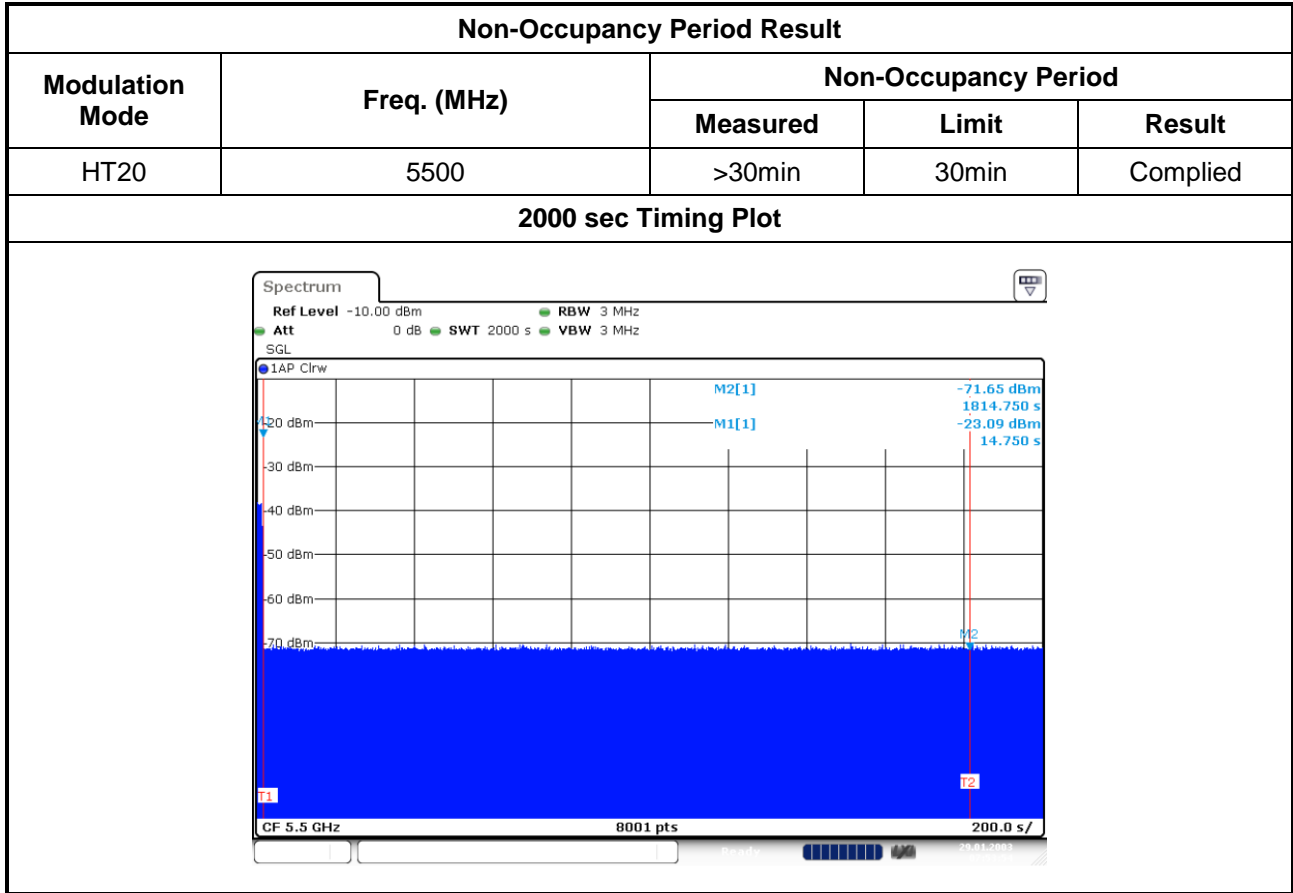

### 3.6 Statistical Performance Check

#### 3.6.1 Statistical Performance Check Limit

RadAR Type	Minimum Percentage of Successful Detection (Pd)	Minimum Trials
1	60%	30
2	60%	30
3	60%	30
4	60%	30
Aggregate (RadAR Types 1-4)	80%	120
5	80%	30
6	70%	30

The percentage of successful detection is calculated by:

$$\frac{\text{TotalWaveformDetections}}{\text{TotalWaveformTrials}} \times 100 = \text{Probability of Detection Radar Waveform}$$

In addition an aggregate minimum percentage of successful detection across all Short Pulse RadAR Types 1-4 is required and is calculated as follows:

$$\frac{Pd1 + Pd2 + Pd3 + Pd4}{4}$$

#### 3.6.2 Test Procedures

Test Method
<input checked="" type="checkbox"/> Refer as FCC 06-96, clause 7.8.4 for Statistical Performance Check test. Stream the MPEG test file from the Master Device to the Client Device on the test Channel for the entire period of the test. Observe the transmissions of the UUT at the end of the Burst on the Operating Channel for duration greater than 10 seconds for Short Pulse RadAR Types 1-4 and 6 to ensure detection occurs. Then Observe the transmissions of the UUT at the end of the Burst on the Operating Channel for duration greater than 22 seconds for Long Pulse RadAR Type 5 to ensure detection occurs. The device can utilize a test mode to demonstrate when detection occurs to prevent the need to reset the device between trial runs.

### 3.6.3 Test Result of Statistical Performance Check

Statistical Performance Check Result– HT20					
Radar Signal (#)	Test Trail #	Detect Trail #	Pd (%)	Limit Pd (%)	Result
1	30	30	100	60	Complied
2	30	30	100	60	Complied
3	30	30	100	60	Complied
4	30	30	100	60	Complied
<b>Aggregate 1 - 4</b>	120	120	100	80	Complied
5	30	30	93.33	80	Complied
6	30	30	100	70	Complied

Statistical Performance Check Result– HT40					
Radar Signal (#)	Test Trail #	Detect Trail #	Pd (%)	Limit Pd (%)	Result
1	30	30	100	60	Complied
2	30	30	100	60	Complied
3	30	30	100	60	Complied
4	30	30	100	60	Complied
<b>Aggregate 1 - 4</b>	120	120	100	80	Complied
5	30	30	100	80	Complied
6	30	30	100	70	Complied

### 3.6.4 Detection Data Sheet for Radar Types 1, 5, and 6

Radar Type	1		5		6	
Trail #	HT20 <sub>*1</sub>	HT40 <sub>*1</sub>	HT20 <sub>*1</sub>	HT40 <sub>*1</sub>	HT20 <sub>*1</sub>	HT40 <sub>*1</sub>
1	1	1	1	1	1	1
2	1	1	1	1	1	1
3	1	1	1	1	1	1
4	1	1	1	1	1	1
5	1	1	1	1	1	1
6	1	1	1	1	1	1
7	1	1	1	1	1	1
8	1	1	1	1	1	1
9	1	1	1	1	1	1
10	1	1	1	1	1	1
11	1	1	1	1	1	1
12	1	1	1	1	1	1
13	1	1	1	1	1	1
14	1	1	1	1	1	1
15	1	1	1	1	1	1
16	1	1	1	1	1	1
17	1	1	1	1	1	1
18	1	1	1	1	1	1
19	1	1	0	1	1	1
20	1	1	0	1	1	1
21	1	1	1	1	1	1
22	1	1	1	1	1	1
23	1	1	1	1	1	1
24	1	1	1	1	1	1
25	1	1	1	1	1	1
26	1	1	1	1	1	1
27	1	1	1	1	1	1
28	1	1	1	1	1	1
29	1	1	1	1	1	1
30	1	1	1	1	1	1
Pd (%)	100.00%	100.00%	93.33%	100.00%	100.00%	100.00%
Note 1: 1=Detection ;0=No Detection						

### 3.6.5 Data Sheet for Radar Type 2

Radar Type	2				
Trail #	Pulse Width (us)	PRI (us)	Pulses / Burst	HT20 <sub>-1</sub>	HT40 <sub>-1</sub>
1	3.6	170	28	1	1
2	4.7	179	27	1	1
3	4.3	213	29	1	1
4	2.1	200	27	1	1
5	4.5	189	27	1	1
6	2.3	230	28	1	1
7	2.1	155	23	1	1
8	4.2	168	26	1	1
9	1.9	158	24	1	1
10	2	221	23	1	1
11	4	228	28	1	1
12	2.1	189	27	1	1
13	2	228	27	1	1
14	4.9	210	27	1	1
15	3.8	180	27	1	1
16	1.9	190	25	1	1
17	2.9	223	26	1	1
18	1.7	169	26	1	1
19	1.7	207	25	1	1
20	1.7	175	28	1	1
21	1.1	152	29	1	1
22	1.6	168	27	1	1
23	1.8	177	25	1	1
24	2.8	198	27	1	1
25	4	151	27	1	1
26	3	155	28	1	1
27	1.4	188	24	1	1
28	2	178	25	1	1
29	3.3	173	25	1	1
30	2.8	208	28	1	1
Detection Percentage (%)				100.00%	100.00%
Note 1: 1=Detection ;0=No Detection					

### 3.6.6 Data Sheet for Radar Type 3

Radar Type	3				
Trail #	Pulse Width (us)	PRI (us)	Pulses / Burst	HT20 <sub>-1</sub>	HT40 <sub>-1</sub>
1	6.4	390	17	1	1
2	9.1	410	17	1	1
3	9.4	490	17	1	1
4	7.6	395	17	1	1
5	7.9	201	17	1	1
6	9.1	227	16	1	1
7	7.8	477	16	1	1
8	7.2	497	16	1	1
9	7.9	491	16	1	1
10	8.5	304	16	1	1
11	10	443	17	1	1
12	8.1	264	18	1	1
13	7.7	461	17	1	1
14	6.1	242	17	1	1
15	7.8	331	18	1	1
16	7.8	481	17	1	1
17	6.6	325	18	1	1
18	6.6	239	17	1	1
19	6	258	17	1	1
20	6.8	464	18	1	1
21	9.1	288	17	1	1
22	6.1	375	17	1	1
23	8.8	377	17	1	1
24	9.5	293	17	1	1
25	9.1	437	18	1	1
26	6.7	290	17	1	1
27	7.2	481	16	1	1
28	9.4	315	18	1	1
29	6.9	356	17	1	1
30	9.6	385	16	1	1
Detection Percentage (%)				100.00%	100.00%
Note 1: 1=Detection ;0=No Detection					



### 3.6.7 Data Sheet for Radar Type 4

Radar Type	4				
Trail #	Pulse Width (us)	PRI (us)	Pulses / Burst	HT20 <sub>-1</sub>	HT40 <sub>-1</sub>
1	18.2	424	13	1	1
2	17	283	15	1	1
3	11.4	386	12	1	1
4	14.2	471	13	1	1
5	13.9	399	15	1	1
6	18.7	252	14	1	1
7	11.4	370	12	1	1
8	17.5	283	15	1	1
9	14.1	391	16	1	1
10	16.4	229	15	1	1
11	15.8	327	14	1	1
12	18.8	317	15	1	1
13	17.7	433	13	1	1
14	16.3	312	15	1	1
15	15	486	16	1	1
16	16.9	393	14	1	1
17	19.3	354	12	1	1
18	15.2	353	13	1	1
19	14	478	13	1	1
20	16	408	16	1	1
21	16.4	317	12	1	1
22	19.2	464	14	1	1
23	16.2	301	12	1	1
24	11.1	226	14	1	1
25	14	315	16	1	1
26	15.7	293	12	1	1
27	19.3	398	14	1	1
28	15.7	324	15	1	1
29	15.4	394	13	1	1
30	15.5	376	13	1	1
Detection Percentage (%)				100.00%	100.00%
Note 1: 1=Detection ;0=No Detection					

### 3.6.8 Parameter Data Sheet for Radar Type 5

Statistical Performance Check Result						
Radar TestSignal (#)	5			Trail #	1	
Burst	Number of Pulses	Pulse Width (μsec)	Chirp Width (MHz)	Pulse 1-to-2 Spacing (μsec)	Pulse 2-to-3 Spacing (μsec)	Start Time (msec)
1	1	62.3	8			346
2	2	51.2	15	1745		2705
3	3	93.6	5	957	1634	3674
4	3	68.2	12	1668	1573	4884
5	3	83.1	8	1188	1888	6876
6	1	56.7	18			7876
7	2	60.6	18	1874		10409
8	3	75.5	13	1263	1683	11878

Statistical Performance Check Result						
Radar TestSignal (#)	5			Trail #	2	
Burst	Number of Pulses	Pulse Width (μsec)	Chirp Width (MHz)	Pulse 1-to-2 Spacing (μsec)	Pulse 2-to-3 Spacing (μsec)	Start Time (msec)
1	1	99.6	13			217
2	2	54.8	15	1727		2315.333
3	3	91.1	15	1120	1826	3607.666
4	2	76.2	7	1638		4476.999
5	1	88.9	13			5592.332
6	1	83	9			7558.665
7	1	83.9	12			8319.998
8	2	55.9	15	1613		9778.331
9	1	96.1	13			11445.664

Statistical Performance Check Result						
Radar TestSignal (#)		5		Trail #		3
Burst	Number of Pulses	Pulse Width (µsec)	Chirp Width (MHz)	Pulse 1-to-2 Spacing (µsec)	Pulse 2-to-3 Spacing (µsec)	Start Time (msec)
1	2	82	6	1246		1017
2	1	93.2	13			1960
3	2	61.3	13	1175		2727
4	1	52.8	8			4424
5	3	70.6	19	929	1076	4915
6	1	80.3	17			6325
7	1	83.2	15			7879
8	2	94	9	1805		9288
9	2	67	8	1486		10449
10	1	56.4	20			11613

Statistical Performance Check Result						
Radar TestSignal (#)		5		Trail #		4
Burst	Number of Pulses	Pulse Width (µsec)	Chirp Width (MHz)	Pulse 1-to-2 Spacing (µsec)	Pulse 2-to-3 Spacing (µsec)	Start Time (msec)
1	3	90.5	8	1149	1612	35
2	3	54.5	8	1094	1525	2104.909
3	1	57.1	18			3008.818
4	2	98.6	20	1292		3355.727
5	2	62.9	12	1433		5039.636
6	1	71.1	15			6162.545
7	1	96.7	5			7256.454
8	1	64.3	5			8120.363
9	3	61.2	8	1075	1524	9171.272
10	2	79.2	13	1877		10615.181
11	2	79.3	20	1313		11197.09

Statistical Performance Check Result						
Radar TestSignal (#)		5		Trail #		5
Burst	Number of Pulses	Pulse Width (µsec)	Chirp Width (MHz)	Pulse 1-to-2 Spacing (µsec)	Pulse 2-to-3 Spacing (µsec)	Start Time (msec)
1	1	89.5	13			20
2	3	71.8	11	1446	1549	1117
3	3	53.7	15	1100	1517	2485
4	2	99.3	11	1571		3334
5	3	56.8	6	1594	1280	4468
6	1	97.4	11			5213
7	2	67.6	13	1831		6014
8	3	77.1	8	1683	1337	7267
9	1	98.5	17			8544
10	3	58.3	13	1924	1829	9159
11	1	98.4	14			10380
12	1	79.3	11			11257

Statistical Performance Check Result						
Radar TestSignal (#)		5		Trail #		6
Burst	Number of Pulses	Pulse Width (µsec)	Chirp Width (MHz)	Pulse 1-to-2 Spacing (µsec)	Pulse 2-to-3 Spacing (µsec)	Start Time (msec)
1	2	53.8	14	1631		768
2	1	90	17			1453.077
3	3	87.2	18	1115	1297	2003.154
4	2	82	11	1728		3661.231
5	3	69.8	7	1641	1779	3888.308
6	2	63.1	20	1836		4946.385
7	1	59.8	6			6033.462
8	3	78.5	19	941	1921	7007.539
9	1	85.7	6			7603.616
10	3	67.7	9	1834	1450	8841.693
11	2	84.5	15	1376		9512.77
12	2	99.3	13	1570		10639.847
13	2	80.2	8	1088		11143.924

Statistical Performance Check Result						
Radar TestSignal (#)		5		Trail #		7
Burst	Number of Pulses	Pulse Width (µsec)	Chirp Width (MHz)	Pulse 1-to-2 Spacing (µsec)	Pulse 2-to-3 Spacing (µsec)	Start Time (msec)
1	3	80.8	10	1061	1124	389
2	2	81	9	1479		1091.143
3	2	87.6	17	1247		2291.286
4	2	94.7	18	1041		3143.429
5	2	78	18	1267		3741.572
6	1	95.5	14			4337.715
7	2	97.6	15	1215		5199.858
8	3	88	9	1349	1598	6171.001
9	2	69.7	17	1711		7626.144
10	2	96.5	17	1431		7882.287
11	2	96.9	6	1871		8695.43
12	3	66.4	10	1824	1468	10194.573
13	1	78.8	10			10822.716
14	3	87.6	6	1080	1159	11856.859

Statistical Performance Check Result						
Radar TestSignal (#)		5		Trail #	8	
Burst	Number of Pulses	Pulse Width (µsec)	Chirp Width (MHz)	Pulse 1-to-2 Spacing (µsec)	Pulse 2-to-3 Spacing (µsec)	Start Time (msec)
1	2	71.8	14	1432		573
2	2	65.9	19	1762		1114
3	2	74.7	6	1754		1977
4	3	81.7	5	1133	974	2616
5	3	57.8	14	1176	1712	3329
6	1	80.6	6			4341
7	3	99.3	17	1268	1876	4965
8	1	79.8	12			6218
9	3	83	11	990	1738	6989
10	3	71.5	11	1473	1255	7206
11	1	77.4	11			8127
12	2	84.8	12	1390		9315
13	2	64.6	12	1653		9748
14	2	92.9	12	1881		10919
15	1	71.3	6			11501

Statistical Performance Check Result						
Radar TestSignal (#)		5		Trail #		9
Burst	Number of Pulses	Pulse Width (µsec)	Chirp Width (MHz)	Pulse 1-to-2 Spacing (µsec)	Pulse 2-to-3 Spacing (µsec)	Start Time (msec)
1	2	55.4	9	1318		383
2	2	80.8	18	1710		1284
3	1	88.8	9			1995
4	2	78	12	1818		2342
5	1	78.5	12			3108
6	2	55	13	1219		3873
7	2	75.9	20	1004		4623
8	2	70.9	7	1820		5796
9	2	71.7	18	1559		6476
10	2	73.9	19	1232		6985
11	1	59.2	20			7924
12	1	55.7	9			8641
13	3	60.9	12	1144	1370	9198
14	2	60.8	14	990		9766
15	3	60.6	19	1526	1326	11195
16	2	89	5	1029		11381

Statistical Performance Check Result						
Radar TestSignal (#)		5		Trail #		10
Burst	Number of Pulses	Pulse Width (µsec)	Chirp Width (MHz)	Pulse 1-to-2 Spacing (µsec)	Pulse 2-to-3 Spacing (µsec)	Start Time (msec)
1	2	72.1	14	1119		488
2	3	81.4	13	1142	961	1156.882
3	3	92.9	18	991	1147	1976.764
4	3	81.3	18	1793	1369	2402.646
5	3	76.4	20	1005	1793	2902.528
6	1	61.6	18			4032.41
7	1	66.6	19			4416.292
8	1	53.7	12			5357.174
9	2	58	8	1477		5754.056
10	2	64	18	1791		6493.938
11	2	80.3	12	1304		7574.82
12	3	77.3	5	1039	1668	8136.702
13	2	97.6	11	1593		8633.584
14	1	73	6			9323.466
15	3	65.1	8	1097	1927	9984.348
16	2	59.5	13	1569		10770.23
17	1	88.2	19			11947.112



Statistical Performance Check Result						
Radar TestSignal (#)		5		Trail #		11
Burst	Number of Pulses	Pulse Width (µsec)	Chirp Width (MHz)	Pulse 1-to-2 Spacing (µsec)	Pulse 2-to-3 Spacing (µsec)	Start Time (msec)
1	2	56.1	12	1219		273
2	1	83.3	7			964.666
3	3	79.6	17	1218	1897	1492.333
4	2	95.8	7	1672		2480
5	2	79.6	8	920		3053.667
6	2	88.9	11	1779		3338.334
7	2	81.4	8	1645		4201.001
8	2	92	6	1454		4746.668
9	3	96	13	1518	1121	5525.335
10	2	65.6	11	1798		6349.002
11	2	98.7	5	1360		7082.669
12	2	52.9	15	1140		7985.336
13	2	76.5	8	1032		8092.003
14	3	73.8	18	1719	1383	9168.67
15	3	83.7	10	1270	1216	9676.337
16	2	89.6	10	1141		10108.004
17	2	67.2	20	1455		10938.671
18	3	55.7	14	1444	1475	11899.338

Statistical Performance Check Result						
Radar TestSignal (#)		5		Trail #		12
Burst	Number of Pulses	Pulse Width (µsec)	Chirp Width (MHz)	Pulse 1-to-2 Spacing (µsec)	Pulse 2-to-3 Spacing (µsec)	Start Time (msec)
1	2	70.6	15	1040		575
2	2	72.9	13	1460		809.579
3	3	88.9	5	1250	1629	1454.158
4	3	60.3	20	1757	1822	2362.737
5	3	92.1	19	1845	1198	3002.316
6	1	73	5			3689.895
7	1	50.4	15			3858.474
8	1	66.4	10			4754.053
9	1	79.1	18			5489.632
10	1	71.6	20			6108.211
11	2	95.6	13	1229		6813.79
12	1	74.4	9			7310.369
13	3	55.6	17	1263	1724	7701.948
14	2	78.3	13	1507		8247.527
15	3	54.1	13	1325	1249	9034.106
16	2	67.1	18	1584		9784.685
17	2	65.8	9	1195		10348.264
18	2	50.1	12	1755		10784.843
19	2	87.7	18	1359		11548.422

Statistical Performance Check Result						
Radar TestSignal (#)		5		Trail #		13
Burst	Number of Pulses	Pulse Width (µsec)	Chirp Width (MHz)	Pulse 1-to-2 Spacing (µsec)	Pulse 2-to-3 Spacing (µsec)	Start Time (msec)
1	3	79.5	7	1808	1550	274
2	2	76.7	20	1632		1173
3	3	85.9	12	1305	1496	1218
4	3	86.6	14	968	1172	1933
5	2	74.9	14	1348		2448
6	3	82.2	20	1692	1310	3156
7	2	53.9	13	1342		3645
8	3	62.7	15	1839	1651	4276
9	2	86.2	6	1165		4891
10	1	63.1	11			5791
11	2	82.4	6	1416		6107
12	1	95.8	18			6848
13	2	75.7	9	993		7682
14	3	70.1	18	1563	1020	8154
15	3	85.8	13	1420	1084	8846
16	1	63.2	7			9265
17	1	75.1	11			9747
18	2	69.5	5	1802		10456
19	1	51.8	19			11222
20	2	62.3	5	1449		11704

Statistical Performance Check Result						
Radar TestSignal (#)		5		Trail #		14
Burst	Number of Pulses	Pulse Width (µsec)	Chirp Width (MHz)	Pulse 1-to-2 Spacing (µsec)	Pulse 2-to-3 Spacing (µsec)	Start Time (msec)
1	3	74.9	5	1314	1466	1289
2	2	83.9	19	1442		2936
3	2	55.8	6	1147		3240
4	2	59.4	6	1490		5955
5	2	78.2	15	1665		7312
6	2	57.3	15	1357		7764
7	2	76.2	11	1651		9255
8	3	59	7	1460	1109	11910

Statistical Performance Check Result						
Radar TestSignal (#)		5		Trail #		15
Burst	Number of Pulses	Pulse Width (µsec)	Chirp Width (MHz)	Pulse 1-to-2 Spacing (µsec)	Pulse 2-to-3 Spacing (µsec)	Start Time (msec)
1	3	77.7	19	1046	1568	17
2	2	98.2	20	1628		2210.333
3	2	95.3	8	1540		3732.666
4	2	78.8	15	1341		4821.999
5	2	52.8	20	988		6353.332
6	2	65.2	9	1480		7268.665
7	2	99.5	10	1867		8883.998
8	2	79.5	13	1148		9675.331
9	3	50.6	13	1030	1525	11987.664

Statistical Performance Check Result						
Radar TestSignal (#)		5		Trail #		16
Burst	Number of Pulses	Pulse Width (µsec)	Chirp Width (MHz)	Pulse 1-to-2 Spacing (µsec)	Pulse 2-to-3 Spacing (µsec)	Start Time (msec)
1	2	97.5	11	1357		764
2	2	91.8	13	1896		1498
3	1	78.5	5			3517
4	1	60.1	11			4669
5	2	96.2	10	975		5957
6	2	56.6	18	1626		6701
7	1	77.1	20			7523
8	2	96.3	8	1682		8707
9	2	52.2	13	1017		9817
10	1	92.8	15			11116

Statistical Performance Check Result						
Radar TestSignal (#)		5		Trail #		17
Burst	Number of Pulses	Pulse Width (µsec)	Chirp Width (MHz)	Pulse 1-to-2 Spacing (µsec)	Pulse 2-to-3 Spacing (µsec)	Start Time (msec)
1	2	57.3	8	1220		792
2	3	73.1	5	1717	1679	1935.909
3	2	54.1	14	967		2293.818
4	2	98.8	19	1137		3987.727
5	3	85.5	8	1068	960	4664.636
6	2	78.5	7	1387		6281.545
7	2	77.9	12	1869		7051.454
8	1	81.9	10			8185.363
9	1	50.4	9			9191.272
10	1	75.2	8			10608.181
11	2	92.7	7	1770		11876.09

Statistical Performance Check Result						
Radar TestSignal (#)		5		Trail #		18
Burst	Number of Pulses	Pulse Width (µsec)	Chirp Width (MHz)	Pulse 1-to-2 Spacing (µsec)	Pulse 2-to-3 Spacing (µsec)	Start Time (msec)
1	2	79.1	6	1042		793
2	3	55.7	9	1327	1744	1159
3	1	95	20			2734
4	1	88.4	5			3523
5	1	92.3	15			4546
6	1	93.6	6			5208
7	2	95.1	12	1044		6894
8	1	59.5	17			7666
9	2	98.7	17	1422		8640
10	2	65.1	5	1104		9320
11	1	60.2	5			10060
12	1	88.7	8			11823

Statistical Performance Check Result						
Radar TestSignal (#)		5		Trail #		19
Burst	Number of Pulses	Pulse Width (µsec)	Chirp Width (MHz)	Pulse 1-to-2 Spacing (µsec)	Pulse 2-to-3 Spacing (µsec)	Start Time (msec)
1	1	53.9	10			226
2	2	82.6	13	992		1777.077
3	1	87.7	8			2149.154
4	3	69	12	1696	1606	3297.231
5	1	68.6	12			3912.308
6	3	76.5	13	1333	1468	5004.385
7	2	95.8	17	1380		5595.462
8	2	55.6	19	1147		6795.539
9	2	78.6	14	1268		7512.616
10	2	65.4	17	1231		9220.693
11	2	76.6	18	1883		9748.77
12	1	93.2	6			10749.847
13	2	50.2	13	1836		11137.924

Statistical Performance Check Result						
Radar TestSignal (#)		5		Trail #		20
Burst	Number of Pulses	Pulse Width (µsec)	Chirp Width (MHz)	Pulse 1-to-2 Spacing (µsec)	Pulse 2-to-3 Spacing (µsec)	Start Time (msec)
1	1	60.9	13			142
2	2	81.7	15	1831		1379.143
3	2	78.5	5	1396		2504.286
4	2	98.2	6	1652		2574.429
5	1	64.1	12			3842.572
6	3	53	18	1862	1902	4442.715
7	2	62.3	15	1490		5390.858
8	2	87	11	1411		6576.001
9	2	78.4	8	1090		7594.144
10	2	87.2	7	967		8057.287
11	3	71	13	1662	1841	8676.43
12	2	77.2	5	1557		10029.573
13	1	94.4	15			10393.716
14	1	90.6	13			11648.859

Statistical Performance Check Result						
Radar TestSignal (#)		5		Trail #		21
Burst	Number of Pulses	Pulse Width (µsec)	Chirp Width (MHz)	Pulse 1-to-2 Spacing (µsec)	Pulse 2-to-3 Spacing (µsec)	Start Time (msec)
1	3	76.5	8	1870	1326	385
2	2	95.3	13	1162		873
3	3	58.9	9	1586	1909	2342
4	2	73.1	13	1460		2730
5	2	73.1	12	1488		3225
6	2	75.1	5	1331		4418
7	3	98.5	11	936	1532	5014
8	3	72.5	13	1110	1903	5987
9	3	67.4	12	1567	1513	6480
10	2	76.1	12	1005		7477
11	2	94.3	17	1413		8314
12	2	72.8	12	1778		8866
13	2	90.9	14	1793		9747
14	3	94.8	11	1012	1742	10841
15	3	95	12	912	1641	11809



Statistical Performance Check Result						
Radar TestSignal (#)		5		Trail #		22
Burst	Number of Pulses	Pulse Width (µsec)	Chirp Width (MHz)	Pulse 1-to-2 Spacing (µsec)	Pulse 2-to-3 Spacing (µsec)	Start Time (msec)
1	1	96.7	9			308
2	2	78.3	13	1045		777
3	1	56.5	12			1574
4	3	88.5	14	1119	1020	2879
5	2	62.4	9	1436		3548
6	2	78.2	5	1147		4091
7	3	76.8	14	1069	1575	4860
8	2	91.6	18	978		5852
9	2	93.7	5	1130		6623
10	2	97.4	8	1100		7006
11	3	90.1	6	1629	1375	7608
12	2	79.9	18	1809		8433
13	2	83	10	1370		9477
14	2	89.1	13	1239		10234
15	2	58.3	8	1321		10776
16	1	85.2	13			11272

Statistical Performance Check Result						
Radar TestSignal (#)		5		Trail #		23
Burst	Number of Pulses	Pulse Width (µsec)	Chirp Width (MHz)	Pulse 1-to-2 Spacing (µsec)	Pulse 2-to-3 Spacing (µsec)	Start Time (msec)
1	3	60	10	1097	1748	56
2	3	66.3	13	1391	1430	1126.882
3	2	88.5	15	1040		1994.764
4	2	72.1	8	1526		2278.646
5	1	72.3	8			3273.528
6	2	67.3	7	1022		3577.41
7	2	56.1	12	1325		4896.292
8	1	83.5	11			5636.174
9	3	99.4	13	1490	938	6052.056
10	1	54.2	12			6478.938
11	3	92.7	17	1251	1631	7423.82
12	3	95.1	17	1741	1162	7821.702
13	2	84	9	1597		8637.584
14	1	68.5	18			9688.466
15	1	76.5	20			10067.348
16	3	86.6	11	1774	1875	11045.23
17	2	62.2	9	1563		11786.112

Statistical Performance Check Result						
Radar TestSignal (#)		5		Trail #		24
Burst	Number of Pulses	Pulse Width (µsec)	Chirp Width (MHz)	Pulse 1-to-2 Spacing (µsec)	Pulse 2-to-3 Spacing (µsec)	Start Time (msec)
1	1	86.6	19			621
2	2	95.3	17	926		794.666
3	1	76.2	12			1584.333
4	3	71.4	19	1287	1404	2269
5	3	51.7	12	1564	1339	3299.667
6	2	77	5	1899		3948.334
7	1	87.5	12			4375.001
8	3	59	17	1327	1615	5276.668
9	2	78.3	15	1551		5881.335
10	2	89.7	5	1718		6456.002
11	2	92.1	7	1403		6678.669
12	2	97.3	14	1338		7929.336
13	3	80.3	20	1354	1563	8484.003
14	1	98.2	8			9094.67
15	3	94.4	13	1795	1829	9845.337
16	2	90.4	13	1105		10342.004
17	2	73.6	19	1787		10958.671
18	1	82.9	7			11951.338

Statistical Performance Check Result						
Radar TestSignal (#)		5		Trail #		25
Burst	Number of Pulses	Pulse Width (µsec)	Chirp Width (MHz)	Pulse 1-to-2 Spacing (µsec)	Pulse 2-to-3 Spacing (µsec)	Start Time (msec)
1	1	90	18			173
2	1	65.3	19			876.579
3	2	82.6	10	1756		1390.158
4	2	93.9	18	1557		2181.737
5	2	50.5	13	1479		2808.316
6	1	68	7			3333.895
7	3	88.4	11	1244	1076	4357.474
8	3	66.8	11	1288	1909	4869.053
9	2	88	12	1450		5579.632
10	3	51.1	6	1797	1935	5879.211
11	2	93.8	13	1073		6499.79
12	1	83.5	10			7453.369
13	2	96.9	12	1047		7845.948
14	3	87.2	18	1521	1450	8453.527
15	2	60.1	8	1545		9133.106
16	3	98	10	1842	1402	10027.685
17	3	57	19	1665	1732	10248.264
18	1	74.3	14			10767.843
19	2	57.8	10	1576		11977.422

Statistical Performance Check Result						
Radar TestSignal (#)		5		Trail #	26	
Burst	Number of Pulses	Pulse Width (µsec)	Chirp Width (MHz)	Pulse 1-to-2 Spacing (µsec)	Pulse 2-to-3 Spacing (µsec)	Start Time (msec)
1	2	92.8	9	1222		531
2	2	52.4	8	1547		768
3	3	56.8	7	1158	1184	1393
4	1	91.2	7			2365
5	3	61.2	10	1558	1664	2787
6	3	62	7	1518	1656	3391
7	2	69	5	1531		3927
8	2	67.3	18	1064		4225
9	1	94.1	5			4878
10	2	76	17	1190		5622
11	2	81.9	12	1815		6096
12	2	57.9	8	1594		6877
13	3	68.3	19	1427	1540	7241
14	2	53.3	7	1713		7848
15	2	85.3	15	1136		8448
16	1	65.3	20			9057
17	3	79.8	20	923	1259	9648
18	2	56.9	20	1357		10683
19	2	93	9	1686		10873
20	2	82.8	10	944		11752

Statistical Performance Check Result						
Radar TestSignal (#)		5		Trail #		27
Burst	Number of Pulses	Pulse Width (µsec)	Chirp Width (MHz)	Pulse 1-to-2 Spacing (µsec)	Pulse 2-to-3 Spacing (µsec)	Start Time (msec)
1	3	50.9	11	1106	1077	1293
2	2	77.8	18	1836		2735
3	3	60.7	5	1069	1635	4092
4	2	77.2	13	1916		5843
5	2	91.6	13	1465		7466
6	2	56.8	17	1783		7876
7	1	59.5	20			9131
8	1	66.5	12			11524

Statistical Performance Check Result						
Radar TestSignal (#)		5		Trail #		28
Burst	Number of Pulses	Pulse Width (µsec)	Chirp Width (MHz)	Pulse 1-to-2 Spacing (µsec)	Pulse 2-to-3 Spacing (µsec)	Start Time (msec)
1	2	72	9	1092		965
2	2	89.2	6	1550		2559.333
3	1	81.2	12			2943.666
4	2	80.6	15	1616		4457.999
5	2	62.8	10	1812		6081.332
6	1	71	8			7100.665
7	2	69.3	6	1027		9110.998
8	2	77.2	13	1076		9971.331
9	2	65.4	5	1582		10944.664

Statistical Performance Check Result						
Radar TestSignal (#)		5		Trail #		29
Burst	Number of Pulses	Pulse Width (µsec)	Chirp Width (MHz)	Pulse 1-to-2 Spacing (µsec)	Pulse 2-to-3 Spacing (µsec)	Start Time (msec)
1	1	51.5	19			151
2	1	82.3	13			2271
3	3	78.3	8	1115	1740	3046
4	2	99	14	1101		4309
5	3	98.8	7	1819	945	5356
6	2	80.9	19	922		6567
7	2	64	12	953		7781
8	1	79	20			9198
9	1	68	8			9712
10	2	50.4	13	1587		10826

Statistical Performance Check Result						
Radar TestSignal (#)		5		Trail #		30
Burst	Number of Pulses	Pulse Width (µsec)	Chirp Width (MHz)	Pulse 1-to-2 Spacing (µsec)	Pulse 2-to-3 Spacing (µsec)	Start Time (msec)
1	3	57.8	5	1324	1716	82
2	2	70.1	20	1733		1677.909
3	2	95.2	13	1188		2970.818
4	3	84.6	20	1042	1259	4293.727
5	3	96.5	7	1329	1596	4379.636
6	2	84.3	15	1606		6162.545
7	3	53.5	19	1783	1458	7283.454
8	3	74.9	5	1599	1891	8102.363
9	3	53.8	7	1494	1467	8979.272
10	2	60.5	14	1319		10282.181
11	1	73.3	10			11754.09

## 4 Test laboratory information

Established in 2012, ICC provides foremost EMC & RF Testing and advisory consultation services by our skilled engineers and technicians. Our services employ a wide variety of advanced edge test equipment and one of the widest certification extents in the business.

International Certification Corp, it is our definitive objective is to institute long term, trust-based associations with our clients. The expectation we set up with our clients is based on outstanding service, practical expertise and devotion to a certified value structure. Our passion is to grant our clients with best EMC / RF services by oriented knowledgeable and accommodating staff.

Our Test sites are located at Linkou District and Kwei Shan Hsiang. Location map can be found on our website <http://www.icertifi.com.tw>.

### **Linkou**

Tel: 886-2-2601-1640

No. 30-2, Ding Fwu Tsuen, Lin Kou District, New Taipei City, Taiwan, R.O.C.

### **Kwei Shan**

Tel: 886-3-271-8666

No. 3-1, Lane 6, Wen San 3rd St., Kwei Shan Hsiang, Tao Yuan Hsien 333, Taiwan, R.O.C.

If you have any suggestion, please feel free to contact us as below information

Tel: 886-3-271-8666

Fax: 886-3-318-0155

Email: ICC\_Service@icertifi.com.tw

==END==