

FCC Test Report

FCC ID : 2AAS9-1254XW
Equipment : Dual Radio 802.11a/n+b/g/n Indoor Access Point
Model No. : BW1254
Brand Name : BROWAN
Applicant : BROWAN COMMUNICATIONS Co., Ltd.
Address : No. 15-1, Zhonghua Rd., Hsinchu Industrial Park, Hukou, Hsinchu, Taiwan, R. O. C. 303
Manufacturer : Gemtek Technology Co., Ltd.
Address : No. 15-1, Zhonghua Rd., Hsinchu Industrial Park, Hukou, Hsinchu, Taiwan, R. O. C. 303
Standard : 47 CFR FCC Part 15.247
Received Date : Aug. 02, 2013
Tested Date : Aug. 03 ~ Sep. 30, 2013

We, International Certification Corp., would like to declare that the tested sample has been evaluated and in compliance with the requirement of the above standards. The test results contained in this report refer exclusively to the product. It may be duplicated completely for legal use with the approval of the applicant. It shall not be reproduced except in full without the written approval of our laboratory.

Approved & Reviewed by:



Gary Chang / Manager



Table of Contents

1	GENERAL DESCRIPTION	5
1.1	Information.....	5
1.2	Local Support Equipment List	7
1.3	Test Setup Chart	8
1.4	The Equipment List	9
1.5	Test Standards	10
1.6	Measurement Uncertainty	11
2	TEST CONFIGURATION	12
2.1	Testing Condition	12
2.2	The Worst Test Modes and Channel Details	12
3	TRANSMITTER TEST RESULTS.....	13
3.1	Conducted Emissions.....	13
3.2	6dB and Occupied Bandwidth	18
3.3	RF Output Power	21
3.4	Power Spectral Density	23
3.5	Unwanted Emissions into Restricted Frequency Bands	25
3.6	Unwanted Emissions into Non-Restricted Frequency Bands	55
4	TEST LABORATORY INFORMATION	64
5	APPENDIX A – AVERAGE POWER FOR REFERENCE ONLY	65

Release Record

Report No.	Version	Description	Issued Date
FR380701AC	Rev. 01	Initial issue	Feb. 14, 2014

Summary of Test Results

FCC Rules	Test Items	Measured	Result
15.207	Conducted Emissions	[dBuV]: 2.877MHz 43.83 (Margin -2.17dB) - AV	Pass
15.247(d) 15.209	Radiated Emissions	[dBuV/m at 3m]: 955.33 MHz 45.00 (Margin -1.00dB) – QP [dBuV/m at 3m]: 2390 MHz 53.00 (Margin -1.00dB) - AV	Pass
15.247(b)(3)	Fundamental Emission Output Power	Power [dBm]: 11b: 29.62 11g: 29.43 HT20: 29.39 HT40: 27.51	Pass
15.247(a)(2)	6dB Bandwidth	Meet the requirement of limit	Pass
15.247(e)	Power Spectral Density	Meet the requirement of limit	Pass
15.203	Antenna Requirement	Meet the requirement of limit	Pass

1 General Description

1.1 Information

1.1.1 Specification of the Equipment under Test (EUT)

RF General Information					
Frequency Range (MHz)	IEEE Std. 802.11	Ch. Freq. (MHz)	Channel Number	Transmit Chains (N _{TX})	Data Rate / MCS
2400-2483.5	b	2412-2462	1-11 [11]	2	1-11 Mbps
2400-2483.5	g	2412-2462	1-11 [11]	2	6-54 Mbps
2400-2483.5	n (HT20)	2412-2462	1-11 [11]	2	MCS 0-15
2400-2483.5	n (HT40)	2422-2452	3-9 [7]	2	MCS 0-15

Note 1: RF output power specifies that Maximum Peak Conducted Output Power.
 Note 2: 802.11b uses a combination of DSSS-DBPSK, DQPSK, CCK modulation.
 Note 3: 802.11g/n uses a combination of OFDM-BPSK, QPSK, 16QAM, 64QAM modulation.

1.1.2 Antenna Details

Ant. No.	Model	Type	Connector	Operating Frequencies (MHz) / Antenna Gain (dBi)				
				2400~2483.5	5150~5250	5250~5350	5470~5725	5725~5850
1	EDA-1713 2G4 R2-A7	Dipole (Omni-directional)	R-SMA	5	X	X	X	X
2	EDA-1713 5G0 R2-A2	Dipole (Omni-directional)	R-SMA	X	5	5	5	5
3	EDA-870P-2 5G R2-A11	Dipole (Omni-directional)	R-SMA	2	2	2	2	2
4	EDA-1713-2 5G R2-A4	Dipole (Omni-directional)	R-SMA	5	5	5	5	5
5	SAA05-2201 70	Dipole (Omni-directional)	R-SMA	3	5	5	5	5

Note: Highest antenna gain (Antenna 1) was chosen for test.

1.1.3 EUT Operational Condition

Supply Voltage	<input checked="" type="checkbox"/> AC mains	<input type="checkbox"/> DC	
Type of DC Source	<input type="checkbox"/> Internal DC supply	<input type="checkbox"/> External DC adapter	<input type="checkbox"/> 5Vdc from Host

1.1.4 Accessories

Accessories		
No.	Equipment	Description
1	AC Adapter	Brand Name: LEI Model Name: MU24-B480050-A1 Power Rating: I/P: 100-240Vac, 50-60Hz, 1.0A O/P: 48Vdc, 0.5A Power Line: 1.5m non-shielded cable w/o core
2	POE	Brand Name: BROWAN Model Name: BE3013 Power Rating: I/P: 8~57Vdc O/P: 8~57Vdc,

1.1.5 Channel List

Frequency band (MHz)		2400~2483.5	
802.11 b / g / n HT20		802.11n HT40	
Channel	Frequency(MHz)	Channel	Frequency(MHz)
1	2412	3	2422
2	2417	4	2427
3	2422	5	2432
4	2427	6	2437
5	2432	7	2442
6	2437	8	2447
7	2442	9	2452
8	2447	---	---
9	2452	---	---
10	2457	---	---
11	2462	---	---

1.1.6 Test Tool and Duty Cycle

Test tool	ART2-GUI V2.3
Duty Cycle Of Test Signal (%)	100.00% - IEEE 802.11b 100.00% - IEEE 802.11g 100.00% - IEEE 802.11n (HT20) 100.00% - IEEE 802.11n (HT40)
Duty Factor	0 - IEEE 802.11b 0 - IEEE 802.11g 0 - IEEE 802.11n (HT20) 0 - IEEE 802.11n (HT40)

1.1.7 Power Setting

Modulation Mode	Test Frequency (MHz)	Power Set
11b	2412	22
11b	2437	29
11b	2462	24
11g	2412	18.5
11g	2437	19
11g	2462	18.5
HT20	2412	16.5
HT20	2437	19
HT20	2462	18
HT40	2422	13.5
HT40	2437	18.5
HT40	2452	15

1.2 Local Support Equipment List

Support Equipment List						
No.	Equipment	Brand	Model	S/N	FCC ID	Signal cable / Length (m)
1	Notebook	DELL	E6430	---	DoC	RJ45, 10m non-shielded with 1 core.
2	USB Dongle	PQI	U273V	---	---	---

Note: Console cable was supplied by applicant.

1.3 Test Setup Chart

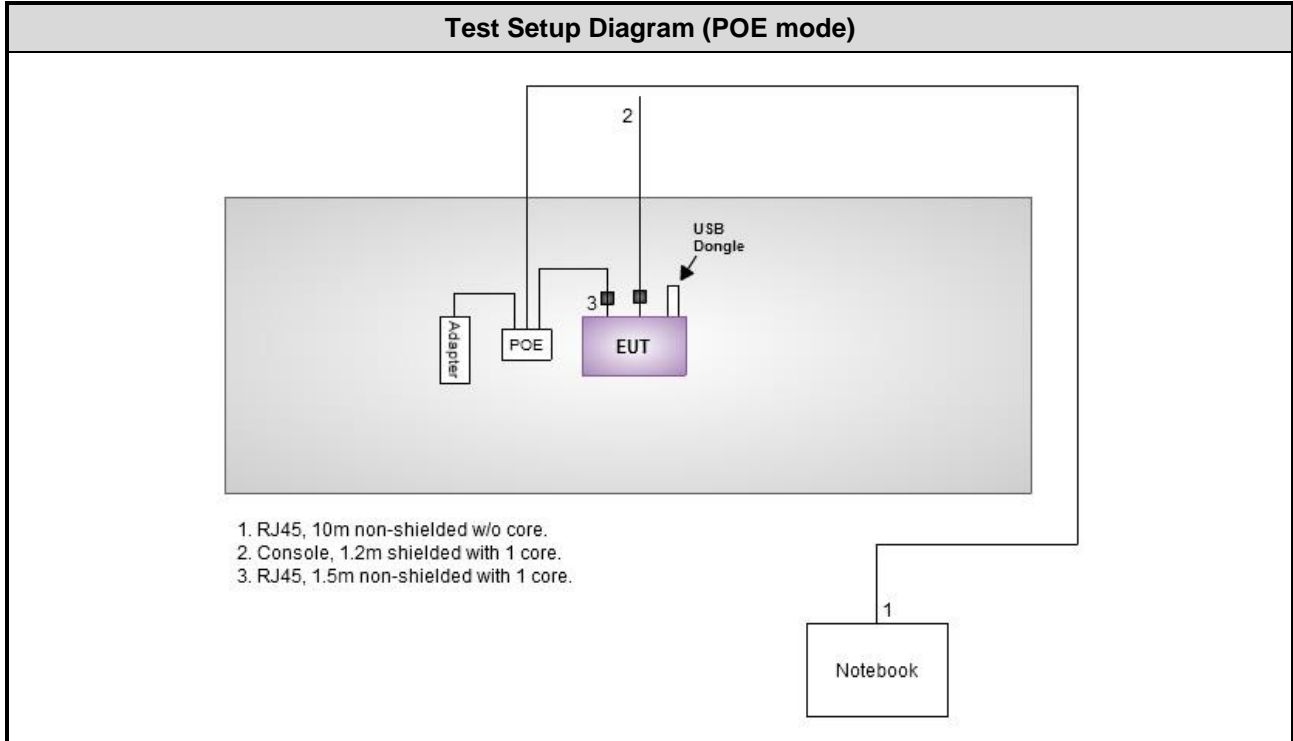
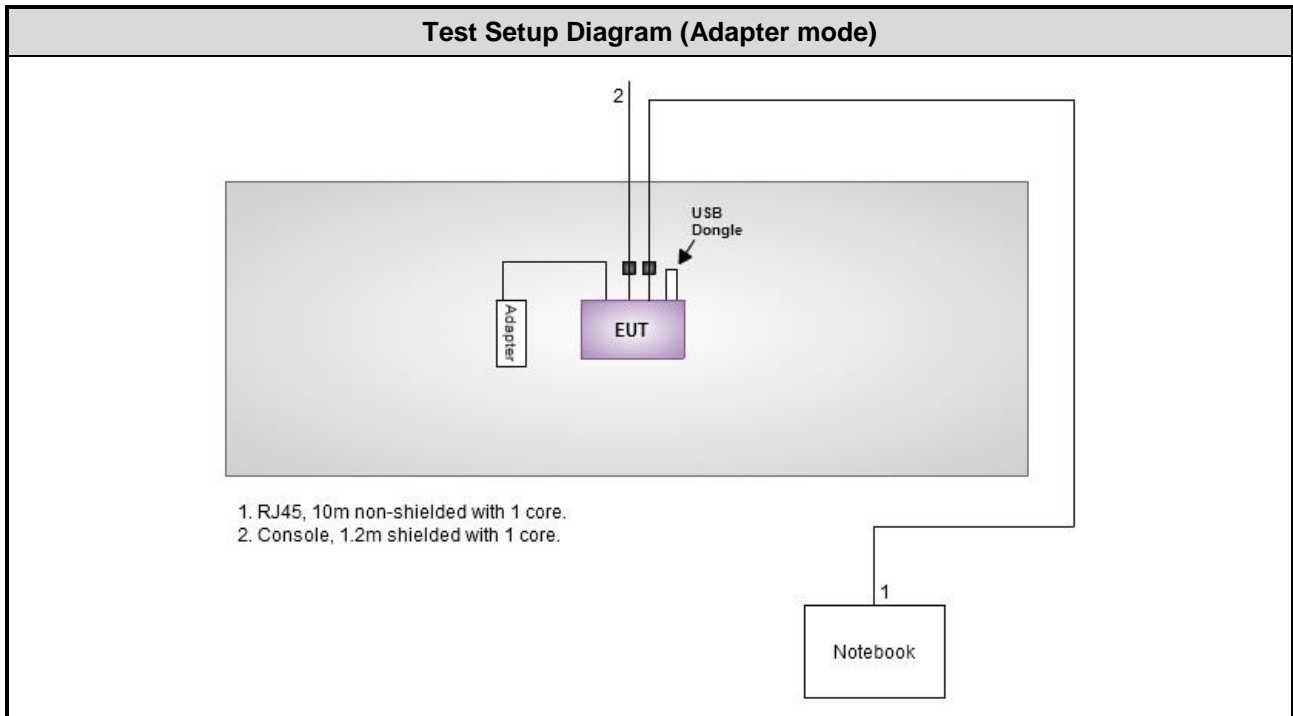

1.4 The Equipment List

Test Item	Conducted Emission				
Test Site	Conduction room 1 / (CO01-WS)				
Instrument	Manufacturer	Model No.	Serial No.	Calibration Date	Calibration Until
EMC Receiver	R&S	ESCS 30	100169	Oct. 02, 2012	Oct. 01, 2013
LISN	SCHWARZBECK MESS-ELEKTRONIK	Schwarzbeck 8127	8127-667	Dec. 04, 2012	Dec. 03, 2013
LISN (Support Unit)	SCHWARZBECK MESS-ELEKTRONIK	Schwarzbeck 8127	8127-666	Dec. 04, 2012	Dec. 03, 2013
ISN	TESEQ	ISN T800	34406	Apr. 08, 2013	Apr. 07, 2014
ISN	TESEQ	ISN T200A	30494	Apr. 09, 2013	Apr. 08, 2014
ISN	TESEQ	ISN ST08	22589	Jan. 24, 2013	Jan. 23, 2014
RF Current Probe	FCC	F-33-4	121630	Dec. 04, 2012	Dec. 03, 2013
RF Cable-CON	Woken	CFD200-NL	CFD200-NL-001	Dec. 25, 2012	Dec. 24, 2013
ESH3-Z6 V-Network(+)	R&S	ESH3-Z6	100920	Nov. 21, 2012	Nov. 20, 2013
ESH3-Z6 V-Network(-)	R&S	ESH3-Z6	100951	Jan. 30, 2013	Jan. 29, 2014
Two-Line V-Network	R&S	ENV216	101579	Jan. 07, 2013	Jan. 06, 2014
50 ohm terminal	NA	50	01	Apr. 22, 2013	Apr. 21, 2014
50 ohm terminal	NA	50	02	Apr. 22, 2013	Apr. 21, 2014
50 ohm terminal	NA	50	03	Apr. 22, 2013	Apr. 21, 2014
50 ohm terminal (Support Unit)	NA	50	04	Apr. 22, 2013	Apr. 21, 2014

Note: Calibration Interval of instruments listed above is one year.

Test Item	RF Conducted				
Test Site	(TH01-WS)				
Instrument	Manufacturer	Model No.	Serial No.	Calibration Date	Calibration Until
Spectrum Analyzer	R&S	FSV 40	101063	Feb. 18, 2013	Feb. 17, 2014
TEMP&HUMIDITY CHAMBER	GIANT FORCE	GCT-225-40-SP-SD	MAF1212-002	Nov. 29, 2012	Nov. 28, 2013
Power Meter	Anritsu	ML2495A	1241002	Oct. 15, 2012	Oct. 14, 2013
Power Sensor	Anritsu	MA2411B	1027366	Oct. 24, 2012	Oct. 23, 2013
Signal Generator	R&S	SMB100A	175727	Jan. 14, 2013	Jan. 13, 2014
Radio Communication Analyzer	Anritsu	MT8820C	6201240341	Mar. 13, 2013	Mar. 12, 2014
Wideband Radio Communication Tester	R&S	CMW500	106070	Jan. 29, 2013	Jan. 28, 2014
Bluetooth Tester	R&S	CBT	100959	Jan. 09, 2013	Jan. 08, 2014
MXG-B RF Vector Signal Generator	Agilent	N5182B	MY53050081	Apr. 19, 2013	Apr. 18, 2014
Mobile WiMAX test set	Agilent	E6651A	MY47310158	Oct. 09, 2012	Oct. 09, 2013

Note: Calibration Interval of instruments listed above is one year.

Test Item	Radiated Emission above 1GHz				
Test Site	966 chamber1 / (03CH01-WS)				
Instrument	Manufacturer	Model No.	Serial No.	Calibration Date	Calibration Until
3m semi-anechoic chamber	CHAMPRO	SAC-03	03CH01-WS	Jan. 04, 2013	Jan. 03, 2014
Spectrum Analyzer	R&S	FSV40	101498	Jan. 24, 2013	Jan. 23, 2014
Receiver	R&S	ESR3	101658	Jan. 28, 2013	Jan. 27, 2014
Bilog Antenna	SCHWARZBECK	VULB9168	VULB9168-522	Jan. 11, 2013	Jan. 10, 2014
Horn Antenna 1G-18G	SCHWARZBECK	BBHA 9120 D	BBHA 9120 D 1096	Feb. 18, 2013	Feb. 17, 2014
Horn Antenna 18G-40G	SCHWARZBECK	BBHA 9170	BBHA 9170517	Jan. 14, 2013	Jan. 13, 2014
Amplifier	Burgeon	BPA-530	100219	Nov. 28, 2012	Nov. 27, 2013
Amplifier	Agilent	83017A	MY39501308	Dec. 18, 2012	Dec. 17, 2013
RF Cable	HUBER+SUHNER	SUCOFLEX104	MY16014/4	Dec. 25, 2012	Dec. 24, 2013
RF Cable	HUBER+SUHNER	SUCOFLEX104	MY16019/4	Dec. 25, 2012	Dec. 24, 2013
RF Cable	HUBER+SUHNER	SUCOFLEX104	MY16139/4	Dec. 25, 2012	Dec. 24, 2013
RF Cable-R03m	Woken	CFD400NL-LW	CFD400NL-001	Dec. 25, 2012	Dec. 24, 2013
RF Cable-R10m	Woken	CFD400NL-LW	CFD400NL-002	Dec. 25, 2012	Dec. 24, 2013
control	EM Electronics	EM1000	60612	N/A	N/A
Note: Calibration Interval of instruments listed above is one year.					

Loop Antenna	R&S	HFH2-Z2	100330	Nov. 15, 2012	Nov. 14, 2014
Amplifier	MITEQ	AMF-6F-260400	9121372	Apr. 19, 2013	Apr. 18, 2015
Note: Calibration Interval of instruments listed above is two year.					

1.5 Test Standards

According to the specification of EUT, the EUT must comply with following standards and KDB documents.

47 CFR FCC Part 15.247

ANSI C63.10-2009

FCC KDB 558074 D01 DTS Meas Guidance v03r01

FCC KDB 662911 D01 Multiple Transmitter Output v02

Note: The EUT has been tested and complied with FCC part 15B requirement. FCC Part 15B test results are issued to another report.

1.6 Measurement Uncertainty

ISO/IEC 17025 requires that an estimate of the measurement uncertainties associated with the emissions test results be included in the report. The measurement uncertainties given below are based on a 95% confidence level (based on a coverage factor (k=2))

Measurement Uncertainty	
Parameters	Uncertainty
Bandwidth	± 35.286 Hz
Conducted power	± 0.536 dB
Frequency error	± 35.286 Hz
Temperature	± 0.3 °C
Conducted emission	± 2.946 dB
AC conducted emission	± 2.43 dB
Radiated emission	± 2.49 dB

2 Test Configuration

2.1 Testing Condition

Test Item	Test Site	Ambient Condition	Tested By
AC Conduction	CO01-WS	24°C / 72%	Peter Lin
Radiated Emissions	03CH01-WS	24°C / 66%	Aska Huang
RF Conducted	TH01-WS	23°C / 62%	Brad Wu

➤ FCC site registration No.: 657002

➤ IC site registration No.: 10807A-1

2.2 The Worst Test Modes and Channel Details

Test item	Modulation Mode	Test Frequency (MHz)	Data rate (Mbps) / MCS	Test Configuration
Conducted Emissions	11b	2437	1 Mbps	1, 2
Radiated Emissions (below 1GHz)	11b	2437	1 Mbps	1, 2
Radiated Emissions (above 1GHz)	11b	2412 / 2437 / 2462	1 Mbps	1
	11g	2412 / 2437 / 2462	6 Mbps	
	HT20	2412 / 2437 / 2462	MCS 0	
	HT40	2422 / 2437 / 2452	MCS 0	
Fundamental Emission Output Power	11b	2412 / 2437 / 2462	1 Mbps	1
6dB bandwidth	11g	2412 / 2437 / 2462	6 Mbps	
Power spectral density	HT20	2412 / 2437 / 2462	MCS 0	
	HT40	2422 / 2437 / 2452	MCS 0	
NOTE:				
1. The EUT was pretested with 3 orientations placed on the table for the radiated emission measurement – X, Y, and Z-plane. The Y-plane results were found as the worst case and were shown in this report.				
2. Test Configuration 1 : Adapter Mode Test Configuration 2 : POE Mode				

3 Transmitter Test Results

3.1 Conducted Emissions

3.1.1 Limit of Conducted Emissions

Conducted Emissions Limit		
Frequency Emission (MHz)	Quasi-Peak	Average
0.15-0.5	66 - 56 *	56 - 46 *
0.5-5	56	46
5-30	60	50

Note 1: * Decreases with the logarithm of the frequency.

3.1.2 Test Procedures

1. The device is placed on a test table, raised 80 cm above the reference ground plane. The vertical conducting plane is located 40 cm to the rear of the device.
2. The device is connected to line impedance stabilization network (LISN) and other accessories are connected to other LISN. Measured levels of AC power line conducted emission are across the 50 Ω LISN port.
3. AC conducted emission measurements is made over frequency range from 150 kHz to 30 MHz.
4. This measurement was performed with AC 120V / 60Hz.

3.1.3 Test Setup

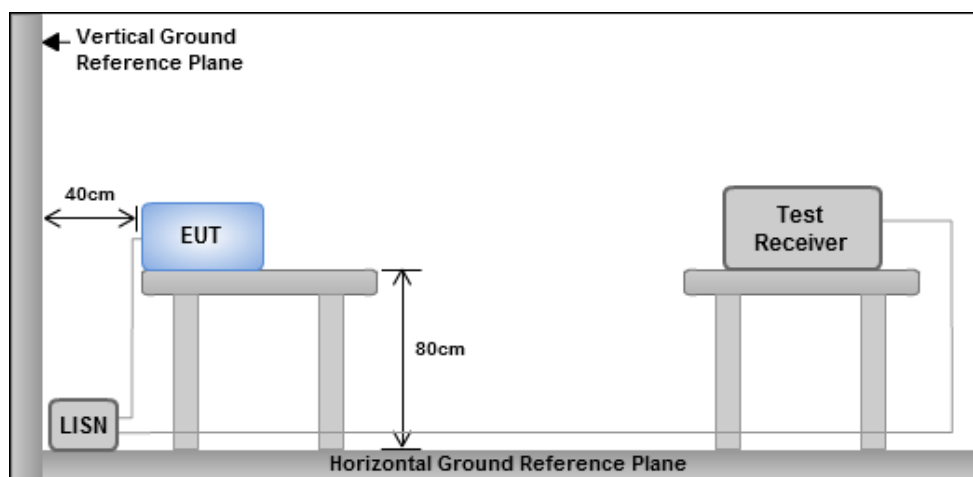

- Note: 1. Support units were connected to second LISN.
 2. Both of LISNs (AMN) are 80 cm from EUT and at least 80 cm from other units and other metal planes

3.1.4 Test Result of Conducted Emissions

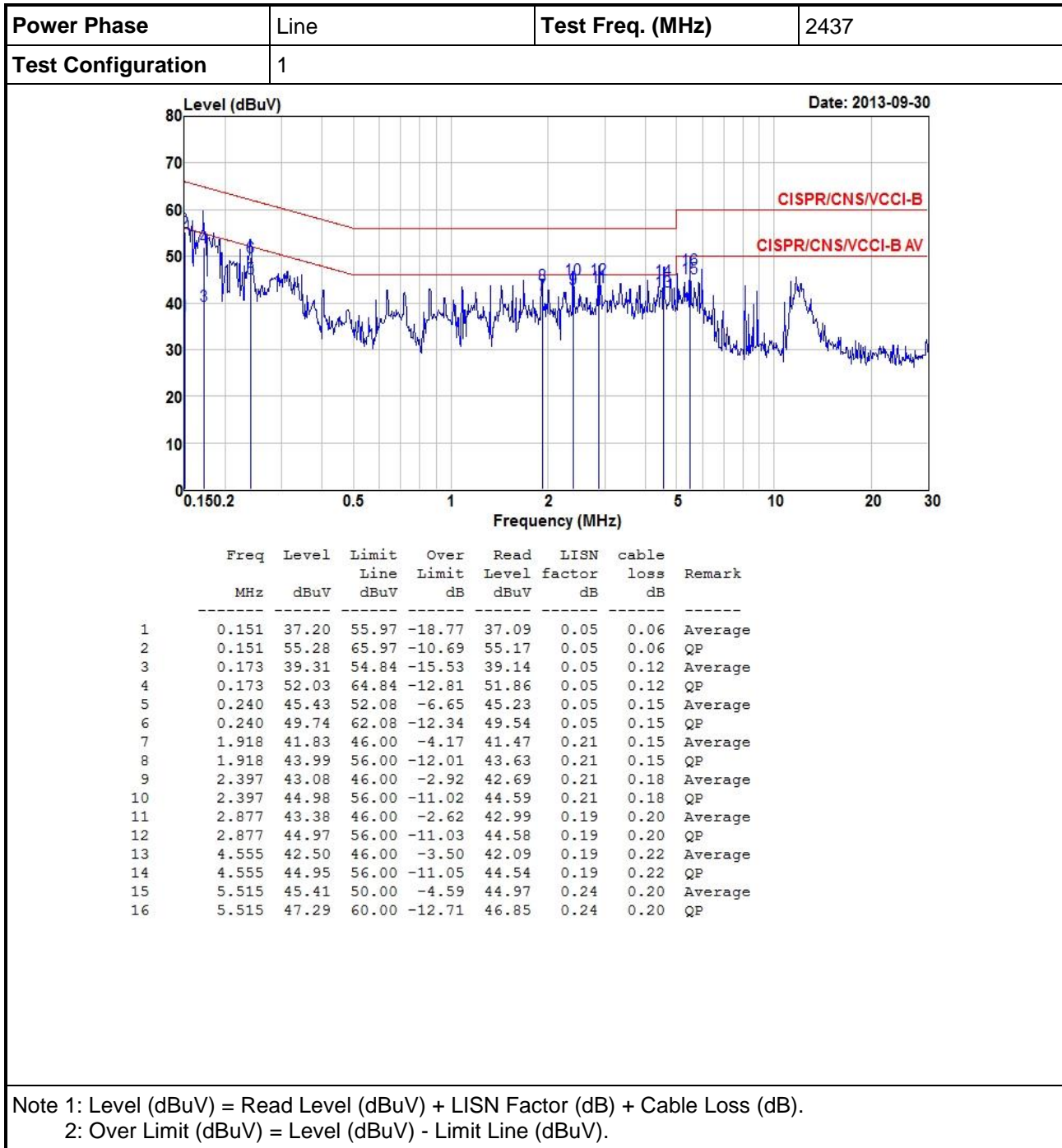

Power Phase	Neutral	Test Freq. (MHz)	2437
--------------------	---------	-------------------------	------

Test Configuration	1
---------------------------	---

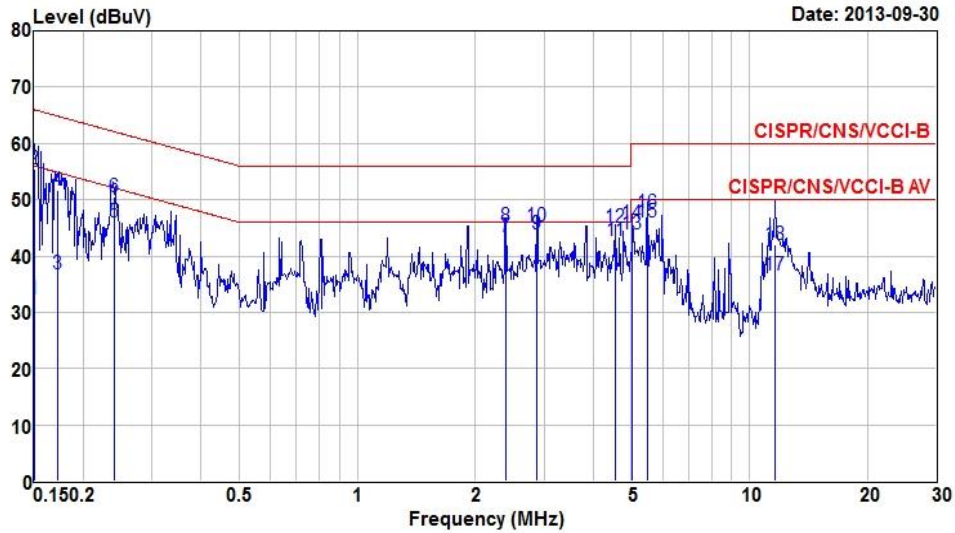

	Freq MHz	Level dBuV	Limit Line dBuV	Over Limit dB	Read Level dBuV	LISN factor dB	cable loss dB	Remark
1	0.150	32.38	56.00	-23.62	32.28	0.04	0.06	Average
2	0.150	55.37	66.00	-10.63	55.27	0.04	0.06	QP
3	0.172	36.87	54.88	-18.01	36.71	0.04	0.12	Average
4	0.172	51.74	64.88	-13.14	51.58	0.04	0.12	QP
5	0.240	45.95	52.08	-6.13	45.76	0.04	0.15	Average
6	0.240	50.58	62.08	-11.50	50.39	0.04	0.15	QP
7	2.398	43.52	46.00	-2.48	43.16	0.18	0.18	Average
8	2.398	45.36	56.00	-10.64	45.00	0.18	0.18	QP
9	2.877	43.83	46.00	-2.17	43.46	0.17	0.20	Average
10	2.877	45.24	56.00	-10.76	44.87	0.17	0.20	QP
11	4.555	42.73	46.00	-3.27	42.34	0.17	0.22	Average
12	4.555	45.10	56.00	-10.90	44.71	0.17	0.22	QP
13	5.035	43.88	50.00	-6.12	43.48	0.19	0.21	Average
14	5.035	45.87	60.00	-14.13	45.47	0.19	0.21	QP
15	5.515	45.94	50.00	-4.06	45.52	0.22	0.20	Average
16	5.515	47.69	60.00	-12.31	47.27	0.22	0.20	QP
17	11.621	36.52	50.00	-13.48	35.73	0.67	0.12	Average
18	11.621	42.03	60.00	-17.97	41.24	0.67	0.12	QP

Note 1: Level (dBuV) = Read Level (dBuV) + LISN Factor (dB) + Cable Loss (dB).
 2: Over Limit (dBuV) = Level (dBuV) - Limit Line (dBuV).

Power Phase	Line	Test Freq. (MHz)	2437
-------------	------	------------------	------

Test Configuration	2
--------------------	---

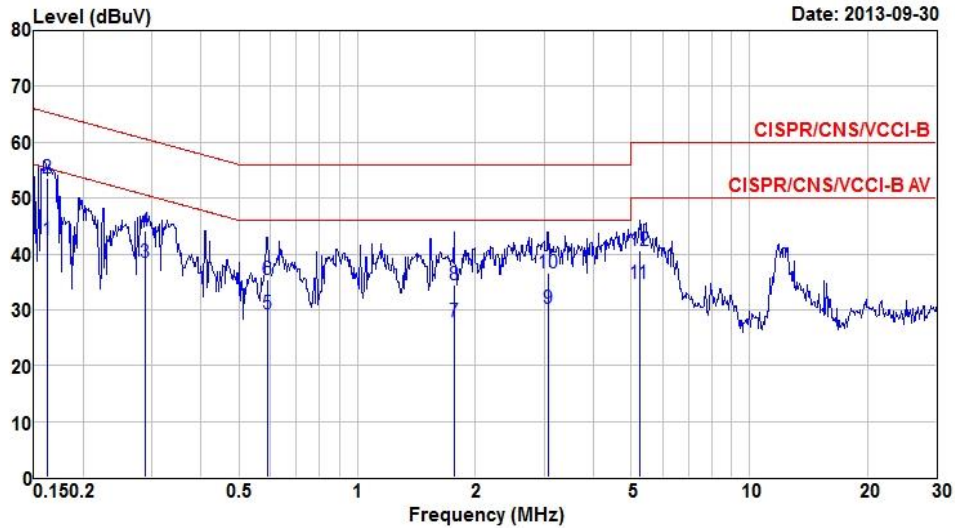

	Freq MHz	Level dBuV	Limit Line dBuV	Over Limit dB	Read Level dBuV	LISN factor dB	cable loss dB	Remark
1	0.162	42.58	55.35	-12.77	42.44	0.05	0.09	Average
2	0.162	53.67	65.35	-11.68	53.53	0.05	0.09	QP
3	0.288	38.44	50.59	-12.15	38.27	0.06	0.11	Average
4	0.288	44.18	60.59	-16.41	44.01	0.06	0.11	QP
5	0.592	29.24	46.00	-16.76	29.10	0.09	0.05	Average
6	0.592	35.32	56.00	-20.68	35.18	0.09	0.05	QP
7	1.762	27.88	46.00	-18.12	27.54	0.20	0.14	Average
8	1.762	34.55	56.00	-21.45	34.21	0.20	0.14	QP
9	3.074	30.21	46.00	-15.79	29.81	0.19	0.21	Average
10	3.074	36.50	56.00	-19.50	36.10	0.19	0.21	QP
11	5.249	34.62	50.00	-15.38	34.19	0.23	0.20	Average
12	5.249	40.55	60.00	-19.45	40.12	0.23	0.20	QP

Note 1: Level (dBuV) = Read Level (dBuV) + LISN Factor (dB) + Cable Loss (dB).
 2: Over Limit (dBuV) = Level (dBuV) - Limit Line (dBuV).

Power Phase	Neutral	Test Freq. (MHz)	2437
--------------------	---------	-------------------------	------

Test Configuration	2
---------------------------	---

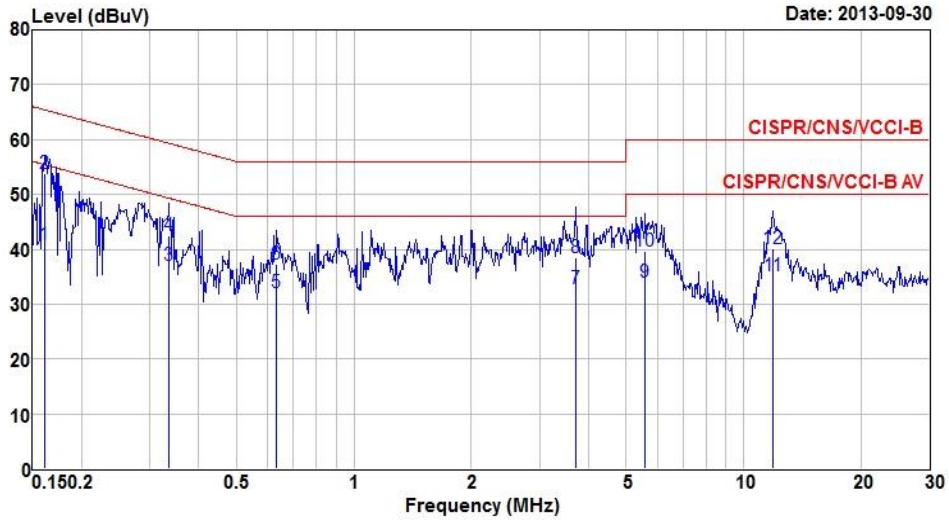

	Freq MHz	Level dBuV	Limit Line dBuV	Over Limit dB	Read Level dBuV	LISN factor dB	cable loss dB	Remark
1	0.161	40.75	55.43	-14.68	40.62	0.04	0.09	Average
2	0.161	53.71	65.43	-11.72	53.58	0.04	0.09	QP
3	0.336	37.03	49.31	-12.28	36.89	0.06	0.08	Average
4	0.336	42.56	59.31	-16.75	42.42	0.06	0.08	QP
5	0.634	32.17	46.00	-13.83	32.02	0.10	0.05	Average
6	0.634	37.37	56.00	-18.63	37.22	0.10	0.05	QP
7	3.720	32.80	46.00	-13.20	32.42	0.15	0.23	Average
8	3.720	38.52	56.00	-17.48	38.14	0.15	0.23	QP
9	5.594	34.00	50.00	-16.00	33.59	0.22	0.19	Average
10	5.594	39.72	60.00	-20.28	39.31	0.22	0.19	QP
11	11.933	35.18	50.00	-14.82	34.35	0.71	0.12	Average
12	11.933	40.11	60.00	-19.89	39.28	0.71	0.12	QP

Note 1: Level (dBuV) = Read Level (dBuV) + LISN Factor (dB) + Cable Loss (dB).
 2: Over Limit (dBuV) = Level (dBuV) - Limit Line (dBuV).

3.2 6dB and Occupied Bandwidth

3.2.1 Limit of 6dB Bandwidth

The minimum 6dB bandwidth shall be at least 500 kHz.

3.2.2 Test Procedures

1. Set resolution bandwidth (RBW) = 100 kHz, Video bandwidth = 300 kHz.
2. Detector = Peak, Trace mode = max hold.
3. Sweep = auto couple, Allow the trace to stabilize.
4. Measure the maximum width of the emission that is constrained by the frequencies associated with the two outermost amplitude points (upper and lower) that are attenuated by 6dB relative to the maximum level measured in the fundamental emission.

3.2.3 Test Setup

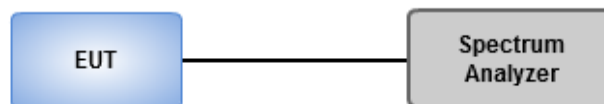

3.2.4 Test Result of 6dB and Occupied Bandwidth

Modulation Mode	N _{TX}	Freq. (MHz)	6dB Bandwidth (MHz)				Limit (kHz)
			Chain 0	Chain 1	Chain 2	Chain 3	
11b	2	2412	10.09	10.09	---	---	500
11b	2	2437	10.09	10.09	---	---	500
11b	2	2462	10.09	10.09	---	---	500
11g	2	2412	16.35	16.35	---	---	500
11g	2	2437	16.29	16.35	---	---	500
11g	2	2462	16.29	16.41	---	---	500
HT20	2	2412	17.22	17.22	---	---	500
HT20	2	2437	17.16	16.93	---	---	500
HT20	2	2462	17.57	16.93	---	---	500
HT40	2	2422	36.06	35.94	---	---	500
HT40	2	2437	35.83	35.83	---	---	500
HT40	2	2452	35.83	35.71	---	---	500

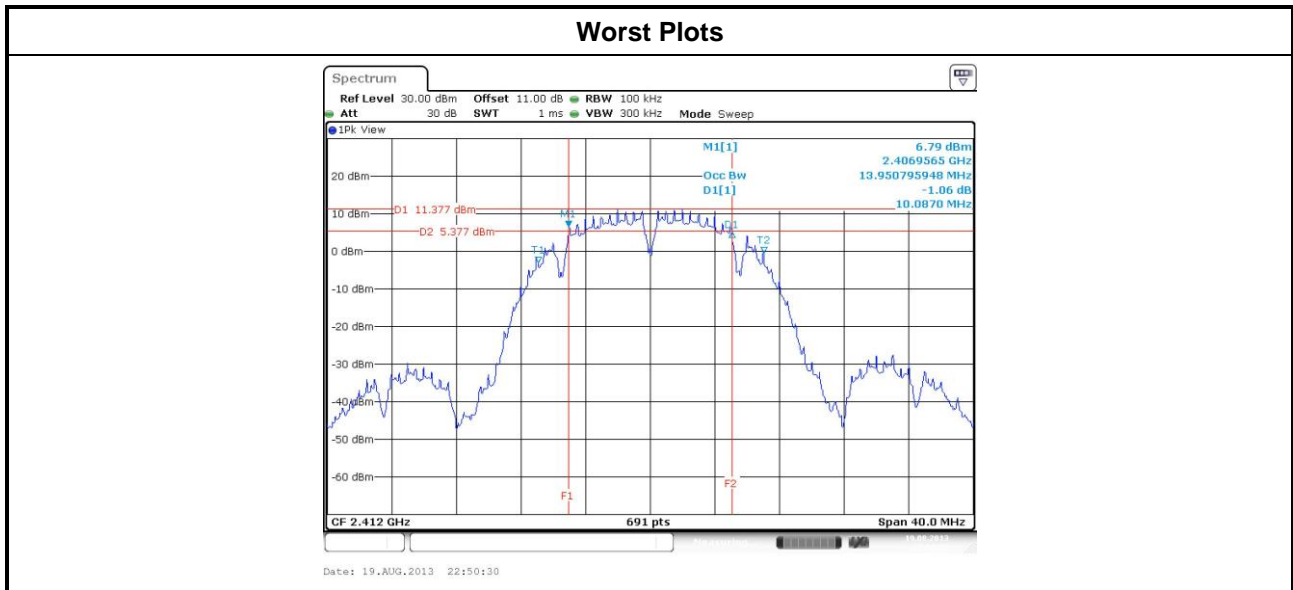

Modulation Mode	N _{TX}	Freq. (MHz)	99% Occupied Bandwidth (MHz)			
			Chain 0	Chain 1	Chain 2	Chain 3
11b	2	2412	13.89	13.89	---	---
11b	2	2437	14.07	14.07	---	---
11b	2	2462	14.01	14.12	---	---
11g	2	2412	17.08	16.90	---	---
11g	2	2437	17.13	16.79	---	---
11g	2	2462	17.25	16.90	---	---
HT20	2	2412	18.12	18.06	---	---
HT20	2	2437	18.18	18.12	---	---
HT20	2	2462	18.29	18.00	---	---
HT40	2	2422	38.21	37.40	---	---
HT40	2	2437	38.21	37.63	---	---
HT40	2	2452	38.78	38.32	---	---

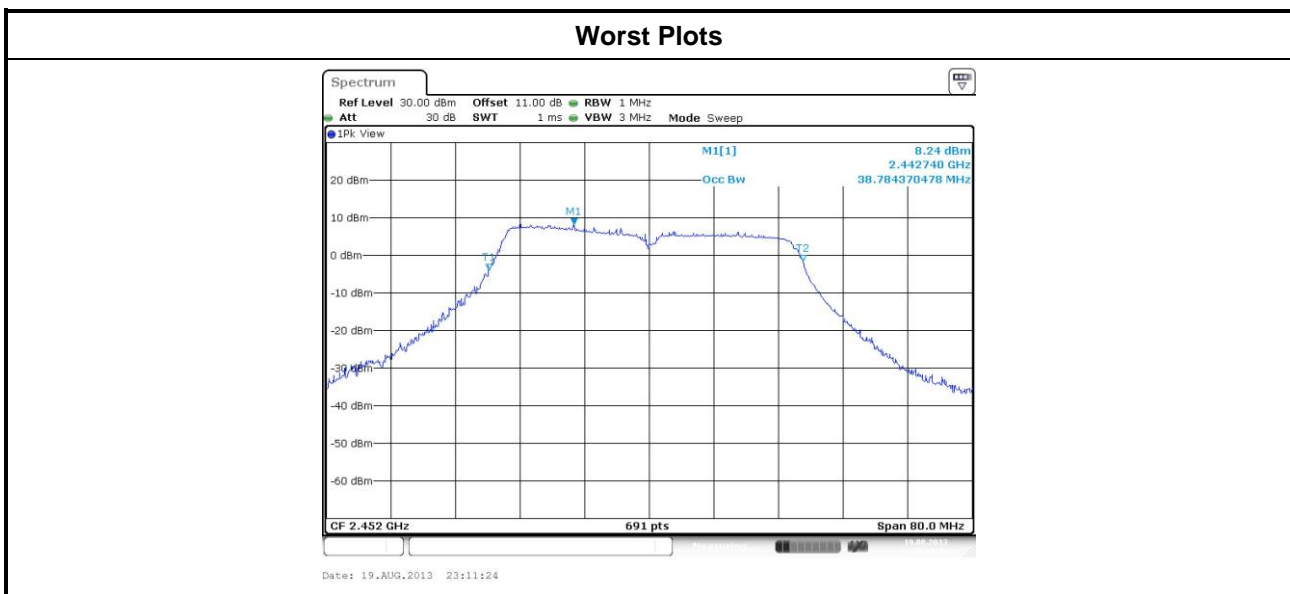

3.3 RF Output Power

3.3.1 Limit of RF Output Power

Conducted power shall not exceed 1Watt.

- Antenna gain \leq 6dBi, no any corresponding reduction is in output power limit.
- Antenna gain $>$ 6dBi
 - Non Fixed, point to point operations.
The conducted output power from the intentional radiator shall be reduced by the amount in dB that the directional gain of the antenna exceeds 6 dB
 - Fixed, point to point operations
Systems operating in the 2400–2483.5 MHz band that are used exclusively for fixed, point-to-point Operations, maximum peak output power of the intentional radiator is reduced by 1 dB for every 3 dB that the directional gain of the antenna exceeds 6 dBi.

Systems operating in the 5725–5850 MHz band that are used exclusively for fixed, point-to-point operations ,no any corresponding reduction is in transmitter peak output power

3.3.2 Test Procedures

- Maximum Peak Conducted Output Power
 - Spectrum analyzer**
 1. Set RBW = 1MHz, VBW = 3MHz, Detector = Peak.
 2. Sweep time = auto, Trace mode = max hold, Allow trace to fully stabilize.
 3. Use the spectrum analyzer channel power measurement function with the band limits set equal to the DTS bandwidth edges.
 - Power meter**
 1. A broadband Peak RF power meter is used for output power measurement. The video bandwidth of power meter is greater than DTS bandwidth of EUT. If duty cycle of test signal is not 100 %, trigger and gating function of power meter will be enabled to capture transmission burst for measuring output power.
- Maximum Conducted Output Power
 - Spectrum analyzer**
 1. Set RBW = 1MHz, VBW = 3MHz, Detector = RMS.
 2. Set the sweep time to: $\geq 10 \times$ (number of measurement points in sweep) \times (maximum data rate per stream).
 3. Perform the measurement over a single sweep.
 4. Use the spectrum analyzer's band power measurement function with band limits set equal to the EBW(26dBc) band edges.
 - Power meter**
 1. A broadband Average RF power meter is used for output power measurement. The video bandwidth of power meter is greater than DTS bandwidth of EUT. If duty cycle of test signal is not 100 %, trigger and gating function of power meter will be enabled to capture transmission burst for measuring output power.

3.3.3 Test Setup

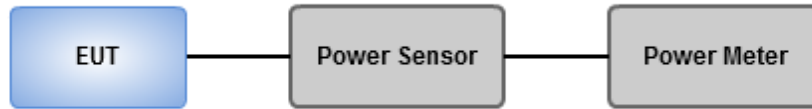

3.3.4 Test Result of Maximum Output Power

Modulation Mode	N _{TX}	Freq. (MHz)	Conducted output power (dBm)				Total Power (mW)	Total Power (dBm)	Limit (dBm)
			Chain 0	Chain 1	Chain 2	Chain 3			
11b	2	2412	22.69	22.14	---	---	349.462	25.43	30
11b	2	2437	26.75	26.46	---	---	915.740	29.62	30
11b	2	2462	22.65	22.32	---	---	354.685	25.50	30
11g	2	2412	26.21	26.05	---	---	820.547	29.14	30
11g	2	2437	26.74	26.08	---	---	877.572	29.43	30
11g	2	2462	25.12	24.89	---	---	633.406	28.02	30
HT20	2	2412	24.02	23.88	---	---	496.691	26.96	30
HT20	2	2437	26.42	26.34	---	---	869.057	29.39	30
HT20	2	2462	24.45	24.06	---	---	533.295	27.27	30
HT40	2	2422	21.12	20.74	---	---	247.996	23.94	30
HT40	2	2437	24.76	24.22	---	---	563.467	27.51	30
HT40	2	2452	20.99	20.02	---	---	226.065	23.54	30

3.4 Power Spectral Density

3.4.1 Limit of Power Spectral Density

Power spectral density shall not be greater than 8 dBm in any 3 kHz band.

3.4.2 Test Procedures

- Maximum peak conducted output power was used to demonstrate compliance to the fundamental output power limit.
 1. Set the RBW = 3kHz, VBW = 10kHz.
 2. Detector = Peak, Sweep time = auto couple.
 3. Trace mode = max hold, allow trace to fully stabilize.
 4. Use the peak marker function to determine the maximum amplitude level.
- Maximum (average) conducted output power was used to demonstrate compliance to the fundamental output power limit.
 1. Set the RBW = 100kHz, VBW = 300 kHz.
 2. Detector = RMS, Sweep time = auto couple.
 3. Set the sweep time to: $\geq 10 \times (\text{number of measurement points in sweep}) \times (\text{maximum data rate per stream})$.
 4. Perform the measurement over a single sweep.
 5. Use the peak marker function to determine the maximum amplitude level.\

3.4.3 Test Setup

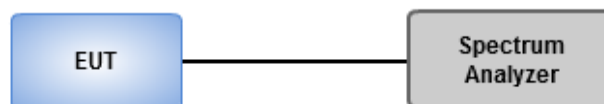

3.4.4 Test Result of Power Spectral Density

Modulation Mode	N _{TX}	Freq. (MHz)	Total Power Spectral Density (dBm/3kHz)	Limit (dBm/3kHz)
11b	2	2412	-0.54	5.99
11b	2	2437	4.91	5.99
11b	2	2462	0.38	5.99
11g	2	2412	-5.17	5.99
11g	2	2437	-4.22	5.99
11g	2	2462	-5.70	5.99
HT20	2	2412	-6.95	5.99
HT20	2	2437	-5.38	5.99
HT20	2	2462	-5.84	5.99
HT40	2	2422	-12.26	5.99
HT40	2	2437	-7.25	5.99
HT40	2	2452	-10.56	5.99

Note:

1. Test result is bin-by-bin summing measured value of each TX port.
2. Directional gain = $5 + 10 \cdot \log(2/1) = 8.01 \text{ dBi} > 6 \text{ dBi}$
Limit shall be reduced to $8 \text{ dBm} - (8.01 \text{ dBi} - 6 \text{ dBi}) = 5.99 \text{ dBm}$

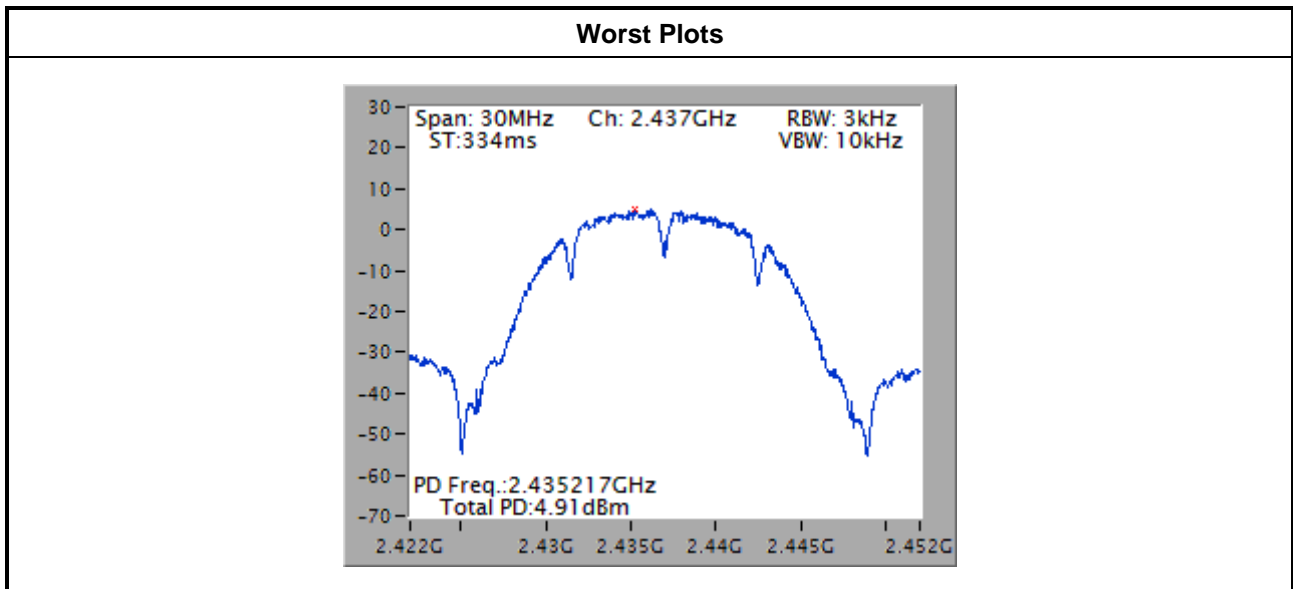

3.5 Unwanted Emissions into Restricted Frequency Bands

3.5.1 Limit of Unwanted Emissions into Restricted Frequency Bands

Restricted Band Emissions Limit			
Frequency Range (MHz)	Field Strength (uV/m)	Field Strength (dBuV/m)	Measure Distance (m)
0.009~0.490	2400/F(kHz)	48.5 - 13.8	300
0.490~1.705	24000/F(kHz)	33.8 - 23	30
1.705~30.0	30	29	30
30~88	100	40	3
88~216	150	43.5	3
216~960	200	46	3
Above 960	500	54	3

Note 1:
 Qusai-Peak value is measured for frequency below 1GHz except for 9–90 kHz, 110–490 kHz frequency band. Peak and average value are measured for frequency above 1GHz. The limit on average radio frequency emission is as above table. The limit on peak radio frequency emissions is 20 dB above the maximum permitted average emission limit

Note 2:
 Measurements may be performed at a distance other than what is specified provided. When performing measurements at a distance other than that specified, the results shall be extrapolated to the specified distance using an extrapolation factor as below, Frequency at or above 30 MHz: 20 dB/decade Frequency below 30 MHz: 40 dB/decade.

3.5.2 Test Procedures

1. Measurement is made at a semi-anechoic chamber that incorporates a turntable allowing a EUT rotation of 360°. A continuously-rotating, remotely-controlled turntable is installed at the test site to support the EUT and facilitate determination of the direction of maximum radiation for each EUT emission frequency. The EUT is placed at a height of 0.8 m test table above the ground plane.
2. Measurement is made with the antenna positioned in both the horizontal and vertical planes of polarization. The measurement antenna is varied in height (1m ~ 4m) above the reference ground plane to obtain the maximum signal strength. Distance between EUT and antenna is 3 m.
3. This investigation is performed with the EUT rotated 360°, the antenna height scanned between 1 m and 4 m, and the antenna rotated to repeat the measurements for both the horizontal and vertical antenna polarizations.

Note:

1. 120kHz measurement bandwidth of test receiver and Quasi-peak detector is for radiated emission below 1GHz.
2. RBW=1MHz, VBW=3MHz and Peak detector is for peak measured value of radiated emission above 1GHz.
3. RBW=1MHz, VBW=1/T and Peak detector is for average measured value of radiated emission above 1GHz.

3.5.3 Test Setup

Radiated Emissions below 1 GHz

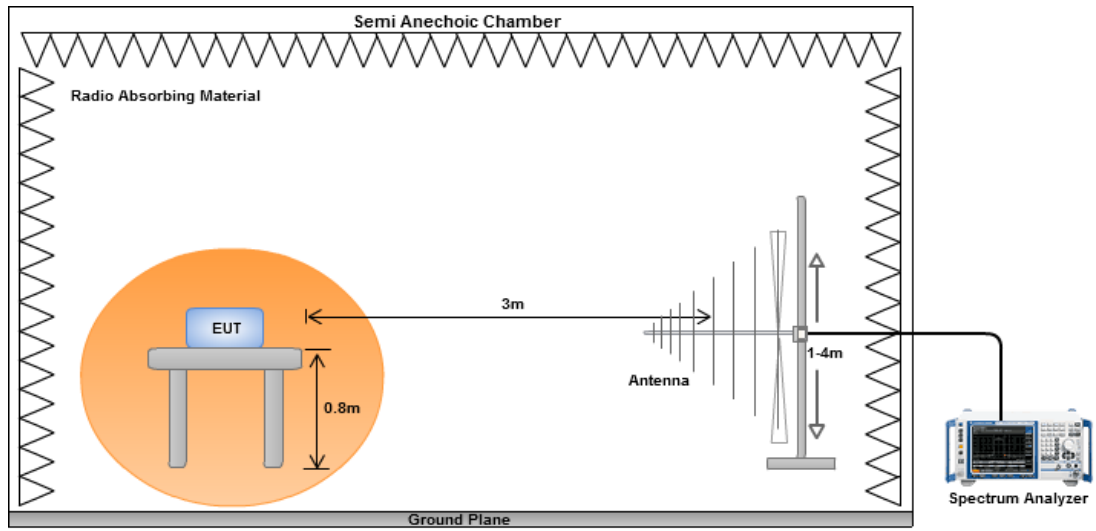

Radiated Emissions above 1 GHz

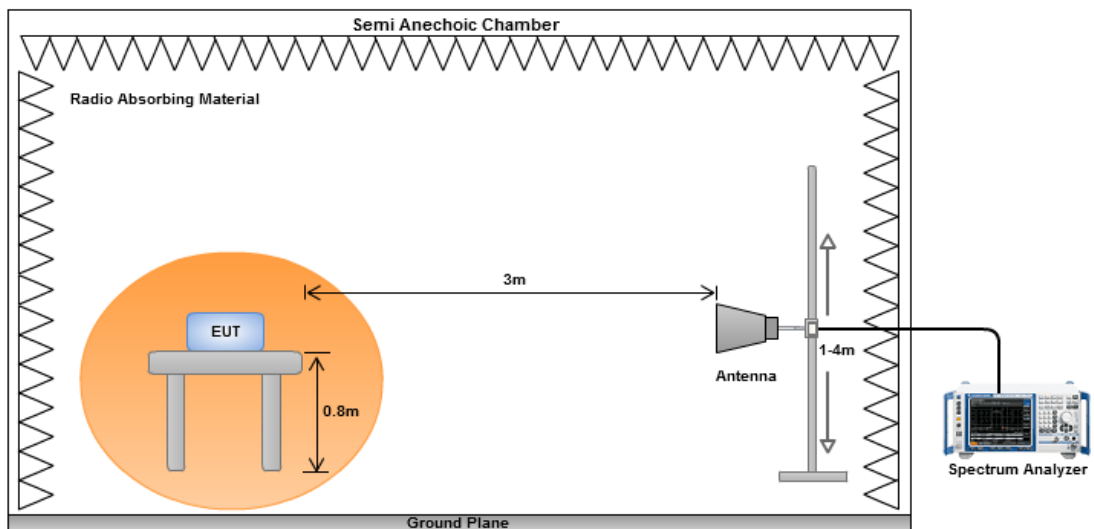

3.5.4 Transmitter Radiated Unwanted Emissions (Below 1GHz)

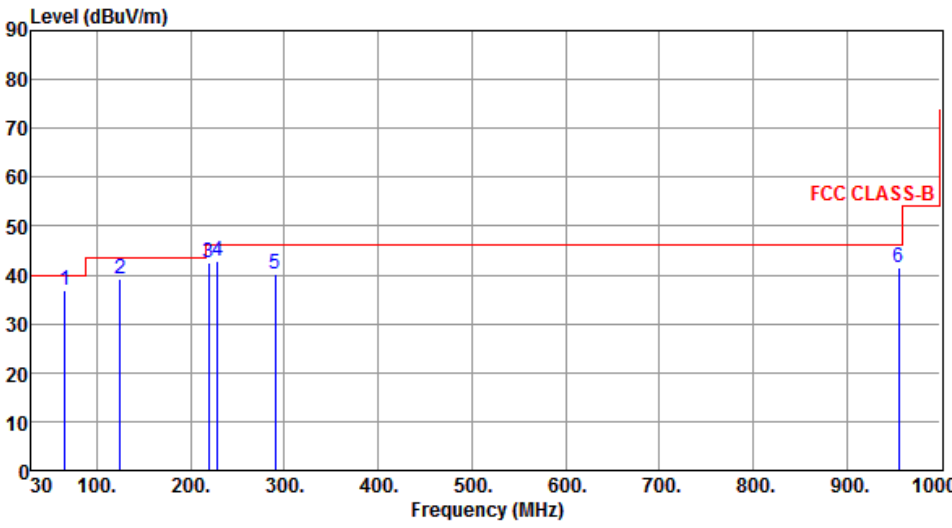
Polarization	Horizontal	Test Freq. (MHz)	2437						
Test Configuration	1								
									
	Freq. MHz	Emission level dBuV/m	Limit dBuV/m	Margin dB	SA reading dBuV	Factor dB	Remark	ANT High cm	Turn Table deg
1	65.89	36.86	40.00	-3.14	55.28	-18.42	Peak	---	---
2	125.06	39.33	43.50	-4.17	57.95	-18.62	Peak	---	---
3	219.15	42.58	46.00	-3.42	61.96	-19.38	Peak	---	---
4	228.85	42.88	46.00	-3.12	61.79	-18.91	Peak	---	---
5	289.96	40.23	46.00	-5.77	56.58	-16.35	Peak	---	---
6	955.38	41.58	46.00	-4.42	46.37	-4.79	Peak	---	---

Note 1: Emission Level (dBuV/m) = SA Reading (dBuV/m) + Factor* (dB)
*Factor includes antenna factor , cable loss and amplifier gain
Note 2: Margin (dB) = Emission level (dBuV/m) – Limit (dBuV/m).

Polarization	Vertical	Test Freq. (MHz)	2437
Test Configuration	1		

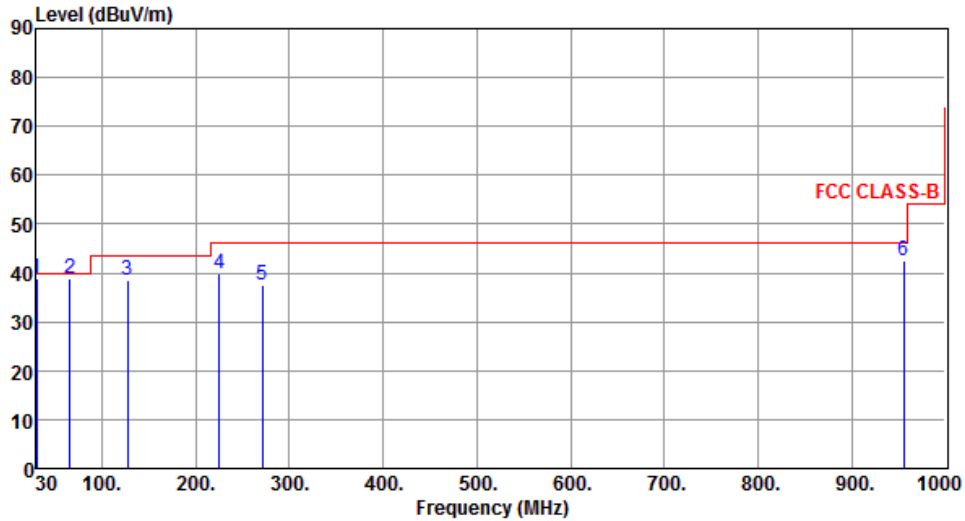

	Freq. MHz	Emission level dBUV/m	Limit dBUV/m	Margin dB	SA reading dBUV	Factor dB	Remark	ANT High cm	Turn Table deg
1	30.00	38.85	40.00	-1.15	56.58	-17.73	QP	---	---
2	65.82	38.91	40.00	-1.09	57.32	-18.41	QP	---	---
3	127.00	38.44	43.50	-5.06	56.86	-18.42	Peak	---	---
4	224.97	39.83	46.00	-6.17	58.95	-19.12	Peak	---	---
5	271.53	37.53	46.00	-8.47	54.54	-17.01	Peak	---	---
6	955.38	42.55	46.00	-3.45	47.34	-4.79	Peak	---	---

Note 1: Emission Level (dBUV/m) = SA Reading (dBUV/m) + Factor* (dB)

*Factor includes antenna factor , cable loss and amplifier gain

Note 2: Margin (dB) = Emission level (dBUV/m) – Limit (dBUV/m)

Polarization	Horizontal	Test Freq. (MHz)	2437
Test Configuration	2		

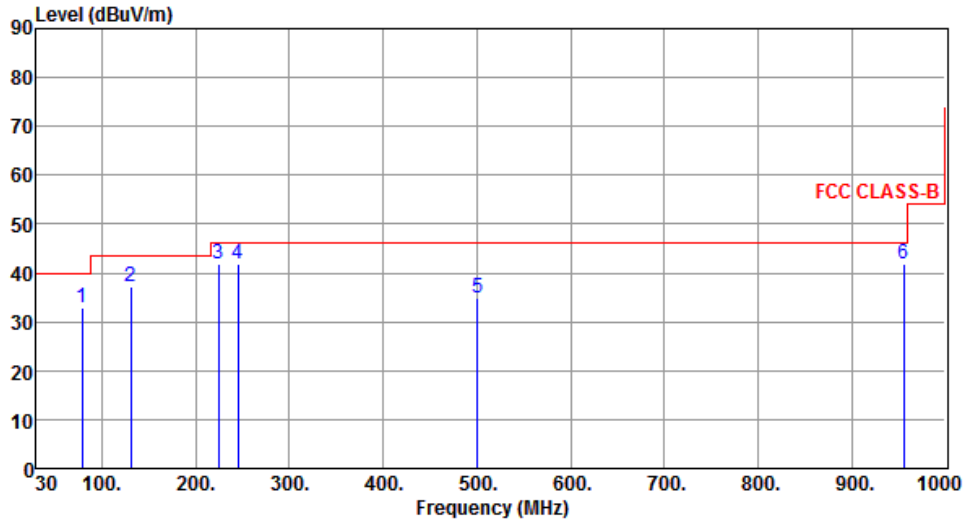

	Freq. MHz	Emission level dBUV/m	Limit dBUV/m	Margin dB	SA reading dBUV	Factor dB	Remark	ANT High cm	Turn Table deg
1	78.50	32.80	40.00	-7.20	54.22	-21.42	Peak	---	---
2	130.88	37.10	43.50	-6.40	55.14	-18.04	Peak	---	---
3	224.00	41.79	46.00	-4.21	60.96	-19.17	Peak	---	---
4	245.34	41.93	46.00	-4.07	59.91	-17.98	Peak	---	---
5	500.45	34.88	46.00	-11.12	46.44	-11.56	Peak	---	---
6	955.38	41.97	46.00	-4.03	46.76	-4.79	Peak	---	---

Note 1: Emission Level (dBUV/m) = SA Reading (dBUV/m) + Factor* (dB)

*Factor includes antenna factor , cable loss and amplifier gain

Note 2: Margin (dB) = Emission level (dBUV/m) – Limit (dBUV/m).

Polarization	Vertical	Test Freq. (MHz)	2437
Test Configuration	2		

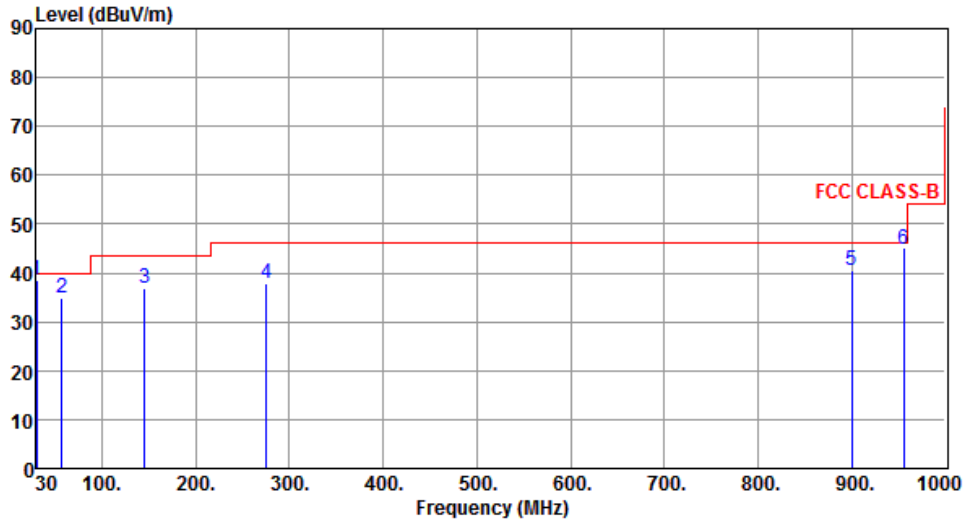

	Freq. MHz	Emission level dBuV/m	Limit dBuV/m	Margin dB	SA reading dBuV	Factor dB	Remark	ANT High cm	Turn Table deg
1	30.00	38.41	40.00	-1.59	56.14	-17.73	QP	---	---
2	56.92	34.76	40.00	-5.24	51.81	-17.05	QP	---	---
3	145.43	36.98	43.50	-6.52	54.04	-17.06	Peak	---	---
4	275.41	37.96	46.00	-8.04	54.80	-16.84	Peak	---	---
5	900.09	40.49	46.00	-5.51	46.00	-5.51	Peak	---	---
6	955.33	45.00	46.00	-1.00	49.79	-4.79	QP	---	---

Note 1: Emission Level (dBuV/m) = SA Reading (dBuV/m) + Factor* (dB)

*Factor includes antenna factor , cable loss and amplifier gain

Note 2: Margin (dB) = Emission level (dBuV/m) – Limit (dBuV/m)

3.5.5 Transmitter Radiated Unwanted Emissions (Above 1GHz) for 11b

Polarization	Horizontal	Test Freq. (MHz)	2412																																																													
	<table border="1"> <thead> <tr> <th>Freq. MHz</th> <th>Emission level dBuV/m</th> <th>Limit dBuV/m</th> <th>Margin dB</th> <th>SA reading dBuV</th> <th>Factor dB</th> <th>Remark</th> <th>ANT High cm</th> <th>Turn Table deg</th> </tr> </thead> <tbody> <tr> <td>1</td> <td>2386.00</td> <td>43.55</td> <td>54.00</td> <td>-10.45</td> <td>46.78</td> <td>-3.23</td> <td>Average</td> <td>---</td> </tr> <tr> <td>2</td> <td>2386.00</td> <td>50.99</td> <td>74.00</td> <td>-23.01</td> <td>54.22</td> <td>-3.23</td> <td>Peak</td> <td>---</td> </tr> <tr> <td>3</td> <td>2500.00</td> <td>40.24</td> <td>54.00</td> <td>-13.76</td> <td>43.00</td> <td>-2.76</td> <td>Average</td> <td>---</td> </tr> <tr> <td>4</td> <td>2500.00</td> <td>53.28</td> <td>74.00</td> <td>-20.72</td> <td>56.04</td> <td>-2.76</td> <td>Peak</td> <td>---</td> </tr> <tr> <td>5</td> <td>4824.00</td> <td>37.56</td> <td>54.00</td> <td>-16.44</td> <td>33.25</td> <td>4.31</td> <td>Average</td> <td>---</td> </tr> <tr> <td>6</td> <td>4824.00</td> <td>47.17</td> <td>74.00</td> <td>-26.83</td> <td>42.86</td> <td>4.31</td> <td>Peak</td> <td>---</td> </tr> </tbody> </table>	Freq. MHz	Emission level dBuV/m	Limit dBuV/m	Margin dB	SA reading dBuV	Factor dB	Remark	ANT High cm	Turn Table deg	1	2386.00	43.55	54.00	-10.45	46.78	-3.23	Average	---	2	2386.00	50.99	74.00	-23.01	54.22	-3.23	Peak	---	3	2500.00	40.24	54.00	-13.76	43.00	-2.76	Average	---	4	2500.00	53.28	74.00	-20.72	56.04	-2.76	Peak	---	5	4824.00	37.56	54.00	-16.44	33.25	4.31	Average	---	6	4824.00	47.17	74.00	-26.83	42.86	4.31	Peak	---
Freq. MHz	Emission level dBuV/m	Limit dBuV/m	Margin dB	SA reading dBuV	Factor dB	Remark	ANT High cm	Turn Table deg																																																								
1	2386.00	43.55	54.00	-10.45	46.78	-3.23	Average	---																																																								
2	2386.00	50.99	74.00	-23.01	54.22	-3.23	Peak	---																																																								
3	2500.00	40.24	54.00	-13.76	43.00	-2.76	Average	---																																																								
4	2500.00	53.28	74.00	-20.72	56.04	-2.76	Peak	---																																																								
5	4824.00	37.56	54.00	-16.44	33.25	4.31	Average	---																																																								
6	4824.00	47.17	74.00	-26.83	42.86	4.31	Peak	---																																																								
<p>Note 1: ">20dB" means spurious emission levels that exceed the level of 20 dB below the applicable limit.</p> <p>Note 2: For restricted bands, the peak measurement is fully sufficient, as the max field strength as measured with the Peak-Detector meets the AV-Limit so that the AV level does not need to be reported in addition.</p> <p>Note 3: For un-restricted bands, unwanted emissions shall be attenuated by at least 20 dB relative to the maximum measured in-band level.</p>																																																																

Polarization	Vertical	Test Freq. (MHz)	2412
---------------------	----------	-------------------------	------

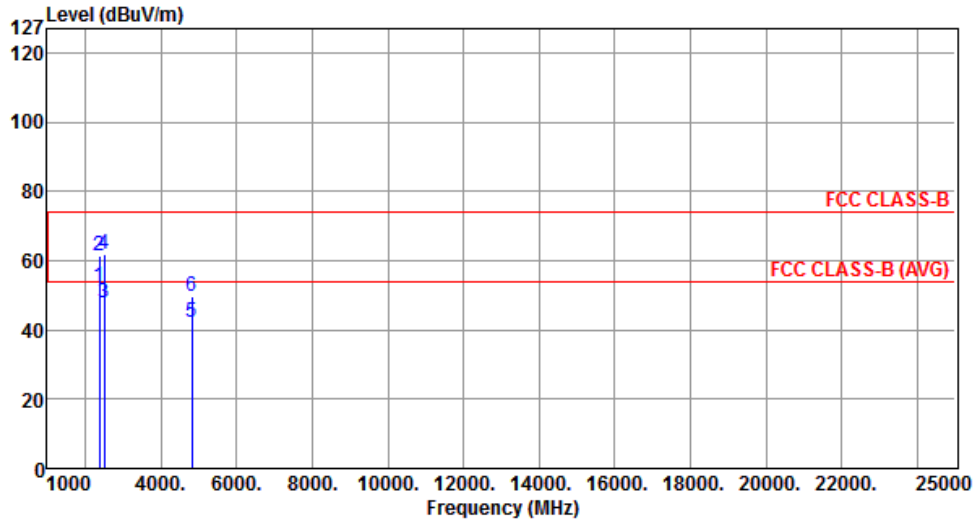

	Freq. MHz	Emission level dBuV/m	Limit dBuV/m	Margin dB	SA reading dBuV	Factor dB	Remark	ANT High cm	Turn Table deg
1	2386.00	52.45	54.00	-1.55	55.68	-3.23	Average	---	---
2	2386.00	61.34	74.00	-12.66	64.57	-3.23	Peak	---	---
3	2500.00	47.71	54.00	-6.29	50.47	-2.76	Average	---	---
4	2500.00	61.87	74.00	-12.13	64.63	-2.76	Peak	---	---
5	4824.00	41.99	54.00	-12.01	37.68	4.31	Average	---	---
6	4824.00	49.56	74.00	-24.44	45.25	4.31	Peak	---	---

Note 1: ">20dB" means spurious emission levels that exceed the level of 20 dB below the applicable limit.
 Note 2: For restricted bands, the peak measurement is fully sufficient, as the max field strength as measured with the Peak-Detector meets the AV-Limit so that the AV level does not need to be reported in addition.
 Note 3: For un-restricted bands, unwanted emissions shall be attenuated by at least 20 dB relative to the maximum measured in-band level.

Polarization	Horizontal	Test Freq. (MHz)	2437
---------------------	------------	-------------------------	------

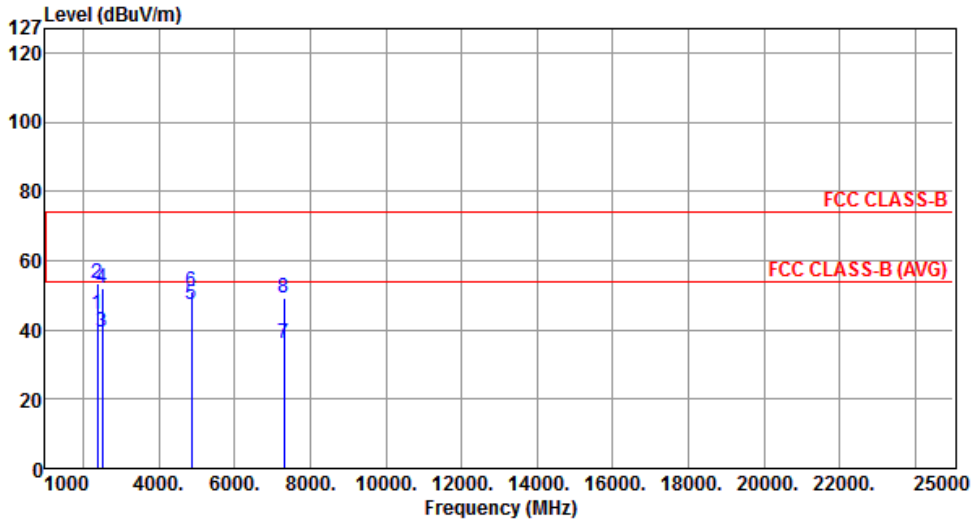

	Freq. MHz	Emission level dBuV/m	Limit dBuV/m	Margin dB	SA reading dBuV	Factor dB	Remark	ANT High cm	Turn Table deg
1	2371.00	44.37	54.00	-9.63	47.66	-3.29	Average	---	---
2	2371.00	53.61	74.00	-20.39	56.90	-3.29	Peak	---	---
3	2500.00	39.34	54.00	-14.66	42.10	-2.76	Average	---	---
4	2500.00	52.19	74.00	-21.81	54.95	-2.76	Peak	---	---
5	4874.00	47.30	54.00	-6.70	42.91	4.39	Average	---	---
6	4874.00	51.09	74.00	-22.91	46.70	4.39	Peak	---	---
7	7311.00	36.19	54.00	-17.81	27.27	8.92	Average	---	---
8	7311.00	49.27	74.00	-24.73	40.35	8.92	Peak	---	---

Note 1: ">20dB" means spurious emission levels that exceed the level of 20 dB below the applicable limit.
 Note 2: For restricted bands, the peak measurement is fully sufficient, as the max field strength as measured with the Peak-Detector meets the AV-Limit so that the AV level does not need to be reported in addition.
 Note 3: For un-restricted bands, unwanted emissions shall be attenuated by at least 20 dB relative to the maximum measured in-band level.

Polarization	Vertical	Test Freq. (MHz)	2437
---------------------	----------	-------------------------	------

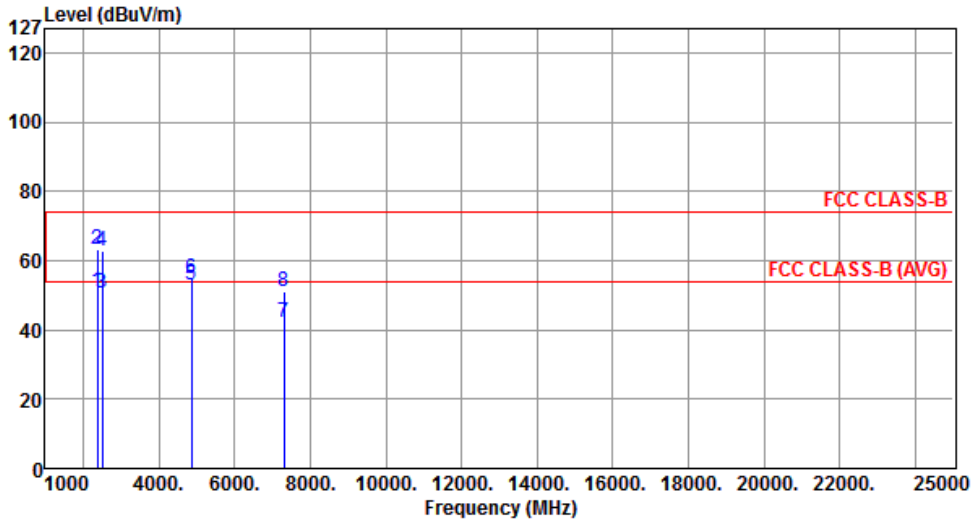

	Freq. MHz	Emission level dBuV/m	Limit dBuV/m	Margin dB	SA reading dBuV	Factor dB	Remark	ANT High cm	Turn Table deg
1	2371.00	50.86	54.00	-3.14	54.15	-3.29	Average	---	---
2	2371.00	63.46	74.00	-10.54	66.75	-3.29	Peak	---	---
3	2500.00	50.68	54.00	-3.32	53.44	-2.76	Average	---	---
4	2500.00	62.72	74.00	-11.28	65.48	-2.76	Peak	---	---
5	4874.00	52.94	54.00	-1.06	48.55	4.39	Average	---	---
6	4874.00	54.84	74.00	-19.16	50.45	4.39	Peak	---	---
7	7311.00	42.00	54.00	-12.00	33.08	8.92	Average	---	---
8	7311.00	50.87	74.00	-23.13	41.95	8.92	Peak	---	---

Note 1: ">20dB" means spurious emission levels that exceed the level of 20 dB below the applicable limit.
 Note 2: For restricted bands, the peak measurement is fully sufficient, as the max field strength as measured with the Peak-Detector meets the AV-Limit so that the AV level does not need to be reported in addition.
 Note 3: For un-restricted bands, unwanted emissions shall be attenuated by at least 20 dB relative to the maximum measured in-band level.

Polarization	Horizontal	Test Freq. (MHz)	2462
---------------------	------------	-------------------------	------

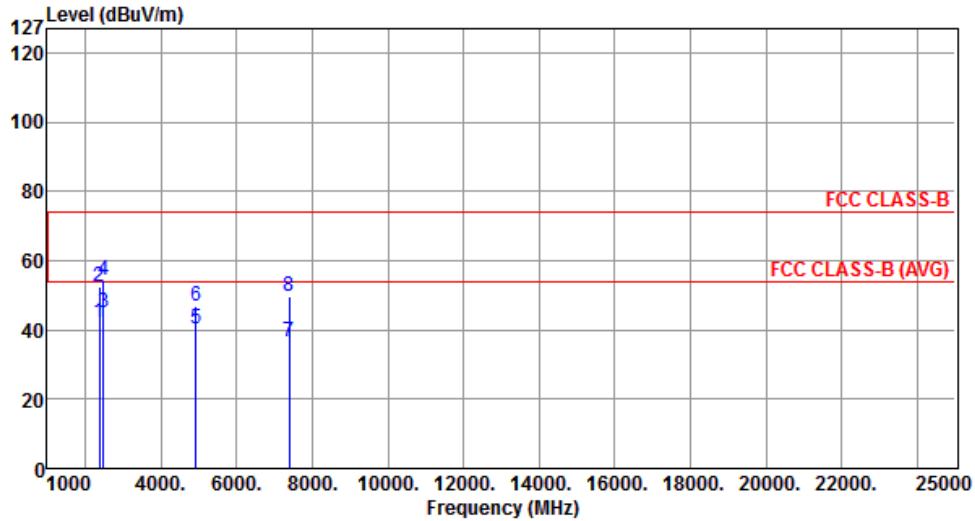

	Freq. MHz	Emission level dBuV/m	Limit dBuV/m	Margin dB	SA reading dBuV	Factor dB	Remark	ANT High cm	Turn Table deg
1	2384.00	42.25	54.00	-11.75	45.49	-3.24	Average	---	---
2	2384.00	52.37	74.00	-21.63	55.61	-3.24	Peak	---	---
3	2487.00	44.84	54.00	-9.16	47.66	-2.82	Average	---	---
4	2487.00	54.39	74.00	-19.61	57.21	-2.82	Peak	---	---
5	4924.00	40.34	54.00	-13.66	35.86	4.48	Average	---	---
6	4924.00	46.96	74.00	-27.04	42.48	4.48	Peak	---	---
7	7386.00	36.36	54.00	-17.64	27.38	8.98	Average	---	---
8	7386.00	49.57	74.00	-24.43	40.59	8.98	Peak	---	---

Note 1: ">20dB" means spurious emission levels that exceed the level of 20 dB below the applicable limit.
 Note 2: For restricted bands, the peak measurement is fully sufficient, as the max field strength as measured with the Peak-Detector meets the AV-Limit so that the AV level does not need to be reported in addition.
 Note 3: For un-restricted bands, unwanted emissions shall be attenuated by at least 20 dB relative to the maximum measured in-band level.

Polarization	Vertical	Test Freq. (MHz)	2462
---------------------	----------	-------------------------	------

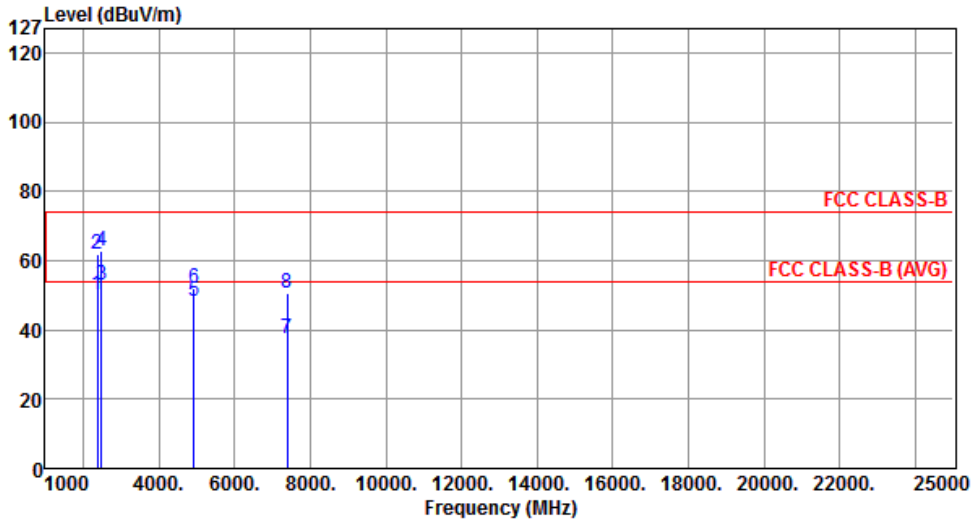

	Freq. MHz	Emission level dBuV/m	Limit dBuV/m	Margin dB	SA reading dBuV	Factor dB	Remark	ANT High cm	Turn Table deg
1	2384.00	50.25	54.00	-3.75	53.49	-3.24	Average	---	---
2	2384.00	61.85	74.00	-12.15	65.09	-3.24	Peak	---	---
3	2487.00	52.99	54.00	-1.01	55.81	-2.82	Average	---	---
4	2487.00	62.93	74.00	-11.07	65.75	-2.82	Peak	---	---
5	4924.00	48.41	54.00	-5.59	43.93	4.48	Average	---	---
6	4924.00	51.80	74.00	-22.20	47.32	4.48	Peak	---	---
7	7386.00	37.41	54.00	-16.59	28.43	8.98	Average	---	---
8	7386.00	50.65	74.00	-23.35	41.67	8.98	Peak	---	---

Note 1: ">20dB" means spurious emission levels that exceed the level of 20 dB below the applicable limit.
 Note 2: For restricted bands, the peak measurement is fully sufficient, as the max field strength as measured with the Peak-Detector meets the AV-Limit so that the AV level does not need to be reported in addition.
 Note 3: For un-restricted bands, unwanted emissions shall be attenuated by at least 20 dB relative to the maximum measured in-band level.

3.5.6 Transmitter Radiated Unwanted Emissions (Above 1GHz) for 11g

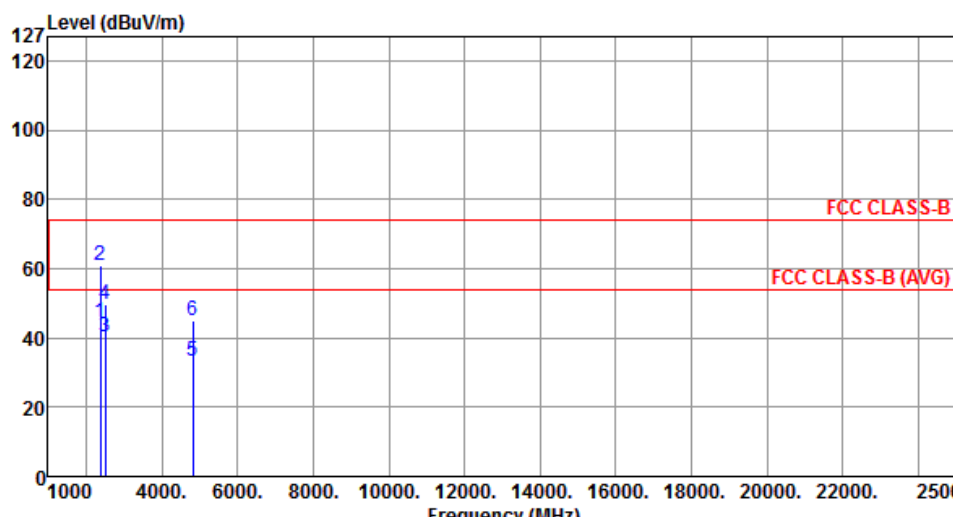
Polarization	Horizontal	Test Freq. (MHz)	2412						
									
	Freq.	Emission level	Limit	Margin	SA reading	Factor	Remark	ANT High	Turn Table
	MHz	dBuV/m	dBuV/m	dB	dBuV	dB		cm	deg
1	2390.00	44.57	54.00	-9.43	47.79	-3.22	Average	---	---
2	2390.00	61.03	74.00	-12.97	64.25	-3.22	Peak	---	---
3	2500.00	40.26	54.00	-13.74	43.02	-2.76	Average	---	---
4	2500.00	49.64	74.00	-24.36	52.40	-2.76	Peak	---	---
5	4824.00	33.19	54.00	-20.81	28.88	4.31	Average	---	---
6	4824.00	44.90	74.00	-29.10	40.59	4.31	Peak	---	---
<p>Note 1: ">20dB" means spurious emission levels that exceed the level of 20 dB below the applicable limit.</p> <p>Note 2: For restricted bands, the peak measurement is fully sufficient, as the max field strength as measured with the Peak-Detector meets the AV-Limit so that the AV level does not need to be reported in addition.</p> <p>Note 3: For un-restricted bands, unwanted emissions shall be attenuated by at least 20 dB relative to the maximum measured in-band level.</p>									

Polarization	Vertical	Test Freq. (MHz)	2412
---------------------	----------	-------------------------	------

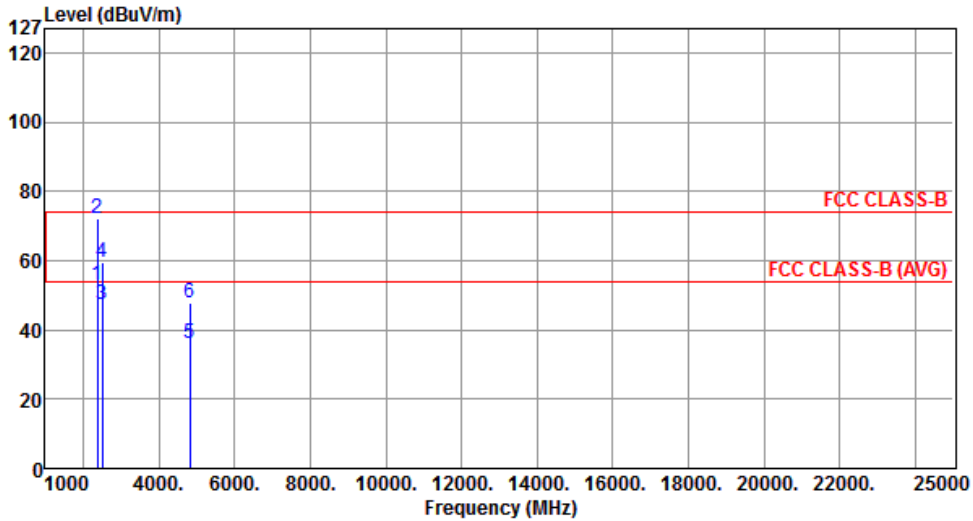

	Freq. MHz	Emission level dBuV/m	Limit dBuV/m	Margin dB	SA reading dBuV	Factor dB	Remark	ANT High cm	Turn Table deg
1	2390.00	52.99	54.00	-1.01	56.21	-3.22	Average	---	---
2	2390.00	72.40	74.00	-1.60	75.62	-3.22	Peak	---	---
3	2500.00	47.22	54.00	-6.78	49.98	-2.76	Average	---	---
4	2500.00	59.60	74.00	-14.40	62.36	-2.76	Peak	---	---
5	4824.00	35.89	54.00	-18.11	31.58	4.31	Average	---	---
6	4824.00	47.86	74.00	-26.14	43.55	4.31	Peak	---	---

Note 1: ">20dB" means spurious emission levels that exceed the level of 20 dB below the applicable limit.
 Note 2: For restricted bands, the peak measurement is fully sufficient, as the max field strength as measured with the Peak-Detector meets the AV-Limit so that the AV level does not need to be reported in addition.
 Note 3: For un-restricted bands, unwanted emissions shall be attenuated by at least 20 dB relative to the maximum measured in-band level.

Polarization	Horizontal	Test Freq. (MHz)	2437
---------------------	------------	-------------------------	------

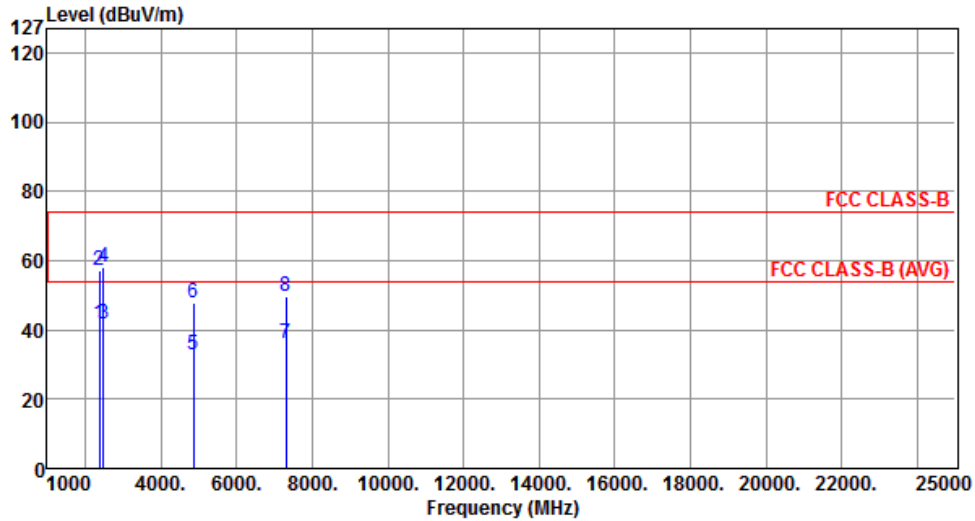

	Freq. MHz	Emission level dBuV/m	Limit dBuV/m	Margin dB	SA reading dBuV	Factor dB	Remark	ANT High cm	Turn Table deg
1	2390.00	41.59	54.00	-12.41	44.81	-3.22	Average	---	---
2	2390.00	57.03	74.00	-16.97	60.25	-3.22	Peak	---	---
3	2483.50	41.54	54.00	-12.46	44.37	-2.83	Average	---	---
4	2483.50	57.95	74.00	-16.05	60.78	-2.83	Peak	---	---
5	4874.00	32.88	54.00	-21.12	28.49	4.39	Average	---	---
6	4874.00	47.87	74.00	-26.13	43.48	4.39	Peak	---	---
7	7311.00	36.30	54.00	-17.70	27.38	8.92	Average	---	---
8	7311.00	49.47	74.00	-24.53	40.55	8.92	Peak	---	---

Note 1: ">20dB" means spurious emission levels that exceed the level of 20 dB below the applicable limit.

Note 2: For restricted bands, the peak measurement is fully sufficient, as the max field strength as measured with the Peak-Detector meets the AV-Limit so that the AV level does not need to be reported in addition.

Note 3: For un-restricted bands, unwanted emissions shall be attenuated by at least 20 dB relative to the maximum measured in-band level.

Polarization	Vertical	Test Freq. (MHz)	2437
---------------------	----------	-------------------------	------

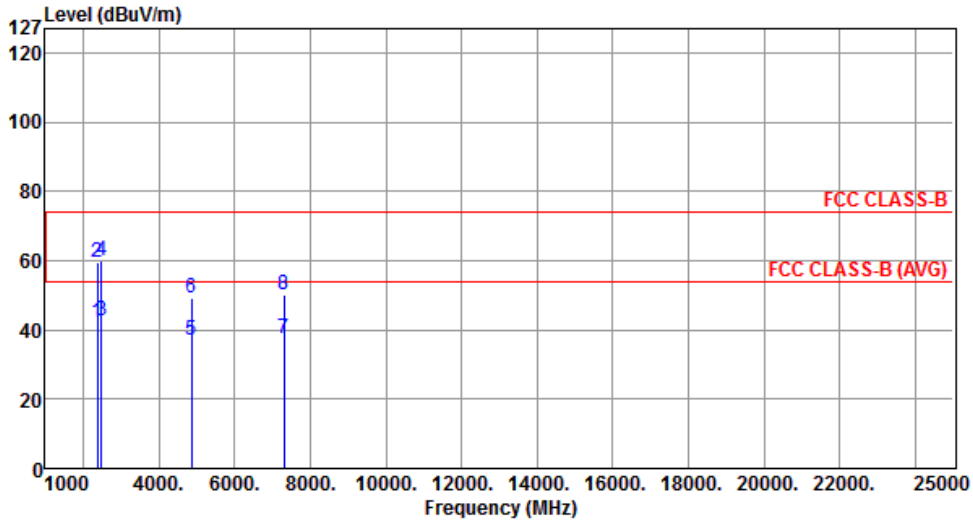

	Freq. MHz	Emission level dBuV/m	Limit dBuV/m	Margin dB	SA reading dBuV	Factor dB	Remark	ANT High cm	Turn Table deg
1	2390.00	42.38	54.00	-11.62	45.60	-3.22	Average	---	---
2	2390.00	59.44	74.00	-14.56	62.66	-3.22	Peak	---	---
3	2483.50	42.43	54.00	-11.57	45.26	-2.83	Average	---	---
4	2483.50	60.16	74.00	-13.84	62.99	-2.83	Peak	---	---
5	4874.00	36.96	54.00	-17.04	32.57	4.39	Average	---	---
6	4874.00	49.34	74.00	-24.66	44.95	4.39	Peak	---	---
7	7311.00	37.36	54.00	-16.64	28.44	8.92	Average	---	---
8	7311.00	50.34	74.00	-23.66	41.42	8.92	Peak	---	---

Note 1: ">20dB" means spurious emission levels that exceed the level of 20 dB below the applicable limit.

Note 2: For restricted bands, the peak measurement is fully sufficient, as the max field strength as measured with the Peak-Detector meets the AV-Limit so that the AV level does not need to be reported in addition.

Note 3: For un-restricted bands, unwanted emissions shall be attenuated by at least 20 dB relative to the maximum measured in-band level.

Polarization	Horizontal	Test Freq. (MHz)	2462
---------------------	------------	-------------------------	------

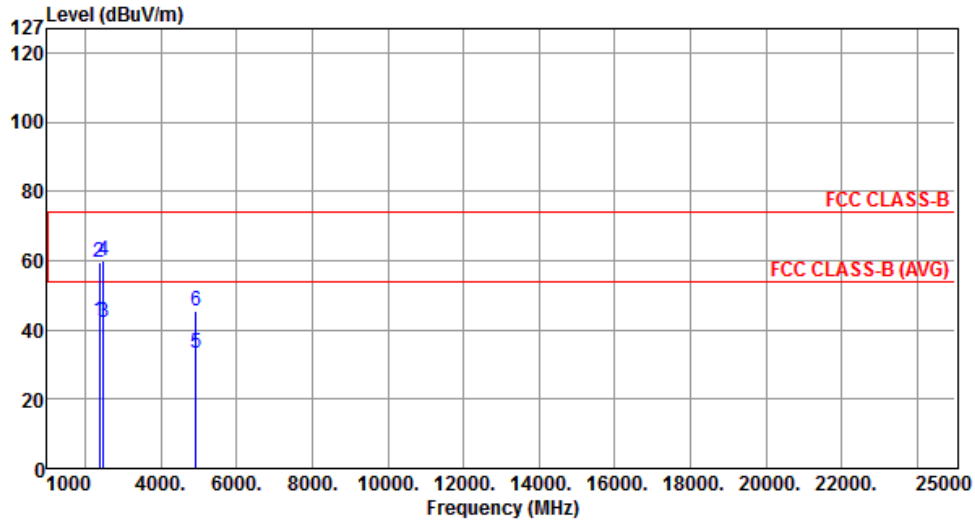

	Freq. MHz	Emission level dBuV/m	Limit dBuV/m	Margin dB	SA reading dBuV	Factor dB	Remark	ANT High cm	Turn Table deg
1	2373.00	42.51	54.00	-11.49	45.79	-3.28	Average	---	---
2	2373.00	59.48	74.00	-14.52	62.76	-3.28	Peak	---	---
3	2483.50	42.18	54.00	-11.82	45.01	-2.83	Average	---	---
4	2483.50	59.82	74.00	-14.18	62.65	-2.83	Peak	---	---
5	4924.00	33.36	54.00	-20.64	28.88	4.48	Average	---	---
6	4924.00	45.24	74.00	-28.76	40.76	4.48	Peak	---	---

Note 1: ">20dB" means spurious emission levels that exceed the level of 20 dB below the applicable limit.

Note 2: For restricted bands, the peak measurement is fully sufficient, as the max field strength as measured with the Peak-Detector meets the AV-Limit so that the AV level does not need to be reported in addition.

Note 3: For un-restricted bands, unwanted emissions shall be attenuated by at least 20 dB relative to the maximum measured in-band level.

Polarization	Vertical	Test Freq. (MHz)	2462
---------------------	----------	-------------------------	------

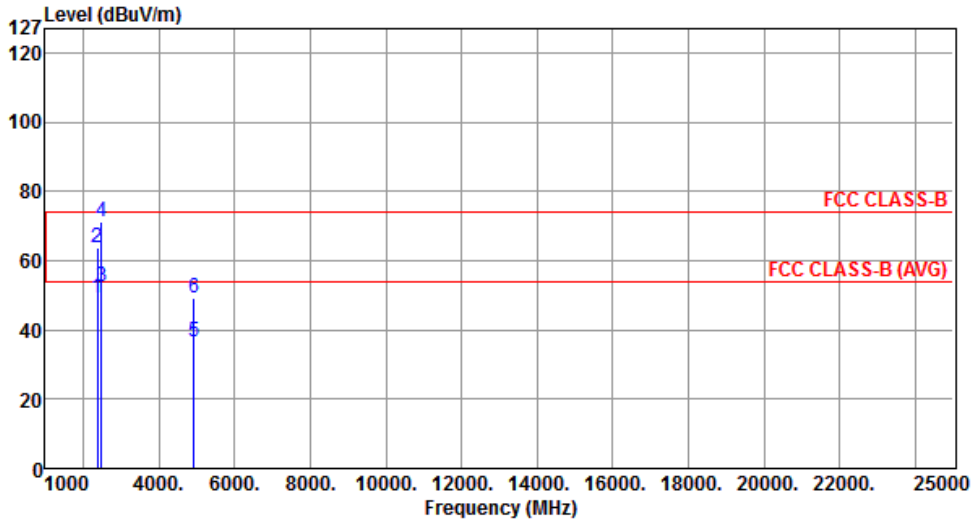

	Freq. MHz	Emission level dBuV/m	Limit dBuV/m	Margin dB	SA reading dBuV	Factor dB	Remark	ANT High cm	Turn Table deg
1	2373.00	49.17	54.00	-4.83	52.45	-3.28	Average	---	---
2	2373.00	63.80	74.00	-10.20	67.08	-3.28	Peak	---	---
3	2483.50	52.50	54.00	-1.50	55.33	-2.83	Average	---	---
4	2483.50	71.38	74.00	-2.62	74.21	-2.83	Peak	---	---
5	4924.00	36.43	54.00	-17.57	31.95	4.48	Average	---	---
6	4924.00	49.11	74.00	-24.89	44.63	4.48	Peak	---	---

Note 1: ">20dB" means spurious emission levels that exceed the level of 20 dB below the applicable limit.
 Note 2: For restricted bands, the peak measurement is fully sufficient, as the max field strength as measured with the Peak-Detector meets the AV-Limit so that the AV level does not need to be reported in addition.
 Note 3: For un-restricted bands, unwanted emissions shall be attenuated by at least 20 dB relative to the maximum measured in-band level.

3.5.7 Transmitter Radiated Unwanted Emissions (Above 1GHz) for HT20

Polarization	Horizontal	Test Freq. (MHz)	2412						
	Freq.	Emission level	Limit	Margin	SA reading	Factor	Remark	ANT High	Turn Table
	MHz	dBuV/m	dBuV/m	dB	dBuV	dB		cm	deg
1	2390.00	44.28	54.00	-9.72	47.50	-3.22	Average	---	---
2	2390.00	60.57	74.00	-13.43	63.79	-3.22	Peak	---	---
3	2500.00	40.35	54.00	-13.65	43.11	-2.76	Average	---	---
4	2500.00	49.54	74.00	-24.46	52.30	-2.76	Peak	---	---
5	4824.00	33.25	54.00	-20.75	28.94	4.31	Average	---	---
6	4824.00	44.73	74.00	-29.27	40.42	4.31	Peak	---	---
<p>Note 1: ">20dB" means spurious emission levels that exceed the level of 20 dB below the applicable limit. Note 2: For restricted bands, the peak measurement is fully sufficient, as the max field strength as measured with the Peak-Detector meets the AV-Limit so that the AV level does not need to be reported in addition. Note 3: For un-restricted bands, unwanted emissions shall be attenuated by at least 20 dB relative to the maximum measured in-band level.</p>									

Polarization	Vertical	Test Freq. (MHz)	2412
---------------------	----------	-------------------------	------

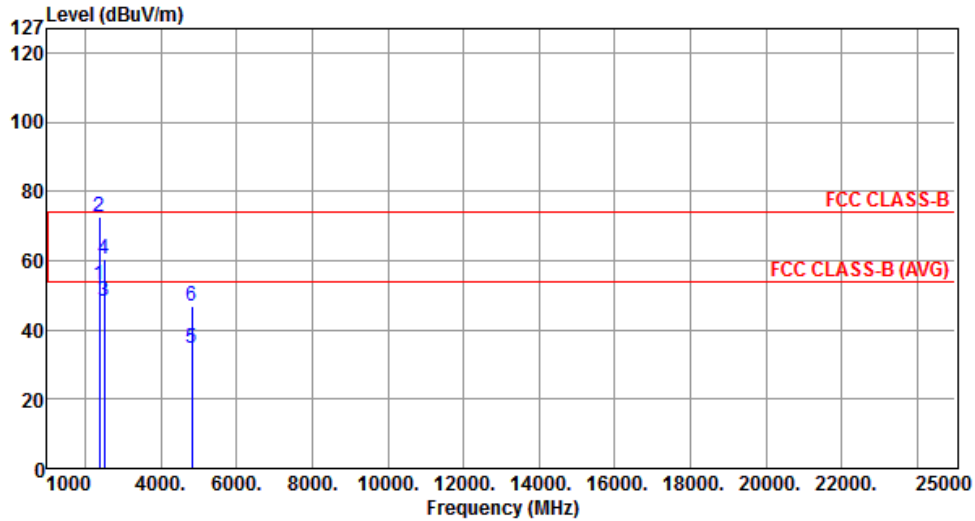

	Freq. MHz	Emission level dBuV/m	Limit dBuV/m	Margin dB	SA reading dBuV	Factor dB	Remark	ANT High cm	Turn Table deg
1	2390.00	53.00	54.00	-1.00	56.22	-3.22	Average	---	---
2	2390.00	72.51	74.00	-1.49	75.73	-3.22	Peak	---	---
3	2500.00	48.21	54.00	-5.79	50.97	-2.76	Average	---	---
4	2500.00	60.53	74.00	-13.47	63.29	-2.76	Peak	---	---
5	4824.00	34.88	54.00	-19.12	30.57	4.31	Average	---	---
6	4824.00	46.69	74.00	-27.31	42.38	4.31	Peak	---	---

Note 1: ">20dB" means spurious emission levels that exceed the level of 20 dB below the applicable limit.
 Note 2: For restricted bands, the peak measurement is fully sufficient, as the max field strength as measured with the Peak-Detector meets the AV-Limit so that the AV level does not need to be reported in addition.
 Note 3: For un-restricted bands, unwanted emissions shall be attenuated by at least 20 dB relative to the maximum measured in-band level.

Polarization	Horizontal	Test Freq. (MHz)	2437
---------------------	------------	-------------------------	------

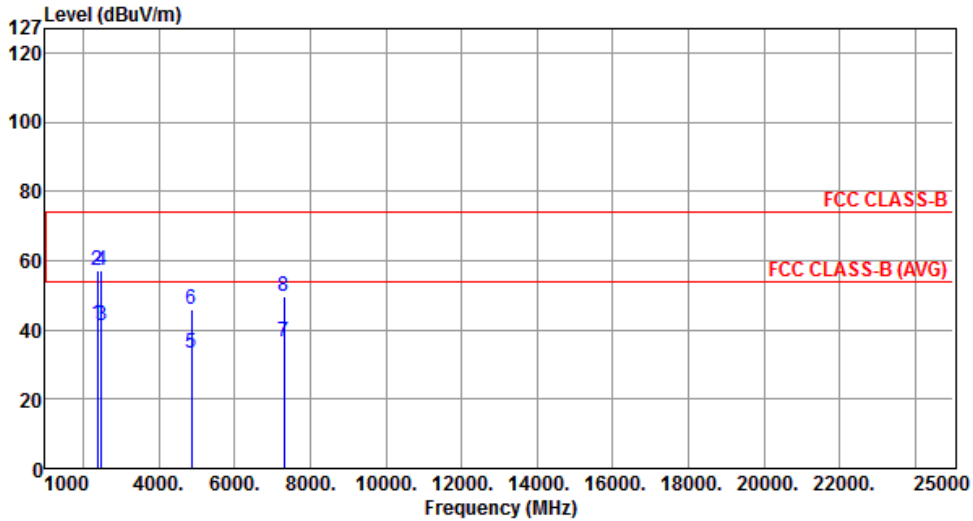

	Freq. MHz	Emission level dBuV/m	Limit dBuV/m	Margin dB	SA reading dBuV	Factor dB	Remark	ANT High cm	Turn Table deg
1	2390.00	41.64	54.00	-12.36	44.86	-3.22	Average	---	---
2	2390.00	57.35	74.00	-16.65	60.57	-3.22	Peak	---	---
3	2483.50	41.28	54.00	-12.72	44.11	-2.83	Average	---	---
4	2483.50	57.36	74.00	-16.64	60.19	-2.83	Peak	---	---
5	4874.00	33.14	54.00	-20.86	28.75	4.39	Average	---	---
6	4874.00	45.72	74.00	-28.28	41.33	4.39	Peak	---	---
7	7311.00	36.44	54.00	-17.56	27.52	8.92	Average	---	---
8	7311.00	49.56	74.00	-24.44	40.64	8.92	Peak	---	---

Note 1: ">20dB" means spurious emission levels that exceed the level of 20 dB below the applicable limit.
 Note 2: For restricted bands, the peak measurement is fully sufficient, as the max field strength as measured with the Peak-Detector meets the AV-Limit so that the AV level does not need to be reported in addition.
 Note 3: For un-restricted bands, unwanted emissions shall be attenuated by at least 20 dB relative to the maximum measured in-band level.

Polarization	Vertical	Test Freq. (MHz)	2437
---------------------	----------	-------------------------	------

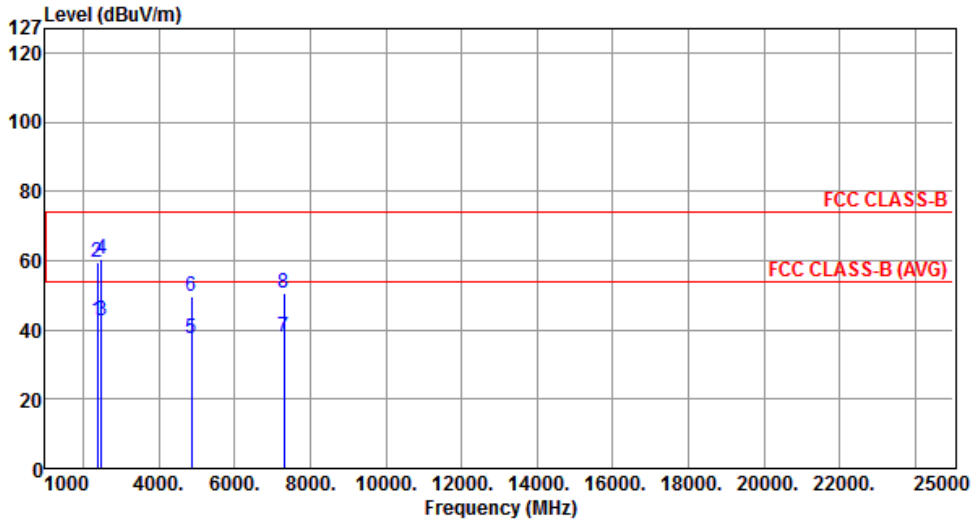

	Freq. MHz	Emission level dBuV/m	Limit dBuV/m	Margin dB	SA reading dBuV	Factor dB	Remark	ANT High cm	Turn Table deg
1	2390.00	42.45	54.00	-11.55	45.67	-3.22	Average	---	---
2	2390.00	59.31	74.00	-14.69	62.53	-3.22	Peak	---	---
3	2483.50	42.68	54.00	-11.32	45.51	-2.83	Average	---	---
4	2483.50	60.43	74.00	-13.57	63.26	-2.83	Peak	---	---
5	4874.00	37.26	54.00	-16.74	32.87	4.39	Average	---	---
6	4874.00	49.48	74.00	-24.52	45.09	4.39	Peak	---	---
7	7311.00	37.85	54.00	-16.15	28.93	8.92	Average	---	---
8	7311.00	50.56	74.00	-23.44	41.64	8.92	Peak	---	---

Note 1: ">20dB" means spurious emission levels that exceed the level of 20 dB below the applicable limit.

Note 2: For restricted bands, the peak measurement is fully sufficient, as the max field strength as measured with the Peak-Detector meets the AV-Limit so that the AV level does not need to be reported in addition.

Note 3: For un-restricted bands, unwanted emissions shall be attenuated by at least 20 dB relative to the maximum measured in-band level.

Polarization	Horizontal	Test Freq. (MHz)	2462
---------------------	------------	-------------------------	------

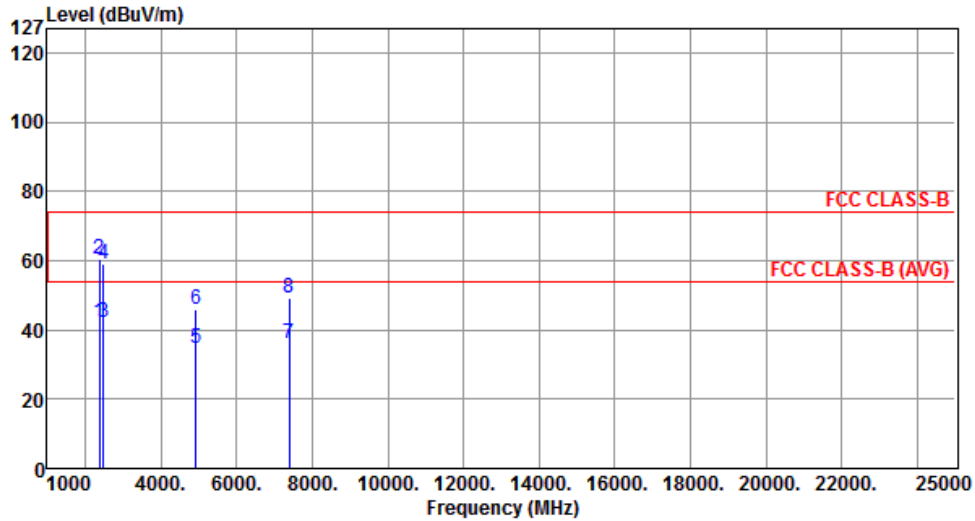

	Freq. MHz	Emission level dBuV/m	Limit dBuV/m	Margin dB	SA reading dBuV	Factor dB	Remark	ANT High cm	Turn Table deg
1	2373.00	42.38	54.00	-11.62	45.66	-3.28	Average	---	---
2	2373.00	60.47	74.00	-13.53	63.75	-3.28	Peak	---	---
3	2483.50	42.18	54.00	-11.82	45.01	-2.83	Average	---	---
4	2483.50	59.15	74.00	-14.85	61.98	-2.83	Peak	---	---
5	4924.00	34.63	54.00	-19.37	30.15	4.48	Average	---	---
6	4924.00	45.76	74.00	-28.24	41.28	4.48	Peak	---	---
7	7386.00	36.14	54.00	-17.86	27.16	8.98	Average	---	---
8	7386.00	49.31	74.00	-24.69	40.33	8.98	Peak	---	---

Note 1: ">20dB" means spurious emission levels that exceed the level of 20 dB below the applicable limit.
 Note 2: For restricted bands, the peak measurement is fully sufficient, as the max field strength as measured with the Peak-Detector meets the AV-Limit so that the AV level does not need to be reported in addition.
 Note 3: For un-restricted bands, unwanted emissions shall be attenuated by at least 20 dB relative to the maximum measured in-band level.

Polarization	Vertical	Test Freq. (MHz)	2462
---------------------	----------	-------------------------	------

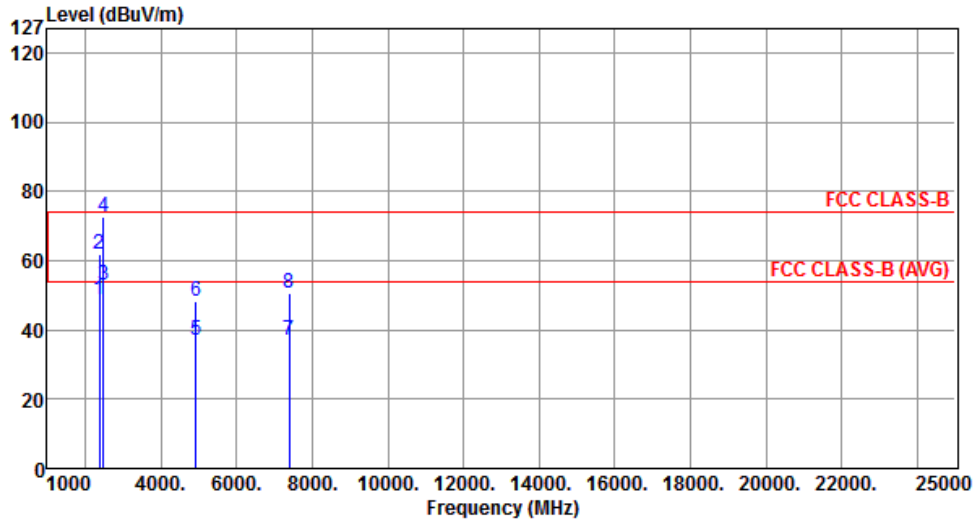

	Freq. MHz	Emission level dBuV/m	Limit dBuV/m	Margin dB	SA reading dBuV	Factor dB	Remark	ANT High cm	Turn Table deg
1	2373.00	48.79	54.00	-5.21	52.07	-3.28	Average	---	---
2	2373.00	61.98	74.00	-12.02	65.26	-3.28	Peak	---	---
3	2483.50	52.85	54.00	-1.15	55.68	-2.83	Average	---	---
4	2483.50	72.58	74.00	-1.42	75.41	-2.83	Peak	---	---
5	4924.00	36.96	54.00	-17.04	32.48	4.48	Average	---	---
6	4924.00	48.43	74.00	-25.57	43.95	4.48	Peak	---	---
7	7386.00	37.20	54.00	-16.80	28.22	8.98	Average	---	---
8	7386.00	50.40	74.00	-23.60	41.42	8.98	Peak	---	---

Note 1: ">20dB" means spurious emission levels that exceed the level of 20 dB below the applicable limit.
 Note 2: For restricted bands, the peak measurement is fully sufficient, as the max field strength as measured with the Peak-Detector meets the AV-Limit so that the AV level does not need to be reported in addition.
 Note 3: For un-restricted bands, unwanted emissions shall be attenuated by at least 20 dB relative to the maximum measured in-band level.

3.5.8 Transmitter Radiated Unwanted Emissions (Above 1GHz) for HT40

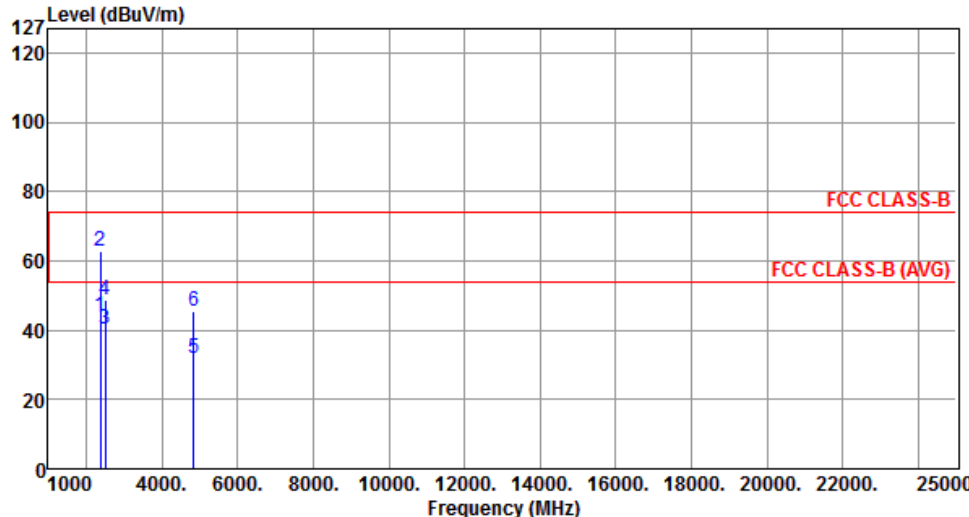
Polarization	Horizontal			Test Freq. (MHz)	2422				
 <p>The graph plots Level (dBuV/m) on the y-axis (0 to 127) against Frequency (MHz) on the x-axis (1000 to 25000). Two horizontal red lines represent limits: 'FCC CLASS-B' at approximately 74 dBuV/m and 'FCC CLASS-B (AVG)' at approximately 54 dBuV/m. Six vertical blue lines indicate measured peaks at various frequencies, labeled 1 through 6. Peak 2 is the highest, exceeding the FCC CLASS-B limit.</p>									
	Freq.	Emission level	Limit	Margin	SA reading	Factor	Remark	ANT High	Turn Table
	MHz	dBuV/m	dBuV/m	dB	dBuV	dB		cm	deg
1	2390.00	43.85	54.00	-10.15	47.07	-3.22	Average	---	---
2	2390.00	62.57	74.00	-11.43	65.79	-3.22	Peak	---	---
3	2500.00	40.25	54.00	-13.75	43.01	-2.76	Average	---	---
4	2500.00	48.65	74.00	-25.35	51.41	-2.76	Peak	---	---
5	4844.00	31.98	54.00	-22.02	27.64	4.34	Average	---	---
6	4844.00	45.27	74.00	-28.73	40.93	4.34	Peak	---	---

Note 1: ">20dB" means spurious emission levels that exceed the level of 20 dB below the applicable limit.
 Note 2: For restricted bands, the peak measurement is fully sufficient, as the max field strength as measured with the Peak-Detector meets the AV-Limit so that the AV level does not need to be reported in addition.
 Note 3: For un-restricted bands, unwanted emissions shall be attenuated by at least 20 dB relative to the maximum measured in-band level.

Polarization	Vertical	Test Freq. (MHz)	2422
---------------------	----------	-------------------------	------

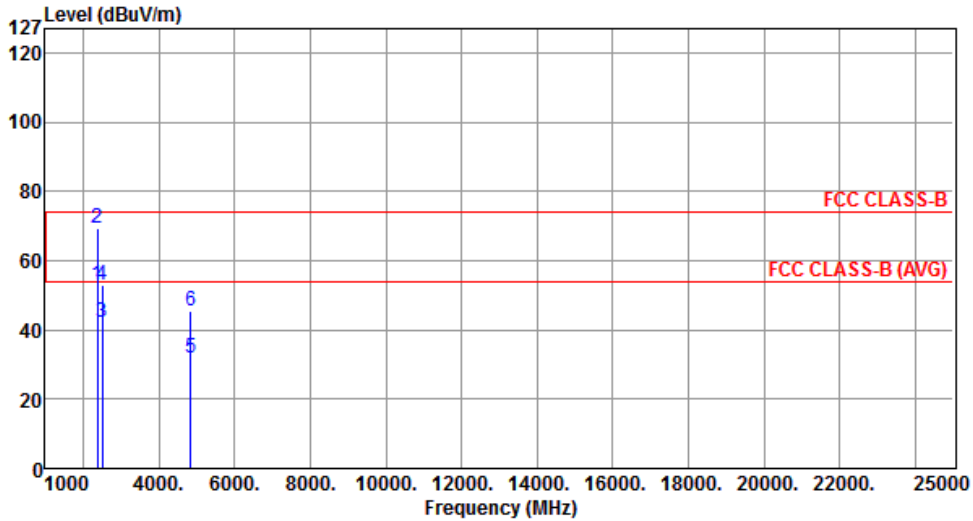

	Freq. MHz	Emission level dBuV/m	Limit dBuV/m	Margin dB	SA reading dBuV	Factor dB	Remark	ANT High cm	Turn Table deg
1	2390.00	52.98	54.00	-1.02	56.20	-3.22	Average	---	---
2	2390.00	69.46	74.00	-4.54	72.68	-3.22	Peak	---	---
3	2500.00	42.33	54.00	-11.67	45.09	-2.76	Average	---	---
4	2500.00	52.78	74.00	-21.22	55.54	-2.76	Peak	---	---
5	4844.00	31.89	54.00	-22.11	27.55	4.34	Average	---	---
6	4844.00	45.57	74.00	-28.43	41.23	4.34	Peak	---	---

Note 1: ">20dB" means spurious emission levels that exceed the level of 20 dB below the applicable limit.
 Note 2: For restricted bands, the peak measurement is fully sufficient, as the max field strength as measured with the Peak-Detector meets the AV-Limit so that the AV level does not need to be reported in addition.
 Note 3: For un-restricted bands, unwanted emissions shall be attenuated by at least 20 dB relative to the maximum measured in-band level.

Polarization	Horizontal	Test Freq. (MHz)	2437
---------------------	------------	-------------------------	------

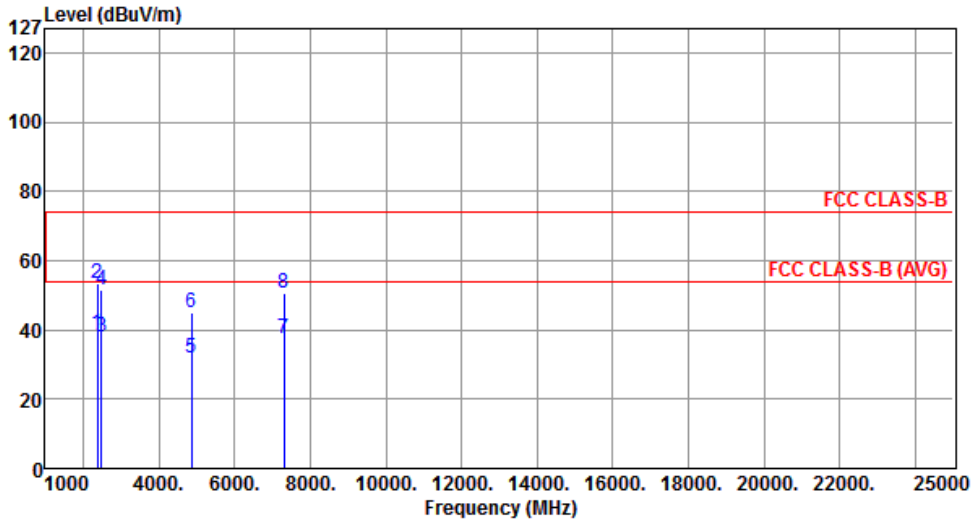

	Freq. MHz	Emission level dBuV/m	Limit dBuV/m	Margin dB	SA reading dBuV	Factor dB	Remark	ANT High cm	Turn Table deg
1	2390.00	39.12	54.00	-14.88	42.34	-3.22	Average	---	---
2	2390.00	53.53	74.00	-20.47	56.75	-3.22	Peak	---	---
3	2483.50	37.75	54.00	-16.25	40.58	-2.83	Average	---	---
4	2483.50	51.67	74.00	-22.33	54.50	-2.83	Peak	---	---
5	4874.00	32.07	54.00	-21.93	27.68	4.39	Average	---	---
6	4874.00	45.00	74.00	-29.00	40.61	4.39	Peak	---	---
7	7311.00	37.52	54.00	-16.48	28.60	8.92	Average	---	---
8	7311.00	50.39	74.00	-23.61	41.47	8.92	Peak	---	---

Note 1: ">20dB" means spurious emission levels that exceed the level of 20 dB below the applicable limit.
 Note 2: For restricted bands, the peak measurement is fully sufficient, as the max field strength as measured with the Peak-Detector meets the AV-Limit so that the AV level does not need to be reported in addition.
 Note 3: For un-restricted bands, unwanted emissions shall be attenuated by at least 20 dB relative to the maximum measured in-band level.

Polarization	Vertical	Test Freq. (MHz)	2437
---------------------	----------	-------------------------	------

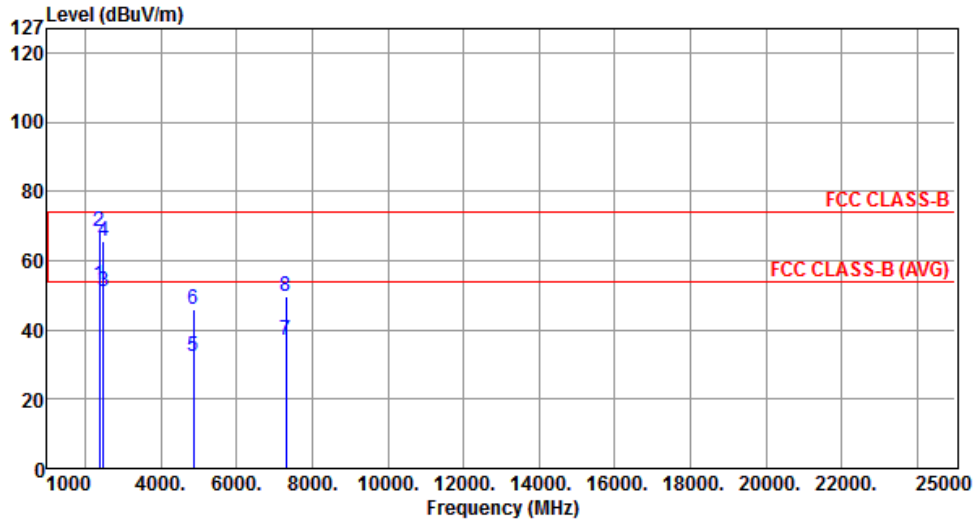

	Freq. MHz	Emission level dBuV/m	Limit dBuV/m	Margin dB	SA reading dBuV	Factor dB	Remark	ANT High cm	Turn Table deg
1	2390.00	53.00	54.00	-1.00	56.22	-3.22	Average	---	---
2	2390.00	68.49	74.00	-5.51	71.71	-3.22	Peak	---	---
3	2483.50	50.95	54.00	-3.05	53.78	-2.83	Average	---	---
4	2483.50	65.70	74.00	-8.30	68.53	-2.83	Peak	---	---
5	4874.00	32.53	54.00	-21.47	28.14	4.39	Average	---	---
6	4874.00	45.78	74.00	-28.22	41.39	4.39	Peak	---	---
7	7311.00	37.14	54.00	-16.86	28.22	8.92	Average	---	---
8	7311.00	49.75	74.00	-24.25	40.83	8.92	Peak	---	---

Note 1: ">20dB" means spurious emission levels that exceed the level of 20 dB below the applicable limit.
 Note 2: For restricted bands, the peak measurement is fully sufficient, as the max field strength as measured with the Peak-Detector meets the AV-Limit so that the AV level does not need to be reported in addition.
 Note 3: For un-restricted bands, unwanted emissions shall be attenuated by at least 20 dB relative to the maximum measured in-band level.

Polarization	Horizontal	Test Freq. (MHz)	2452
---------------------	------------	-------------------------	------

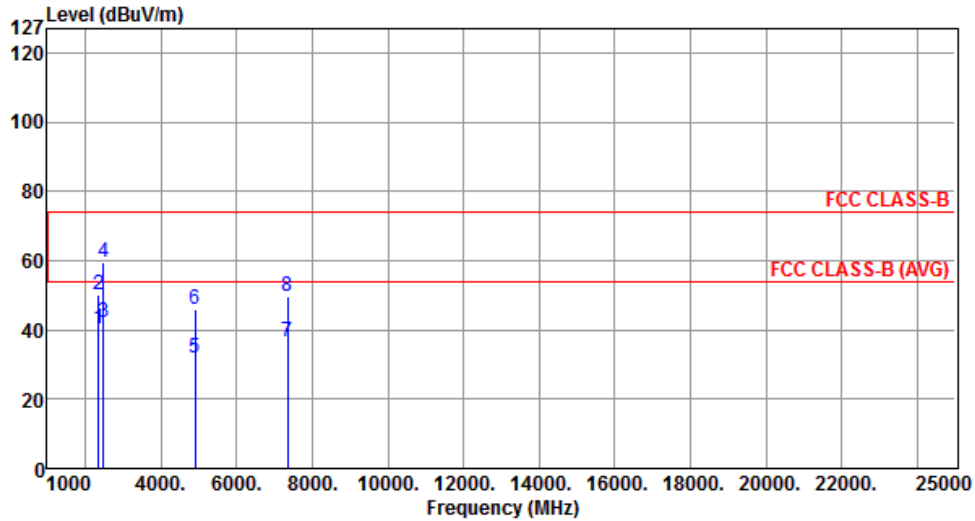

	Freq. MHz	Emission level dBuV/m	Limit dBuV/m	Margin dB	SA reading dBuV	Factor dB	Remark	ANT High cm	Turn Table deg
1	2363.00	40.15	54.00	-13.85	43.47	-3.32	Average	---	---
2	2363.00	50.13	74.00	-23.87	53.45	-3.32	Peak	---	---
3	2483.50	42.38	54.00	-11.62	45.21	-2.83	Average	---	---
4	2483.50	59.44	74.00	-14.56	62.27	-2.83	Peak	---	---
5	4904.00	31.76	54.00	-22.24	27.31	4.45	Average	---	---
6	4904.00	45.72	74.00	-28.28	41.27	4.45	Peak	---	---
7	7356.00	36.39	54.00	-17.61	27.43	8.96	Average	---	---
8	7356.00	49.68	74.00	-24.32	40.72	8.96	Peak	---	---

Note 1: ">20dB" means spurious emission levels that exceed the level of 20 dB below the applicable limit.
 Note 2: For restricted bands, the peak measurement is fully sufficient, as the max field strength as measured with the Peak-Detector meets the AV-Limit so that the AV level does not need to be reported in addition.
 Note 3: For un-restricted bands, unwanted emissions shall be attenuated by at least 20 dB relative to the maximum measured in-band level.

Polarization	Vertical	Test Freq. (MHz)	2452
---------------------	----------	-------------------------	------

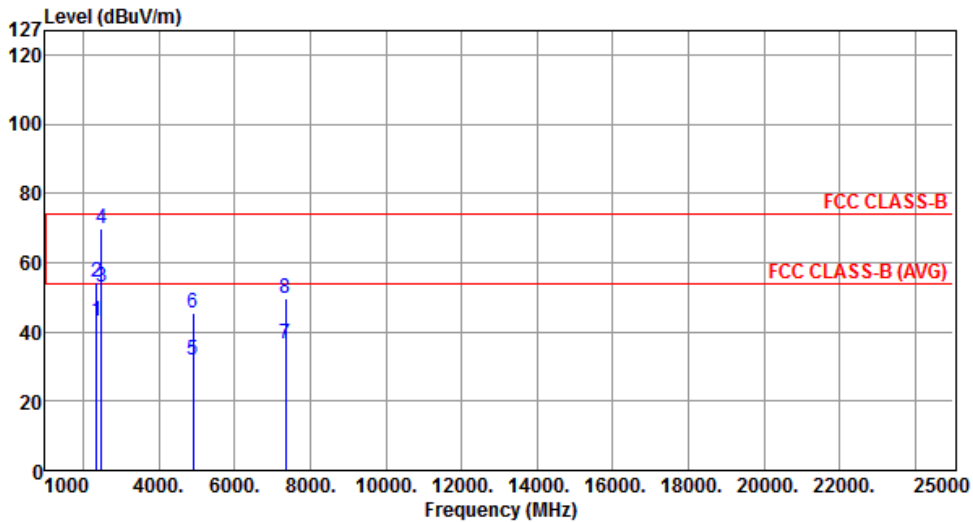

	Freq. MHz	Emission level dBuV/m	Limit dBuV/m	Margin dB	SA reading dBuV	Factor dB	Remark	ANT High cm	Turn Table deg
1	2363.00	43.22	54.00	-10.78	46.54	-3.32	Average	---	---
2	2363.00	54.28	74.00	-19.72	57.60	-3.32	Peak	---	---
3	2483.50	52.97	54.00	-1.03	55.80	-2.83	Average	---	---
4	2483.50	70.02	74.00	-3.98	72.85	-2.83	Peak	---	---
5	4904.00	31.70	54.00	-22.30	27.25	4.45	Average	---	---
6	4904.00	45.59	74.00	-28.41	41.14	4.45	Peak	---	---
7	7356.00	36.40	54.00	-17.60	27.44	8.96	Average	---	---
8	7356.00	49.81	74.00	-24.19	40.85	8.96	Peak	---	---

Note 1: ">20dB" means spurious emission levels that exceed the level of 20 dB below the applicable limit.
 Note 2: For restricted bands, the peak measurement is fully sufficient, as the max field strength as measured with the Peak-Detector meets the AV-Limit so that the AV level does not need to be reported in addition.
 Note 3: For un-restricted bands, unwanted emissions shall be attenuated by at least 20 dB relative to the maximum measured in-band level.

3.6 Unwanted Emissions into Non-Restricted Frequency Bands

3.6.1 Limit of Unwanted Emissions into Non-Restricted Frequency Bands

- The peak output power measured in any 100 kHz bandwidth outside of the authorized frequency band shall be attenuated by at least 20 dB relative to the maximum in-band peak PSD level in 100 kHz.
- The peak power in any 100 kHz bandwidth outside of the authorized frequency band shall be attenuated by at least 30 dB relative to the maximum in-band peak PSD level in 100 kHz.

3.6.2 Test Procedures

Reference Level Measurement

1. Set the RBW = 100 kHz, VBW = 300 kHz, Detector = peak.
2. Set Sweep time = auto couple, Trace mode = max hold.
3. Allow trace to fully stabilize.
4. Use the peak marker function to determine the maximum amplitude level.

Unwanted Emissions Level Measurement

1. Set RBW = 100 kHz, VBW = 300 kHz, Detector = peak.
2. Trace Mode = max hold, Sweep = auto couple.
3. Allow the trace to stabilize.
4. Use peak marker function to determine maximum amplitude of all unwanted emissions within any 100 kHz bandwidth.

3.6.3 Test Setup

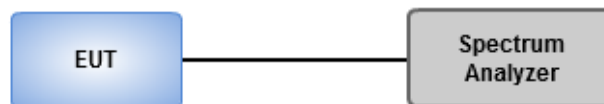

3.6.4 Unwanted Emissions into Non-Restricted Frequency Bands

802.11b

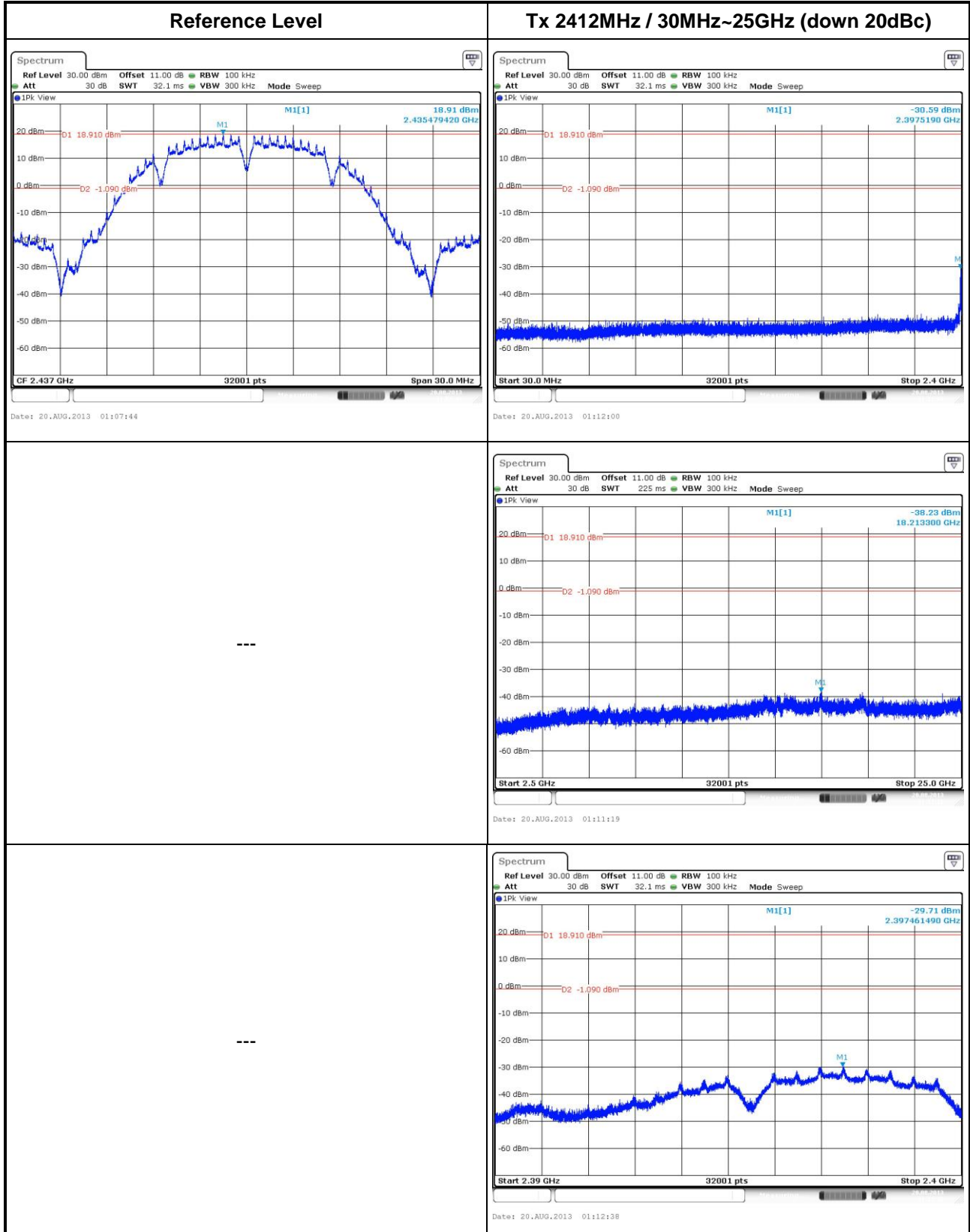

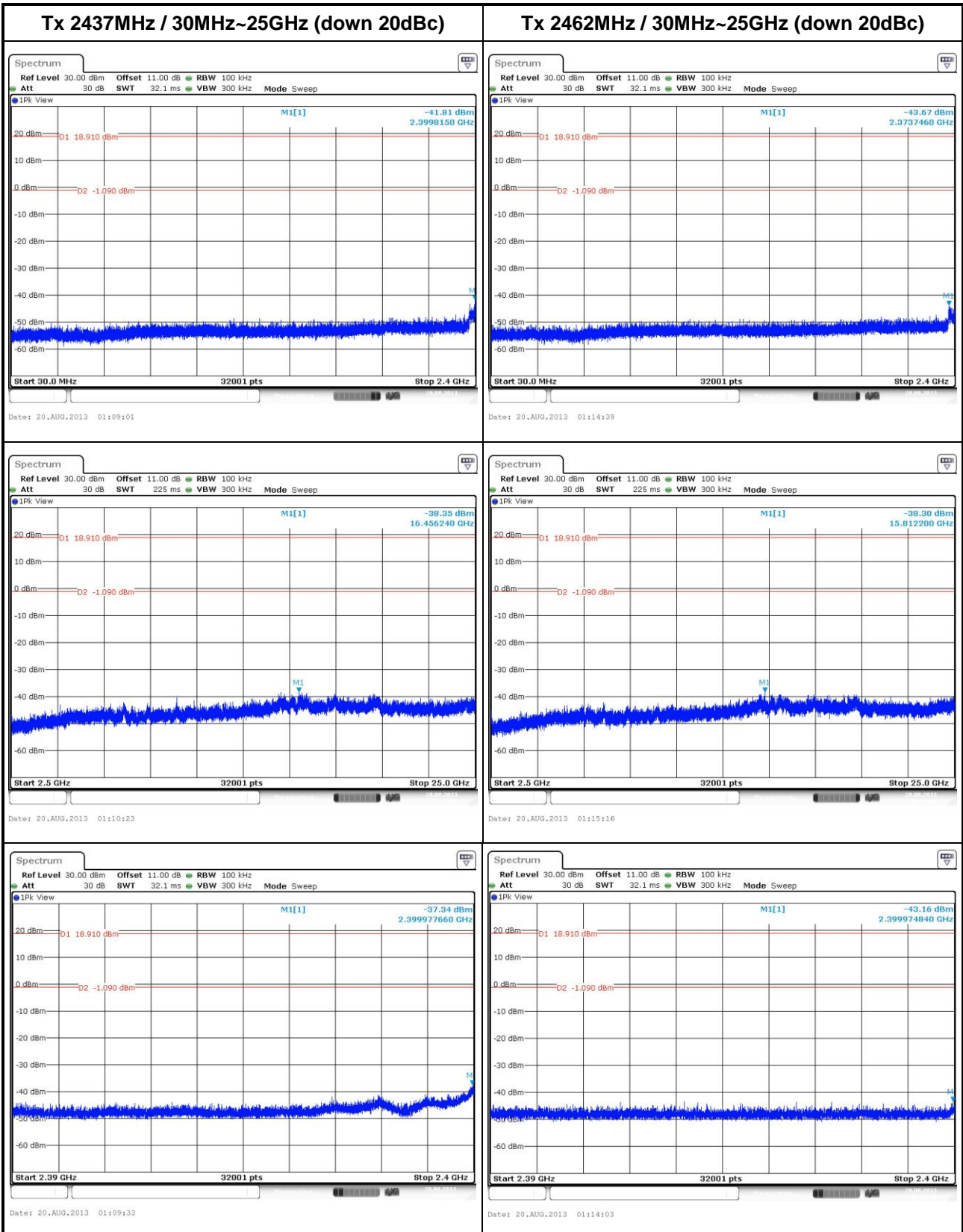

802.11g

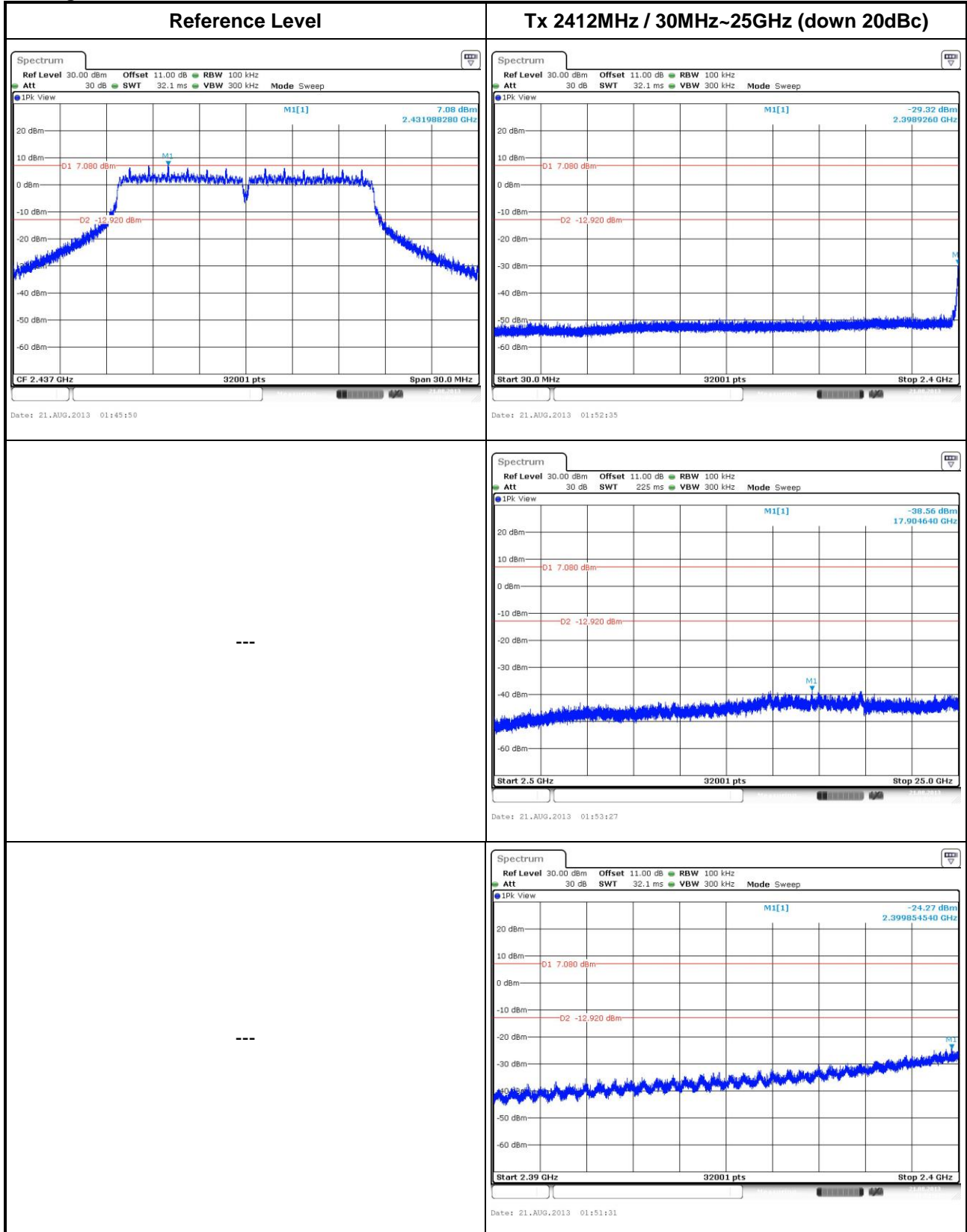

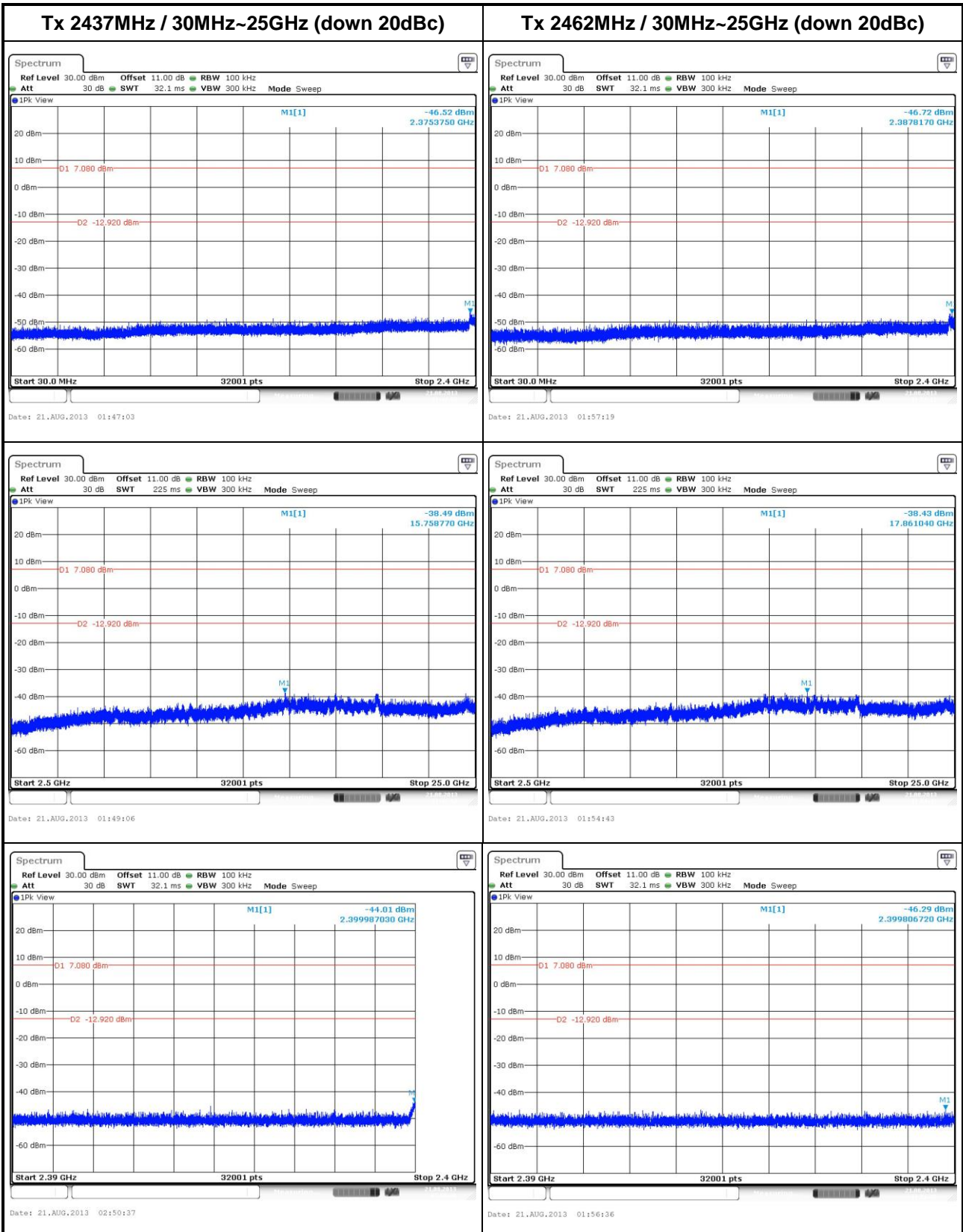

802.11n HT20

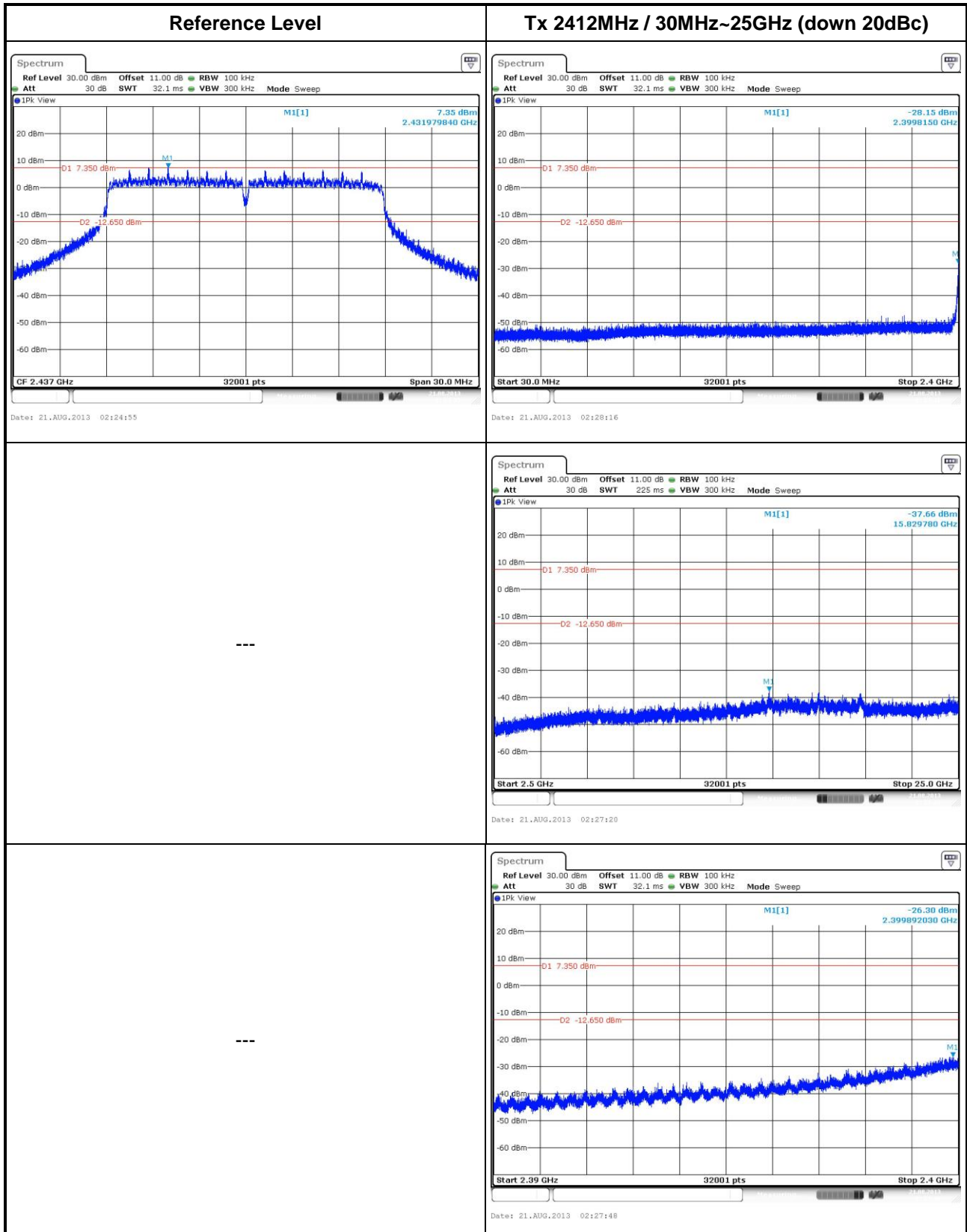

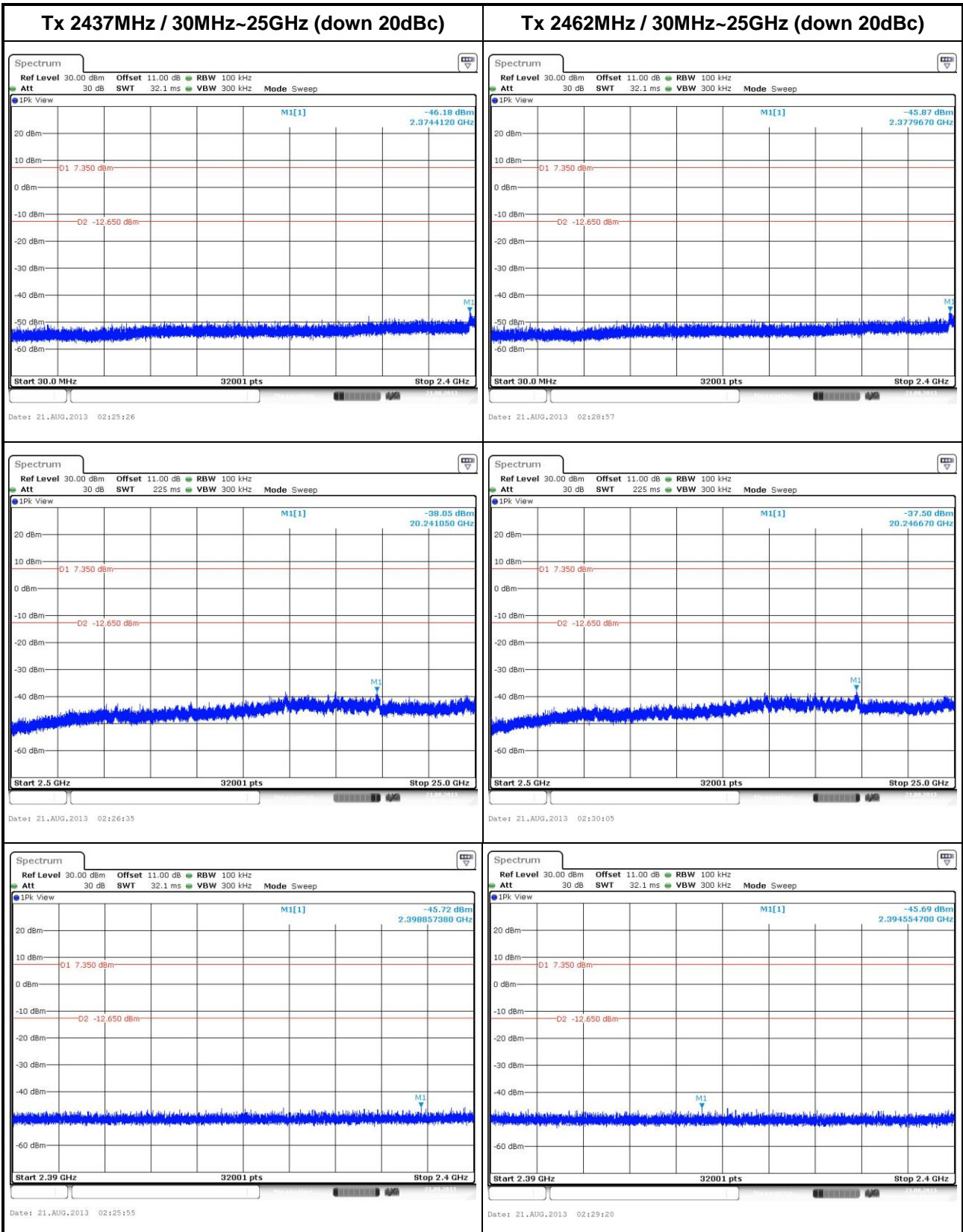

802.11n HT40

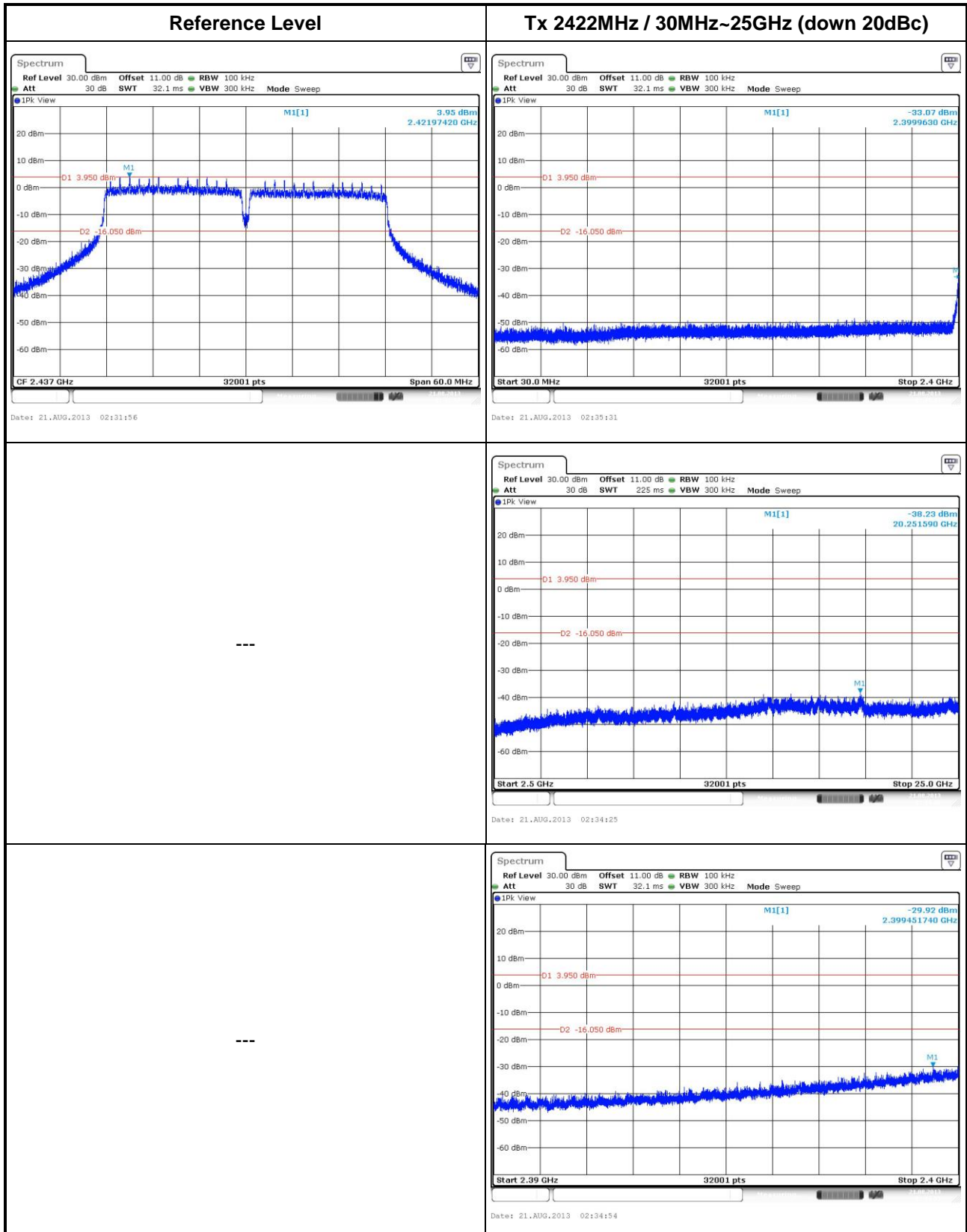

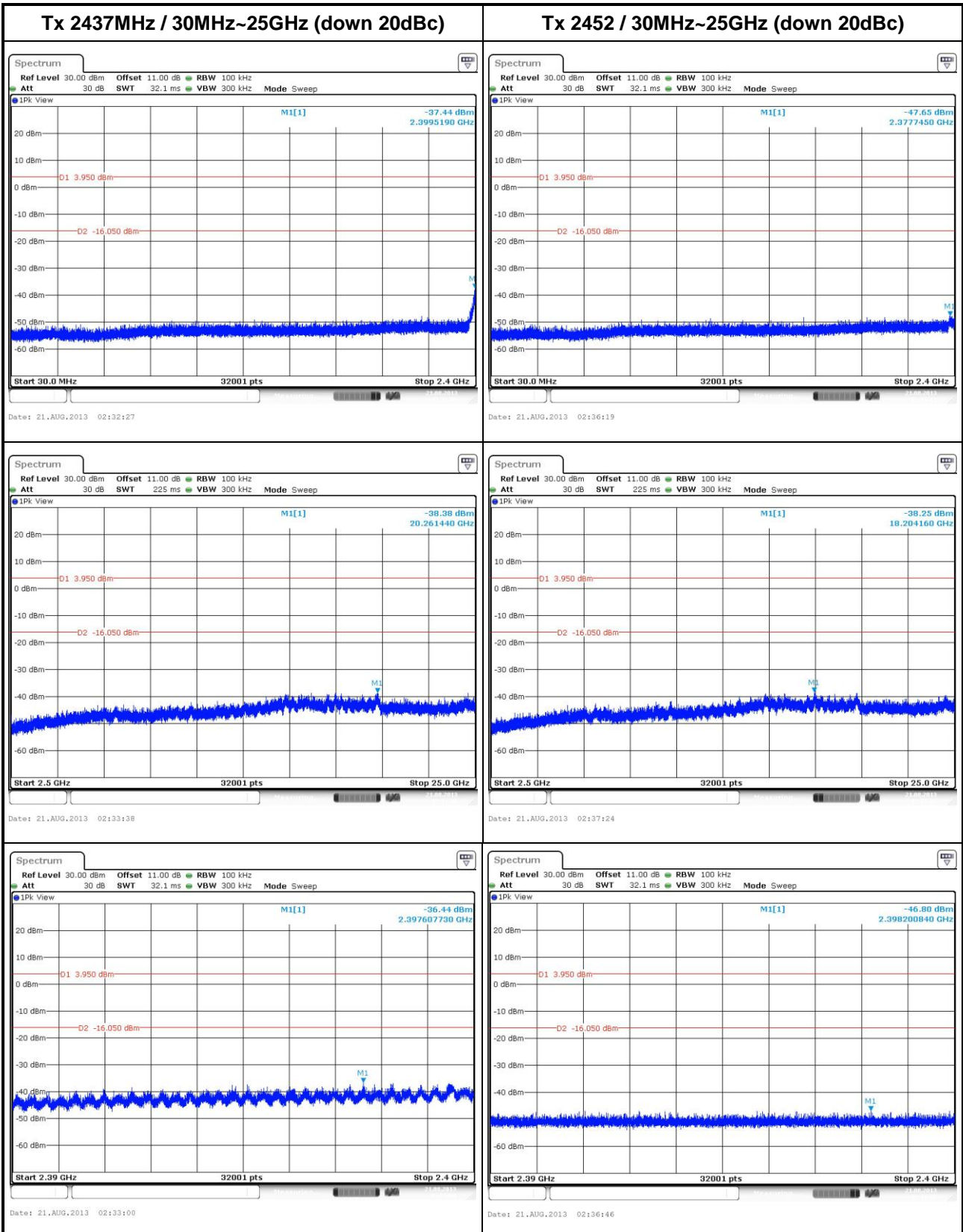

4 Test laboratory information

Established in 2012, ICC provides foremost EMC & RF Testing and advisory consultation services by our skilled engineers and technicians. Our services employ a wide variety of advanced edge test equipment and one of the widest certification extents in the business.

International Certification Corp, it is our definitive objective is to institute long term, trust-based associations with our clients. The expectation we set up with our clients is based on outstanding service, practical expertise and devotion to a certified value structure. Our passion is to grant our clients with best EMC / RF services by oriented knowledgeable and accommodating staff.

Our Test sites are located at Linkou District and Kwei Shan Hsiang. Location map can be found on our website <http://www.icertifi.com.tw>.

Linkou

Tel: 886-3-271-8666

No. 30-2, Ding Fwu Tsuen, Lin Kou District, New Taipei City, Taiwan, R.O.C.

Kwei Shan

Tel: 886-3-271-8666

No. 3-1, Lane 6, Wen San 3rd St., Kwei Shan Hsiang, Tao Yuan Hsien 333, Taiwan, R.O.C.

If you have any suggestion, please feel free to contact us as below information

Tel: 886-3-271-8666

Fax: 886-3-318-0155

Email: ICC_Service@icertifi.com.tw

5 Appendix A – Average power for reference only

Test Procedures

A broadband Average RF power meter is used for output power measurement. The video bandwidth of power meter is greater than DTS bandwidth of EUT. If duty cycle of test signal is not 100 %, trigger and gating function of power meter will be enabled to capture transmission burst for measuring output power

Test Setup



Test Result of Maximum Output Power

Modulation Mode	N _{TX}	Freq. (MHz)	Average conducted output power (dBm)				Total Power (mW)	Total Power (dBm)	Limit (dBm)
			Chain 0	Chain 1	Chain 2	Chain 3			
11b	2	2412	20.14	20.06	---	---	204.667	23.11	30
11b	2	2437	25.78	25.21	---	---	710.337	28.51	30
11b	2	2462	21.12	20.36	---	---	238.062	23.77	30
11g	2	2412	17.53	17.26	---	---	109.835	20.41	30
11g	2	2437	18.19	17.54	---	---	122.672	20.89	30
11g	2	2462	16.82	16.02	---	---	88.078	19.45	30
HT20	2	2412	15.71	15.33	---	---	71.358	18.53	30
HT20	2	2437	17.82	17.71	---	---	119.554	20.78	30
HT20	2	2462	16.15	15.63	---	---	77.769	18.91	30
HT40	2	2422	12.52	12.05	---	---	33.897	15.30	30
HT40	2	2437	16.93	16.02	---	---	89.312	19.51	30
HT40	2	2452	12.71	11.52	---	---	32.854	15.17	30

==END==