

## FCC Report

**Applicant:** CEI Conrad Electronic International (HK) Limited

**Address of Applicant:** 18/F, Tower 2, Nina Tower, 8 Yeung Uk Road, Tsuen Wan, N.T, Hong Kong.

**Equipment Under Test (EUT)**

Product Name: RC Logger R8 Radio System

Model No.: 89102RC

**FCC ID:** 2AARVRCL-R8RADIO

**Applicable standards:** FCC CFR Title 47 Part 15 Subpart C Section 15.247:2014

**Date of sample receipt:** July 16, 2015

**Date of Test:** July 17-23, 2015

**Date of report issued:** July 24, 2015

**Test Result :** PASS \*

\* In the configuration tested, the EUT complied with the standards specified above.

Authorized Signature:



Robinson Lo  
Laboratory Manager

This report details the results of the testing carried out on one sample. The results contained in this test report do not relate to other samples of the same product and does not permit the use of the GTS product certification mark. The manufacturer should ensure that all products in series production are in conformity with the product sample detailed in this report.

This report may only be reproduced and distributed in full. If the product in this report is used in any configuration other than that detailed in the report, the manufacturer must ensure the new system complies with all relevant standards. Any mention of GTS or testing done by GTS in connection with, distribution or use of the product described in this report must be approved by GTS in writing.

This document cannot be reproduced except in full, without prior written approval of the Company. Any unauthorized alteration, forgery or falsification of the content or appearance of this document is unlawful and offenders may be prosecuted to the fullest extent of the law. Unless otherwise stated the results shown in this test report refer only to the sample(s) tested and such sample(s) are retained for 90 days only.

## 2 Version

Version No.	Date	Description
00	July 24, 2015	Original

Prepared By:

*Edward Pan*

Date:

July 24, 2015

Project Engineer

Check By:

*Hank Yan*

Date:

July 24, 2015

Reviewer

## 3 Contents

Page

1	COVER PAGE .....	1
2	VERSION .....	2
3	CONTENTS .....	3
4	TEST SUMMARY .....	4
4.1	MEASUREMENT UNCERTAINTY .....	4
5	GENERAL INFORMATION .....	5
5.1	CLIENT INFORMATION .....	5
5.2	GENERAL DESCRIPTION OF EUT .....	5
5.3	TEST MODE .....	8
5.4	TEST FACILITY.....	8
5.5	TEST LOCATION .....	8
5.6	OTHER INFORMATION REQUESTED BY THE CUSTOMER.....	8
5.7	DESCRIPTION OF SUPPORT UNITS .....	8
5.8	TEST INSTRUMENTS LIST.....	9
6	TEST RESULTS AND MEASUREMENT DATA.....	10
6.1	ANTENNA REQUIREMENT.....	10
6.2	CONDUCTED PEAK OUTPUT POWER.....	11
6.3	20dB EMISSION BANDWIDTH .....	14
6.4	CARRIER FREQUENCIES SEPARATION.....	17
6.5	HOPPING CHANNEL NUMBER .....	21
6.6	DWELL TIME.....	23
6.7	PSEUDORANDOM FREQUENCY HOPPING SEQUENCE .....	31
6.8	BAND EDGE .....	32
6.8.1	Conducted Emission Method.....	32
6.8.2	Radiated Emission Method.....	35
6.9	SPURIOUS EMISSION.....	37
6.9.1	Conducted Emission Method.....	37
6.9.2	Radiated Emission Method.....	40
7	TEST SETUP PHOTO .....	46
8	EUT CONSTRUCTIONAL DETAILS .....	48

## 4 Test Summary

Test Item	Section	Result
Antenna Requirement	15.203/15.247 (c)	Pass
AC Power Line Conducted Emission	15.207	N/A
Conducted Peak Output Power	15.247 (b)(1)	Pass
20dB Occupied Bandwidth	15.247 (a)(1)	Pass
Carrier Frequencies Separation	15.247 (a)(1)	Pass
Hopping Channel Number	15.247 (a)(1)	Pass
Dwell Time	15.247 (a)(1)	Pass
Pseudorandom Frequency Hopping Sequence	15.247(b)(4)	Pass
Radiated Emission	15.205/15.209	Pass
Band Edge	15.247(d)	Pass

*Pass: The EUT complies with the essential requirements in the standard.*

### 4.1 Measurement Uncertainty

Test Item	Frequency Range	Measurement Uncertainty	Notes
Radiated Emission	9kHz ~ 30MHz	± 4.34dB	(1)
Radiated Emission	30MHz ~ 1000MHz	± 4.24dB	(1)
Radiated Emission	1GHz ~ 26.5GHz	± 4.68dB	(1)
AC Power Line Conducted Emission	0.15MHz ~ 30MHz	± 3.45dB	(1)
Note (1): The measurement uncertainty is for coverage factor of k=2 and a level of confidence of 95%.			

## 5 General Information

### 5.1 Client Information

Applicant:	CEI Conrad Electronic International (HK) Limited
Address of Applicant:	18/F, Tower 2,Nina Tower,8 Yeung Uk Road, Tsuen Wan, N.T, Hong Kong.
Manufacturer/Factory:	FLYSKY RC MODEL TECHNOLOGY CO.,LTD
Address of Manufacturer/Factory:	West building3, Huangjianyuan Ind, Park QIAOLI North Gate Changping Town, Dongguan, China

### 5.2 General Description of EUT

Product Name:	RC Logger R8 Radio System
Model No.:	89102RC
Operation Frequency:	2405.5MHz~2475.0MHz
Channel numbers:	140
Modulation technology:	GFSK
Antenna Type:	Integral Antenna
Antenna gain:	2dBi
Power supply:	DC 6.0V(4*1.5V "AA" Battery)

Remark: The system works in the frequency range of 2405.5MHz to 2475MHz. This band has been divided to 140 independent channels. Each radio system uses 16 different channels, the minimum channel separation is  $\geq 1$ MHz. By using various switch-on times, hopping scheme and channel frequencies, the system can guarantee a jamming free radio transmission. The channel list is below.

Operation Frequency each of channel							
Channel	Frequency (MHz)	Channel	Frequency (MHz)	Channel	Frequency (MHz)	Channel	Frequency (MHz)
1	2405.50	36	2423.00	71	2440.50	106	2458.00
2	2406.00	37	2423.50	72	2441.00	107	2458.50
3	2406.50	38	2424.00	73	2441.50	108	2459.00
4	2407.00	39	2424.50	74	2442.00	109	2459.50
5	2407.50	40	2425.00	75	2442.50	110	2460.00
6	2408.00	41	2425.50	76	2443.00	111	2460.50
7	2408.50	42	2426.00	77	2443.50	112	2461.00
8	2409.00	43	2426.50	78	2444.00	113	2461.50
9	2409.50	44	2427.00	79	2444.50	114	2462.00
10	2410.00	45	2427.50	80	2445.00	115	2462.50
11	2410.50	46	2428.00	81	2445.50	116	2463.00
12	2411.00	47	2428.50	82	2446.00	117	2463.50
13	2411.50	48	2429.00	83	2446.50	118	2464.00
14	2412.00	49	2429.50	84	2447.00	119	2464.50
15	2412.50	50	2430.00	85	2447.50	120	2465.00
16	2413.00	51	2430.50	86	2448.00	121	2465.50
17	2413.50	52	2431.00	87	2448.50	122	2466.00
18	2414.00	53	2431.50	88	2449.00	123	2466.50
19	2414.50	54	2432.00	89	2449.50	124	2467.00
20	2415.00	55	2432.50	90	2450.00	125	2467.50
21	2415.50	56	2433.00	91	2450.50	126	2468.00
22	2416.00	57	2433.50	92	2451.00	127	2468.50
23	2416.50	58	2434.00	93	2451.50	128	2469.00
24	2417.00	59	2434.50	94	2452.00	129	2469.50
25	2417.50	60	2435.00	95	2452.50	130	2470.00
26	2418.00	61	2435.50	96	2453.00	131	2470.50
27	2418.50	62	2436.00	97	2453.50	132	2471.00
28	2419.00	63	2436.50	98	2454.00	133	2471.50
29	2419.50	64	2437.00	99	2454.50	134	2472.00
30	2420.00	65	2437.50	100	2455.00	135	2472.50
31	2420.50	66	2438.00	101	2455.50	136	2473.00
32	2421.00	67	2438.50	102	2456.00	137	2473.50
33	2421.50	68	2439.00	103	2456.50	138	2474.00
34	2422.00	69	2439.50	104	2457.00	139	2474.50
35	2422.50	70	2440.00	105	2457.50	140	2475.00

In section 15.31(m), regards to the operating frequency range over 10 MHz, the Lowest frequency, the middle frequency, and the highest frequency of channel were selected to perform the test, and the selected channel see below:

Channel	Frequency
The lowest channel	2405.5MHz
The middle channel	2440.0MHz
The Highest channel	2475.0MHz

### 5.3 Test mode

Transmitting mode	Keep the EUT in transmitting mode.
-------------------	------------------------------------

### 5.4 Test Facility

<p>The test facility is recognized, certified, or accredited by the following organizations:</p> <ul style="list-style-type: none"><li>● <b>FCC —Registration No.: 600491</b> Global United Technology Services Co., Ltd., Shenzhen EMC Laboratory has been registered and fully described in a report filed with the (FCC) Federal Communications Commission. The acceptance letter from the FCC is maintained in files. Registration 600491, June 28, 2013.</li><li>● <b>Industry Canada (IC) —Registration No.: 9079A-2</b> The 3m Semi-anechoic chamber of Global United Technology Services Co., Ltd. has been registered by Certification and Engineering Bureau of Industry Canada for radio equipment testing with Registration No.: 9079A-2, June 26, 2013.</li></ul>
--

### 5.5 Test Location

All other tests were performed at:
Global United Technology Services Co., Ltd. Address: Room 301-309, 3th Floor, Block A, Huafeng Jinyuan Business Building, No. 300 Laodong Industrial Zone, Xixiang Road, Baoan District, Shenzhen 518102 Tel: 0755-27798480 Fax: 0755-27798960

### 5.6 Other Information Requested by the Customer

None.
-------

### 5.7 Description of Support Units

None.
-------



## 5.8 Test Instruments list

Radiated Emission:						
Item	Test Equipment	Manufacturer	Model No.	Inventory No.	Cal.Date (mm-dd-yy)	Cal.Due date (mm-dd-yy)
1	3m Semi- Anechoic Chamber	ZhongYu Electron	9.2(L)*6.2(W)* 6.4(H)	GTS250	Mar. 28 2015	Mar. 27 2016
2	Control Room	ZhongYu Electron	6.2(L)*2.5(W)* 2.4(H)	GTS251	N/A	N/A
3	Spectrum Analyzer	Agilent	E4440A	GTS536	Jul. 04 2015	Jul. 03 2016
4	EMI Test Receiver	Rohde & Schwarz	ESU26	GTS203	Jul. 04 2015	Jul. 03 2016
5	Loop Antenna	ZHINAN	ZN30900A	GTS534	Feb. 22 2015	Feb. 21 2016
6	BiConiLog Antenna	SCHWARZBECK MESS-ELEKTRONIK	VULB9163	GTS214	Feb. 22 2015	Feb. 21 2016
7	Double -ridged waveguide horn	SCHWARZBECK MESS-ELEKTRONIK	9120D-829	GTS208	Jul. 04 2015	Jul. 03 2016
8	Horn Antenna	ETS-LINDGREN	3160	GTS217	Mar. 28 2015	Mar. 27 2016
9	EMI Test Software	AUDIX	E3	N/A	N/A	N/A
10	Coaxial Cable	GTS	N/A	GTS213	Mar. 28 2015	Mar. 27 2016
11	Coaxial Cable	GTS	N/A	GTS211	Mar. 28 2015	Mar. 27 2016
12	Coaxial cable	GTS	N/A	GTS210	Mar. 28 2015	Mar. 27 2016
13	Coaxial Cable	GTS	N/A	GTS212	Mar. 28 2015	Mar. 27 2016
14	Amplifier(100kHz-3GHz)	HP	8347A	GTS204	Jul. 04 2015	Jul. 03 2016
15	Amplifier(2GHz-20GHz)	HP	8349B	GTS206	Jul. 04 2015	Jul. 03 2016
16	Amplifier (18-26GHz)	Rohde & Schwarz	AFS33-18002 650-30-8P-44	GTS218	Jul. 04 2015	Jul. 03 2016
17	Band filter	Amindeon	82346	GTS219	Mar. 28 2015	Mar. 27 2016

## 6 Test results and Measurement Data

### 6.1 Antenna requirement

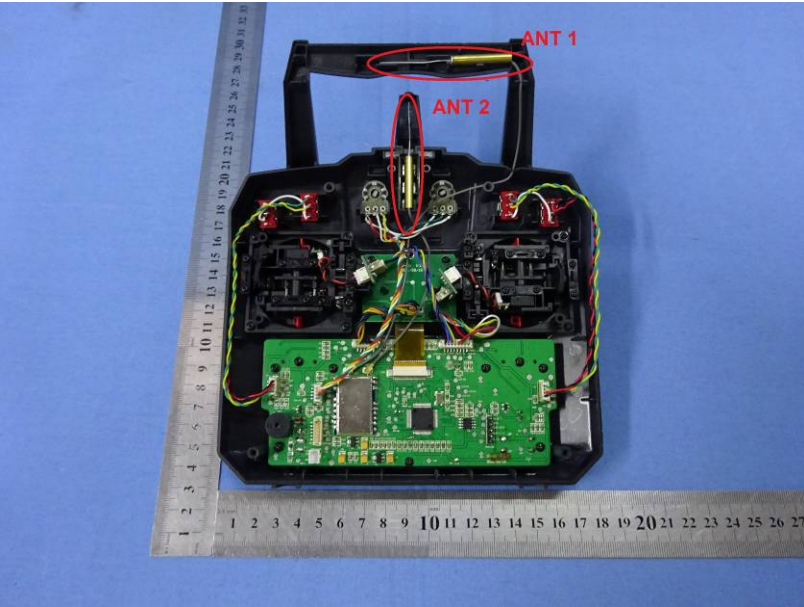
<b>Standard requirement:</b>	FCC Part15 C Section 15.203 /247(c)
<p><b>15.203 requirement:</b></p> <p>An intentional radiator shall be designed to ensure that no antenna other than that furnished by the responsible party shall be used with the device. The use of a permanently attached antenna or of an antenna that uses a unique coupling to the intentional radiator, the manufacturer may design the unit so that a broken antenna can be replaced by the user, but the use of a standard antenna jack or electrical connector is prohibited.</p> <p><b>15.247(c) (1)(i) requirement:</b></p> <p>(i) Systems operating in the 2400-2483.5 MHz band that is used exclusively for fixed. Point-to-point operations may employ transmitting antennas with directional gain greater than 6dBi provided the maximum conducted output power of the intentional radiator is reduced by 1 dB for every 3 dB that the directional gain of the antenna exceeds 6dBi.</p>	
<b>EUT Antenna:</b>	
<p><i>The antenna is integral Antenna, the best case gain of the antenna is 2dBi</i></p> <p>Two antenna can't transmit at the same time. While the ANT1 transmitting, the ANT2 act as a receiver antenna and vice versa.</p>	
	

## 6.2 Conducted Peak Output Power

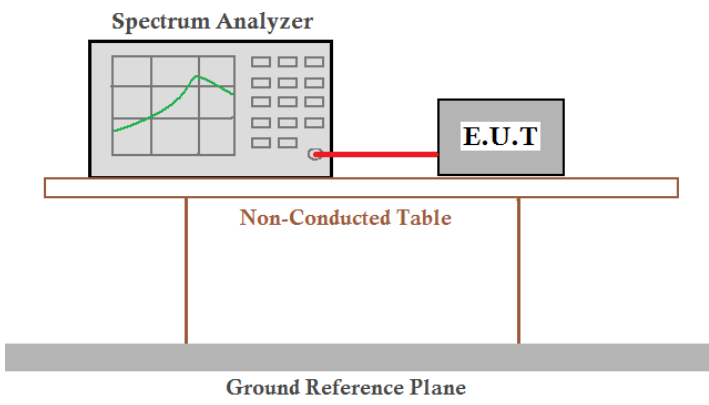
Test Requirement:	FCC Part15 C Section 15.247 (b)(1)
Test Method:	DA 00-705, ANSI C63.10:2013
Limit:	20.97dBm
Test setup:	 <p>The diagram shows a Spectrum Analyzer on the left and an E.U.T. on the right, connected by a red cable. They are both on a table labeled 'Non-Conducted Table'. Below the table is a 'Ground Reference Plane'.</p>
Test Instruments:	Refer to section 5.8 for details
Test mode:	Refer to section 5.3 for details
Test results:	Pass

### Measurement Data

#### Antenna 1:

Test channel	Peak Output Power (dBm)	Limit (dBm)	Result
Lowest	12.65	20.97	Pass
Middle	12.15		
Highest	11.97		

#### Antenna 2:

Test channel	Peak Output Power (dBm)	Limit (dBm)	Result
Lowest	12.16	20.97	Pass
Middle	11.12		
Highest	10.73		

Test plot as follows:

		Antenna:	Antenna 1
--	--	----------	-----------

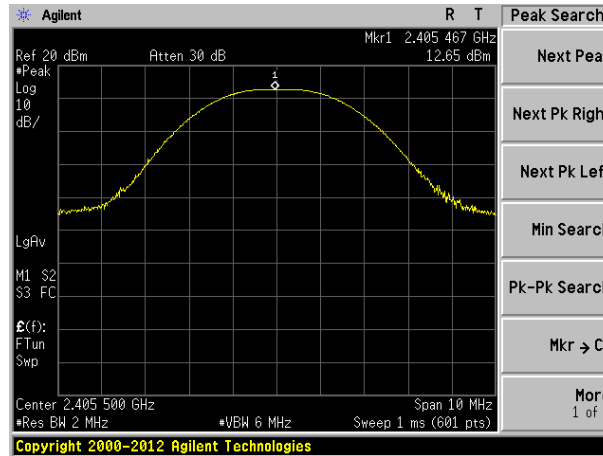

Lowest channel

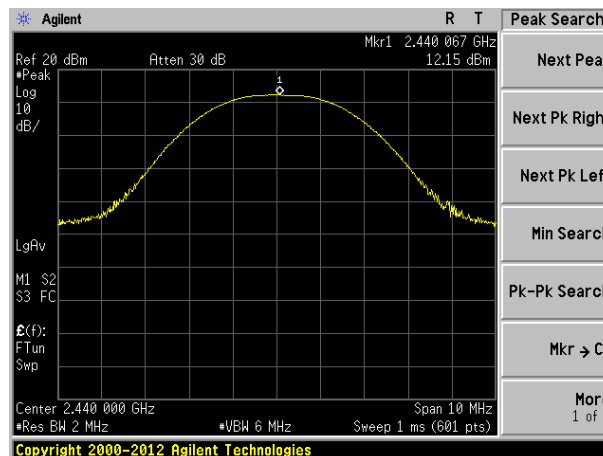

Middle channel

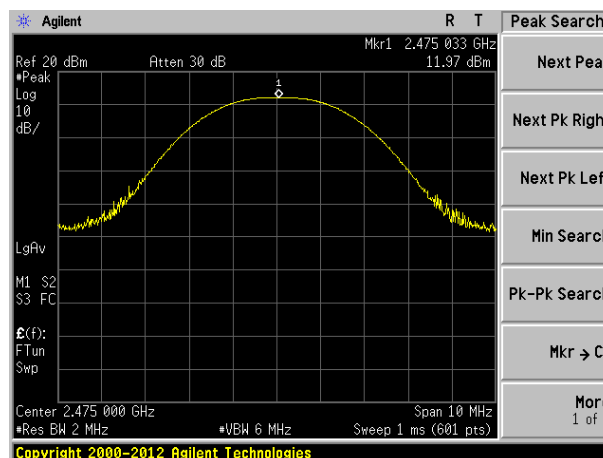

Highest channel

		Antenna:	Antenna 2
--	--	----------	-----------

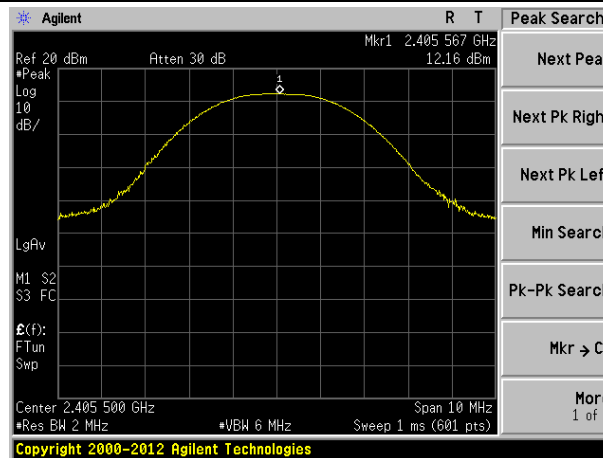

Lowest channel

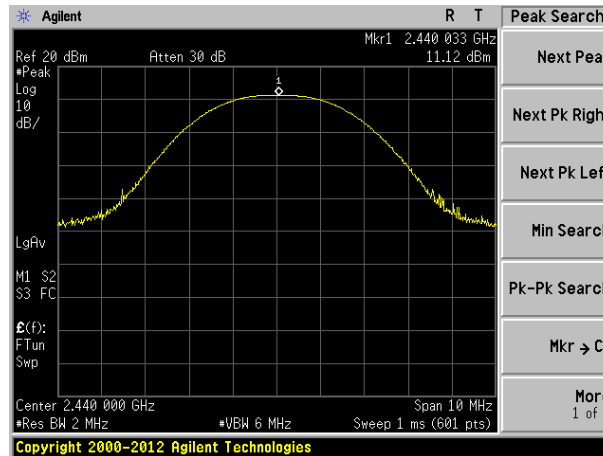

Middle channel

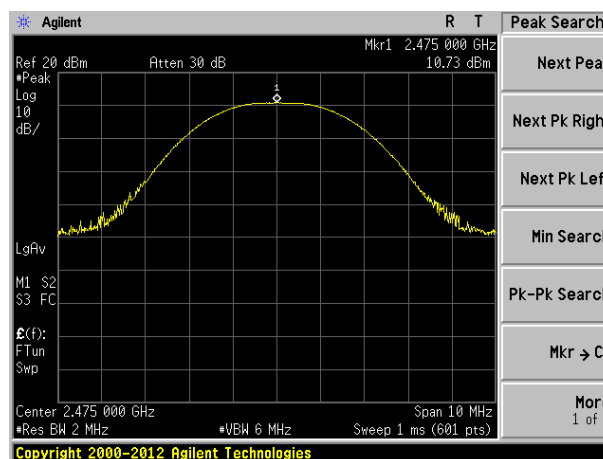

Highest channel

### 6.3 20dB Emission Bandwidth

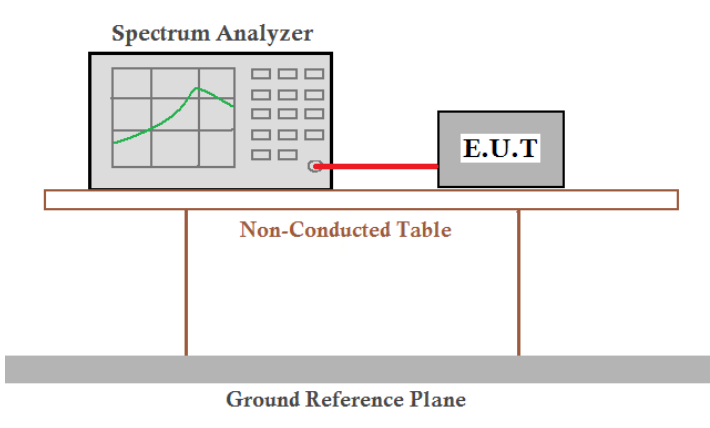
Test Requirement:	FCC Part15 C Section 15.247 (a)(1)
Test Method:	DA 00-705, ANSI C63.10:2013
Limit:	N/A
Test setup:	 <p>The diagram illustrates the test setup. A Spectrum Analyzer is connected to an E.U.T. (Equipment Under Test) via a red cable. Both are placed on a Non-Conducted Table, which is positioned above a Ground Reference Plane.</p>
Test Instruments:	Refer to section 5.8 for details
Test mode:	Refer to section 5.3 for details
Test results:	Pass

#### Measurement Data

##### Antenna 1:

Test channel	20dB Emission Bandwidth (MHz)	Result
Lowest	1.049	Pass
Middle	1.048	
Highest	1.046	

##### Antenna 2:

Test channel	20dB Emission Bandwidth (MHz)	Result
Lowest	1.049	Pass
Middle	1.047	
Highest	1.048	

Test plot as follows:

		Antenna:	Antenna 1
--	--	----------	-----------

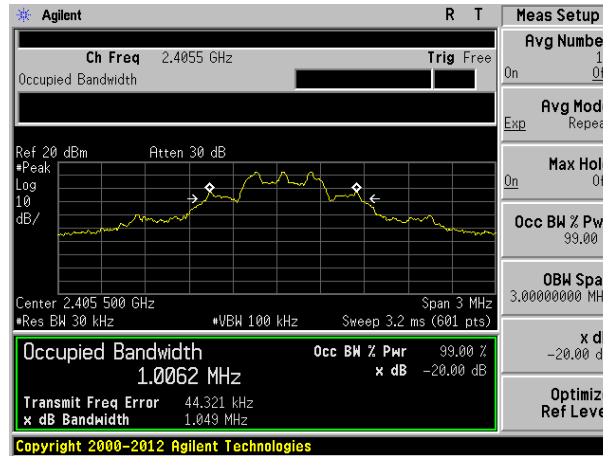

Lowest channel

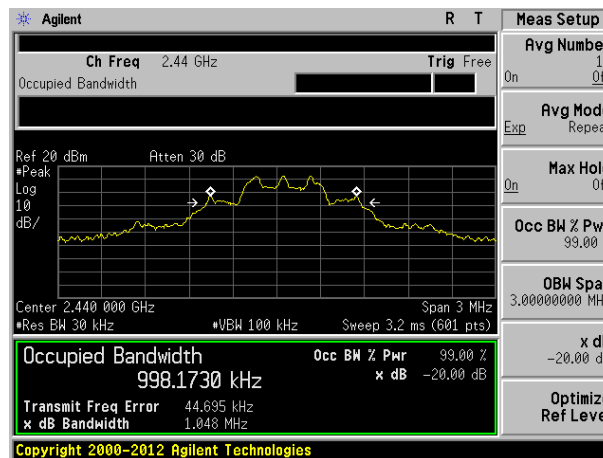

Middle channel

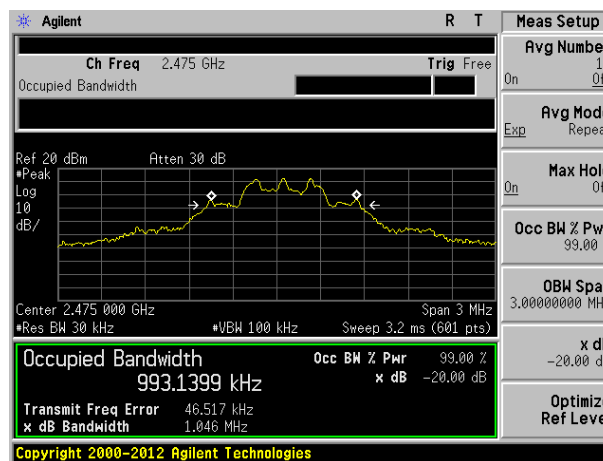

Highest channel

	Antenna:	Antenna 2
--	----------	-----------

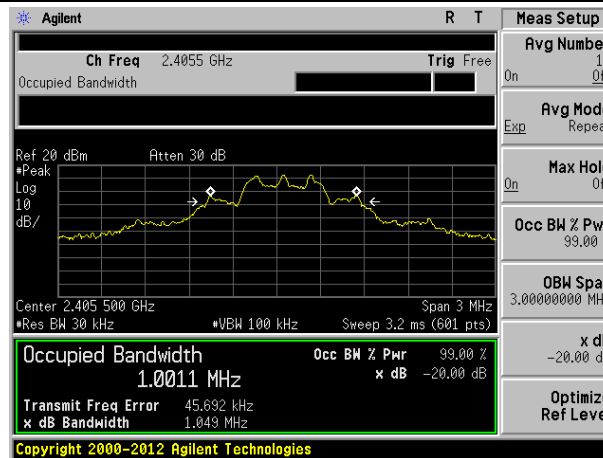

Lowest channel

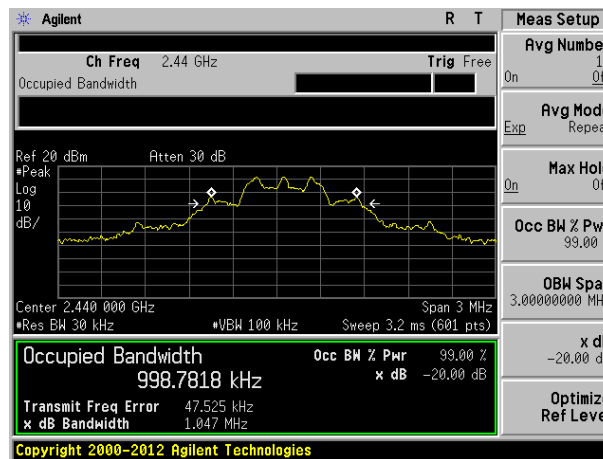

Middle channel

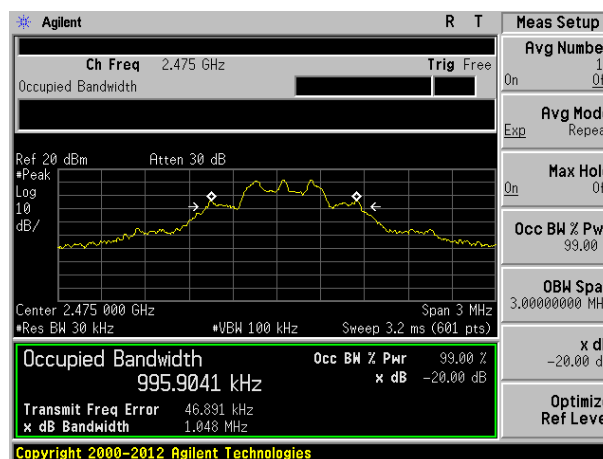

Highest channel

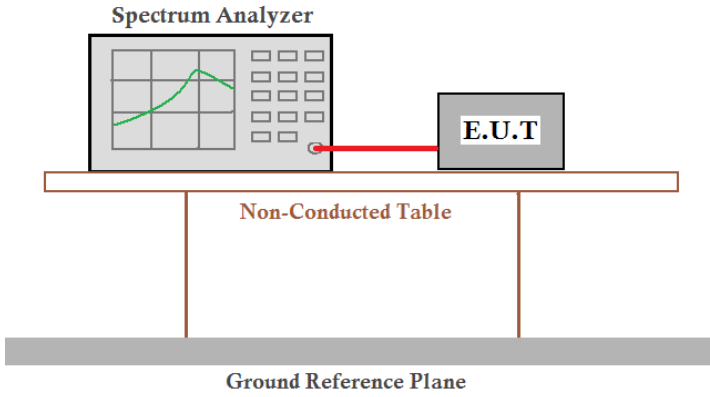

## 6.4 Carrier Frequencies Separation

Test Requirement:	FCC Part15 C Section 15.247 (a)(1)
Test Method:	DA 00-705, ANSI C63.10:2013
Receiver setup:	RBW=100KHz, VBW=300KHz, detector=Peak
Limit:	0.025MHz or 2/3 of the 20dB bandwidth (whichever is greater)
Test setup:	 <p>The diagram illustrates the test setup. A Spectrum Analyzer is connected to an E.U.T. (Equipment Under Test) via a red cable. Both are placed on a Non-Conducted Table, which is supported by a Ground Reference Plane.</p>
Test Instruments:	Refer to section 5.8 for details
Test mode:	Refer to section 5.3 for details
Test results:	Pass

## Measurement Data

### Antenna 1:

Test channel	Carrier Frequencies Separation (kHz)	Limit (kHz)	Result
Lowest	5520	699	Pass
Middle	2000	699	Pass
Highest	6013	699	Pass

Note: According to section 6.3

Mode	20dB bandwidth (kHz) (worse case)	Limit (kHz) (Carrier Frequencies Separation)
GFSK	1049	699

### Antenna 2:

Test channel	Carrier Frequencies Separation (kHz)	Limit (kHz)	Result
Lowest	5507	699	Pass
Middle	2000	699	Pass
Highest	6000	699	Pass

Note: According to section 6.3

Mode	20dB bandwidth (kHz) (worse case)	Limit (kHz) (Carrier Frequencies Separation)
GFSK	1049	699

Test plot as follows:

		Antenna:	Antenna 1
--	--	----------	-----------

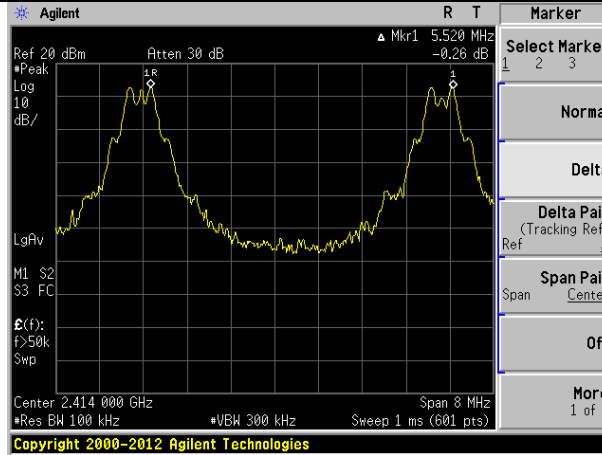

Lowest channel

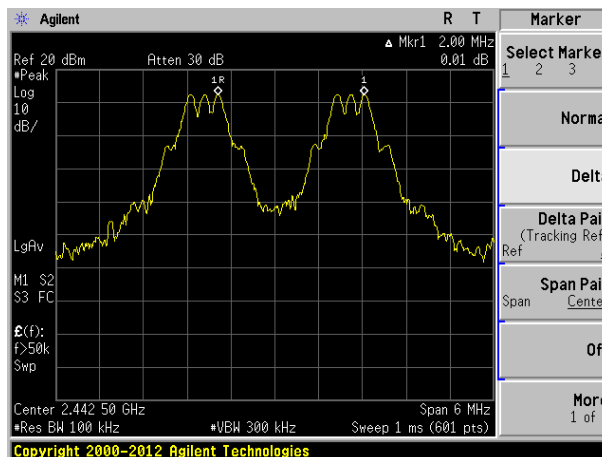

Middle channel

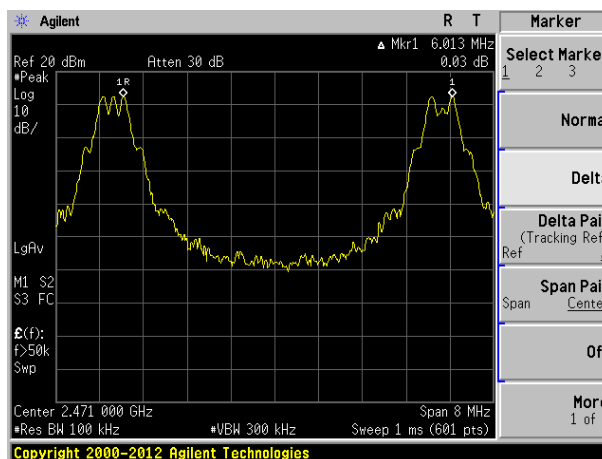

Highest channel

	Antenna:	Antenna 2
--	----------	-----------

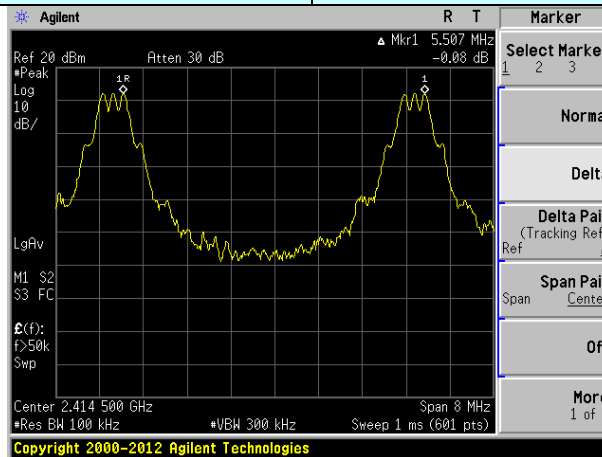

Lowest channel

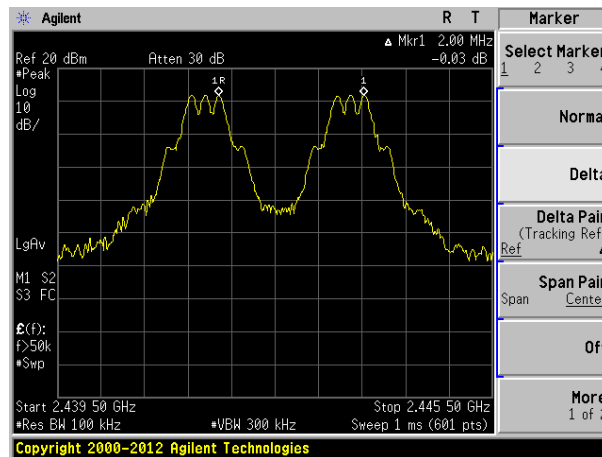

Middle channel

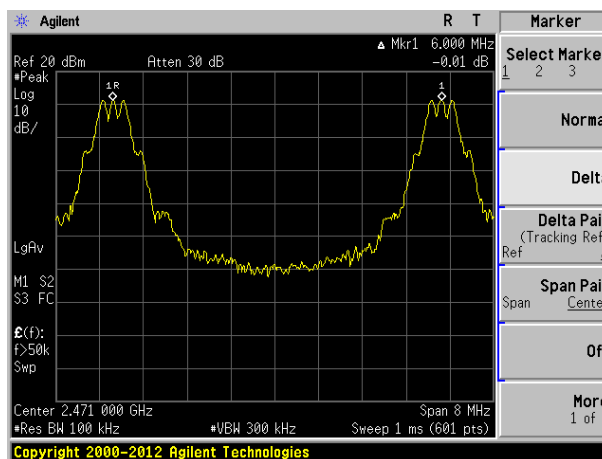

Highest channel

## 6.5 Hopping Channel Number

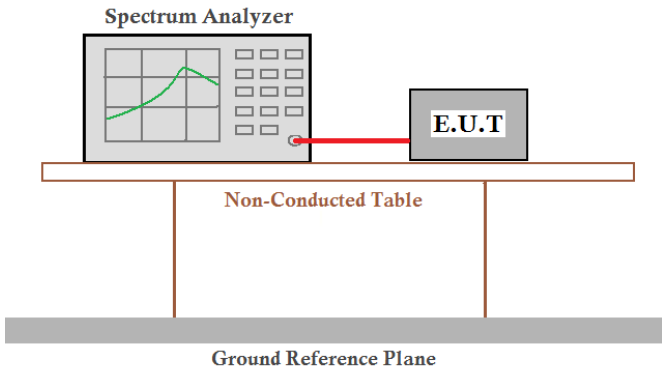
Test Requirement:	FCC Part15 C Section 15.247 (a)(1)(iii)
Test Method:	DA 00-705, ANSI C63.10:2013
Receiver setup:	RBW=100kHz, VBW=300kHz, Frequency range=2400MHz-2483.5MHz, Detector=Peak
Limit:	15 channels
Test setup:	 <p>The diagram illustrates the test setup. A Spectrum Analyzer is connected to an E.U.T. (Equipment Under Test) via a red cable. Both the Spectrum Analyzer and the E.U.T. are placed on a Non-Conducted Table. The table is supported by a Ground Reference Plane.</p>
Test Instruments:	Refer to section 5.8 for details
Test mode:	Refer to section 5.3 for details
Test results:	Pass

**Measurement Data:**

**Antenna 1:**

Hopping channel numbers	Limit	Result
16	15	Pass

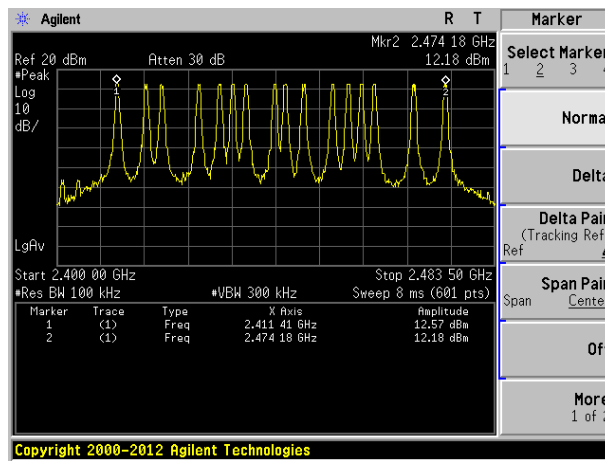

**Antenna 2:**

Hopping channel numbers	Limit	Result
16	15	Pass

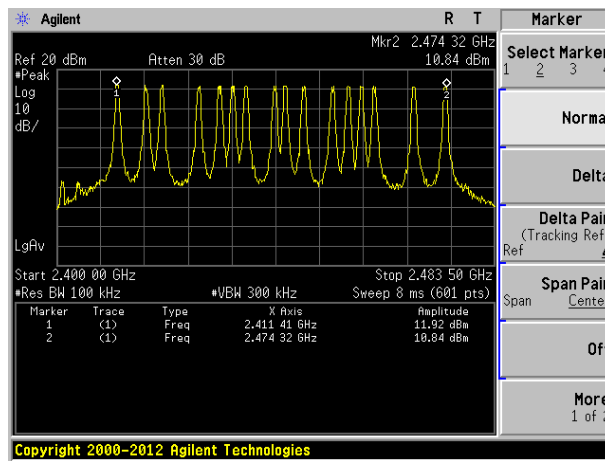

## 6.6 Dwell Time

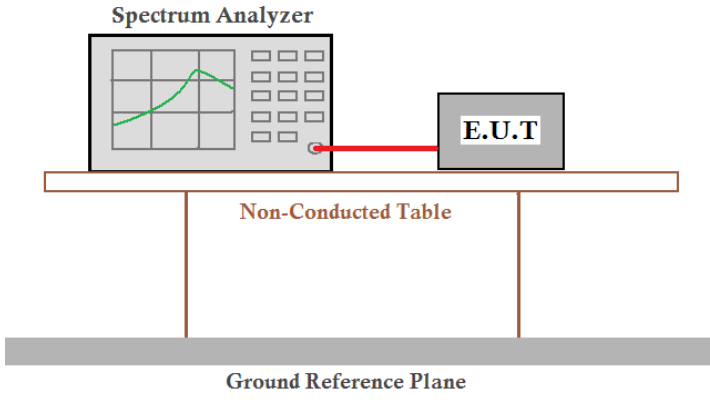
Test Requirement:	FCC Part15 C Section 15.247 (a)(1)(iii)
Test Method:	DA 00-705, ANSI C63.10:2013
Receiver setup:	RBW=1MHz, VBW=1MHz, Span=0Hz, Detector=Peak
Limit:	0.4 Second
Test setup:	 <p>The diagram illustrates the test setup. A Spectrum Analyzer is connected to an E.U.T. (Equipment Under Test) via a red cable. Both are placed on a Non-Conducted Table. Below the table is a Ground Reference Plane.</p>
Test Instruments:	Refer to section 5.8 for details
Test mode:	Refer to section 5.3 for details
Test results:	Pass

**Measurement Data****Antenna 1:**

Frequency	Ton (ms)	Dwell time(ms)	Limit(ms)	Result
2.4055GHz	1.297	66.40	400	Pass
2.440GHz	1.297	66.40	400	Pass
2.475GHz	1.293	66.20	400	Pass

The formula as below:

2405.5MHz: Dwell time = Ton \* Ton times in 1s \* 0.4s \* channel numbers=1.297ms\*8\*0.4\*16=66.40ms

2440MHz: Dwell time = Ton \* Ton times in 1s \* 0.4s \* channel numbers=1.297ms\*8\*0.4\*16=66.40ms

2475MHz: Dwell time = Ton \* Ton times in 1s \* 0.4s \* channel numbers=1.293ms\*8\*0.4\*16=66.20ms

**Antenna 1:**

Frequency	Ton (ms)	Dwell time(ms)	Limit(ms)	Result
2.4055GHz	1.295	66.30	400	Pass
2.440GHz	1.290	66.05	400	Pass
2.475GHz	1.295	66.30	400	Pass

The formula as below:

2405.5MHz: Dwell time = Ton \* Ton times in 1s \* 0.4s \* channel numbers=1.295ms\*8\*0.4\*16=66.30ms

2440MHz: Dwell time = Ton \* Ton times in 1s \* 0.4s \* channel numbers=1.29ms\*8\*0.4\*16=66.05ms

2475MHz: Dwell time = Ton \* Ton times in 1s \* 0.4s \* channel numbers=1.295ms\*8\*0.4\*16=66.30ms

**Test plot as follows:**



Frequency:	2405.5MHz	Antenna:	Antenna 1
------------	-----------	----------	-----------

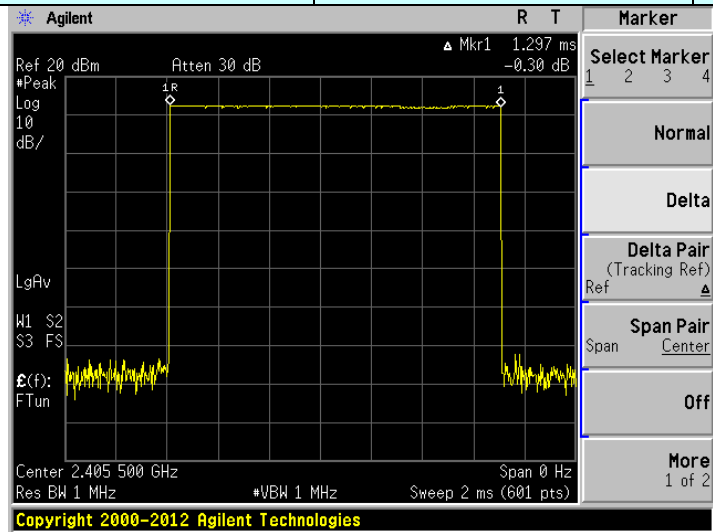

Ton

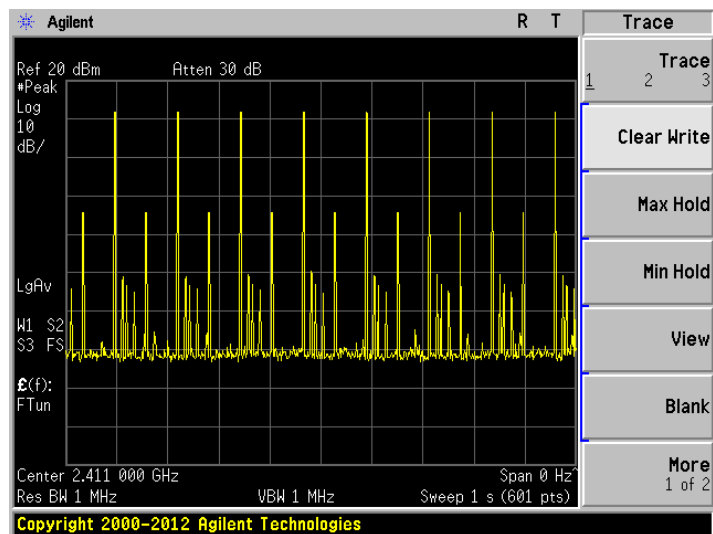

Ton times in 1s

Frequency:	2440MHz	Antenna:	Antenna 1
------------	---------	----------	-----------

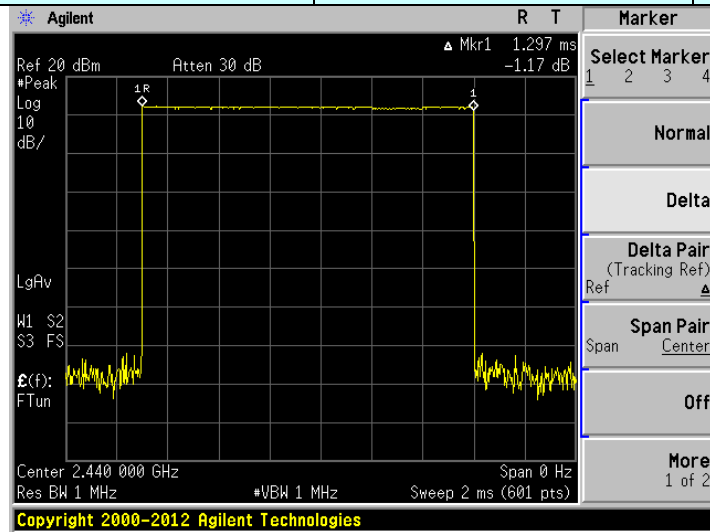

Ton

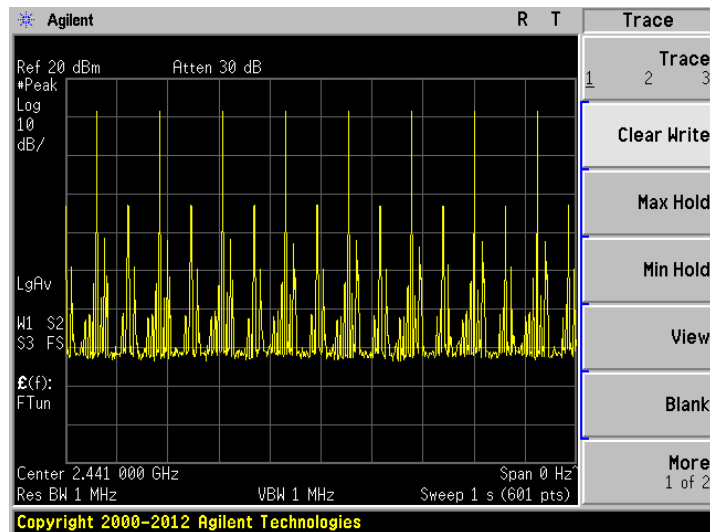

Ton times in 1s

Frequency:	2475MHz	Antenna:	Antenna 1
------------	---------	----------	-----------

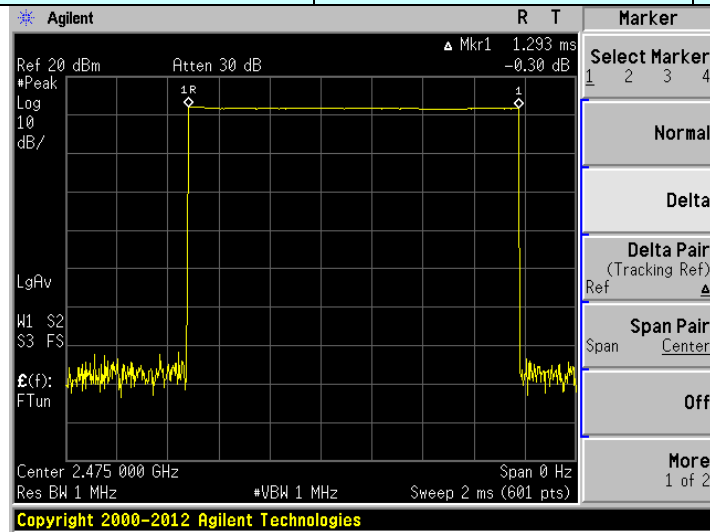

Ton

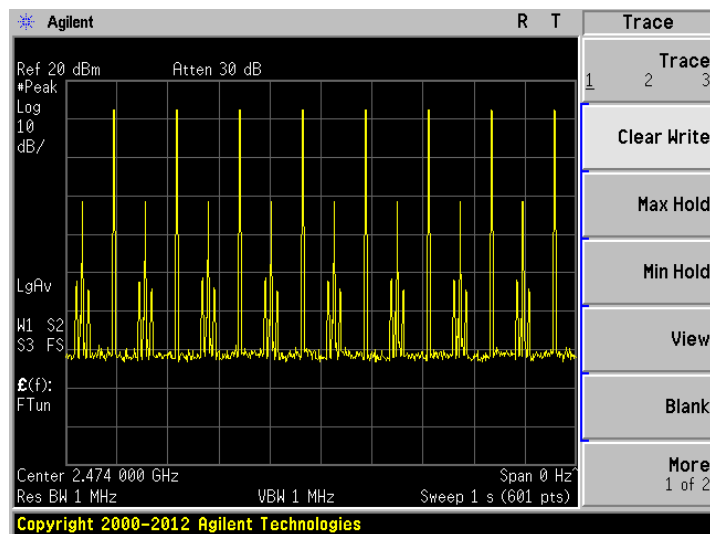

Ton times in 1s

Frequency:	2405.5MHz	Antenna:	Antenna 2
------------	-----------	----------	-----------

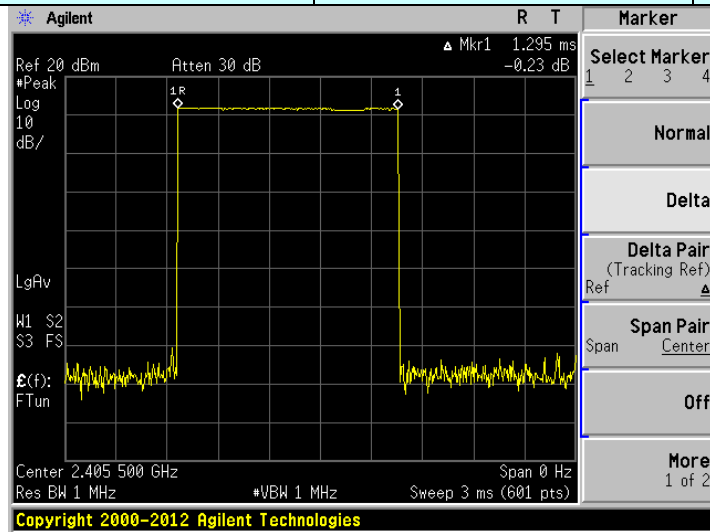

Ton

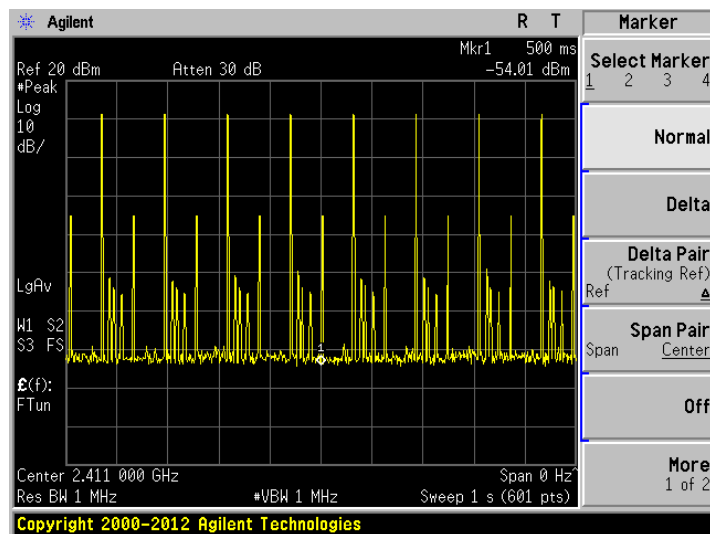

Ton times in 1s

Frequency:	2440MHz	Antenna:	Antenna 2
------------	---------	----------	-----------

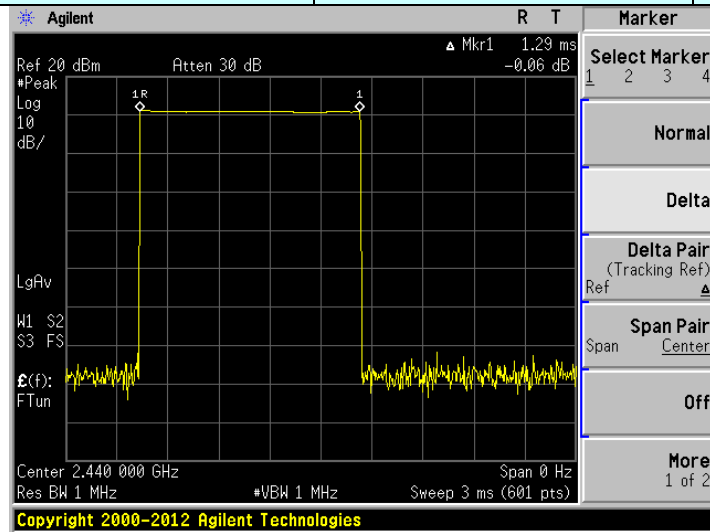

Ton

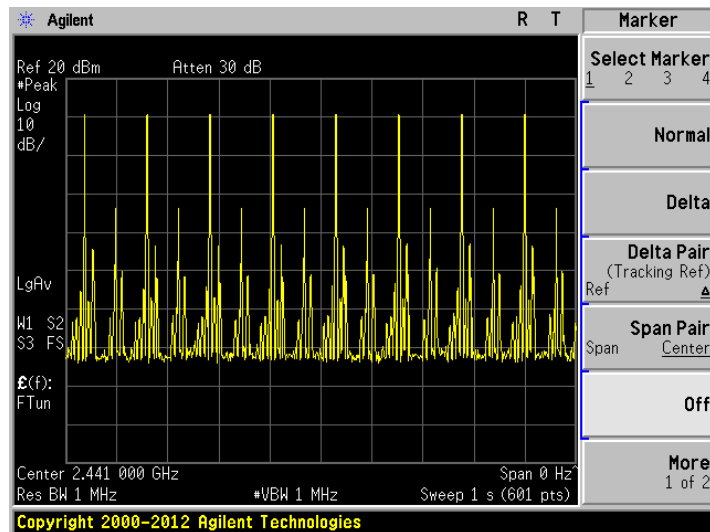

Ton times in 1s

Frequency:	2475MHz	Antenna:	Antenna 2
------------	---------	----------	-----------

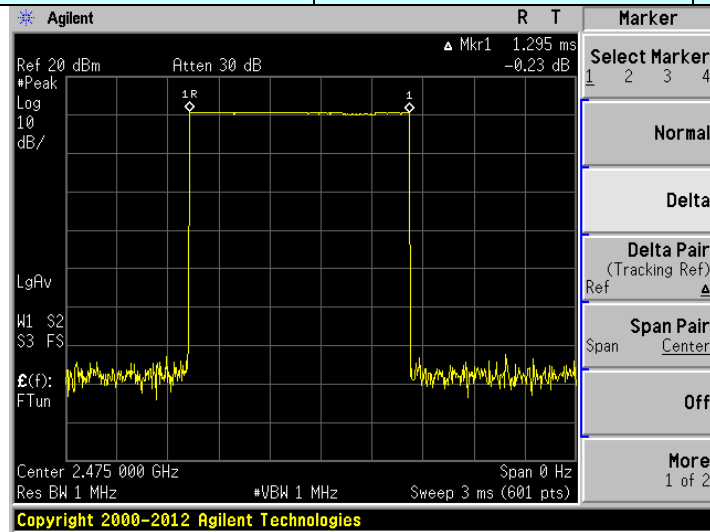

Ton

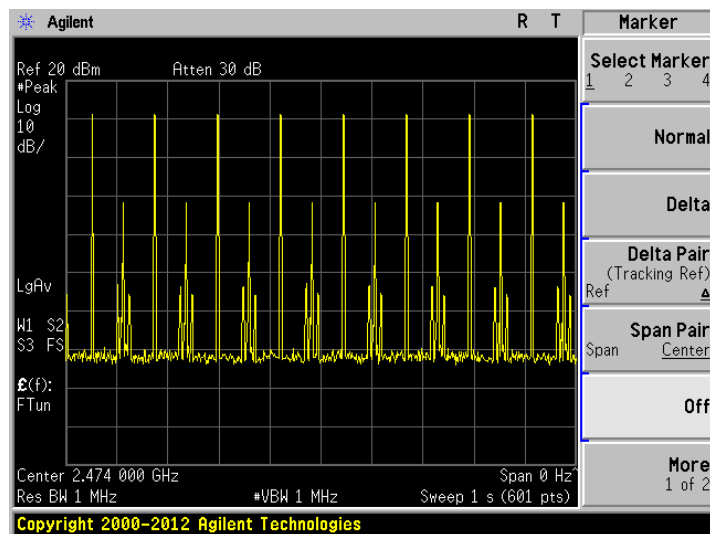

Ton times in 1s

## 6.7 Pseudorandom Frequency Hopping Sequence

Test Requirement:	FCC Part15 C Section 15.247 (a)(1) requirement:
<p><i>Frequency hopping systems shall have hopping channel carrier frequencies separated by a minimum of 25 kHz or the 20 dB bandwidth of the hopping channel, whichever is greater.</i></p> <p><i>Alternatively. Frequency hopping systems operating in the 2400-2483.5 MHz band may have hopping channel carrier frequencies that are separated by 25 kHz or two-thirds of the 20 dB bandwidth of the hopping channel, whichever is greater, provided the systems operate with an output power no greater than 125 mW. The system shall hop to channel frequencies that are selected at the system hopping rate from a Pseudorandom ordered list of hopping frequencies. Each frequency must be used equally on the average by each transmitter. The system receivers shall have input bandwidths that match the hopping channel bandwidths of their corresponding transmitters and shall shift frequencies in synchronization with the transmitted signals.</i></p>	
<p><b>EUT Pseudorandom Frequency Hopping Sequence</b></p>	
<p><i>The pseudorandom sequence may be generated in a nine-stage shift register whose 5th and 9th stage outputs are added in a modulo-two addition stage. And the result is fed back to the input of the first stage. The sequence begins with the first ONE of 9 consecutive ONES; i.e. the shift register is initialized with nine ones.</i></p> <ul style="list-style-type: none"> <li>• Number of shift register stages: 9</li> <li>• Length of pseudo-random sequence: <math>2^9 - 1 = 511</math> bits</li> <li>• Longest sequence of zeros: 8 (non-inverted signal)</li> </ul> <div data-bbox="245 1005 1297 1155" style="text-align: center;"> </div> <p style="text-align: center;"><i>Linear Feedback Shift Register for Generation of the PRBS sequence</i></p> <p><i>Each frequency used equally on the average by each transmitter.</i></p> <p><i>The system receivers have input bandwidths that match the hopping channel bandwidths of their corresponding transmitters and shift frequencies in synchronization with the transmitted signals.</i></p>	

## 6.8 Band Edge

### 6.8.1 Conducted Emission Method

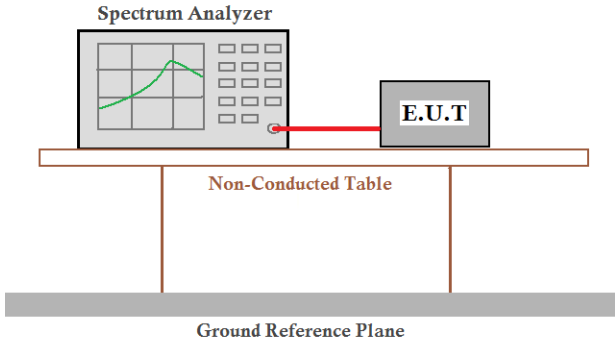
Test Requirement:	FCC Part15 C Section 15.247 (d)
Test Method:	DA 00-705, ANSI C63.10:2013
Receiver setup:	RBW=100kHz, VBW=300kHz, Detector=Peak
Limit:	In any 100 kHz bandwidth outside the frequency band in which the spread spectrum intentional radiator is operating, the radio frequency power that is produced by the intentional radiator shall be at least 20 dB below that in the 100 kHz bandwidth within the band that contains the highest level of the desired power, based on either an RF conducted or a radiated measurement.
Test setup:	 <p>The diagram illustrates the test setup. A Spectrum Analyzer is connected to an E.U.T. (Equipment Under Test) via a red cable. Both are placed on a Non-Conducted Table, which is supported by a Ground Reference Plane.</p>
Test Instruments:	Refer to section 5.8 for details
Test mode:	Refer to section 5.3 for details
Test results:	Pass

**Test plot as follows:**



**Antenna 1:**

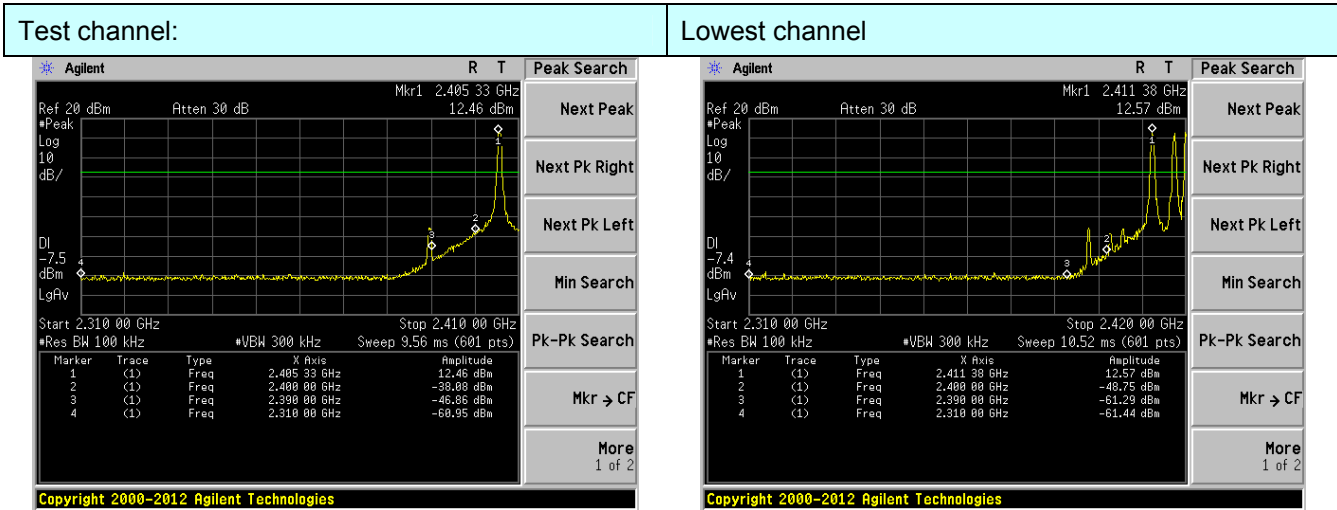

No-hopping mode

Hopping mode

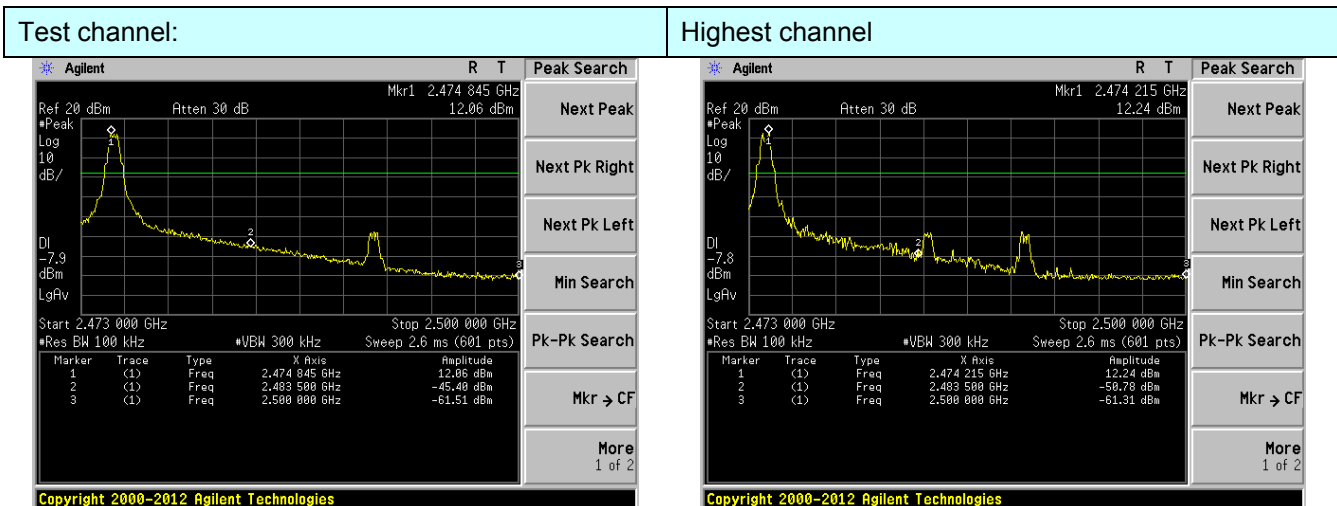

No-hopping mode

Hopping mode

**Antenna 2:**

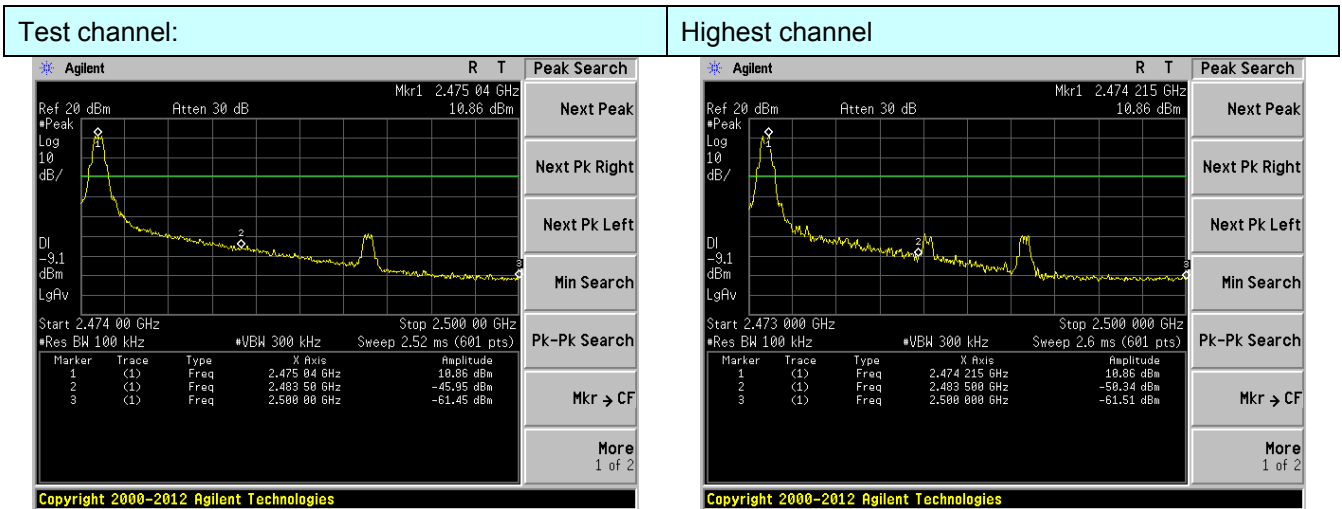
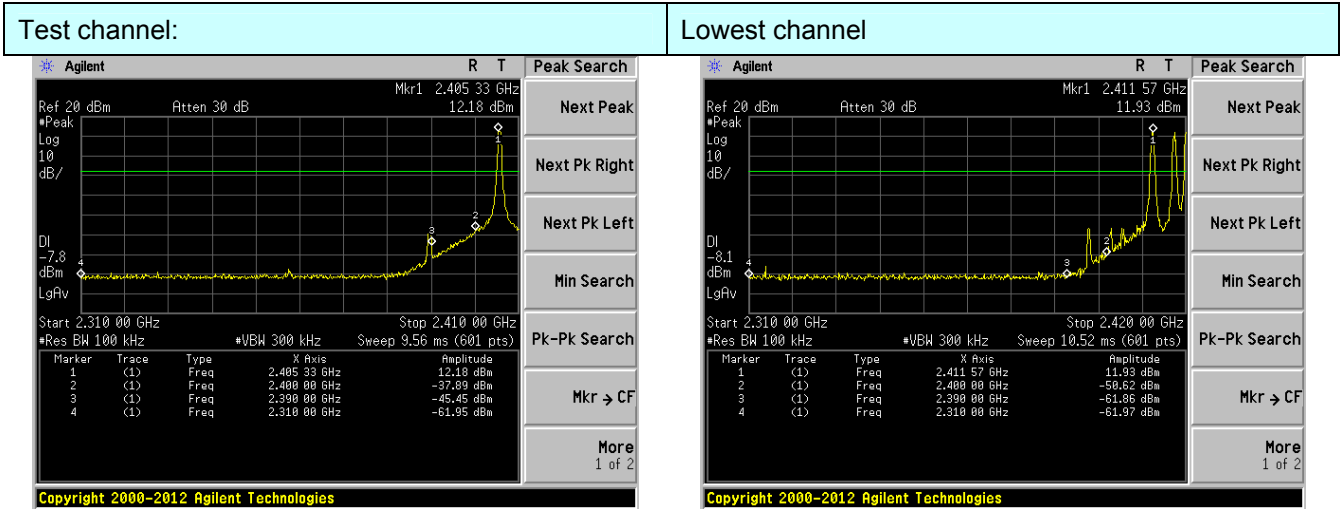

## 6.8.2 Radiated Emission Method

Test Requirement:	FCC Part15 C Section 15.209 and 15.205				
Test Method:	ANSI C63.10:2013				
Test Frequency Range:	All restriction band have been tested, and 2.3GHz to 2.5GHz band is the worse case				
Test site:	Measurement Distance: 3m				
Receiver setup:	Frequency	Detector	RBW	VBW	Remark
	Above 1GHz	Peak	1MHz	3MHz	Peak Value
		Peak	1MHz	10Hz	Average Value
Limit:	Frequency		Limit (dBuV/m @3m)		Remark
	Above 1GHz		54.00		Average Value
			74.00		Peak Value
Test setup:					
Test Procedure:	<ol style="list-style-type: none"> <li>1. The EUT was placed on the top of a rotating table 0.8 meters above the ground at a 3 meter camber. The table was rotated 360 degrees to determine the position of the highest radiation.</li> <li>2. The EUT was set 3 meters away from the interference-receiving antenna, which was mounted on the top of a variable-height antenna tower.</li> <li>3. The antenna height is varied from one meter to four meters above the ground to determine the maximum value of the field strength. Both horizontal and vertical polarizations of the antenna are set to make the measurement.</li> <li>4. For each suspected emission, the EUT was arranged to its worst case and then the antenna was tuned to heights from 1 meter to 4 meters and the rota table was turned from 0 degrees to 360 degrees to find the maximum reading.</li> <li>5. The test-receiver system was set to Peak Detect Function and Specified Bandwidth with Maximum Hold Mode.</li> <li>6. If the emission level of the EUT in peak mode was 10dB lower than the limit specified, then testing could be stopped and the peak values of the EUT would be reported. Otherwise the emissions that did not have 10dB margin would be re-tested one by one using peak, quasi-peak or average method as specified and then reported in a data sheet.</li> </ol>				
Test Instruments:	Refer to section 5.8 for details				
Test mode:	Refer to section 5.3 for details				
Test results:	Pass				

**Remark:**

1. Pre-scan all kind of the place mode (X-axis, Y-axis, Z-axis), and found the Y-axis which it is worse case.
2. Two antenna were tested and found the antenna1 is worse. So only the data of antenna1 is reported.

**Antenna 1:**

Test channel:	Lowest
---------------	--------

**Peak value:**

Frequency (MHz)	Read Level (dBuV)	Antenna Factor (dB/m)	Cable Loss (dB)	Preamp Factor (dB)	Level (dBuV/m)	Limit Line (dBuV/m)	Over Limit (dB)	Polarization
2390.00	60.48	27.59	5.38	30.18	63.27	74.00	-10.73	Vertical
2400.00	69.62	27.58	5.39	30.18	72.41	74.00	-1.59	Vertical
2390.00	54.42	27.59	5.38	30.18	57.21	74.00	-16.79	Horizontal
2400.00	60.46	27.58	5.39	30.18	63.25	74.00	-10.75	Horizontal

**Average value:**

Frequency (MHz)	Read Level (dBuV)	Antenna Factor (dB/m)	Cable Loss (dB)	Preamp Factor (dB)	Level (dBuV/m)	Limit Line (dBuV/m)	Over Limit (dB)	Polarization
2390.00	45.14	27.59	5.38	30.18	47.93	54.00	-6.07	Vertical
2400.00	49.85	27.58	5.39	30.18	52.64	54.00	-1.36	Vertical
2390.00	41.27	27.59	5.38	30.18	44.06	54.00	-9.94	Horizontal
2400.00	45.44	27.58	5.39	30.18	48.23	54.00	-5.77	Horizontal

Test channel:	Highest
---------------	---------

**Peak value:**

Frequency (MHz)	Read Level (dBuV)	Antenna Factor (dB/m)	Cable Loss (dB)	Preamp Factor (dB)	Level (dBuV/m)	Limit Line (dBuV/m)	Over Limit (dB)	Polarization
2483.50	60.22	27.53	5.47	29.93	63.29	74.00	-10.71	Vertical
2500.00	51.35	27.55	5.49	29.93	54.46	74.00	-19.54	Vertical
2483.50	56.95	27.53	5.47	29.93	60.02	74.00	-13.98	Horizontal
2500.00	50.35	27.55	5.49	29.93	53.46	74.00	-20.54	Horizontal

**Average value:**

Frequency (MHz)	Read Level (dBuV)	Antenna Factor (dB/m)	Cable Loss (dB)	Preamp Factor (dB)	Level (dBuV/m)	Limit Line (dBuV/m)	Over Limit (dB)	Polarization
2483.50	44.20	27.53	5.47	29.93	47.27	54.00	-6.73	Vertical
2500.00	38.96	27.55	5.49	29.93	42.07	54.00	-11.93	Vertical
2483.50	43.21	27.53	5.47	29.93	46.28	54.00	-7.72	Horizontal
2500.00	37.75	27.55	5.49	29.93	40.86	54.00	-13.14	Horizontal

*Remark:*

1. *Final Level = Receiver Read level + Antenna Factor + Cable Loss – Preamplifier Factor*
2. *The emission levels of other frequencies are very lower than the limit and not show in test report.*

## 6.9 Spurious Emission

### 6.9.1 Conducted Emission Method

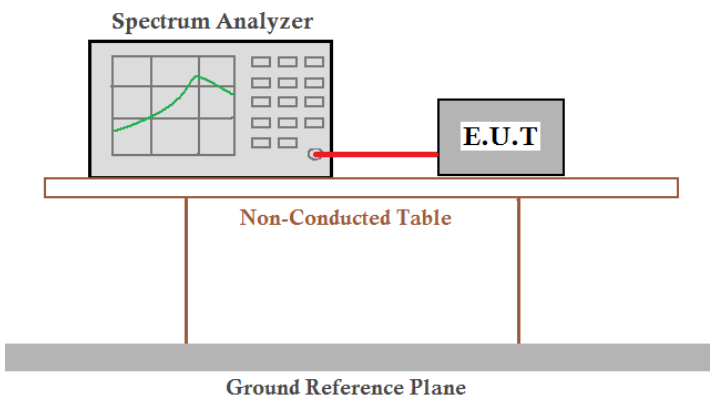
Test Requirement:	FCC Part15 C Section 15.247 (d)
Test Method:	ANSI C63.10:2013
Limit:	In any 100 kHz bandwidth outside the frequency band in which the spread spectrum intentional radiator is operating, the radio frequency power that is produced by the intentional radiator shall be at least 20 dB below that in the 100 kHz bandwidth within the band that contains the highest level of the desired power, based on either an RF conducted or a radiated measurement.
Test setup:	 <p>The diagram illustrates the test setup. A Spectrum Analyzer is connected to an E.U.T. (Equipment Under Test) via a red cable. Both are placed on a Non-Conducted Table, which sits on a Ground Reference Plane.</p>
Test Instruments:	Refer to section 5.8 for details
Test mode:	Refer to section 5.3 for details
Test results:	Pass

**Antenna 1:**

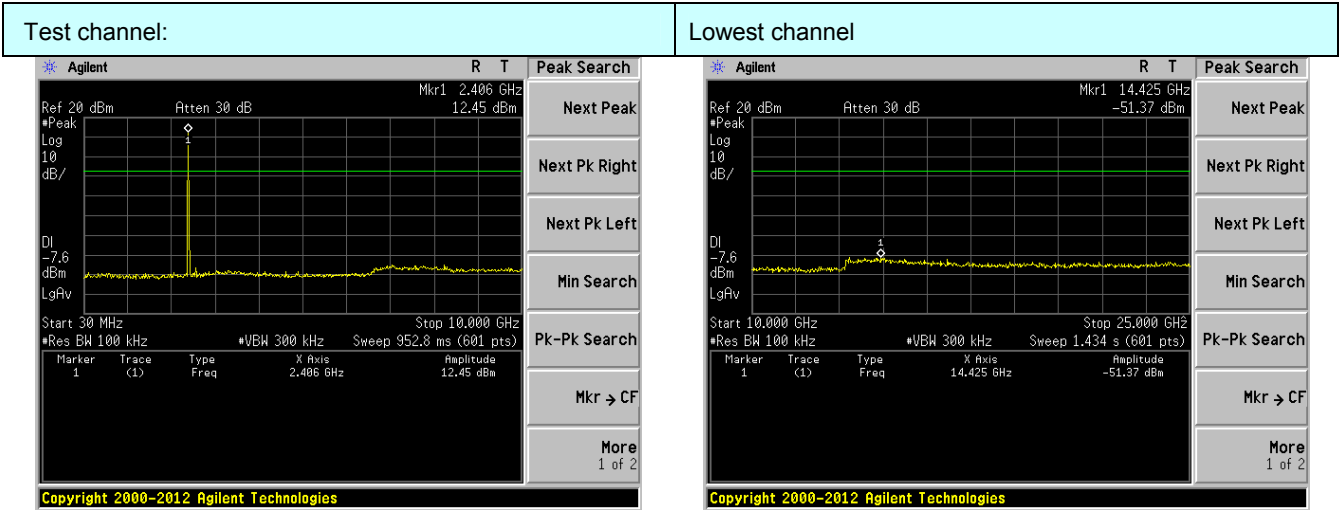

30MHz~10GHz

10GHz~25GHz

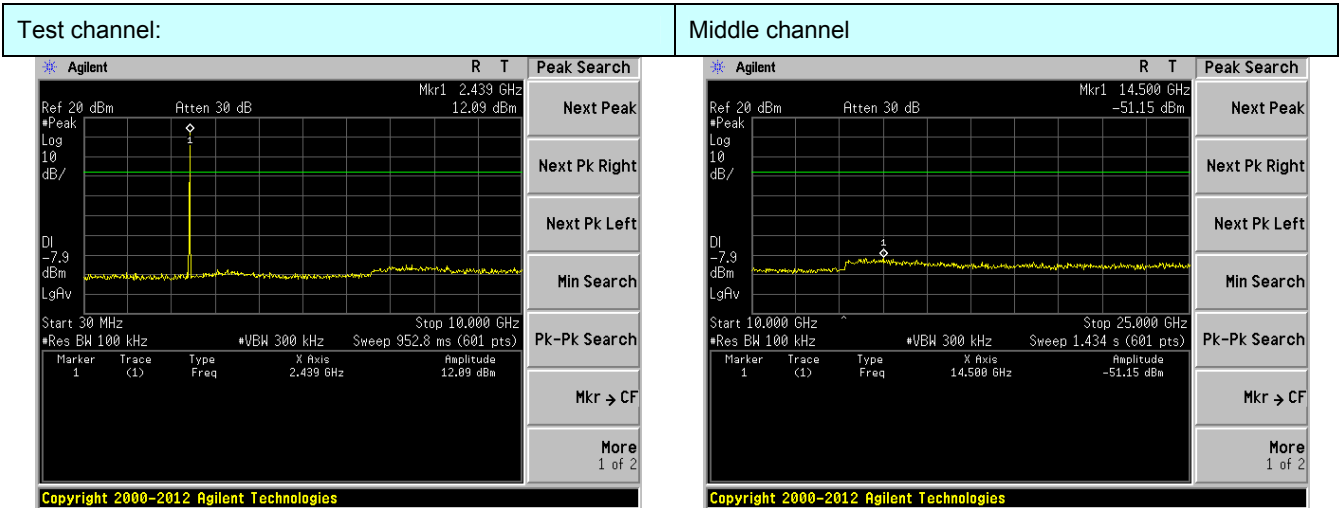

30MHz~10GHz

10GHz~25GHz

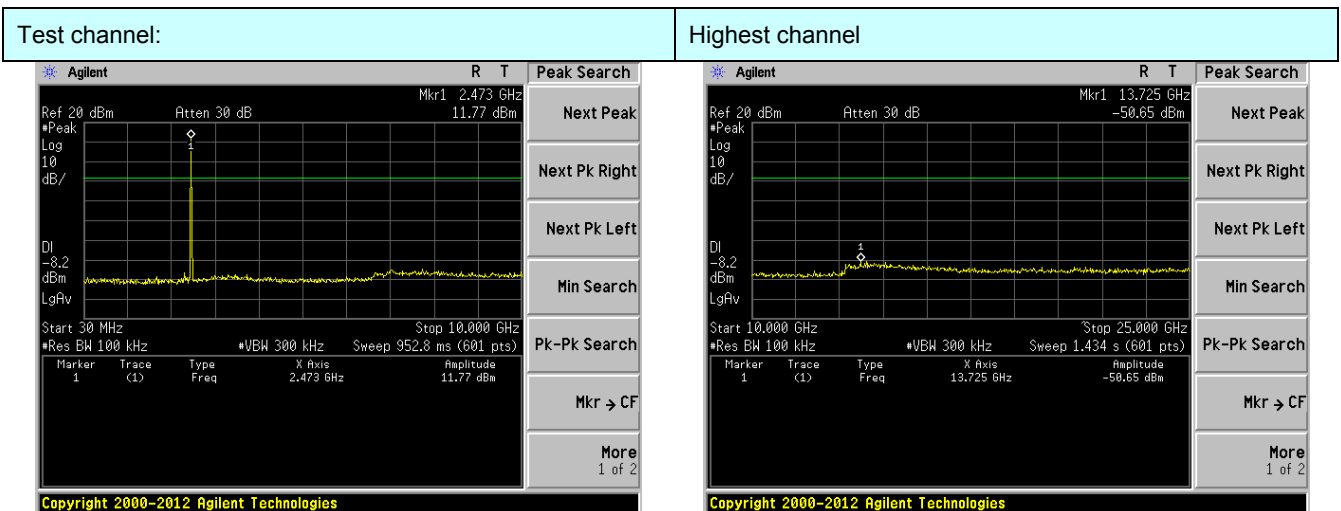

30MHz~10GHz

10GHz~25GHz

**Antenna 2:**

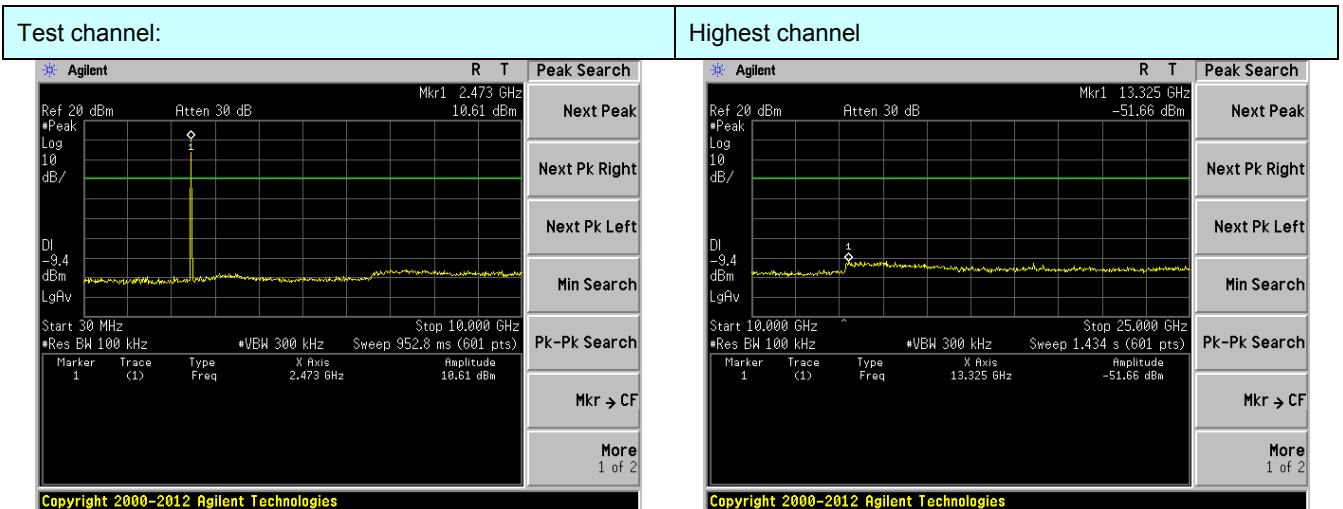
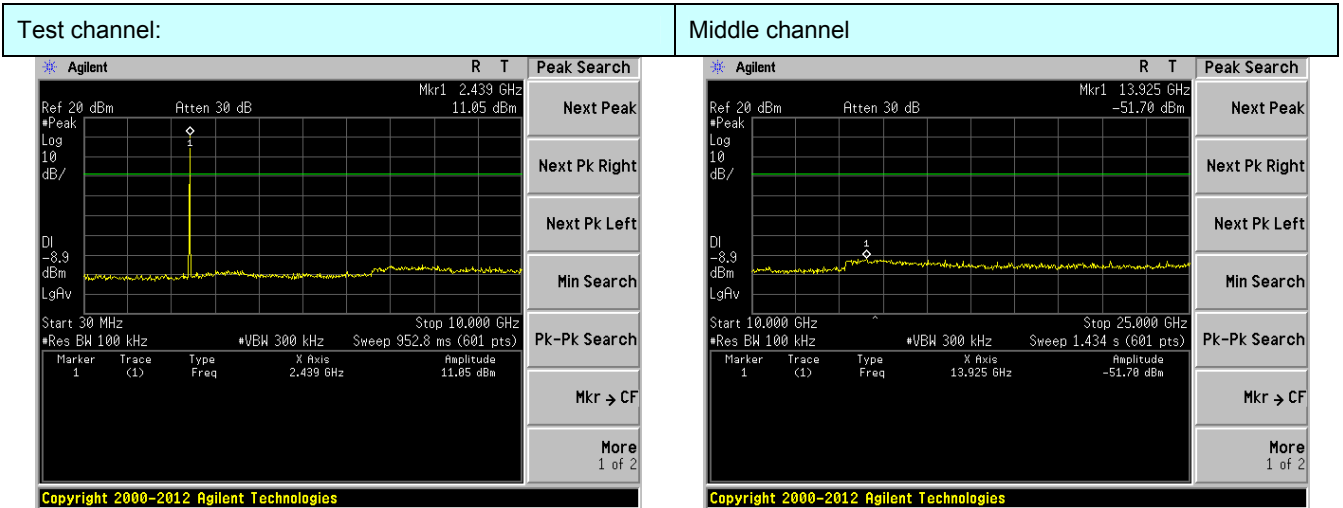
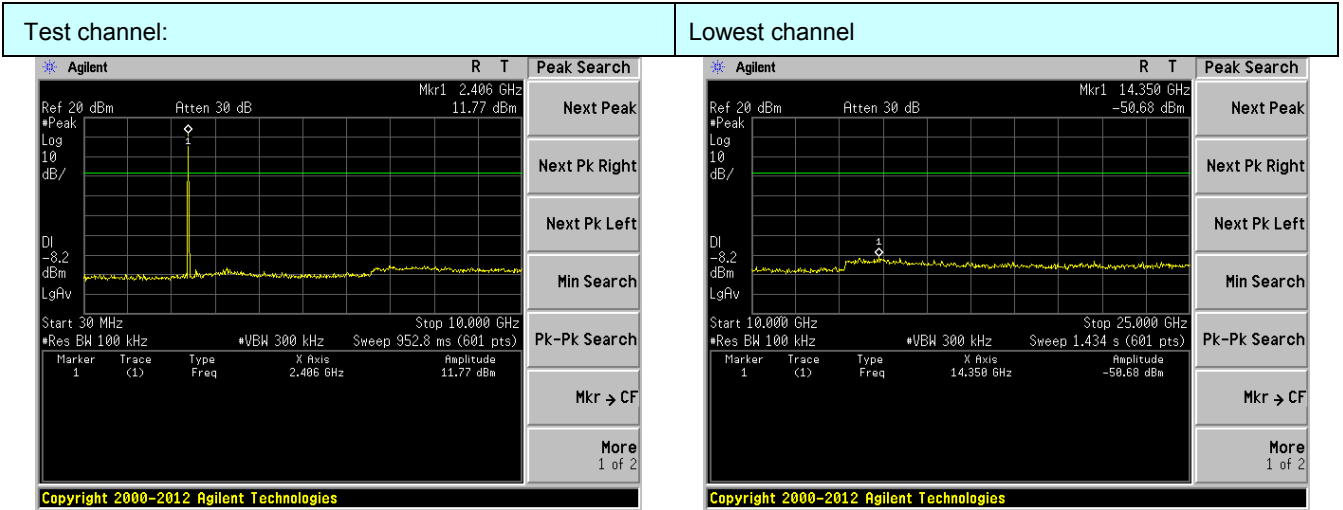

## 6.9.2 Radiated Emission Method

Test Requirement:	FCC Part15 C Section 15.209				
Test Method:	ANSI C63.10:2013				
Test Frequency Range:	9kHz to 25GHz				
Test site:	Measurement Distance: 3m				
Receiver setup:	Frequency	Detector	RBW	VBW	Value
	9KHz-150KHz	Quasi-peak	200Hz	600Hz	Quasi-peak
	150KHz-30MHz	Quasi-peak	9KHz	30KHz	Quasi-peak
	30MHz-1GHz	Quasi-peak	100KHz	300KHz	Quasi-peak
	Above 1GHz	Peak	1MHz	3MHz	Peak
Peak		1MHz	10Hz	Average	
Limit: (Spurious Emissions)	Frequency	Limit (uV/m)	Value	Measurement Distance	
	0.009MHz-1.705MHz	2400/F(KHz)	QP	300m	
	0.490MHz-1.705MHz	24000/F(KHz)	QP	300m	
	1.705MHz-30MHz	30	QP	30m	
	30MHz-88MHz	100	QP	3m	
	88MHz-216MHz	150	QP		
	216MHz-960MHz	200	QP		
	960MHz-1GHz	500	QP		
	Above 1GHz	500	Average		
		5000	Peak		
Test setup:	Below 1GHz				
	<p>Above 1GHz</p>				



	<p>The diagram illustrates the test setup. An EUT (Equipment Under Test) is placed on a turn table that is 1.5m high. The EUT is positioned 3m away from the antenna. The antenna is mounted on an antenna tower at a height of 4m. The antenna is connected to a spectrum analyzer via an amplifier. The antenna is a horn antenna.</p>
<p>Test Procedure:</p>	<ol style="list-style-type: none"> <li>1. The EUT was placed on the top of a rotating table 0.8 meters above the ground at a 3 meter camber. The table was rotated 360 degrees to determine the position of the highest radiation.</li> <li>2. The EUT was set 3 meters away from the interference-receiving antenna, which was mounted on the top of a variable-height antenna tower.</li> <li>3. The antenna height is varied from one meter to four meters above the ground to determine the maximum value of the field strength. Both horizontal and vertical polarizations of the antenna are set to make the measurement.</li> <li>4. For each suspected emission, the EUT was arranged to its worst case and then the antenna was tuned to heights from 1 meter to 4 meters and the rota table was turned from 0 degrees to 360 degrees to find the maximum reading.</li> <li>5. The test-receiver system was set to Peak Detect Function and Specified Bandwidth with Maximum Hold Mode.</li> <li>6. If the emission level of the EUT in peak mode was 10dB lower than the limit specified, then testing could be stopped and the peak values of the EUT would be reported. Otherwise the emissions that did not have 10dB margin would be re-tested one by one using peak, quasi-peak or average method as specified and then reported in a data sheet.</li> </ol>
<p>Test Instruments:</p>	<p>Refer to section 5.8 for details</p>
<p>Test mode:</p>	<p>Refer to section 5.3 for details</p>
<p>Test results:</p>	<p>Pass</p>

**Remark:**

1. Pre-scan all kind of the place mode (X-axis, Y-axis, Z-axis), and found the Y-axis which it is worse case.
2. The measured filed strength at frequencies below 30MHz are lower than the limit over 30dB. So the data isn't reported.
3. Two antenna were tested and found the antenna 1 is worse. So only the data of antenna 1 is reported.

**Measurement data:**

■ **30MHz ~ 1GHz**

Frequency (MHz)	Read Level (dBuV)	Antenna Factor (dB/m)	Cable Loss (dB)	Preamplifier Factor (dB)	Level (dBuV/m)	Limit Line (dBuV/m)	Over Limit (dB)	Polarization
197.89	54.10	12.57	1.83	29.21	39.29	43.50	-4.21	Vertical
210.05	50.96	12.87	1.90	29.30	36.43	43.50	-7.07	Vertical
222.17	47.58	13.25	1.97	29.41	33.39	46.00	-12.61	Vertical
234.17	45.72	13.83	2.04	29.52	32.07	46.00	-13.93	Vertical
270.38	47.89	14.38	2.22	29.80	34.69	46.00	-11.31	Vertical
317.70	40.32	15.31	2.45	29.90	28.18	46.00	-17.82	Vertical
185.79	42.33	12.16	1.77	29.25	27.01	43.50	-16.49	Horizontal
197.89	49.93	12.57	1.83	29.21	35.12	43.50	-8.38	Horizontal
258.33	50.47	14.05	2.16	29.71	36.97	46.00	-9.03	Horizontal
282.00	49.23	14.70	2.28	29.88	36.33	46.00	-9.67	Horizontal
306.75	48.77	15.15	2.39	29.96	36.35	46.00	-9.65	Horizontal
317.70	49.79	15.31	2.45	29.90	37.65	46.00	-8.35	Horizontal

■ Above 1GHz

Test channel:	Lowest
---------------	--------

**Peak value:**

Frequency (MHz)	Read Level (dBuV)	Antenna Factor (dB/m)	Cable Loss (dB)	Preamp Factor (dB)	Level (dBuV/m)	Limit Line (dBuV/m)	Over Limit (dB)	Polarization
4811.00	52.86	31.78	8.60	32.09	61.15	74.00	-12.85	Vertical
7216.50	28.46	36.15	11.66	31.99	44.28	74.00	-29.72	Vertical
9622.00	29.13	38.01	14.14	31.60	49.68	74.00	-24.32	Vertical
12027.50	*					74.00		Vertical
14433.00	*					74.00		Vertical
4811.00	50.74	31.78	8.60	32.09	59.03	74.00	-14.97	Horizontal
7216.50	28.61	36.15	11.66	31.99	44.43	74.00	-29.57	Horizontal
9622.00	27.23	38.01	14.14	31.60	47.78	74.00	-26.22	Horizontal
12027.50	*					74.00		Horizontal
14433.00	*					74.00		Horizontal

**Average value:**

Frequency (MHz)	Read Level (dBuV)	Antenna Factor (dB/m)	Cable Loss (dB)	Preamp Factor (dB)	Level (dBuV/m)	Limit Line (dBuV/m)	Over Limit (dB)	Polarization
4811.00	42.20	31.78	8.60	32.09	50.49	54.00	-3.51	Vertical
7216.50	18.30	36.15	11.66	31.99	34.12	54.00	-19.88	Vertical
9622.00	19.00	38.01	14.14	31.60	39.55	54.00	-14.45	Vertical
12027.50	*					54.00		Vertical
14433.00	*					54.00		Vertical
4811.00	40.60	31.78	8.60	32.09	48.89	54.00	-5.11	Horizontal
7216.50	18.83	36.15	11.66	31.99	34.65	54.00	-19.35	Horizontal
9622.00	16.80	38.01	14.14	31.60	37.35	54.00	-16.65	Horizontal
12027.50	*					54.00		Horizontal
14433.00	*					54.00		Horizontal

*Remark:*

1. *Final Level = Receiver Read level + Antenna Factor + Cable Loss – Pre-amplifier Factor*
2. *“\*”*, means this data is the too weak instrument of signal is unable to test.
3. *The emission levels of other frequencies are very lower than the limit and not show in test report.*

Test channel:	Middle
---------------	--------

**Peak value:**

Frequency (MHz)	Read Level (dBuV)	Antenna Factor (dB/m)	Cable Loss (dB)	Preamp Factor (dB)	Level (dBuV/m)	Limit Line (dBuV/m)	Over Limit (dB)	Polarization
4880.00	47.02	31.85	8.66	32.12	55.41	74.00	-18.59	Vertical
7320.00	28.40	36.37	11.72	31.89	44.60	74.00	-29.40	Vertical
9760.00	27.99	38.35	14.25	31.59	49.00	74.00	-25.00	Vertical
12200.00	*					74.00		Vertical
14640.00	*					74.00		Vertical
4880.00	48.27	31.85	8.66	32.12	56.66	74.00	-17.34	Horizontal
7425.00	28.72	36.56	11.79	31.80	45.27	74.00	-28.73	Horizontal
9900.00	26.70	38.81	14.35	31.85	48.01	74.00	-25.99	Horizontal
12200.00	*					74.00		Horizontal
14640.00	*					74.00		Horizontal

**Average value:**

Frequency (MHz)	Read Level (dBuV)	Antenna Factor (dB/m)	Cable Loss (dB)	Preamp Factor (dB)	Level (dBuV/m)	Limit Line (dBuV/m)	Over Limit (dB)	Polarization
4880.00	37.21	31.85	8.66	32.12	45.60	54.00	-8.40	Vertical
7320.00	18.19	36.37	11.72	31.89	34.39	54.00	-19.61	Vertical
9760.00	17.86	38.35	14.25	31.59	38.87	54.00	-15.13	Vertical
12200.00	*					54.00		Vertical
14640.00	*					54.00		Vertical
4880.00	40.15	31.85	8.66	32.12	48.54	54.00	-5.46	Horizontal
7320.00	19.19	36.37	11.72	31.89	35.39	54.00	-18.61	Horizontal
9760.00	17.69	38.35	14.25	31.59	38.70	54.00	-15.30	Horizontal
12200.00	*					54.00		Horizontal
14640.00	*					54.00		Horizontal

*Remark:*

1. *Final Level = Receiver Read level + Antenna Factor + Cable Loss – Pre-amplifier Factor*
2. *“\*”*, means this data is the too weak instrument of signal is unable to test.
3. *The emission levels of other frequencies are very lower than the limit and not show in test report.*

Test channel:	Highest
---------------	---------

**Peak value:**

Frequency (MHz)	Read Level (dBuV)	Antenna Factor (dB/m)	Cable Loss (dB)	Preamp Factor (dB)	Level (dBuV/m)	Limit Line (dBuV/m)	Over Limit (dB)	Polarization
4950.00	48.95	31.91	8.71	32.16	57.41	74.00	-16.59	Vertical
7425.00	28.01	36.56	11.79	31.80	44.56	74.00	-29.44	Vertical
9900.00	27.26	38.81	14.35	31.85	48.57	74.00	-25.43	Vertical
12375.00	*					74.00		Vertical
14850.00	*					74.00		Vertical
4950.00	48.22	31.91	8.71	32.16	56.68	74.00	-17.32	Horizontal
7425.00	28.43	36.56	11.79	31.80	44.98	74.00	-29.02	Horizontal
9900.00	26.96	38.81	14.35	31.85	48.27	74.00	-25.73	Horizontal
12375.00	*					74.00		Horizontal
14850.00	*					74.00		Horizontal

**Average value:**

Frequency (MHz)	Read Level (dBuV)	Antenna Factor (dB/m)	Cable Loss (dB)	Preamp Factor (dB)	Level (dBuV/m)	Limit Line (dBuV/m)	Over Limit (dB)	Polarization
4950.00	38.30	31.91	8.71	32.16	46.76	54.00	-7.24	Vertical
7425.00	18.67	36.56	11.79	31.80	35.22	54.00	-18.78	Vertical
9900.00	17.55	38.81	14.35	31.85	38.86	54.00	-15.14	Vertical
12375.00	*					54.00		Vertical
14850.00	*					54.00		Vertical
4950.00	38.29	31.91	8.71	32.16	46.75	54.00	-7.25	Horizontal
7425.00	19.12	36.56	11.79	31.80	35.67	54.00	-18.33	Horizontal
9900.00	17.02	38.81	14.35	31.85	38.33	54.00	-15.67	Horizontal
12375.00	*					54.00		Horizontal
14850.00	*					54.00		Horizontal

*Remark:*

1. *Final Level = Receiver Read level + Antenna Factor + Cable Loss – Pre-amplifier Factor*
2. *“\*”*, means this data is the too weak instrument of signal is unable to test.
3. *The emission levels of other frequencies are very lower than the limit and not show in test report.*

## 7 Test Setup Photo

### Radiated Emission

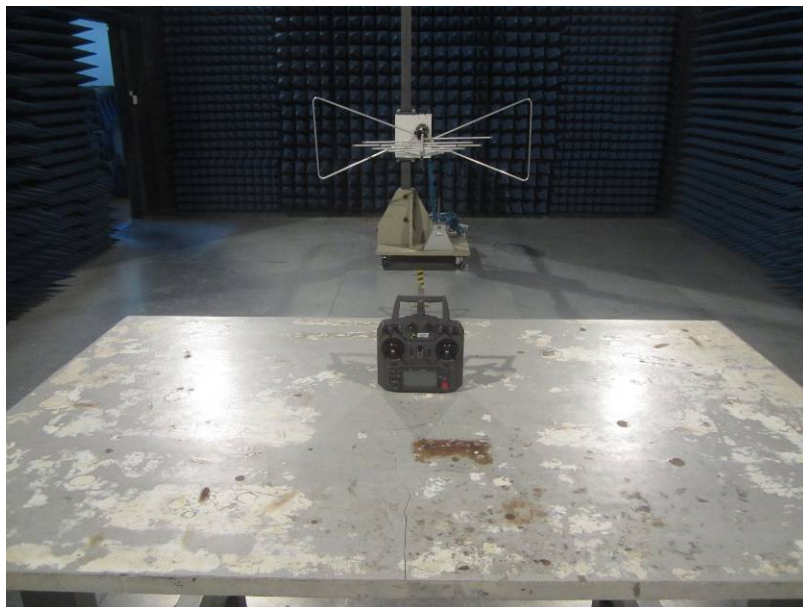
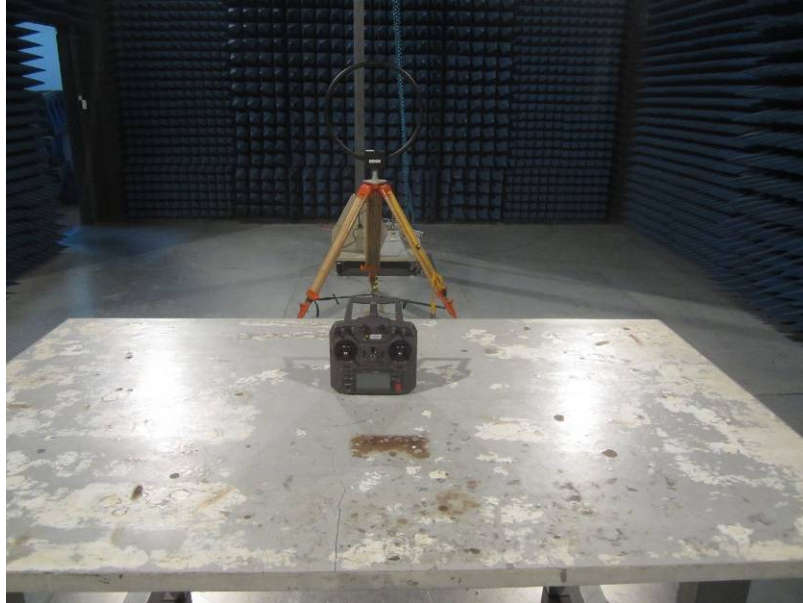



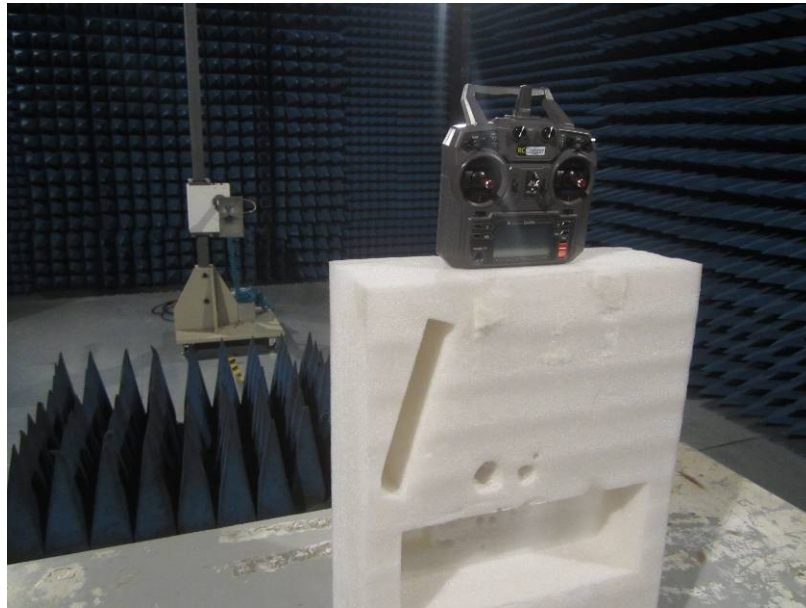

## Conducted Measurement



## 8 EUT Constructional Details





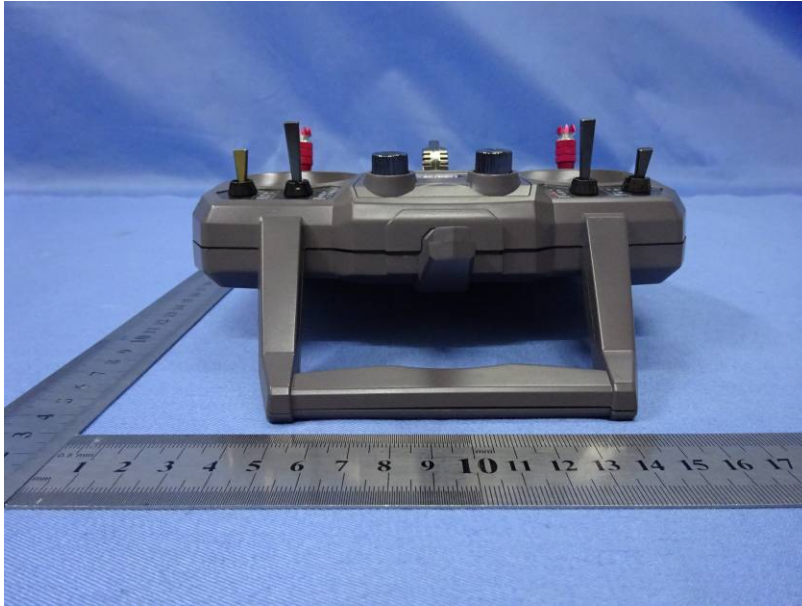



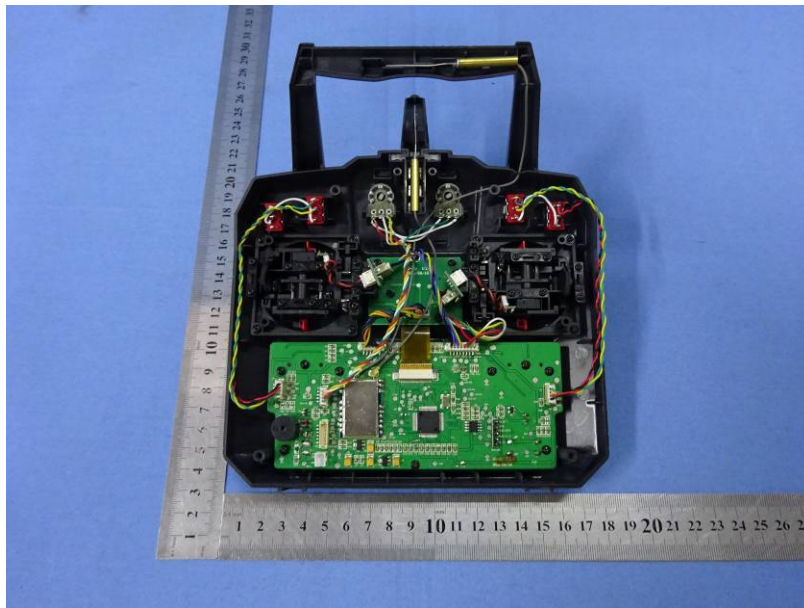
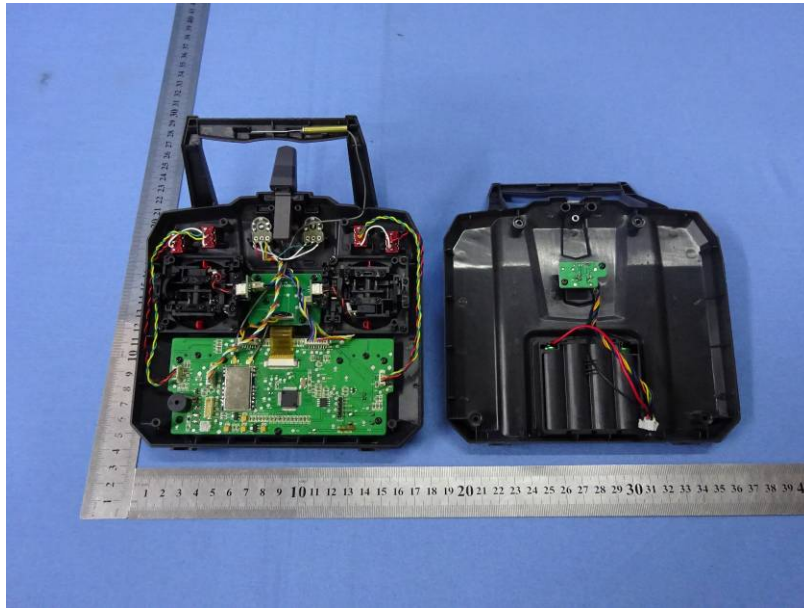



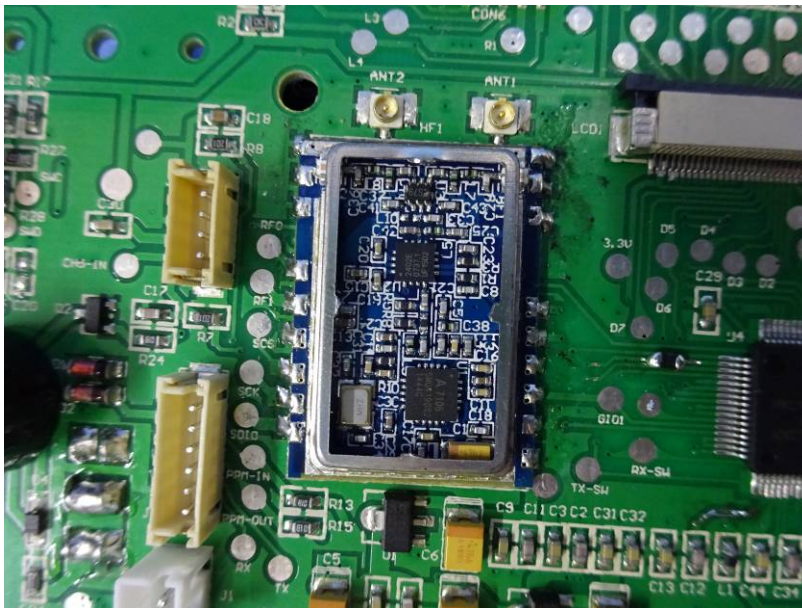
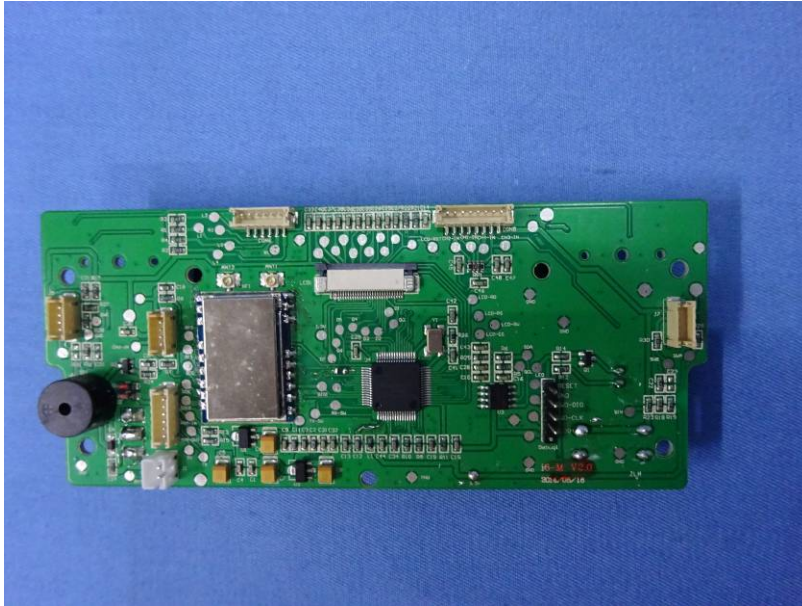

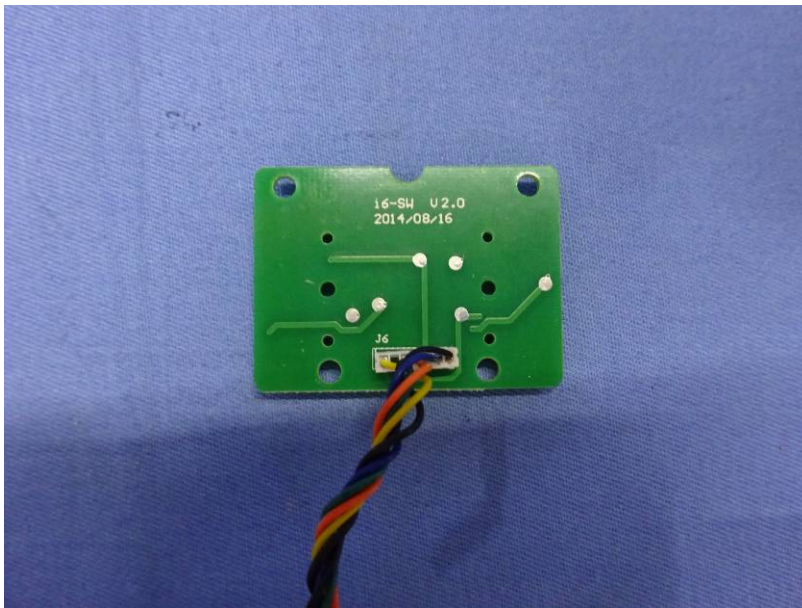
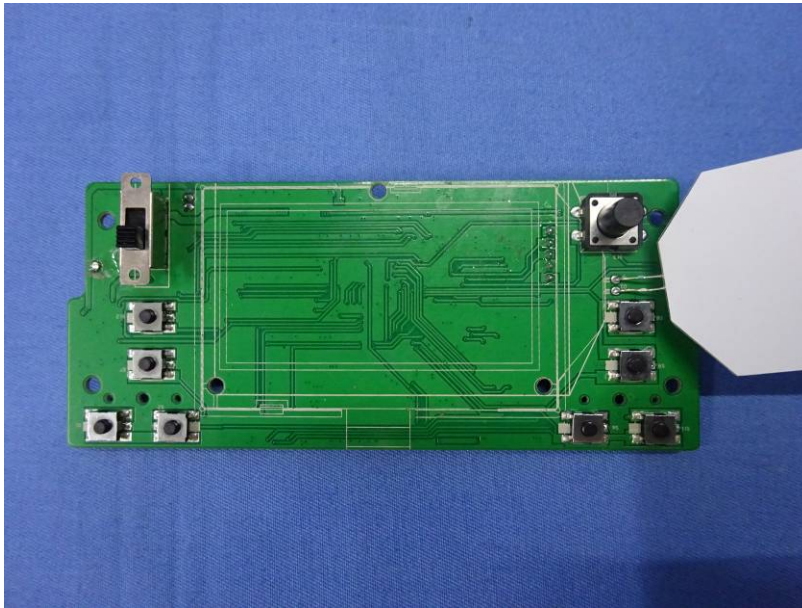



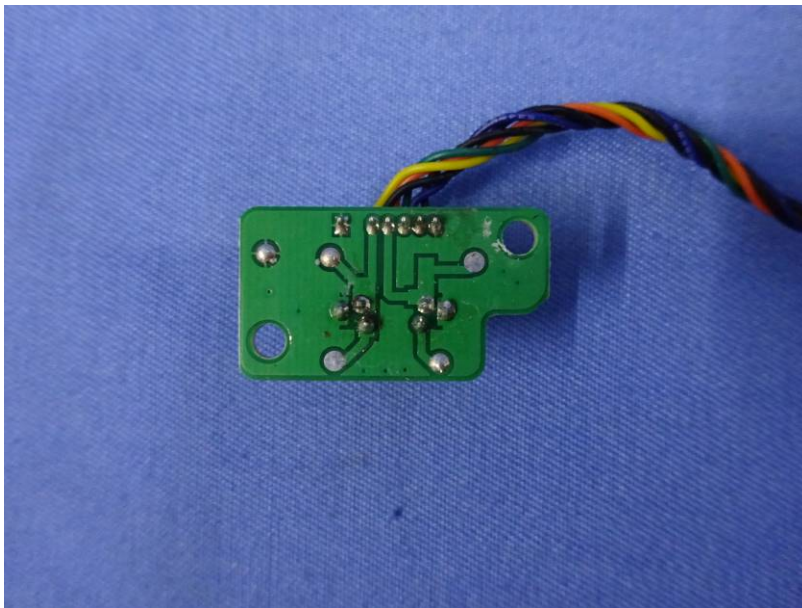
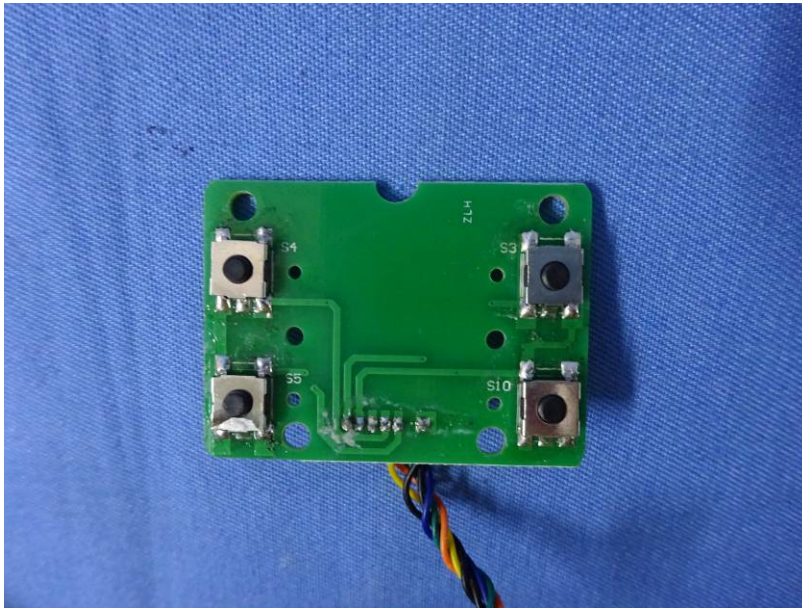

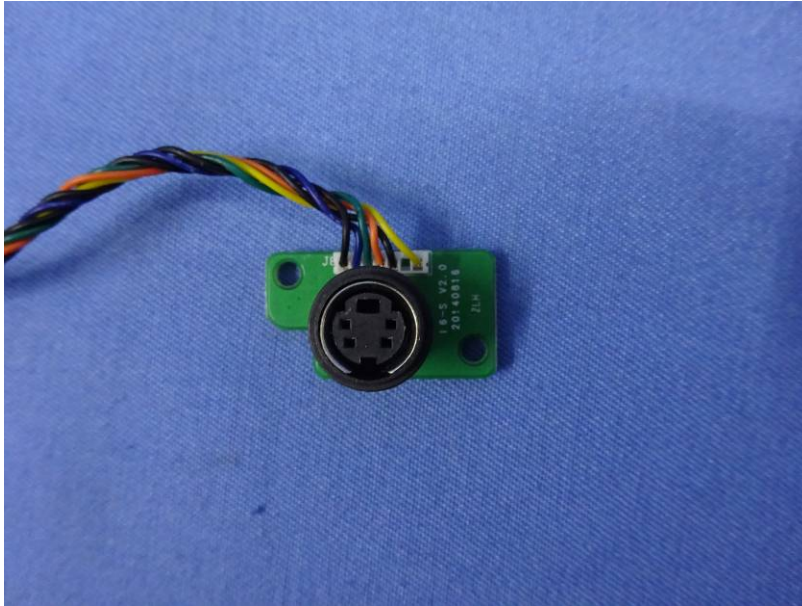

---End---