



# SGS-CSTC Standards Technical Services (Shanghai) Co., Ltd.

588 West Jindu Road, Songjiang District, Shanghai, China  
Telephone: +86 (0) 21 6191 5666  
Fax: +86 (0) 21 6191 5678  
ee.shanghai@sgs.com

Report No.: SHEM151200471001  
Page: 1 of 34

## 1 Cover Page

# FCC Part 15C TEST REPORT

Application No.:	SHEM1512004710CR
Applicant:	Medtrum Technologies Inc.
FCC ID:	2AARUTY015
<b>Equipment Under Test (EUT):</b> <b>NOTE:</b> The following sample(s) was/were submitted and identified by the client as	
Product Name:	Transmitter
Model No.(EUT):	MD-TY-015
Standards:	FCC PART 15 Subpart C: 2015
Date of Receipt:	December 17, 2015
Date of Test:	December 18, 2015 to December 30, 2015
Date of Issue:	January 15, 2016
Test Result:	<b>Pass*</b>

\*In the configuration tested, the EUT detailed in this report complied with the standards specified above.



**Parlam Zhan**  
**E&E Section Manager**  
**SGS-CSTC (Shanghai) Co., Ltd.**

The manufacturer should ensure that all products in series production are in conformity with the product sample detailed in this report. If the product in this report is used in any configuration other than that detailed in the report, the manufacturer must ensure the new system complies with all relevant standards.



The report must not be used by the client to claim product certification, approval, or endorsement by NVLAP, NIST, or any agency of the federal government. All test results in this report can be traceable to National or International Standards.

This document is issued by the Company subject to its General Conditions of Service printed overleaf, available on request or accessible at [www.sgs.com/terms\\_and\\_conditions.htm](http://www.sgs.com/terms_and_conditions.htm) and, for electronic format documents, subject to Terms and Conditions for Electronic Documents at [www.sgs.com/terms\\_e-document.htm](http://www.sgs.com/terms_e-document.htm). Attention is drawn to the limitation of liability, indemnification and jurisdiction issues defined therein. Any holder of this document is advised that information contained hereon reflects the Company's findings at the time of its intervention only and within the limits of Client's instructions, if any. The Company's sole responsibility is to its Client and this document does not exonerate parties to a transaction from exercising all their rights and obligations under the transaction documents. This document cannot be reproduced except in full, without prior written approval of the Company. Any unauthorized alteration, forgery or falsification of the content or appearance of this document is unlawful and offenders may be prosecuted to the fullest extent of the law. Unless otherwise stated the results shown in this test report refer only to the sample(s) tested and such sample(s) are retained for 90 days only.



## 2 Version

Revision Record				
Version	Chapter	Date	Modifier	Remark
00	/	January 15, 2016	/	Original

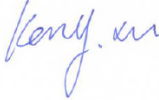
<b>Authorized for issue by:</b>			
<b>Engineer</b>		Eddy Zong _____ <b>Print Name</b>	
<b>Clerk</b>		Susie Liu _____ <b>Print Name</b>	
<b>Reviewer</b>		Keny Xu _____ <b>Print Name</b>	

### 3 Test Summary

Test Item	FCC Requirement	Test method	Result
Antenna Requirement	FCC Part 15, Subpart C Section 15.203/15.247 (c)	---	PASS
AC Power Line Conducted Emission	FCC Part 15, Subpart C Section 15.207	ANSI C63.10 (2013) Section 6.2	N/A
Minimum 6dB Bandwidth	FCC Part 15, Subpart C Section 15.247 (a)(2)	ANSI C63.10 (2013) Section 11.8.1	PASS
Conducted Peak Output Power	FCC Part 15, Subpart C Section 15.247 (b)(3)	ANSI C63.10 (2013) Section 11.9.1.1	PASS
Power Spectrum Density	FCC Part 15, Subpart C Section 15.247 (e)	ANSI C63.10 (2013) Section 11.10.2	PASS
RF Conducted Spurious Emissions and Band-edge	FCC Part 15, Subpart C Section 15.247(d)	ANSI C63.10 (2013) Section 11.11&11.13.3.2	PASS
Radiated Spurious Emissions and Band-edge	FCC Part 15, Subpart C Section 15.209&15.205	ANSI C63.10 (2013) Section 6.4&6.5&6.6&6.10	PASS



## **4 Contents**

	Page
<b>1 COVER PAGE .....</b>	<b>1</b>
<b>2 VERSION .....</b>	<b>2</b>
<b>3 TEST SUMMARY .....</b>	<b>3</b>
<b>4 CONTENTS.....</b>	<b>4</b>
<b>5 GENERAL INFORMATION .....</b>	<b>5</b>
5.1 CLIENT INFORMATION.....	5
5.2 GENERAL DESCRIPTION OF E.U.T.....	5
5.3 TECHNICAL SPECIFICATIONS.....	5
5.4 DESCRIPTION OF SUPPORT UNITS.....	5
5.5 DETAILS OF TEST MODE .....	5
5.6 TEST LOCATION .....	6
5.7 TEST FACILITY .....	6
5.8 MEASUREMENT UNCERTAINTY .....	7
<b>6 EQUIPMENTS LIST.....</b>	<b>7</b>
<b>7 ANTENNA REQUIREMENT .....</b>	<b>8</b>
7.1 E.U.T. TEST CONDITIONS .....	8
7.2 ANTENNA REQUIREMENT.....	9
7.3 CONDUCTED EMISSIONS ON MAINS TERMINALS .....	10
7.4 6dB OCCUPIED BANDWIDTH.....	11
7.5 CONDUCTED PEAK OUTPUT POWER .....	14
7.6 PEAK POWER SPECTRAL DENSITY.....	17
7.7 CONDUCTED SPURIOUS EMISSIONS AND BAND EDGE.....	20
7.7.1 <i>Conducted Spurious Emissions</i> .....	21
7.7.2 <i>Conducted Band-edge</i> .....	24
7.8 RADIATED SPURIOUS EMISSIONS AND BAND-EDGE.....	25
7.8.1 <i>Radiated Spurious Emissions</i> .....	28
7.8.2 <i>Radiated Band-edge</i> .....	31
<b>8 TEST SETUP PHOTOGRAPHS.....</b>	<b>34</b>
<b>9 EUT CONSTRUCTIONAL DETAILS.....</b>	<b>34</b>

## 5 General Information

### 5.1 Client Information

Applicant:	Medtrum Technologies Inc.
Address of Applicant:	7F, Building 8, No.200 Niudun Road, Shanghai, China
Manufacturer:	Medtrum Technologies Inc.
Address of Manufacturer:	7F, Building 8, No.200 Niudun Road, Shanghai, China
Factory:	Medtrum Technologies Inc.
Address of Factory:	7F, Building 8, No.200 Niudun Road, Shanghai, China

### 5.2 General Description of E.U.T.

Product Description:	Portable product with BT 4.0 function
----------------------	---------------------------------------

### 5.3 Technical Specifications

Operation Frequency:	2402MHz-2480MHz
Bluetooth Version:	BT 4.0 Single mode
Modulation Type:	GFSK
Number of Channel:	40
Antenna Type	Integral Antenna
Antenna Gain	1.6 dBi
Power Supply:	DC 3.0V by lithium battery (The new battery is used for the EUT during the test)

### 5.4 Description of Support Units

The EUT has been tested with associated equipment below.

Description	Manufacturer	Model No.	Supplied by
Laptop	Lenovo	ThinkPad X100e	SGS
USB to Serial port plate	/	/	Client

Software name	Manufacturer	Version	Supplied By
nRF tools	Nordic	7.6.0	Client

Description of connection

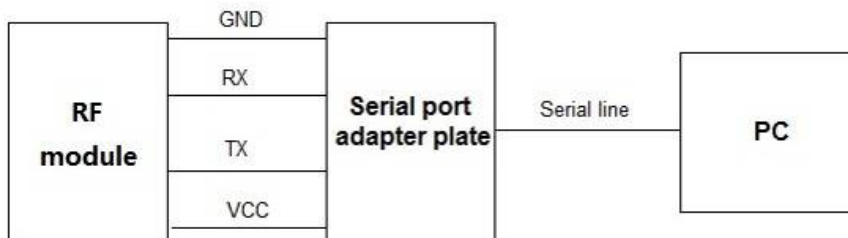

### 5.5 Details of Test Mode

Test Mode	Description of Test Mode
Engineering Mode	Using test software to control EUT working in continuous transmitting and receiving, and select channel and modulation type

## 5.6 Test Location

All tests were performed at:

SGS-CSTC Standards Technical Services (Shanghai) Co., Ltd. E&E Lab  
No.588 West Jindu Road, Songjiang District, Shanghai, China. 201612.

Tel: +86 21 6191 5666

Fax: +86 21 6191 5678

No tests were sub-contracted.

## 5.7 Test Facility

The test facility is recognized, certified, or accredited by the following organizations:

- **CNAS (No. CNAS L0599)**

CNAS has accredited SGS-CSTC Standards Technical Services (Shanghai) Co., Ltd. to ISO/IEC 17025:2005 General Requirements for the Competence of Testing and Calibration Laboratories (CNAS-CL01 Accreditation Criteria for the Competence of Testing and Calibration Laboratories) for the competence in the field of testing. Date of expiry: 2017-07-14.

- **FCC – Registration No.: 402683**

SGS-CSTC Standards Technical Services (Shanghai) Co., Ltd. has been registered and fully described in a report filed with the Federal Communications Commission (FCC). The acceptance letter from the FCC is maintained in our files. Registration No.: 402683, Expiry Date: 2017-09-16.

- **Industry Canada (IC) – IC Assigned Code: 8617A**

The 3m Semi-anechoic chamber of SGS-CSTC Standards Technical Services (Shanghai) Co., Ltd. has been registered by Certification and Engineering Bureau of Industry Canada for radio equipment testing with Registration No.: 8617A-1. Expiry Date: 2017-06-18.

- **VCCI (Member No.: 3061)**

The 3m Semi-anechoic chamber and Shielded Room of SGS-CSTC Standards Technical Services (Shanghai) Co., Ltd. has been registered in accordance with the Regulations for Voluntary Control Measures with Registration No.: R-3868, C-4336, T-2221, G-830 respectively. Date of Expiry: 2017-11-16.

## 5.8 Measurement Uncertainty

No.	Parameter	Measurement Uncertainty
1	Radio Frequency	$< \pm 1 \times 10^{-5}$
2	Total RF power, conducted	$< \pm 1.5$ dB
3	RF power density, conducted	$< \pm 3$ dB
4	Spurious emissions, conducted	$< \pm 3$ dB
5	All emissions, radiated	$< \pm 6$ dB (Below 1GHz) $< \pm 6$ dB (Above 1GHz)
6	Temperature	$< \pm 1^{\circ}\text{C}$
7	Humidity	$< \pm 5$ %
8	DC and low frequency voltages	$< \pm 3$ %

## 6 Equipments List

Item	Test Equipment	Manufacturer	Model No.	Serial No.	Cal. Date	Cal. Due date
1	Power meter	Rohde & Schwarz	NRP	101641	2015-01-22	2016-01-21
2	Power Sensor	Rohde & Schwarz	NRP-Z22	1137.7506.02	2015-08-06	2016-08-05
3	Spectrum Analyzer	Rohde & Schwarz	FSVR	104396	2015-01-22	2016-01-21
4	Spectrum Analyzer	Rohde & Schwarz	FSP-30	2705121009	2015-02-13	2016-02-12
5	EMI test receiver	Rohde & Schwarz	ESU40	100109	2015-02-07	2016-02-06
6	Active Loop Antenna (9kHz to 30MHz)	Rohde & Schwarz	FMZB 1519	1519-034	2015-02-07	2016-02-06
7	Broadband UHF-VHF ANTENNA (25MHz to 2GHz)	SCHWARZBECK	VULB9168	9168-313	2015-08-30	2016-08-29
8	Ultra broadband antenna (25MHz to 3GHz)	Rohde & Schwarz	HL562	100227	2015-02-07	2016-02-06
9	Horn Antenna (1GHz to 18GHz)	Rohde & Schwarz	HF906	100284	2015-02-07	2016-02-06
10	Horn Antenna (1GHz to 18GHz)	SCHWARZBECK	BBHA9120D	9120D-679	2015-02-13	2016-02-12
11	Horn Antenna (14GHz to 40GHz)	SCHWARZBECK	BBHA 9170	BBHA9170373	2015-02-13	2016-02-12
12	Pre-amplifier (9KHz – 2GHz)	LNA6900	TESEQ	71033	2015-01-22	2016-01-21
13	Pre-amplifier (1GHz – 26.5GHz)	Rohde & Schwarz	SCU-F0118- G40-BZ4- CSS(F)	10001	2015-01-22	2016-01-21
14	Pre-amplifier (14GHz – 40GHz)	Rohde & Schwarz	SCU-F1840- G35-BZ3- CSS(F)	10001	2015-01-22	2016-01-21
16	High pass Filter	FSCW	HP 12/2800- 5AA2	19A45-02	2015-09-11	2016-09-10

## 7 Antenna Requirement

### 7.1 E.U.T. test conditions

**Requirements:** 15.31(e) For intentional radiators, measurements of the variation of the input power or the radiated signal level of the fundamental frequency component of the emission, as appropriate, shall be performed with the supply voltage varied between 85% and 115% of the nominal rated supply voltage. For battery operated equipment, the equipment tests shall be performed using a new battery.

<b>Operating Environment:</b>	Temperature:	20.0 -25.0 °C
	Humidity:	35-75 % RH
	Atmospheric Pressure:	99.2 -102 kPa

**Test frequencies:** According to the 15.31(m) Measurements on intentional radiators or receivers, other than TV broadcast receivers, shall be performed and, if required, reported for each band in which the device can be operated with the device operating at the number of frequencies in each band specified in the following table:

Frequency range over which device operates	Number of frequencies	Location in the range of operation
1 MHz or less	1	Middle
1 to 10 MHz	2	1 near top and 1 near bottom
More than 10 MHz	3	1 near top, 1 near middle and 1 near bottom

Pursuant to Part 15.31(c) For swept frequency equipment, measurements shall be made with the frequency sweep stopped at those frequencies chosen for the measurements to be reported.

Test frequency is the lowest channel: 0 channel (2402MHz), middle channel: 19 channel (2440MHz) and highest channel: 39 channel (2480MHz) with fixed at channel.



## 7.2 Antenna Requirement

### Standard requirement:

15.203 requirement:

An intentional radiator shall be designed to ensure that no antenna other than that furnished by the responsible party shall be used with the device. The use of a permanently attached antenna or of an antenna that uses a unique coupling to the intentional radiator, the manufacturer may design the unit so that a broken antenna can be replaced by the user, but the use of a standard antenna jack or electrical connector is prohibited.

15.247(b) (4) requirement:

The conducted output power limit specified in paragraph (b) of this section is based on the use of antennas with directional gains that do not exceed 6 dBi. Except as shown in paragraph (c) of this section, if transmitting antennas of directional gain greater than 6 dBi are used, the conducted output power from the intentional radiator shall be reduced below the stated values in paragraphs (b)(1), (b)(2), and (b)(3) of this section, as appropriate, by the amount in dB that the directional gain of the antenna exceeds 6 dBi.

### EUT Antenna:

The antenna is integral antenna and no consideration of replacement. The gain of the antenna is less than 1.6 dBi.

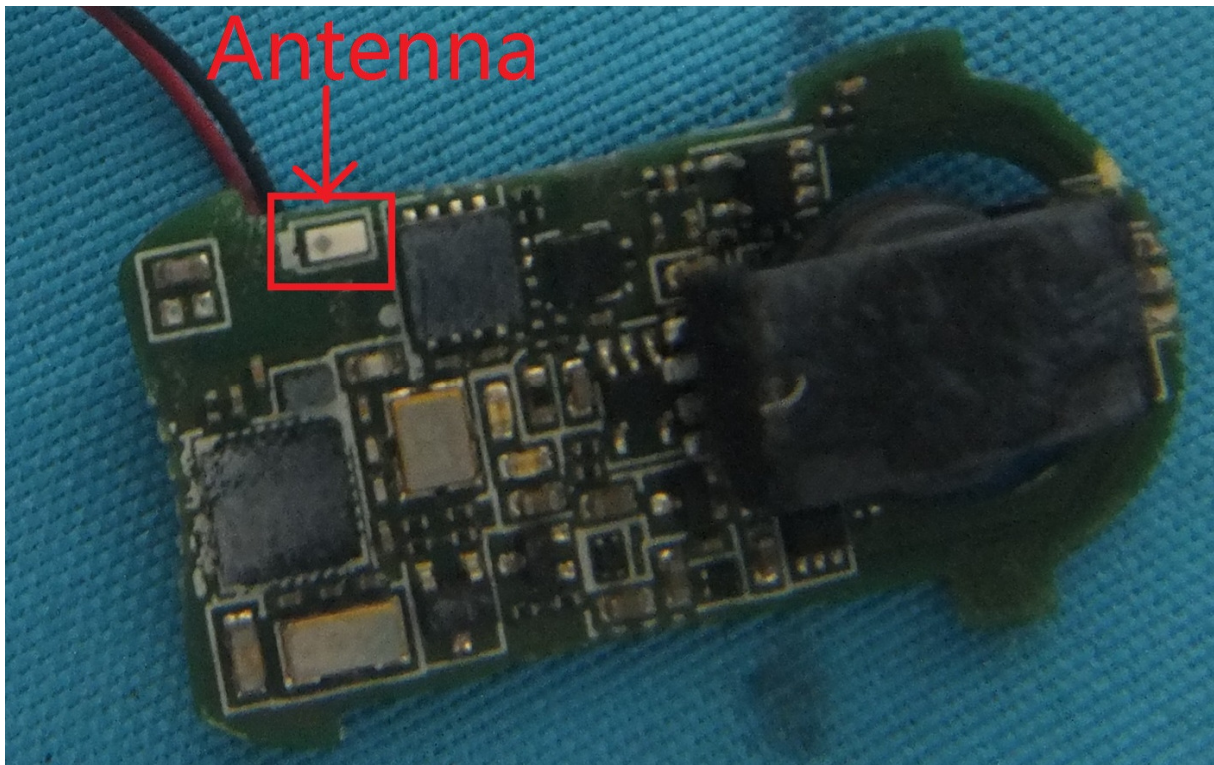

### 7.3 Conducted Emissions on Mains Terminals

**Frequency Range:** 150 KHz to 30 MHz

**Limit:**

Frequency range MHz	Class B Limits: dB (µV)	
	Quasi-peak	Average
0.15 to 0.50	66 to 56	56 to 46
0.50 to 5	56	46
5 to 30	60	50

Note1: The limit decreases linearly with the logarithm of the frequency in the range 0.15 MHz to 0.50MHz.

Note2: The lower limit is applicable at the transition frequency.

#### Test Setup:

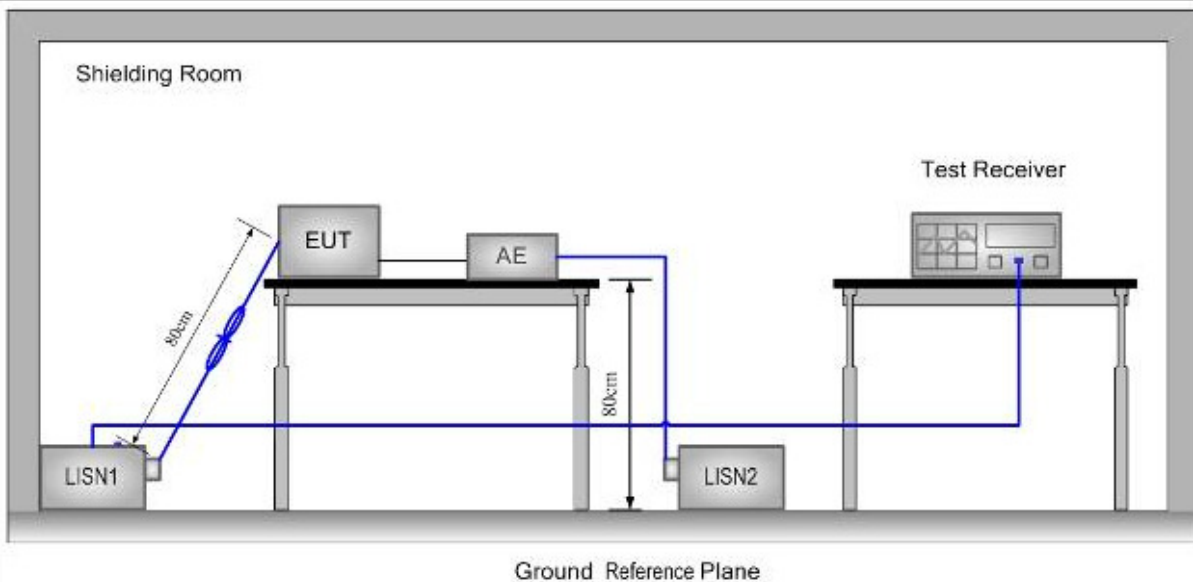

#### Test Procedure:

- 1) The mains terminal disturbance voltage was measured with the EUT in a shielded room.
- 2) The EUT was connected to AC power source through a LISN 1 (Line Impedance Stabilization Network) which provides  $50\Omega/50\mu\text{H} + 5\Omega$  linear impedance. The power cables of all other units of the EUT were connected to a second LISN, which was bonded to the ground reference plane in the same way as the LISN for the unit being measured. A multiple socket outlet strip was used to connect multiple power cables to a single LISN provided the rating of the LISN was not exceeded.
- 3) The tabletop EUT was placed upon a non-metallic table 0.8m above the ground reference plane. And for floor-standing arrangement, the EUT was placed on the horizontal ground reference plane, but separated from metallic contact with the ground reference plane by 0.1m of insulation.
- 4) The test was performed with a vertical ground reference plane. The rear of the EUT shall be 0.4 m from the vertical ground reference plane. The vertical ground reference plane was bonded to the horizontal ground reference plane. The LISN was placed 0.8 m from the boundary of the unit under test and bonded to a ground reference plane for LISN mounted on top of the ground reference plane. This distance was between the closest points of the LISN and the EUT. The mains lead of EUT excess 0.8m was folded back and forth parallel to the lead so as to form a horizontal bundle with a length between 0.3m and 0.4m. All other units of the EUT and associated equipment were at least 0.8 m from the LISN.

Remark: Pre-scan was performed with peak detected on all ports, Quasi-peak & average measurements were performed at the frequencies at which maximum peak emission level were detected. Pretest under all modes; choose the worst case mode (in Middle channel) record on the report. Please see the attached Quasi-peak and Average test results.

**Test Result:** N/A

**Test Data :**

N/A: This EUT in working mode is powered by battery only; therefore the AC Conducted Emission test is not applicable

**7.4 6dB Occupied Bandwidth**

**Test Configuration:**

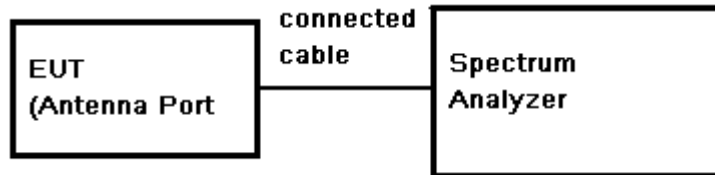

**Test Procedure:**

- 1). Place the EUT on the table and set it in transmitting mode.
- 2). Remove the antenna from the EUT and then connect a low loss RF cable from the antenna port to the spectrum analyzer.
- 3). Set the spectrum analyzer as RBW=100KHz, VBW≥3\* RBW, Span=3MHz, Sweep=auto
- 4). Mark the peak frequency and -6dB (upper and lower) frequency.
- 5). Repeat above procedures until all frequency measured was complete.

**Limit:** ≥ 500 kHz

**Test date:**

Test Channel	Test Frequency (MHz)	6dB Bandwidth (MHz)	Limit (KHz)	Test Result
Lowest	2402	705	500	Pass
Middle	2440	702	500	Pass
Highest	2480	708	500	Pass

**Test plot as follows:**

Test channel: Lowest

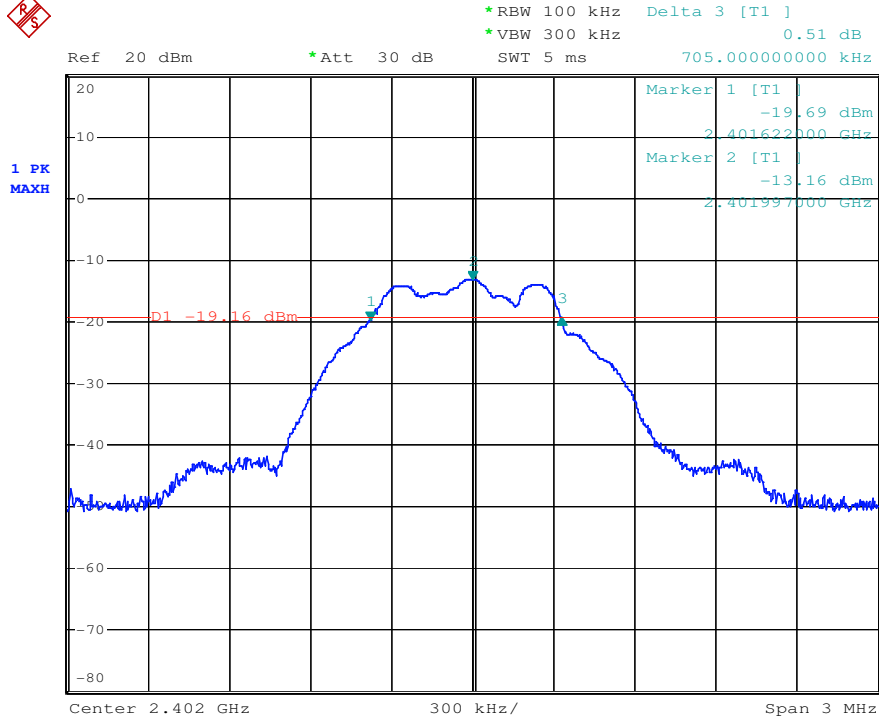

Test channel: Middle

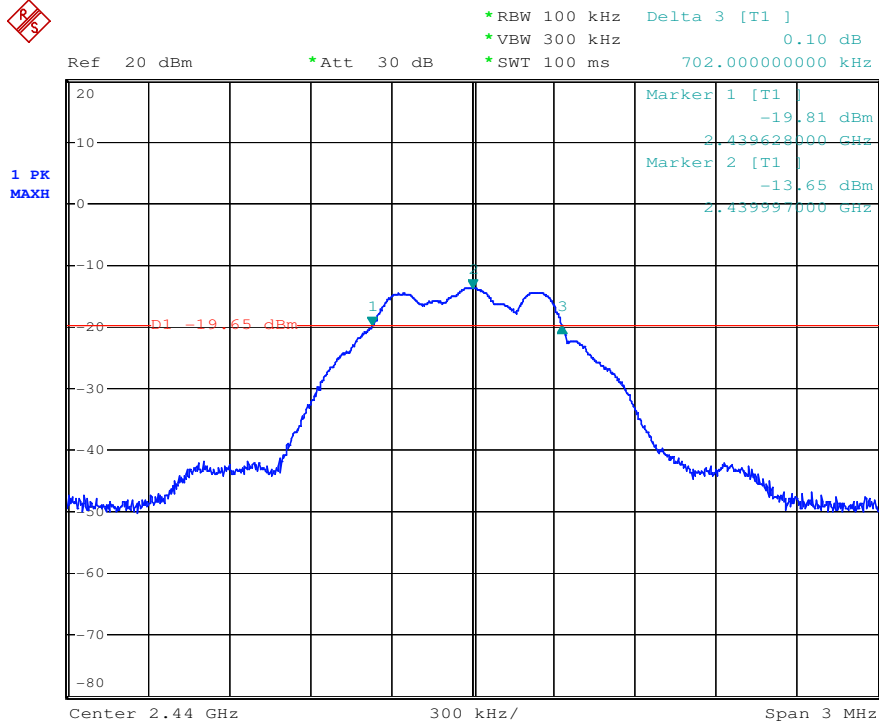

Test channel: Highest



\*RBW 100 kHz Delta 3 [T1 ]  
 \*VBW 300 kHz -0.65 dB  
 \*SWT 100 ms 708.000000000 kHz

Ref 20 dBm \*Att 30 dB

1 PK  
MAXH

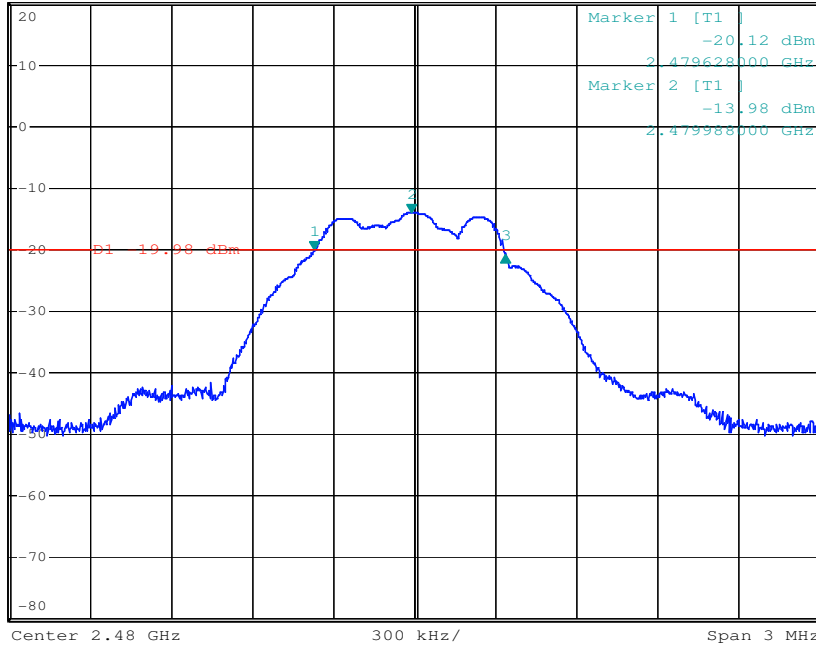

## 7.5 Conducted Peak Output Power

**Test Configuration:**

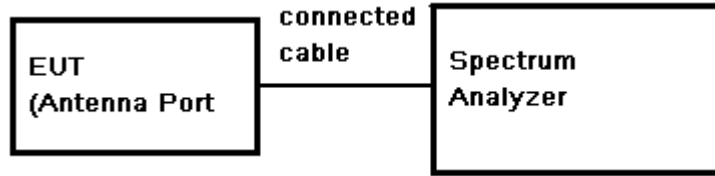

**Test Procedure:**

- 1) Place the EUT on the table and set it in transmitting mode.
- 2) Remove the antenna from the EUT and then connect a low loss RF cable from the antenna port to the spectrum.
- 3) Set the spectrum analyzer: RBW = 3 MHz, VBW = 10 MHz, Span= fully encompass the bandwidth, Sweep = auto; Detector Function = Peak Trace mode=max hold
- 4) Use the peak marker function to determine the maximum amplitude level within the RBW.
- 5) Record the max. Power reading.
- 6) Repeat above procedures until all the frequency measured were complete.

**Test Limit:** 30dBm

**Test data:**

Test Channel	Test Frequency (MHz)	Reading Power (dBm)	Cable Loss (dB)	Output Power (dBm)	Limit (dBm)	Test Result
Lowest	2402	-12.93	0.5	-12.43	30	Pass
Middle	2440	-13.45	0.5	-12.95	30	Pass
Highest	2480	-13.79	0.5	-13.29	30	Pass

$$\text{Output Power} = \text{Reading Power} + \text{Cable Loss}$$

Test plot as follows:

Test channel: Lowest

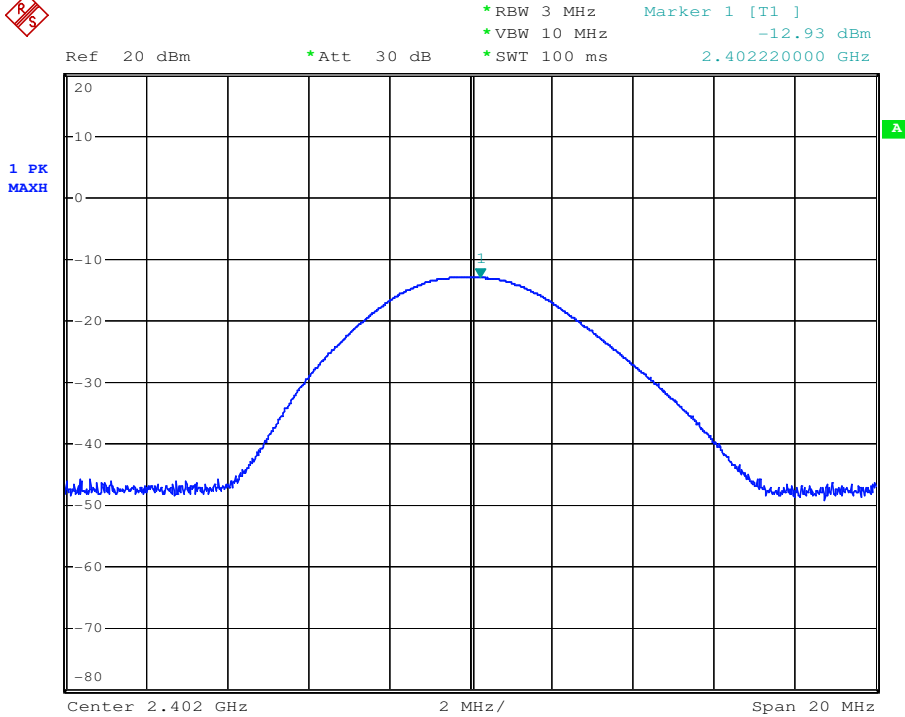

Test channel: Middle

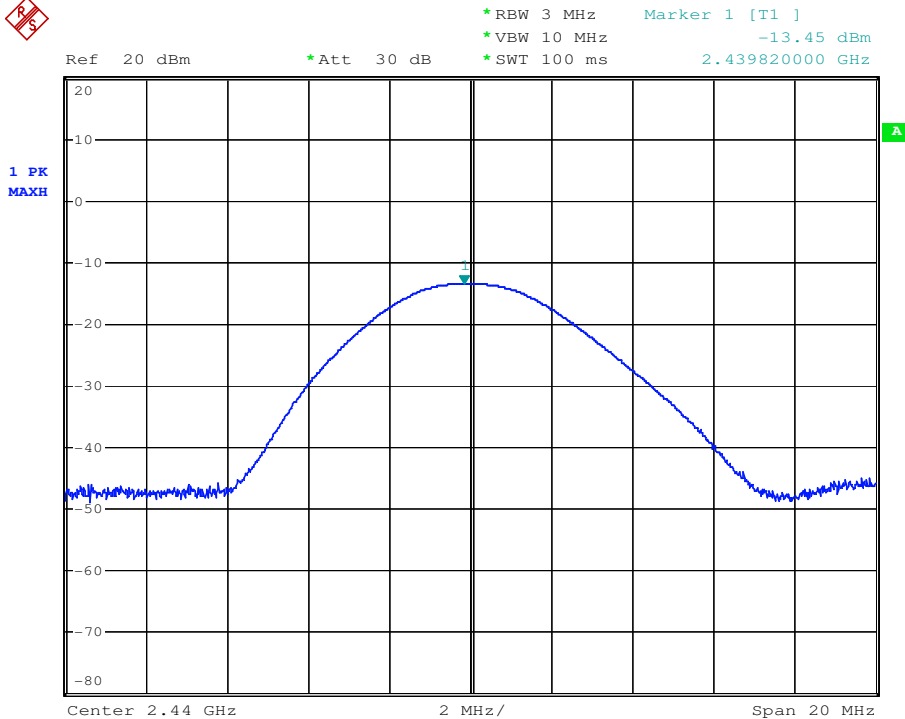

Test channel: Highest



\*RBW 3 MHz      Marker 1 [T1 ]  
\*VBW 10 MHz      -13.79 dBm  
\*SWT 100 ms      2.479580000 GHz

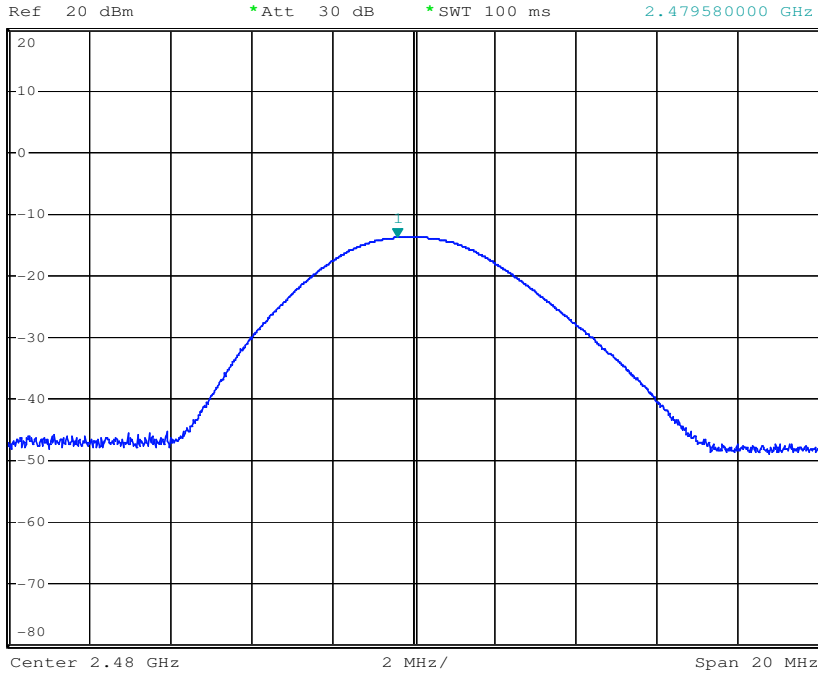



## 7.6 Peak Power Spectral Density

**Test Configuration:**

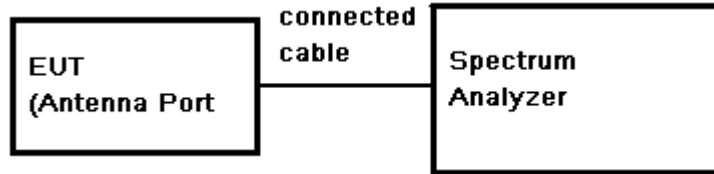

**Test Procedure:**

- 1) Remove the antenna from the EUT and then connect a low RF cable from the antenna port to the spectrum.
- 2) Set the spectrum analyzer: Center Frequency= Channel Frequency, RBW = 3 kHz VBW = 10 kHz. Span= 1.5 times the DTS bandwidth, Sweep = auto; Detector = Peak; Trace mode=max hold, Trace=Max hold.
- 3) Use the peak marker function to determine the maximum amplitude level within the RBW.
- 4) Record the marker level for the particular mode.
- 5) Repeat these steps for other channel and modes.

**Test Limit:**

8dBm/3kHz

**Test data:**

Test Channel	Test Frequency (MHz)	Reading (dBm/3KHz)	Cable Loss (dB)	PSD (dBm/3KHz)	Limit (dBm/3KHz)	Test Result
Lowest	2402	-26.08	0.5	-25.58	8	Pass
Middle	2440	-26.49	0.5	-25.99	8	Pass
Highest	2480	-27.01	0.5	-27.51	8	Pass

RF Power Density = Reading Power + Cable Loss

**Test plot as follows:**

Test channel: Lowest

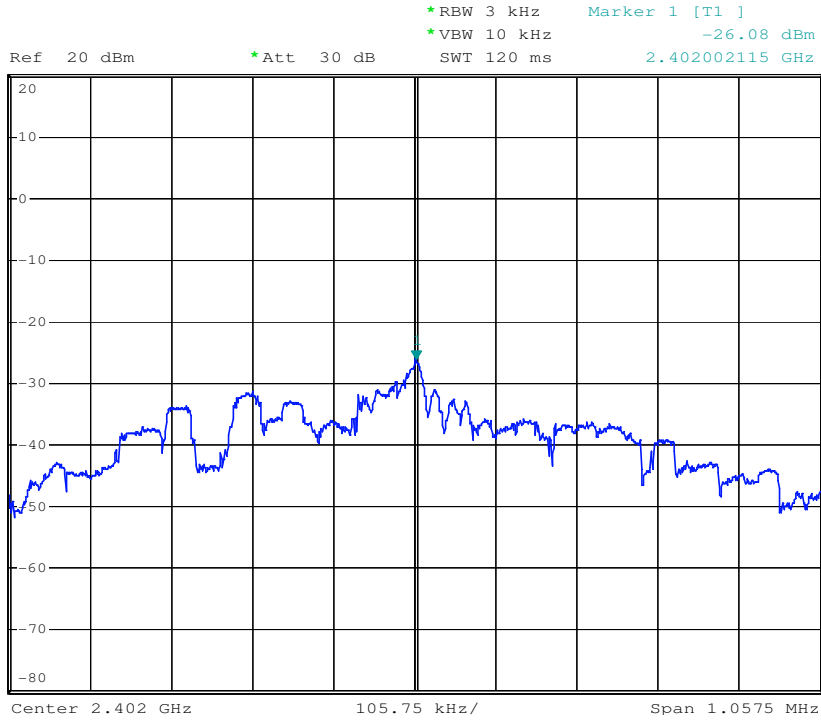

Test channel: Middle

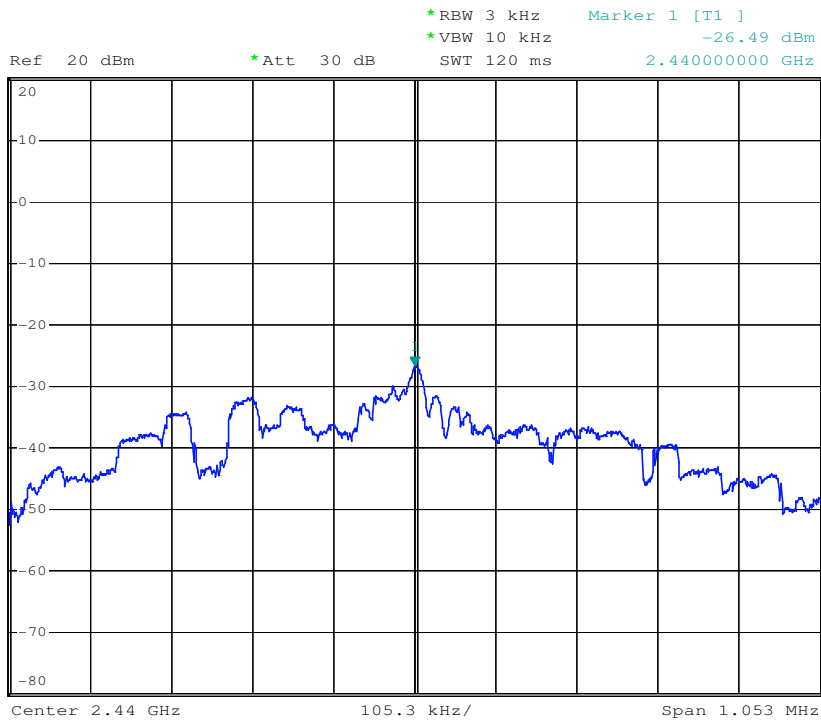

Test channel: Highest



\*RBW 3 kHz      Marker 1 [T1 ]  
\*VBW 10 kHz      -27.01 dBm  
SWT 120 ms      2.480003186 GHz

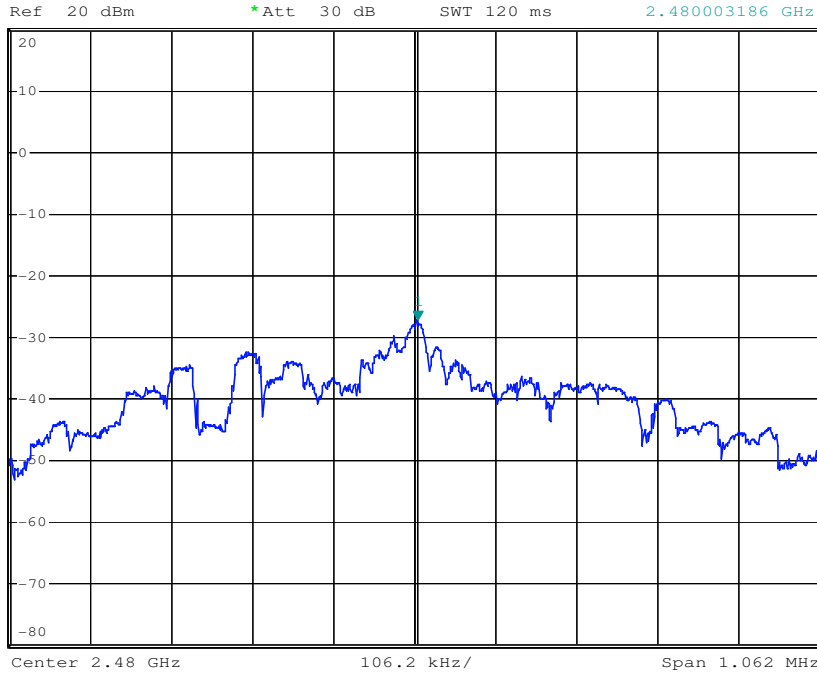

## 7.7 Conducted Spurious Emissions and Band edge

**Test Configuration:**

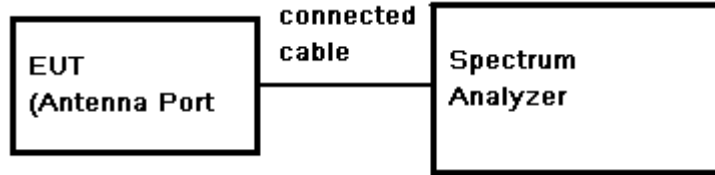

**Test Procedure:**

- 1) Remove the antenna from the EUT and then connect a low RF cable from the antenna port to the spectrum.
- 2) Set the spectrum analyzer: RBW = 100 KHz. VBW = 300 KHz. Sweep = auto; Detector Function = Peak (Max. hold).
- 3) Measurement were investigated while operating in MIMO mode, however, it was determined that single antenna operation produced the worst emissions. Since the data of MIMO mode are not report.

**Limit:**

(d) In any 100 kHz bandwidth outside the frequency band in which the spread spectrum or digitally modulated intentional radiator is operating, the radio frequency power that is produced by the intentional radiator shall be at least 20 dB below that in the 100 kHz bandwidth within the band that contains the Highest level of the desired power, based on either an RF conducted or a radiated measurement, provided the transmitter demonstrates compliance with the peak conducted power limits.

### 7.7.1 Conducted Spurious Emissions

Test plot as follows:

Test channel: Lowest

30MHz-3GHz:

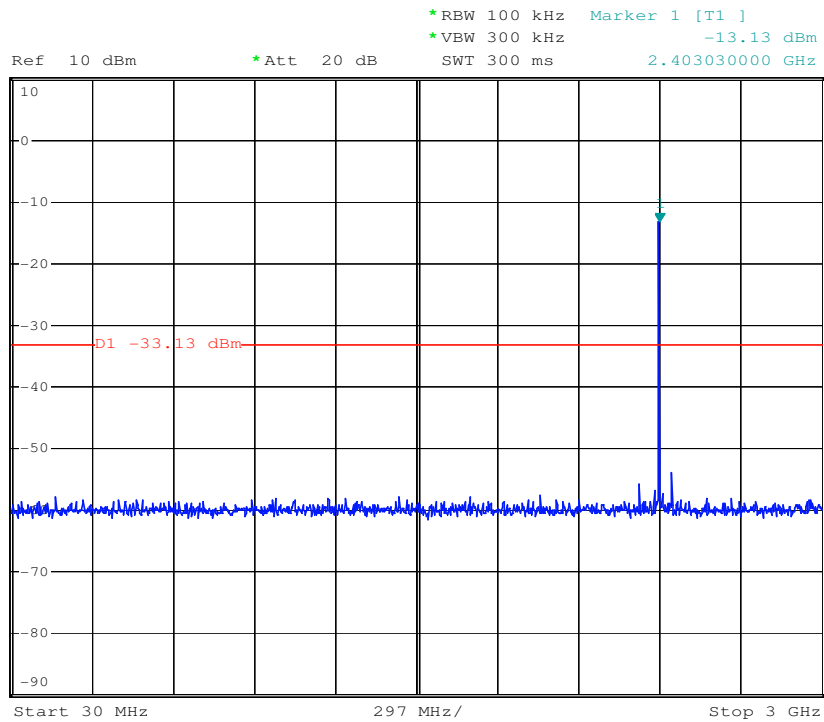

3GHz-25GHz:

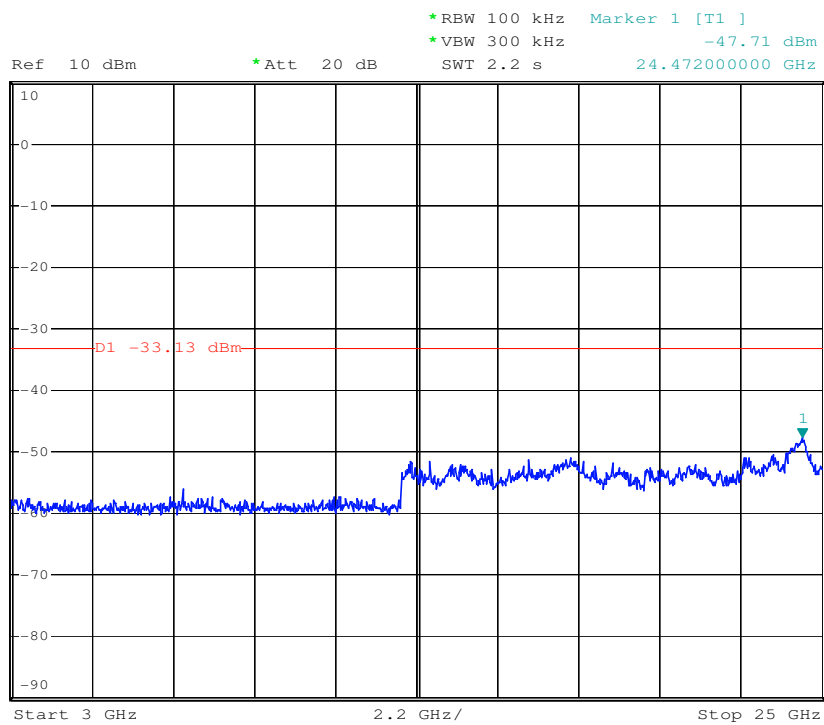

Test channel: Middle

30MHz-3GHz:

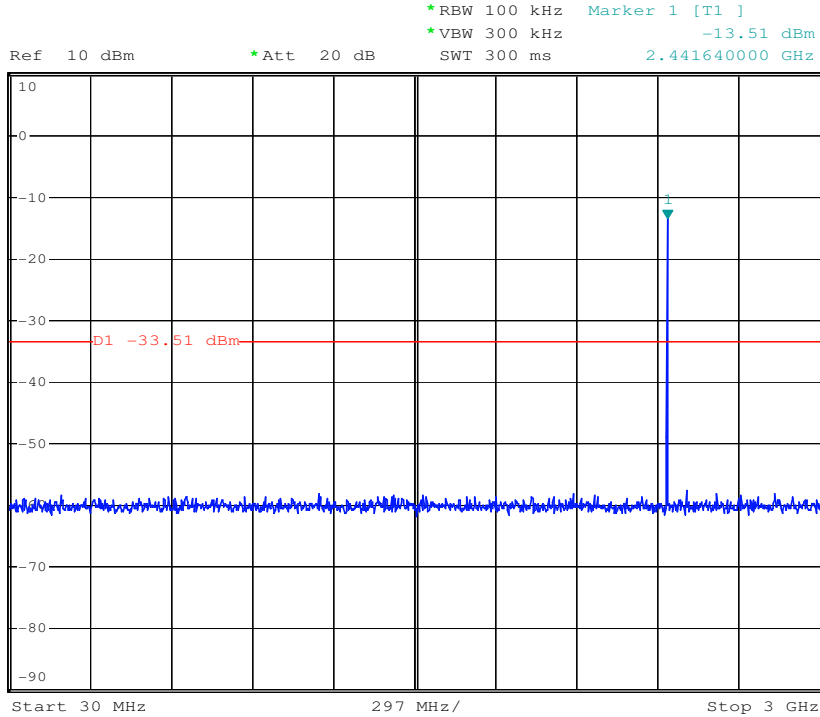

3GHz-25GHz:

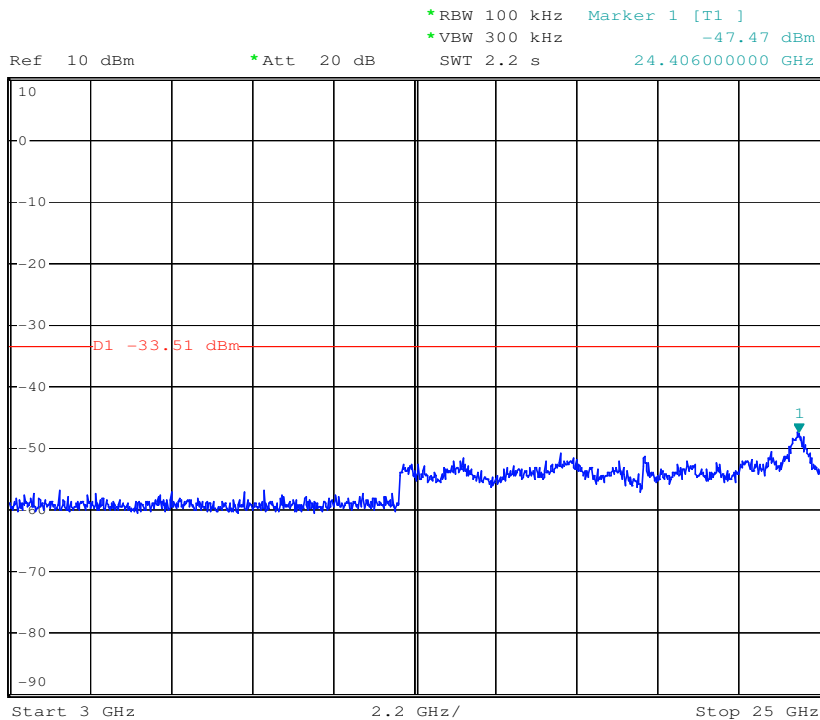

Test channel: Highest

30MHz-3GHz:

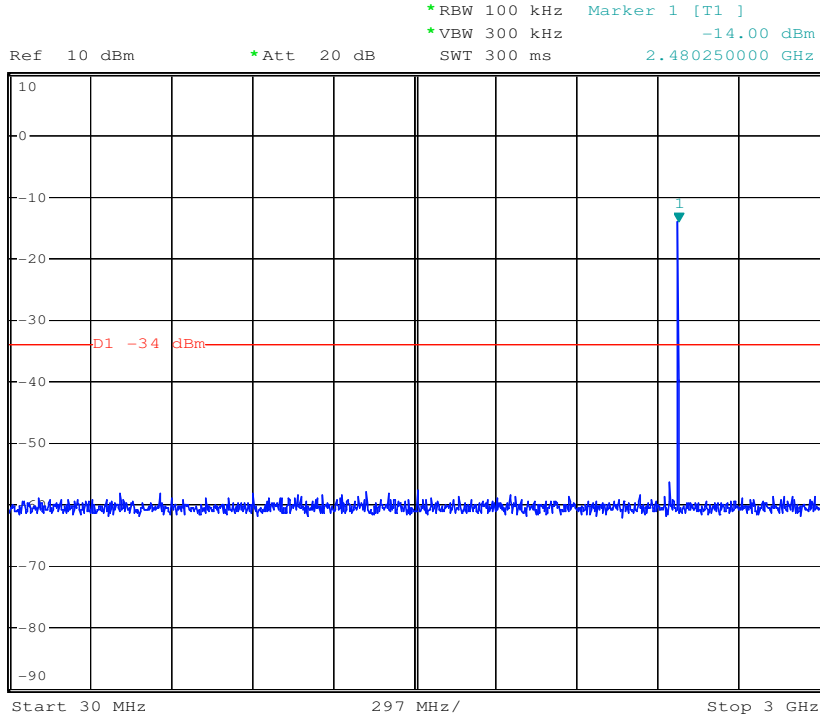

3GHz-25GHz:

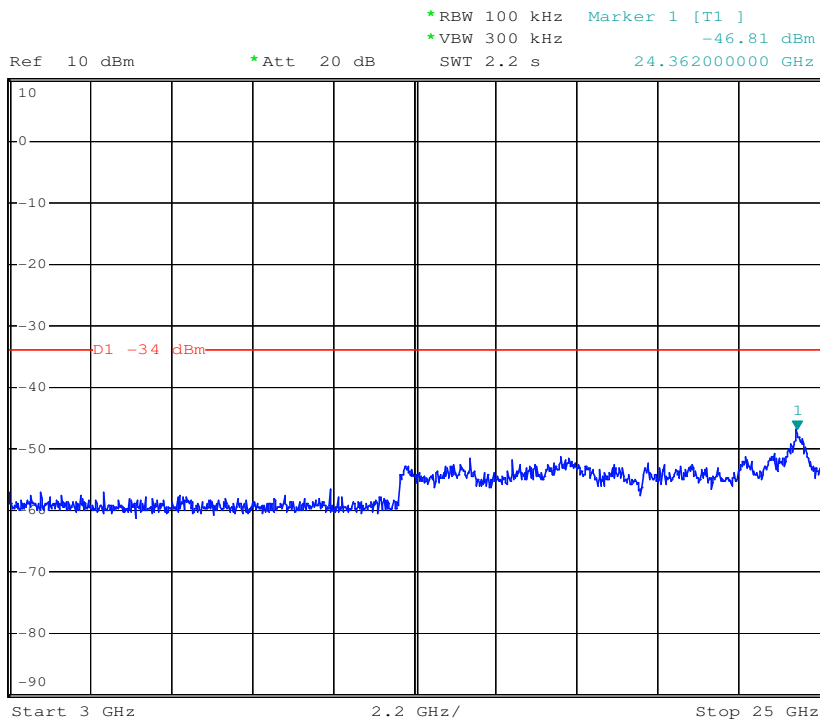

**7.7.2 Conducted Band-edge**  
Test plot as follows:

Test channel: Lowest

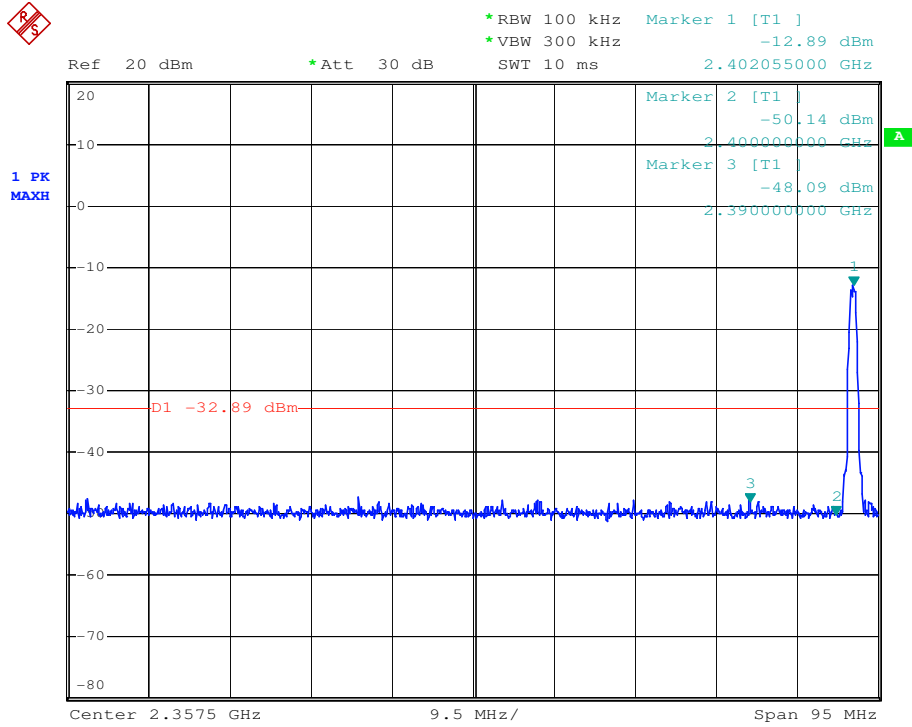

Test channel: Highest

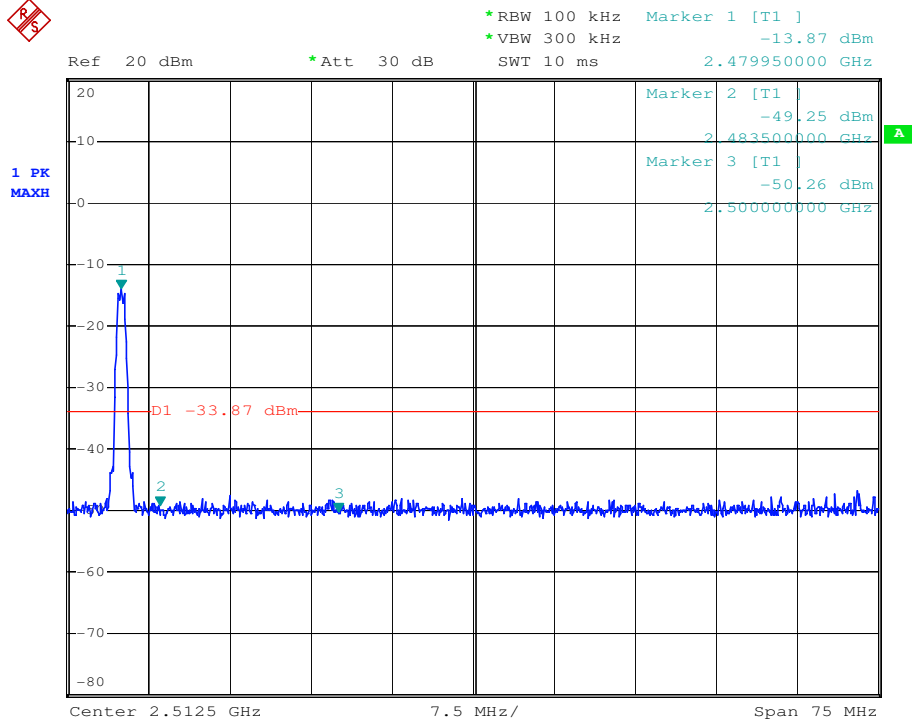



## 7.8 Radiated Spurious Emissions and Band-edge

**Frequency Range:** 9KHz to 25GHz

**Test site/setup:** Measurement Distance: 3m (Semi-Anechoic Chamber)  
Test instrumentation set-up:

Frequency Range	Detector	RBW	VBW
0.009MHz-0.090MHz	Peak	10kHz	30kHz
0.009MHz-0.090MHz	Average	10kHz	30kHz
0.090MHz-0.110MHz	Quasi-peak	10kHz	30kHz
0.110MHz-0.490MHz	Peak	10kHz	30kHz
0.110MHz-0.490MHz	Average	10kHz	30kHz
0.490MHz -30MHz	Quasi-peak	10kHz	30kHz
30MHz-1GHz	Quasi-peak	100kHz	300kHz
Above 1GHz	Peak	RBW=1MHz	VBW≥RBW
	Average		VBW=10Hz

Sweep=Auto

**15.209 Limit:**

Frequency	Limit (dBuV/m)
0.009MHz-0.490MHz	128.5 ~ 93.8
0.490MHz-1.705MHz	73.8 ~63.0
1.705MHz-30MHz	69.5
30MHz-88MHz	40.0
88MHz-216MHz	43.5
216MHz-960MHz	46.0
960MHz-1GHz	54.0
Above 1GHz	54.0

Note: 15.35(b), Unless otherwise specified, the limit on peak radio frequency emissions is 20dB above the maximum permitted average emission limit applicable to the equipment under test. This peak limit applies to the total peak emission level radiated by the device.

**Test Configuration:** Receive antenna scan height 1 m - 4 m. polarization Vertical / Horizontal

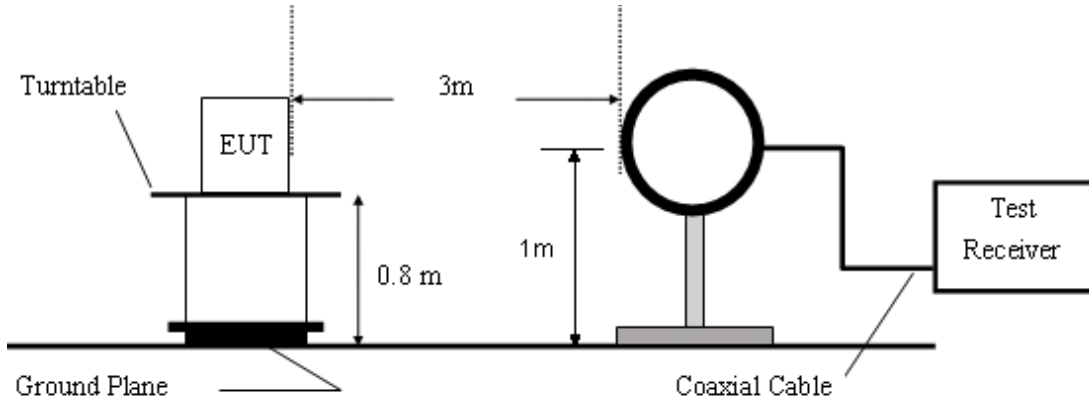

**Figure1. Below 30MHz radiated emissions test configuration**

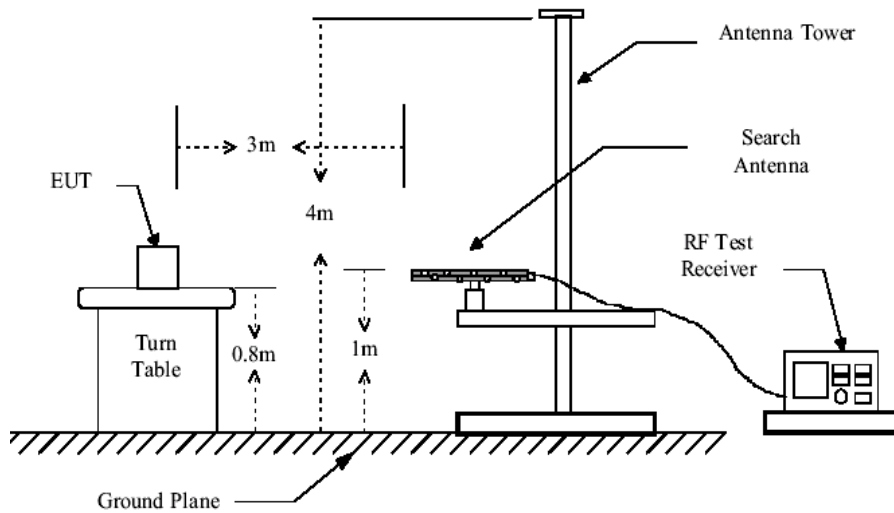

**Figure 2. 30MHz to 1GHz radiated emissions test configuration**

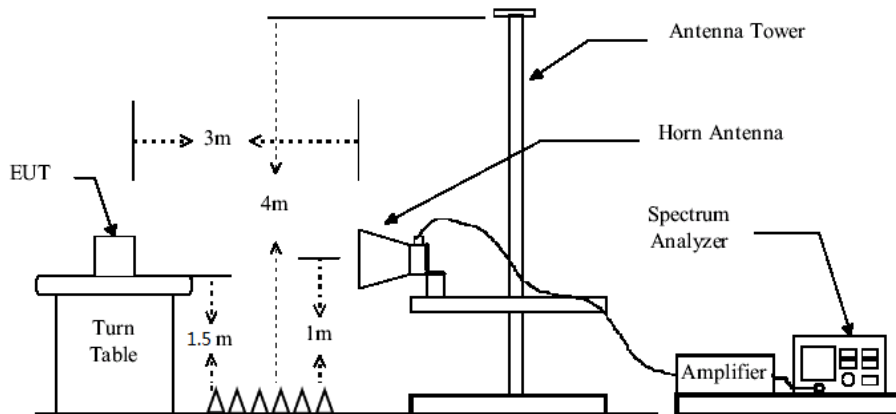

**Figure 3. Above 1GHz radiated emissions test configuration**

- Test Procedure:**
- 1) The procedure used was ANSI Standard C63.10. The receiver was scanned from 9 KHz to 25GHz. When an emission was found, the table was rotated to produce the maximum signal strength. An initial pre-scan was performed for in peak detection mode using the receiver. The EUT was measured for both the Horizontal and Vertical polarities and performed a pre-test three orthogonal planes. For intentional radiators, measurements of the variation of the input power or the radiated signal level of the fundamental frequency component of the emission, as appropriate, shall be performed with the supply voltage varied between 85% and 115% of the nominal rated supply voltage. The worst case emissions were reported.
  - 2) Low noise amplifier was used below 1GHz, High pass Filter was used above 3GHz. We did not use any amplifier or filter between 1G and 3GHz.
  - 3) Test were performed for their spatial orthogonal(X, Y, Z), the worst test data (X orthogonal) was submitted.
    - a) For this intentional radiator operates below 25 GHz. the spectrum shall be investigated to the tenth harmonic of the highest fundamental frequency. And above the third harmonic of this intentional radiator, the disturbance is very low. So the test result only displays to 5rd harmonic.
    - b) As shown in Section, for frequencies above 1000MHz. the above field strength limits are based on average limits. However, the peak field strength of any emission shall not exceed the maximum permitted average limits specified above by more than 20 dB under any condition of modulation.
  - 4) No spurious emissions were detected within 20dB of limit below 30MHz.

**Test Result:** Pass

### 7.8.1 Radiated Spurious Emissions

#### 30MHz-1GHz:

Item	Freq.	Read Level	Antenna Factor	Preamp Factor	Cable Loss	Result Level	Limit Line	Over Limit	Detector	Polarization
(Mark)	(MHz)	(dBμV)	(dB/m)	(dB)	(dB)	(dBμV/m)	(dBμV/m)	(dB)		
1	85.03	33.43	8.60	24.60	1.02	18.45	40.00	-21.55	QP	Horizontal
2	99.87	38.94	9.19	24.60	1.10	24.63	43.50	-18.87	QP	Horizontal
3	103.42	34.13	9.78	24.60	1.10	20.41	43.50	-23.09	QP	Horizontal
4	807.95	22.17	23.58	23.99	3.65	25.41	46.00	-20.59	QP	Horizontal
5	939.01	22.38	23.40	23.91	3.96	25.83	46.00	-20.17	QP	Horizontal
6	1000.00	21.61	24.10	23.70	4.20	26.21	54.00	-27.79	QP	Horizontal
1	88.58	31.18	8.74	24.60	1.04	16.36	43.50	-27.14	QP	Vertical
2	118.78	28.14	11.69	24.59	1.21	16.45	43.50	-27.05	QP	Vertical
3	737.95	22.94	21.56	24.03	3.47	23.94	46.00	-22.06	QP	Vertical
4	857.53	21.85	23.43	23.96	3.77	25.09	46.00	-20.91	QP	Vertical
5	894.23	24.76	22.71	23.94	3.86	27.39	46.00	-18.61	QP	Vertical
6	993.01	21.31	24.38	23.73	4.17	26.13	54.00	-27.87	QP	Vertical

Result Level = Read Level + Antenna Factor + Cable loss - Preamp Factor

**Test plot as follows:**

Vertical:

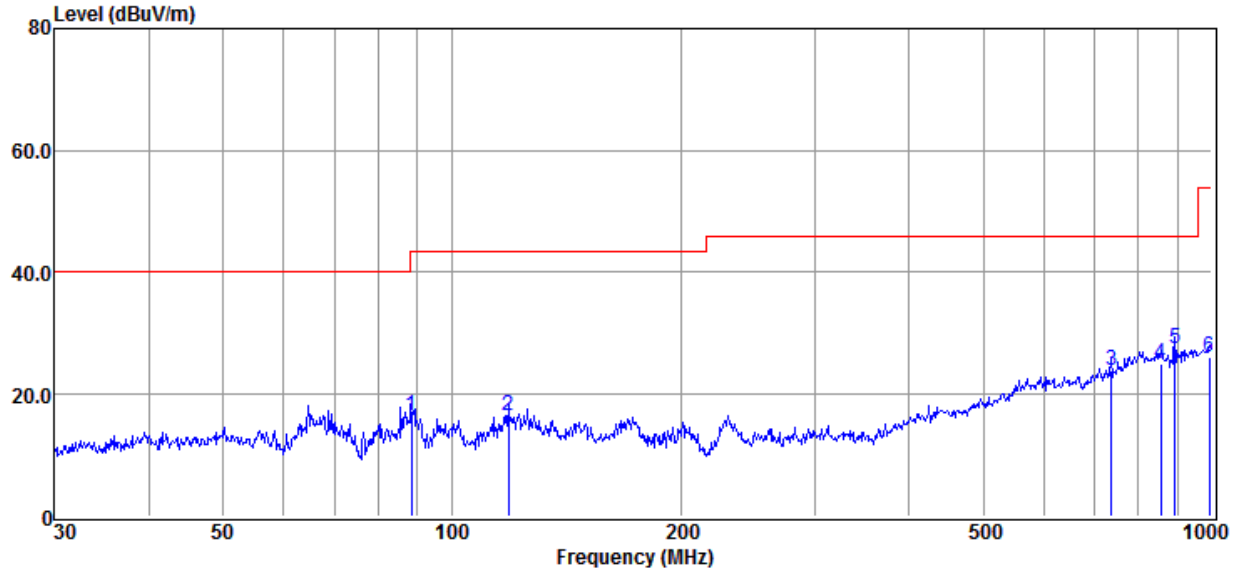

Horizontal:

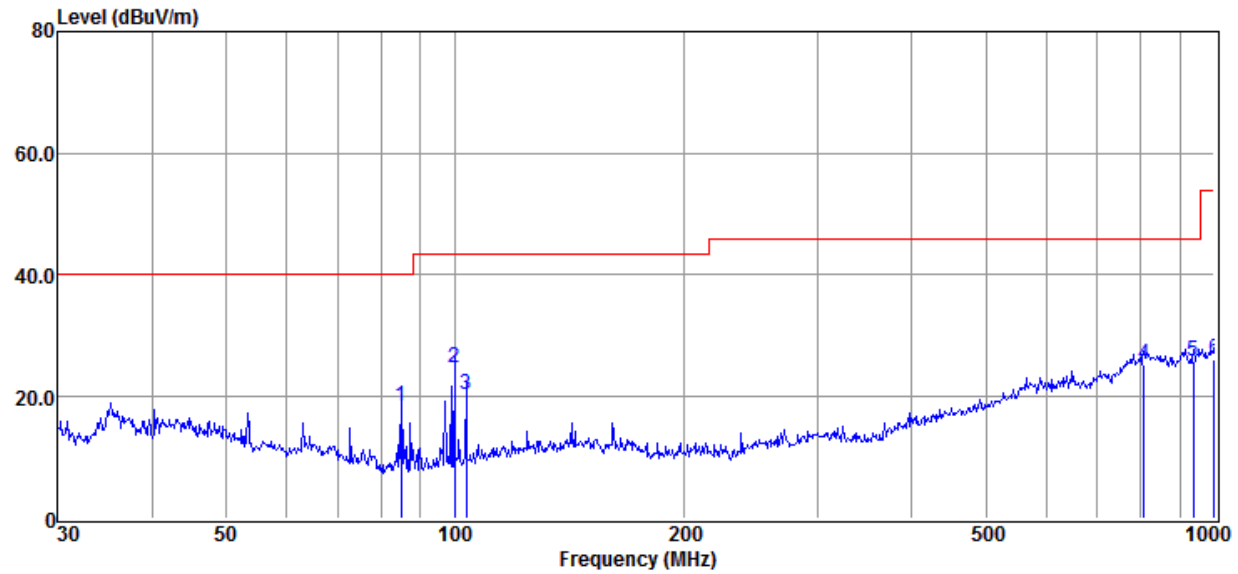

**Above 1GHz:**

**Lowest Channel(2402MHz)**

Mark	Frequency (MHz)	Reading (dBuV)	Factor (dB)	Emission (dBuV/m)	Limit (dBuV/m)	Over Limit (dB)	Detector	polarization
1	4804	44.34	6.18	50.52	54	-3.48	peak	Horizontal
2	7206	39.44	10.63	50.07	54	-3.93	peak	Horizontal
3	9608	35.52	14.38	49.9	54	-4.10	peak	Horizontal
4	4804	41.53	6.18	47.71	54	-6.29	peak	Vertical
5	7206	39.78	10.63	50.41	54	-3.59	peak	Vertical
6	9608	37.28	14.38	51.66	54	-2.34	peak	Vertical

**Middle Channel(2440MHz)**

Mark	Frequency (MHz)	Reading (dBuV)	Factor (dB)	Emission (dBuV/m)	Limit (dBuV/m)	Over Limit (dB)	Detector	polarization
1	4880	39.49	6.97	46.46	54	-7.54	peak	Horizontal
2	7320	39.78	11.12	50.9	54	-3.10	peak	Horizontal
3	9760	37.4	14.35	51.75	54	-2.25	peak	Horizontal
4	4880	37.95	6.97	44.92	54	-9.08	peak	Vertical
5	7320	39.03	11.12	50.15	54	-3.85	peak	Vertical
6	9760	37.15	14.35	51.5	54	-2.5	peak	Vertical

**Highest Channel(2480MHz)**

Mark	Frequency (MHz)	Reading (dBuV)	Factor (dB)	Emission (dBuV/m)	Limit (dBuV/m)	Over Limit (dB)	Detector	polarization
1	4960	40.26	7.49	47.75	54	-6.25	peak	Horizontal
2	7440	40.24	11.65	51.89	54	-2.11	peak	Horizontal
3	9920	37.68	14.4	52.08	54	-1.92	peak	Horizontal
4	4960	40.4	7.49	47.89	54	-6.11	peak	Vertical
5	7440	40.77	11.65	52.42	54	-1.58	peak	Vertical
6	9920	38.5	14.4	52.9	54	-1.10	peak	Vertical

Remark: 1) Emission = Receiver Reading + Factor

2) Factor = Antenna Factor + Cable Loss + Pre-amplifier Factor.

3) If the Peak value below the AV Limit, the AV test doesn't perform for this submission.

**7.8.2 Radiated Band-edge  
Lowest Channel (2402MHz)**

MK.	Frequency (MHz)	Reading (dBuV/m)	Corrected factor(dB)	Result (dBuV/m)	Limit (dBuV/m)	Over Limit (dB)	Detector	Polarization
1	2384.2	47.87	-3.88	43.99	54	-10.01	Peak	Horizontal
2	2390	44.61	-3.89	40.72	54	-13.28	Peak	Horizontal
3	2402.1	83.58	-3.92	79.66	54	25.66	Peak	Horizontal
1	2328.4	46.74	-3.71	43.03	54	-10.97	Peak	Vertical
2	2390	44.1	-3.89	40.21	54	-13.79	Peak	Vertical
3	2401.8	81.76	-3.91	77.85	54	23.85	Peak	Vertical

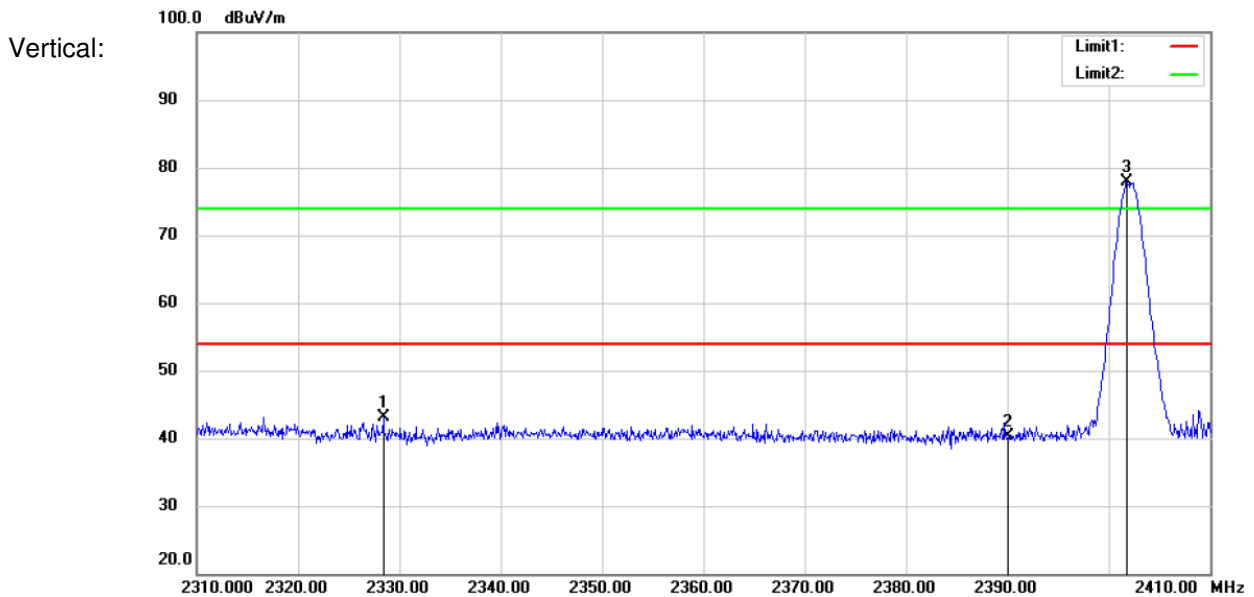
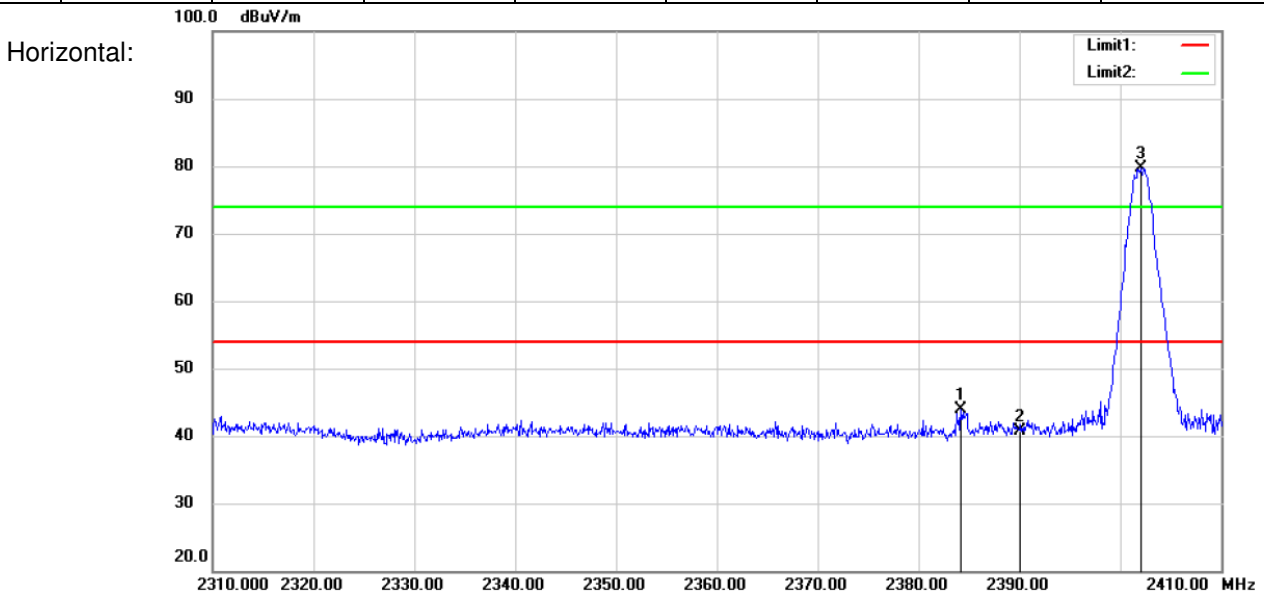

**Highest Channel (2480MHz)**

MK.	Frequency (MHz)	Reading (dBuV/m)	Corrected factor(dB)	Result (dBuV/m)	Limit (dBuV/m)	Over Limit (dB)	Detector	Polarization
1	2480.1	83.06	-4	79.06	54	25.06	Peak	Horizontal
2	2483.5	47.91	-4.01	43.90	54	-10.10	Peak	Horizontal
3	2507.85	48.38	-3.94	44.44	54	-9.56	Peak	Horizontal
1	2479.95	80.75	-4	76.75	54	22.75	Peak	Vertical
2	2483.5	47.52	-4.01	43.51	54	-10.49	Peak	Vertical
3	2548.425	46.08	-3.49	42.59	54	-11.41	Peak	Vertical

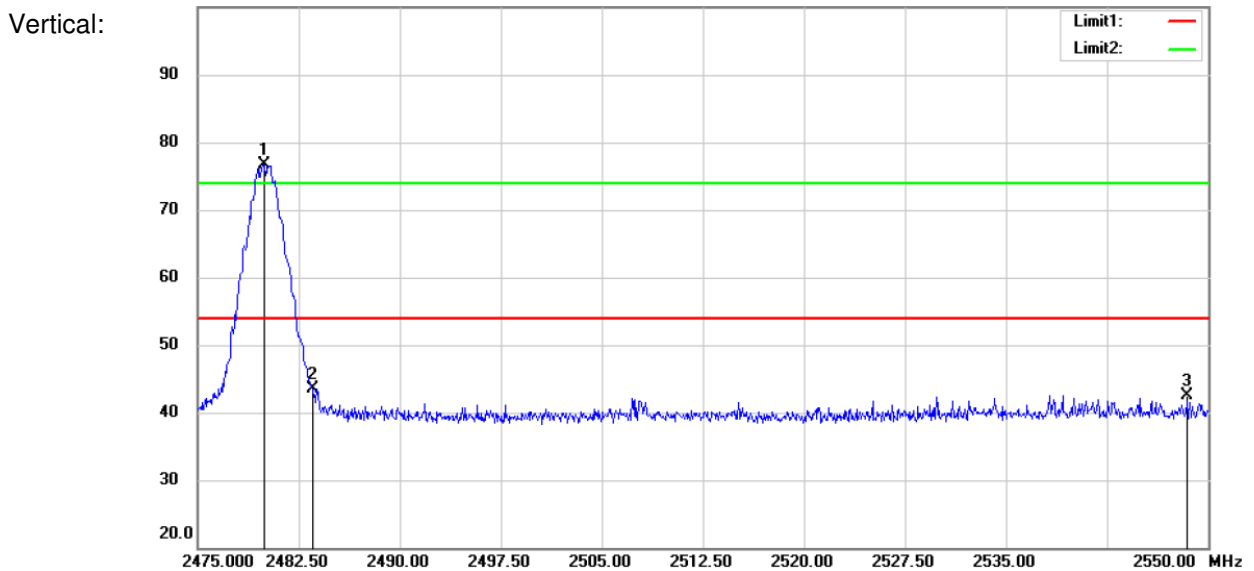
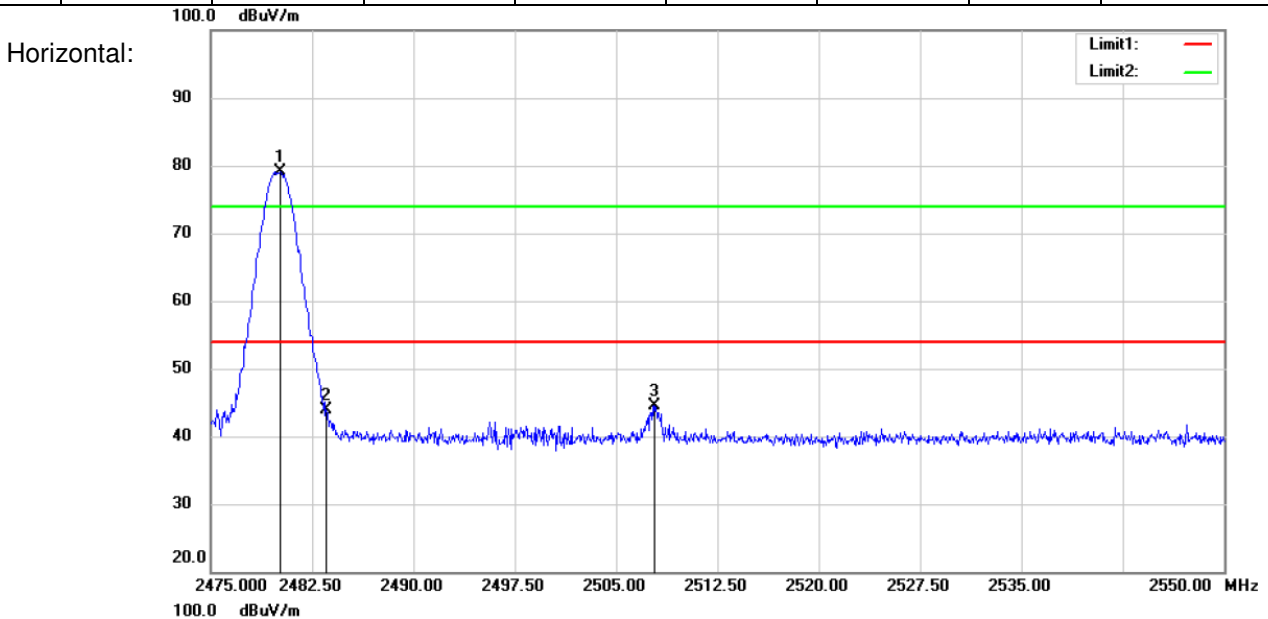





- Remark: 1). Test Level = Receiver Reading + Antenna Factor + Cable Loss- Preamplifier Factor  
2). If the Peak value below the AV Limit, the AV test doesn't perform for this submission.

All frequencies within the "Restricted bands" have been evaluated to compliance. Except as shown in paragraph of this section, only spurious emissions are permitted in any of the frequency bands listed below:

FCC Part 15, Subpart C Section 15.205 Restricted bands of operation.

MHz	MHz	MHz	GHz
0.090 - 0.110	16.42 - 16.423	399.9 - 410	4.5 - 5.15
<sup>1</sup> 0.495 - 0.505	16.69475 - 16.69525	608 - 614	5.35 - 5.46
2.1735 - 2.1905	16.80425 - 16.80475	960 - 1240	7.25 - 7.75
4.125 - 4.128	25.5 - 25.67	1300 - 1427	8.025 - 8.5
4.17725 - 4.17775	37.5 - 38.25	1435 - 1626.5	9.0 - 9.2
4.20725 - 4.20775	73 - 74.6	1645.5 - 1646.5	9.3 - 9.5
6.215 - 6.218	74.8 - 75.2	1660 - 1710	10.5 - 12.7
6.26775 - 6.26825	108 - 121.94	1718.8 - 1722.2	13.25 - 13.4
6.31175 - 6.31225	123 - 138	2200 - 2300	14.47 - 14.5
8.291 - 8.294	149.9 - 150.05	2310 - 2390	15.35 - 16.2
8.362 - 8.366	156.52475 - 156.52525	2483.5 - 2500	17.7 - 21.4
8.37625 - 8.38675	156.7 - 156.9	2655 - 2900	22.01 - 23.12
8.41425 - 8.41475	162.0125 - 167.17	3260 - 3267	23.6 - 24.0
12.29 - 12.293	167.72 - 173.2	3332 - 3339	31.2 - 31.8
12.51975 - 12.52025	240 - 285	3345.8 - 3358	36.43 - 36.5
12.57675 - 12.57725	322 - 335.4	3600 - 4400	
13.36 - 13.41			



## **8 Test Setup Photographs**

Refer to the < MD-TY-015 \_Test Setup photos-FCC>.

## **9 EUT Constructional Details**

Refer to the < MD- TY-015 \_External Photos > & < MD- TY-015\_Internal Photos >.

**--End of the Report--**