



## FCC PART 90

## TEST REPORT

For

### Fujian BelFone Communications Technology Co., Ltd.

A15, Huaqiao Economic Development Zone, Shuangyang, Luojiang, Quanzhou, Fujian, China

**FCC ID: 2AARFBFTM82501**

<b>Report Type:</b> Original Report	<b>Product Type:</b> Digital transceiver
<b>Report Number:</b>	RSZ180208025-00A
<b>Report Date:</b>	2018-05-14
<b>Reviewed By:</b>	Rocky Kang RF Engineer <i>Rocky Kang</i>
<b>Prepared By:</b>	Bay Area Compliance Laboratories Corp. (Shenzhen) 6/F., West Wing, Third Phase of Wanli Industrial Building, Shihua Road, Futian Free Trade Zone, Shenzhen, Guangdong, China Tel: +86-755-33320018 Fax: +86-755-33320008 <a href="http://www.baclcorp.com.cn">www.baclcorp.com.cn</a>

**Note:** This report must not be used by the customer to claim product certification, approval, or endorsement by A2LA\* or any agency of the Federal Government. \* This report may contain data that are not covered by the A2LA accreditation and are marked with an asterisk “\*”

## TABLE OF CONTENTS

<b>GENERAL INFORMATION.....</b>	<b>4</b>
PRODUCT DESCRIPTION FOR EQUIPMENT UNDER TEST (EUT).....	4
OBJECTIVE .....	4
RELATED SUBMITTAL(S)/GRANT(S).....	4
TEST METHODOLOGY .....	4
MEASUREMENT UNCERTAINTY.....	5
TEST FACILITY .....	5
<b>SYSTEM TEST CONFIGURATION.....</b>	<b>6</b>
DESCRIPTION OF TEST CONFIGURATION .....	6
EUT EXERCISE SOFTWARE .....	6
SPECIAL ACCESSORIES.....	6
EQUIPMENT MODIFICATIONS .....	6
SUPPORT EQUIPMENT LIST AND DETAILS .....	6
EXTERNAL I/O CABLE.....	6
BLOCK DIAGRAM OF TEST SETUP .....	7
<b>SUMMARY OF TEST RESULTS .....</b>	<b>8</b>
<b>TEST EQUIPMENT LIST .....</b>	<b>9</b>
<b>FCC §1.1307 (b) (1) &amp; §2.1091- MAXIMUM PERMISSIBLE EXPOSURE (MPE).....</b>	<b>10</b>
APPLICABLE STANDARD .....	10
RESULT .....	10
<b>FCC §2.1046 &amp; §90.205 - RF OUTPUT POWER.....</b>	<b>11</b>
APPLICABLE STANDARD .....	11
TEST PROCEDURE .....	11
TEST DATA .....	11
<b>FCC §2.1047 &amp; §90.207 - MODULATION CHARACTERISTIC.....</b>	<b>13</b>
APPLICABLE STANDARD .....	13
TEST PROCEDURE .....	13
TEST DATA .....	13
<b>FCC §2.1049 &amp; §90.210 – OCCUPIED BANDWIDTH &amp; EMISSION MASK .....</b>	<b>19</b>
APPLICABLE STANDARD .....	19
TEST PROCEDURE .....	19
TEST DATA .....	19
<b>FCC §2.1051 &amp; §90.210 - SPURIOUS EMISSIONS AT ANTENNA TERMINALS .....</b>	<b>25</b>
APPLICABLE STANDARD .....	25
TEST PROCEDURE .....	25
TEST DATA .....	25
<b>FCC §2.1053 &amp; §90.210 - RADIATED SPURIOUS EMISSIONS .....</b>	<b>28</b>
APPLICABLE STANDARD .....	28
TEST PROCEDURE .....	28
TEST DATA .....	28
<b>FCC §2.1055 &amp; §90.213 - FREQUENCY STABILITY .....</b>	<b>30</b>
APPLICABLE STANDARD .....	30

TEST PROCEDURE .....30  
TEST DATA .....30  
**FCC §90.214 - TRANSIENT FREQUENCY BEHAVIOR.....32**  
APPLICABLE STANDARD .....32  
TEST PROCEDURE .....32  
TEST DATA .....33

## GENERAL INFORMATION

---

### Product Description for Equipment under Test (EUT)

The *Fujian BelFone Communications Technology Co., Ltd.*'s product, model number: *BF-TM8250 UHF* (FCC ID: 2AARFBFTM82501) or the "EUT" in this report was a *Digital transceiver* which was measured approximately: 17.5 cm (L) × 17.5 cm (W) × 6.3 cm (H), rated with input voltage: DC 13.8 V.

### EUT Specification:

<b>Operating frequency band</b>	400-470 MHz
<b>Modulation type</b>	4FSK, FM
<b>Channel separation</b>	12.5kHz
<b>Rate Output Power</b>	High: 25 W Low: 10 W

\* All measurement and test data in this report was gathered from production sample serial number: 1800186 (Assigned by BACL, Shenzhen). The EUT supplied by the applicant was received on 2018-02-08.

### Objective

This test report is prepared on behalf of *Fujian BelFone Communications Technology Co., Ltd.* in accordance with Part 2, and Part 90 of the Federal Communication Commissions rules.

### Related Submittal(s)/Grant(s)

No Related Submittal(s)/Grant(s).

### Test Methodology

All tests and measurements indicated in this document were performed in accordance with the Code of federal Regulations Title 47 Part 2, Sub-part J as well as the following individual parts:

Part 90 – Private Land Mobile Radio Service

All emissions measurement was performed at Bay Area Compliance Laboratories Corp. (Shenzhen). The radiated testing was performed at an antenna-to-EUT distance of 3 meters.

**Measurement Uncertainty**

Parameter	uncertainty
Occupied Channel Bandwidth	±5%
RF Output Power with Power meter	±0.5dB
RF conducted test with spectrum	±1.5dB
All emissions, radiated	±4.88dB
Temperature	±3°C
Humidity	±6%
Supply voltages	±0.4%

**Test Facility**

The Test site used by Bay Area Compliance Laboratories Corp. (Shenzhen) to collect test data is located on the 6/F., West Wing, Third Phase of Wanli Industrial Building, Shihua Road, Futian Free Trade Zone, Shenzhen, Guangdong, China.

The test site has been approved by the FCC under the KDB 974614 D01 and is listed in the FCC Public Access Link (PAL) database, FCC Registration No. : 342867, the FCC Designation No. : CN1221.

The test site has been registered with ISED Canada under ISED Canada Registration Number 3062B.

## SYSTEM TEST CONFIGURATION

### Description of Test Configuration

The system was configured for testing in a test mode which has been done in the factory.

### EUT Exercise Software

No exercise software was used.

### Special Accessories

No special accessory was used.

### Equipment Modifications

No modification was made to the EUT tested.

### Support Equipment List and Details

Manufacturer	Description	Model	Serial Number
TDK-Lambda	DC Power Supply	Z60-14-L-C	/
/	Load	/	/

### External I/O Cable

Cable Description	Length (m)	From Port	To
Un-shielding Detachable DC Power Cable	1.8	EUT	DC Power Supply
Shielding Detachable RF Cable	0.5	EUT	Load

**Block Diagram of Test Setup**

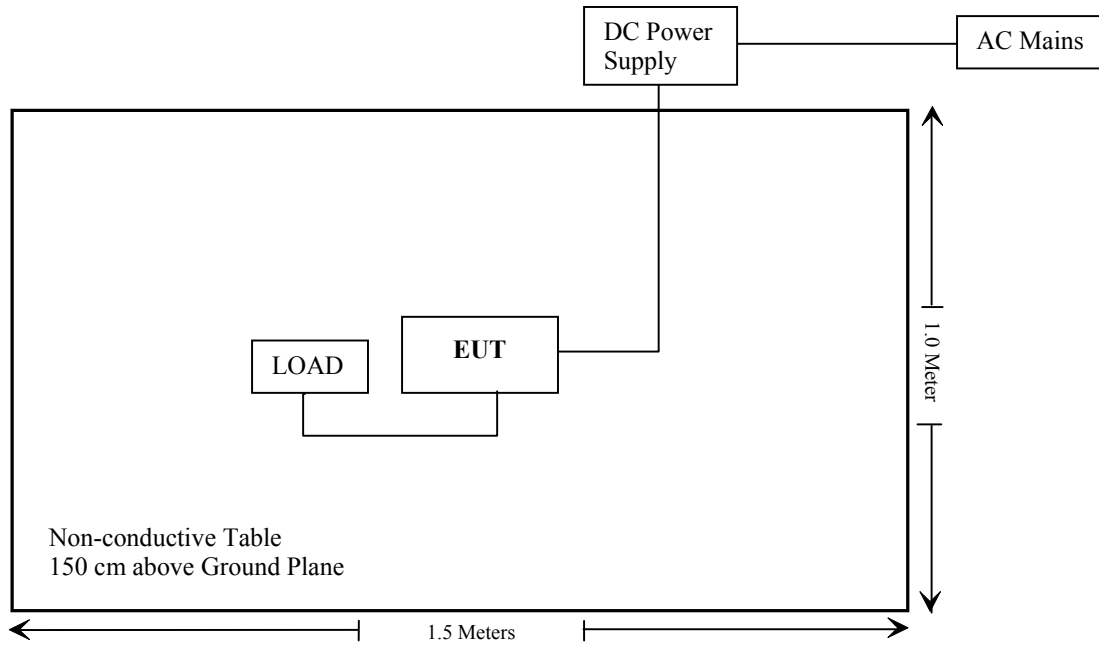

**SUMMARY OF TEST RESULTS**

<b>FCC Rules</b>	<b>Description of Test</b>	<b>Results</b>
§1.1307(b), §2.1091	Maximum Permissible exposure (MPE)	Compliance
§2.1046; §90.205	RF Output Power	Compliance
§2.1047; §90.207	Modulation Characteristic	Compliance
§2.1049; §90.210	Occupied Bandwidth & Emission Mask	Compliance
§2.1051; §90.210	Spurious Emission at Antenna Terminal	Compliance
§2.1053; §90.210	Spurious Radiated Emissions	Compliance
§2.1055; §90.213	Frequency Stability	Compliance
§90.214	Transient Frequency Behavior	Compliance



**TEST EQUIPMENT LIST**

Manufacturer	Description	Model	Serial Number	Calibration Date	Calibration Due Date
<b>Radiated Emission Test</b>					
Rohde & Schwarz	EMI Test Receiver	ESCI	101120	2018-01-11	2019-01-11
HP	Amplifier	HP8447E	1937A01046	2017-11-19	2018-05-17
Sunol Sciences	Broadband Antenna	JB1	A040904-1	2017-12-22	2020-12-21
Rohde & Schwarz	Signal Analyzer	FSEM	845987/005	2017-04-24	2018-04-24
Sunol Sciences	Horn Antenna	DRH-118	A052604	2017-12-22	2020-12-21
HP	Synthesized Sweeper	HP 8341B	2624A00116	2017-07-02	2018-07-01
Mini	Amplifier	ZVA-183-S+	5969001149	2017-05-21	2018-05-21
A.H. System	Horn Antenna	SAS-200/571	135	2015-08-18	2018-08-17
Ducommun technologies	RF Cable	UFA210A-1-4724-30050U	MFR64369 223410-001	2017-11-19	2018-05-21
Ducommun technologies	RF Cable	104PEA	218124002	2017-11-19	2018-05-21
Ducommun technologies	RF Cable	RG-214	1	2017-11-19	2018-05-21
Ducommun technologies	RF Cable	RG-214	2	2017-11-22	2018-05-22
COM POWER	Dipole Antenna	AD-100	041000	2017-08-18	2018-08-18
<b>RF Conducted test</b>					
Rohde & Schwarz	Signal Analyzer	FSIQ26	8386001028	2017-04-24	2018-04-24
Rohde & Schwarz	SPECTRUM ANALYZER	FSU26	200120	2017-12-24	2018-12-24
HP Agilent	RF Communication test set	8920A	3325U00859	2017-06-14	2018-06-13
LEADER	MILLIVOLTMETER	LMV-181A	6041126	2017-07-02	2018-07-01
Hewlett-Packard	Frequency Counter	5343A	2232A00827	2017-05-09	2018-05-08
ESPEC	Temperature & Humidity Chamber	EL-10KA	09107726	2017-11-01	2018-10-31
Ducommun technologies	RF Cable	RG-214	3	2017-11-22	2018-05-22
WEINSCHL	30dB Attenuator	N/A	N/A	2017-11-22	2018-05-23

\* **Statement of Traceability:** Bay Area Compliance Laboratories Corp. (Shenzhen) attests that all calibrations have been performed in accordance to requirements that traceable to National Primary Standards and International System of Units (SI).

## FCC §1.1307 (b) (1) & §2.1091- MAXIMUM PERMISSIBLE EXPOSURE (MPE)

### Applicable Standard

According to subpart 1.1307 (b)(1), 2.1091 systems operating under the provisions of this section shall be operated in a manner that ensures the public is not exposed to RF energy level in excess of the communication guidelines.

#### Limits for Occupational/Controlled Exposure

Limits for occupational/Controlled Exposure				
Frequency Range (MHz)	Electric Field Strength (V/m)	Magnetic Field Strength (A/m)	Power Density (mW/cm <sup>2</sup> )	Averaging Time (Minutes)
0.3-1.34	614	1.63	*(100)	6
1.34-30	1842/f	4.89/f	*(900/f <sup>2</sup> )	6
30-300	61.4	0.163	1.0	6
300-1500	/	/	f/300	6
1500-100,000	/	/	5.0	6

f = frequency in MHz

\* = Plane-wave equivalent power density

### Result

#### Calculated Formulary:

Predication of MPE limit at a given distance

$$S = \frac{PG}{4\pi R^2}$$

S = power density (in appropriate units, e.g. mW/cm<sup>2</sup>)

P = power input to the antenna (in appropriate units, e.g., mW).

G = power gain of the antenna in the direction of interest relative to an isotropic radiator, the power gain factor, is normally numeric gain.

R = distance to the center of radiation of the antenna (appropriate units, e.g., cm)

For worst case:

Frequency (MHz)	Antenna Gain		Max average output power (mW)	Evaluation Distance (cm)	Power Density (mW/cm <sup>2</sup> )	MPE Limit (mW/cm <sup>2</sup> )
	(dBi)	(numeric)				
400-470	5.5	3.55	14091.915	55	1.32	1.33

Note: Max tune-up output power is 44.5dBm (28183.83 mW), the EUT has PTT function, the duty cycle is 50%. So the average power is 14091.915 mW

To maintain compliance with the FCC's RF exposure guidelines, place the equipment at least 55cm from nearby persons.

### Result: Compliance

**FCC §2.1046 & §90.205 - RF OUTPUT POWER**

**Applicable Standard**

FCC §2.1046 and §90.205

**Test Procedure**

Conducted RF Output Power:

The RF output of the transmitter was connected to the input of the spectrum analyzer through sufficient attenuation.

Spectrum Analyzer Setting:

R B/W	Video B/W
100 kHz	300 kHz

**Test Data**

**Environmental Conditions**

<b>Temperature:</b>	26 °C
<b>Relative Humidity:</b>	52 %
<b>ATM Pressure:</b>	101.0 kPa

*The testing was performed by Tracy Hu on 2018-03-07.*

*Test Mode: Transmitting*

**Test Result:** Compliance. Please refer to following table.

Modulation	Channel Separation (kHz)	Frequency (MHz)	Power Level	Output Power (dBm)	Output Power (W)	Result
Analog	12.5	400.0125	High	44.20	26.30	Pass
			Low	40.63	11.56	Pass
	12.5	453.2125	High	44.25	26.61	Pass
			Low	40.19	10.45	Pass
	12.5	469.9875	High	44.41	27.61	Pass
			Low	40.02	10.05	Pass
Digital	12.5	400.0125	High	44.07	25.53	Pass
			Low	40.75	11.89	Pass
	12.5	453.2125	High	44.40	27.54	Pass
			Low	40.43	11.04	Pass
	12.5	469.9875	High	44.41	27.61	Pass
			Low	40.04	10.09	Pass

Note: The rated high power is 25 W.  
 The rated low power is 10 W.

## **FCC §2.1047 & §90.207 - MODULATION CHARACTERISTIC**

### **Applicable Standard**

FCC§2.1047 and §90.207:

- (a) Equipment which utilizes voice modulated communication shall show the frequency response of the audio modulating circuit over a range of 100 to 5000 Hz. for equipment which is required to have a low pass filter, the frequency response of the filter, or all of the circuitry installed between the modulation limited and the modulated stage shall be supplied.
- (b) Equipment which employs modulation limiting, a curve showing the percentage of modulation versus the modulation input voltage shall be supplied.

### **Test Procedure**

Test Method: TIA/EIA-603-D

### **Test Data**

#### **Environmental Conditions**

<b>Temperature:</b>	25 °C
<b>Relative Humidity:</b>	52 %
<b>ATM Pressure:</b>	101.0 kPa

*The testing was performed by Tracy Hu on 2018-03-08.*

*Test Mode: Transmitting*

Please refer to the following tables and plots.

**Audio Frequency Response**

Carrier Frequency: 453.2125 MHz, Channel spacing=12.5 kHz

<b>Audio Frequency (Hz)</b>	<b>Response Attenuation (dB)</b>
300	-10.23
400	-7.17
500	-5.32
600	-4.04
700	-2.81
800	-1.81
900	-0.76
1000	0.00
1200	1.68
1400	2.81
1600	4.01
1800	5.02
2000	5.94
2100	6.38
2200	6.78
2300	7.07
2400	7.11
2500	6.97
2600	6.63
2700	6.28
2800	5.83
2900	5.44
3000	5.03

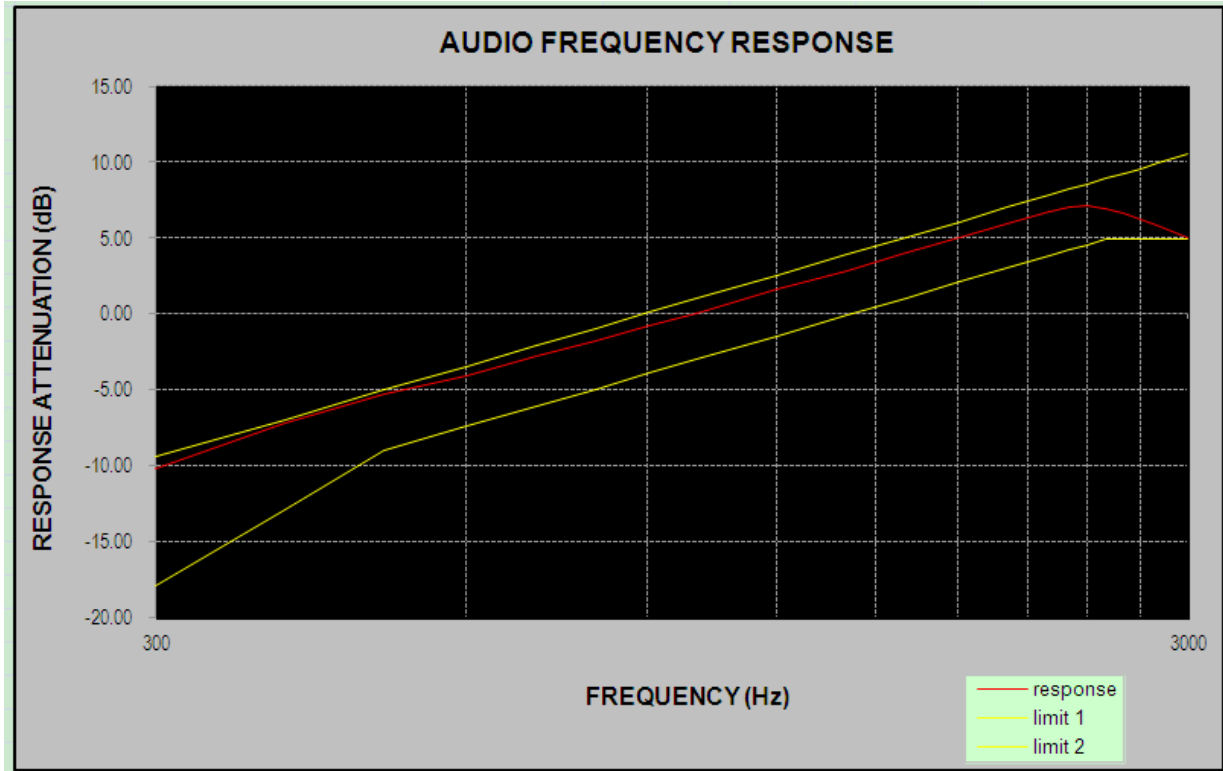

**Audio frequency lows pass filter response**

Carrier Frequency: 453.2125 MHz, Channel spacing=12.5 kHz

Audio Frequency (kHz)	Response Attenuation (dB)	Limit (dB)
1.0	0.0	/
3.0	-36.80	0.0
4.0	-46.02	-12.5
5.0	-60.98	-22.2
6.0	-65.83	-30.1
7.0	-74.89	-36.8
8.0	-74.05	-42.6
9.0	-79.80	-47.7
10.0	-88.82	-52.3
12.0	-96.17	-60.2
14.0	-84.20	-66.9
16.0	-86.39	-72.7
18.0	-93.28	-77.8
20.0	-89.90	-82.5

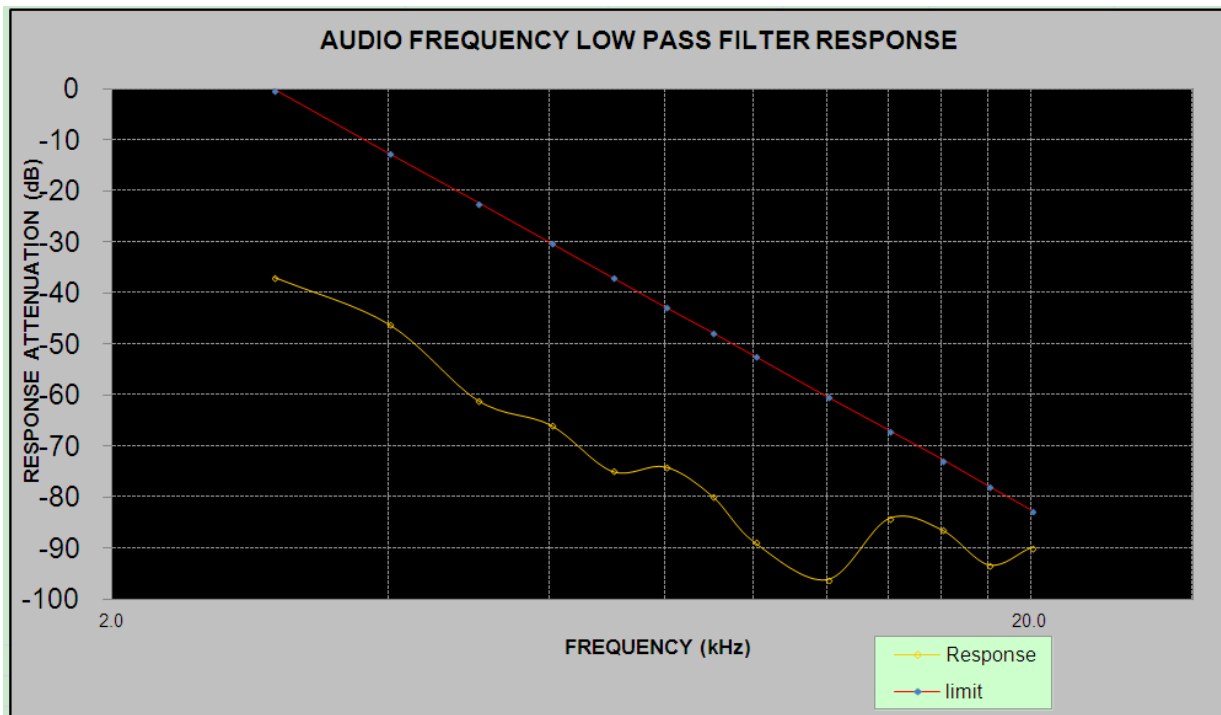



**MODULATION LIMITING**

Carrier Frequency: 453.2125 MHz, Channel spacing=12.5 kHz

Audio Frequency (Hz)	Instantaneous		Steady-state		FCC Limit [kHz]
	DEVIATION (@+20dB) [kHz]	DEVIATION (@-20dB) [kHz]	DEVIATION (@+20dB) [kHz]	DEVIATION (@-20dB) [kHz]	
300	2.168	0.062	2.166	0.058	2.500
400	2.047	0.086	2.041	0.082	2.500
500	2.237	0.107	2.237	0.104	2.500
600	2.224	0.115	2.221	0.111	2.500
700	2.150	0.132	2.148	0.129	2.500
800	2.004	0.143	1.999	0.139	2.500
900	1.773	0.154	1.772	0.152	2.500
1000	1.610	0.170	1.612	0.167	2.500
1200	2.006	0.197	2.002	0.195	2.500
1400	1.953	0.228	1.949	0.224	2.500
1600	1.868	0.251	1.867	0.249	2.500
1800	1.762	0.289	1.760	0.286	2.500
2000	1.627	0.313	1.623	0.310	2.500
2100	1.605	0.324	1.601	0.319	2.500
2200	1.506	0.339	1.500	0.336	2.500
2300	1.483	0.356	1.484	0.352	2.500
2400	1.332	0.370	1.331	0.367	2.500
2500	1.351	0.380	1.347	0.377	2.500
2600	1.303	0.397	1.301	0.394	2.500
2700	1.157	0.396	1.157	0.394	2.500
2800	1.163	0.393	1.160	0.390	2.500
2900	1.145	0.386	1.144	0.382	2.500
3000	0.938	0.369	0.935	0.365	2.500

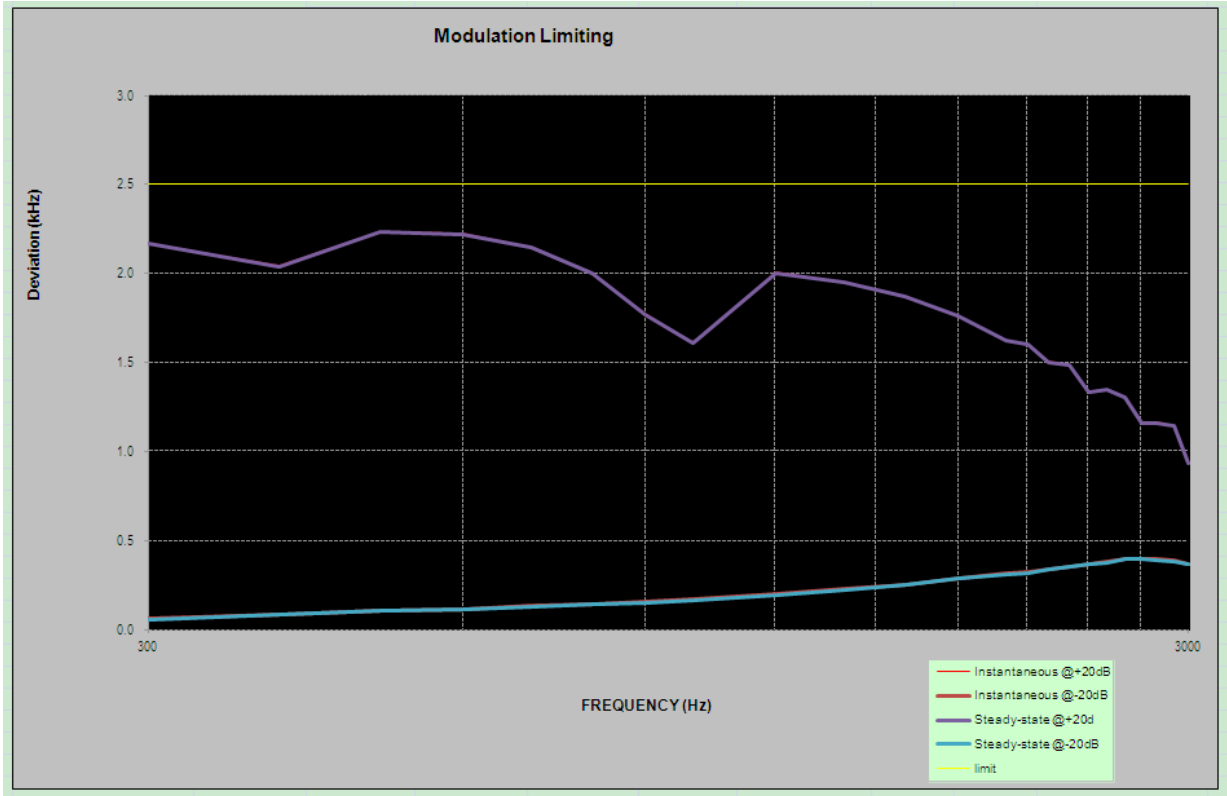

## **FCC §2.1049 & §90.210 – OCCUPIED BANDWIDTH & EMISSION MASK**

### **Applicable Standard**

FCC §2.1049 and §90.210

Emission Mask D - 12.5 kHz channel bandwidth equipment. For transmitters designed to operate with a 12.5 kHz channel bandwidth, any emission must be attenuated below the power (P) of the highest emission contained within the authorized bandwidth as follows:

- 1) For any frequency removed from the center of the authorized bandwidth  $f_0$  to 5.625 kHz removed from  $f_0$ , 0dB.
- 2) On any frequency removed from the center of the authorized bandwidth by a displacement frequency ( $f_d$  in kHz) of more than 5.626 kHz but no more than 12.5 kHz, at least 7.27 ( $f_d - 2.88$  kHz) dB.
- 3) On any frequency removed from the center of the authorized bandwidth by a displacement frequency ( $f_d$  in kHz) of more than 12.5 kHz at least: At least  $50 + 10 \log (P)$  dB or 70 dB, whichever is the lesser attenuation.

### **Test Procedure**

The RF output of the transmitter was connected to the input of the spectrum analyzer through sufficient attenuation.

The resolution bandwidth of the spectrum analyzer was set at 100 Hz and the spectrum was recorded in the frequency band  $\pm 50$  kHz from the carrier frequency.

### **Test Data**

#### **Environmental Conditions**

<b>Temperature:</b>	23~25 °C
<b>Relative Humidity:</b>	50~52 %
<b>ATM Pressure:</b>	100.5~101.0 kPa

*The testing was performed by Tracy Hu from 2018-03-08 to 2018-05-10.*

Modulation	Channel Separation (kHz)	Frequency (MHz)	Power Level	99% Occupied Bandwidth (kHz)	26 dB Emissions Bandwidth (kHz)
Analog	12.5	453.2125	High	9.936	10.337
			Low	9.936	10.337
Digital	12.5	453.2125	High	6.891	8.173
			Low	6.731	8.734

Note: Emission bandwidth was based on calculation method instead of measurement.

Emission Designator Per CFR 47 §2.201& §2.202&,  $B_n = 2M + 2D$

**For FM Mode (Channel Spacing: 12.5 kHz)**

Emission Designator 11K0F3E In this case, the maximum modulating frequency is 3.0 kHz with a 2.5 kHz deviation.  $BW = 2(M+D) = 2*(3.0\text{ kHz} + 2.5\text{ kHz}) = 11\text{ kHz} \rightarrow 11K0$   
 F3E portion of the designator represents an FM voice transmission Therefore, the entire designator for 12.5 kHz channel spacing FM mode is 11K0F3E.

**For Digital Mode (Channel Spacing: 12.5 kHz)**

Emission Designator 7K60F1D and 7K60F1E  
 The 99% energy rule (title 47CFR 2.1049) was used for digital mode. It basically states that 99% of the modulation energy falls within X kHz, in this case, 6.891 kHz. The emission mask was obtained from 47CFR 90.210(d).  
 F1D and F1E portion of the designator indicates digital information.  
 Therefore, the entire designator for 12.5 kHz channel spacing digital mode is 7K60F1D and 7K60F1E.

**Analog Modulation:**

**Frequency 453.2125 MHz: 99% Occupied & 26 dB Bandwidth, High Power**

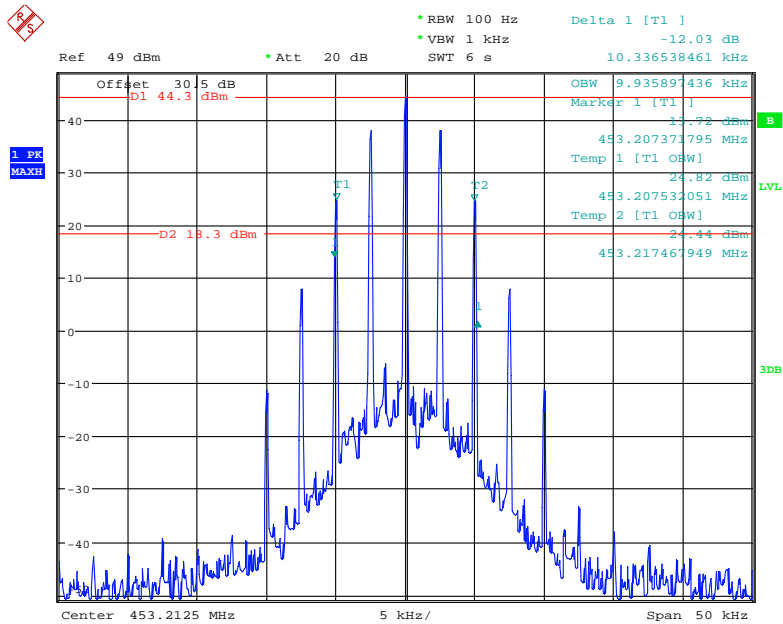

Date: 10.MAY.2018 20:20:38

**Frequency 453.2125 MHz: 99% Occupied & 26 dB Bandwidth, Low Power**

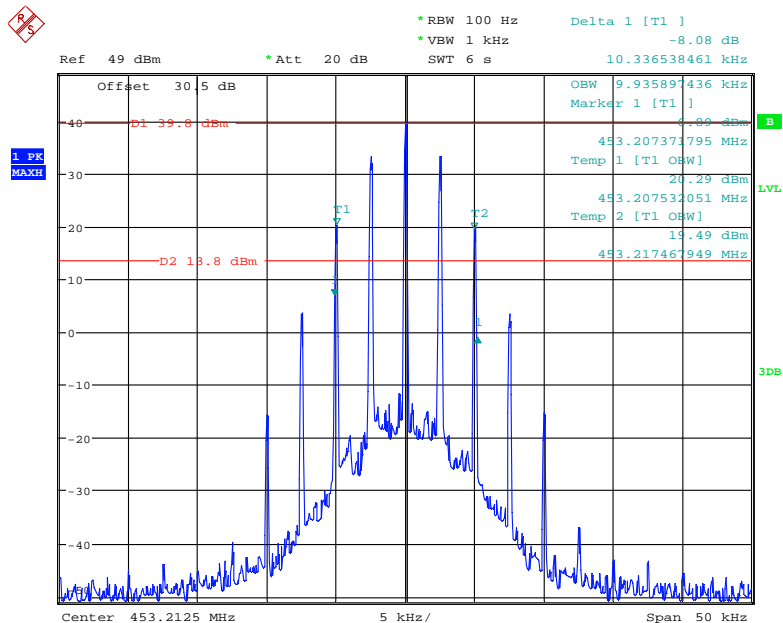

Date: 10.MAY.2018 20:12:29

### Frequency 453.2125 MHz: Emission Mask, High Power

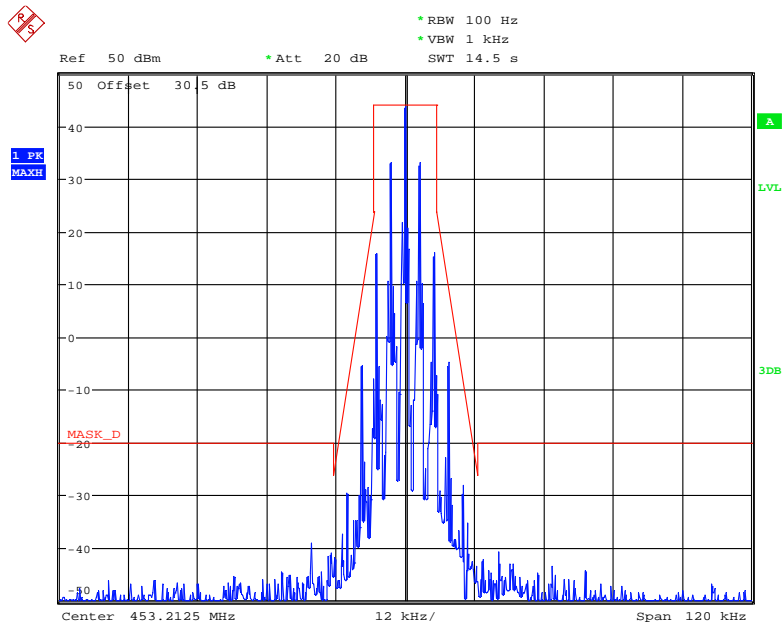

Date: 29.MAR.2018 23:07:22

### Frequency 453.2125 MHz: Emission Mask, Low Power

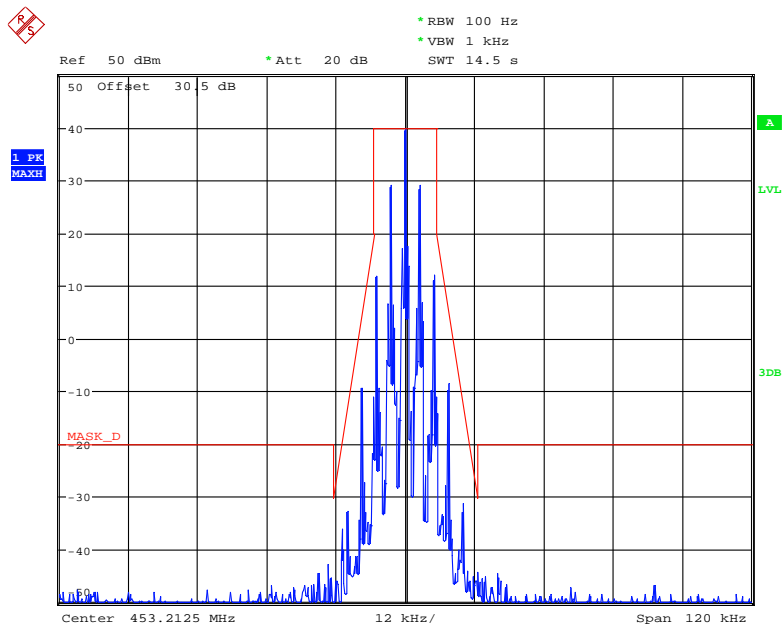

Date: 29.MAR.2018 22:49:25

**Digital Modulation:**

**Frequency 453.2125 MHz: 99% Occupied & 26 dB Bandwidth, High Power**

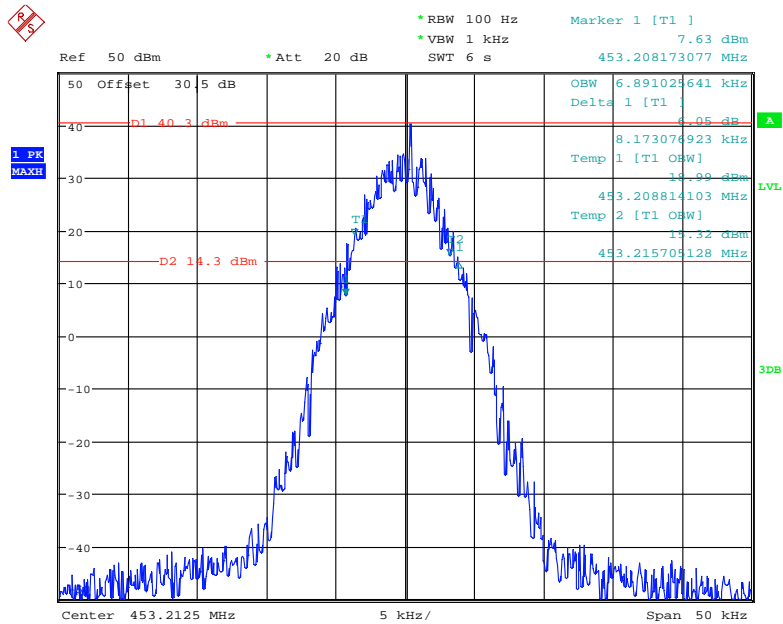

Date: 8.MAR.2018 00:04:37

**Frequency 453.2125 MHz: 99% Occupied & 26 dB Bandwidth, Low Power**

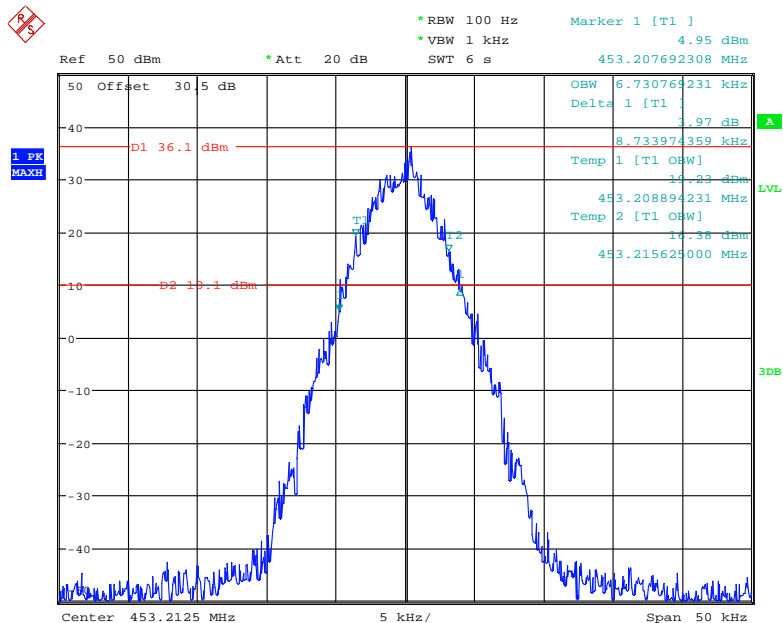

Date: 8.MAR.2018 00:12:15

### Frequency 453.2125 MHz: Emission Mask, High Power

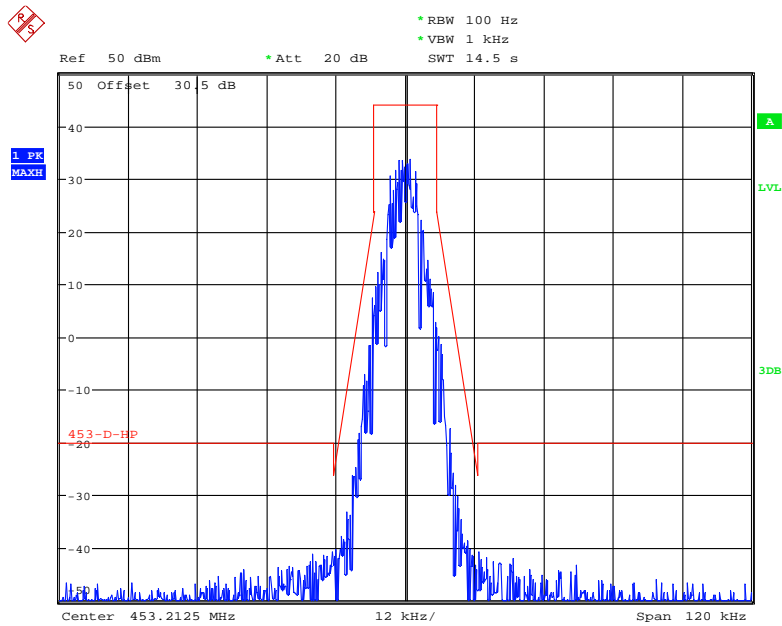

Date: 8.MAR.2018 00:03:32

### Frequency 453.2125 MHz: Emission Mask, Low Power

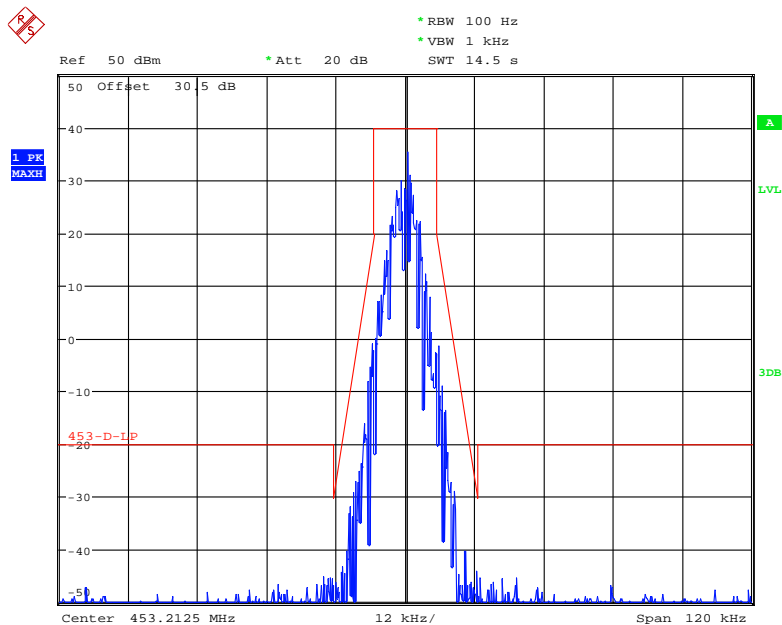

Date: 8.MAR.2018 00:02:37



## FCC §2.1051 & §90.210 - SPURIOUS EMISSIONS AT ANTENNA TERMINALS

---

### Applicable Standard

Emission Mask D—12.5 kHz channel bandwidth equipment. For transmitters designed to operate with a 12.5 kHz channel bandwidth, any emission must be attenuated below the power (P) of the highest emission contained within the authorized bandwidth as follows:

- 1) For any frequency removed from the center of the authorized bandwidth  $f_0$  to 5.625 kHz removed from  $f_0$ , 0 dB.
- 2) On any frequency removed from the center of the authorized bandwidth by a displacement frequency ( $f_d$  in kHz) of more than 5.626 kHz but no more than 12.5 kHz, at least  $7.27 (f_d - 2.88)$  dB.
- 3) On any frequency removed from the center of the authorized bandwidth by a displacement frequency ( $f_d$  in kHz) of more than 12.5 kHz: At least  $50 + 10 \log (P)$  dB or 70 dB, whichever is the lesser attenuation.

### Test Procedure

The RF output of the EUT was connected to a spectrum analyzer through appropriate attenuation. The resolution bandwidth of the spectrum analyzer was set at 100kHz for below 1GHz, and 1MHz for above 1GHz. Sufficient scans were taken to show any out of band emissions up to 10<sup>th</sup> harmonic.

### Test Data

#### Environmental Conditions

Temperature:	25 °C
Relative Humidity:	52 %
ATM Pressure:	101.0 kPa

*The testing was performed by Tracy Hu on 2018-03-07.*

*Test Mode: Transmitting, please refer to the following plots.*

Analog Modulation:

30MHz - 1 GHz

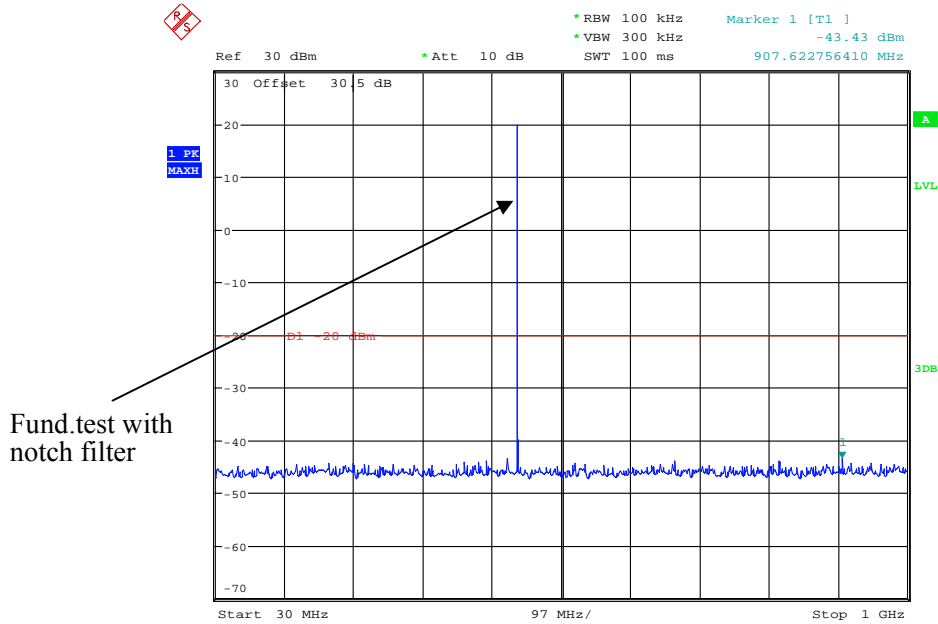

Date: 7.MAR.2018 21:58:23

1 GHz - 5 GHz

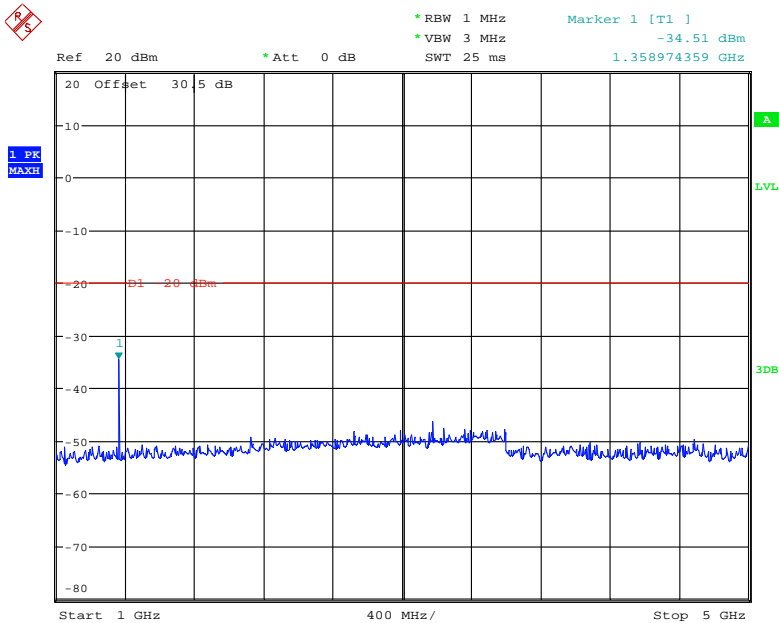

Date: 7.MAR.2018 21:59:07

**Digital Modulation:**

**30MHz - 1 GHz**

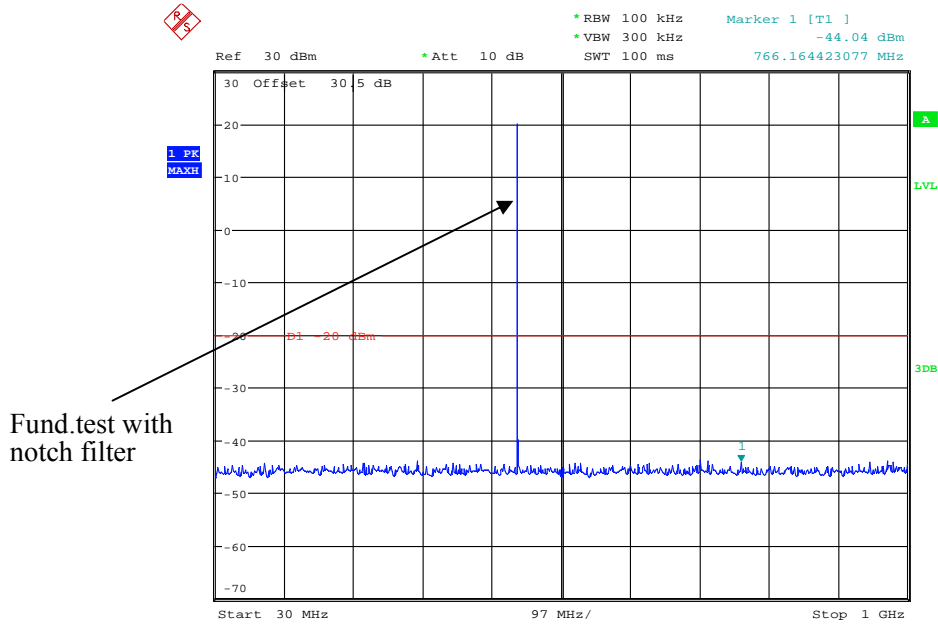

Date: 7.MAR.2018 21:58:03

**1 GHz - 5 GHz**

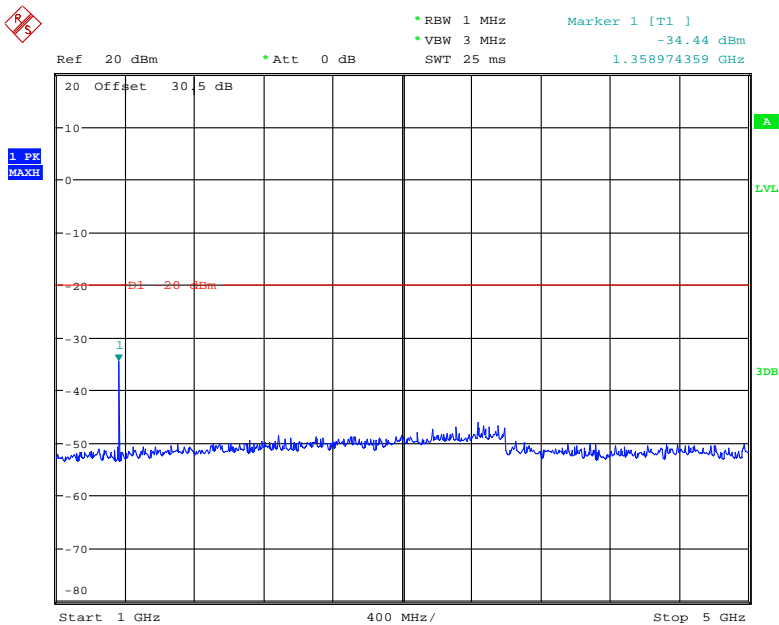

Date: 7.MAR.2018 21:59:31

## **FCC §2.1053 & §90.210 - RADIATED SPURIOUS EMISSIONS**

### **Applicable Standard**

FCC §2.1053 and §90.210

### **Test Procedure**

The transmitter was placed on a wooden turntable, and it was transmitting into a non-radiating load, which was also placed on the turntable.

The measurement antenna was placed at a distance of 3 meters from the EUT. During the tests, the antenna height and polarization as well as EUT azimuth were varied in order to identify the maximum level of emissions from the EUT. The test was performed by placing the EUT on 3-orthogonal axis.

The frequency range up to teeth harmonic of the fundamental frequency was investigated.

Remove the EUT and replace it with substitution antenna. A signal generator was connected to the substitution antenna by a non-radiating cable. The absolute levels of the spurious emissions were measured by the substitution.

Spurious emissions in dB = 10 lg (TXpwr in Watts/0.001)-the absolute level

Spurious attenuation limit in dB = 50 + 10 Log<sub>10</sub> (power out in Watts) for EUT with a 12.5 kHz channel bandwidth.

### **Test Data**

#### **Environmental Conditions**

<b>Temperature:</b>	25 °C
<b>Relative Humidity:</b>	52 %
<b>ATM Pressure:</b>	101.0 kPa

*The testing was performed by Tracy Hu on 2018-03-29.*

Test Mode: Transmitting (High power level)

**30MHz - 5GHz:**

Frequency (MHz)	Receiver Reading (dBµV)	Turn Table Angle Degree	Rx Antenna		Substituted			Absolute Level (dBm)	Limit (dBm)	Margin (dB)
			Height (m)	Polar (H/V)	Level (dBm)	Cable Loss (dB)	Antenna Gain (dB)			
Analog Modulation 453.2125MHz										
906.425	56.28	110	2.3	H	-38.7	0.70	0.0	-39.40	-20	19.40
906.425	49.68	290	1.9	V	-45.3	0.70	0.0	-46.00	-20	26.00
1359.64	63.22	210	2.0	H	-44.7	1.60	7.90	-38.40	-20	18.40
1359.64	61.51	270	1.8	V	-46.7	1.60	7.90	-40.40	-20	20.40
1812.85	58.39	288	2.5	H	-48.0	1.30	9.30	-40.00	-20	20.00
1812.85	53.63	77	1.3	V	-52.4	1.30	9.30	-44.40	-20	24.40
2266.06	56.14	163	1.6	H	-49.1	1.30	10.00	-40.40	-20	20.40
2266.06	50.64	24	2.5	V	-54.5	1.30	10.00	-45.80	-20	25.80
Digital Modulation 453.2125MHz										
906.425	55.96	218	2.3	H	-39.0	0.70	0.0	-39.70	-20	19.70
906.425	50.47	284	2.3	V	-44.5	0.70	0.0	-45.20	-20	25.20
1359.64	61.54	60	1.9	H	-46.4	1.60	7.90	-40.10	-20	20.10
1359.64	60.22	156	2.3	V	-48.0	1.60	7.90	-41.70	-20	21.70
1812.85	56.37	19	1.7	H	-50.1	1.30	9.30	-42.10	-20	22.10
1812.85	55.28	57	1.6	V	-50.8	1.30	9.30	-42.80	-20	22.80
2266.06	54.16	134	1.1	H	-51.1	1.30	10.00	-42.40	-20	22.40
2266.06	49.83	354	1.3	V	-55.3	1.30	10.00	-46.60	-20	26.60

**Note:**

Absolute Level = Substituted Level - Cable loss + Antenna Gain

Margin = Limit- Absolute Level

## **FCC §2.1055 & §90.213 - FREQUENCY STABILITY**

---

### **Applicable Standard**

FCC §2.1055 and §90.213

### **Test Procedure**

Frequency Stability vs. Temperature: The equipment under test was connected to an external DC power supply and the RF output was connected to a frequency counter via feed-through attenuators. The EUT was placed inside the temperature chamber. The DC leads and RF output cable exited the chamber through an opening made for the purpose.

After the temperature stabilized for approximately 20 minutes, the frequency output was recorded from the counter.

### **Test Data**

#### **Environmental Conditions**

<b>Temperature:</b>	25 °C
<b>Relative Humidity:</b>	52 %
<b>ATM Pressure:</b>	101.0 kPa

*The testing was performed by Tracy Hu on 2018-03-09.*

*Test Mode: Transmitting*

<b>Analog Modulation, Reference Frequency: 453.2125MHz, Limit: ±2.5 ppm, 12.5 kHz</b>			
<b>Test Environment</b>		<b>Frequency Measure with Time Elapsed</b>	
<b>Temperature (°C)</b>	<b>Power Supplied (V<sub>DC</sub>)</b>	<b>Measured Frequency error (MHz)</b>	<b>Frequency Error (ppm)</b>
Frequency Stability versus Input Temperature			
50	13.8	453.21218	-0.7127
40	13.8	453.21221	-0.6465
30	13.8	453.21220	-0.6686
20	13.8	453.21222	-0.6244
10	13.8	453.21223	-0.6024
0	13.8	453.21215	-0.7789
-10	13.8	453.21218	-0.7127
-20	13.8	453.21213	-0.8230
-30	13.8	453.21222	-0.6244
Frequency Stability versus Input Voltage			
20	11.7	453.21221	-0.6465

<b>Digital Modulation, Reference Frequency: 453.2125MHz, Limit: ±2.5 ppm, 12.5 kHz</b>			
<b>Test Environment</b>		<b>Frequency Measure with Time Elapsed</b>	
<b>Temperature (°C)</b>	<b>Power Supplied (V<sub>DC</sub>)</b>	<b>Measured Frequency error (MHz)</b>	<b>Frequency Error (ppm)</b>
Frequency Stability versus Input Temperature			
50	13.8	453.21222	-0.6112
40	13.8	453.21218	-0.6995
30	13.8	453.21222	-0.6112
20	13.8	453.21223	-0.5891
10	13.8	453.21218	-0.6995
0	13.8	453.21217	-0.7215
-10	13.8	453.21218	-0.6995
-20	13.8	453.21222	-0.6112
-30	13.8	453.21227	-0.5009
Frequency Stability versus Input Voltage			
20	11.7	453.21221	-0.6333

## FCC §90.214 - TRANSIENT FREQUENCY BEHAVIOR

### Applicable Standard

Regulations: FCC §90.214

Test method: TIA-603-D 2010, section 2.2.19.3

### Test Procedure

- a) Connect the EUT and test equipment as shown on the following block diagram.
- b) Set the Spectrum Analyzer to measure FM deviation, and tune the RF frequency to the transmitter assigned frequency.
- c) Set the signal generator to the assigned transmitter frequency and modulate it with a 1 kHz tone at  $\pm 12.5$  kHz deviation and set its output level to -100dBm.
- d) Turn on the transmitter.
- e) Supply sufficient attenuation via the RF attenuator to provide an input level to the Spectrum Analyzer that is 40 dB below the maximum allowed input power when the transmitter is operating at its rated power level. Note this power level on the Spectrum Analyzer as  $P_0$ .
- f) Turn off the transmitter.
- g) Adjust the RF level of the signal generator to provide RF power equal to  $P_0$ . This signal generator RF level shall be maintained throughout the rest of the measurement.
- h) Remove the attenuation 1, so the input power to the Spectrum Analyzer is increased by 30 dB when the transmitter is turned on.
- i) Adjust the vertical amplitude control of the spectrum analyzer to display the 1000 Hz at  $\pm 4$  divisions vertically centered on the display. Set trigger mode of the Spectrum Analyzer to "Video", and tune the "trigger level" on suitable level. Then set the "trigger offset" to -10ms for turn on and -15ms for turn off.
- j) Turn on the transmitter and the transient wave will be captured on the screen of Spectrum Analyzer. Observe the stored display. The instant when the 1 kHz test signal is completely suppressed is considered to be  $t_{on}$ . The trace should be maintained within the allowed divisions during the period  $t_1$  and  $t_2$ .
- k) Then turn off the transmitter, and another transient wave will be captured on the screen of Spectrum Analyzer. The trace should be maintained within the allowed divisions during the period  $t_3$ .

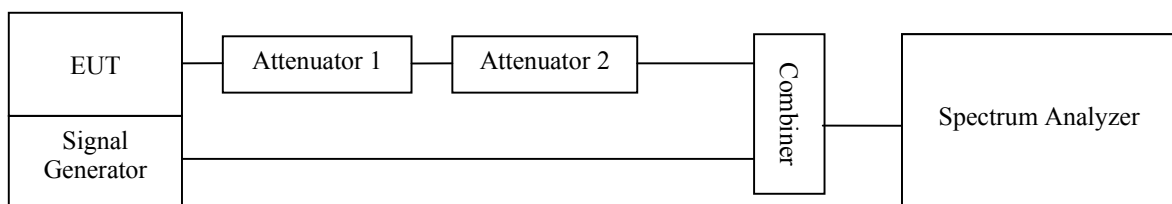



**Test Data****Environmental Conditions**

<b>Temperature:</b>	25 °C
<b>Relative Humidity:</b>	52 %
<b>ATM Pressure:</b>	101.0 kPa

*The testing was performed by Tracy Hu on 2018-03-13.*

<b>Channel Separation (kHz)</b>	<b>Transient Period (ms)</b>	<b>Transient Frequency</b>	<b>Result</b>
12.5	10 (t1)	<+/-12.5 kHz	Pass
	25(t2)	<+/-6.25 kHz	
	10 (t3)	<+/-12.5 kHz	

Please refer to the following plots.

### Turn on

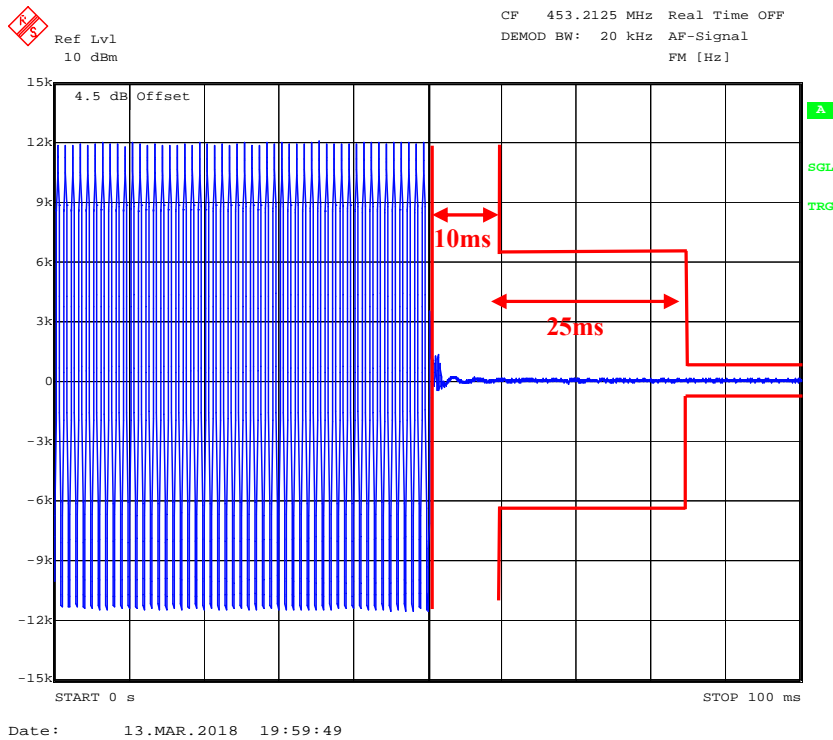

### Turn off

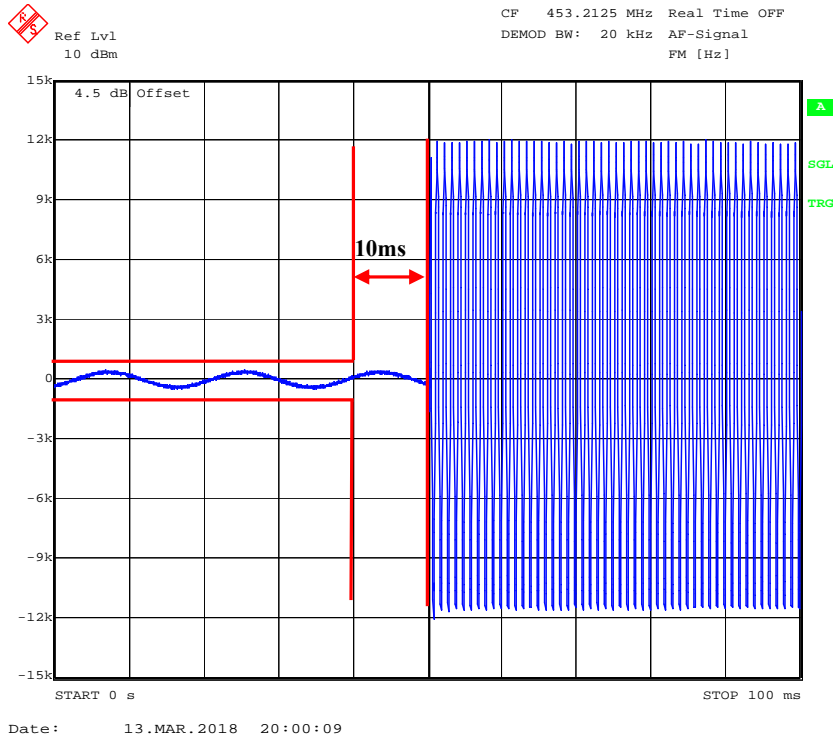

\*\*\*\*\* END OF REPORT \*\*\*\*\*