



No. 1 Workshop, M-10, Middle section, Science & Technology Park,
Shenzhen, Guangdong, China 518057

Telephone: +86 (0) 755 2601 2053
Fax: +86 (0) 755 2671 0594
Email: ee.shenzhen@sgs.com

Report No.: SZEM180900875704
Page: 1 of 88

TEST REPORT

Application No.: SZEM1809008757CR
Applicant: Fujian Belfone Communications Technology Co., Ltd.
Address of Applicant: A15 Huaqiao Economic Development Zone, Shuangyang Luojiang, Quanzhou, Fujian, China
Manufacturer / Factory: Fujian Belfone Communications Technology Co., Ltd.
Address of Manufacturer / Factory: A15 Huaqiao Economic Development Zone, Shuangyang Luojiang, Quanzhou, Fujian, China
Equipment Under Test (EUT):
EUT Name: Digital Trunking Radio
Model No.: BF-TD950
Trade mark: 
FCC ID: 2AARFBFTD95001
Standard(s) : 47 CFR Part 22,
47 CFR Part 74,
47 CFR Part 80,
47 CFR Part 90,
Date of Receipt: 2018-09-30
Date of Test: 2018-10-12 to 2018-11-14
Date of Issue: 2018-11-16

Test Result:	Pass*
---------------------	-------

* In the configuration tested, the EUT complied with the standards specified above.



Keny Xu
EMC Laboratory Manager

The manufacturer should ensure that all products in series production are in conformity with the product sample detailed in this report. If the product in this report is used in any configuration other than that detailed in the report, the manufacturer must ensure the new system complies with all relevant standards. Any mention of SGS International Electrical Approvals or testing done by SGS International Electrical Approvals in connection with, distribution or use of the product described in this report must be approved by SGS International Electrical Approvals in writing.

This document is issued by the Company subject to its General Conditions of Service printed overleaf, available on request or accessible at <http://www.sgs.com/en/Terms-and-Conditions.aspx> and, for electronic format documents, subject to Terms and Conditions for Electronic Documents at <http://www.sgs.com/en/Terms-and-Conditions/Terms-e-Document.aspx>. Attention is drawn to the limitation of liability, indemnification and jurisdiction issues defined therein. Any holder of this document is advised that information contained hereon reflects the Company's findings at the time of its intervention only and within the limits of Client's instructions, if any. The Company's sole responsibility is to its Client and this document does not exonerate parties to a transaction from exercising all their rights and obligations under the transaction documents. This document cannot be reproduced except in full, without prior written approval of the Company. Any unauthorized alteration, forgery or falsification of the content or appearance of this document is unlawful and offenders may be prosecuted to the fullest extent of the law. Unless otherwise stated the results shown in this test report refer only to the sample(s) tested and such sample(s) are retained for 30 days only.



<i>Revision Record</i>				
<i>Version</i>	<i>Chapter</i>	<i>Date</i>	<i>Modifier</i>	<i>Remark</i>
01		2018-11-16		Original

Authorized for issue by:				
				
		<hr/>		
		Edison Li /Project Engineer		
				
		<hr/>		
		Eric Fu /Reviewer		



2 Test Summary

Radio Spectrum Technical Requirement				
Item	Standard	Method	Requirement	Result
Antenna Requirement	47 CFR Part 22, Part 74, Part 80, Part 90	N/A	47 CFR Part 22.365, 47 CFR Part 74.30, 47 CFR Part 80.3(e), 47 CFR Part 90.205(g,h),	Pass

Radio Spectrum Matter Part				
Item	Standard	Method	Requirement	Result
RF Power Output	47 CFR FCC Part 2, Part22, Part74, Part80, Part90	ANSI/TIA-603-E:2016 ANSI C63.4.2014 TIA-102 CCAA-A TIA-102 CCAB-D TIA-102 CCAA-D ANSI C63.26-2015	47 CFR FCC Part 2.1046, Part22.565, Part74.461, Part80.215, Part90.205	Pass
Frequency Stability	47 CFR FCC Part 2, Part22, Part74, Part80, Part90		47 CFR FCC Part 2.1055, Part22.355, Part74.464, Part80.209, Part90.213	Pass
Audio Frequency Response	47 CFR FCC Part 2, Part74, Part80, Part90,		47 CFR FCC Part2.1047, Part74.463, Part80.213, Part90.212,	Pass
Modulation Limiting	47 CFR FCC Part 2, Part74, Part80, Part90,		47 CFR FCC Part2.1047, Part74.463, Part80.213, Part90.212,	Pass
Occupied Bandwidth	47 CFR FCC Part 2, Part22, Part74, Part80, Part90		47 CFR FCC Part 2.1049, Part22.359, Part74.462, Part80.211(e,f), Part90.210	Pass
Transient Frequency Behaviour	47 FCC CFR Part90		47 CFR FCC Part90.214	Pass
Conducted Spurious Emission	47 CFR FCC Part 2, Part22, Part74, Part80, Part90		47 CFR FCC Part 2.1051, Part22.359, Part74.462(c), Part80.211(c), Part90.210	Pass
Radiated Spurious Emission	47 CFR FCC Part 2, Part22, Part74, Part80, Part90		47 CFR FCC Part 2.1051, Part22.359, Part74.462(c), Part80.211(c), Part90.210	Pass



3 Contents

	Page
1 COVER PAGE	1
2 TEST SUMMARY	3
3 CONTENTS	4
4 GENERAL INFORMATION	6
4.1 DETAILS OF E.U.T.	6
4.2 DESCRIPTION OF SUPPORT UNITS	6
4.3 MEASUREMENT UNCERTAINTY	6
4.4 TEST LOCATION	7
4.5 TEST FACILITY	7
4.6 DEVIATION FROM STANDARDS.....	7
4.7 ABNORMALITIES FROM STANDARD CONDITIONS	7
5 EQUIPMENT LIST.....	8
6 RADIO SPECTRUM TECHNICAL REQUIREMENT.....	10
6.1 ANTENNA REQUIREMENT	10
6.1.1 <i>Test Requirement:</i>	10
6.1.2 <i>Conclusion</i>	10
7 RADIO SPECTRUM MATTER TEST RESULTS.....	12
7.1 RF POWER OUTPUT	12
7.1.1 <i>E.U.T. Operation</i>	17
7.1.2 <i>Test Setup Diagram</i>	17
7.1.3 <i>Measurement Procedure and Data</i>	17
7.2 FREQUENCY STABILITY	18
7.2.1 <i>E.U.T. Operation</i>	20
7.2.2 <i>Test Setup Diagram</i>	20
7.2.3 <i>Measurement Procedure and Data</i>	20
7.3 MODULATION CHARACTERISTICS	21
7.3.1 <i>E.U.T. Operation</i>	23
7.3.2 <i>Test Setup Diagram</i>	23
7.3.3 <i>Measurement Procedure and Data</i>	23
7.4 OCCUPIED BANDWIDTH.....	24
7.4.1 <i>E.U.T. Operation</i>	28
7.4.2 <i>Test Setup Diagram</i>	28
7.4.3 <i>Measurement Procedure and Data</i>	28
7.5 TRANSIENT FREQUENCY BEHAVIOUR.....	29
7.5.1 <i>E.U.T. Operation</i>	29
7.5.2 <i>Test Setup Diagram</i>	29
7.5.3 <i>Measurement Procedure and Data</i>	29
7.6 CONDUCTED SPURIOUS EMISSIONS	30
7.6.1 <i>E.U.T. Operation</i>	34
7.6.2 <i>Test Setup Diagram</i>	34
7.6.3 <i>Measurement Procedure and Data</i>	34
7.7 RADIATED SPURIOUS EMISSIONS	35
7.7.1 <i>E.U.T. Operation</i>	39
7.7.2 <i>Test Setup Diagram</i>	39



7.7.3 *Measurement Procedure and Data*.....40

8 PHOTOGRAPHS.....**41**

8.1 TEST SETUP.....41

8.2 EUT CONSTRUCTIONAL DETAILS41

9 APPENDIX.....**42**

9.1 APPENDIX FCC DATA. 42-88

4 General Information

4.1 Details of E.U.T.

Power supply:	Power Adapter Model: BS-24W1201500DUI Input: AC 100-240V, 50/60Hz, 0.6A Output: DC 12V, 1500mA Batteries Model: BF-A48 Lithium Ion Battery DC 7.4V, 3350mAh
Test voltage:	DC 7.4V
Sample Type:	Fixed device
Frequency Range:	400MHz to 470MHz
Modulation Type:	FM for Analog; 4FSK for Digital
Channel Separation:	12.5KHz/25KHz for FM, 12.5KHz for 4FSK
Number of Channels:	The equipment is able to operate on any designated channel within the specified frequency range.
Antenna Type:	External
Antenna Gain:	0dBi

4.2 Description of Support Units

The EUT has been tested independent unit.

4.3 Measurement Uncertainty

No.	Item	Measurement Uncertainty
1	Radio Frequency	$\pm 7.25 \times 10^{-8}$
2	Duty cycle	$\pm 0.37\%$
3	Occupied Bandwidth	$\pm 3\%$
4	RF conducted power	$\pm 0.75\text{dB}$
5	RF power density	$\pm 2.84\text{dB}$
6	Conducted Spurious emissions	$\pm 0.75\text{dB}$
7	RF Radiated power	$\pm 4.5\text{dB}$ (below 1GHz)
		$\pm 4.8\text{dB}$ (above 1GHz)
8	Radiated Spurious emission test	$\pm 4.5\text{dB}$ (Below 1GHz)
		$\pm 4.8\text{dB}$ (Above 1GHz)
9	Temperature test	$\pm 1^\circ\text{C}$
10	Humidity test	$\pm 3\%$
11	Supply voltages	$\pm 1.5\%$

4.4 Test Location

All tests were performed at:

SGS-CSTC Standards Technical Services Co., Ltd., Shenzhen Branch

No. 1 Workshop, M-10, Middle Section, Science & Technology Park, Shenzhen, Guangdong, China.
518057.

Tel: +86 755 2601 2053 Fax: +86 755 2671 0594

No tests were sub-contracted.

4.5 Test Facility

The test facility is recognized, certified, or accredited by the following organizations:

- **CNAS (No. CNAS L2929)**

CNAS has accredited SGS-CSTC Standards Technical Services Co., Ltd. Shenzhen Branch EMC Lab to ISO/IEC 17025:2005 General Requirements for the Competence of Testing and Calibration Laboratories (CNAS-CL01 Accreditation Criteria for the Competence of Testing and Calibration Laboratories) for the competence in the field of testing.

- **A2LA (Certificate No. 3816.01)**

SGS-CSTC Standards Technical Services Co., Ltd., Shenzhen EMC Laboratory is accredited by the American Association for Laboratory Accreditation(A2LA). Certificate No. 3816.01.

- **VCCI**

The 3m Fully-anechoic chamber for above 1GHz, 10m Semi-anechoic chamber for below 1GHz, Shielded Room for Mains Port Conducted Interference Measurement and Telecommunication Port Conducted Interference Measurement of SGS-CSTC Standards Technical Services Co., Ltd. have been registered in accordance with the Regulations for Voluntary Control Measures with Registration No.: G-20026, R-14188, C-12383 and T-11153 respectively.

- **FCC –Designation Number: CN1178**

SGS-CSTC Standards Technical Services Co., Ltd., Shenzhen EMC Laboratory has been recognized as an accredited testing laboratory.

Designation Number: CN1178. Test Firm Registration Number: 406779.

- **Innovation, Science and Economic Development Canada**

SGS-CSTC Standards Technical Services Co., Ltd., Shenzhen EMC Laboratory has been recognized by ISED as an accredited testing laboratory.

CAB identifier: CN0006.

IC#: 4620C.

4.6 Deviation from Standards

None

4.7 Abnormalities from Standard Conditions

None



5 Equipment List

RF conducted test					
Test Equipment	Manufacturer	Model No.	Inventory No.	Cal. Date	Cal. Due date
DC Power Supply	ZhaoXin	PS-3005D	SEM011-05	2018-09-25	2019-09-24
Spectrum Analyzer (20Hz-43GHz)	Rohde & Schwarz	FSU43	SEM004-08	2018-04-13	2019-04-12
Signal Generator (9kHz-40GHz)	KEYSIGHT	N5173B	SEM006-05	2018-09-27	2019-09-26
Measurement Software	JS Tonscend	JS1120-2 BT/WIFI V2.6	N/A	N/A	N/A
Coaxial Cable	SGS	N/A	SEM031-01	2018-07-12	2019-07-11
Attenuator	Weinschel Associates	WA41	SEM021-09	N/A	N/A
Audio Analyzer	Rohde & Schwarz	UPV	SEM008-03	2018-09-25	2019-09-24

Radiated Spurious Emissions					
Equipment	Manufacturer	Model No	Inventory No	Cal Date	Cal Due Date
3m Semi-Anechoic Chamber	AUDIX	N/A	SEM001-02	2017-05-02	2020-05-01
Measurement Software	AUDIX	e3 V8.2014-6-27	N/A	N/A	N/A
Coaxial Cable	SGS	N/A	SEM026-01	2018-07-11	2019-07-10
Spectrum Analyzer	Rohde & Schwarz	FSU43	SEM004-08	2018-03-31	2019-03-30
BiConiLog Antenna (26-3000MHz)	ETS-Lindgren	3142C	SEM003-01	2017-06-27	2020-06-26
Horn Antenna (1-18GHz)	Rohde & Schwarz	HF907	SEM003-07	2018-06-12	2019-06-14
Horn Antenna (15GHz-40GHz)	Schwarzbeck	BBHA 9170	SEM003-15	2017-10-17	2020-10-16
Pre-amplifier (0.1-1300MHz)	HP	8447D	SEM005-02	2018-09-25	2019-09-24
Low Noise Amplifier (100MHz-18GHz)	Black Diamond Series	BDLNA-0118-352810	SEM005-05	2018-09-26	2019-09-25
Pre-amplifier(18-26GHz)	Rohde & Schwarz	CH14-H052	SEM005-17	2018-04-02	2019-04-01
Pre-amplifier (26GHz-40GHz)	Compliance Directions Systems Inc.	PAP-2640-50	SEM005-08	2018-03-31	2019-03-30
DC Power Supply	Zhao Xin	RXN-305D	SEM011-02	2018-09-25	2019-09-24
Active Loop Antenna	ETS-Lindgren	6502	SEM003-08	2017-08-22	2020-08-21
Band filter	N/A	N/A	SEM023-01	N/A	N/A



RE in Chamber					
Test Equipment	Manufacturer	Model No.	Inventory No.	Cal. Date	Cal. Due date
3m Semi-Anechoic Chamber	ETS-LINDGREN	N/A	SEM001-01	2017-08-05	2020-08-04
MXE EMI Receiver (20Hz-8.4GHz)	Agilent Technologies	N9038A	SEM004-05	2018-09-25	2019-09-24
BiConiLog Antenna (26-3000MHz)	ETS-LINDGREN	3142C	SEM003-01	2017-06-27	2020-06-26
Pre-amplifier (0.1-1300MHz)	Agilent Technologies	8447D	SEM005-01	2018-04-02	2019-04-01
Measurement Software	AUDIX	e3 V8.2014-6-27	N/A	N/A	N/A
Coaxial Cable	SGS	N/A	SEM025-01	2018-07-12	2019-07-11

General used equipment					
Equipment	Manufacturer	Model No	Inventory No	Cal Date	Cal Due Date
Humidity/ Temperature Indicator	Shanghai Meteorological Industry Factory	ZJ1-2B	SEM002-03	2018-09-27	2019-09-26
Humidity/ Temperature Indicator	Shanghai Meteorological Industry Factory	ZJ1-2B	SEM002-04	2018-09-27	2019-09-26
Humidity/ Temperature Indicator	Mingle	N/A	SEM002-08	2018-09-27	2019-09-26
Barometer	Changchun Meteorological Industry Factory	DYM3	SEM002-01	2018-04-08	2019-04-07



6 Radio Spectrum Technical Requirement

6.1 Antenna Requirement

6.1.1 Test Requirement:

47 CFR Part 22.365, Part74.30, Part80.3, Part90.205

6.1.2 Conclusion

22.365 Requirement:

Licenses that own their antenna structures must not allow these antenna structures to become a hazard to air navigation. In general, antenna structure owners are responsible for registering antenna structures with the FCC if required by part 17 of this chapter, and for installing and maintaining any required marking and lighting. However, in the event of default of this responsibility by an antenna structure owner, each FCC permittee or licensee authorized to use an affected antenna structure will be held responsible by the FCC for ensuring that the antenna structure continues to meet the requirements of part 17 of this chapter. See §17.6 of this chapter.

(a) Marking and lighting. Antenna structures must be marked, lighted and maintained in accordance with part 17 of this chapter and all applicable rules and requirements of the Federal Aviation Administration.

(b) Maintenance contracts. Antenna structure owners (or licensees and permittees, in the event of default by an antenna structure owner) may enter into contracts with other entities to monitor and carry out necessary maintenance of antenna structures. Antenna structure owners (or licensees and permittees, in the event of default by an antenna structure owner) that make such contractual arrangements continue to be responsible for the maintenance of antenna structures in regard to air navigation safety.

74.30 Requirement:

The provisions of part 17 of the FCC rules (Construction, Marking, and Lighting of Antenna Structures) require certain antenna structures to be painted and/or lighted in accordance with the provisions of §§17.47 through 17.56 of the FCC rules.

80.3 Requirement:

(e) Part 17. This part contains requirements for the construction, marking and lighting of antenna towers, and the environmental notification process that must be completed before filing certain antenna structure registration applications.

90.205 Requirement:

(g) 421-430 MHz. Limitations on power and antenna heights are specified in §90.279.

(h) 450-470 MHz. (1) The maximum allowable station effective radiated power (ERP) is dependent upon the station's antenna HAAT and required service area and will be authorized in accordance with table 2. Applicants requesting an ERP in excess of that listed in table 2 must submit an engineering analysis based upon generally accepted engineering practices and standards that includes coverage contours to demonstrate that the requested station parameters will not produce coverage in excess of that which the applicant requires.

(2) Applications for stations where special circumstances exist that make it necessary to deviate from the ERP and antenna heights in Table 2 will be submitted to the frequency coordinator accompanied by a technical analysis, based upon generally accepted engineering practices and standards, that demonstrates that the requested station parameters will not produce a signal strength in excess of 39 dBu at any point along the edge of the requested service area. The coordinator may then recommend any ERP appropriate to meet this condition.



(3) An applicant for a station with a service area radius greater than 32 km (20 mi) must justify the requested service area radius, which may be authorized only in accordance with table 2, note 4. For base stations with service areas greater than 80 km, all operations 80 km or less from the base station will be on a primary basis and all operations outside of 80 km from the base station will be on a secondary basis and will be entitled to no protection from primary operations.

EUT Antenna:

Antenna location: Refer to Appendix(Internal photos)



7 Radio Spectrum Matter Test Results

7.1 RF Power Output

Test Requirement	47 CFR FCC Part2.1046 & FCC Part22.565 & FCC Part74.461 & FCC Part 80.215 & FCC Part90.205;
Test Method:	ANSI/TIA-603-E:2016; ANSI C63.4.2014; TIA-102 CCAA-A; TIA-102 CCAB-D; TIA-102 CCAA-D; ANSI C63.26-2015
Limit:	

For FCC Part 22.565:

(f) Mobile transmitters. The transmitter output power of mobile transmitters must not exceed 60 watts.

For FCC Part 74.461:

- (a) Transmitter power is the power at the transmitter output terminals and delivered to the antenna, antenna transmission line, or any other impedance-matched, radio frequency load. For the purpose of this Subpart, the transmitter power is the carrier power.
- (b) The authorized transmitter power for a remote pickup broadcast station shall be limited to that necessary for satisfactory service and, in any event, shall not be greater than 100 watts, except that a station to be operated aboard an aircraft shall normally be limited to a maximum authorized power of 15 watts. Specific authorization to operate stations on board aircraft with an output power exceeding 15 watts will be issued only upon an adequate engineering showing of need, and of the procedures that will be taken to avoid harmful interference to other licensees.

For FCC Part 80.215:

- (a) Transmitter power shown on the radio station authorization is the maximum power the licensee is authorized to use. Power is expressed in the following terms:
 - (1) For single sideband emission: Peak envelope power;
 - (2) For G3E emission: Carrier power;
 - (3) For PON and F3N emission: Mean power;
 - (4) For all emissions in the 1626.5-1646.5 MHz band: equivalent isotropic radiated power.
 - (5) For all other emissions: the carrier power multiplied by 1.67.
- (b) Coast station frequencies below 27500 kHz. The maximum power must not exceed the values listed below.
 - (1) Public coast stations, except Alaska:
 - (i) Radiotelegraphy:
 - 100-160 kHz—80kW
 - 405-525 kHz—40kW
 - 2035-2065 kHz—6.6kW
 - 4000-8000 kHz—10kW
 - 8000-9000 kHz—20kW
 - 12000-27500 kHz—30kW
 - (ii) Radiotelephony:
 - 2000-4000 kHz—day—800W
 - 2000-4000 kHz—night—400W
 - 4000-27500 kHz—10kW
 - (2) Private coast stations, except in Alaska: 1kW
 - (3) Coast stations in Alaska, public and private:



405-525 kHz—265W

1605-12000 kHz—150W

(c) Coast station frequencies above 27500 kHz. The maximum power must not exceed the values listed below.

(1) Coast stations:

156-162 MHz-50W^{1 2 13}

¹Maximum authorized power at the input terminals of the station antenna.

216-220 MHz²

²See paragraph (h) of this section.

(2) Marine utility stations:

156-162 MHz—10W

(d) Ship station frequencies below 27500 kHz. The maximum power must not exceed the values listed below:

(1) Radiotelegraphy: All ships—2kW³

³For passenger ships 5000 gross tons and over—8kW. For cable-repair ships operating on radiodetermination frequencies, 15 watts; see §80.375(b).

(2) Radiotelephony:

(i) All ships—Great Lakes and Inland Waters—150W

(ii) All ships—Open waters; 2000-4000 kHz—150W

2182 kHz—emergency, urgency, or safety ship to shore—400W⁴

⁴For passenger ships 5000 gross tons and over—1kW.

(iii) All ships—Open waters; 4000-27500 kHz—1.5kW⁵.

⁵For passenger ships 5,000 gross tons and over 3kW.

(3) Digital selective calling:

All ships 415-526.5 kHz—400 W

All ships 1605-4000 kHz—400 W

All ships 4000-27500 kHz—1.5 kW

(e) Ship stations frequencies above 27500 kHz. The maximum power must not exceed the values listed below.

(1) Ship stations 156-162 MHz—25W⁶

⁶Reducible to 1 watt or less, except for transmitters limited to public correspondence channels and used in an automated system.

(2) Ship stations 216-220 MHz—25W⁷

⁷[Reserved]

(3) On board stations 456-468 MHz—4W⁸

⁸Certification based on a carrier power of 4 watts with transmitter connected to a dummy load of matching impedance. The effective radiated power must not exceed 2 watts.

(4) Ship earth stations 1626.5-1646.5 MHz⁹

⁹See paragraph (k) of this section.

(5) Ship radar stations with F3N emission—200 mW

(6) EPIRB—121.500 and 243.00 MHz¹⁰

¹⁰See subpart V of this part.

(7) EPIRB—156.750 and 156.800 MHz¹⁰

(f) Fixed stations. The maximum power must not exceed the values + listed below.

(1) Maritime support (receiver test):

R3E and J3C emission—150W

F3E emission—50W

(2) Operational fixed: 72-76 MHz and above 162 MHz¹¹

¹¹See paragraph (l) of this section.



(3) Alaska—Private fixed:12

12The frequencies 156.375 MHz and 156.650 MHz are primarily intership frequencies. When authorized for coast stations on a secondary basis, the normal output power must not exceed 1 watt and the maximum output power must not exceed 10 watts.

10-200 kHz—650W

405-525 kHz—265W

1605-12000 kHz—150W

(4) Alaska—Public fixed:

405-525 kHz—1kW

1605-12000 kHz—1kW

(g) The carrier power of ship station radiotelephone transmitters, except portable transmitters, operating in the 156-162 MHz band must be at least 8 but not more than 25 watts. Transmitters that use 12 volt lead acid storage batteries as a primary power source must be measured with a primary voltage between 12.2 and 13.7 volts DC. Additionally, unless otherwise indicated, equipment in radiotelephone ship stations operating in the 156-162 MHz band must meet the following requirements:

(1) All transmitters and remote control units must be capable of reducing the carrier power to one watt or less;

(2) Except as indicated in (g)(4) of this section, all transmitters manufactured after January 21, 1987, or in use after January 21, 1997, must automatically reduce the carrier power to one watt or less when the transmitter is tuned to 156.375 MHz or 156.650 MHz, and must be provided with a manual override switch which when held by an operator will permit full carrier power operation on 156.375 MHz and 156.650 MHz;

(3) [Reserved]

(4) Hand-held portable transmitters are not required to comply with the automatic reduction of carrier power in (g)(2) of this section; and

(5) Transmitters dedicated for use on public correspondence duplex channels as additional equipment to a VHF ship station in the Great Lakes which meet all pertinent rules in this part are not required to reduce their carrier power to one watt.

(h) Coast stations in an AMTS may radiate as follows, subject to the condition that no harmful interference will be caused to television reception except that TV services authorized subsequent to the filing of the AMTS station application will not be protected.

(1) When located more than 169 kilometers (105 miles) from the antenna of a Channel 13 TV station and more than 129 kilometers (80 miles) from the antenna of a channel 10 station, the ERP of coast stations having an antenna height of 61 meters (200 feet) or less above ground must not exceed 1000 watts.

(2) Coast stations located less than 169 kilometers (105 miles) from a channel 13 TV station, or less than 129 kilometers (80 miles) from a channel 10 TV station, or when using a transmitting antenna height above ground greater than 61 meters (200 feet), must submit a plan to limit interference to TV reception, unless the station's predicted interference contour is fully encompassed by the composite interference contour of the system's existing stations, or the station's predicted interference contour extends the system's composite interference contour over water only (disregarding uninhabited islands). The plan must include:

(i) A description of the interference contour with identification of the method used to determine this contour; and

(ii) A statement concerning the number of residences within the interference contour. The interference contour includes only areas inside the TV grade B contour with the latter determined assuming maximum permissible TV antenna height and power for broadcast stations and the actual facility parameters for translators and low power TV stations. See part 73, subpart E of this chapter for further information on TV grade B contour determination.

(3) When located as described in paragraph (h)(2) of this section, the coast station (or stations affecting the same TV Grade B contour) will be authorized if the applicant's plan has limited the interference contour(s) to fewer than 100 residences or if the applicant:

(i) Shows that the proposed site is the only suitable location (which, at the application stage, requires a showing that the proposed site is especially well-suited to provide the proposed service);



- (ii) Develops a plan to control any interference caused to TV reception within the Grade B contour from its operations; and
- (iii) Agrees to make such adjustments in the TV receivers affected as may be necessary to eliminate interference caused by its operations.
- (4) The applicant must eliminate any interference caused by its operation to TV reception within the Grade B contour that might develop within 90 days of the time it is notified in writing by the Commission. If this interference is not removed within the 90-day period, operation of the coast station must be discontinued. The licensee is expected to help resolve all complaints of interference, whether inside or outside the Grade B contour.
- (5) The transmitter power, as measured at the input terminals to the station antenna, must be 50 watts or less.
- (i) A ship station must have a transmitter output not exceeding 25 watts and an ERP not exceeding 18 watts. The maximum transmitter output power is permitted to be increased to 50 watts under the following conditions:
 - (1) Increases exceeding 25 watts are made only by radio command from the controlling coast stations; and
 - (2) The application for an equipment authorization demonstrates that the transmitter output power is 25 watts or less when external radio commands are not present.
- (j) A ship installation with a transmitter output power exceeding 25 watts under the conditions of paragraph (i) of this section is exempted from the limitation of 18 watts ERP when operating in specific geographical areas identified in a plan for the use of higher power.
- (k) Within the 1626.5-1646.5 MHz band the maximum e.i.r.p by a ship earth station in any direction in the horizontal plane or in the direction of the space station must not exceed + 40 dB relative to one watt in any 4 kHz band in the main beam, except upon a satisfactory showing of need for greater power, in which case a maximum of + 55 dB relative to one watt may be authorized.
- (l) For operational fixed stations using frequencies in the 72-76 MHz band and for other classes of stations operating above 162.025 MHz, the transmitter power must be specified in the station authorization. Frequencies in the 72-76 MHz band are listed in §80.381. The operational requirements for 72-76 MHz are contained in subpart L of this part.
- (m) For radiodetermination transmitters using A1D, A2D, F1D, F2D, G1D and G2D emissions on 154.585 MHz, 159.480 MHz, 160.725 MHz, 160.785 MHz, 454.000 MHz and 459.000 MHz the mean output power of the unmodulated carrier must not exceed 25 watts.
- (n) For radiodetermination stations operating above 2400 MHz the output power must be as follows:
 - (1) For radar stations that use F3N emission the mean output power must not exceed 200 milliwatts;
 - (2) For search and rescue stations the output power must be at least 400 milliwatts peak e.i.r.p.
 - (3) For all other transponder stations the output power must not exceed 20 watts peak e.i.r.p. Licensees of non-selectable transponder coast stations operating in the 2920-3100 MHz and 9320-9500 MHz bands must notify in writing the USCG District Commander of any incremental increase of their station's output power above 5 watts peak e.i.r.p.

For FCC Part 90.205:

- (g) 421-430 MHz. Limitations on power and antenna heights are specified in §90.279.
- (h) 450-470 MHz. (1) The maximum allowable station effective radiated power (ERP) is dependent upon the station's antenna HAAT and required service area and will be authorized in accordance with table 2. Applicants requesting an ERP in excess of that listed in table 2 must submit an engineering analysis based upon generally accepted engineering practices and standards that includes coverage contours to demonstrate that the requested station parameters will not produce coverage in excess of that which the applicant requires.
- (2) Applications for stations where special circumstances exist that make it necessary to deviate from the ERP and antenna heights in Table 2 will be submitted to the frequency coordinator accompanied by a technical analysis, based upon generally accepted engineering practices and standards, that demonstrates that the requested station parameters will not produce a signal strength in excess of 39 dBu at any point along the edge of the requested service area. The coordinator may then recommend any ERP appropriate to meet this condition.



(3) An applicant for a station with a service area radius greater than 32 km (20 mi) must justify the requested service area radius, which may be authorized only in accordance with table 2, note 4. For base stations with service areas greater than 80 km, all operations 80 km or less from the base station will be on a primary basis and all operations outside of 80 km from the base station will be on a secondary basis and will be entitled to no protection from primary operations.

	Service area radius (km)									
	3	8	13	16	24	32	40	48 ⁴	64 ⁴	80 ⁴
Maximum ERP (w) ¹	1	28	178	² 500	² 500	² 500	500	² 500	² 500	² 500
Up to reference HAAT (m) ³	15	15	15	15	33	65	110	160	380	670

¹Maximum ERP indicated provides for a 39 dBu signal strength at the edge of the service area per FCC Report R-6602, Fig. 29 (See §73.699, Fig. 10 b).

²Maximum ERP of 500 watts allowed. Signal strength at the service area contour may be less than 39 dBu.

³When the actual antenna HAAT is greater than the reference HAAT, the allowable ERP will be reduced in accordance with the following equation: $ERP_{allow} = ERP_{max} \times (HAAT_{ref} / HAAT_{actual})^2$.

⁴Applications for this service area radius may be granted upon specific request with justification and must include a technical demonstration that the signal strength at the edge of the service area does not exceed 39 dBu.

(i) 470-512 MHz. Power and height limitations are specified in §§90.307 and 90.309.

7.1.1 E.U.T. Operation

Operating Environment:

Temperature: 24.8 °C Humidity: 49.3 % RH Atmospheric Pressure: 1020 mbar

Test mode: o: Tx mode, Keep the EUT in transmitting mode.

7.1.2 Test Setup Diagram

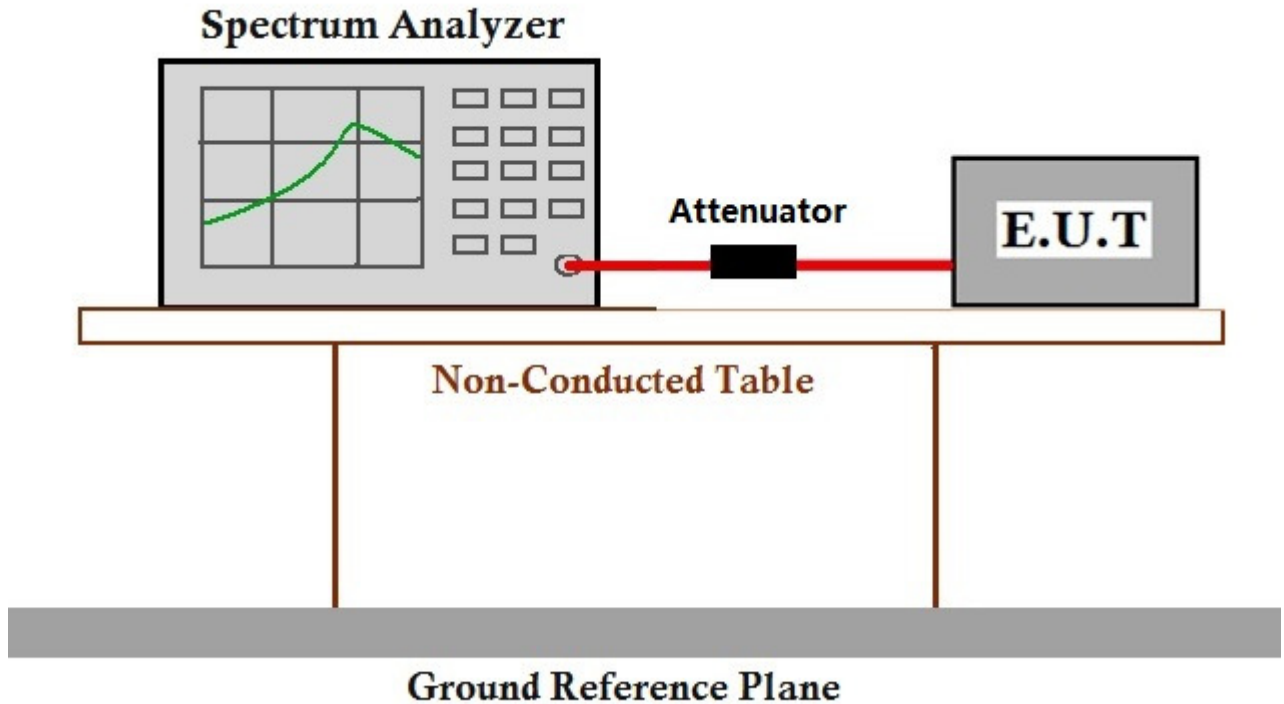

7.1.3 Measurement Procedure and Data

The detailed test data see: Appendix FCC data.



7.2 Frequency Stability

Test Requirement 47 CFR FCC Part2.1055 & FCC Part22.355 & FCC Part74.464 & FCC Part 80.209 & FCC Part90.213;
 Test Method: ANSI/TIA-603-E:2016; ANSI C63.4.2014; TIA-102 CCAA-A; TIA-102 CCAB-D; TIA-102 CCAA-D; ANSI C63.26-2015
 Limit:

For FCC Part 22.355:

Except as otherwise provided in this part, the carrier frequency of each transmitter in the Public Mobile Services must be maintained within the tolerances given in Table C-1 of this section.

Frequency range (MHz)	Base, fixed (ppm)	Mobile >3 watts (ppm)	Mobile ≤3 watts (ppm)
25 to 50	20.0	20.0	50.0
50 to 450	5.0	5.0	50.0
450 to 512	2.5	5.0	5.0
821 to 896	1.5	2.5	2.5
928 to 929	5.0	n/a	n/a
929 to 960	1.5	n/a	n/a
2110 to 2220	10.0	n/a	n/a

For FCC Part 74.464:

For operations on frequencies above 25 MHz using authorized bandwidths up to 30 kHz, the licensee of a remote pickup broadcast station or system shall maintain the operating frequency of each station in compliance with the frequency tolerance requirements of §90.213 of this chapter. For all other operations, the licensee of a remote pickup broadcast station or system shall maintain the operating frequency of each station in accordance with the following:

Frequency range	Tolerance (percent)	
	Base station	Mobile station
25 to 30 MHz:		
3 W or less	.002	.005
Over 3 W	.002	.002
30 to 300 MHz:		
3 W or less	.0005	.005
Over 3 W	.0005	.0005
300 to 500 MHz, all powers	.00025	.0005



For FCC Part 80.209(7):

Frequency bands and categories of stations	Tolerances ¹
(7) Band 400-466 MHz:	
(i) EPIRBs operating on 406-406.1 MHz	5.
(ii) On-board stations	5.
(iii) Radiolocation and telecommand stations.	5.

For FCC Part 90.213:

Frequency range (MHz)	Fixed and base stations	Mobile stations	
		Over 2 watts output power	2 watts or less output power
Below 25	^{1 2 3} 100	100	200
25-50	20	20	50
72-76	5		50
150-174	^{5 11} 5	⁶⁵	^{4 65} 50
216-220	1.0		1.0
220-222 ¹²	0.1	1.5	1.5
421-512	^{7 11 14} 2.5	⁸⁵	⁸⁵
806-809	¹⁴ 1.0	1.5	1.5
809-824	¹⁴ 1.5	2.5	2.5
851-854	1.0	1.5	1.5
854-869	1.5	2.5	2.5
896-901	¹⁴ 0.1	1.5	1.5
902-928	2.5	2.5	2.5
902-928 ¹³	2.5	2.5	2.5
929-930	1.5		
935-940	0.1	1.5	1.5
1427-1435	⁹ 300	300	300
Above 2450 ¹⁰			

This document is issued by the Company subject to its General Conditions of Service printed overleaf, available on request or accessible at <http://www.sgs.com/en/Terms-and-Conditions.aspx> and, for electronic format documents, subject to Terms and Conditions for Electronic Documents at <http://www.sgs.com/en/Terms-and-Conditions/Terms-e-Document.aspx>. Attention is drawn to the limitation of liability, indemnification and jurisdiction issues defined therein. Any holder of this document is advised that information contained hereon reflects the Company's findings at the time of its intervention only and within the limits of Client's instructions, if any. The Company's sole responsibility is to its Client and this document does not exonerate parties to a transaction from exercising all their rights and obligations under the transaction documents. This document cannot be reproduced except in full, without prior written approval of the Company. Any unauthorized alteration, forgery or falsification of the content or appearance of this document is unlawful and offenders may be prosecuted to the fullest extent of the law. Unless otherwise stated the results shown in this test report refer only to the sample(s) tested and such sample(s) are retained for 30 days only.

7.2.1 E.U.T. Operation

Operating Environment:

Temperature: 24.8 °C Humidity: 49.2 % RH Atmospheric Pressure: 1020 mbar

Test mode: o: Tx mode, Keep the EUT in transmitting mode.

7.2.2 Test Setup Diagram

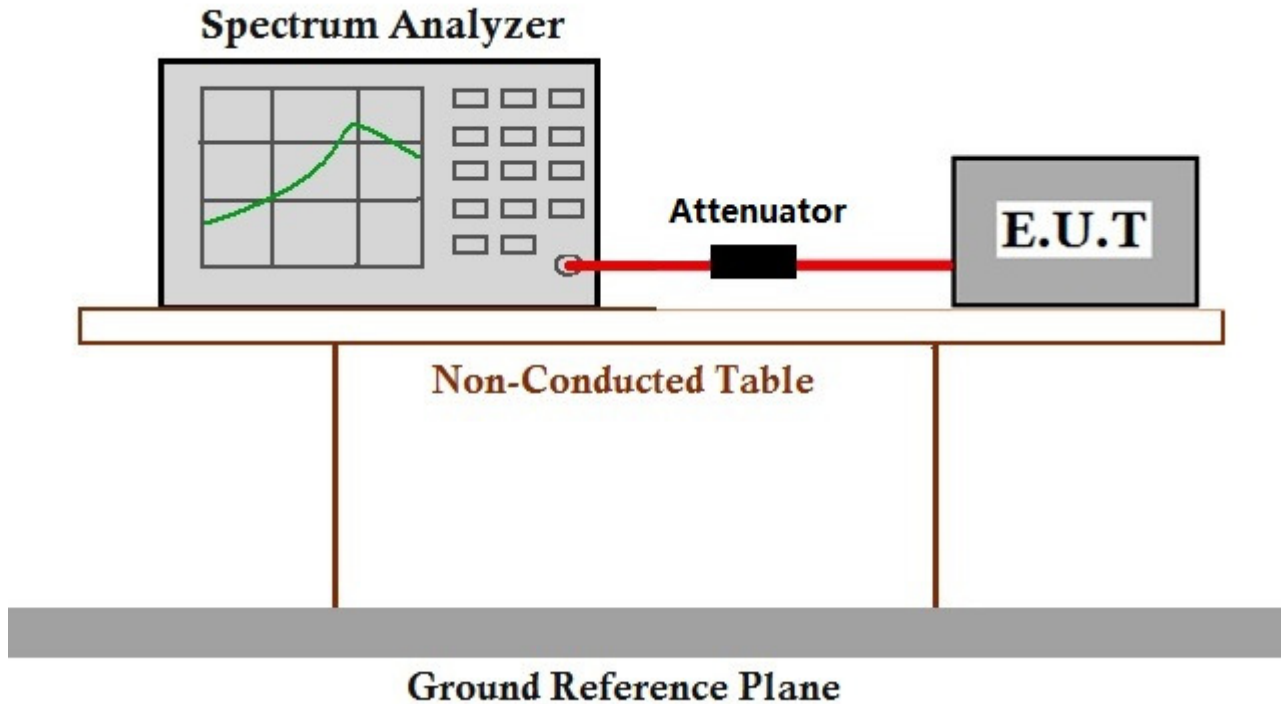

7.2.3 Measurement Procedure and Data

The detailed test data see: Appendix FCC data.



7.3 Modulation characteristics

Test Requirement	47 CFR FCC Part2.1047 & FCC Part74.463 & FCC Part 80.213 & FCC Part90.212;
Test Method:	ANSI/TIA-603-E:2016; ANSI C63.4.2014; TIA-102 CCAA-A; TIA-102 CCAB-D; TIA-102 CCAA-D; ANSI C63.26-2015
Limit:	

For FCC Part 74.463:

- (a) Each new remote pickup broadcast station authorized to operate with a power output in excess of 3 watts shall be equipped with a device which will automatically prevent modulation in excess of the limits set forth in this subpart.
- (b) If amplitude modulation is employed, modulation shall not exceed 100 percent on negative peaks.
- (c) If frequency modulation is employed, emission shall conform to the requirements specified in §74.462.

For FCC Part 80.213:

- (a) Transmitters must meet the following modulation requirements:
 - (1) When double sideband emission is used the peak modulation must be maintained between 75 and 100 percent;
 - (2) When phase or frequency modulation is used in the 156-162 MHz band the peak modulation must be maintained between 75 and 100 percent. A frequency deviation of ± 5 kHz is defined as 100 percent peak modulation; and
 - (3) In single sideband operation the upper sideband must be transmitted. Single sideband transmitters must automatically limit the peak envelope power to their authorized operating power and meet the requirements in §80.207(c).
- (b) Radiotelephone transmitters using A3E, F3E and G3E emission must have a modulation limiter to prevent any modulation over 100 percent. This requirement does not apply to survival craft transmitters, to transmitters that do not require a license or to transmitters whose output power does not exceed 3 watts.
- (c) Coast station transmitters operated in the 72.0-73.0 MHz and 75.4-76.0 MHz bands must be equipped with an audio low-pass filter. The filter must be installed between the modulation limiter and the modulated radio frequency stage. At frequencies between 3 kHz and 15 kHz it must have an attenuation greater than at 1 kHz by at least $40\log_{10}(f/3)$ dB where "f" is the frequency in kilohertz. At frequencies above 15 kHz the attenuation must be at least 28 dB greater than at 1 kHz.
- (d) Ship and coast station transmitters operating in the 156-162 MHz and 216-220 bands must be capable of proper operation with a frequency deviation that does not exceed ± 5 kHz when using any emission authorized by §80.207.
- (e) Coast station transmitters operated in the 156-162 MHz band must be equipped with an audio low-pass filter. The filter must be installed between the modulation limiter and the modulated radio frequency stage. At frequencies between 3 kHz and 20 kHz it must have an attenuation greater than at 1 kHz by at least $60\log_{10}(f/3)$ dB where "f" is the audio frequency in kilohertz. At frequencies above 20 kHz the attenuation must be at least 50 dB greater than at 1 kHz.
- (f) Radiodetermination ship stations operating on 154.585 MHz, 159.480 MHz, 160.725 MHz, 160.785 MHz, 454.000 MHz and 459.000 MHz must employ a duty cycle with a maximum transmission period of 60 seconds followed by a minimum quiescent period four times the duration of the transmission period.
- (g) Radar stations operating in the bands above 2.4 GHz may use any type of modulation consistent with the bandwidth requirements in §80.209(b).
- (h) Radar transponder coast stations using the 2900-3100 MHz or 9300-9500 MHz band must operate in a variable frequency mode and respond on their operating frequencies with a maximum error equivalent to 100 meters. Additionally, their response must be encoded with a Morse character starting with a dash. The duration of a Morse dot is defined as equal to the width of a space and 1/3 of the width of a Morse dash. The duration of the response code must not exceed 50 microseconds. The sensitivity of the stations must be



adjustable so that received signals below -10 dBm at the antenna will not activate the transponder. Antenna polarization must be horizontal when operating in the 9300-9500 MHz band and either horizontal or both horizontal and vertical when operating in the 2900-3100 MHz band. Racons using frequency agile transmitting techniques must include circuitry designed to reduce interference caused by triggering from radar antenna sidelobes.

(i) Variable frequency ship station transponders operating in the 2900-3100 MHz or 9300-9500 MHz band that are not used for search and rescue purposes must meet the following requirements:

(1) Non-selectable transponders must have the following characteristics:

(i) They must respond on all their frequencies with a maximum range error equivalent to 100 meters;

(ii) They must use a Morse encoding of "PS" (dot-dash-dash-dot, dot-dot-dot), meaning "You should not come any closer". The width of a Morse dot is defined as equal to the width of a space and $\frac{1}{3}$ of the width of a Morse dash;

(iii) When they employ swept frequency techniques they must not transmit on any frequency for more than 10 seconds in any 120 second period;

(iv) Any range offset of their response must occur during their pause on the fixed frequency;

(v) The duration of the response code must not exceed 50 microseconds;

(vi) The sensitivity of the stations must be adjustable so that received signals below -10 dBm at the antenna input will not activate the transponder;

(vii) Antenna polarization must be horizontal when operating in the 9300-9500 MHz band and either horizontal or both horizontal and vertical when operating in the 2900-3100 MHz band.

(viii) Transponders using frequency agile techniques must include circuitry designed to reduce interference caused by triggering from radar antenna sidelobes.

(2) Selectable transponders must be authorized under part 5 of the Commission's rules until standards for their use are developed.

(j) The transmitted signals of search and rescue transponders must cause to appear on a radar display a series of at least 20 equally spaced dots.

(k) The modulation requirements for EPIRB's are contained in subpart V.

For FCC Part 90.212:

(a) Analog scrambling techniques may be employed at any station authorized the use of A3E, F3E, or G3E emission, subject to the provision of paragraph (d) of this section.

(b) The use of digital scrambling techniques or digital voice modulation requires the specific authorization of F1E or G1E emission, and these emissions will only be authorized subject to the provisions of paragraph (d) of this section.

(c) The transmission of any non-voice information or data under the authorization of F1E or G1E emission is prohibited. However, stations authorized the use of F1E or G1E emission may also be authorized F1D, F2D, G1D or G2D emission for non-voice communication purposes, pursuant to §90.207(l).

(d) Station identification shall be transmitted in the unscrambled analog mode (clear voice) or Morse code in accordance with the provisions of §90.425. All digital encoding and digital modulation shall be disabled during station identification.

7.3.1 E.U.T. Operation

Operating Environment:

Temperature: 24.8 °C Humidity: 49.2 % RH Atmospheric Pressure: 1020 mbar

Test mode: o: Tx mode, Keep the EUT in transmitting mode.

7.3.2 Test Setup Diagram

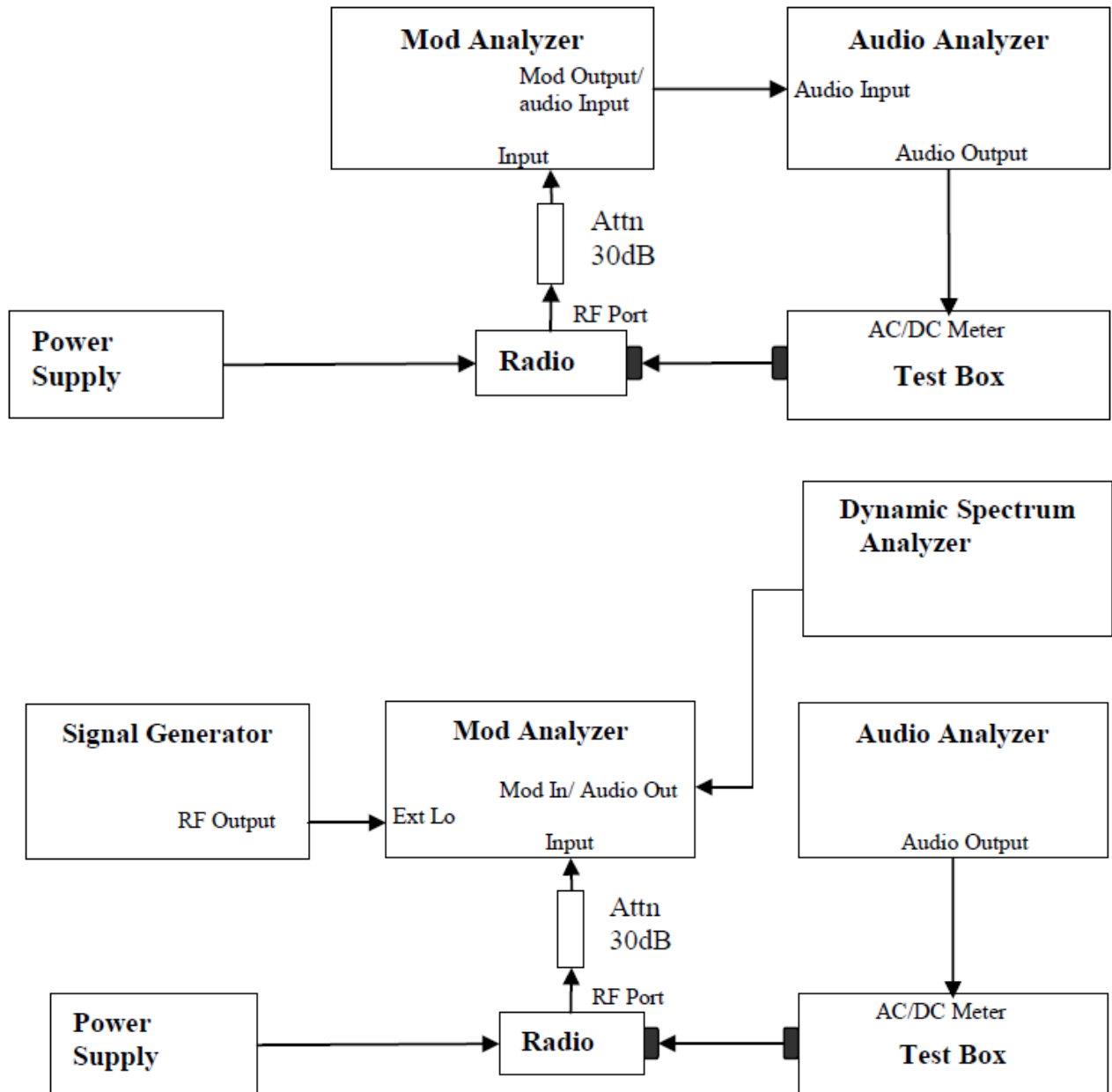

7.3.3 Measurement Procedure and Data

The detailed test data see: Appendix FCC data.



7.4 Occupied Bandwidth

Test Requirement 47 CFR FCC Part2.1049 & FCC Part22.359 & FCC Part74.462 & FCC Part 80.211 & FCC Part90.210;
Test Method: ANSI/TIA-603-E:2016; ANSI C63.4.2014; TIA-102 CCAA-A; TIA-102 CCAB-D; TIA-102 CCAA-D; ANSI C63.26-2015
Limit:

For FCC Part 22.359:

The rules in this section govern the spectral characteristics of emissions in the Public Mobile Services, except for the Air-Ground Radiotelephone Service (see §22.861, instead) and the Cellular Radiotelephone Service (see §22.917, instead).

(a) Out of band emissions. The power of any emission outside of the authorized operating frequency ranges must be attenuated below the transmitting power (P) by a factor of at least 43 + 10 log (P) dB.

(b) Measurement procedure. Compliance with these rules is based on the use of measurement instrumentation employing a resolution bandwidth of 30 kHz or more. In the 60 kHz bands immediately outside and adjacent to the authorized frequency range or channel, a resolution bandwidth of at least one percent of the emission bandwidth of the fundamental emission of the transmitter may be employed. A narrower resolution bandwidth is permitted in all cases to improve measurement accuracy provided the measured power is integrated over the full required measurement bandwidth (i.e., 30 kHz or 1 percent of emission bandwidth, as specified). The emission bandwidth is defined as the width of the signal between two points, one below the carrier center frequency and one above the carrier center frequency, outside of which all emissions are attenuated at least 26 dB below the transmitter power.

(c) Alternative out of band emission limit. Licensees in the Public Mobile Services may establish an alternative out of band emission limit to be used at specified frequencies (band edges) in specified geographical areas, in lieu of that set forth in this section, pursuant to a private contractual arrangement of all affected licensees and applicants. In this event, each party to such contract shall maintain a copy of the contract in their station files and disclose it to prospective assignees or transferees and, upon request, to the FCC.

(d) Interference caused by out of band emissions. If any emission from a transmitter operating in any of the Public Mobile Services results in interference to users of another radio service, the FCC may require a greater attenuation of that emission than specified in this section.

For FCC Part 74.462:

Frequencies	Authorized bandwidth (kHz)	Maximum frequency deviation ¹ (kHz)	Type of emission ²
MHz:			
25.87 to 26.03 26.07 to 26.47 152.8625 to 153.3575 ³	40 20 30/60		10 5 10 Frequencies 25.87 to 153.3575 MHz: A3E, F1E, F3E, F9E.
160.860 to 161.400	60		10
161.625 to 161.775	30		5
166.25 and 170.15 ⁴	12.5/25		5

This document is issued by the Company subject to its General Conditions of Service printed overleaf, available on request or accessible at <http://www.sgs.com/en/Terms-and-Conditions.aspx> and, for electronic format documents, subject to Terms and Conditions for Electronic Documents at <http://www.sgs.com/en/Terms-and-Conditions/Terms-e-Document.aspx>. Attention is drawn to the limitation of liability, indemnification and jurisdiction issues defined therein. Any holder of this document is advised that information contained hereon reflects the Company's findings at the time of its intervention only and within the limits of Client's instructions, if any. The Company's sole responsibility is to its Client and this document does not exonerate parties to a transaction from exercising all their rights and obligations under the transaction documents. This document cannot be reproduced except in full, without prior written approval of the Company. Any unauthorized alteration, forgery or falsification of the content or appearance of this document is unlawful and offenders may be prosecuted to the fullest extent of the law. Unless otherwise stated the results shown in this test report refer only to the sample(s) tested and such sample(s) are retained for 30 days only.



450.00625 to 450.025 450.98125 to 450.99375 455.00625 to 455.025 455.98125 to 455.99375 Up to 12.5 1.5	Frequencies 160.860 to 455.950 MHz: A1A, A1B, A1D, A1E, A2A, A2B, A2D, A2E, A3E, F1A, F1B, F1D, F1E, F2A, F2B, F2D, F2E, F3E, F9E		
450.03125 to 450.61875			
455.03125 to 455.61875	Up to 25		5
450.6375 to 450.8625			
455.6375 to 455.8625	25-50		10
450.900, 450.950			
455.900, 455.950	50-100		35

For FCC Part 80.211:

(e) The mean power of EPIRBs operating on 121.500 MHz, 243.000 MHz and 406.0-406.1 MHz must be as follows:

- (1) On any frequency removed from the assigned frequency by more than 50 percent, up to and including 100 percent of the authorized bandwidth: At least 25 dB;
- (2) On any frequency removed from the assigned frequency by more than 100 percent: at least 30 dB.

(f) The mean power when using emissions other than those in paragraphs (a), (b), (c) and (d) of this section:

- (1) On any frequency removed from the assigned frequency by more than 50 percent up to and including 100 percent of the authorized bandwidth: At least 25 dB;
- (2) On any frequency removed from the assigned frequency by more than 100 percent up to and including 250 percent of the authorized bandwidth: At least 35 dB; and
- (3) On any frequency removed from the assigned frequency by more than 250 percent of the authorized bandwidth: At least 43 plus $10\log_{10}$ (mean power in watts) dB.



For FCC Part 90.209:

(a) Each authorization issued to a station licensed under this part will show an emission designator representing the class of emission authorized. The designator will be prefixed by a specified necessary bandwidth. This number does not necessarily indicate the bandwidth occupied by the emission at any instant. In those cases where §2.202 of this chapter does not provide a formula for the computation of necessary bandwidth, the occupied bandwidth, as defined in part 2 of this chapter, may be used in lieu of the necessary bandwidth.

(b) The maximum authorized single channel bandwidth of emission corresponding to the type of emission specified in §90.207 is as follows:

(1) For A1A or A1B emissions, the maximum authorized bandwidth is 0.25 kHz. The maximum authorized bandwidth for type A3E emission is 8 kHz.

(2) For operations below 25 MHz utilizing J3E emission, the bandwidth occupied by the emission shall not exceed 3000 Hz. The assigned frequency will be specified in the authorization. The authorized carrier frequency will be 1400 Hz lower in frequency than the assigned frequency. Only upper sideband emission may be used. In the case of regularly available double sideband radiotelephone channels, an assigned frequency for J3E emissions is available either 1600 Hz below or 1400 Hz above the double sideband radiotelephone assigned frequency.

(3) For all other types of emissions, the maximum authorized bandwidth shall not be more than that normally authorized for voice operations.

(4) Where a frequency is assigned exclusively to a single licensee, more than a single emission may be used within the authorized bandwidth. In such cases, the frequency stability requirements of §90.213 must be met for each emission.

(5) Unless specified elsewhere, channel spacings and bandwidths that will be authorized in the following frequency bands are given in the following table.

band (MHz)	Channel spacing (kHz)	Authorized bandwidth (kHz)
Below 25 ²		
25-50	20	20
72-76	20	20
150-174	17.5	¹ 320/11.25/6
216-220 ⁵	6.25	20/11.25/6
220-222	5	4
406-512 ²	16.25	¹³⁶ 20/11.25/6
806-809/851-854	12.5	20
809-824/854-869	25	⁶ 20
896-901/935-940	12.5	13.6
902-928 ⁴		
929-930	25	20
1427-1432 ⁵	12.5	12.5
³ 2450-2483.5 ²		
Above 2500 ²		



¹For stations authorized on or after August 18, 1995.

²Bandwidths for radiolocation stations in the 420-450 MHz band and for stations operating in bands subject to this footnote will be reviewed and authorized on a case-by-case basis.

³Operations using equipment designed to operate with a 25 kHz channel bandwidth will be authorized a 20 kHz bandwidth. Operations using equipment designed to operate with a 12.5 kHz channel bandwidth will be authorized a 11.25 kHz bandwidth. Operations using equipment designed to operate with a 6.25 kHz channel bandwidth will be authorized a 6 kHz bandwidth. All stations must operate on channels with a bandwidth of 12.5 kHz or less beginning January 1, 2013, unless the operations meet the efficiency standard of §90.203(j)(3).

⁴The maximum authorized bandwidth shall be 12 MHz for non-multilateration LMS operations in the band 909.75-921.75 MHz and 2 MHz in the band 902.00-904.00 MHz. The maximum authorized bandwidth for multilateration LMS operations shall be 5.75 MHz in the 904.00-909.75 MHz band; 2 MHz in the 919.75-921.75 MHz band; 5.75 MHz in the 921.75-927.25 MHz band and its associated 927.25-927.50 MHz narrowband forward link; and 8.00 MHz if the 919.75-921.75 MHz and 921.75-927.25 MHz bands and their associated 927.25-927.50 MHz and 927.50-927.75 MHz narrowband forward links are aggregated.

⁵See §90.259.

⁶Operations using equipment designed to operate with a 25 kHz channel bandwidth may be authorized up to a 22 kHz bandwidth if the equipment meets the Adjacent Channel Power limits of §90.221.

(6)(i) Beginning January 1, 2011, no new applications for the 150-174 MHz and/or 421-512 MHz bands will be acceptable for filing if the applicant utilizes channels with an authorized bandwidth exceeding 11.25 kHz, unless specified elsewhere or the operations meet the efficiency standards of §90.203(j)(3).

(ii) Beginning January 1, 2011, no modification applications for stations in the 150-174 MHz and/or 421-512 MHz bands that increase the station's authorized interference contour, will be acceptable for filing if the applicant utilizes channels with an authorized bandwidth exceeding 11.25 kHz, unless specified elsewhere or the operations meet the efficiency standards of §90.203(j)(3). See §90.187(b)(2)(iii) and (iv) for interference contour designations and calculations. Applications submitted pursuant to this paragraph must comply with frequency coordination requirements of §90.175.

(7) Economic Area (EA)-based licensees in frequencies 817-824/862-869 MHz (813.5-824/858.5-869 MHz in the counties listed in §90.614(c)) may exceed the standard channel spacing and authorized bandwidth listed in paragraph (b)(5) of this section in any National Public Safety Planning Advisory Committee Region when all 800 MHz public safety licensees in the Region have completed band reconfiguration consistent with this part. In any National Public Safety Planning Advisory Committee Region where the 800 MHz band reconfiguration is incomplete, EA-based licensees in frequencies 817-821/862-866 MHz (813.5-821/858.5-866 MHz in the counties listed in §90.614(c)) may exceed the standard channel spacing and authorized bandwidth listed in paragraph (b)(5) of this section. Upon all 800 MHz public safety licensees in a National Public Safety Planning Advisory Committee Region completing band reconfiguration, EA-based 800 MHz SMR licensees in the 821-824/866-869 MHz band may exceed the channel spacing and authorized bandwidth in paragraph (b)(5) of this section. Licensees authorized to exceed the standard channel spacing and authorized bandwidth under this paragraph must provide at least 30 days written notice prior to initiating such service in the bands listed herein to every 800 MHz public safety licensee with a base station in an affected National Public Safety Planning Advisory Committee Region, and every 800 MHz public safety licensee with a base station within 113 kilometers (70 miles) of an affected National Public Safety Planning Advisory Committee Region. Such notice shall include the estimated date upon which the EA-based 800 MHz SMR licensee intends to begin operations that exceed the channel spacing and authorized bandwidth in paragraph (b)(5) of this section.

7.4.1 E.U.T. Operation

Operating Environment:

Temperature: 24.8 °C Humidity: 49.2 % RH Atmospheric Pressure: 1020 mbar

Test mode: o: Tx mode, Keep the EUT in transmitting mode.

7.4.2 Test Setup Diagram

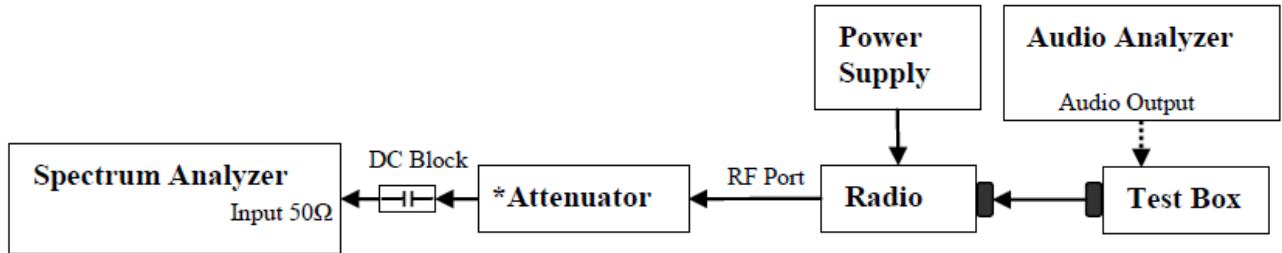

7.4.3 Measurement Procedure and Data

The detailed test data see: Appendix FCC data.

7.5 Transient Frequency Behaviour

Test Requirement 47 CFR FCC Part 90.214
 Test Method: ANSI/TIA-603-E:2016; ANSI C63.4:2014; TIA-102 CCAA-A; TIA-102 CCAB-D; TIA-102 CCAA-D; ANSI C63.26-2015

Limit:

Time intervals ^{1 2}	Maximum frequency difference ³	All equipment	
		150 to 174 MHz	421 to 512 MHz
Transient Frequency Behavior for Equipment Designed to Operate on 25 kHz Channels			
t ₁ ⁴	±25.0 kHz	5.0 ms	10.0 ms
t ₂	±12.5 kHz	20.0 ms	25.0 ms
t ₃ ⁴	±25.0 kHz	5.0 ms	10.0 ms
Transient Frequency Behavior for Equipment Designed to Operate on 12.5 kHz Channels			
t ₁ ⁴	±12.5 kHz	5.0 ms	10.0 ms
t ₂	±6.25 kHz	20.0 ms	25.0 ms
t ₃ ⁴	±12.5 kHz	5.0 ms	10.0 ms
Transient Frequency Behavior for Equipment Designed to Operate on 6.25 kHz Channels			
t ₁ ⁴	±6.25 kHz	5.0 ms	10.0 ms
t ₂	±3.125 kHz	20.0 ms	25.0 ms
t ₃ ⁴	±6.25 kHz	5.0 ms	10.0 ms

7.5.1 E.U.T. Operation

Operating Environment:

Temperature: 23.1 °C Humidity: 48 % RH Atmospheric Pressure: 1020 mbar

Test mode: o: Tx mode, Keep the EUT in transmitting mode.

7.5.2 Test Setup Diagram

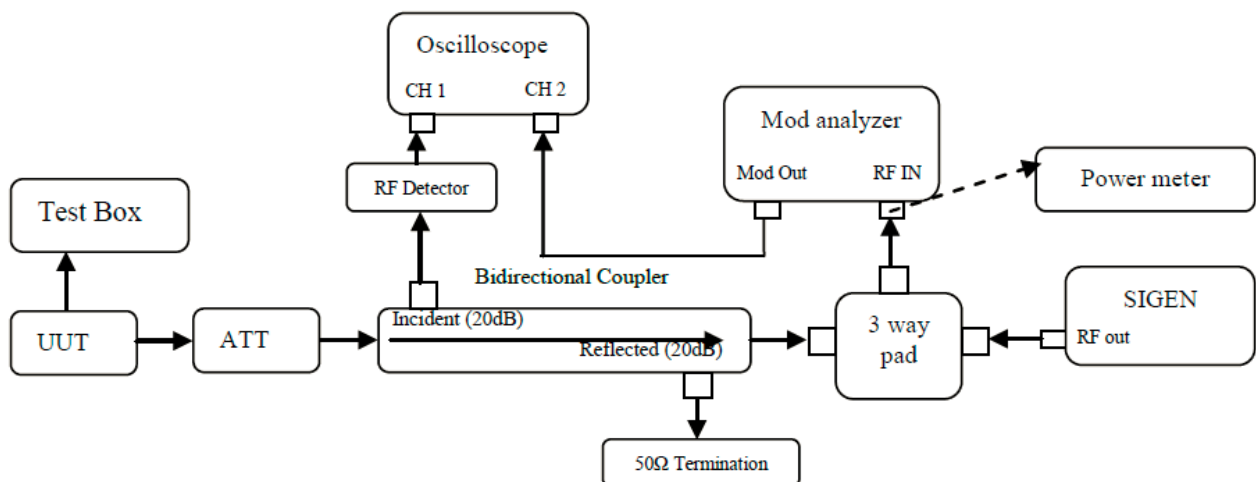

7.5.3 Measurement Procedure and Data

The detailed test data see: Appendix FCC data.



7.6 Conducted Spurious Emissions

Test Requirement 47 CFR FCC Part2.1051 & FCC Part22.359 & FCC Part74.462 & FCC Part 80.211 & FCC Part90.210;
Test Method: ANSI/TIA-603-E:2016; ANSI C63.4:2014; TIA-102 CCAA-A; TIA-102 CCAB-D; TIA-102 CCAA-D; ANSI C63.26-2015
Limit:

For FCC Part 22.359:

The rules in this section govern the spectral characteristics of emissions in the Public Mobile Services, except for the Air-Ground Radiotelephone Service (see §22.861, instead) and the Cellular Radiotelephone Service (see §22.917, instead).

(a) Out of band emissions. The power of any emission outside of the authorized operating frequency ranges must be attenuated below the transmitting power (P) by a factor of at least 43 + 10 log (P) dB.

(b) Measurement procedure. Compliance with these rules is based on the use of measurement instrumentation employing a resolution bandwidth of 30 kHz or more. In the 60 kHz bands immediately outside and adjacent to the authorized frequency range or channel, a resolution bandwidth of at least one percent of the emission bandwidth of the fundamental emission of the transmitter may be employed. A narrower resolution bandwidth is permitted in all cases to improve measurement accuracy provided the measured power is integrated over the full required measurement bandwidth (i.e., 30 kHz or 1 percent of emission bandwidth, as specified). The emission bandwidth is defined as the width of the signal between two points, one below the carrier center frequency and one above the carrier center frequency, outside of which all emissions are attenuated at least 26 dB below the transmitter power.

(c) Alternative out of band emission limit. Licensees in the Public Mobile Services may establish an alternative out of band emission limit to be used at specified frequencies (band edges) in specified geographical areas, in lieu of that set forth in this section, pursuant to a private contractual arrangement of all affected licensees and applicants. In this event, each party to such contract shall maintain a copy of the contract in their station files and disclose it to prospective assignees or transferees and, upon request, to the FCC.

(d) Interference caused by out of band emissions. If any emission from a transmitter operating in any of the Public Mobile Services results in interference to users of another radio service, the FCC may require a greater attenuation of that emission than specified in this section.

For FCC Part 74.462:

Frequencies	Authorized bandwidth (kHz)	Maximum frequency deviation ¹ (kHz)	Type of emission ²
MHz:			
25.87 to 26.03 26.07 to 26.47 152.8625 to 153.3575 ³	40 20 30/60	10 5 5/10	Frequencies 25.87 to 153.3575 MHz: A3E, F1E, F3E, F9E.
160.860 to 161.400	60	10	
161.625 to 161.775	30	5	
166.25 and 170.154	12.5/25	5	
450.00625 to 450.025 450.98125 to	Frequencies 160.860 to 455.950 MHz: A1A, A1B, A1D, A1E, A2A, A2B, A2D, A2E,		

This document is issued by the Company subject to its General Conditions of Service printed overleaf, available on request or accessible at <http://www.sgs.com/en/Terms-and-Conditions.aspx> and, for electronic format documents, subject to Terms and Conditions for Electronic Documents at <http://www.sgs.com/en/Terms-and-Conditions/Terms-e-Document.aspx>. Attention is drawn to the limitation of liability, indemnification and jurisdiction issues defined therein. Any holder of this document is advised that information contained hereon reflects the Company's findings at the time of its intervention only and within the limits of Client's instructions, if any. The Company's sole responsibility is to its Client and this document does not exonerate parties to a transaction from exercising all their rights and obligations under the transaction documents. This document cannot be reproduced except in full, without prior written approval of the Company. Any unauthorized alteration, forgery or falsification of the content or appearance of this document is unlawful and offenders may be prosecuted to the fullest extent of the law. Unless otherwise stated the results shown in this test report refer only to the sample(s) tested and such sample(s) are retained for 30 days only.



450.99375 455.00625 to 455.025 455.98125 to 455.99375 Up to 12.5 1.5	A3E, F1A, F1B, F1D, F1E, F2A, F2B, F2D, F2E, F3E, F9E		
450.03125 to 450.61875			
455.03125 to 455.61875	Up to 25		5
450.6375 to 450.8625			
455.6375 to 455.8625	25-50		10
450.900, 450.950			
455.900, 455.950	50-100		35

For FCC Part 80.211:

(e) The mean power of EPIRBs operating on 121.500 MHz, 243.000 MHz and 406.0-406.1 MHz must be as follows:

- (1) On any frequency removed from the assigned frequency by more than 50 percent, up to and including 100 percent of the authorized bandwidth: At least 25 dB;
- (2) On any frequency removed from the assigned frequency by more than 100 percent: at least 30 dB.

(f) The mean power when using emissions other than those in paragraphs (a), (b), (c) and (d) of this section:

- (1) On any frequency removed from the assigned frequency by more than 50 percent up to and including 100 percent of the authorized bandwidth: At least 25 dB;
- (2) On any frequency removed from the assigned frequency by more than 100 percent up to and including 250 percent of the authorized bandwidth: At least 35 dB; and
- (3) On any frequency removed from the assigned frequency by more than 250 percent of the authorized bandwidth: At least 43 plus $10\log_{10}$ (mean power in watts) dB.



For FCC Part 90.210:

Frequency band (MHz)	Mask for equipment with audio low pass filter	Mask for equipment without audio low pass filter
Below 25 ¹	A or B	A or C
25-50	B	C
72-76	B	C
150-174 ²	B, D, or E	C, D or E
150 paging only	B	C
220-222	F	F
421-512 ^{2 5}	B, D, or E	C, D, or E
450 paging only	B	G
806-809/851-854 ⁶	B	H
809-824/854-869 ^{3 5}	B	G
896-901/935-940	I	J
902-928	K	K
929-930	B	G
4940-4990 MHz	L or M	L or M
5850-5925 ⁴		
All other bands	B	C

(b) Emission Mask B. For transmitters that are equipped with an audio low-pass filter, the power of any emission must be attenuated below the unmodulated carrier power (P) as follows:

(1) On any frequency removed from the assigned frequency by more than 50 percent, but not more than 100 percent of the authorized bandwidth: At least 25 dB.

(2) On any frequency removed from the assigned frequency by more than 100 percent, but not more than 250 percent of the authorized bandwidth: At least 35 dB.

(3) On any frequency removed from the assigned frequency by more than 250 percent of the authorized bandwidth: At least $43 + 10 \log (P)$ dB.

(c) Emission Mask C. For transmitters that are not equipped with an audio low-pass filter, the power of any emission must be attenuated below the unmodulated carrier output power (P) as follows:

(1) On any frequency removed from the center of the authorized bandwidth by a displacement frequency (fd in kHz) of more than 5 kHz, but not more than 10 kHz: At least $83 \log (fd/5)$ dB;

(2) On any frequency removed from the center of the authorized bandwidth by a displacement frequency (fd in kHz) of more than 10 kHz, but not more than 250 percent of the authorized bandwidth: At least $29 \log (fd^2/11)$ dB or 50 dB, whichever is the lesser attenuation;

(3) On any frequency removed from the center of the authorized bandwidth by more than 250 percent of the authorized bandwidth: At least $43 + 10 \log (P)$ dB.

(4) In the 1427-1432 MHz band, licensees are encouraged to take all reasonable steps to ensure that unwanted emissions power does not exceed the following levels in the 1400-1427 MHz band:

(i) For stations of point-to-point systems in the fixed service: -45 dBW/27 MHz.

(ii) For stations in the mobile service: -60 dBW/27 MHz.



(d) Emission Mask D—12.5 kHz channel bandwidth equipment. For transmitters designed to operate with a 12.5 kHz channel bandwidth, any emission must be attenuated below the power (P) of the highest emission contained within the authorized bandwidth as follows:

- (1) On any frequency from the center of the authorized bandwidth f_0 to 5.625 kHz removed from f_0 : Zero dB.
- (2) On any frequency removed from the center of the authorized bandwidth by a displacement frequency (f_d in kHz) of more than 5.625 kHz but no more than 12.5 kHz: At least $7.27(f_d - 2.88 \text{ kHz})$ dB.
- (3) On any frequency removed from the center of the authorized bandwidth by a displacement frequency (f_d in kHz) of more than 12.5 kHz: At least $50 + 10 \log(P)$ dB or 70 dB, whichever is the lesser attenuation.
- (4) The reference level for showing compliance with the emission mask shall be established using a resolution bandwidth sufficiently wide (usually two or three times the channel bandwidth) to capture the true peak emission of the equipment under test. In order to show compliance with the emission mask up to and including 50 kHz removed from the edge of the authorized bandwidth, adjust the resolution bandwidth to 100 Hz with the measuring instrument in a peak hold mode. A sufficient number of sweeps must be measured to insure that the emission profile is developed. If video filtering is used, its bandwidth must not be less than the instrument resolution bandwidth. For emissions beyond 50 kHz from the edge of the authorized bandwidth, see paragraph (o) of this section. If it can be shown that use of the above instrumentation settings do not accurately represent the true interference potential of the equipment under test, an alternate procedure may be used provided prior Commission approval is obtained.

(e) Emission Mask E—6.25 kHz or less channel bandwidth equipment. For transmitters designed to operate with a 6.25 kHz or less bandwidth, any emission must be attenuated below the power (P) of the highest emission contained within the authorized bandwidth as follows:

- (1) On any frequency from the center of the authorized bandwidth f_0 to 3.0 kHz removed from f_0 : Zero dB.
- (2) On any frequency removed from the center of the authorized bandwidth by a displacement frequency (f_d in kHz) of more than 3.0 kHz but no more than 4.6 kHz: At least $30 + 16.67(f_d - 3 \text{ kHz})$ or $55 + 10 \log(P)$ or 65 dB, whichever is the lesser attenuation.
- (3) On any frequency removed from the center of the authorized bandwidth by more than 4.6 kHz: At least $55 + 10 \log(P)$ or 65 dB, whichever is the lesser attenuation.
- (4) The reference level for showing compliance with the emission mask shall be established using a resolution bandwidth sufficiently wide (usually two or three times the channel bandwidth) to capture the true peak emission of the equipment under test. In order to show compliance with the emission mask up to and including 50 kHz removed from the edge of the authorized bandwidth, adjust the resolution bandwidth to 100 Hz with the measuring instrument in a peak hold mode. A sufficient number of sweeps must be measured to insure that the emission profile is developed. If video filtering is used, its bandwidth must not be less than the instrument resolution bandwidth. For emissions beyond 50 kHz from the edge of the authorized bandwidth, see paragraph (o) of this section. If it can be shown that use of the above instrumentation settings do not accurately represent the true interference potential of the equipment under test, an alternate procedure may be used provided prior Commission approval is obtained.

7.6.1 E.U.T. Operation

Operating Environment:

Temperature: 18.7 °C Humidity: 41.1 % RH Atmospheric Pressure: 1015 mbar

Test mode: o: Tx mode, Keep the EUT in transmitting mode.

7.6.2 Test Setup Diagram

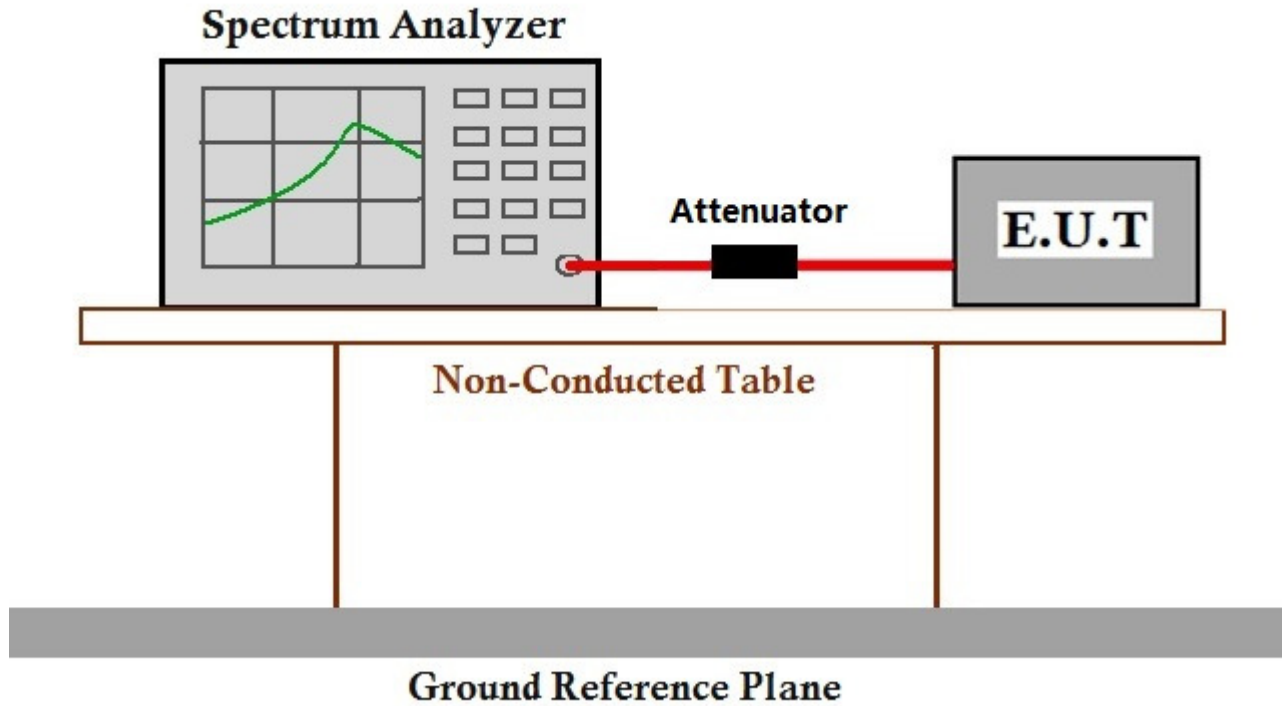

7.6.3 Measurement Procedure and Data

The detailed test data see: Appendix FCC data.



7.7 Radiated Spurious Emissions

Test Requirement 47 CFR FCC Part2.1051 & FCC Part22.359 & FCC Part74.462 & FCC Part 80.211 & FCC Part90.210;
Test Method: ANSI/TIA-603-E:2016; ANSI C63.4:2014; TIA-102 CCAA-A; TIA-102 CCAB-D; TIA-102 CCAA-D; ANSI C63.26-2015
Measurement Distance: 3m
Limit:

For FCC Part 22.359:

The rules in this section govern the spectral characteristics of emissions in the Public Mobile Services, except for the Air-Ground Radiotelephone Service (see §22.861, instead) and the Cellular Radiotelephone Service (see §22.917, instead).

(a) Out of band emissions. The power of any emission outside of the authorized operating frequency ranges must be attenuated below the transmitting power (P) by a factor of at least 43 + 10 log (P) dB.

(b) Measurement procedure. Compliance with these rules is based on the use of measurement instrumentation employing a resolution bandwidth of 30 kHz or more. In the 60 kHz bands immediately outside and adjacent to the authorized frequency range or channel, a resolution bandwidth of at least one percent of the emission bandwidth of the fundamental emission of the transmitter may be employed. A narrower resolution bandwidth is permitted in all cases to improve measurement accuracy provided the measured power is integrated over the full required measurement bandwidth (i.e., 30 kHz or 1 percent of emission bandwidth, as specified). The emission bandwidth is defined as the width of the signal between two points, one below the carrier center frequency and one above the carrier center frequency, outside of which all emissions are attenuated at least 26 dB below the transmitter power.

(c) Alternative out of band emission limit. Licensees in the Public Mobile Services may establish an alternative out of band emission limit to be used at specified frequencies (band edges) in specified geographical areas, in lieu of that set forth in this section, pursuant to a private contractual arrangement of all affected licensees and applicants. In this event, each party to such contract shall maintain a copy of the contract in their station files and disclose it to prospective assignees or transferees and, upon request, to the FCC.

(d) Interference caused by out of band emissions. If any emission from a transmitter operating in any of the Public Mobile Services results in interference to users of another radio service, the FCC may require a greater attenuation of that emission than specified in this section.

For FCC Part 74.462:

Frequencies	Authorized bandwidth (kHz)	Maximum frequency deviation ¹ (kHz)	Type of emission ²
MHz:			
25.87 to 26.03 26.07 to 26.47 152.8625 to 153.3575 ³	40 20 30/60	10 5 5/10	Frequencies 25.87 to 153.3575 MHz: A3E, F1E, F3E, F9E.
160.860 to 161.400	60	10	
161.625 to 161.775	30	5	
166.25 and 170.154	12.5/25	5	
450.00625 to 450.025	Frequencies 160.860 to 455.950 MHz: A1A, A1B, A1D,		

This document is issued by the Company subject to its General Conditions of Service printed overleaf, available on request or accessible at <http://www.sgs.com/en/Terms-and-Conditions.aspx> and, for electronic format documents, subject to Terms and Conditions for Electronic Documents at <http://www.sgs.com/en/Terms-and-Conditions/Terms-e-Documents.aspx>. Attention is drawn to the limitation of liability, indemnification and jurisdiction issues defined therein. Any holder of this document is advised that information contained hereon reflects the Company's findings at the time of its intervention only and within the limits of Client's instructions, if any. The Company's sole responsibility is to its Client and this document does not exonerate parties to a transaction from exercising all their rights and obligations under the transaction documents. This document cannot be reproduced except in full, without prior written approval of the Company. Any unauthorized alteration, forgery or falsification of the content or appearance of this document is unlawful and offenders may be prosecuted to the fullest extent of the law. Unless otherwise stated the results shown in this test report refer only to the sample(s) tested and such sample(s) are retained for 30 days only.



450.98125 to 450.99375 455.00625 to 455.025 455.98125 to 455.99375 Up to 12.5 1.5	A1E, A2A, A2B, A2D, A2E, A3E, F1A, F1B, F1D, F1E, F2A, F2B, F2D, F2E, F3E, F9E		
450.03125 to 450.61875			
455.03125 to 455.61875	Up to 25		5
450.6375 to 450.8625			
455.6375 to 455.8625	25-50		10
450.900, 450.950			
455.900, 455.950	50-100		35

For FCC Part 80.211:

(e) The mean power of EPIRBs operating on 121.500 MHz, 243.000 MHz and 406.0-406.1 MHz must be as follows:

- (1) On any frequency removed from the assigned frequency by more than 50 percent, up to and including 100 percent of the authorized bandwidth: At least 25 dB;
- (2) On any frequency removed from the assigned frequency by more than 100 percent: at least 30 dB.

(f) The mean power when using emissions other than those in paragraphs (a), (b), (c) and (d) of this section:

- (1) On any frequency removed from the assigned frequency by more than 50 percent up to and including 100 percent of the authorized bandwidth: At least 25 dB;
- (2) On any frequency removed from the assigned frequency by more than 100 percent up to and including 250 percent of the authorized bandwidth: At least 35 dB; and
- (3) On any frequency removed from the assigned frequency by more than 250 percent of the authorized bandwidth: At least 43 plus $10\log_{10}$ (mean power in watts) dB.



For FCC Part 90.210:

Frequency band (MHz)	Mask for equipment with audio low pass filter	Mask for equipment without audio low pass filter
Below 25 ¹	A or B	A or C
25-50	B	C
72-76	B	C
150-174 ²	B, D, or E	C, D or E
150 paging only	B	C
220-222	F	F
421-512 ^{2 5}	B, D, or E	C, D, or E
450 paging only	B	G
806-809/851-854 ⁶	B	H
809-824/854-869 ^{3 5}	B	G
896-901/935-940	I	J
902-928	K	K
929-930	B	G
4940-4990 MHz	L or M	L or M
5850-5925 ⁴		
All other bands	B	C

(b) Emission Mask B. For transmitters that are equipped with an audio low-pass filter, the power of any emission must be attenuated below the unmodulated carrier power (P) as follows:

(1) On any frequency removed from the assigned frequency by more than 50 percent, but not more than 100 percent of the authorized bandwidth: At least 25 dB.

(2) On any frequency removed from the assigned frequency by more than 100 percent, but not more than 250 percent of the authorized bandwidth: At least 35 dB.

(3) On any frequency removed from the assigned frequency by more than 250 percent of the authorized bandwidth: At least $43 + 10 \log (P)$ dB.

(c) Emission Mask C. For transmitters that are not equipped with an audio low-pass filter, the power of any emission must be attenuated below the unmodulated carrier output power (P) as follows:

(1) On any frequency removed from the center of the authorized bandwidth by a displacement frequency (f_d in kHz) of more than 5 kHz, but not more than 10 kHz: At least $83 \log (f_d/5)$ dB;

(2) On any frequency removed from the center of the authorized bandwidth by a displacement frequency (f_d in kHz) of more than 10 kHz, but not more than 250 percent of the authorized bandwidth: At least $29 \log (f_d/11)$ dB or 50 dB, whichever is the lesser attenuation;

(3) On any frequency removed from the center of the authorized bandwidth by more than 250 percent of the authorized bandwidth: At least $43 + 10 \log (P)$ dB.

(4) In the 1427-1432 MHz band, licensees are encouraged to take all reasonable steps to ensure that unwanted emissions power does not exceed the following levels in the 1400-1427 MHz band:

(i) For stations of point-to-point systems in the fixed service: -45 dBW/27 MHz.

(ii) For stations in the mobile service: -60 dBW/27 MHz.



(d) Emission Mask D—12.5 kHz channel bandwidth equipment. For transmitters designed to operate with a 12.5 kHz channel bandwidth, any emission must be attenuated below the power (P) of the highest emission contained within the authorized bandwidth as follows:

- (1) On any frequency from the center of the authorized bandwidth f_0 to 5.625 kHz removed from f_0 : Zero dB.
- (2) On any frequency removed from the center of the authorized bandwidth by a displacement frequency (f_d in kHz) of more than 5.625 kHz but no more than 12.5 kHz: At least $7.27(f_d - 2.88 \text{ kHz})$ dB.
- (3) On any frequency removed from the center of the authorized bandwidth by a displacement frequency (f_d in kHz) of more than 12.5 kHz: At least $50 + 10 \log(P)$ dB or 70 dB, whichever is the lesser attenuation.
- (4) The reference level for showing compliance with the emission mask shall be established using a resolution bandwidth sufficiently wide (usually two or three times the channel bandwidth) to capture the true peak emission of the equipment under test. In order to show compliance with the emission mask up to and including 50 kHz removed from the edge of the authorized bandwidth, adjust the resolution bandwidth to 100 Hz with the measuring instrument in a peak hold mode. A sufficient number of sweeps must be measured to insure that the emission profile is developed. If video filtering is used, its bandwidth must not be less than the instrument resolution bandwidth. For emissions beyond 50 kHz from the edge of the authorized bandwidth, see paragraph (o) of this section. If it can be shown that use of the above instrumentation settings do not accurately represent the true interference potential of the equipment under test, an alternate procedure may be used provided prior Commission approval is obtained.

(e) Emission Mask E—6.25 kHz or less channel bandwidth equipment. For transmitters designed to operate with a 6.25 kHz or less bandwidth, any emission must be attenuated below the power (P) of the highest emission contained within the authorized bandwidth as follows:

- (1) On any frequency from the center of the authorized bandwidth f_0 to 3.0 kHz removed from f_0 : Zero dB.
- (2) On any frequency removed from the center of the authorized bandwidth by a displacement frequency (f_d in kHz) of more than 3.0 kHz but no more than 4.6 kHz: At least $30 + 16.67(f_d - 3 \text{ kHz})$ or $55 + 10 \log(P)$ or 65 dB, whichever is the lesser attenuation.
- (3) On any frequency removed from the center of the authorized bandwidth by more than 4.6 kHz: At least $55 + 10 \log(P)$ or 65 dB, whichever is the lesser attenuation.
- (4) The reference level for showing compliance with the emission mask shall be established using a resolution bandwidth sufficiently wide (usually two or three times the channel bandwidth) to capture the true peak emission of the equipment under test. In order to show compliance with the emission mask up to and including 50 kHz removed from the edge of the authorized bandwidth, adjust the resolution bandwidth to 100 Hz with the measuring instrument in a peak hold mode. A sufficient number of sweeps must be measured to insure that the emission profile is developed. If video filtering is used, its bandwidth must not be less than the instrument resolution bandwidth. For emissions beyond 50 kHz from the edge of the authorized bandwidth, see paragraph (o) of this section. If it can be shown that use of the above instrumentation settings do not accurately represent the true interference potential of the equipment under test, an alternate procedure may be used provided prior Commission approval is obtained.

The detailed test data see: Appendix FCC data.

7.7.1 E.U.T. Operation

Operating Environment:

Temperature: 23.1 °C Humidity: 48 % RH Atmospheric Pressure: 1020 mbar

Test mode: o: Tx mode, Keep the EUT in transmitting mode.

7.7.2 Test Setup Diagram

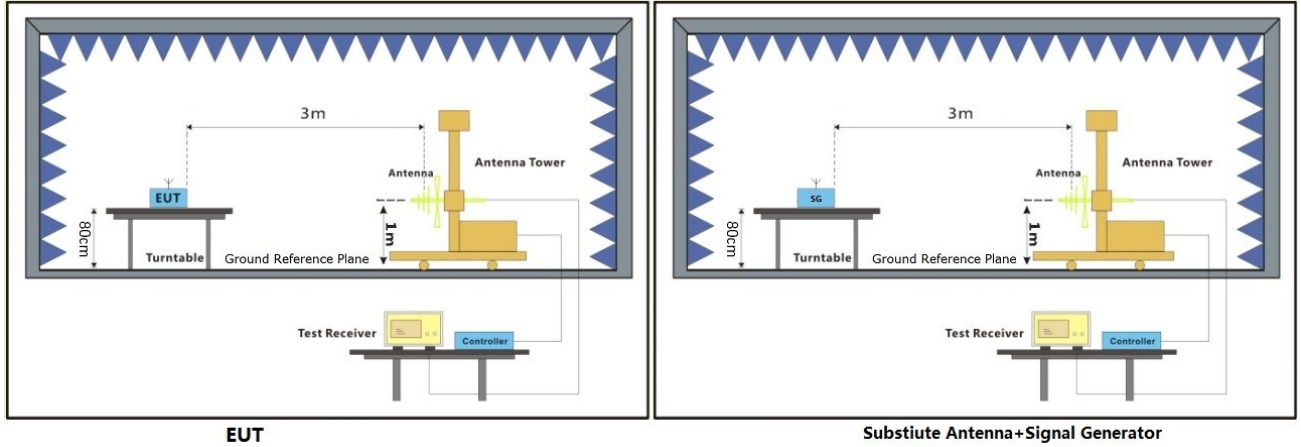



7.7.3 Measurement Procedure and Data

Test Procedure:

- (1) On a test site, the EUT shall be placed on a turntable and in the position closest to the normal use as declared by the user.
- (2) The test antenna shall be oriented initially for vertical polarization located 3m from the EUT to correspond to the transmitter.
- (3) The output of the antenna shall be connected to the measuring receiver and either a peak or quasi-peak detector was used for the measurement as indicated on the report. The detector selection is based on how close the emission level was approaching the limit.
- (4) The transmitter shall be switched on; if possible, without the modulation and the measurement receiver shall be tuned to the frequency of the transmitter under test.
- (5) The test antenna shall be raised and lowered through the specified range of height until the measuring receiver detects a maximum signal level.
- (6) The transmitter shall then be rotated through 360° in the horizontal plane, until the maximum signal level is detected by the measuring receiver.
- (7) The test antenna shall be raised and lowered again through the specified range of height until the measuring receiver detects a maximum signal level.
- (8) The maximum signal level detected by the measuring receiver shall be noted.
- (9) The measurement shall be repeated with the test antenna set to horizontal polarization.
- (10) Replace the antenna with a proper Antenna (substitution antenna).
- (11) The substitution antenna shall be oriented for vertical polarization and, if necessary, the length of the substitution antenna shall be adjusted to correspond to the frequency of transmitting.
- (12) The substitution antenna shall be connected to a calibrated signal generator.
- (13) If necessary, the input attenuator setting of the measuring receiver shall be adjusted in order to increase the sensitivity of the measuring receiver.
- (14) The test antenna shall be raised and lowered through the specified range of the height to ensure that the maximum signal is received.
- (15) The input signal to substitution antenna shall be adjusted to the level that produces a level detected by the measuring receiver, that is equal to the level noted while the transmitter radiated power was measured, corrected for the change of input attenuation setting of the measuring receiver.
- (16) The input level to the substitution antenna shall be recorded as power level in dBm, corrected for any change of input attenuator setting of the measuring receiver.
- (17) The measurement shall be repeated with the test antenna and the substitution antenna oriented for horizontal polarization.



8 Photographs

8.1 Test Setup

Please refer to setup photos.

8.2 EUT Constructional Details

Please Refer to external and internal photos for details.



9 Appendix

9.1 Appendix FCC data.

1. RF Output Power

Modulation Type	Channel Separation	Frequency (MHz)	Power Level	RF Output Power(dBm)	RF Output Power(W)	Remark
Analog FM	12.5KHz/ 25KHz	400.025	Max	37.17	5.21	For Federal
			Middle	34.17	2.61	
			Low	31.57	1.44	
		450.025	Max	37.75	5.96	For Part74
			Middle	35.28	3.37	
			Low	32.53	1.79	
		459.125	Max	37.75	5.96	For Part22
			Middle	35.28	3.37	
			Low	32.53	1.79	
		469.975	Max	37.55	5.69	For Part90 & Part80
			Middle	34.90	3.09	
			Low	32.25	1.68	
Digital 4FSK	12.5KHz	400.025	Max	37.07	5.09	For Federal
			Middle	33.99	2.51	
			Low	31.32	1.36	
		450.025	Max	37.76	5.97	For Part74
			Middle	35.22	3.33	
			Low	32.30	1.70	
		459.125	Max	37.77	5.98	For Part22
			Middle	35.33	3.41	
			Low	32.67	1.85	
		469.975	Max	37.59	5.74	For Part90 & Part80
			Middle	34.95	3.13	
			Low	32.36	1.72	



2.Frequency Stability

12.5KHz/25KHz, Analog modulation, Assigned Frequency:400.025MHz					
Voltage(V)	Temperature (°C)	Measured Frequency(MHz)	Frequency Deviation(ppm)	FCC Limit (ppm)	Result
7.4	-30	400.025100	0.250	±2.5	Pass
	-20	400.025104	0.260		
	-10	400.025099	0.247		
	0	400.025090	0.225		
	10	400.025094	0.235		
	20	400.025101	0.252		
	30	400.025094	0.235		
	40	400.025094	0.235		
50	400.025099	0.247			
6.29	25	400.025098	0.245		
8.51	25	400.025094	0.235		

12.5KHz, Digital modulation, Assigned Frequency:400.025MHz					
Voltage(V)	Temperature (°C)	Measured Frequency(MHz)	Frequency Deviation(ppm)	FCC Limit (ppm)	Result
7.4	-30	400.025004	0.010	±2.5	Pass
	-20	400.025008	0.020		
	-10	400.025007	0.017		
	0	400.025002	0.005		
	10	400.025201	0.502		
	20	400.025104	0.260		
	30	400.025202	0.505		
	40	400.025209	0.522		
	50	400.025391	0.977		
6.29	25	400.025324	0.810		
8.51	25	400.025331	0.827		



3.Audio Frequency Response

12.5KHz, Analog modulation, Assigned Frequency:400.025MHz	
Audio Frequency(Hz)	Response Attenuation(dB)
300	-11.15
400	-8.6
500	-6.23
600	-4.5
700	-3.45
800	-2.44
900	-1.22
1000	-0.17
1200	0.05
1400	1.66
1600	2.42
1800	3.74
2000	4.43
2100	5.15
2200	5.81
2300	6.15
2400	6.39
2500	7.9
2600	8.3
2700	8.35
2800	8.43
2900	8.82
3000	8.7

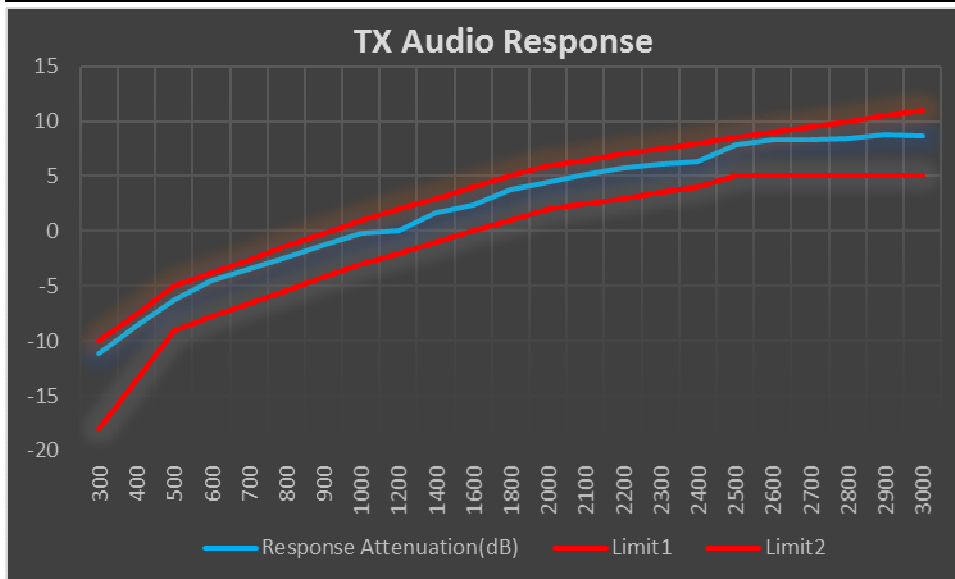



12.5KHz, Analog modulation, Assigned Frequency:450.025MHz	
Audio Frequency(Hz)	Response Attenuation(dB)
300	-11.23
400	-8.63
500	-6.27
600	-4.55
700	-3.48
800	-2.47
900	-1.24
1000	-0.18
1200	0.76
1400	1.69
1600	2.48
1800	3.82
2000	4.51
2100	5.15
2200	5.79
2300	6.01
2400	7.2
2500	7.64
2600	8.03
2700	8.04
2800	8.12
2900	8.53
3000	8.38

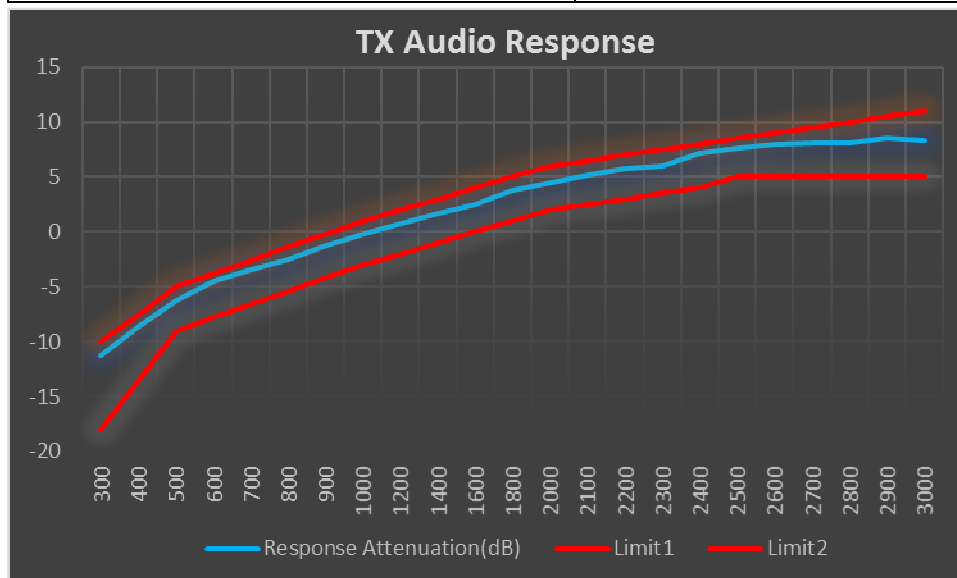



12.5KHz, Analog modulation, Assigned Frequency:459.125MHz	
Audio Frequency(Hz)	Response Attenuation(dB)
300	-11.19
400	-8.62
500	-6.27
600	-4.49
700	-3.49
800	-2.43
900	-1.2
1000	-0.17
1200	1.07
1400	1.71
1600	2.54
1800	3.67
2000	4.69
2100	5.27
2200	5.78
2300	6.02
2400	7.15
2500	7.6
2600	7.95
2700	7.95
2800	8.03
2900	8.42
3000	8.28

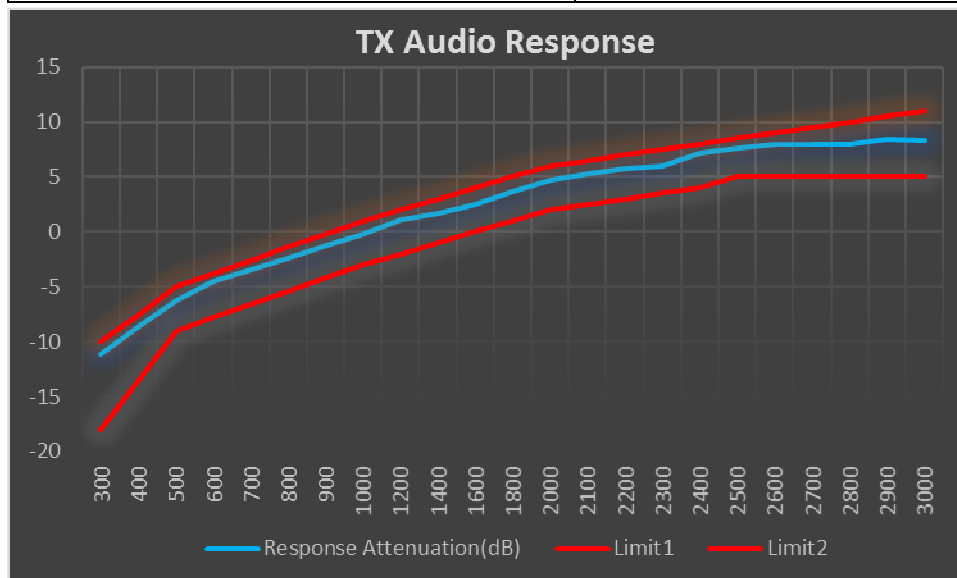



12.5KHz, Analog modulation, Assigned Frequency:469.975MHz	
Audio Frequency(Hz)	Response Attenuation(dB)
300	-11.1
400	-8.52
500	-6.18
600	-4.47
700	-3.4
800	-2.41
900	-1.18
1000	-0.17
1200	0.83
1400	1.77
1600	2.95
1800	3.56
2000	4.96
2100	5.22
2200	5.98
2300	6.24
2400	7.38
2500	7.8
2600	8.16
2700	8.17
2800	8.25
2900	8.64
3000	8.5

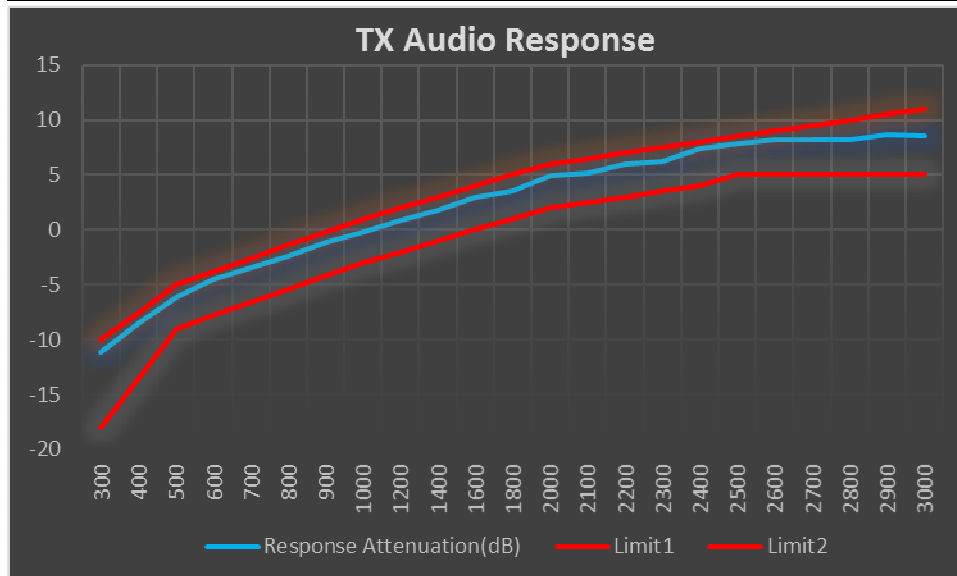



25KHz, Analog modulation, Assigned Frequency:400.025MHz	
Audio Frequency(Hz)	Response Attenuation(dB)
300	-11.93
400	-9.34
500	-6.98
600	-5.23
700	-4.17
800	-3.15
900	-1.91
1000	-0.87
1200	0.38
1400	2.02
1600	2.82
1800	4.13
2000	4.79
2100	5.43
2200	6.0
2300	6.31
2400	6.49
2500	6.99
2600	7.38
2700	7.39
2800	7.47
2900	7.87
3000	7.73

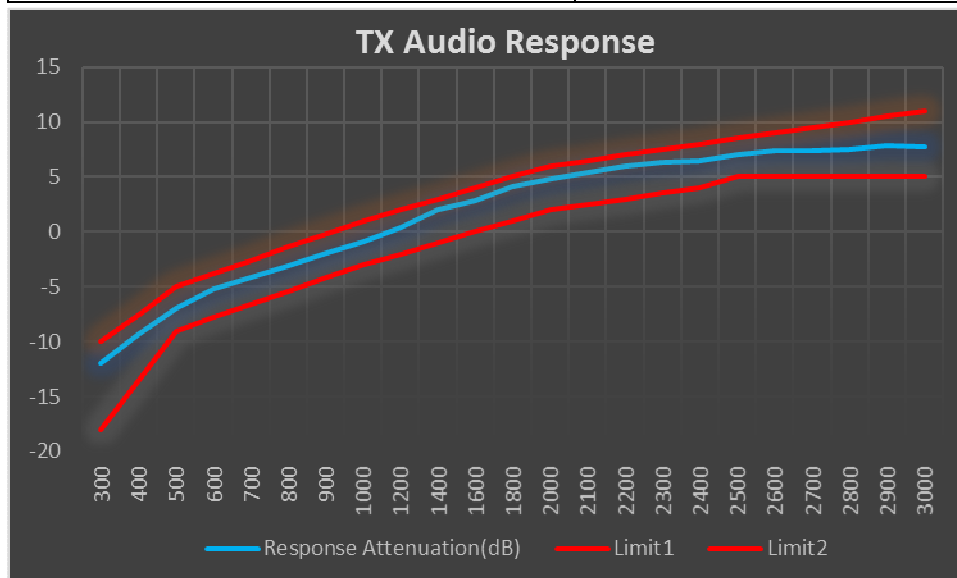



25KHz, Analog modulation, Assigned Frequency:450.025MHz	
Audio Frequency(Hz)	Response Attenuation(dB)
300	-11.94
400	-9.34
500	-6.97
600	-5.25
700	-4.18
800	-3.16
900	-1.92
1000	-0.87
1200	0.38
1400	2.03
1600	2.84
1800	4.14
2000	4.8
2100	5.5
2200	6.07
2300	6.29
2400	6.52
2500	6.94
2600	7.32
2700	7.34
2800	7.42
2900	7.81
3000	7.69

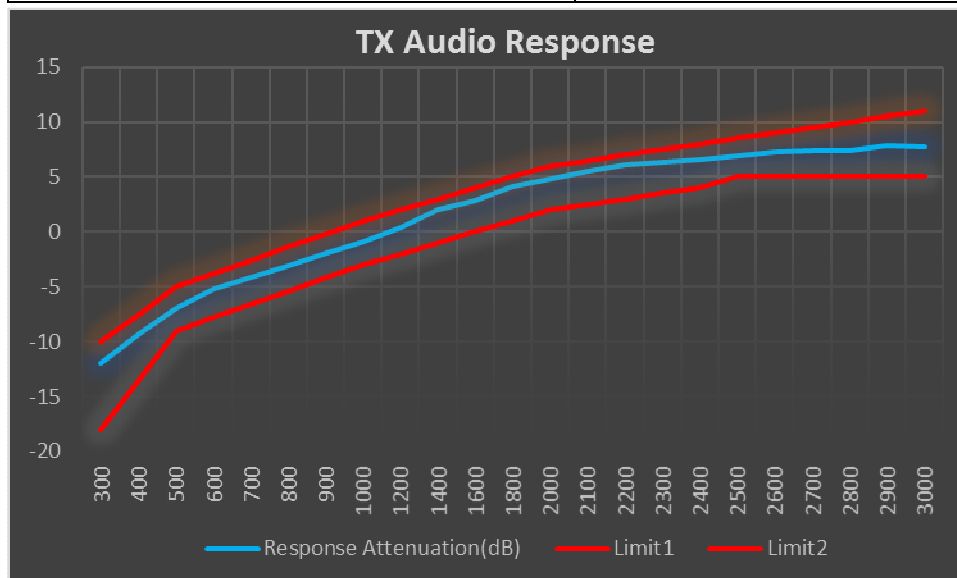



25KHz, Analog modulation, Assigned Frequency:459.125MHz	
Audio Frequency(Hz)	Response Attenuation(dB)
300	-11.9
400	-9.3
500	-6.95
600	-5.21
700	-4.15
800	-3.13
900	-1.92
1000	-0.88
1200	0.36
1400	2.03
1600	2.9
1800	4.42
2000	5.06
2100	5.66
2200	6.16
2300	6.34
2400	6.51
2500	6.93
2600	7.28
2700	7.29
2800	7.37
2900	7.76
3000	7.62

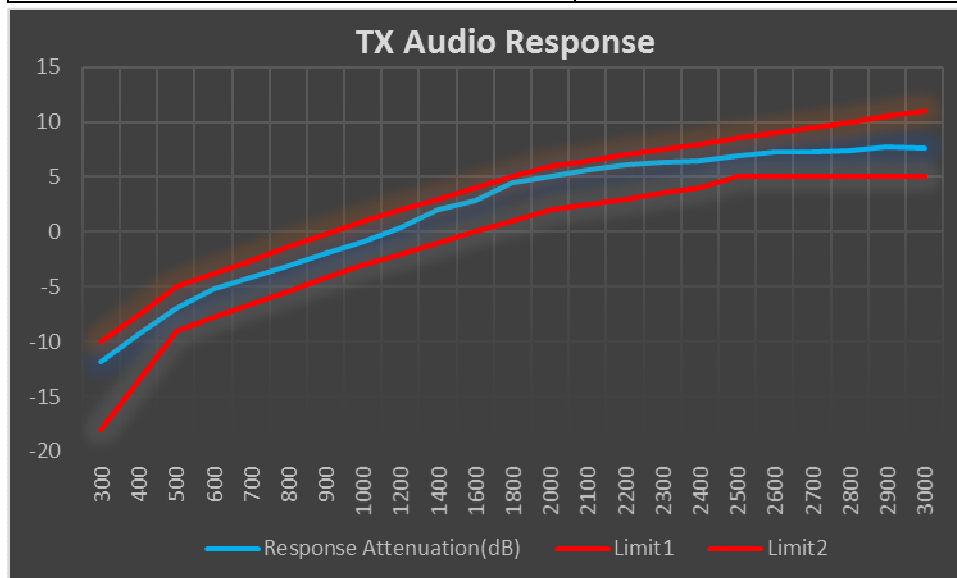



25KHz, Analog modulation, Assigned Frequency:469.975MHz	
Audio Frequency(Hz)	Response Attenuation(dB)
300	-11.86
400	-9.27
500	-6.9
600	-5.17
700	-4.12
800	-3.11
900	-1.89
1000	-0.86
1200	0.35
1400	2.06
1600	2.2
1800	3.68
2000	4.26
2100	4.85
2200	5.36
2300	6.54
2400	6.69
2500	7.1
2600	7.47
2700	7.48
2800	7.55
2900	7.95
3000	7.8

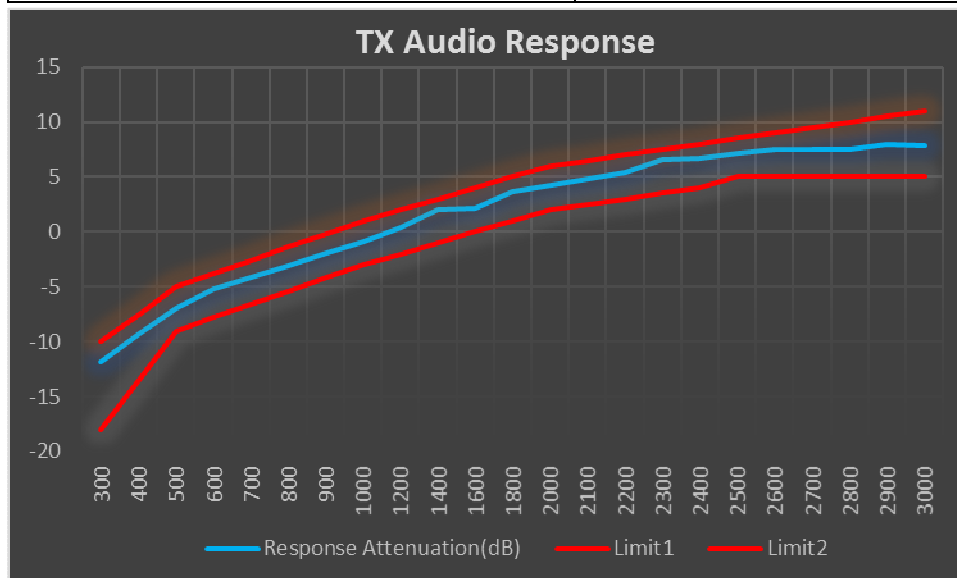

4.Audio Low Pass Filter Response

12.5KHz/25KHz, Analog modulation, Assigned Frequency: 400.025MHz		
Audio Frequency(KHz)	Response Attenuation(dB)	Limit (dB)
1	0.0	/
2	-19.1	0
3	-19.1	0
4	-74.9	-12.5
5	-85.5	-22.2
6	-88.3	-30.1
7	-84.2	-36.8
8	-88.6	-42.6
9	-89.0	-47.7
10	-90.6	-52.3
12	-91.6	-60.2
14	-94.1	-66.9
16	-95.8	-72.7
18	-91.2	-77.8
20	-92.6	-82.5

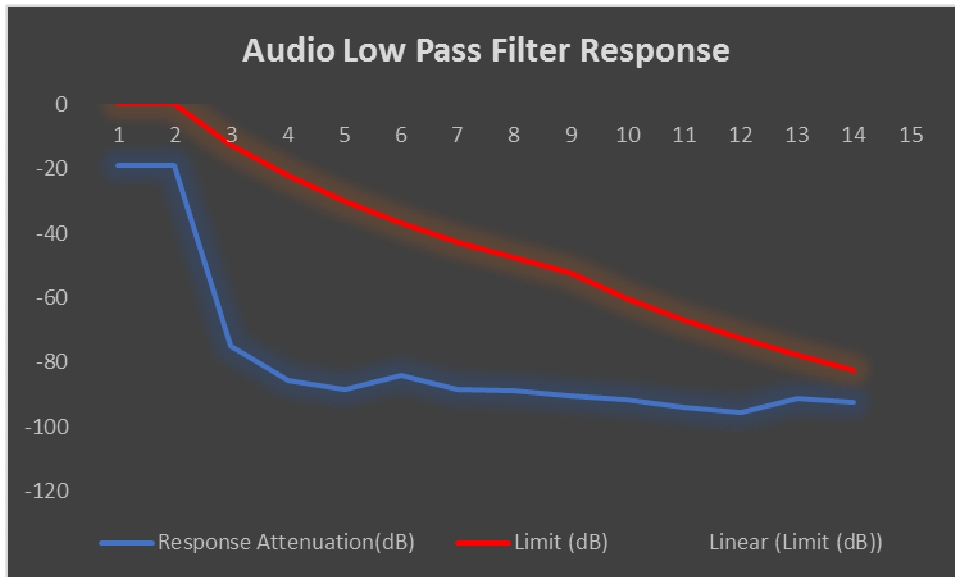



12.5KHz/25KHz, Analog modulation, Assigned Frequency: 450.025MHz		
Audio Frequency(KHz)	Response Attenuation(dB)	Limit (dB)
1	0	/
2	-18.5	0
3	-18.5	0
4	-74.3	-12.5
5	-84.9	-22.2
6	-87.7	-30.1
7	-83.6	-36.8
8	-88	-42.6
9	-88.4	-47.7
10	-90	-52.3
12	-91	-60.2
14	-93.5	-66.9
16	-95.2	-72.7
18	-90.6	-77.8
20	-92	-82.5

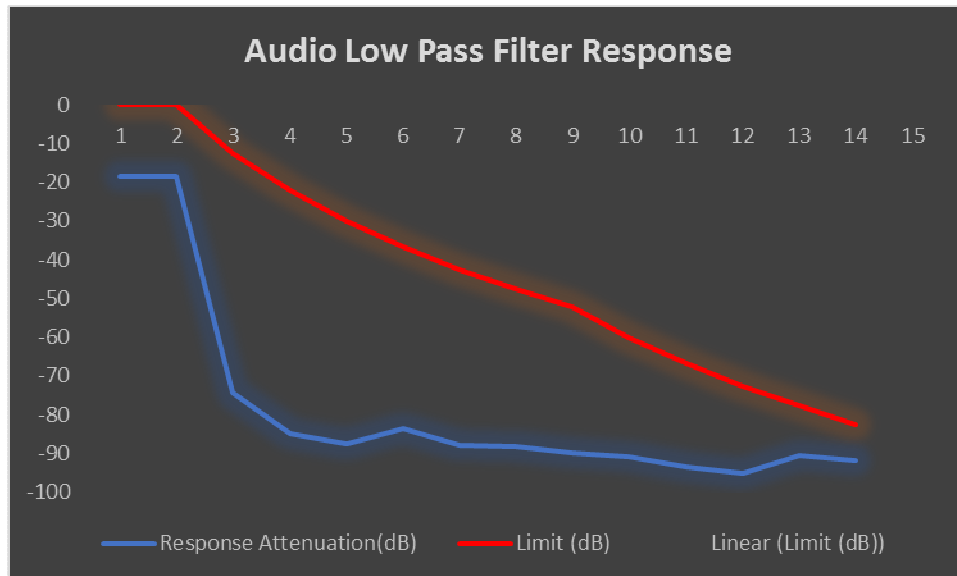



12.5KHz/25KHz, Analog modulation, Assigned Frequency:459.125MHz		
Audio Frequency(KHz)	Response Attenuation(dB)	Limit (dB)
1	0	/
2	-17.1	0
3	-17.1	0
4	-72.9	-12.5
5	-82.7	-22.2
6	-85.8	-30.1
7	-82.2	-36.8
8	-87.1	-42.6
9	-86.7	-47.7
10	-88.7	-52.3
12	-90.2	-60.2
14	-92.1	-66.9
16	-93.8	-72.7
18	-89.2	-77.8
20	-91.3	-82.5

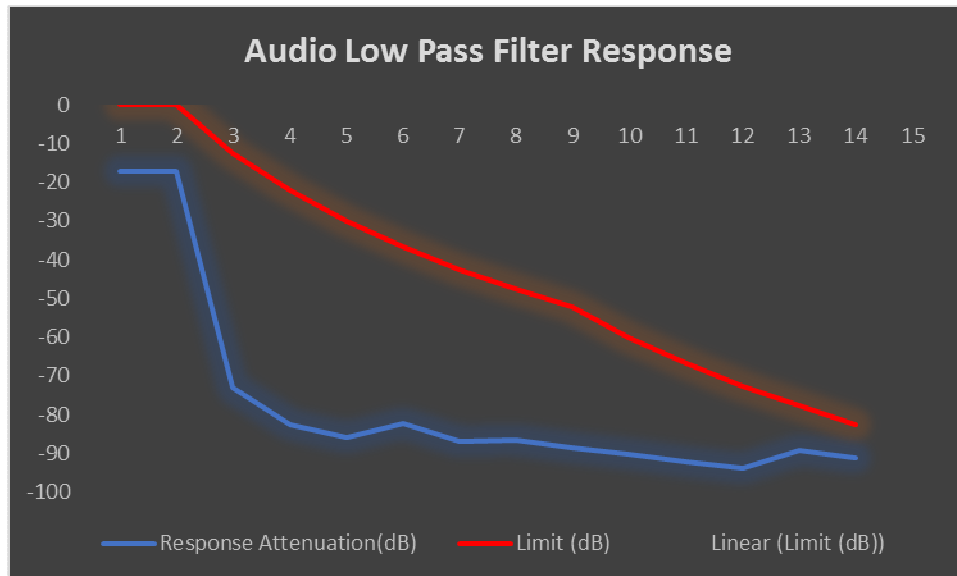



12.5KHz/25KHz, Analog modulation, Assigned Frequency: 469.975MHz		
Audio Frequency(KHz)	Response Attenuation(dB)	Limit (dB)
1	0	/
2	-17.5	0
3	-17.3	0
4	-72.5	-12.5
5	-81.7	-22.2
6	-85	-30.1
7	-82.2	-36.8
8	-86.7	-42.6
9	-85.9	-47.7
10	-88.3	-52.3
12	-89.8	-60.2
14	-92.2	-66.9
16	-93.4	-72.7
18	-89.2	-77.8
20	-91.4	-82.5

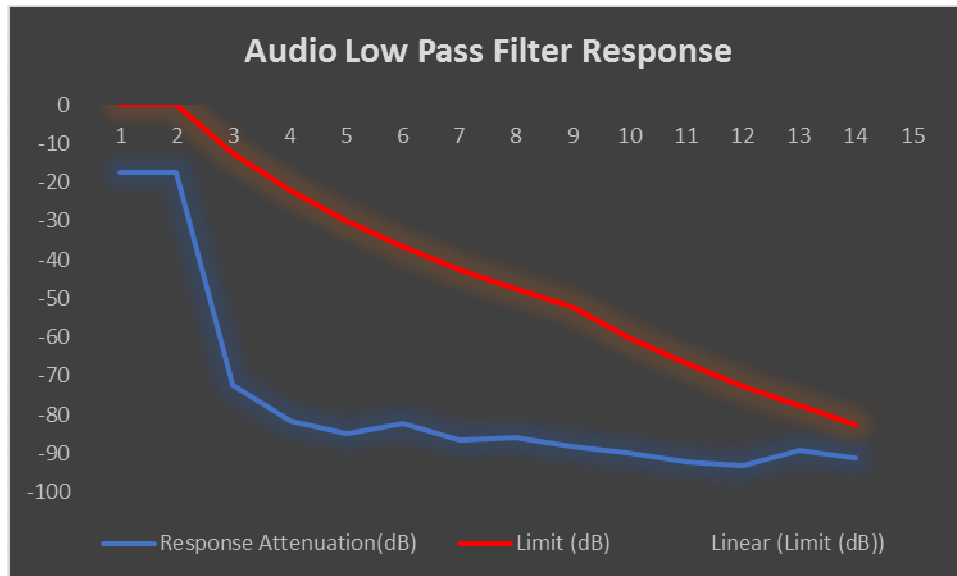



5.Modulation Limiting

12.5KHz, Digital modulation, Assigned Frequency:400.025MHz					
Audio Frequency(Hz)	Instantaneous		Steady-state		Limit (KHz)
	Deviation (peak positive at -20dB) (KHz)	Deviation (peak negative at +20dB) (KHz)	Deviation (peak positive at -20dB) (KHz)	Deviation (peak negative at +20dB) (KHz)	
300	4.43	4.37	4.51	4.5	5.0
400	4.48	4.44	4.53	4.67	5.0
500	4.46	4.42	4.5	4.54	5.0
600	4.46	4.41	4.51	4.54	5.0
700	4.45	4.39	4.49	4.53	5.0
800	4.43	4.38	4.49	4.52	5.0
900	4.43	4.38	4.49	4.53	5.0
1000	4.43	4.38	4.48	4.52	5.0
1200	4.42	4.37	4.47	4.51	5.0
1400	4.43	4.37	4.46	4.51	5.0
1600	4.41	4.36	4.45	4.5	5.0
1800	4.4	4.35	4.45	4.49	5.0
2000	4.39	4.34	4.45	4.48	5.0
2100	4.44	4.4	4.49	4.51	5.0
2200	4.48	4.42	4.52	4.54	5.0
2300	4.49	4.46	4.55	4.57	5.0
2400	4.51	4.47	4.58	4.6	5.0
2500	4.51	4.46	4.57	4.58	5.0
2600	4.49	4.45	4.54	4.56	5.0
2700	4.45	4.39	4.49	4.54	5.0
2800	4.41	4.35	4.43	4.48	5.0
2900	4.32	4.26	4.26	4.38	5.0
3000	4.21	4.16	4.27	4.3	5.0

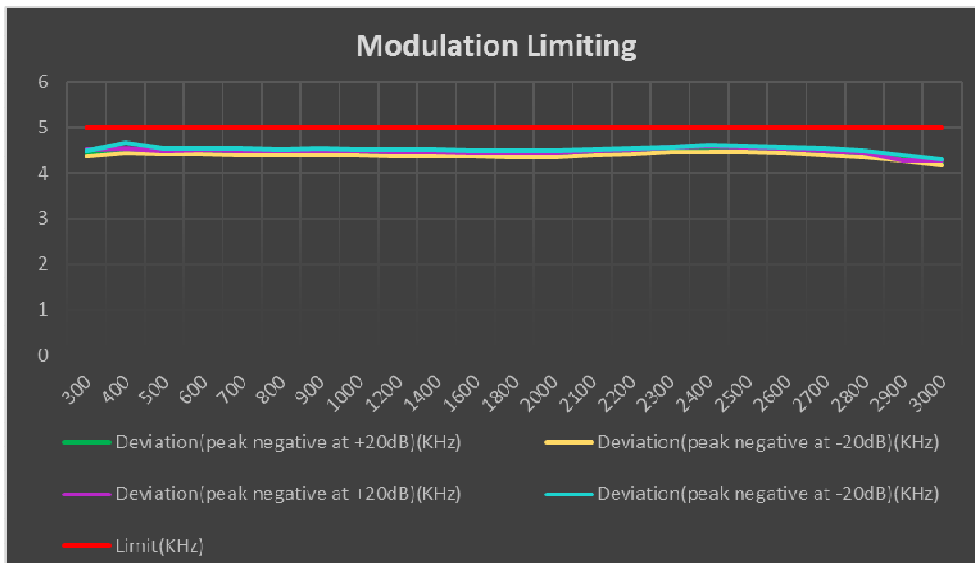

This document is issued by the Company subject to its General Conditions of Service printed overleaf, available on request or accessible at <http://www.sgs.com/en/Terms-and-Conditions.aspx> and, for electronic format documents, subject to Terms and Conditions for Electronic Documents at <http://www.sgs.com/en/Terms-and-Conditions/Terms-e-Document.aspx>. Attention is drawn to the limitation of liability, indemnification and jurisdiction issues defined therein. Any holder of this document is advised that information contained hereon reflects the Company's findings at the time of its intervention only and within the limits of Client's instructions, if any. The Company's sole responsibility is to its Client and this document does not exonerate parties to a transaction from exercising all their rights and obligations under the transaction documents. This document cannot be reproduced except in full, without prior written approval of the Company. Any unauthorized alteration, forgery or falsification of the content or appearance of this document is unlawful and offenders may be prosecuted to the fullest extent of the law. Unless otherwise stated the results shown in this test report refer only to the sample(s) tested and such sample(s) are retained for 30 days only.



12.5KHz, Digital modulation, Assigned Frequency:450.025MHz					
Audio Frequency(Hz)	Instantaneous		Steady-state		Limit (KHz)
	Deviation (peak positive at -20dB) (KHz)	Deviation (peak negative at +20dB) (KHz)	Deviation (peak positive at -20dB) (KHz)	Deviation (peak negative at +20dB) (KHz)	
300	4.42	4.37	4.47	4.54	5.0
400	4.48	4.43	4.64	4.56	5.0
500	4.45	4.4	4.5	4.54	5.0
600	4.45	4.4	4.5	4.55	5.0
700	4.44	4.39	4.5	4.53	5.0
800	4.44	4.39	4.54	4.52	5.0
900	4.43	4.37	4.51	4.52	5.0
1000	4.42	4.37	4.48	4.52	5.0
1200	4.42	4.37	4.48	4.51	5.0
1400	4.42	4.37	4.47	4.51	5.0
1600	4.41	4.35	4.45	4.49	5.0
1800	4.4	4.34	4.44	4.51	5.0
2000	4.39	4.35	4.47	4.49	5.0
2100	4.46	4.42	4.52	4.57	5.0
2200	4.5	4.44	4.55	4.59	5.0
2300	4.52	4.46	4.55	4.61	5.0
2400	4.52	4.47	4.55	4.61	5.0
2500	4.5	4.45	4.55	4.6	5.0
2600	4.46	4.42	4.51	4.57	5.0
2700	4.41	4.37	4.49	4.52	5.0
2800	4.37	4.33	4.43	4.46	5.0
2900	4.29	4.26	4.35	4.38	5.0
3000	4.19	4.14	4.23	4.27	5.0

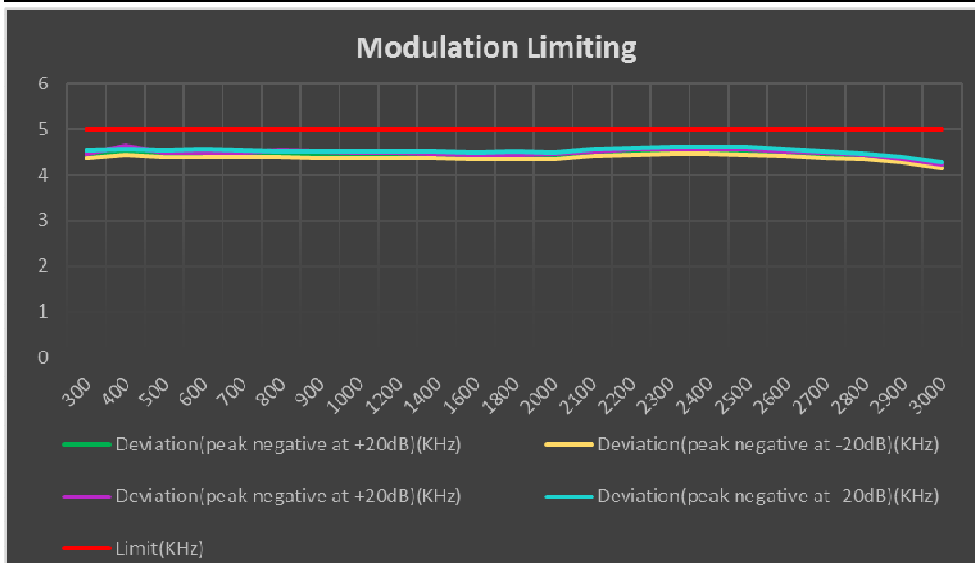



12.5KHz, Digital modulation, Assigned Frequency:459.125MHz					
Audio Frequency(Hz)	Instantaneous		Steady-state		Limit (KHz)
	Deviation (peak positive at -20dB) (KHz)	Deviation (peak negative at +20dB) (KHz)	Deviation (peak positive at -20dB) (KHz)	Deviation (peak negative at +20dB) (KHz)	
300	4.41	4.35	4.47	4.49	5.0
400	4.48	4.42	4.63	4.57	5.0
500	4.46	4.4	4.51	4.54	5.0
600	4.45	4.41	4.57	4.55	5.0
700	4.45	4.39	4.5	4.53	5.0
800	4.43	4.37	4.48	4.51	5.0
900	4.43	4.38	4.47	4.51	5.0
1000	4.43	4.36	4.5	4.5	5.0
1200	4.41	4.35	4.46	4.5	5.0
1400	4.4	4.34	4.43	4.49	5.0
1600	4.39	4.34	4.44	4.48	5.0
1800	4.45	4.42	4.51	4.68	5.0
2000	4.59	4.52	4.64	4.67	5.0
2100	4.61	4.56	4.67	4.71	5.0
2200	4.61	4.54	4.64	4.68	5.0
2300	4.57	4.52	4.62	4.67	5.0
2400	4.55	4.49	4.61	4.65	5.0
2500	4.52	4.46	4.57	4.61	5.0
2600	4.47	4.41	4.51	4.5	5.0
2700	4.42	4.36	4.47	4.51	5.0
2800	4.36	4.31	4.4	4.45	5.0
2900	4.28	4.22	4.32	4.37	5.0
3000	4.17	4.11	4.21	4.26	5.0

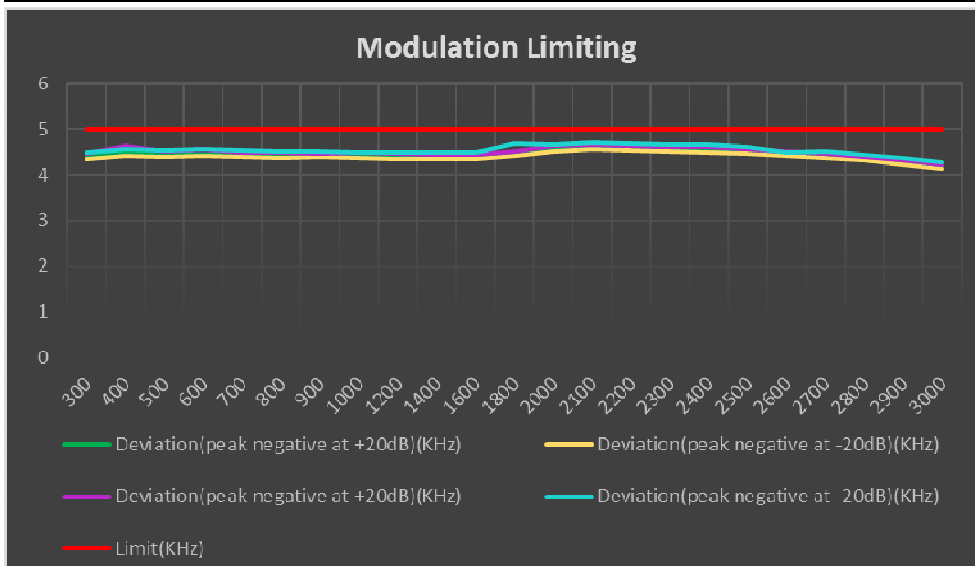

This document is issued by the Company subject to its General Conditions of Service printed overleaf, available on request or accessible at <http://www.sgs.com/en/Terms-and-Conditions.aspx> and, for electronic format documents, subject to Terms and Conditions for Electronic Documents at <http://www.sgs.com/en/Terms-and-Conditions/Terms-e-Document.aspx>. Attention is drawn to the limitation of liability, indemnification and jurisdiction issues defined therein. Any holder of this document is advised that information contained hereon reflects the Company's findings at the time of its intervention only and within the limits of Client's instructions, if any. The Company's sole responsibility is to its Client and this document does not exonerate parties to a transaction from exercising all their rights and obligations under the transaction documents. This document cannot be reproduced except in full, without prior written approval of the Company. Any unauthorized alteration, forgery or falsification of the content or appearance of this document is unlawful and offenders may be prosecuted to the fullest extent of the law. Unless otherwise stated the results shown in this test report refer only to the sample(s) tested and such sample(s) are retained for 30 days only.



12.5KHz, Digital modulation, Assigned Frequency:469.975MHz					
Audio Frequency(Hz)	Instantaneous		Steady-state		Limit (KHz)
	Deviation (peak positive at -20dB) (KHz)	Deviation (peak negative at +20dB) (KHz)	Deviation (peak positive at -20dB) (KHz)	Deviation (peak negative at +20dB) (KHz)	
300	4.35	4.31	4.43	4.46	5.0
400	4.47	4.4	4.53	4.55	5.0
500	4.44	4.39	4.49	4.53	5.0
600	4.45	4.4	4.49	4.52	5.0
700	4.44	4.38	4.49	4.52	5.0
800	4.41	4.36	4.46	4.55	5.0
900	4.4	4.35	4.45	4.49	5.0
1000	4.38	4.34	4.46	4.48	5.0
1200	4.36	4.31	4.38	4.45	5.0
1400	4.33	4.28	4.37	4.48	5.0
1600	4.44	4.38	4.5	4.53	5.0
1800	4.64	4.58	4.67	4.73	5.0
2000	4.65	4.61	4.71	4.74	5.0
2100	4.63	4.58	4.69	4.71	5.0
2200	4.61	4.55	4.65	4.7	5.0
2300	4.58	4.53	4.64	4.64	5.0
2400	4.56	4.52	4.61	4.64	5.0
2500	4.52	4.48	4.58	4.61	5.0
2600	4.48	4.42	4.53	4.57	5.0
2700	4.43	4.38	4.48	4.52	5.0
2800	4.37	4.33	4.42	4.47	5.0
2900	4.29	4.25	4.34	4.38	5.0
3000	4.19	4.14	4.23	4.27	5.0

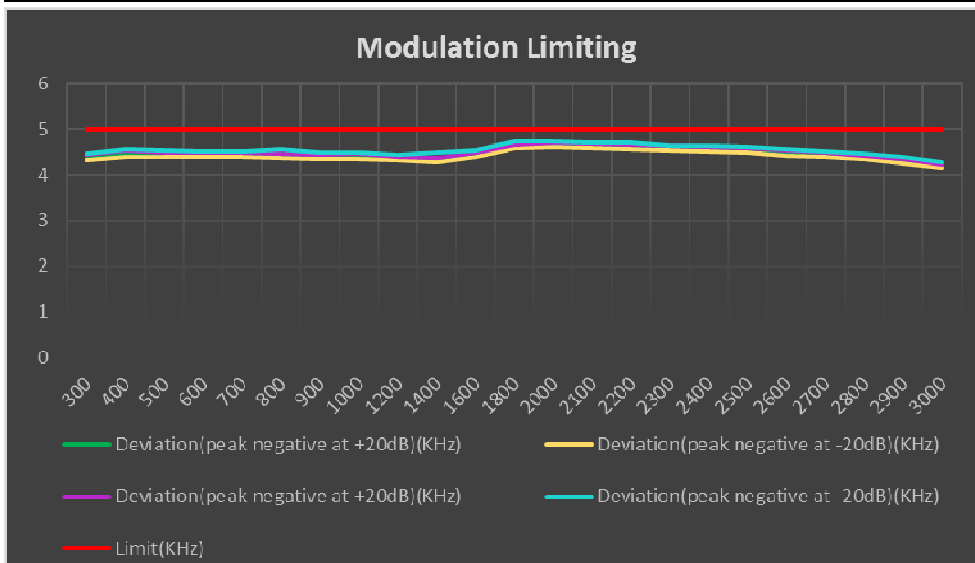

This document is issued by the Company subject to its General Conditions of Service printed overleaf, available on request or accessible at <http://www.sgs.com/en/Terms-and-Conditions.aspx> and, for electronic format documents, subject to Terms and Conditions for Electronic Documents at <http://www.sgs.com/en/Terms-and-Conditions/Terms-e-Document.aspx>. Attention is drawn to the limitation of liability, indemnification and jurisdiction issues defined therein. Any holder of this document is advised that information contained hereon reflects the Company's findings at the time of its intervention only and within the limits of Client's instructions, if any. The Company's sole responsibility is to its Client and this document does not exonerate parties to a transaction from exercising all their rights and obligations under the transaction documents. This document cannot be reproduced except in full, without prior written approval of the Company. Any unauthorized alteration, forgery or falsification of the content or appearance of this document is unlawful and offenders may be prosecuted to the fullest extent of the law. Unless otherwise stated the results shown in this test report refer only to the sample(s) tested and such sample(s) are retained for 30 days only.



12.5KHz, Analog modulation, Assigned Frequency:400.025MHz					
Audio Frequency(Hz)	Instantaneous		Steady-state		Limit (KHz)
	Deviation (peak positive at -20dB) (KHz)	Deviation (peak negative at +20dB) (KHz)	Deviation (peak positive at -20dB) (KHz)	Deviation (peak negative at +20dB) (KHz)	
300	2.13	2.08	2.18	2.21	2.5
400	2.15	2.1	2.2	2.24	2.5
500	2.14	2.08	2.19	2.23	2.5
600	2.14	2.09	2.19	2.23	2.5
700	2.14	2.08	2.18	2.22	2.5
800	2.12	2.07	2.18	2.25	2.5
900	2.13	2.08	2.18	2.22	2.5
1000	2.13	2.08	2.19	2.22	2.5
1200	2.13	2.08	2.19	2.22	2.5
1400	2.14	2.08	2.18	2.23	2.5
1600	2.14	2.08	2.18	2.23	2.5
1800	2.14	2.08	2.18	2.23	2.5
2000	2.14	2.08	2.17	2.22	2.5
2100	2.13	2.09	2.18	2.23	2.5
2200	2.13	2.08	2.19	2.22	2.5
2300	2.12	2.07	2.18	2.22	2.5
2400	2.13	2.08	2.18	2.2	2.5
2500	2.13	2.07	2.17	2.2	2.5
2600	2.1	2.05	2.16	2.19	2.5
2700	2.08	2.02	2.13	2.17	2.5
2800	2.06	2	2.12	2.1	2.5
2900	2.02	1.95	2.07	2.1	2.5
3000	1.96	1.9	2.02	2.06	2.5

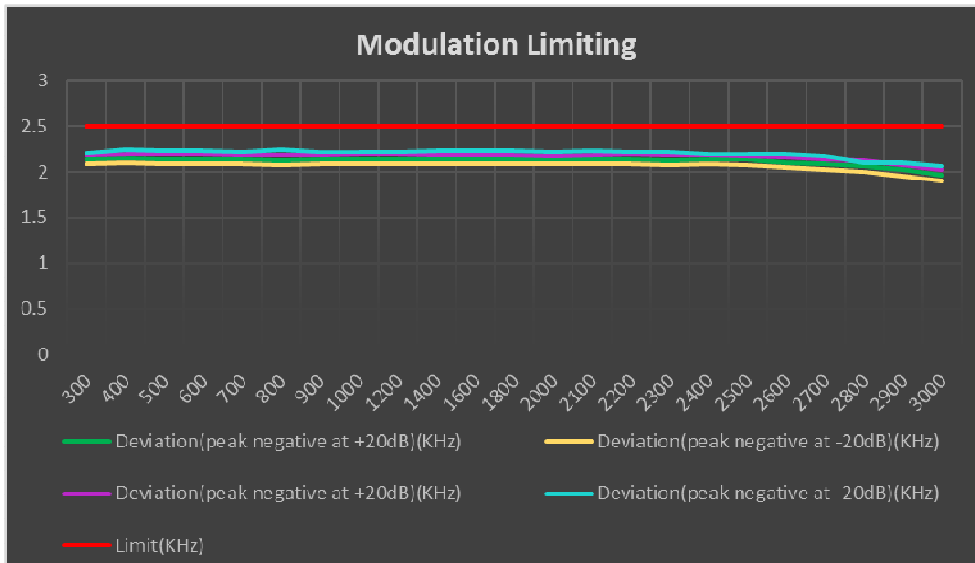

This document is issued by the Company subject to its General Conditions of Service printed overleaf, available on request or accessible at <http://www.sgs.com/en/Terms-and-Conditions.aspx> and, for electronic format documents, subject to Terms and Conditions for Electronic Documents at <http://www.sgs.com/en/Terms-and-Conditions/Terms-e-Document.aspx>. Attention is drawn to the limitation of liability, indemnification and jurisdiction issues defined therein. Any holder of this document is advised that information contained hereon reflects the Company's findings at the time of its intervention only and within the limits of Client's instructions, if any. The Company's sole responsibility is to its Client and this document does not exonerate parties to a transaction from exercising all their rights and obligations under the transaction documents. This document cannot be reproduced except in full, without prior written approval of the Company. Any unauthorized alteration, forgery or falsification of the content or appearance of this document is unlawful and offenders may be prosecuted to the fullest extent of the law. Unless otherwise stated the results shown in this test report refer only to the sample(s) tested and such sample(s) are retained for 30 days only.



12.5KHz, Analog modulation, Assigned Frequency:450.025MHz					
Audio Frequency(Hz)	Instantaneous		Steady-state		Limit (KHz)
	Deviation (peak positive at -20dB) (KHz)	Deviation (peak negative at +20dB) (KHz)	Deviation (peak positive at -20dB) (KHz)	Deviation (peak negative at +20dB) (KHz)	
300	2.13	2.07	2.22	2.21	2.5
400	2.16	2.12	2.23	2.24	2.5
500	2.14	2.09	2.19	2.23	2.5
600	2.15	2.09	2.2	2.21	2.5
700	2.14	2.09	2.19	2.22	2.5
800	2.12	2.08	2.18	2.22	2.5
900	2.13	2.07	2.18	2.22	2.5
1000	2.14	2.07	2.18	2.22	2.5
1200	2.12	2.07	2.18	2.21	2.5
1400	2.13	2.06	2.17	2.21	2.5
1600	2.11	2.07	2.17	2.21	2.5
1800	2.11	2.05	2.16	2.2	2.5
2000	2.11	2.06	2.18	2.2	2.5
2100	2.15	2.09	2.2	2.22	2.5
2200	2.17	2.13	2.2	2.24	2.5
2300	2.17	2.12	2.22	2.27	2.5
2400	2.18	2.15	2.23	2.29	2.5
2500	2.17	2.13	2.22	2.28	2.5
2600	2.15	2.12	2.21	2.24	2.5
2700	2.13	2.1	2.19	2.24	2.5
2800	2.11	2.06	2.17	2.2	2.5
2900	2.09	2.02	2.12	2.17	2.5
3000	2.02	1.97	2.08	2.11	2.5

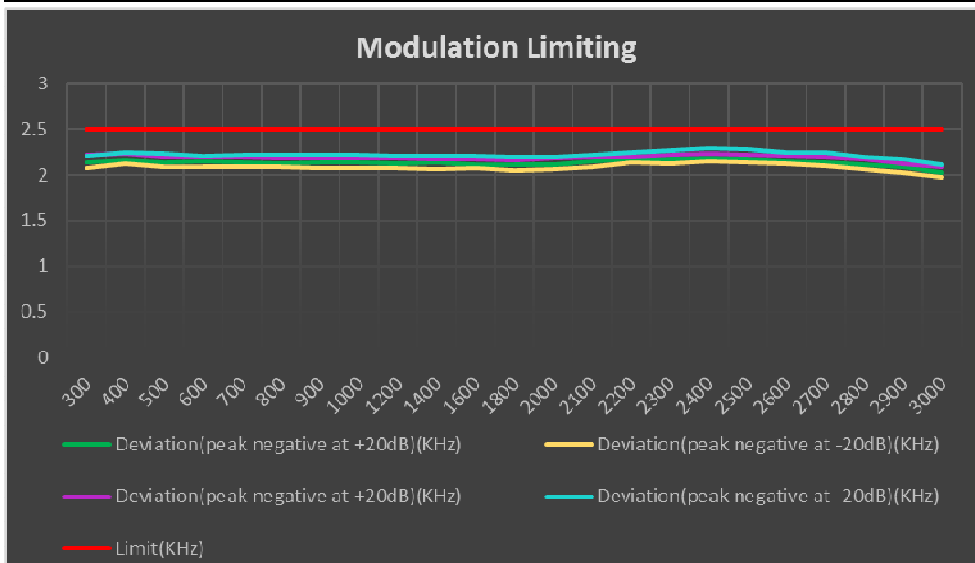

This document is issued by the Company subject to its General Conditions of Service printed overleaf, available on request or accessible at <http://www.sgs.com/en/Terms-and-Conditions.aspx> and, for electronic format documents, subject to Terms and Conditions for Electronic Documents at <http://www.sgs.com/en/Terms-and-Conditions/Terms-e-Document.aspx>. Attention is drawn to the limitation of liability, indemnification and jurisdiction issues defined therein. Any holder of this document is advised that information contained hereon reflects the Company's findings at the time of its intervention only and within the limits of Client's instructions, if any. The Company's sole responsibility is to its Client and this document does not exonerate parties to a transaction from exercising all their rights and obligations under the transaction documents. This document cannot be reproduced except in full, without prior written approval of the Company. Any unauthorized alteration, forgery or falsification of the content or appearance of this document is unlawful and offenders may be prosecuted to the fullest extent of the law. Unless otherwise stated the results shown in this test report refer only to the sample(s) tested and such sample(s) are retained for 30 days only.



12.5KHz, Analog modulation, Assigned Frequency:459.125MHz					
Audio Frequency(Hz)	Instantaneous		Steady-state		Limit (KHz)
	Deviation (peak positive at -20dB) (KHz)	Deviation (peak negative at +20dB) (KHz)	Deviation (peak positive at -20dB) (KHz)	Deviation (peak negative at +20dB) (KHz)	
300	2.13	2.07	2.18	2.22	2.5
400	2.15	2.09	2.24	2.22	2.5
500	2.13	2.08	2.19	2.22	2.5
600	2.13	2.08	2.21	2.22	2.5
700	2.14	2.08	2.17	2.22	2.5
800	2.13	2.07	2.18	2.21	2.5
900	2.12	2.08	2.19	2.21	2.5
1000	2.13	2.08	2.18	2.22	2.5
1200	2.12	2.07	2.18	2.21	2.5
1400	2.12	2.08	2.18	2.22	2.5
1600	2.13	2.08	2.18	2.21	2.5
1800	2.15	2.09	2.2	2.26	2.5
2000	2.17	2.12	2.23	2.26	2.5
2100	2.18	2.14	2.23	2.27	2.5
2200	2.16	2.12	2.23	2.26	2.5
2300	2.17	2.1	2.21	2.25	2.5
2400	2.16	2.1	2.2	2.25	2.5
2500	2.14	2.08	2.19	2.23	2.5
2600	2.12	2.06	2.16	2.21	2.5
2700	2.09	2.04	2.15	2.15	2.5
2800	2.06	2.01	2.11	2.15	2.5
2900	2.02	1.97	2.07	2.11	2.5
3000	1.97	1.92	2.02	2.05	2.5

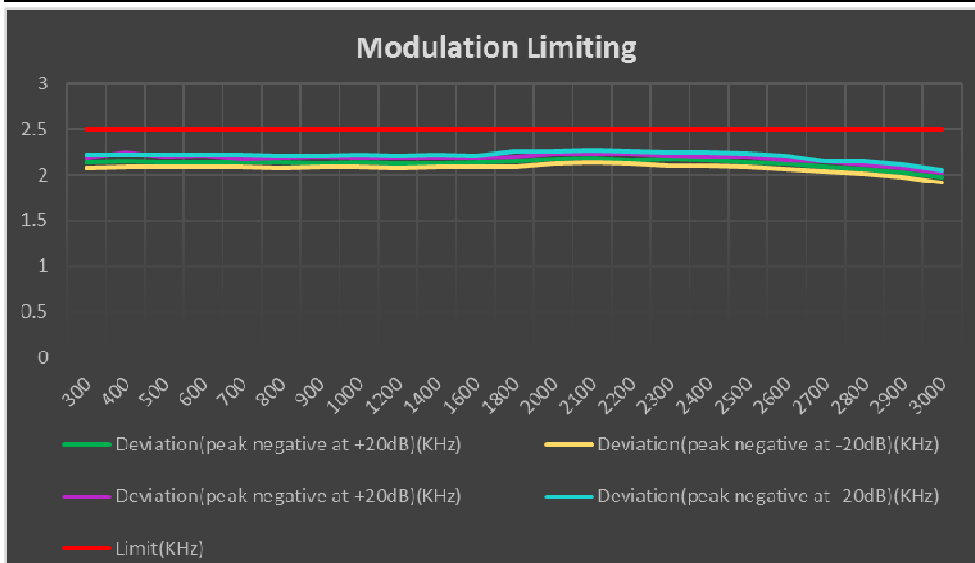

This document is issued by the Company subject to its General Conditions of Service printed overleaf, available on request or accessible at <http://www.sgs.com/en/Terms-and-Conditions.aspx> and, for electronic format documents, subject to Terms and Conditions for Electronic Documents at <http://www.sgs.com/en/Terms-and-Conditions/Terms-e-Document.aspx>. Attention is drawn to the limitation of liability, indemnification and jurisdiction issues defined therein. Any holder of this document is advised that information contained hereon reflects the Company's findings at the time of its intervention only and within the limits of Client's instructions, if any. The Company's sole responsibility is to its Client and this document does not exonerate parties to a transaction from exercising all their rights and obligations under the transaction documents. This document cannot be reproduced except in full, without prior written approval of the Company. Any unauthorized alteration, forgery or falsification of the content or appearance of this document is unlawful and offenders may be prosecuted to the fullest extent of the law. Unless otherwise stated the results shown in this test report refer only to the sample(s) tested and such sample(s) are retained for 30 days only.



12.5KHz, Analog modulation, Assigned Frequency:469.975MHz					
Audio Frequency(Hz)	Instantaneous		Steady-state		Limit (KHz)
	Deviation (peak positive at -20dB) (KHz)	Deviation (peak negative at +20dB) (KHz)	Deviation (peak positive at -20dB) (KHz)	Deviation (peak negative at +20dB) (KHz)	
300	2.09	2.04	2.15	2.18	2.5
400	2.14	2.08	2.19	2.23	2.5
500	2.13	2.08	2.18	2.22	2.5
600	2.13	2.07	2.19	2.21	2.5
700	2.12	2.07	2.18	2.21	2.5
800	2.12	2.06	2.17	2.21	2.5
900	2.11	2.07	2.16	2.19	2.5
1000	2.1	2.05	2.15	2.2	2.5
1200	2.1	2.06	2.15	2.18	2.5
1400	2.07	2.01	2.12	2.16	2.5
1600	2.08	2.02	2.12	2.17	2.5
1800	2.15	2.11	2.2	2.24	2.5
2000	2.2	2.15	2.24	2.28	2.5
2100	2.19	2.15	2.24	2.28	2.5
2200	2.19	2.14	2.24	2.28	2.5
2300	2.18	2.12	2.22	2.26	2.5
2400	2.16	2.13	2.22	2.26	2.5
2500	2.16	2.11	2.2	2.24	2.5
2600	2.13	2.08	2.19	2.23	2.5
2700	2.11	2.06	2.16	2.2	2.5
2800	2.08	2.04	2.13	2.18	2.5
2900	2.05	2	2.09	2.14	2.5
3000	1.99	1.95	2.05	2.08	2.5

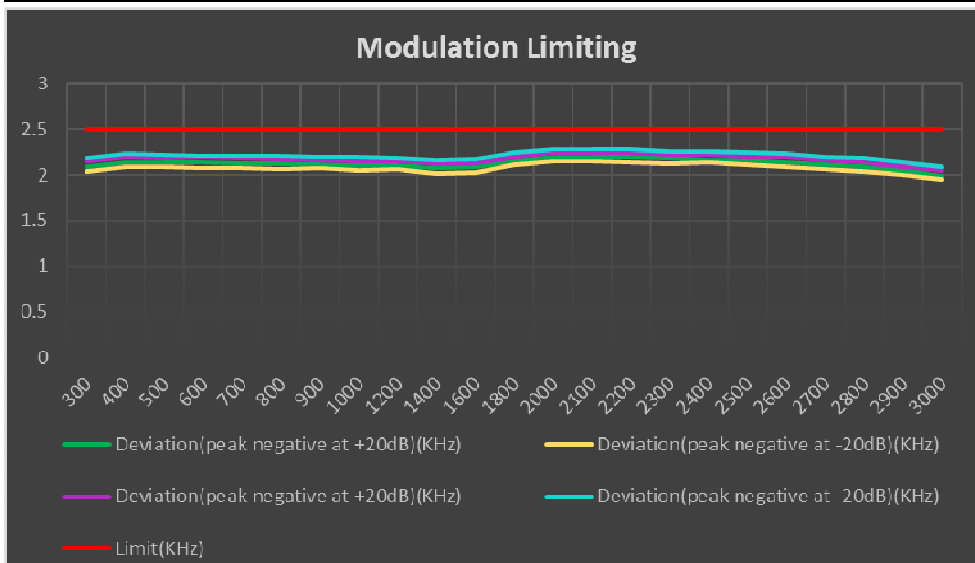

This document is issued by the Company subject to its General Conditions of Service printed overleaf, available on request or accessible at <http://www.sgs.com/en/Terms-and-Conditions.aspx> and, for electronic format documents, subject to Terms and Conditions for Electronic Documents at <http://www.sgs.com/en/Terms-and-Conditions/Terms-e-Document.aspx>. Attention is drawn to the limitation of liability, indemnification and jurisdiction issues defined therein. Any holder of this document is advised that information contained hereon reflects the Company's findings at the time of its intervention only and within the limits of Client's instructions, if any. The Company's sole responsibility is to its Client and this document does not exonerate parties to a transaction from exercising all their rights and obligations under the transaction documents. This document cannot be reproduced except in full, without prior written approval of the Company. Any unauthorized alteration, forgery or falsification of the content or appearance of this document is unlawful and offenders may be prosecuted to the fullest extent of the law. Unless otherwise stated the results shown in this test report refer only to the sample(s) tested and such sample(s) are retained for 30 days only.



6.Occupied Bandwidth

Modulation Type	Channel Separation	Frequency (MHz)	Power Level	99% Occupied Bandwidth (kHz)	26dB Emissions Bandwidth (kHz)	Remark
Analog FM	25KHz	400.025	High	11.20	14.40	For Federal
			Middle	10.50	14.40	
			Low	10.40	14.40	
		450.025	High	12.00	14.40	For Part74
			Middle	11.80	14.40	
			Low	11.80	14.40	
		459.125	High	10.50	14.30	For Part22
			Middle	10.50	14.40	
			Low	11.00	14.40	
		469.975	High	10.50	14.40	For Part90 & Part80
			Middle	10.50	14.20	
			Low	10.5	12.50	
	12.5KHz	400.025	High	7.90	8.30	For Federal
			Middle	7.90	8.30	
			Low	8.00	8.30	
		450.025	High	7.90	8.30	For Part74
			Middle	7.90	8.30	
			Low	7.90	8.30	
		459.125	High	8.00	8.34	For Part22
			Middle	7.90	8.34	
			Low	7.90	8.34	
		469.975	High	7.90	8.30	For Part90 & Part80
			Middle	7.90	8.30	
			Low	7.90	8.30	
Digital 4FSK	12.5KHz	400.025	High	7.20	9.60	For Federal
			Middle	7.30	9.50	
			Low	7.30	9.20	
		450.025	High	6.90	9.80	For Part74
			Middle	7.00	10.10	
			Low	7.10	10.40	
		459.125	High	7.20	10.00	For Part22
			Middle	7.10	9.70	
			Low	6.90	9.90	
		469.975	High	7.00	9.00	For Part90 & Part80
			Middle	7.10	9.30	
			Low	7.20	9.30	



25KHz, Analog modulation, Assigned Frequency:400.025MHz

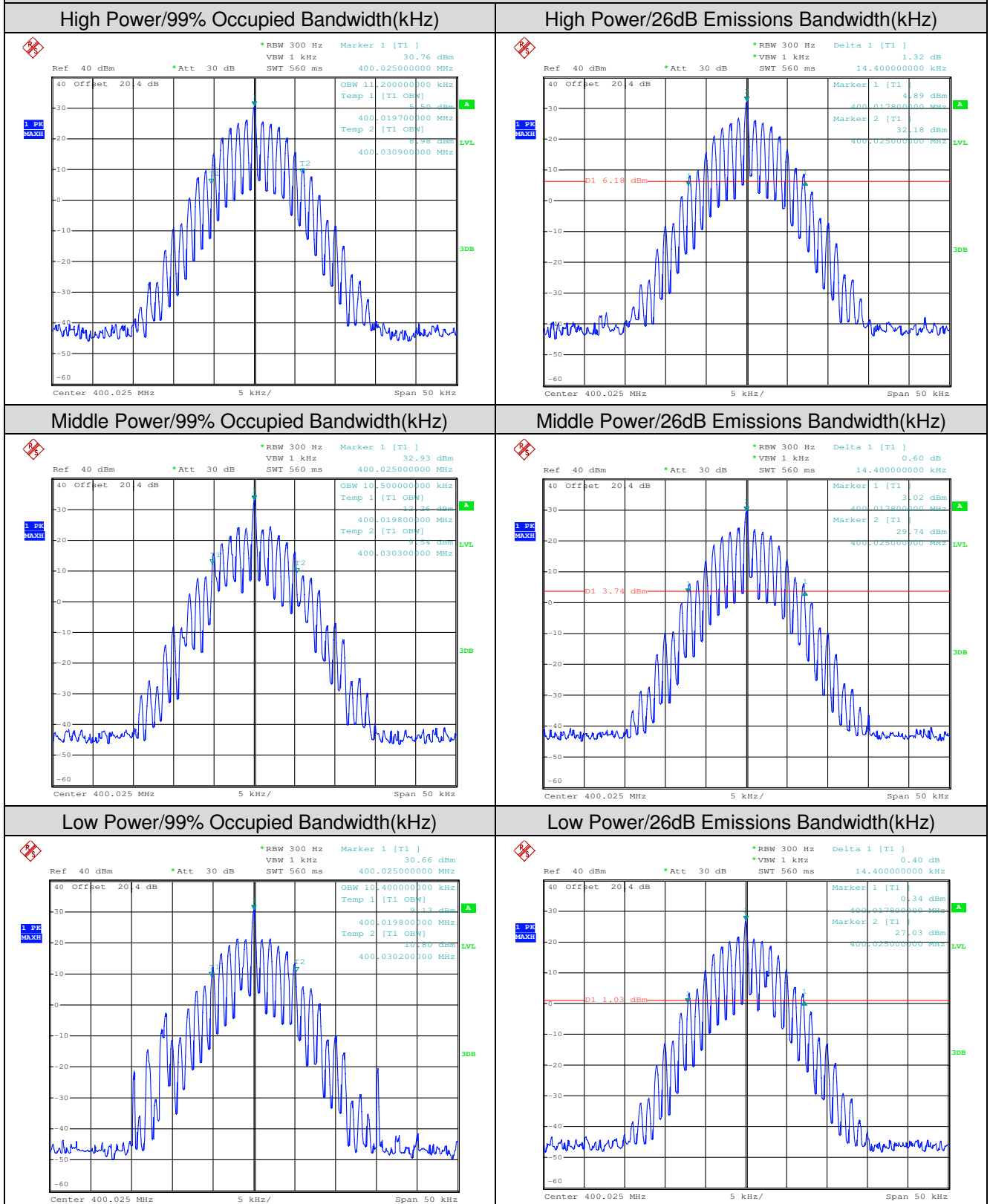

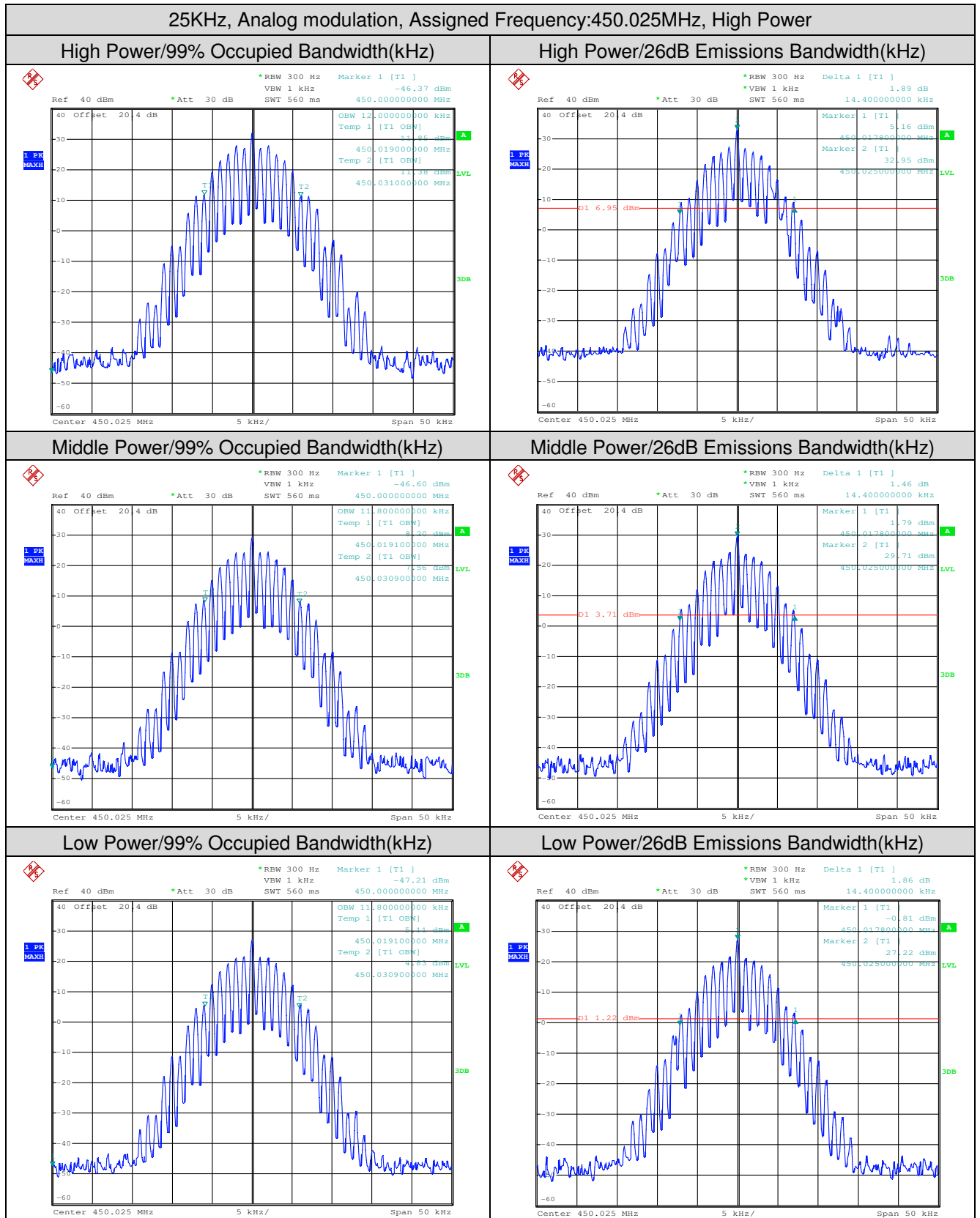



25KHz, Analog modulation, Assigned Frequency:459.125MHz

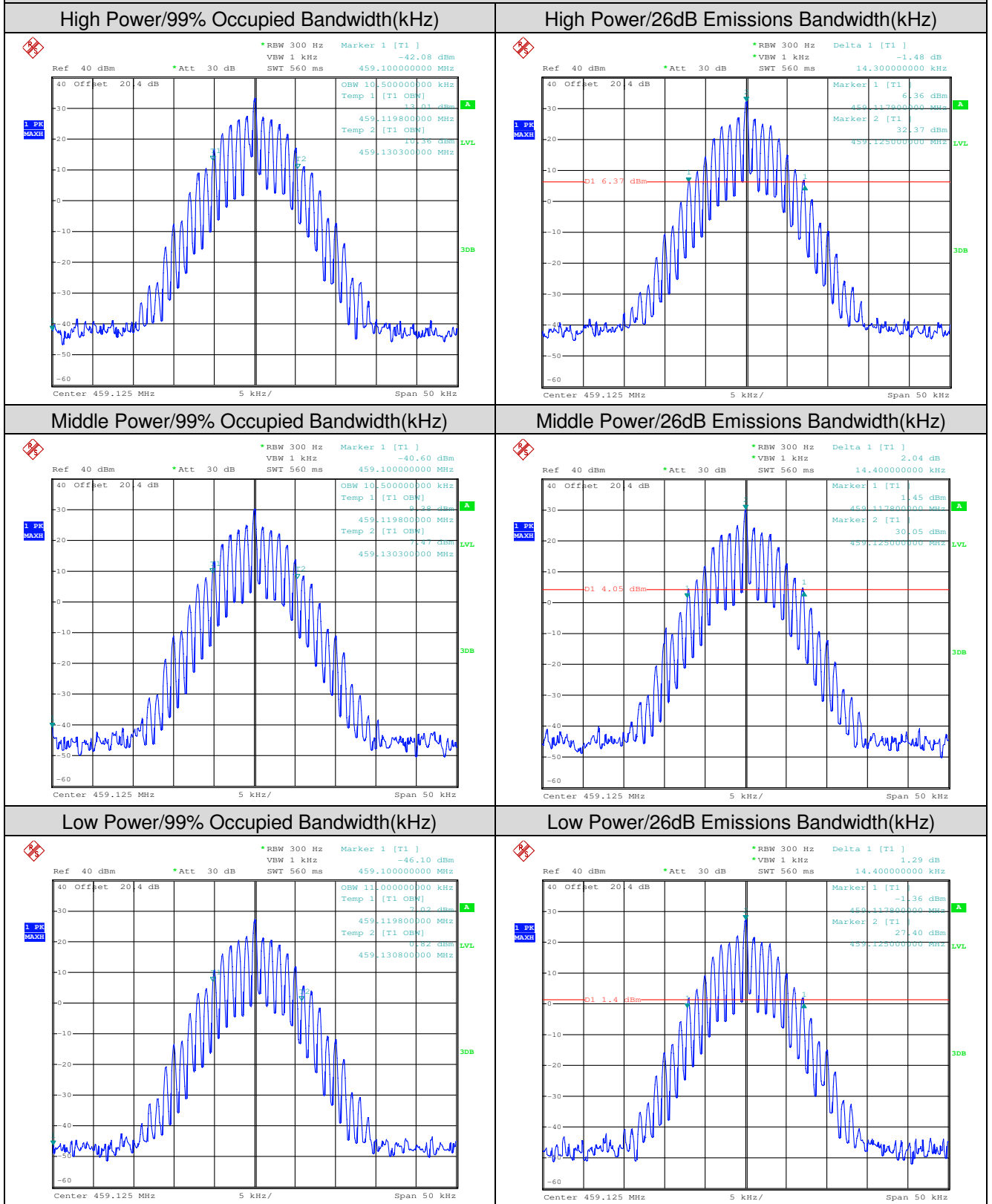

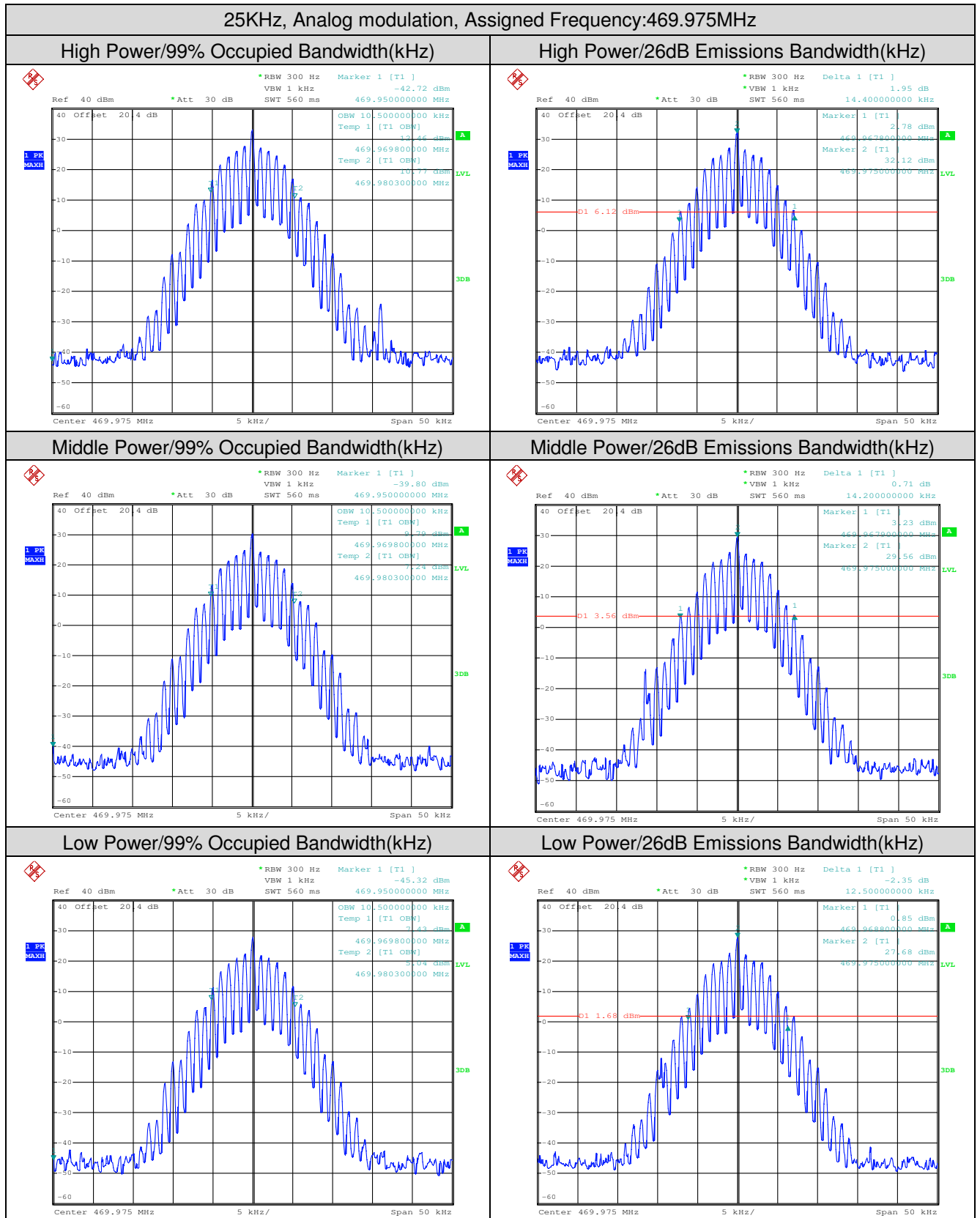



12.5KHz, Analog modulation, Assigned Frequency:400.025MHz

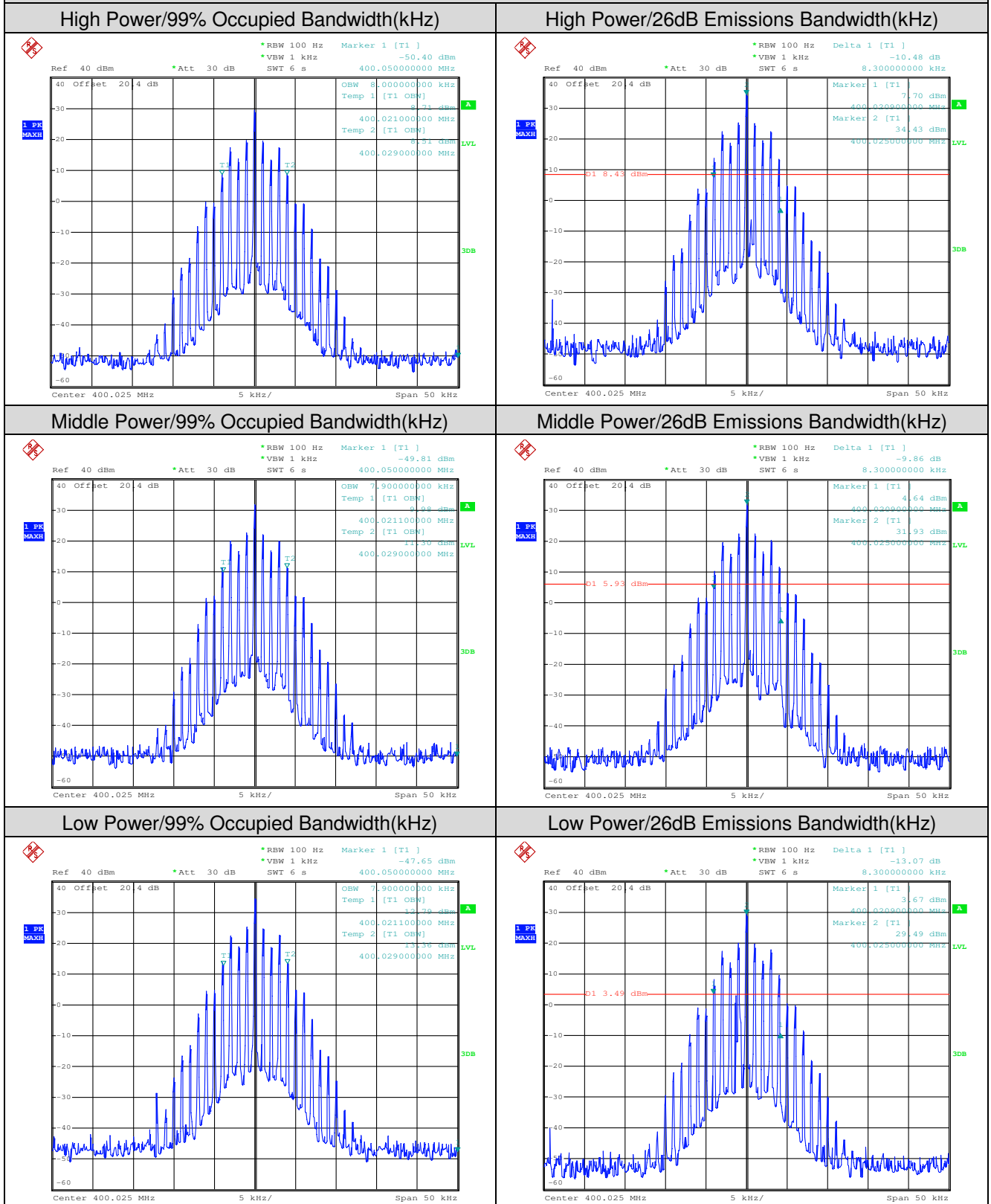



12.5KHz, Analog modulation, Assigned Frequency:450.025MHz

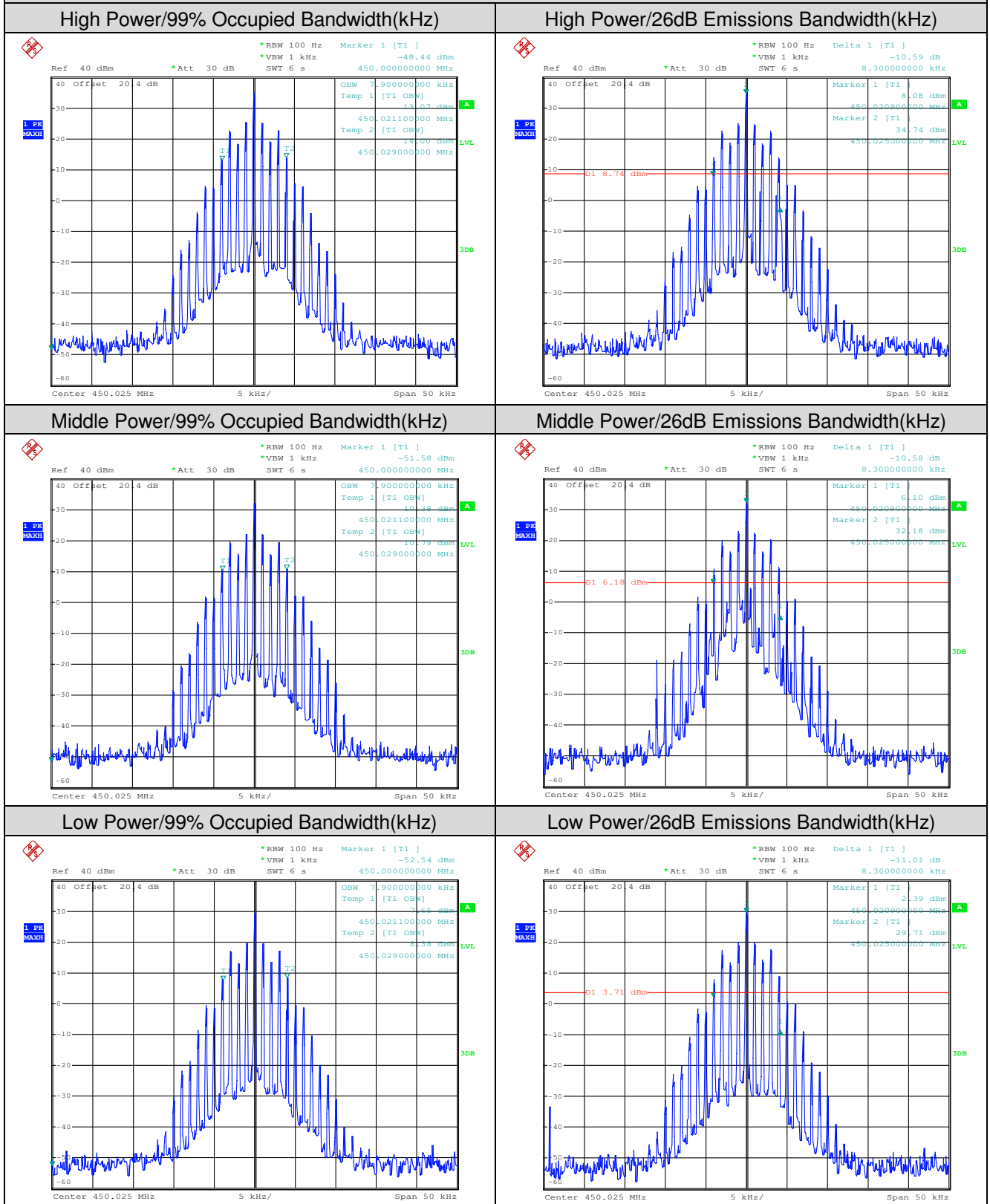



12.5KHz, Analog modulation, Assigned Frequency:459.125MHz

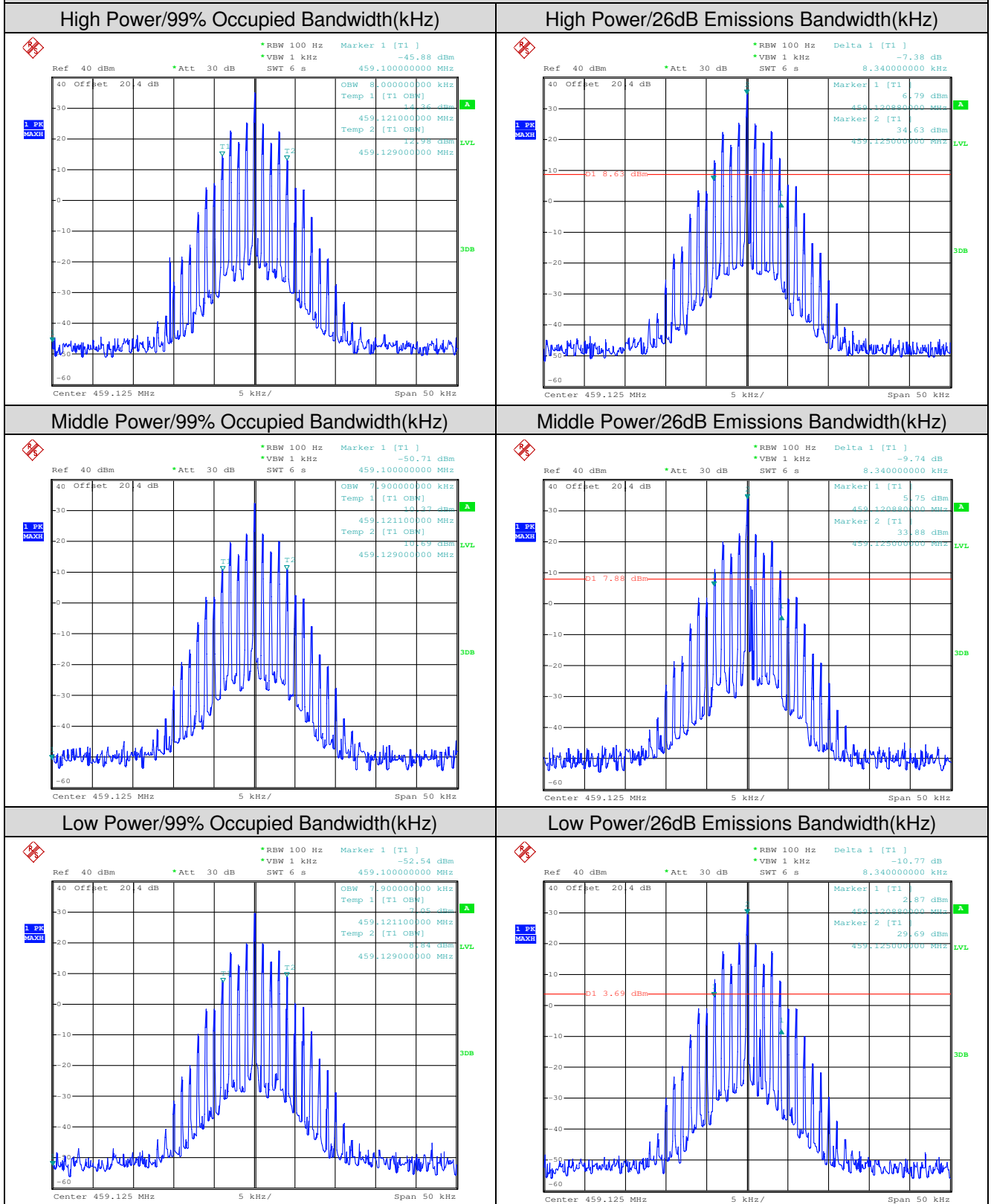



12.5KHz, Analog modulation, Assigned Frequency:469.975MHz

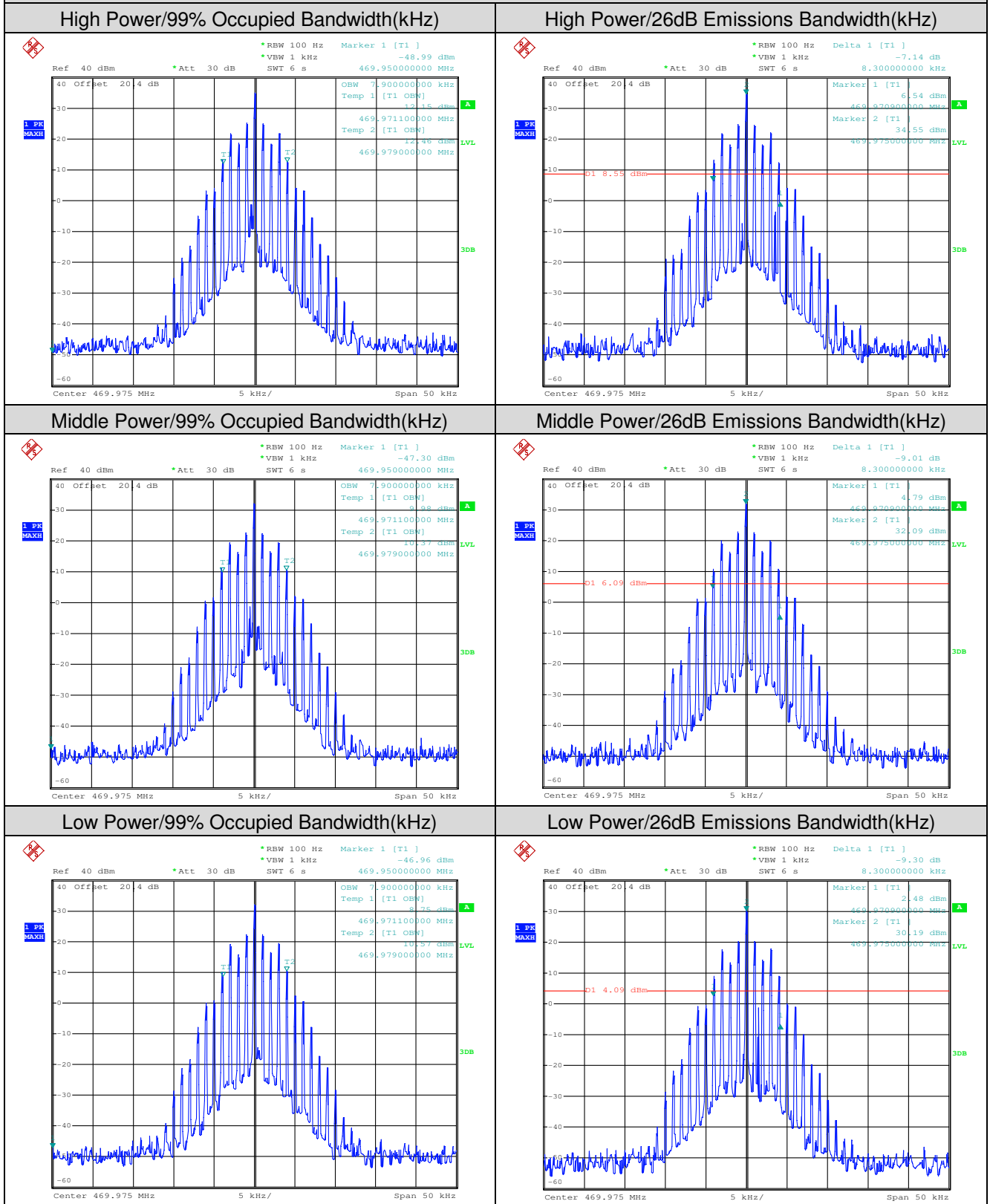



12.5KHz, Digital modulation, Assigned Frequency:400.025MHz

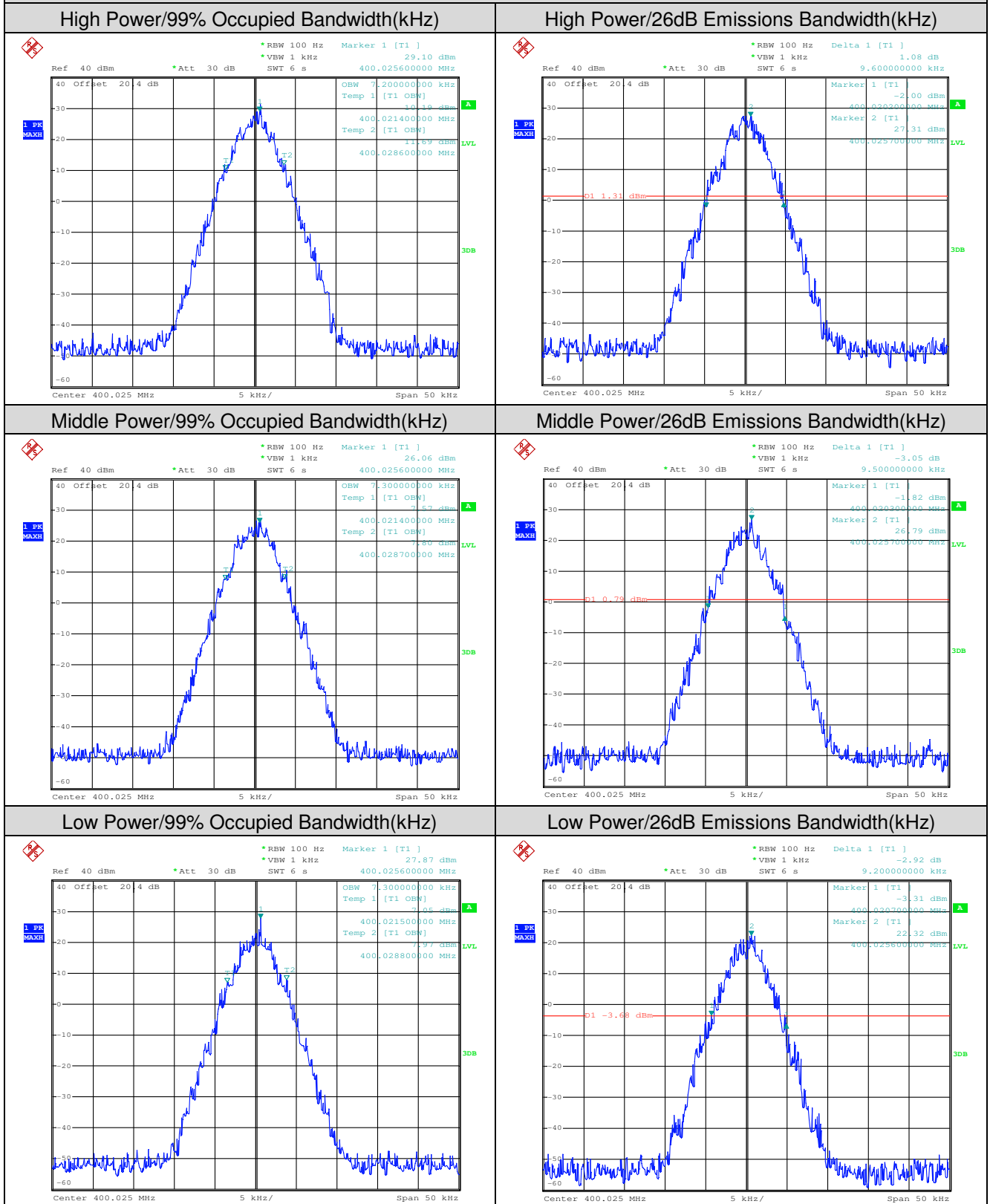



12.5KHz, Digital modulation, Assigned Frequency:450.025MHz

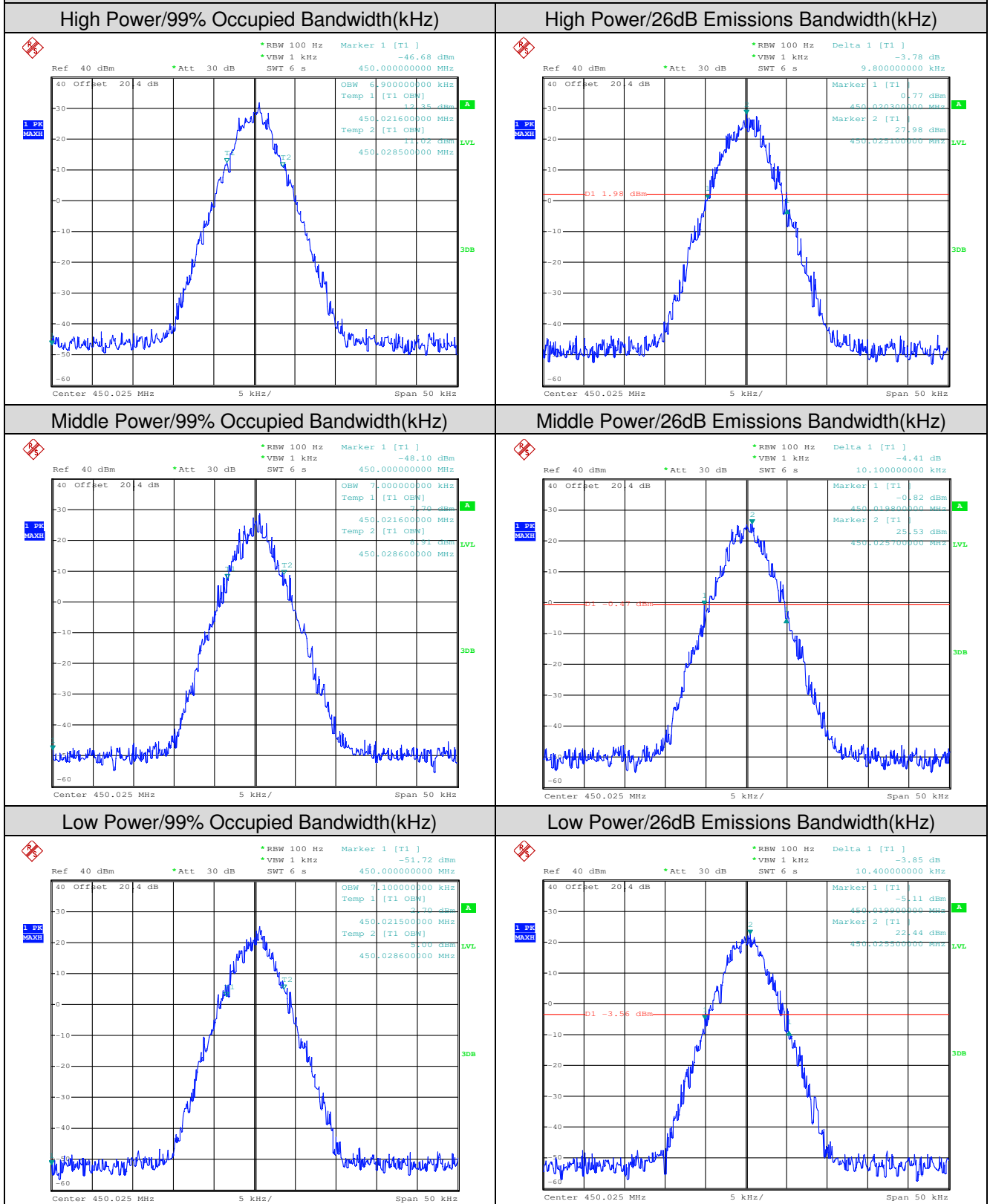



12.5KHz, Digital modulation, Assigned Frequency:459.125MHz

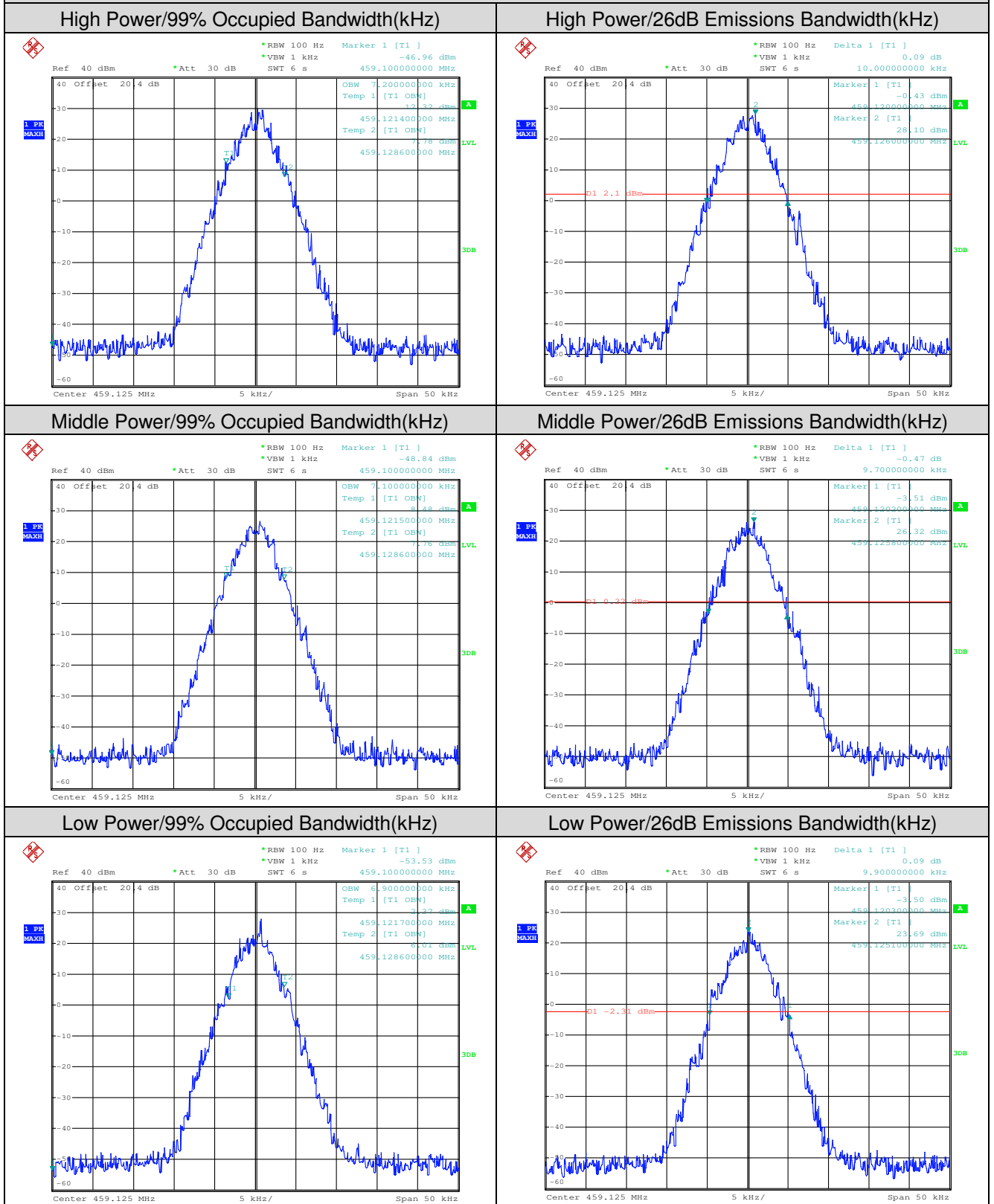



12.5KHz, Digital modulation, Assigned Frequency:469.975MHz

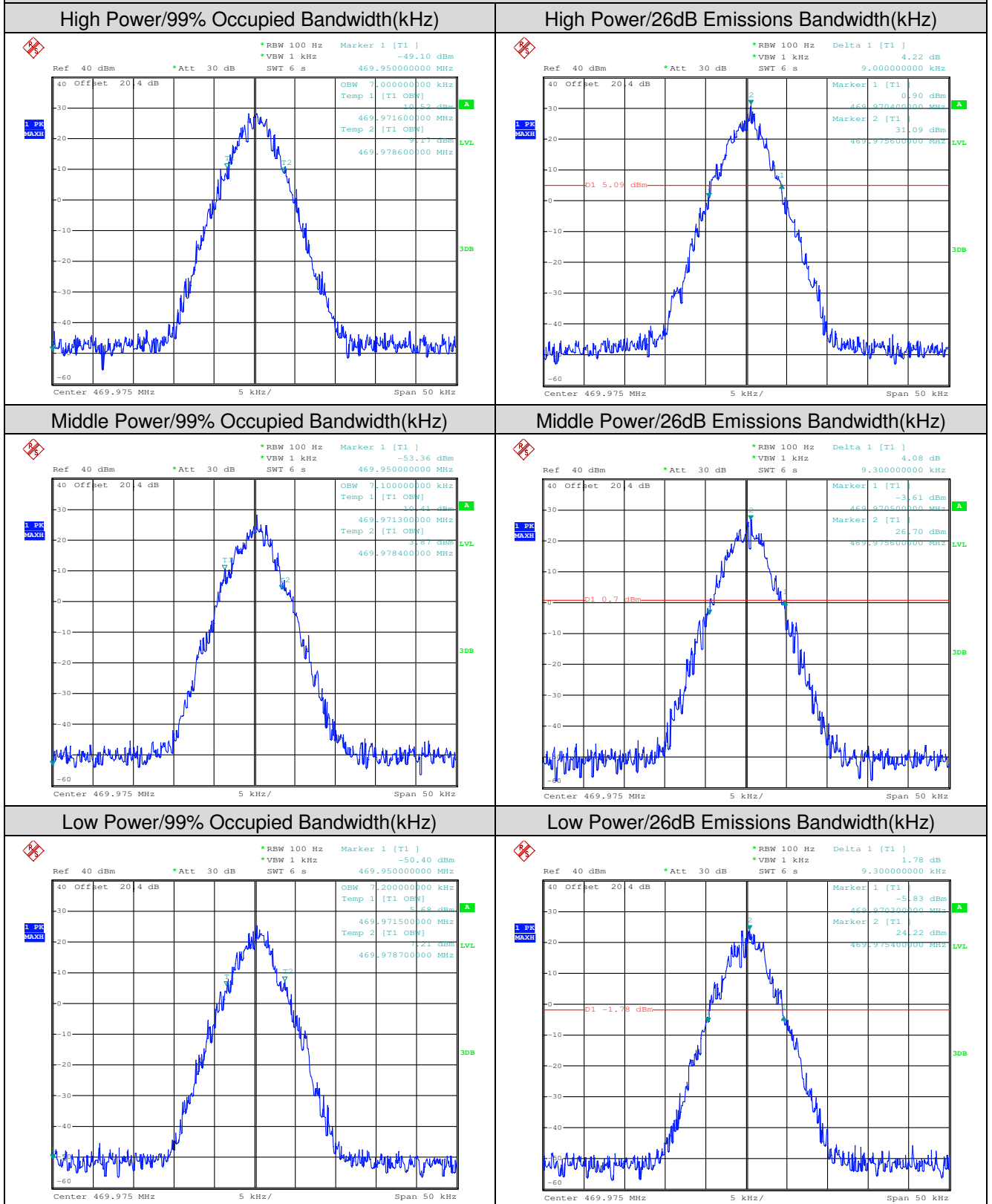

7.Emission Mask

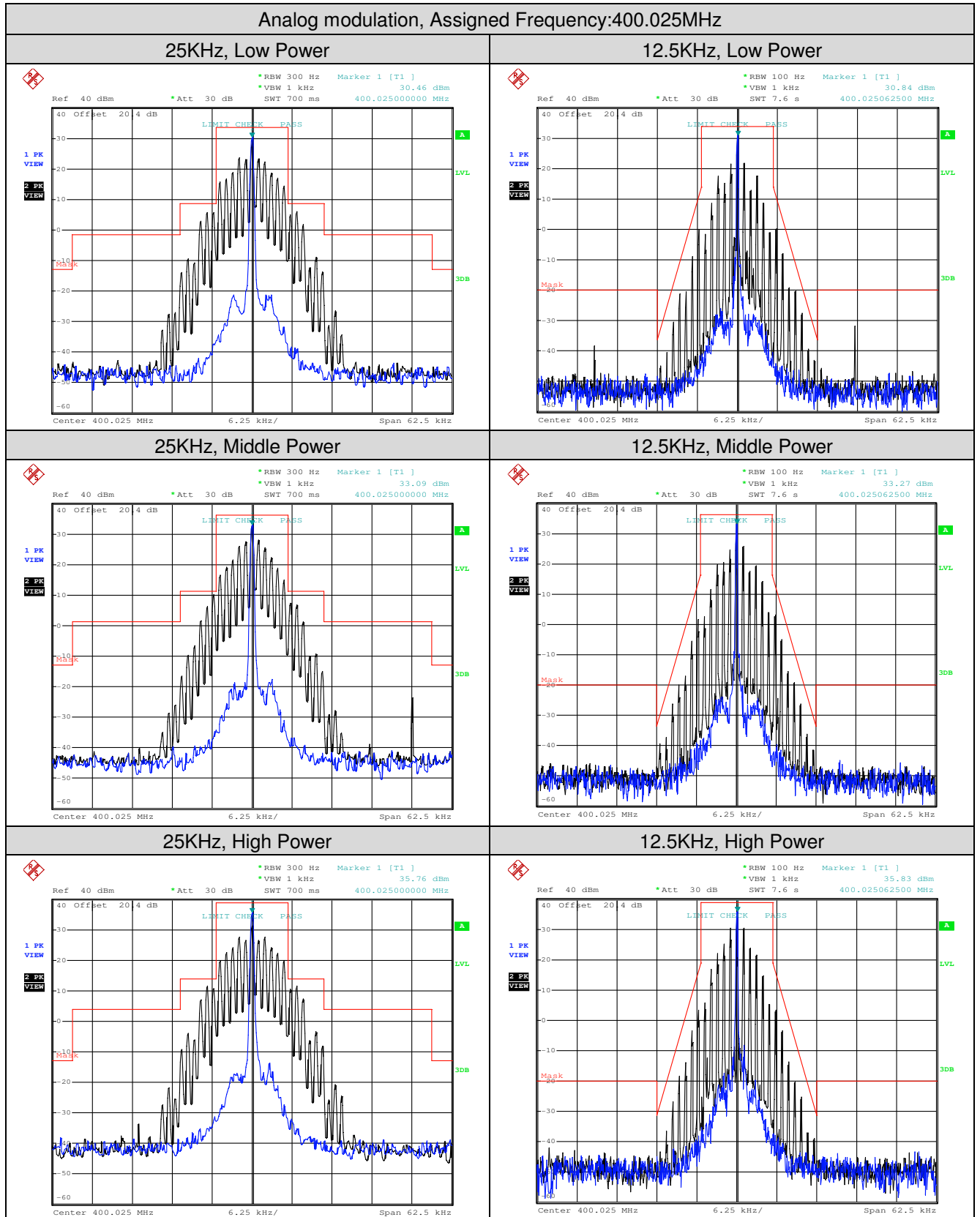

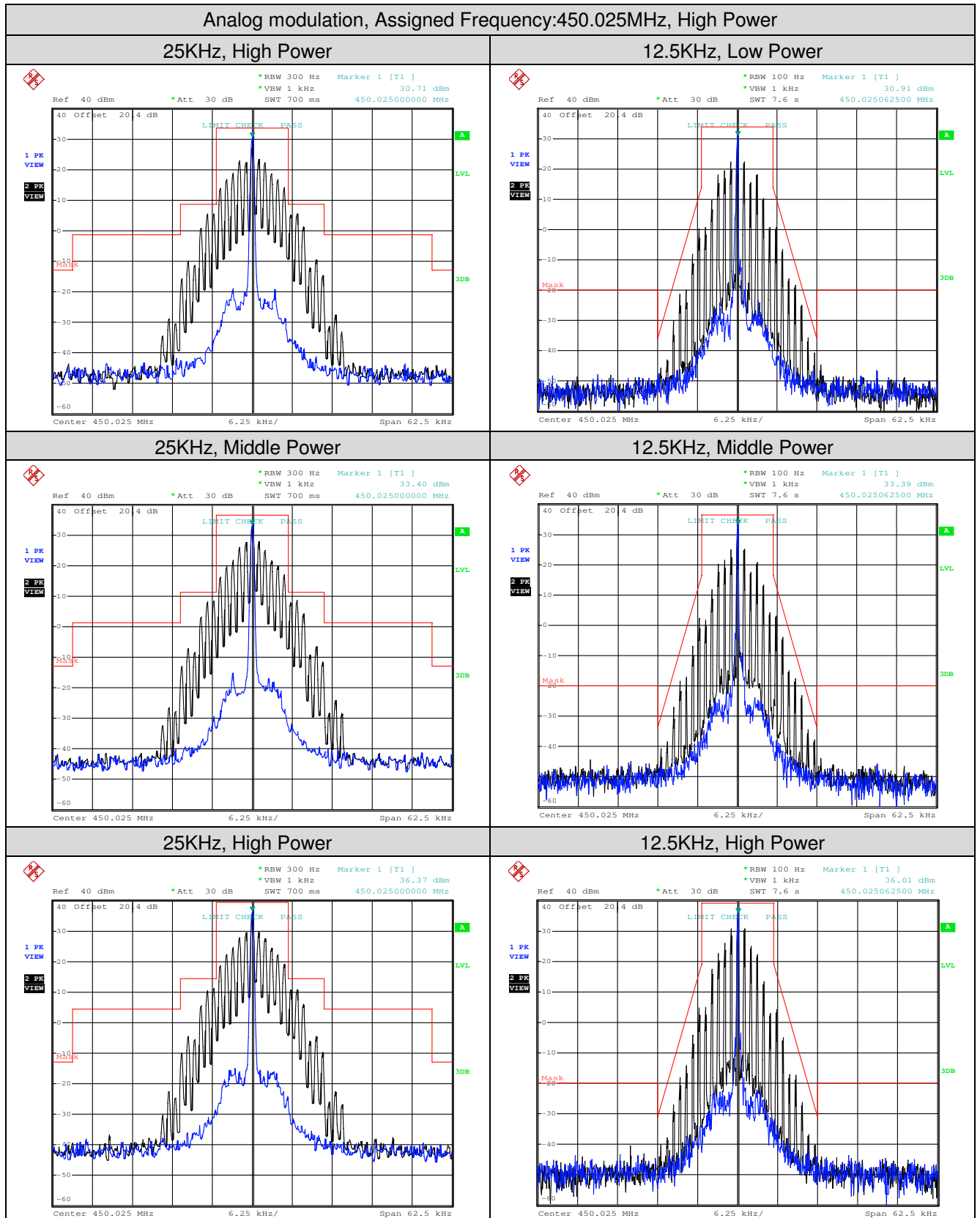

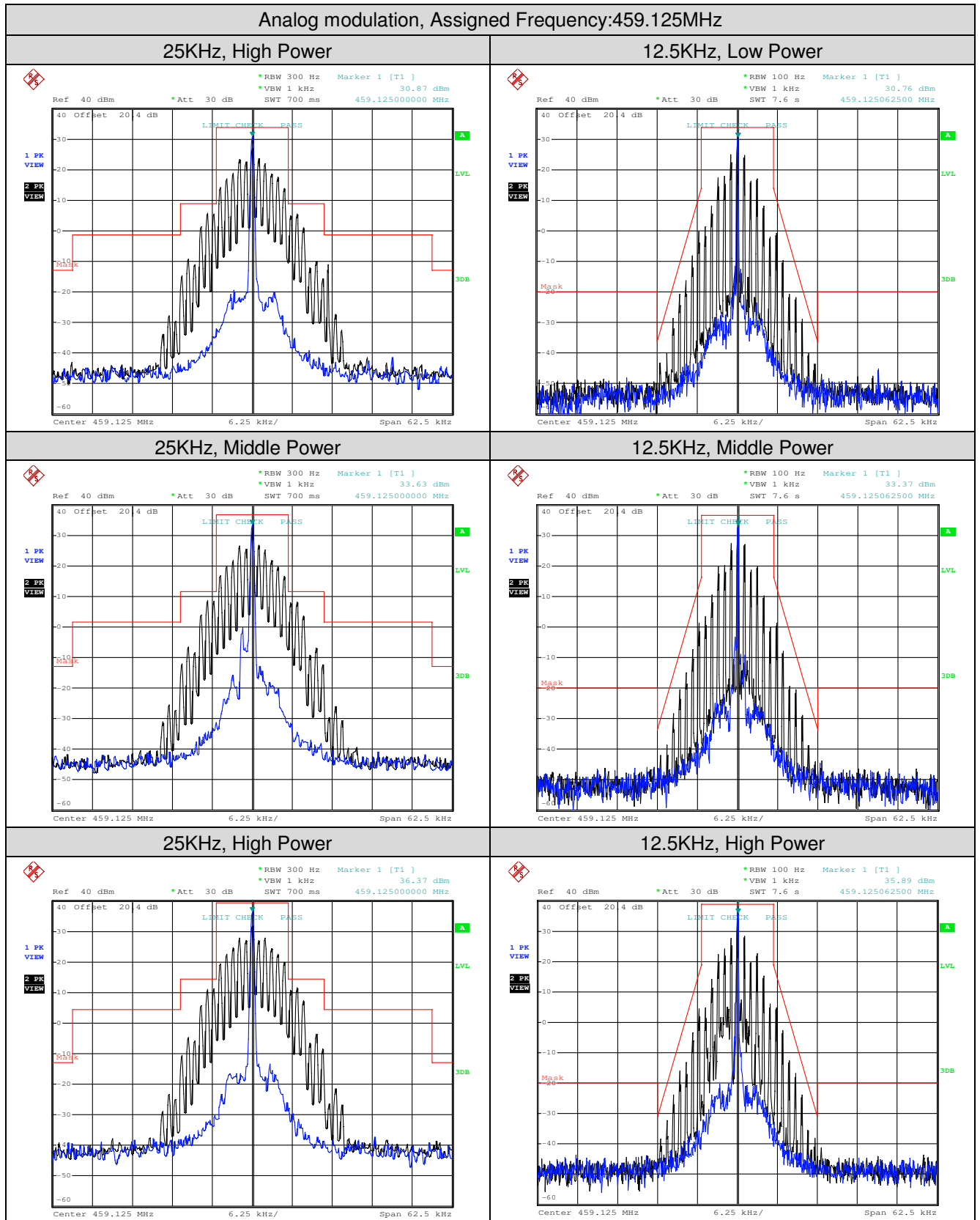

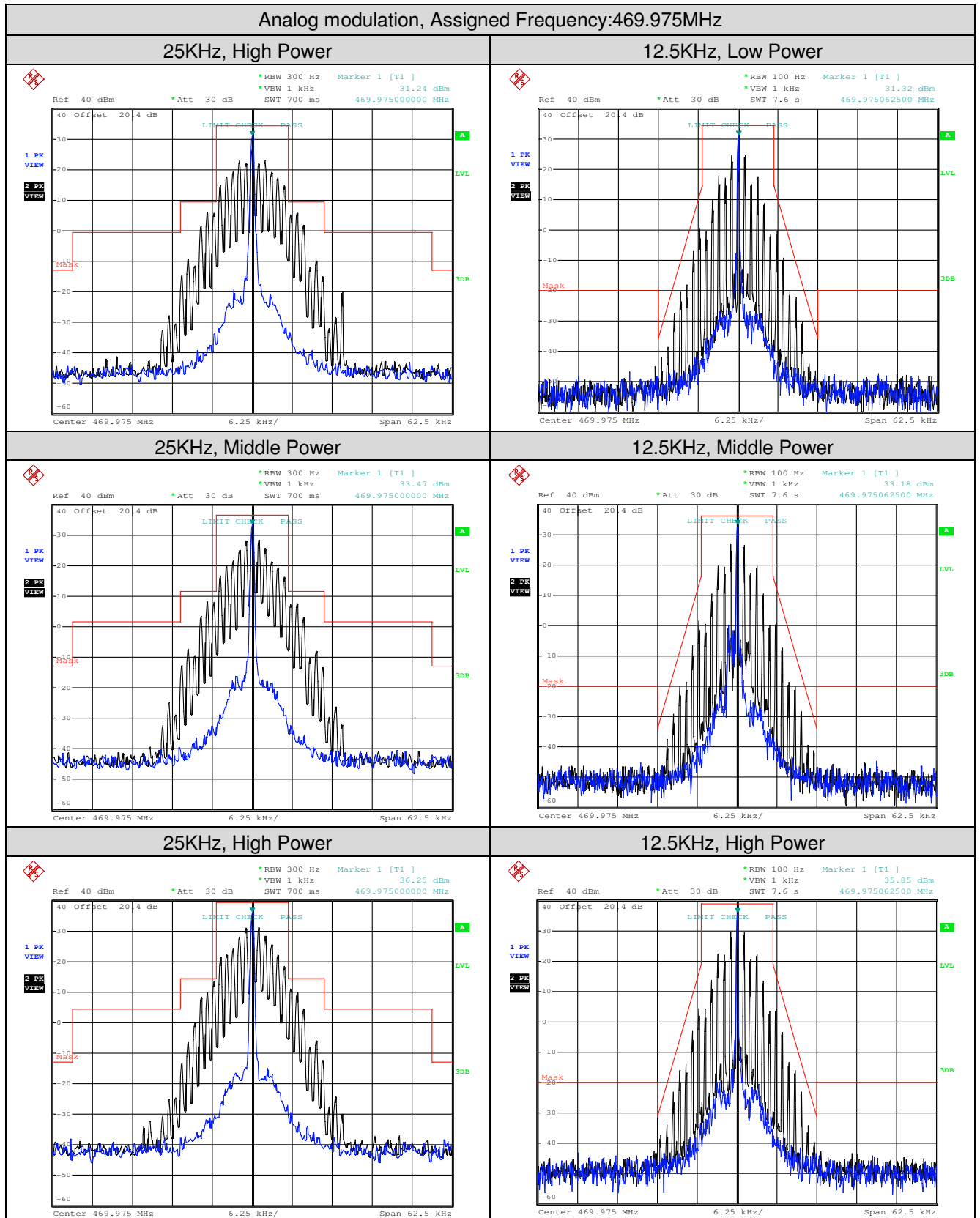

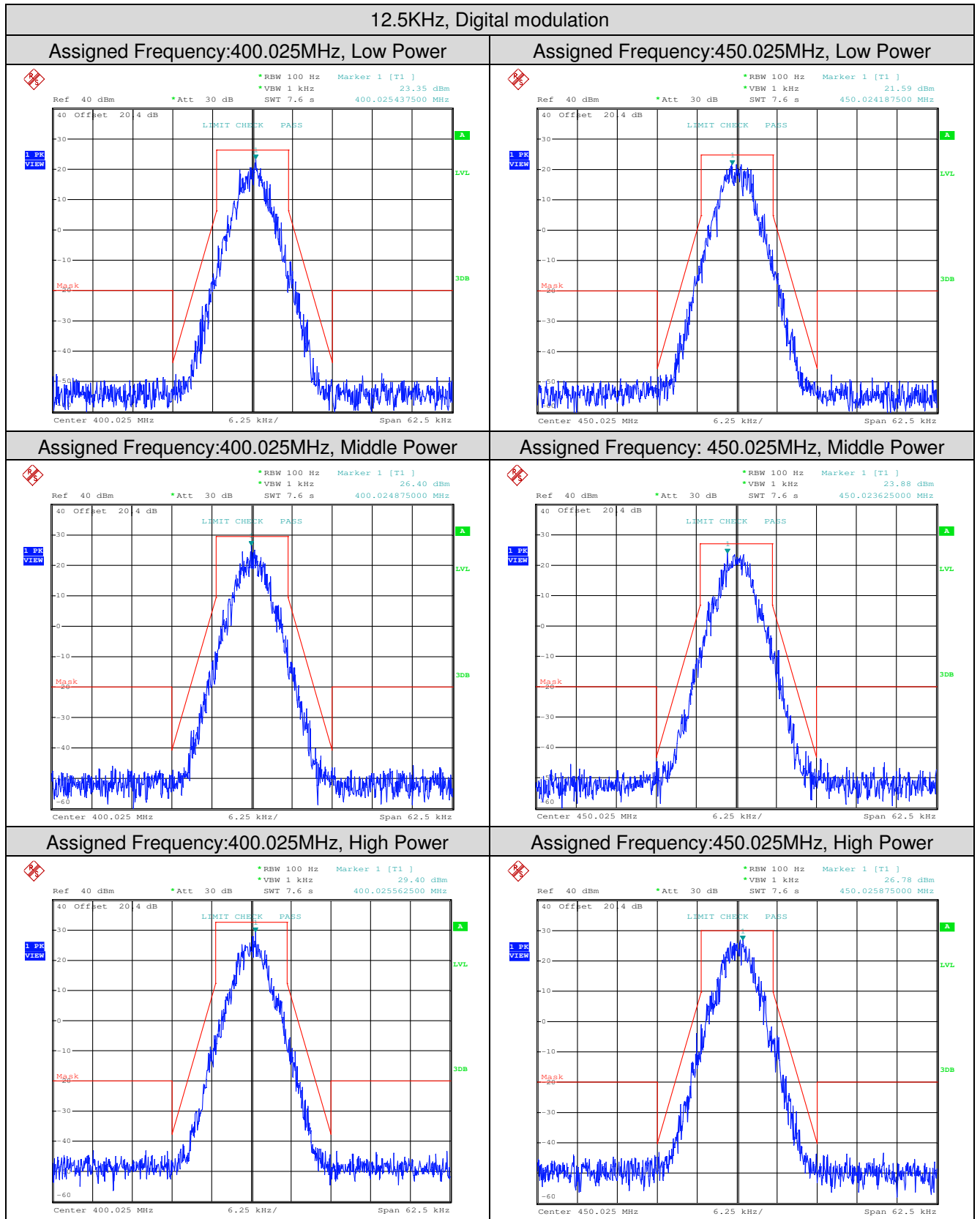

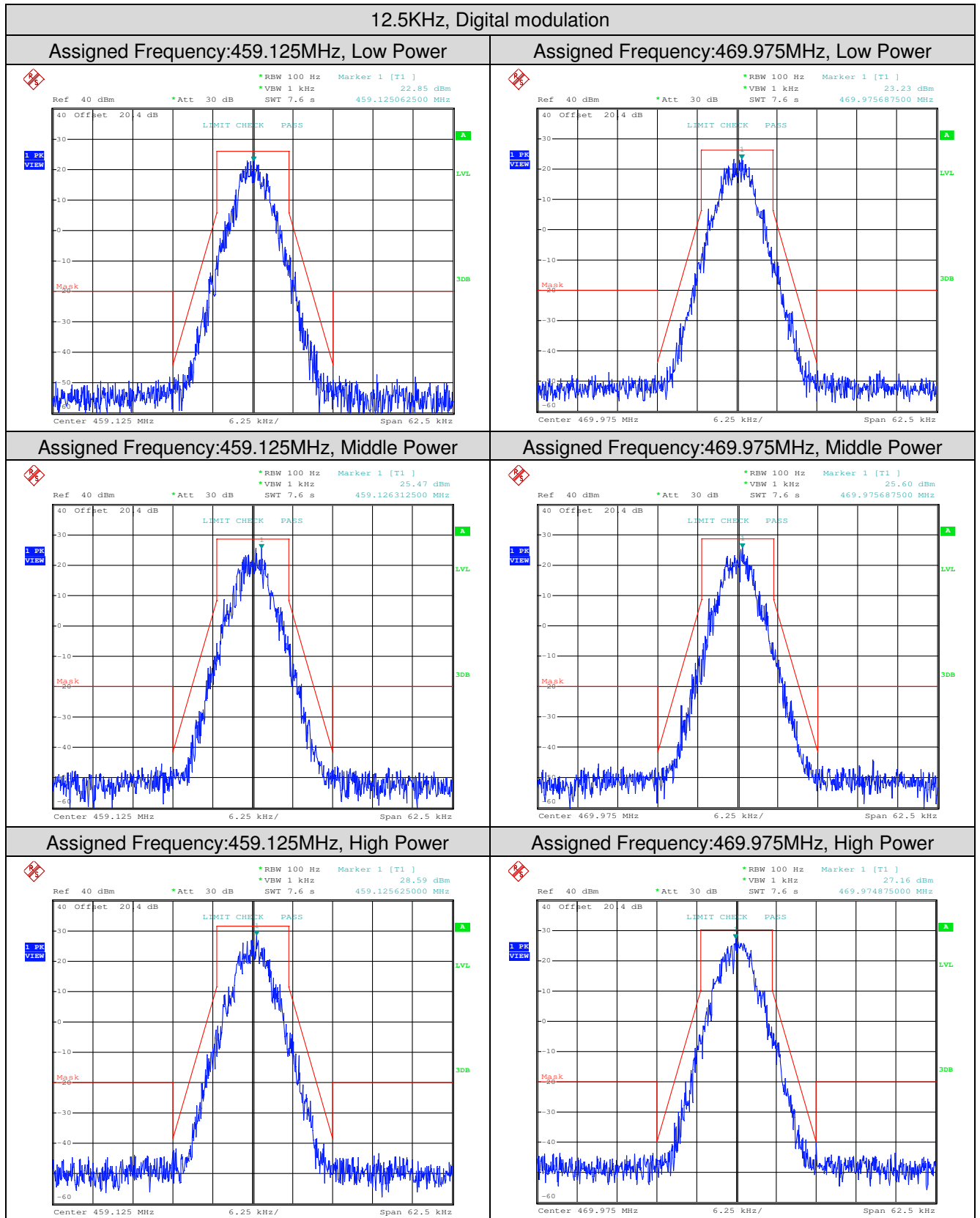

8. Transient Frequency Behavior

12.5KHz, Analog modulation, Assigned Frequency:467.775MHz, Turn On

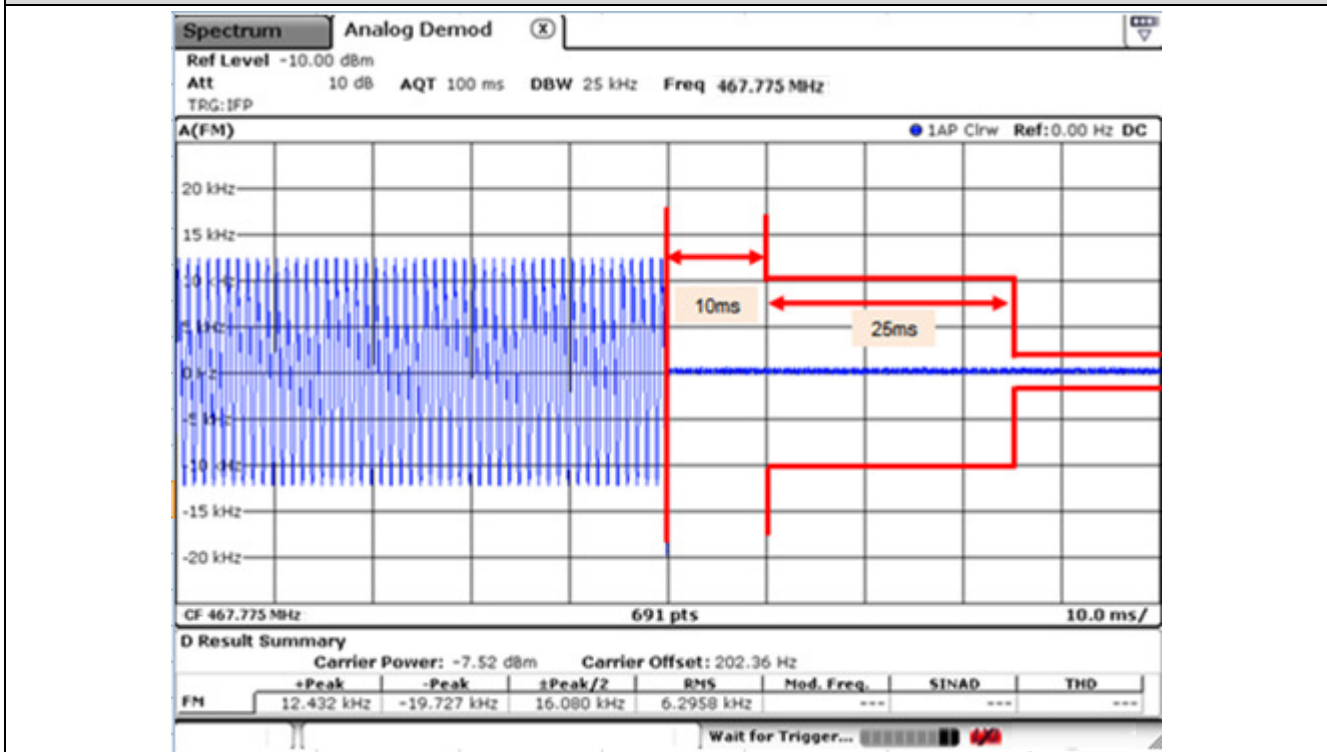

12.5KHz, Analog modulation, Assigned Frequency:467.775MHz, Turn Off

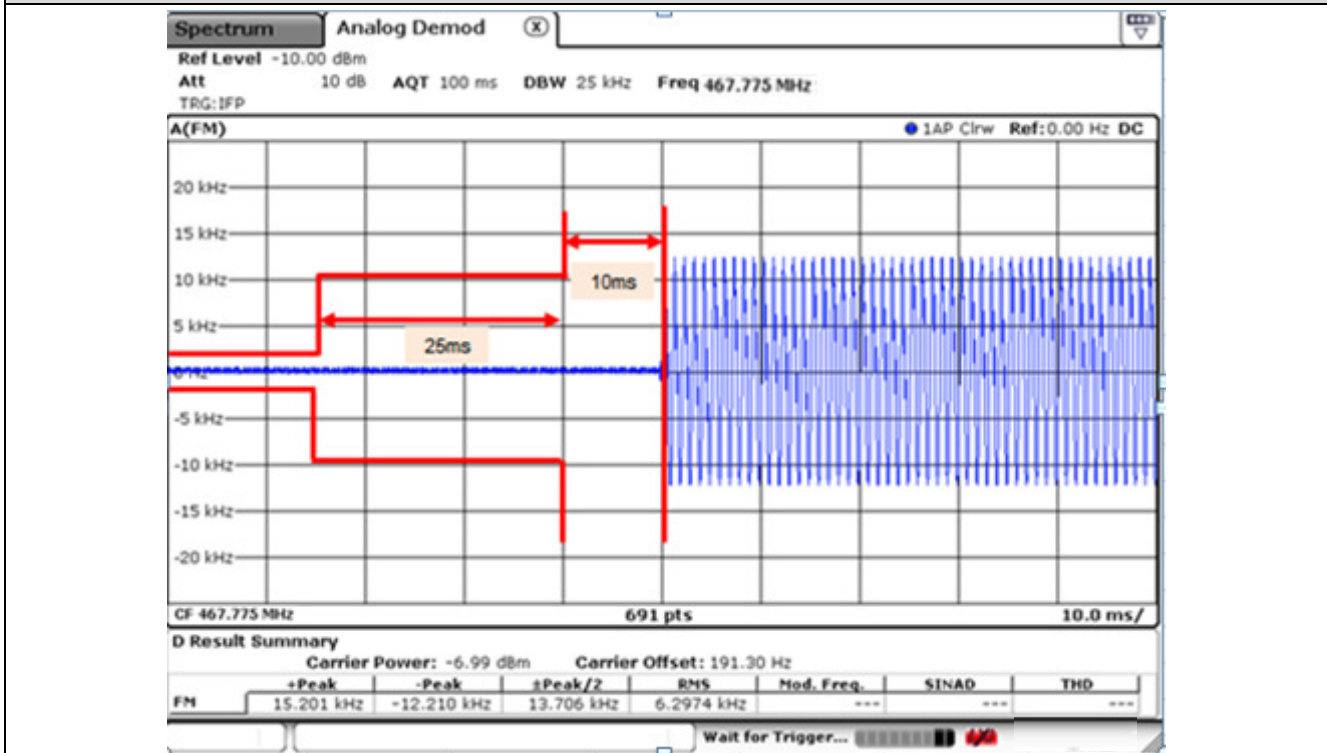

12.5KHz, Digital modulation, Assigned Frequency:467.775MHz, Turn On

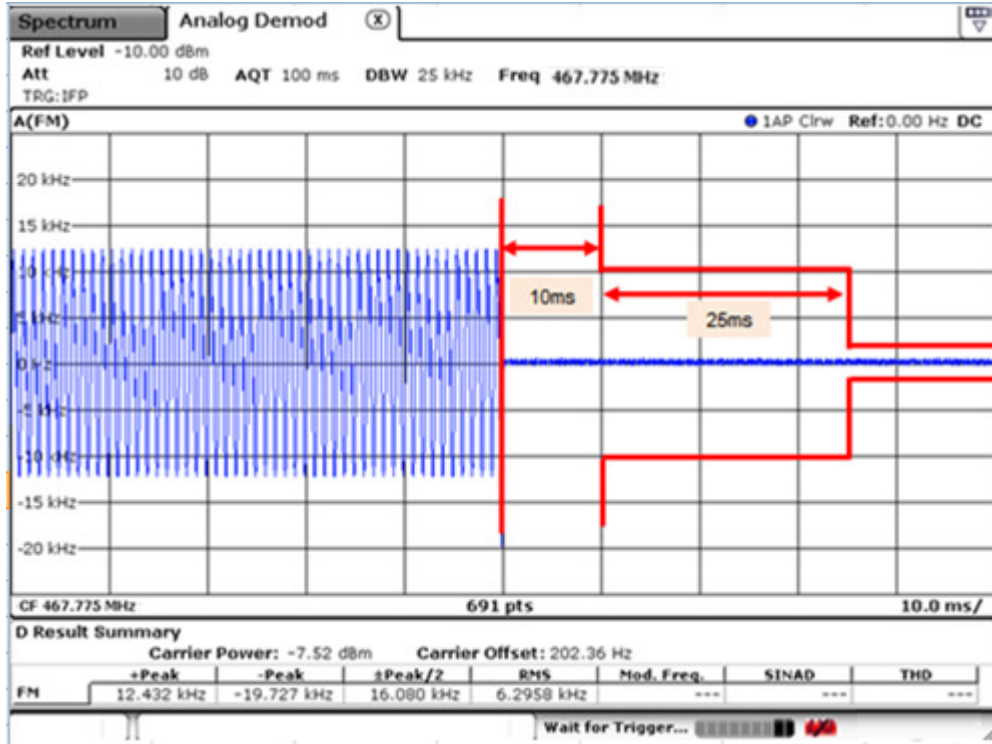

12.5KHz, Digital modulation, Assigned Frequency:467.775MHz, Turn Off

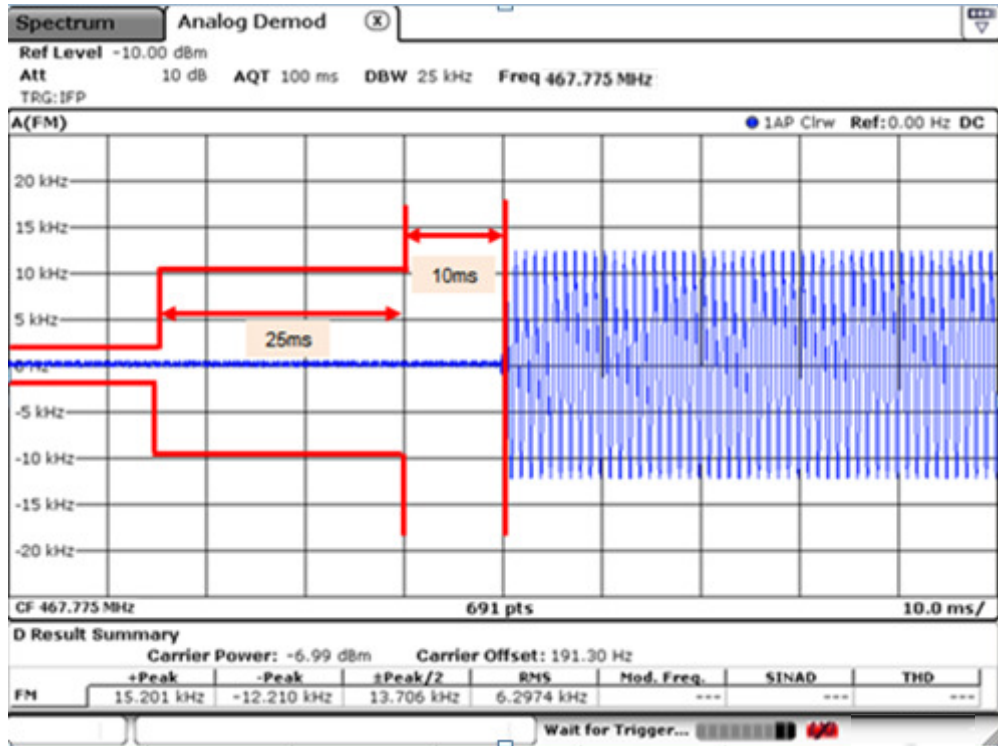



9. Conducted Spurious Emission

--Remark: Add the HPF(>1000MHz) for 1G~12.75G Spurious Emission testing

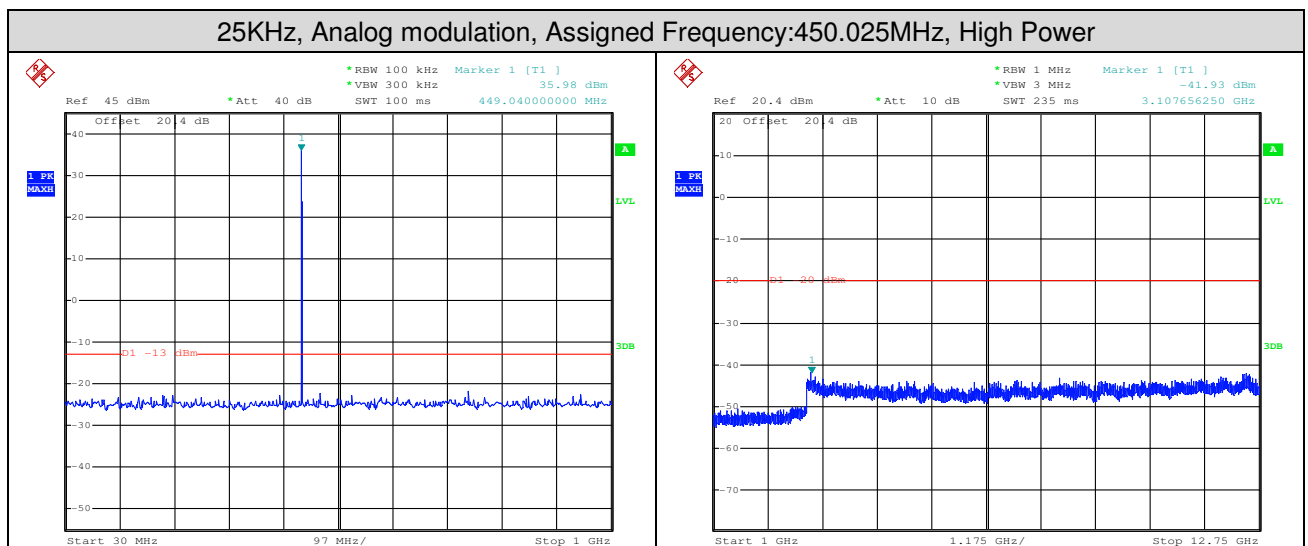
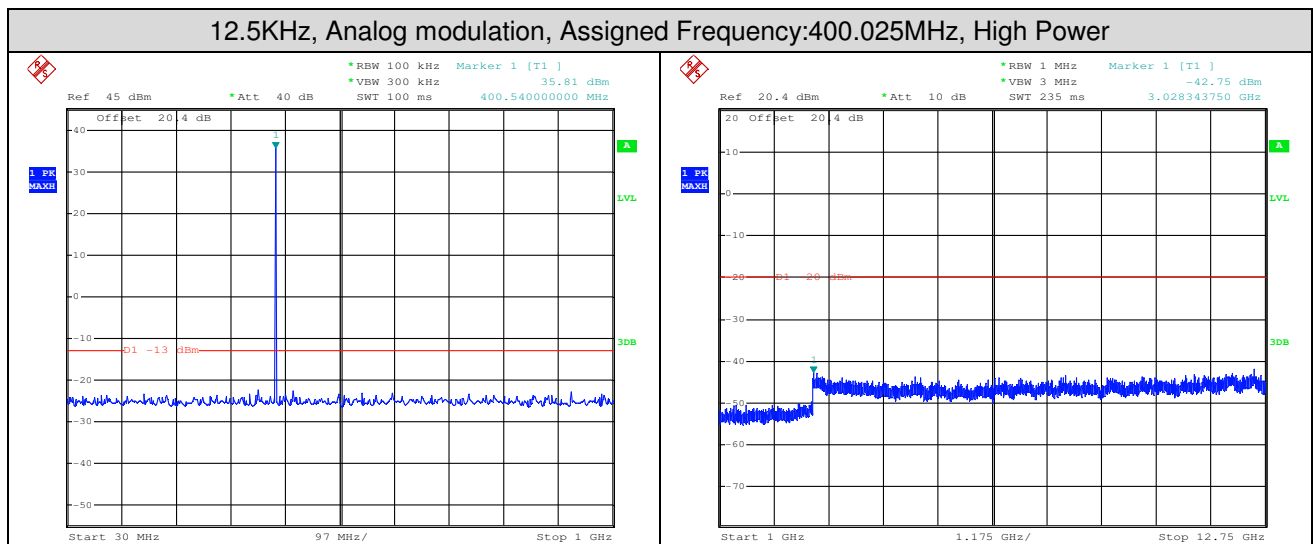
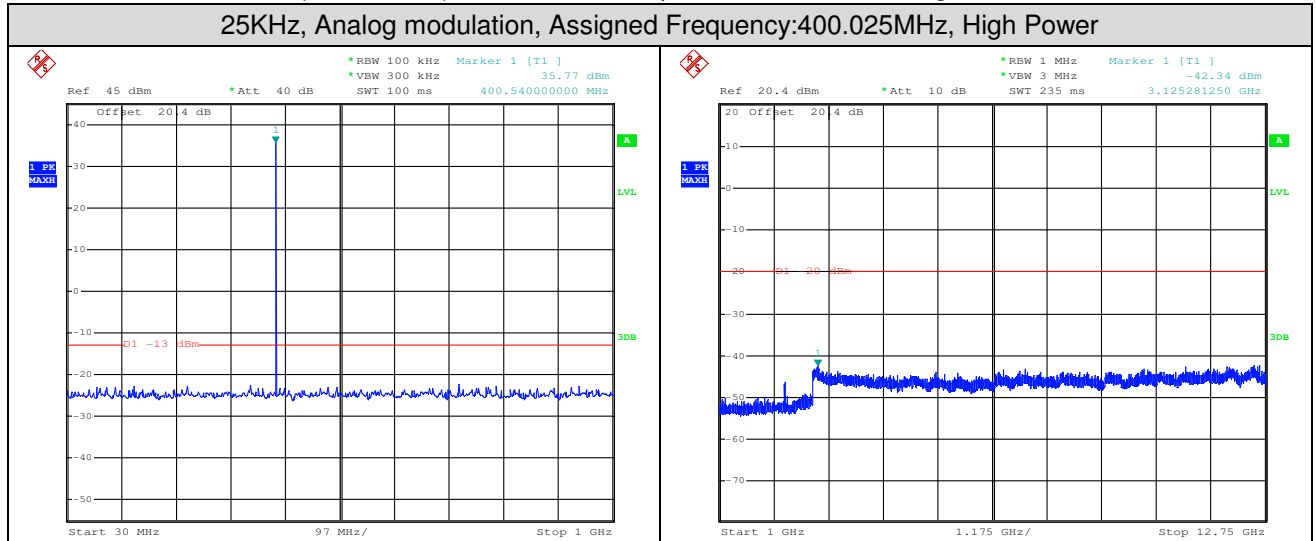

This document is issued by the Company subject to its General Conditions of Service printed overleaf, available on request or accessible at <http://www.sgs.com/en/Terms-and-Conditions.aspx> and, for electronic format documents, subject to Terms and Conditions for Electronic Documents at <http://www.sgs.com/en/Terms-and-Conditions/Terms-e-Document.aspx>. Attention is drawn to the limitation of liability, indemnification and jurisdiction issues defined therein. Any holder of this document is advised that information contained hereon reflects the Company's findings at the time of its intervention only and within the limits of Client's instructions, if any. The Company's sole responsibility is to its Client and this document does not exonerate parties to a transaction from exercising all their rights and obligations under the transaction documents. This document cannot be reproduced except in full, without prior written approval of the Company. Any unauthorized alteration, forgery or falsification of the content or appearance of this document is unlawful and offenders may be prosecuted to the fullest extent of the law. Unless otherwise stated the results shown in this test report refer only to the sample(s) tested and such sample(s) are retained for 30 days only.

12.5KHz, Analog modulation, Assigned Frequency:450.025MHz, High Power

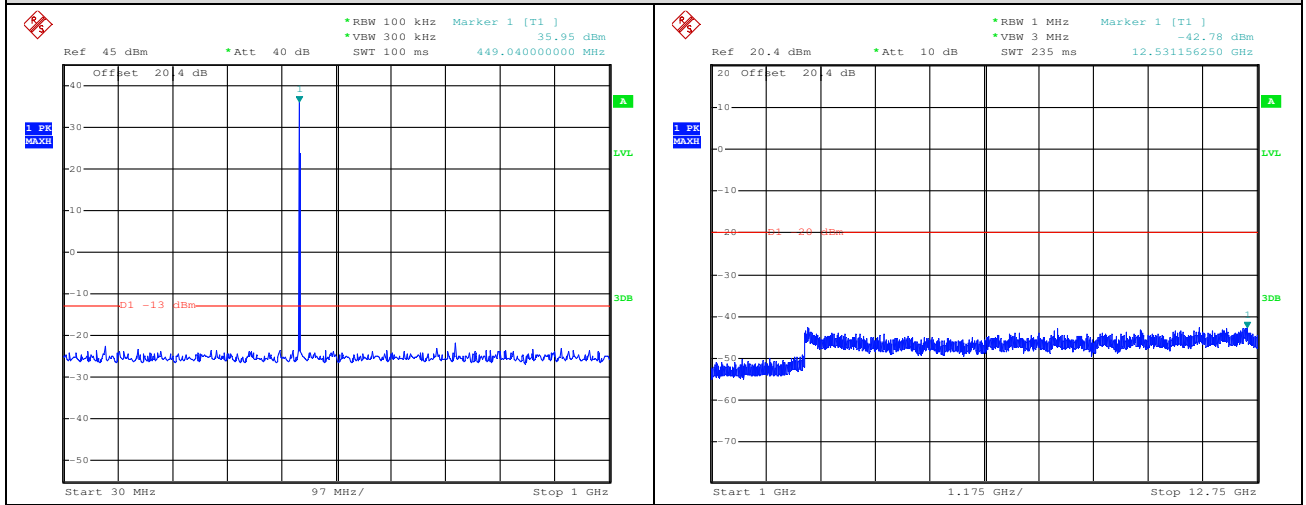

25KHz, Analog modulation, Assigned Frequency:459.125MHz, High Power

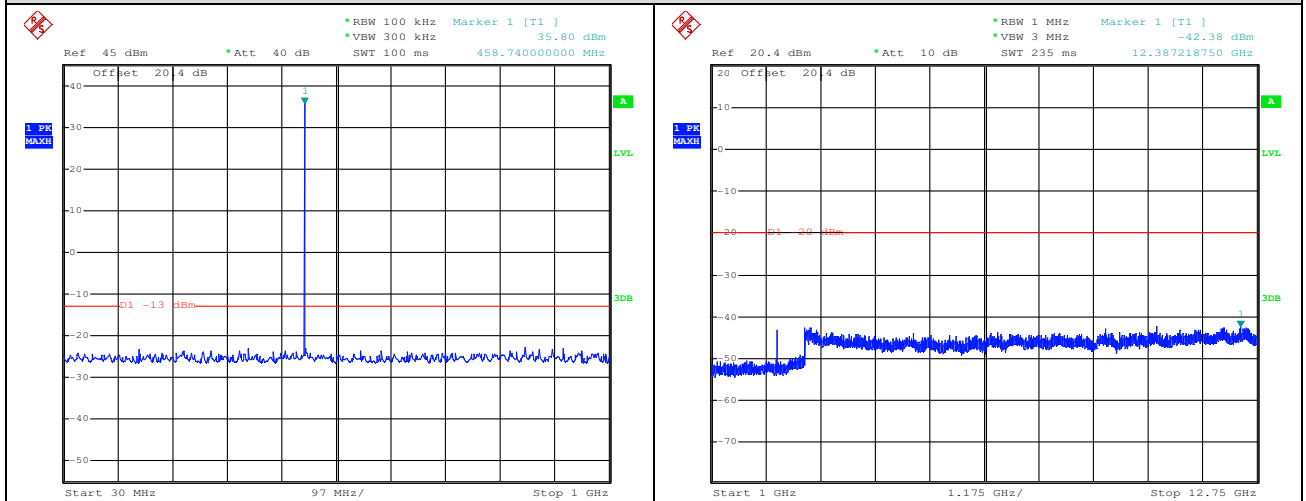

12.5KHz, Analog modulation, Assigned Frequency:459.125MHz, High Power

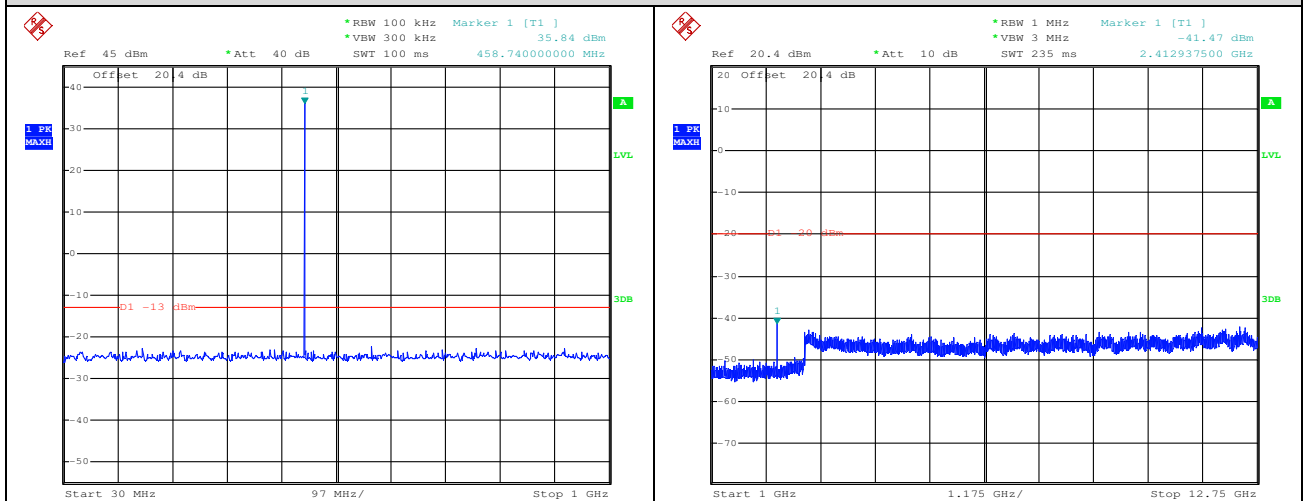

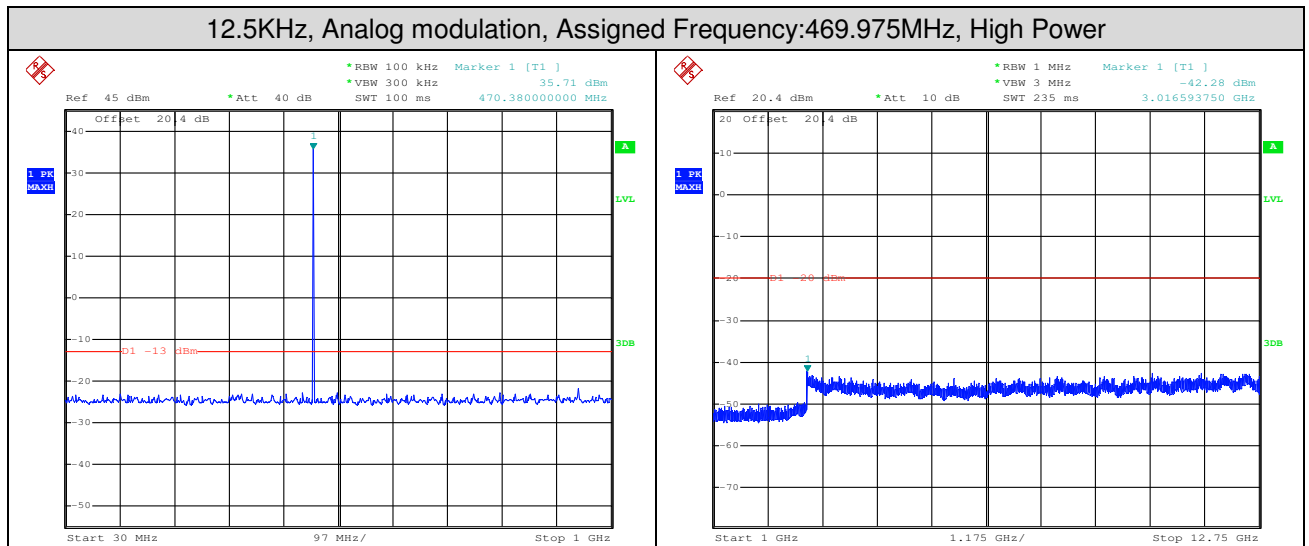
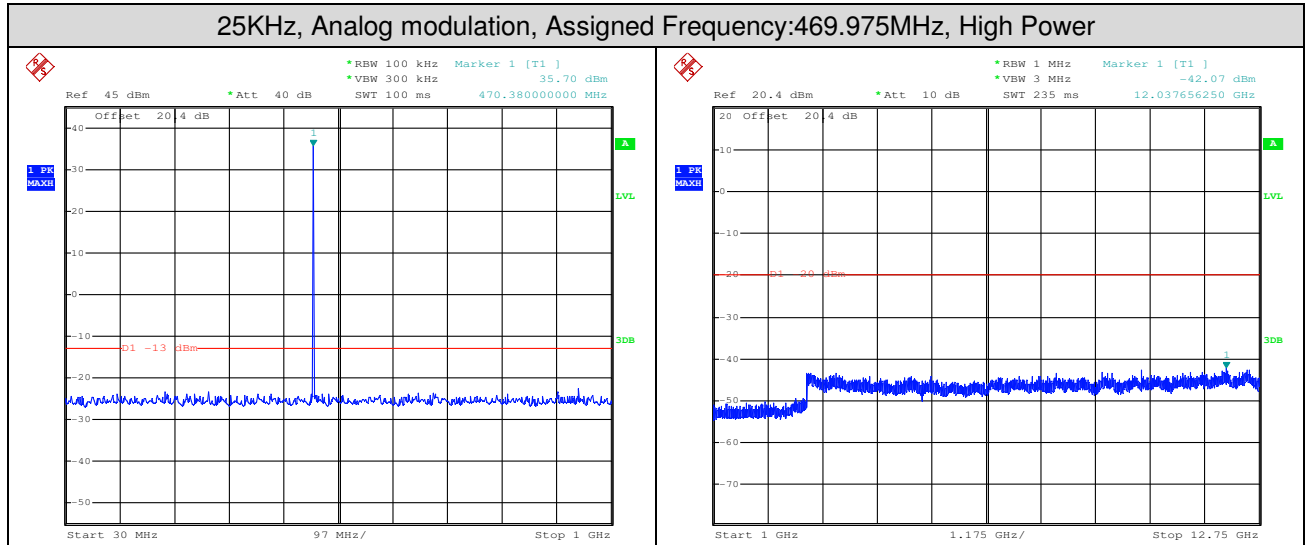



10. Radiated Spurious Emission

12.5KHz, Analog modulation, Assigned Frequency:400.025MHz, High Power				
Frequency MHz	Polarity H/V	Emission Level dBm	Limit dBm	Over Limit dBm
1293.173	H	-58.13	-20.00	-38.13
3786.01	H	-50.04	-20.00	-30.04
4946.072	H	-47.09	-20.00	-27.09
2590.961	V	-56.07	-20.00	-36.07
3815.033	V	-50.62	-20.00	-30.62
4933.497	V	-47.28	-20.00	-27.28

12.5KHz, Analog modulation, Assigned Frequency:450.025MHz, High Power				
Frequency MHz	Polarity H/V	Emission Level dBm	Limit dBm	Over Limit dBm
1779.227	H	-57.80	-20.00	-37.80
3827.727	H	-49.23	-20.00	-29.23
4857.229	H	-45.77	-20.00	-25.77
3026.156	V	-51.35	-20.00	-31.35
3984.88	V	-48.66	-20.00	-28.66
4943.986	V	-46.20	-20.00	-26.20

12.5KHz, Analog modulation, Assigned Frequency:459.125MHz, High Power				
Frequency MHz	Polarity H/V	Emission Level dBm	Limit dBm	Over Limit dBm
1297.876	H	-57.24	-20	-37.24
2892.812	H	-52.14	-20	-32.14
4904.36	H	-45.71	-20	-25.71
1293.705	V	-56.66	-20	-36.66
3170.746	V	-50.47	-20	-30.47
4912.26	V	-46.49	-20	-26.49

12.5KHz, Analog modulation, Assigned Frequency:469.975MHz, High Power				
Frequency MHz	Polarity H/V	Emission Level dBm	Limit dBm	Over Limit dBm
2854.107	H	-54.41	-20	-34.41
3795.66	H	-50.2	-20	-30.20
4871.103	H	-47.13	-20	-27.13
2818.011	V	-50.74	-20	-30.74
3291.385	V	-41.3	-20	-21.30
4234.716	V	-43.91	-20	-23.91

Note: Margin = Emission level – Limit.

All modes have been tested and we found 12.5KHz bandwidth, analog modulation has the worst test result. Only record the worst test result.

- End of the Report -