



TEST REPORT

Report Reference No.: **TRE18100262** R/C.....: 54779

FCC ID: **2AARFBFTD51601**

Applicant's name: **Fujian BelFone Communications Technology Co., Ltd.**

Address: A15, Huaqiao Economic Development Zone, Shuangyang, Luojiang, Quanzhou,Fujian, China

Manufacturer.....: Fujian BelFone Communications Technology Co., Ltd.

Address.....: A15, Huaqiao Economic Development Zone, Shuangyang, Luojiang, Quanzhou,Fujian, China

Test item description: **DMR RADIO**

Trade Mark.....: BelFone

Model/Type reference: BF-TD516 (400-480MHZ)

Listed Model(s).....: -

Standard.....: **FCC CFR Title 47 Part 2**
FCC CFR Title 47 Part 90

Date of receipt of test sample.....: Oct. 31, 2018

Date of testing.....: Oct. 31, 2018- Nov. 27, 2018

Date of issue.....: Nov. 28, 2018

Result: **PASS**

Compiled by
(position+printed name+signature) .: File administrators Fanghui Zhu 

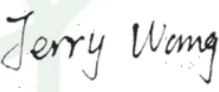
Supervised by
(position+printed name+signature) .: Project Engineer Jerry Wang 

Approved by
(position+printed name+signature) .: RF Manager Hans Hu 

Testing Laboratory Name.....: **Shenzhen Huatongwei International Inspection Co., Ltd.**

Address: 1/F, Bldg 3, Hongfa Hi-tech Industrial Park, Genyu Road, Tianliao, Gongming, Shenzhen, China

Shenzhen Huatongwei International Inspection Co., Ltd. All rights reserved.

This publication may be reproduced in whole or in part for non-commercial purposes as long as the Shenzhen Huatongwei International Inspection Co., Ltd. is acknowledged as copyright owner and source of the material. Shenzhen Huatongwei International Inspection Co., Ltd. takes no responsibility for and will not assume liability for damages resulting from the reader's interpretation of the reproduced material due to its placement and context.

The test report merely correspond to the test sample.

Contents

1	<u>TEST STANDARDS AND REPORT VERSION</u>	3
1.1.	Test Standards	3
1.2.	Report revised information	3
2	<u>TEST DESCRIPTION</u>	4
3	<u>SUMMARY</u>	5
3.1	Client Information	5
3.2	Product Description	5
3.3	Test frequency list	6
3.4	Operation mode	7
3.5	EUT configuration	8
4	<u>TEST ENVIRONMENT</u>	9
4.1	Address of the test laboratory	9
4.2	Test Facility	9
4.3	Environmental conditions	10
4.4	Statement of the measurement uncertainty	10
4.5	Equipments Used during the Test	11
5	<u>TEST CONDITIONS AND RESULTS</u>	13
5.1	Conducted Carrier Output Power	13
5.2	99% Occupied Bandwidth & 26dB Bandwidth	14
5.3	Emission Mask	16
5.4	Modulation Limit	18
5.5	Audio Frequency Response	19
5.6	Frequency stability VS Temperature	21
5.7	Frequency stability VS Voltage	22
5.8	Transmitter Frequency Behavior	23
5.9	Transmit Conducted Spurious Emission	25
5.10	Transmitter Radiated Spurious Emission	26
5.11	AC Power Line Conducted Emission	33
5.12	Radiated Emission	36
6	<u>TEST SETUP PHOTOS OF THE EUT</u>	39
7	<u>EXTERNAL AND INTERNAL PHOTOS OF THE EUT</u>	42
8	<u>APPENDIX REPORT</u>	47

1 TEST STANDARDS AND REPORT VERSION

1.1. Test Standards

The tests were performed according to following standards:

[FCC Rules Part 2](#): Frequency allocations and radio treaty matters; General rules and regulations

[FCC Rules Part 90](#): Private land mobile radio services.

[ANSI C63.26-2015](#): American National Standard for Compliance Testing of Transmitters Used in Licensed Radio Services

[ANSI/TIA-603-E\(2016\)](#): Land Mobile FM or PM Communications Equipment and Performance Standards

[FCC Part 15 Subpart B](#): Unintentional Radiators.

[ANSI C63.4-2014](#): American National Standard for Methods of Measurement of Radio-Noise Emissions from Low-Voltage Electrical and Electronic Equipment in the Range of 9 kHz to 40 GHz

1.2. Report revised information

Revised No.	Date of issued	Description
N/A	2018-11-28	Original

2 TEST DESCRIPTION

Test Item	Section in CFR 47	Result	Test Engineer
Conducted Carrier Output Power	Part 90.205 Part 2.1046(a)	Pass	Gaosheng Pan
99% Occupied Bandwidth & 26dB bandwidth	Part 90.209 & 210 Part 2.1049	Pass	Gaosheng Pan
Emission Mask	Part 90.209 & 210 Part 2.1049	Pass	Gaosheng Pan
Modulation Limit	Part 2.1047(b)	N/A	N/A
Audio Frequency Response	Part 2.1047(a)	N/A	N/A
Frequency Stability VS Temperature	Part 90.213 Part 2.1055	Pass	Gaosheng Pan
Frequency Stability VS Voltage	Part 90.213 Part 2.1055	Pass	Gaosheng Pan
Transient Frequency Behavior	Part 90.214	Pass	Gaosheng Pan
Transmit Conducted Spurious Emission	Part 90.210 Part 2.1051	Pass	Gaosheng Pan
Transmit Radiated Spurious Emission	Part 90.210 Part 2.1053	Pass	Michael.Jie
AC Power Line Conducted Emission	Part 15.107	Pass	Jeremy Zhang
Radiated Emission	Part 15.109	Pass	Michael.Jie

3 SUMMARY

3.1 Client Information

Applicant:	Fujian BelFone Communications Technology Co., Ltd.
Address:	A15, Huaqiao Economic Development Zone, Shuangyang, Luojiang, Quanzhou, Fujian, China
Manufacturer:	Fujian BelFone Communications Technology Co., Ltd.
Address:	A15, Huaqiao Economic Development Zone, Shuangyang, Luojiang, Quanzhou, Fujian, China

3.2 Product Description

Name of EUT:	DMR RADIO
Trade mark:	BelFone
Model/Type reference:	BF-TD516 (400-480MHz)
Listed model(s):	-
Power supply:	DC 7.4V
Battery information:	Model:BF-A51 7.4Vd.c., 1800mAh
Charger information:	Model:BF-B42 Input:9.2V.d.c. Output: 8.6V.d.c.
Adapter information:	Model:RSF-DY056-09000800 Input:100-240Va.c., 50-60Hz, 0.4A Output:9Vd.c., 0.8A
Hardware version:	AP105A2
Software version:	1.0.2
RF Specification	
Support Frequency Range:	400MHz~480MHz
Permitted frequency range:	400MHz~406MHz, 406.1MHz~480MHz
Rated Output Power:	<input checked="" type="checkbox"/> High Power: 5W <input checked="" type="checkbox"/> Low Power: 1W
Modulation Type:	Digital : 4FSK
Channel Separation:	Digital : <input type="checkbox"/> 6.25kHz <input checked="" type="checkbox"/> 12.5kHz
Emission Designator:	Digital: 7K60FXW, 7K60FXD
Support data rate:	9.6kbps
Antenna Type:	External

Note:

- (1) *¹ Listed frequency range 400MHz~406MHz for Federal use Only.
- (2) *² The DMR standard specifies two-slot Time Division Multiplexing Technology to split the 12.5 kHz channel into two virtual 6.25kHz communication paths. This equates to an efficiency of one voice channel per 6.25 kHz of bandwidth even though it operates in channels of 12.5 kHz
- (3) *³ According to FCC Part 2.202 requirements, the Necessary Bandwidth is calculated as follows:
- For FM Data Modulation
 Channel Spacing = 12.5 KHz, R = 9600 bps, D = 1944Hz, S = 4, K = 0.72
 $B_n = (R/\log_2 S) + 2DK \cong 7.6 \text{ KHz}$
 Emission designation: 7K60FXW, 7K60FXD

3.3 Test frequency list

According to ANSI C63.26 section 5.1.2.1:

Measurements of transmitters shall be performed and, if required, reported for each frequency band in which the EUT can be operated with the device transmitting at the number of frequencies in each band specified in Table 2.

Frequency range over which EUT operates	Number of frequencies	Location in frequency range of operation
1 MHz or less	1	Middle
1 MHz to 10 MHz	2	1 near top and 1 near bottom
More than 10 MHz	3	1 near top, 1 near middle, and 1 near bottom

Frequency Bands (MHz)	Test Frequency (MHz)	
400MHz ~ 406MHz	CH _L	400.0125
	CH _{M1}	405.9875
406.1MHz ~470MHz	CH _{M2}	406.1125
	CH _{M3}	443.05
	CH _H	479.9875

3.4 Operation mode

Test mode	Transmitting	Receiving	Digital	Analog	Power level		GPS
			12.5kHz	12.5kHz	High	Low	
TX-DNH	√		√		√		
TX-DNL	√		√			√	
RX-DN		√	√				

Note:

√: is operation mode.

Modulation Type	Description
UM	Un-modulation
AM2	Apply a 1000 Hz tone and adjust the audio frequency generator to produce 20% of the rated system deviation.
AM6	Apply a 1000 Hz modulating signal to the transmitter from the audio frequency generator, and adjust the level to obtain 60% of full rated system deviation, then increase the level from the audio generator by 20 dB
AM5	Modulate the transmitter with a 2500 Hz sine wave at an input level 16 dB greater than that necessary to produce 50% of rated system deviation.
DM	A 511 bit binary pseudo-random bit sequence based on ITU-T Rec. O.153

Pre-scan above all test mode, found below test mode which it was worse case mode, so only show the test data for worse case mode on the test report.

Test item	Modulation Type	Test mode (Worse case mode)
Conducted Output Power	UM	TX-DNH, TX-DNL
99% Occupied Bandwidth & 26dB bandwidth	DM	TX-DNH, TX-DNL
Emission Mask	DM	TX-DNH, TX-DNL
Modulation Limit	AM6	-
Audio Frequency Response	AM2	-
Frequency Stability VS Temperature	UM	TX-DNH, TX-DNL
Frequency Stability VS Voltage	UM	TX-DNH, TX-DNL
Transient Frequency Behavior	UM	TX-DNH
Transmit Conducted Spurious Emission	DM	TX-DNH
Transmit Radiated Spurious Emission	DM	TX-DNH
AC Power Line Conducted Emission	-	RX-DN
Radiated Emission	-	RX-DN

3.5 EUT configuration

The following peripheral devices and interface cables were connected during the measurement:

- - supplied by the manufacturer
- - supplied by the lab

●	Power Cable	Length (m) :	/
		Shield :	Unshielded
		Detachable :	Undetachable
○	Multimeter	Manufacturer :	/
		Model No. :	/

4 TEST ENVIRONMENT

4.1 Address of the test laboratory

Laboratory: Shenzhen Huatongwei International Inspection Co., Ltd.

Address: 1/F, Bldg 3, Hongfa Hi-tech Industrial Park, Genyu Road, Tianliao, Gongming, Shenzhen, China

4.2 Test Facility

The test facility is recognized, certified, or accredited by the following organizations:

CNAS-Lab Code: L1225

Shenzhen Huatongwei International Inspection Co., Ltd. has been assessed and proved to be in compliance with CNAS-CL01 Accreditation Criteria for Testing and Calibration Laboratories (identical to ISO/IEC17025: 2005 General Requirements) for the Competence of Testing and Calibration Laboratories.

A2LA-Lab Cert. No. 3902.01

Shenzhen Huatongwei International Inspection Co., Ltd. EMC Laboratory has been accredited by A2LA for technical competence in the field of electrical testing, and proved to be in compliance with ISO/IEC 17025: 2005 General Requirements for the Competence of Testing and Calibration Laboratories and any additional program requirements in the identified field of testing.

FCC-Registration No.: 762235

Shenzhen Huatongwei International Inspection Co., Ltd. EMC Laboratory has been registered and fully described in a report filed with the FCC (Federal Communications Commission). The acceptance letter from the FCC is maintained in our files. Registration 762235.

IC-Registration No.: 5377B-1

Two 3m Alternate Test Site of Shenzhen Huatongwei International Inspection Co., Ltd. has been registered by Certification and Engineering Bureau of Industry Canada for the performance of radiated measurements with Registration No. 5377B-1.

ACA

Shenzhen Huatongwei International Inspection Co., Ltd. EMC Laboratory can also perform testing for the Australian C-Tick mark as a result of our A2LA accreditation.

4.3 Environmental conditions

Atmospheric Contions	
Temperature:	21°C to 25°C
Relative Humidity:	20 % to 75 %.
Atmospheric Pressure:	860 mbar to 1060 mbar
Norminal Test Voltage:	$V_N = DC 7.40V$
Extrem Test Voltage @115% V_N :	$V_H = DC 8.51V$
Extrem Test Voltage @85% V_N :	$V_L = DC 6.29V$

4.4 Statement of the measurement uncertainty

The data and results referenced in this document are true and accurate. The reader is cautioned that there may be errors within the calibration limits of the equipment and facilities. The measurement uncertainty was calculated for all measurements listed in this test report acc. to CISPR 16 - 4 „Specification for radio disturbance and immunity measuring apparatus and methods – Part 4: Uncertainty in EMC Measurements“ and is documented in the Shenzhen Huatongwei International Inspection Co., Ltd quality system acc. to DIN EN ISO/IEC 17025. Furthermore, component and process variability of devices similar to that tested may result in additional deviation. The manufacturer has the sole responsibility of continued compliance of the device.

Hereafter the best measurement capability for Shenzhen Huatongwei laboratory is reported:

Test Items	Measurement Uncertainty	Notes
Frequency stability & Occupied Bandwidth	18Hz for <1GHz 69Hz for >1GHz	(1)
Conducted Output Power	0.63dB	(1)
ERP / EIRP / RSE	2.38dB for <1GHz 3.45dB for >1GHz	(1)
Conducted Emission 9KHz-30MHz	3.35 dB	(1)
Radiated Emission 30~1000MHz	4.80 dB	(1)
Radiated Emission 1~18GHz	5.16 dB	(1)
Radiated Emission 18-40GHz	5.54 dB	(1)
FM deviation	25 Hz	(1)
Audio level	0.62 dB	(1)
Low Pass Filter Response	0.76 dB	(1)
Modulation Limiting	0.42 %	(1)
Transient Frequency Behavior	6.8 %	(1)

(1) This uncertainty represents an expanded uncertainty expressed at approximately the 95% confidence level using a coverage factor of $k=1.96$.

4.5 Equipments Used during the Test

AC power line conducted emission						
Item	Equipment	Manufacturer	Model No.	Serial No.	Last Cal. (mm-dd-yy)	Next Cal. (mm-dd-yy)
1	Shielded Room	Albatross projects	N/A	N/A	05/02/2017	05/01/2019
2	Artificial Mains	SCHWARZBECK	NNLK 8121	573	10/27/2018	10/26/2019
3	EMI Test Receiver	R&S	ESCI	101247	10/27/2018	10/26/2019
4	Pulse Limiter	R&S	ESH3-Z2	101488	10/27/2018	10/26/2019
5	RF Connection Cable	HUBER+SUHNER	EF400	N/A	10/27/2018	10/26/2019
6	Test Software	R&S	ES-K1	N/A	N/A	N/A
7	Four Balanced Telecom Pairs ISN	FCC	FCC-TLISN-T8-02	20375	10/28/2018	10/27/2019

Test Equipment For Conducted Method						
Item	Equipment	Manufacturer	Model No.	Serial No.	Last Cal. (mm-dd-yy)	Next Cal. (mm-dd-yy)
1	Shielded Room	CRT	4.8*3*3	\	04/25/2016	04/25/2019
2	Digital intercom COMM.TESRER	Aeroflex	3920B	1001682041	10/28/2018	10/27/2019
3	RF Communication Test Set	HP	8920A	3813A10206	10/28/2018	10/27/2019
4	RF Control Unit	Tonscend	JS0806-2	\	\	\
5	10dB Attenuator	Mini-Circuits	VAT-10W2+	\	\	\
6	20dB Attenuator	JFW	50FH-30-100	\	\	\
7	30dB Attenuator	JFW	50-A-MFN-20	\	\	\
8	Band Stop Filter	microwave	N26460M1	498702	03/19/2018	03/19/2019
9	Band Stop Filter	microwave	N25155M2	498704	03/19/2018	03/19/2019
12	Spectrum Analyzer	R&S	FSW26	103440	10/28/2018	10/27/2019
13	Signal Generator	R&S	SML02	100507	10/28/2018	10/27/2019
14	Signal Generator	IFR	2032	203002\100	10/28/2018	10/27/2019
15	Constant temperature humidity chamber	ESPEC	GPL-2	0010003045	10/28/2018	10/27/2019
16	DC Power supply	GW INSTRON	GPS-3030D	012578	\	\
17	Multimeter	FLUKE	15B	\	10/28/2018	10/27/2019
18	Land mobile test soft	HTW	RADIO ATE	1.0.0.31	\	\

Test Equipment For Radiated Method						
Item	Equipment	Manufacturer	Model No.	Serial No.	Last Cal. (mm-dd-yy)	Next Cal. (mm-dd-yy)
1	EMI Test Receiver	R&S	ESCI	101247	10/28/2018	10/27/2019
2	Loop Antenna	R&S	HFH2-Z2	100020	04/02/2018	04/01/2021
3	Ultra-Broadband Antenna	SCHWARZBECK	VULB9163	538	04/05/2017	04/04/2020
4	Preamplifier	SCHWARZBECK	BBV 9743	9743-0022	11/14/2018	11/13/2019
5	RF Connection Cable	HUBER+SUHNER	RE-7-FL	\	11/15/2018	11/14/2019
6	EMI Test Software	R&S	ESK1	\	\	\
7	Spectrum Analyzer	R&S	FSP40	100597	10/27/2018	10/26/2019
8	Horn Antenna	SCHWARZBECK	9120D	1011	03/27/2017	03/26/2020
9	Horn Antenna	SCHWARZBECK	BBHA9170	25841	03/27/2017	03/26/2020
10	Broadband Preamplifier	SCHWARZBECK	BBV 9718	9718-248	04/28/2018	04/27/2019
11	RF Connection Cable	HUBER+SUHNER	RE-7-FH	\	11/15/2018	11/14/2019
12	Signal Generator	Rohde&Schwarz	SMB100A	114360	11/15/2018	11/14/2019
13	Band Stop Filter	microwave	N26460M1	498703	03/19/2018	03/19/2019
14	Band Stop Filter	microwave	N25155M2	498705	03/19/2018	03/19/2019
15	EMI Test Software	Audix	E3	\	\	\
16	Turntable	MATURO	TT2.0	\	\	\
17	Antenna Mast	Maturo Germany	CAM-4.0-P-12	\	\	\
18	Anechoic Chamber	Albatross projects	SAC-3m-01	C11121	09/30/2018	09/29/2021

5 TEST CONDITIONS AND RESULTS

5.1 Conducted Carrier Output Power

LIMIT

FCC Part 90.205, FCC Part 2.1046

Applicants for licenses must request and use no more power than the actual power necessary for satisfactory operation.

TEST CONFIGURATION

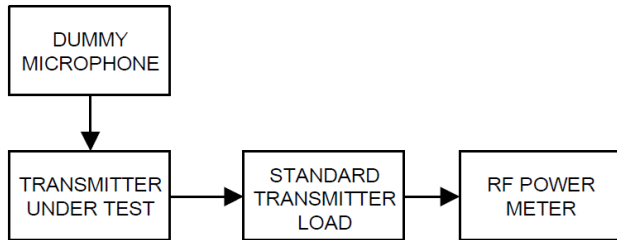

TEST PROCEDURE

- (1) Connect the equipment as illustrated
- (2) Correct for all losses in the RF path
- (3) Measure the transmitter output power
- (4) If the power output is adjustable, measurements shall be made for the highest and lowest power levels.

TEST MODE

Please reference to the section 3.4

TEST RESULTS

Passed **Not Applicable**

Please refer to appendix A on the section 8 appendix report

5.2 99% Occupied Bandwidth & 26dB Bandwidth

LIMIT

FCC Part 90.209, FCC Part 2.1049

Frequency band (MHz)	Channel spacing (kHz)	Authorized bandwidth (kHz)
Below 25 ²		
25-50	20	20
72-76	20	20
150-174	17.5	¹ 320/11.25/6
216-220 ⁵	6.25	20/11.25/6
220-222	5	4
406-512 ²	¹ 6.25	¹³⁶ 20/11.25/6
806-809/851-854	12.5	20
809-824/854-869	25	⁶ 20
896-901/935-940	12.5	13.6
902-928 ⁴		
929-930	25	20
1427-1432 ⁵	12.5	12.5
³ 2450-2483.5 ²		
Above 2500 ²		

TEST CONFIGURATION

Test setup for Analog:

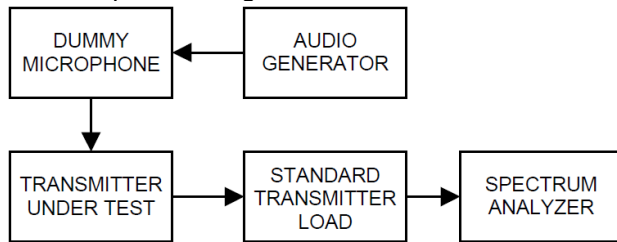

Test setup for Digital:

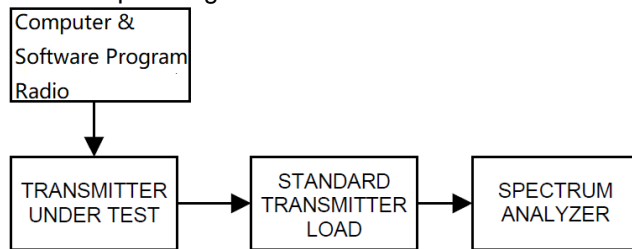

TEST PROCEDURE

- (1) Connect the equipment as illustrated
- (2) Spectrum set as follow:
 - Centre frequency = the nominal EUT channel center frequency,
 - The frequency span for the spectrum analyzer shall be set wide enough to capture all modulation products including the emission skirts (typically a span of 1.5 × OBW is sufficient)
 - RBW = 1% to 5% of the anticipated OBW, VBW ≥ 3 × RBW, Sweep = auto,
 - Detector function = peak, Trace = max hold
- (3) Set 99% Occupied Bandwidth and 26dB Bandwidth
- (4) Measure and record the results in the test report.

TEST MODE

Please reference to the section 3.4

TEST RESULTS

Passed **Not Applicable**

Please refer to appendix B on the section 8 appendix report

5.3 Emission Mask

LIMIT

FCC Part 90.210, FCC Part 2.1049

Frequency band (MHz)	Mask for equipment with audio low pass filter	Mask for equipment without audio low pass filter
Below 25 ¹	A or B	A or C
25-50	B	C
72-76	B	C
150-174 ²	B, D, or E	C, D or E
150 paging only	B	C
220-222	F	F
421-512 ^{2 5}	B, D, or E	C, D, or E
450 paging only	B	G
806-809/851-854 ⁶	B	H
809-824/854-869 ^{3 5}	B	G
896-901/935-940	I	J
902-928	K	K
929-930	B	G
4940-4990 MHz	L or M	L or M
5850-5925 ⁴		
All other bands	B	C

Emission Mask D — 12.5 kHz channel bandwidth equipment

For transmitters designed to operate with a 12.5 kHz channel bandwidth, any emission must be attenuated below the power (P) of the highest emission contained within the authorized bandwidth as follows:

- (1) On any frequency from the centre of the authorized bandwidth f_0 to 5.625 kHz removed from f_0 : 0dB
- (2) On any frequency removed from the centre of the authorized bandwidth by a displacement frequency (f_d in kHz) of more than 5.625 kHz but no more than 12.5 kHz: At least $7.27(f_d - 2.88 \text{ kHz})$ dB.
- (3) On any frequency removed from the centre of the authorized bandwidth by a displacement frequency (f_d in kHz) of more than 12.5 kHz: At least $50 + 10 \log (P)$ dB or 70 dB, whichever is the lesser attenuation.

TEST CONFIGURATION

Test setup for Analog:

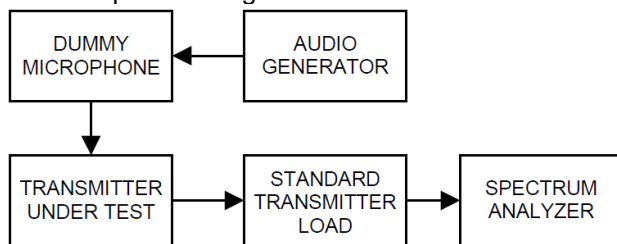

Test setup for Digital:

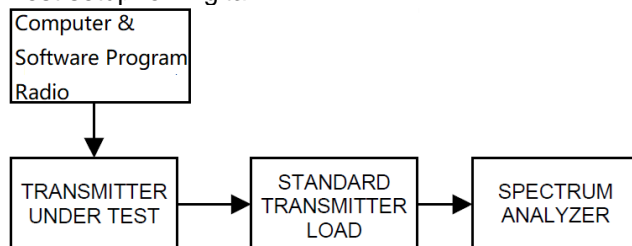

TEST PROCEDURE

- 1) Connect the equipment as illustrated.
- 2) Spectrum set as follow:
Centre frequency = fundamental frequency, span=120kHz for 12.5kHz channel spacing,
RBW=100Hz, VBW=1000Hz, Sweep = auto,
Detector function = peak, Trace = max hold
- 3) Key the transmitter, and set the level of the unmodulated carrier to a full scale reference line. This is the 0dB reference for the measurement.
- 4) Apply Input Modulation Signal to EUT according to Section 3.4
- 5) Measure and record the results in the test report.

TEST MODE

Please reference to the section 3.4

TEST RESULTS

Passed **Not Applicable**

Please refer to appendix C on the section 8 appendix report

5.4 Modulation Limit

LIMIT

FCC Part 2.1047(b)

2.5kHz for 12.5 KHz Channel Spacing System

TEST CONFIGURATION

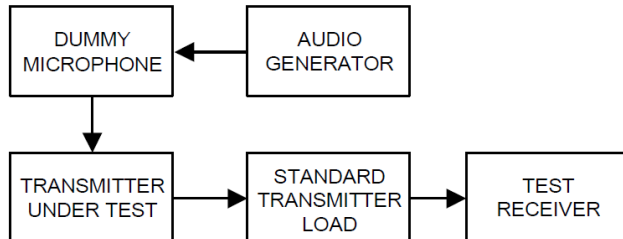

TEST PROCEDURE

- 1) Connect the equipment as illustrated.
- 2) Adjust the transmitter per the manufacturer's procedure for full rated system deviation.
- 3) Set the test receiver to measure peak positive deviation. Set the audio bandwidth for ≤ 0.25 Hz to $\geq 15,000$ Hz. Turn the de-emphasis function off.
- 4) Apply Input Modulation Signal to EUT according to Section 3.4 and vary the input level from -20 to $+20$ dB.
- 5) Measure both the instantaneous and steady-state deviation at and after the time of increasing the audio input level
- 6) Repeat step 4-5 with input frequency changing to 300Hz, 1004Hz, 1500Hz and 2500Hz in sequence.

TEST MODE

Please reference to the section 3.4

TEST RESULTS

Passed Not Applicable

5.5 Audio Frequency Response

LIMIT

2.1047(a): Voice modulated communication equipment. A curve or equivalent data showing the frequency response of the audio modulating circuit over a range of 100 to 5000 Hz shall be submitted. For equipment required to have an audio low-pass filter, a curve showing the frequency response of the filter or of all circuitry installed between the modulation limiter and the modulated stage shall be submitted.

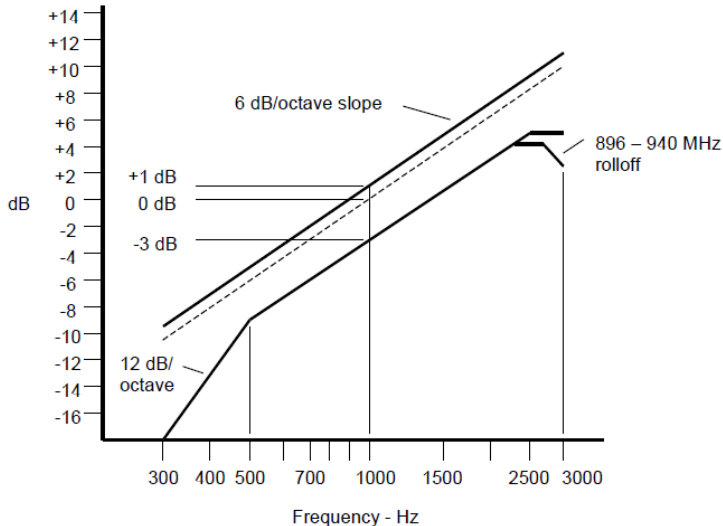

An additional 6 dB per octave attenuation is allowed from 2500 Hz to 3000 Hz in equipment operating in the 25 MHz to 869 MHz range.

TEST CONFIGURATION

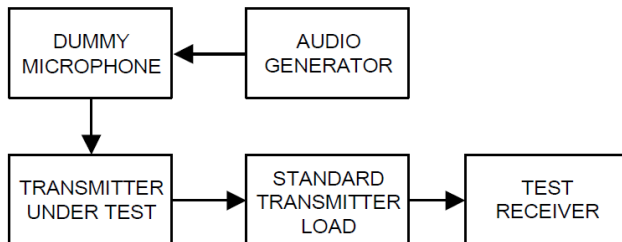

TEST PROCEDURE

- 1) Connect the equipment as illustrated.
- 2) Set the test receiver to measure peak positive deviation. Set the audio bandwidth for 50 Hz to 15,000 Hz. Turn the de-emphasis function off.
- 3) Set the DMM to measure rms voltage.
- 4) Adjust the transmitter per the manufacturer's procedure for full rated system deviation.
- 5) Apply Input Modulation Signal to EUT according to Section 3.4
- 6) Set the test receiver to measure rms deviation and record the deviation reading.
- 7) Record the DMM reading as V_{REF} .
- 8) Set the audio frequency generator to the desired test frequency between 300 Hz and 3000 Hz.
- 9) Vary the audio frequency generator output level until the deviation reading that was recorded in step 6) is obtained.
- 10) Record the DMM reading as V_{FREQ}
- 11) Calculate the audio frequency response at the present frequency as:
audio frequency response = $20 \log_{10} (V_{FREQ}/V_{REF})$.
- 12) Repeat steps 8) through 11) for all the desired test frequencies

TEST MODE

Please reference to the section 3.4

TEST RESULTS

Passed Not Applicable

5.6 Frequency stability VS Temperature

LIMIT

FCC Part 90.213, FCC Part 2.1055

Frequency range (MHz)	Fixed and base stations	Mobile stations	
		Over 2 watts output power	2 watts or less output power
Below 25	1 2 3 100	100	200
25-50	20	20	50
72-76	5		50
150-174	5 11 5	6 5	4 6 5 0
216-220	1.0		1.0
220-222 ¹²	0.1	1.5	1.5
421-512	7 11 14 2.5	8 5	8 5
806-809	14 1.0	1.5	1.5
809-824	14 1.5	2.5	2.5
851-854	1.0	1.5	1.5
854-869	1.5	2.5	2.5
896-901	14 0.1	1.5	1.5
902-928	2.5	2.5	2.5
902-928 ¹³	2.5	2.5	2.5
929-930	1.5		
935-940	0.1	1.5	1.5
1427-1435	9 300	300	300
Above 2450 ¹⁰			

TEST CONFIGURATION

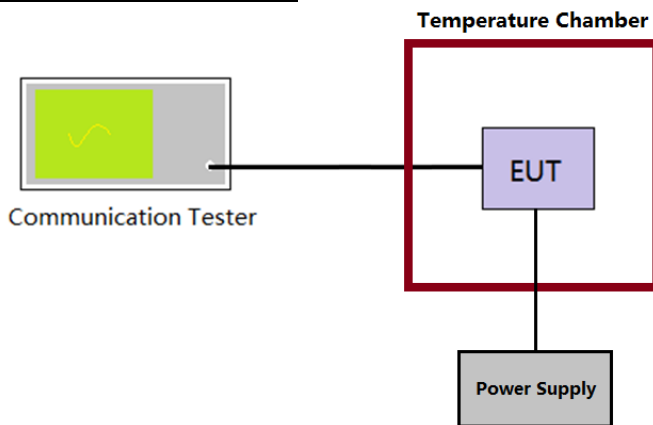

TEST PROCEDURE

- 1) The EUT output port was connected to communication tester.
- 2) The EUT was placed inside the temperature chamber.
- 3) Turn EUT off and set the chamber temperature to -30°C . After the temperature stabilized for approximately 30 minutes recorded the frequency as MCF_{MHz} .
- 4) Calculate the ppm frequency error by the following:

$$\text{ppm error} = (MCF_{\text{MHz}} / ACF_{\text{MHz}} - 1) * 10^6$$
 where
 MCF_{MHz} is the Measured Carrier Frequency in MHz
 ACF_{MHz} is the Assigned Carrier Frequency in MHz
- 5) Repeat step 3 measure with 10°C increased per stage until the highest temperature of $+50^{\circ}\text{C}$ reached.

TEST MODE

Please reference to the section 3.4

TEST RESULTS

Passed Not Applicable

Please refer to appendix F on the section 8 appendix report

5.7 Frequency stability VS Voltage

LIMIT

FCC Part 90.213, FCC Part 2.1055

Frequency range (MHz)	Fixed and base stations	Mobile stations	
		Over 2 watts output power	2 watts or less output power
Below 25	1 2 3 100	100	200
25-50	20	20	50
72-76	5		50
150-174	5 11 5	6 5	4 6 5 0
216-220	1.0		1.0
220-222 ¹²	0.1	1.5	1.5
421-512	7 11 14 2.5	8 5	8 5
806-809	14 1.0	1.5	1.5
809-824	14 1.5	2.5	2.5
851-854	1.0	1.5	1.5
854-869	1.5	2.5	2.5
896-901	14 0.1	1.5	1.5
902-928	2.5	2.5	2.5
902-928 ¹³	2.5	2.5	2.5
929-930	1.5		
935-940	0.1	1.5	1.5
1427-1435	9 300	300	300
Above 2450 ¹⁰			

TEST CONFIGURATION

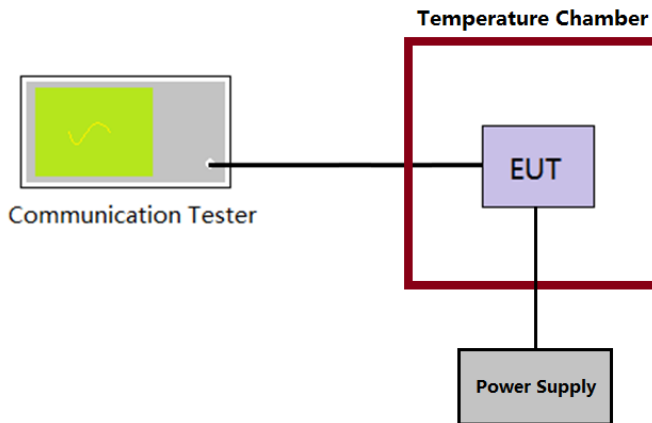

TEST PROCEDURE

- 1) The EUT output port was connected to communication tester.
- 2) The EUT was placed inside the temperature chamber at 25°C
- 3) Record the carrier frequency of the transmitter as MCF_{MHz}
- 4) Calculate the ppm frequency error by the following:
 $ppm\ error = (MCF_{MHz} / ACF_{MHz} - 1) * 10^6$
 where
 MCF_{MHz} is the Measured Carrier Frequency in MHz
 ACF_{MHz} is the Assigned Carrier Frequency in MHz
- 5) Repeat step 3 measure with varied $\pm 15\%$ of the nominal value measured at the input to the EUT

TEST MODE

Please reference to the section 3.4

TEST RESULTS

Passed Not Applicable

Please refer to appendix G on the section 8 appendix report

5.8 Transmitter Frequency Behavior

LIMIT

FCC part 90.214

Transmitters designed to operate in the 150-174 MHz and 421-512 MHz frequency bands must maintain transient frequencies within the maximum frequency difference limits during the time intervals indicated:

Time intervals ^{1 2}	Maximum frequency difference ³	All equipment	
		150 to 174 MHz	421 to 512 MHz
Transient Frequency Behavior for Equipment Designed to Operate on 25 kHz Channels			
t ₁ ⁴	±25.0 kHz	5.0 ms	10.0 ms
t ₂	±12.5 kHz	20.0 ms	25.0 ms
t ₃ ⁴	±25.0 kHz	5.0 ms	10.0 ms
Transient Frequency Behavior for Equipment Designed to Operate on 12.5 kHz Channels			
t ₁ ⁴	±12.5 kHz	5.0 ms	10.0 ms
t ₂	±6.25 kHz	20.0 ms	25.0 ms
t ₃ ⁴	±12.5 kHz	5.0 ms	10.0 ms
Transient Frequency Behavior for Equipment Designed to Operate on 6.25 kHz Channels			
t ₁ ⁴	±6.25 kHz	5.0 ms	10.0 ms
t ₂	±3.125 kHz	20.0 ms	25.0 ms
t ₃ ⁴	±6.25 kHz	5.0 ms	10.0 ms

Note:

- On is the instant when a 1 kHz test signal is completely suppressed, including any capture time due to phasing.
 - t₁ is the time period immediately following ton.
 - t₂ is the time period immediately following t₁.
 - t₃ is the time period from the instant when the transmitter is turned off until toff.
 - t_{off} is the instant when the 1 kHz test signal starts to rise.
- During the time from the end of t₂ to the beginning of t₃, the frequency difference must not exceed the limits specified in §90.213.
- Difference between the actual transmitter frequency and the assigned transmitter frequency.
- If the transmitter carrier output power rating is 6 watts or less, the frequency difference during this time period may exceed the maximum frequency difference for this time period.

TEST CONFIGURATION

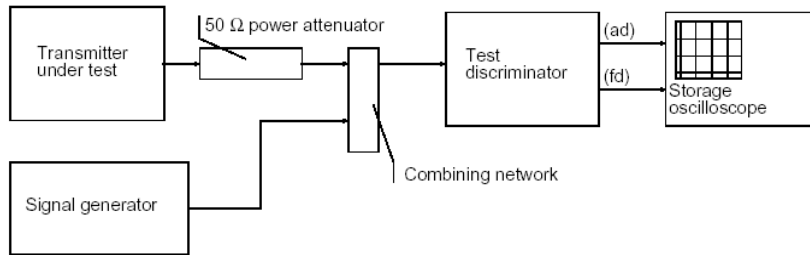

TEST PROCEDURE

- Connect DUT into Test discriminator and Storage Oscilloscope and keep DUT stats ON;
- Input 1kHz signal into DUT;
- Set the modulation domain analyzer to trigger on the rising edge of the waveform in order to capture a single-shot turn-on of the transmitter signals;
- Keep DUT in OFF state and Key the PTT;
- Observe the stored oscilloscope of modulation domain analyzer. The signal trace shall be maintained within the allowable limits during the periods t₁ and t₂, and shall also remain within limits following t₂;
- Adjust the modulation domain analyzer to trigger on the falling edge of the transmitter waveform in order to capture a single-shot turn-off transmitter of the transmitter signal.
- Keep the digital portable radio in ON state and unkey the PTT;
- Observe the stored oscilloscope of modulation domain analyzer, The signal trace shall be maintained within the allowable limits during the period t₃.
- Set the signal generator to the assigned transmitter frequency and modulate it with a 1 kHz tone at ±12.5 kHz deviation and set its output level to -100dBm.
- Turn on the transmitter.

- 11) Supply sufficient attenuation via the RF attenuator to provide an input level to the stored oscilloscope
- 12) that is 40 dB below the maximum allowed input power when the transmitter is operating at its rated power level. Note this power level on the stored oscilloscope as P_0 .
- 13) Turn off the transmitter.
- 14) Adjust the RF level of the signal generator to provide RF power equal to P_0 . This signal generator RF level shall be maintained throughout the rest of the measurement.
- 15) Remove the attenuation, so the input power to the stored oscilloscope is increased by 30 dB when the transmitter is turned on.
- 16) Adjust the vertical amplitude control of the stored oscilloscope to display the 1000 Hz at ± 4 divisions vertically centered on the display. Set trigger mode of the Spectrum Analyzer to "Video", and tune the "trigger level" on suitable level. Then set the "trigger offset" to -10ms for turn on and -15ms for turn off.
- 17) Turn on the transmitter and the transient wave will be captured on the screen of Spectrum Analyzer. Observe the stored display. The instant when the 1 kHz test signal is completely suppressed is considered to be ton. The trace should be maintained within the allowed divisions during the period t_1 and t_2 .
- 18) Then turn off the transmitter, and another transient wave will be captured on the screen of Spectrum
- 19) Analyzer. The trace should be maintained within the allowed divisions during the period t_3 .

TEST MODE

Please reference to the section 3.4

TEST RESULTS

Passed **Not Applicable**

Please refer to appendix H on the section 8 appendix report

5.9 Transmit Conducted Spurious Emission

LIMIT

FCC Part 90.210, FCC Part 2.1051

Emission Mask D—12.5 kHz channel bandwidth equipment. For transmitters designed to operate with a 12.5 kHz channel bandwidth, any emission must be attenuated below the power (P) of the highest emission contained within the authorized bandwidth as follows:

(3) On any frequency removed from the center of the authorized bandwidth by a displacement frequency (fd in kHz) of more than 12.5 kHz: At least 50 + 10 log (P) dB or 70 dB, whichever is the lesser attenuation.

In general, the worse case attenuation requirement shown above was applied.

Calculation: Limit (dBm) =EL-50-10log (P)

EL is the emission level of the Output Power expressed in dBm,

Limit (dBm) = P(dBm)-50-10 log (Pwatts) = -20dBm

TEST CONFIGURATION

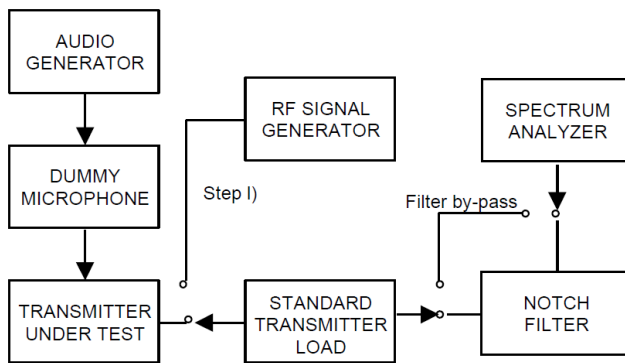

TEST PROCEDURE

1. Connect the equipment as illustrated, with the notch filter by-passed.
2. Apply Input Modulation Signal to EUT according to Section 3.4
3. Adjust the spectrum analyzer for the following settings:
 Below 1GHz: RBW=100kHz, VBW=300kHz
 Above 1GHz: RBW=1MHz, VBW=3MHz
 Detector=Peak, Sweep time=Auto, Trace=Max hold
4. Scan frequency range up to 10th harmonic.
5. Record the frequencies and levels of spurious emissions

TEST MODE

Please reference to the section 3.4

TEST RESULTS

Passed Not Applicable

Please refer to appendix I on the section 8 appendix report

5.10 Transmitter Radiated Spurious Emission

Radiated spurious emissions are emissions from the equipment when transmitting into a nonradiating load on a frequency or frequencies that are outside an occupied band sufficient to ensure transmission of information of required quality for the class of communications desired.

LIMIT

FCC Part 90.210, FCC Part 2.1051

Emission Mask D—12.5 kHz channel bandwidth equipment. For transmitters designed to operate with a 12.5 kHz channel bandwidth, any emission must be attenuated below the power (P) of the highest emission contained within the authorized bandwidth as follows:

(3) On any frequency removed from the center of the authorized bandwidth by a displacement frequency (fd in kHz) of more than 12.5 kHz: At least 50 + 10 log (P) dB or 70 dB, whichever is the lesser attenuation.

Emission Mask E—6.25 kHz or less channel bandwidth equipment. For transmitters designed to operate with a 6.25 kHz or less bandwidth, any emission must be attenuated below the power (P) of the highest emission contained within the authorized bandwidth as follows:

(3) On any frequency removed from the center of the authorized bandwidth by more than 4.6 kHz: At least 55 + 10 log (P) or 65 dB, whichever is the lesser attenuation.

In general, the worse case attenuation requirement shown above was applied.

Calculation: Limit (dBm) = EL - 50 - 10 log (P)

EL is the emission level of the Output Power expressed in dBm,

Limit (dBm) = P(dBm) - 50 - 10 log (Pwatts) = -20dBm

TEST CONFIGURATION

Below 1GHz:

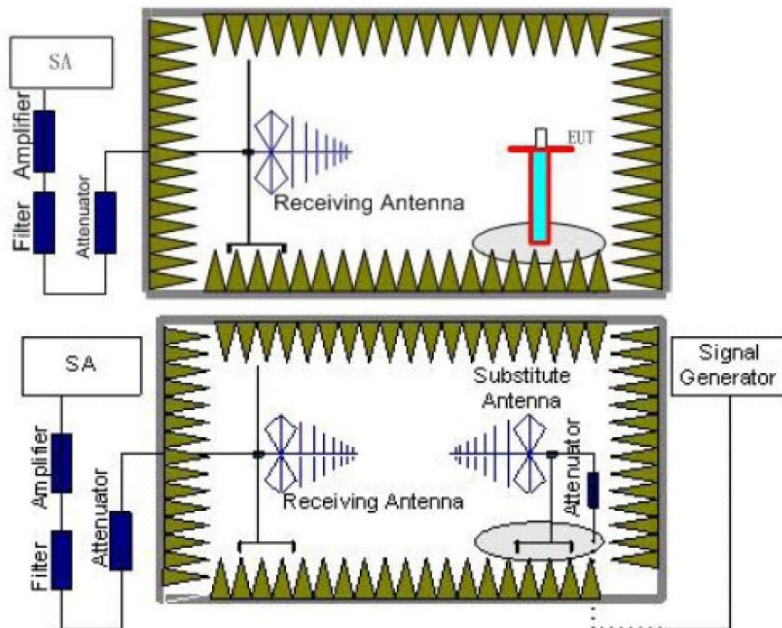

Above 1GHz:

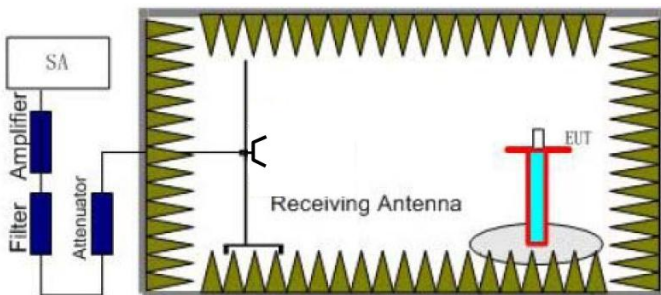

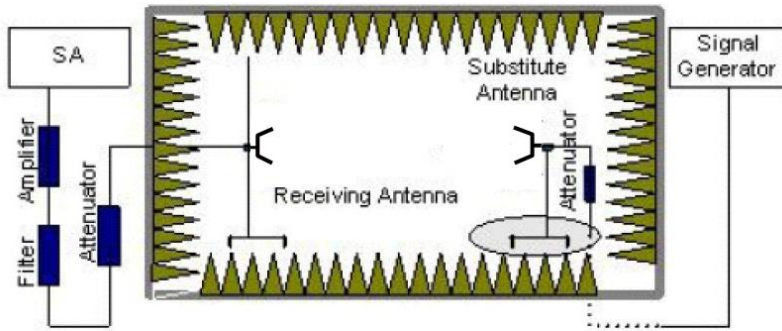

TEST PROCEDURE

1. Standard Transmitter Load with a 50Ω input impedance and an output impedance matched to the test equipment.
2. EUT was placed on a 0.8 meter high non-conductive stand at a 3 meter test distance from the receive antenna. A receiving antenna was placed on the antenna mast 3 meters from the EUT for emission measurements. The height of receiving antenna is 1.0 m. Detected emissions were maximized at each frequency by rotating the EUT through 360° and adjusting the receiving antenna polarization. The radiated emission measurements of all transmit frequencies in six channels were measured with peak detector.
3. A log-periodic antenna or double-ridged waveguide horn antenna shall be substituted in place of the EUT. The log-periodic antenna will be driven by a signal generator and the level will be adjusted till the same power value on the spectrum analyzer or receiver. The level of the spurious emissions can be calculated through the level of the signal generator, cable loss, the gain of the substitution antenna and the reading of the spectrum analyzer or receiver.
4. The EUT is then put into continuously transmitting mode at its maximum power level during the test. Set Test Receiver or Spectrum RBW=1MHz, VBW=3MHz for above 1GHz and RBW=100kHz, VBW=300kHz for 30MHz to 1GHz, And the maximum value of the receiver should be recorded as (Pr).
5. The EUT shall be replaced by a substitution antenna. In the chamber, an substitution antenna for the frequency band of interest is placed at the reference point of the chamber. An RF Signal source for the frequency band of interest is connected to the substitution antenna with a cable that has been constructed to not interfere with the radiation pattern of the antenna. A power (PMea) is applied to the input of the substitution antenna, and adjust the level of the signal generator output until the value of the receiver reach the previously recorded (Pr). The power of signal source (PMea) is recorded. The test should be performed by rotating the test item and adjusting the receiving antenna polarization.
6. A amplifier should be connected to the Signal Source output port. And the cable should be connect between the Amplifier and the Substitution Antenna. The cable loss (Pcl) ,the Substitution Antenna Gain (Ga) and the Amplifier Gain (PAg) should be recorded after test.
The measurement results are obtained as described below:
Power(EIRP)=PMea- PAg - Pcl - Ga
We used SMF100A microwave signal generator which signal level can up to 33dBm,so we not used power Amplifier for substitution test; The measurement results are amend as described below:
Power(EIRP)=PMea- Pcl - Ga
7. This value is EIRP since the measurement is calibrated using an antenna of known gain (2.15 dBi) and known input power.
8. ERP can be calculated from EIRP by subtracting the gain of the dipole, ERP = EIRP-2.15dBi.

TEST MODE

Please reference to the section 3.4

TEST RESULTS

Passed Not Applicable

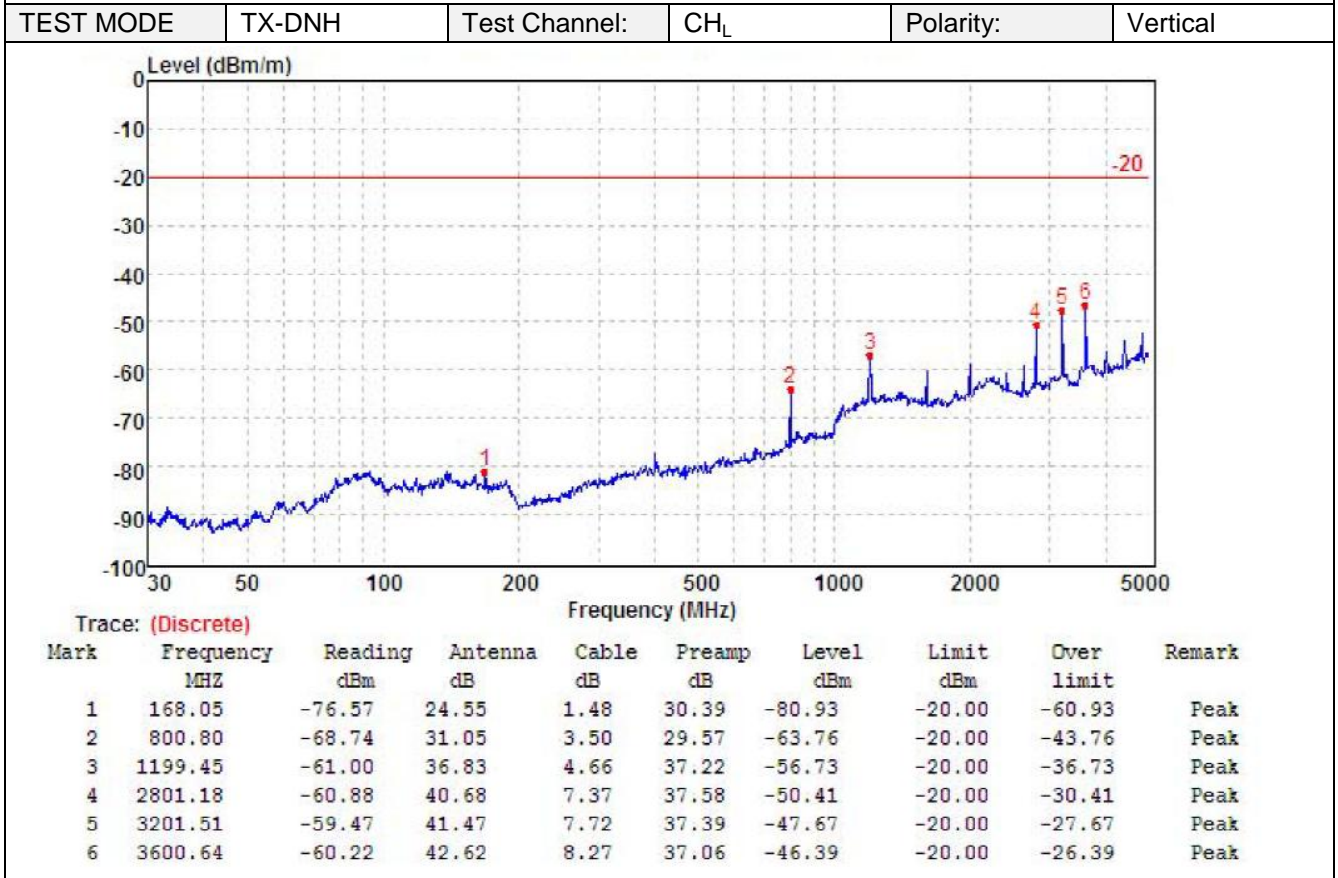
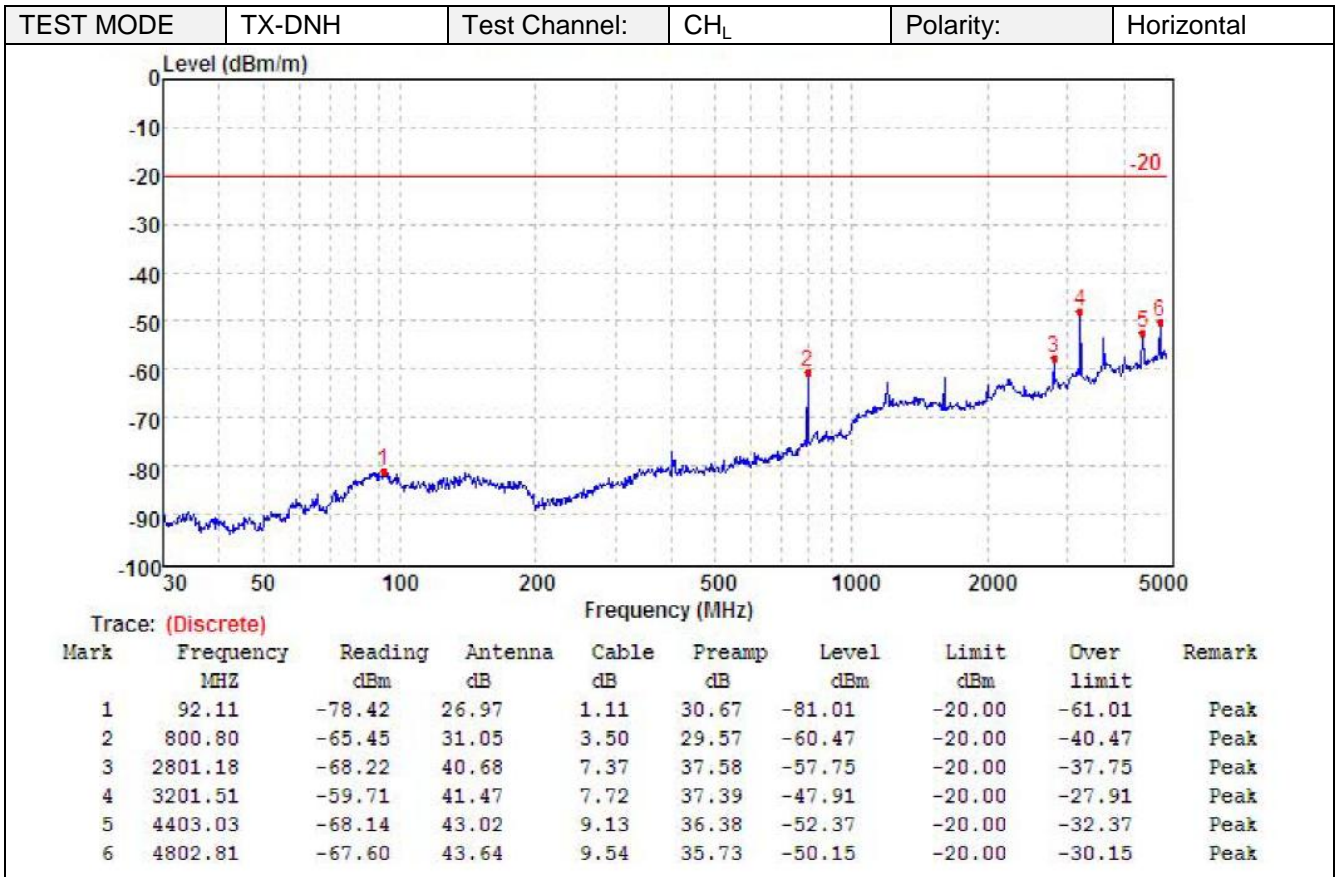

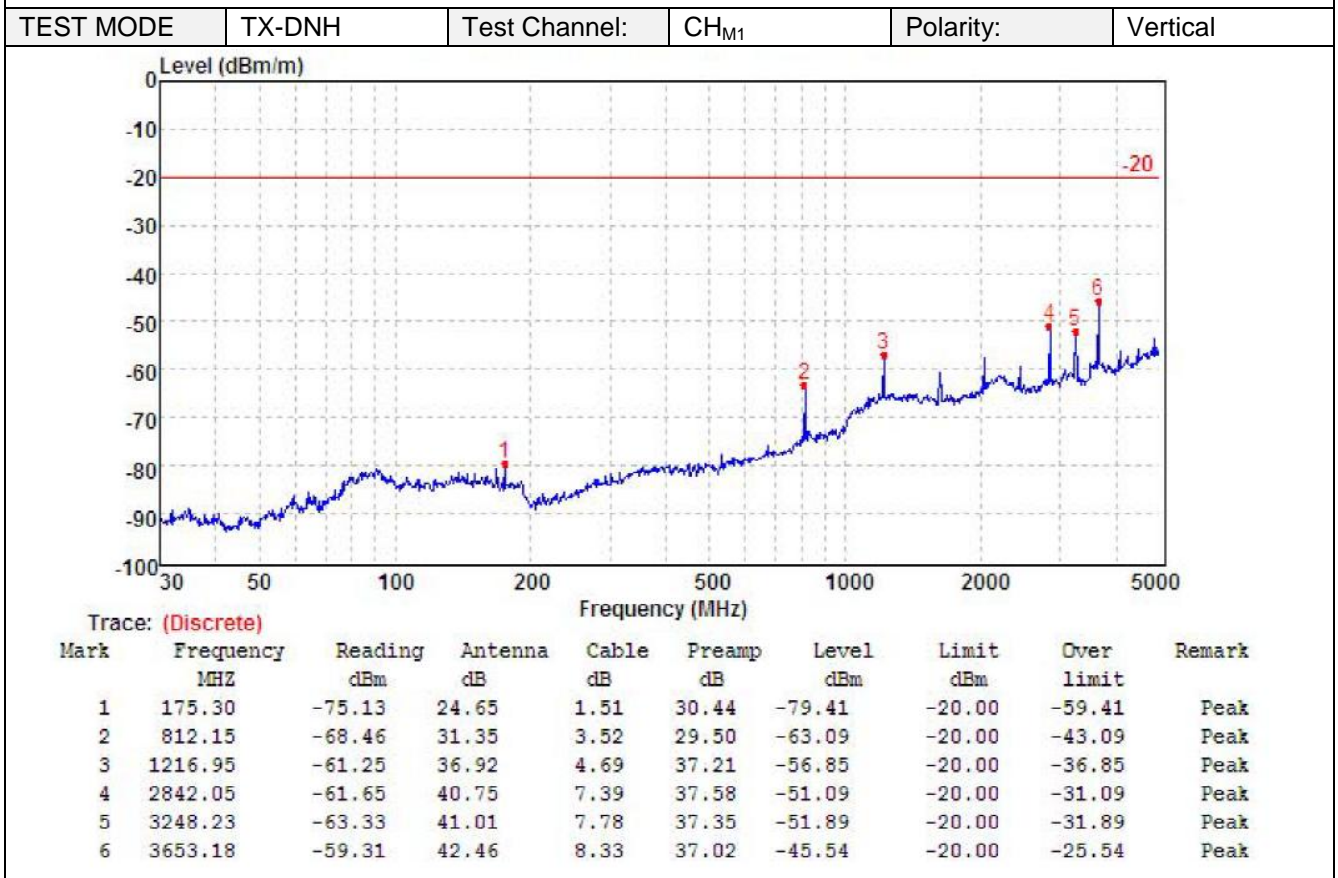
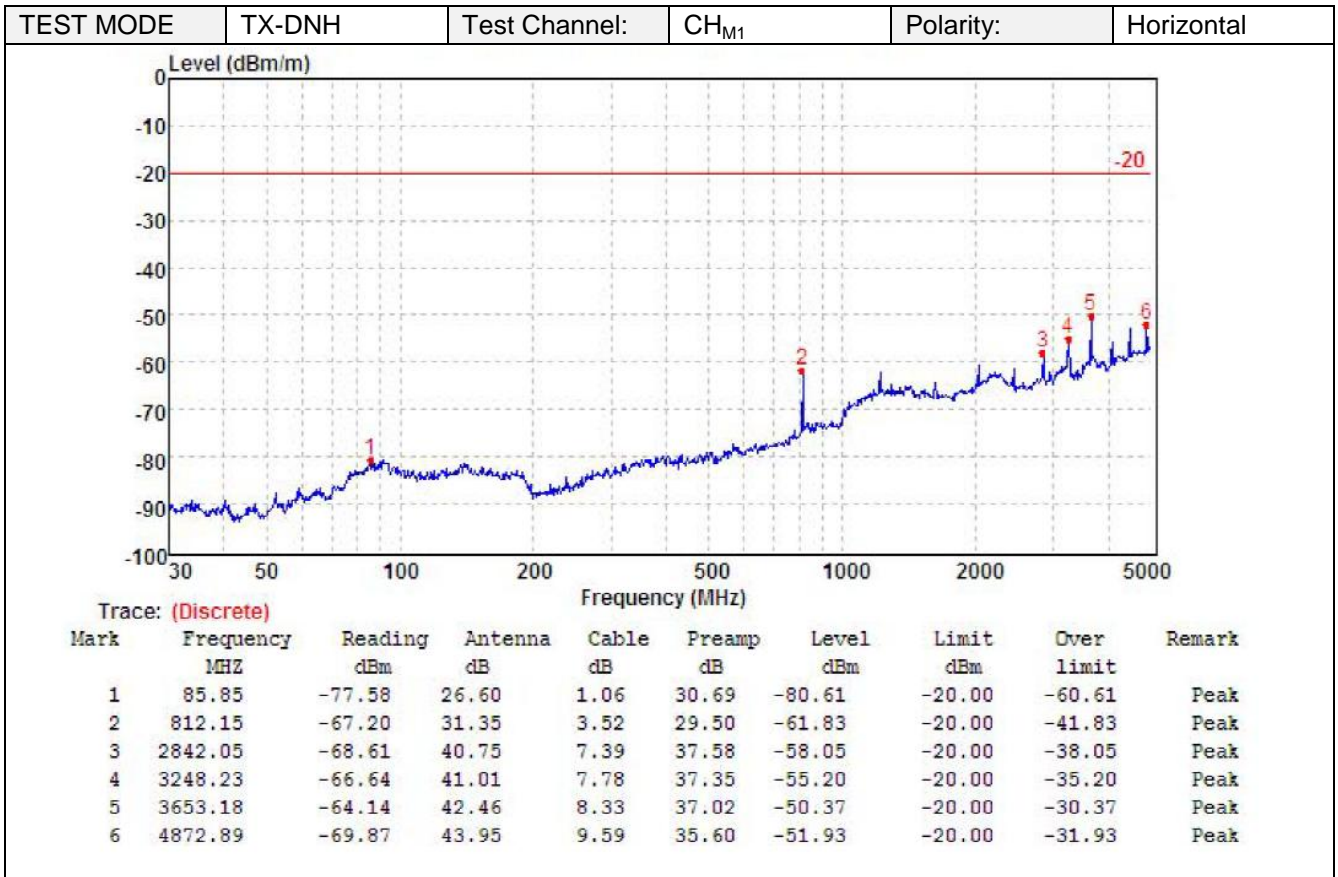

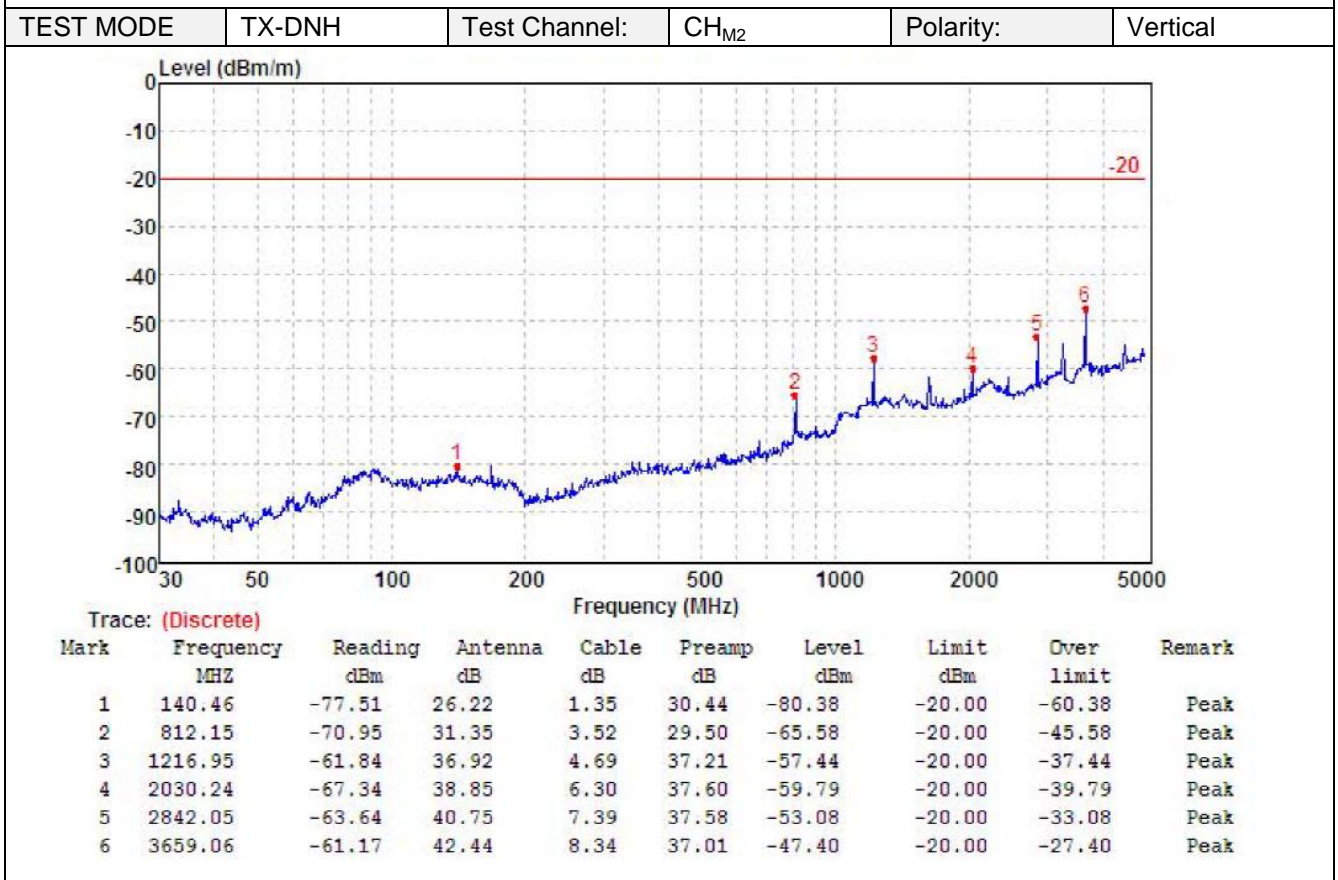
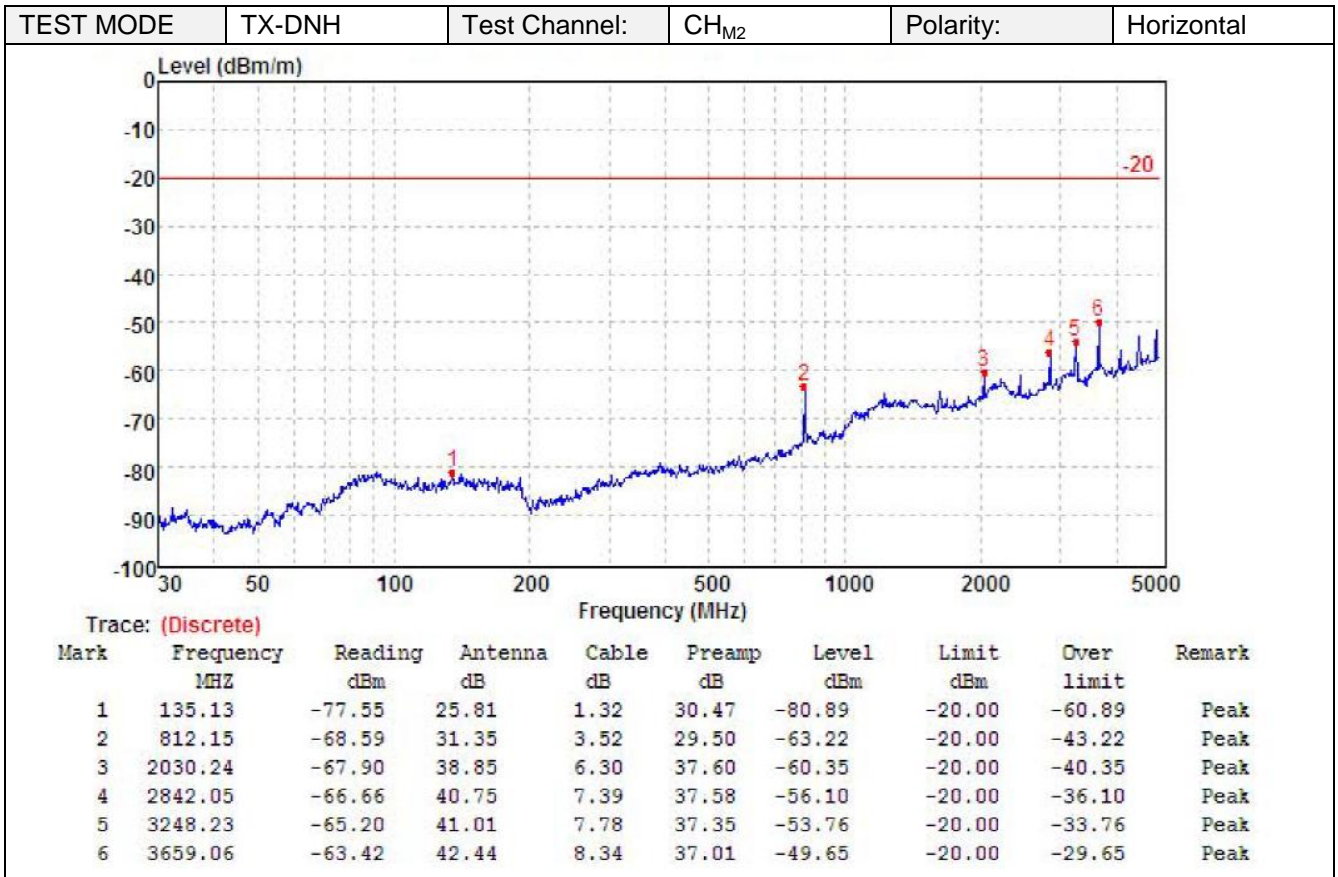

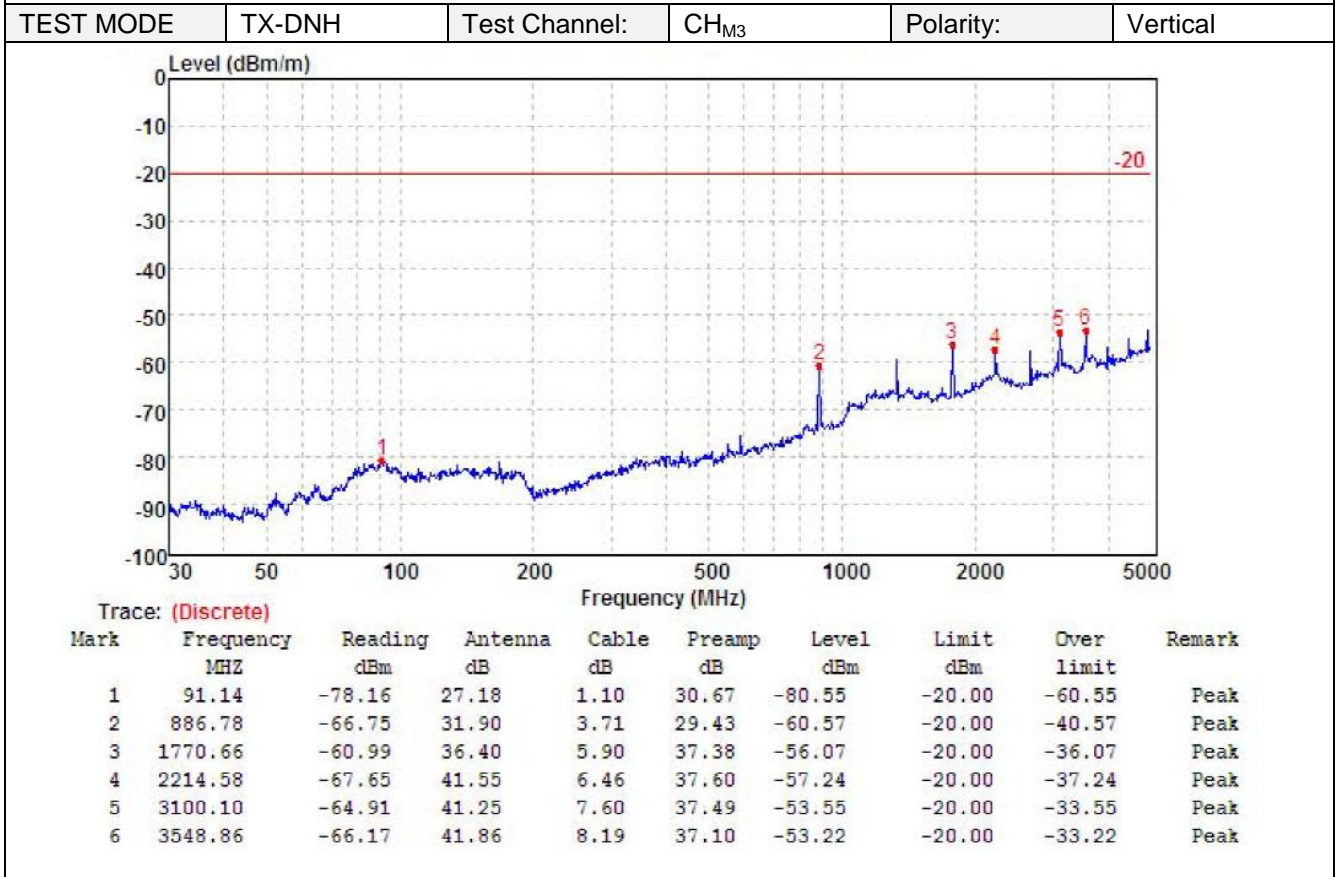
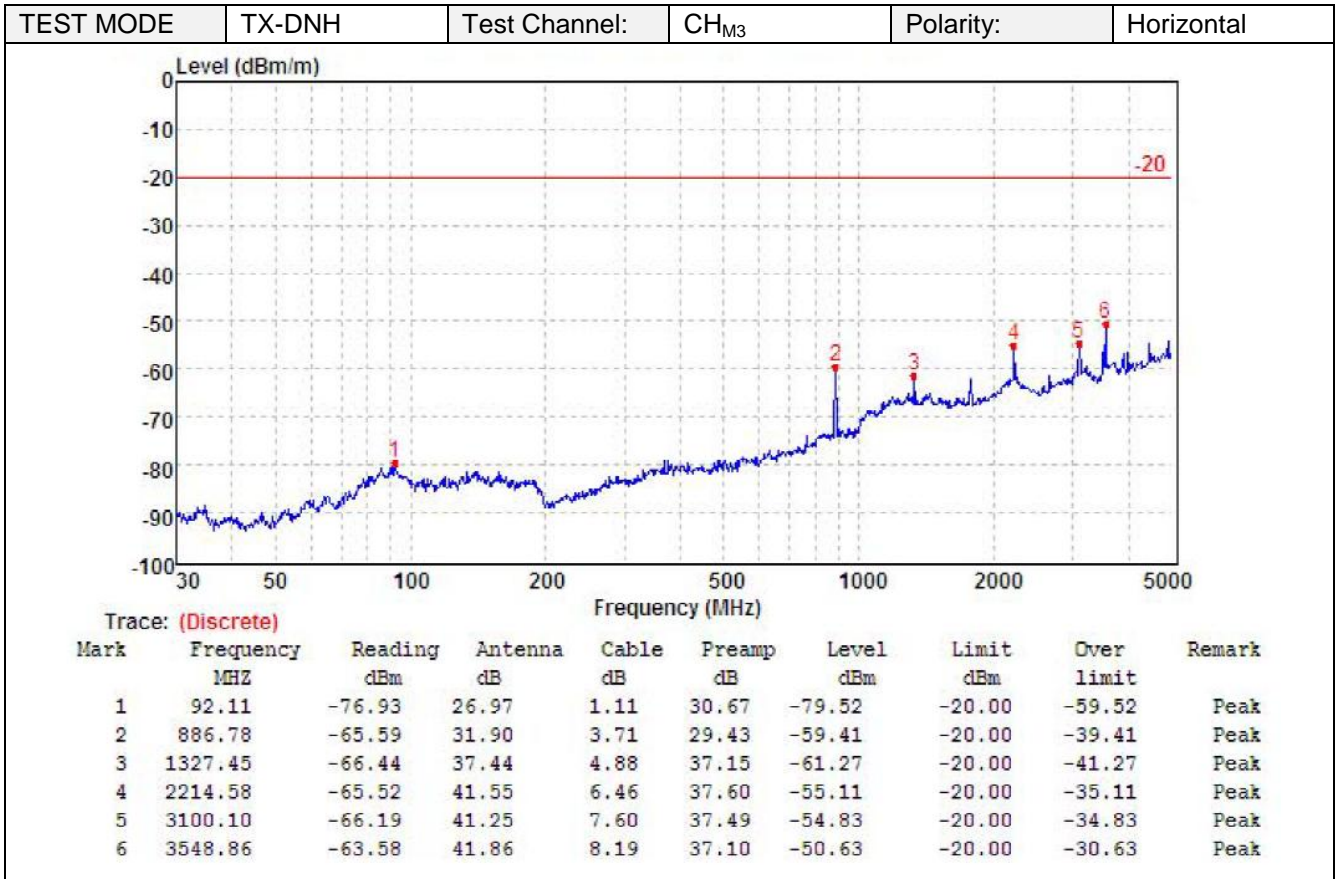

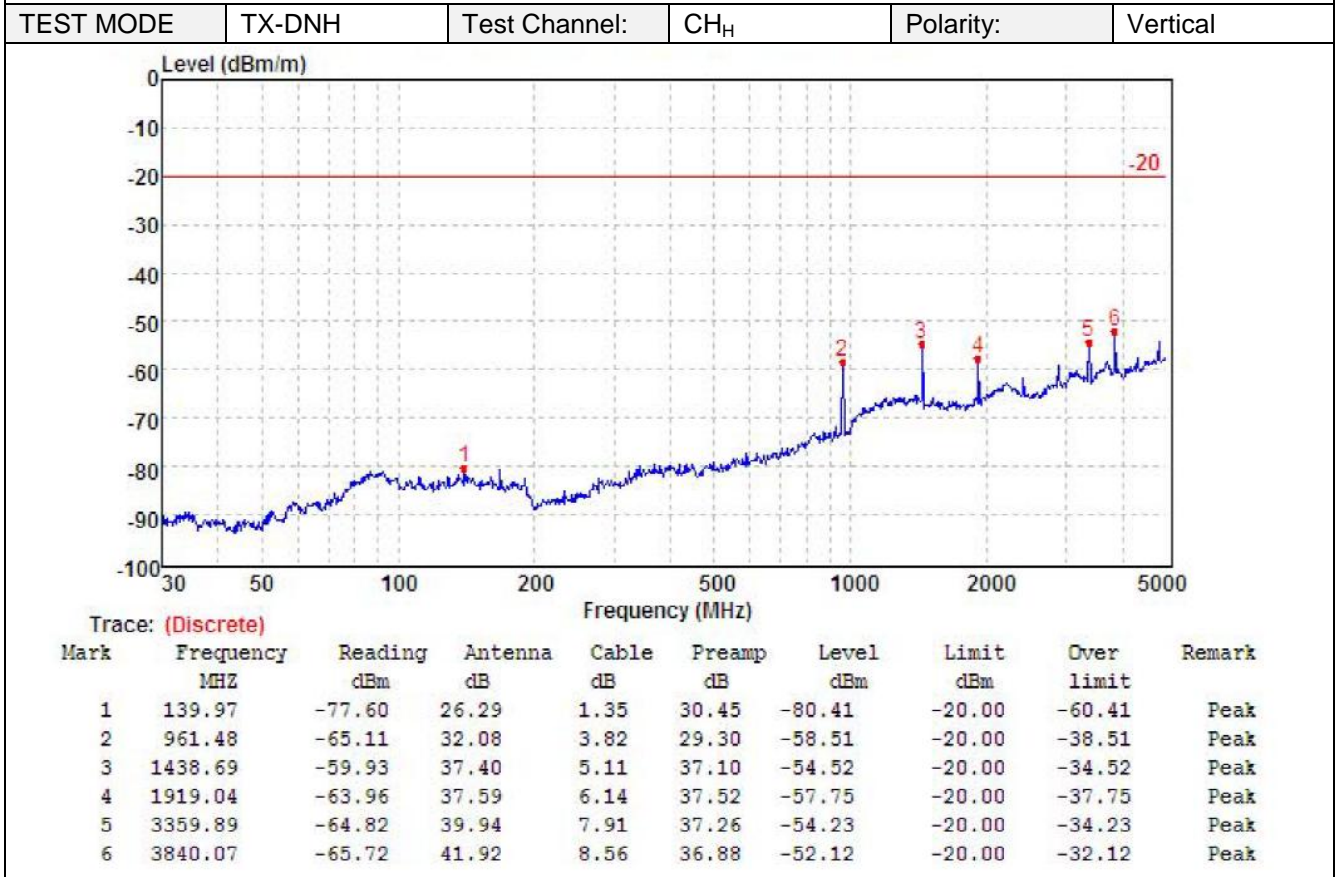
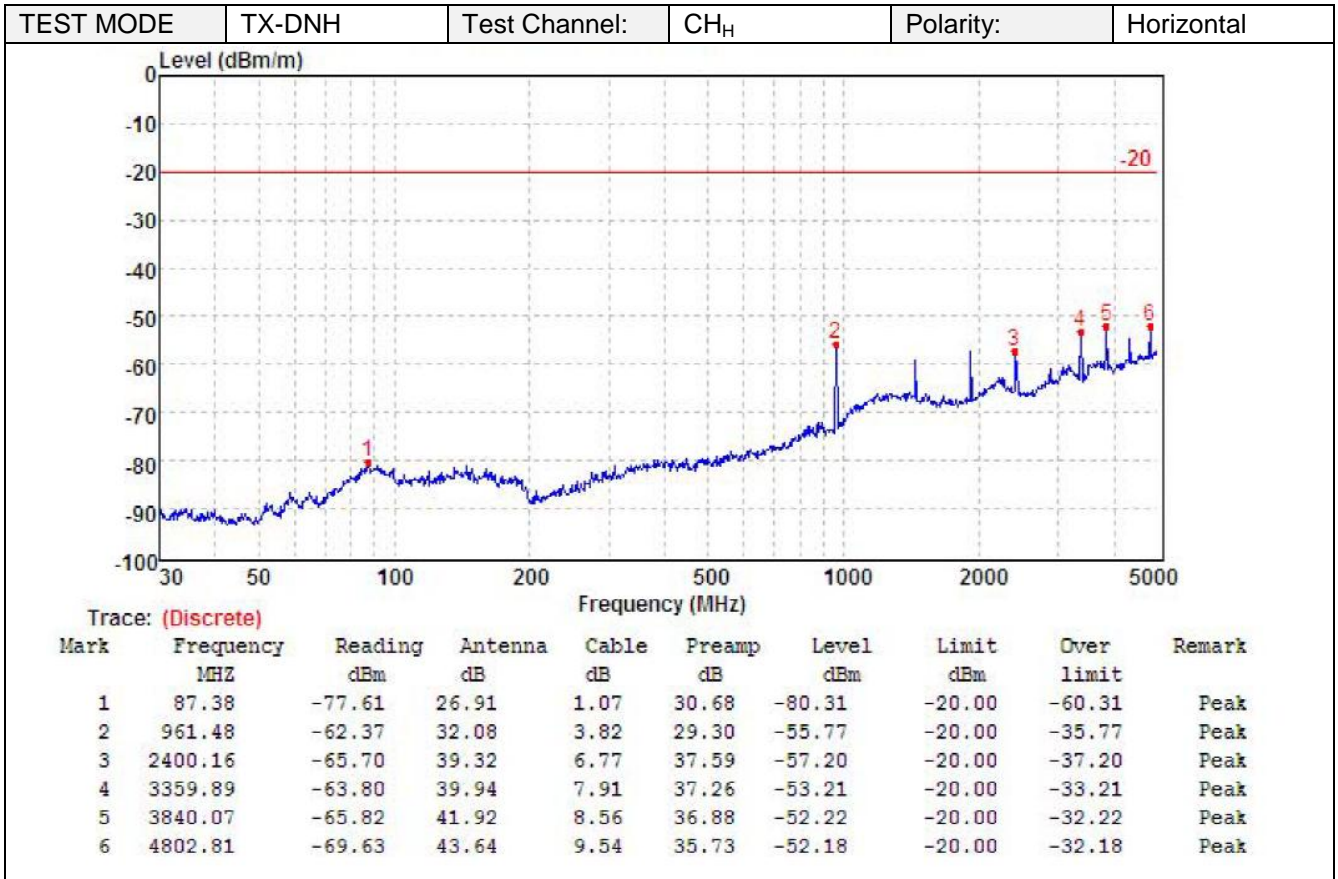

5.11 AC Power Line Conducted Emission

The frequency spectrum from 0.15 MHz to 30 MHz was investigated. The LISN used was 50 ohm / 50 u Henry as specified by section 5.1 of ANSI C63.4. Cables and peripherals were moved to find the maximum emission levels for each frequency.

Limit

FCC part 15.107(a)

Frequency of emission (MHz)	Conducted limit (dBµV)	
	Quasi-peak	Average
0.15-0.5	66 to 56*	56 to 46*
0.5-5	56	46
5-30	60	50

TEST CONFIGURATION

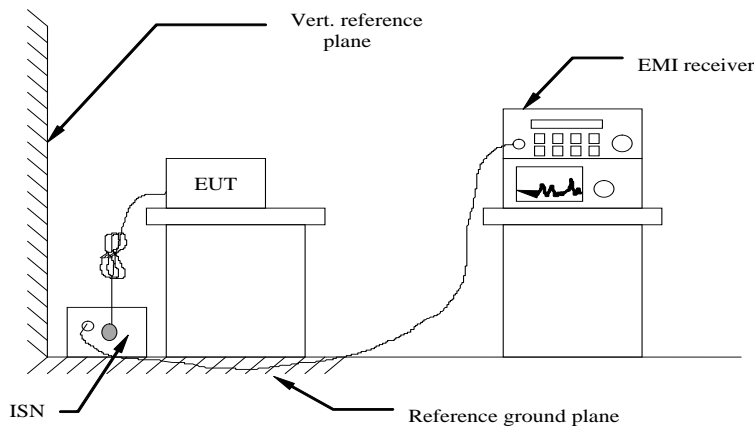

TEST PROCEDURE

- 1 The equipment was set up as per the test configuration to simulate typical actual usage per the user’s manual. The EUT is a tabletop system; a wooden table with a height of 0.8 meters is used and is placed on the ground plane as per ANSI C63.4
- 2 Support equipment, if needed, was placed as per ANSI C63.4
- 3 All I/O cables were positioned to simulate typical actual usage as per ANSI C63.4.
- 4 If a EUT received AC120V/60Hz power through a Line Impedance Stabilization Network (LISN) which supplied power source and was grounded to the ground plane.
- 5 All support equipments received AC power from a second LISN, if any
- 6 The EUT test program was started. Emissions were measured on each current carrying line of the EUT using a spectrum Analyzer / Receiver connected to the LISN powering the EUT. The LISN has two monitoring points: Line 1 (Hot Side) and Line 2 (Neutral Side). Two scans were taken: one with Line 1 connected to Analyzer / Receiver and Line 2 connected to a 50 ohm load; the second scan had Line 1 connected to a 50 ohm load and Line 2 connected to the Analyzer / Receiver.
- 7 Analyzer / Receiver scanned from 150 kHz to 30MHz for emissions in each of the test modes.
- 8 During the above scans, the emissions were maximized by cable manipulation.

TEST MODE

Please reference to the section 3.4

TEST RESULTS

Passed Not Applicable

Polarity:

L

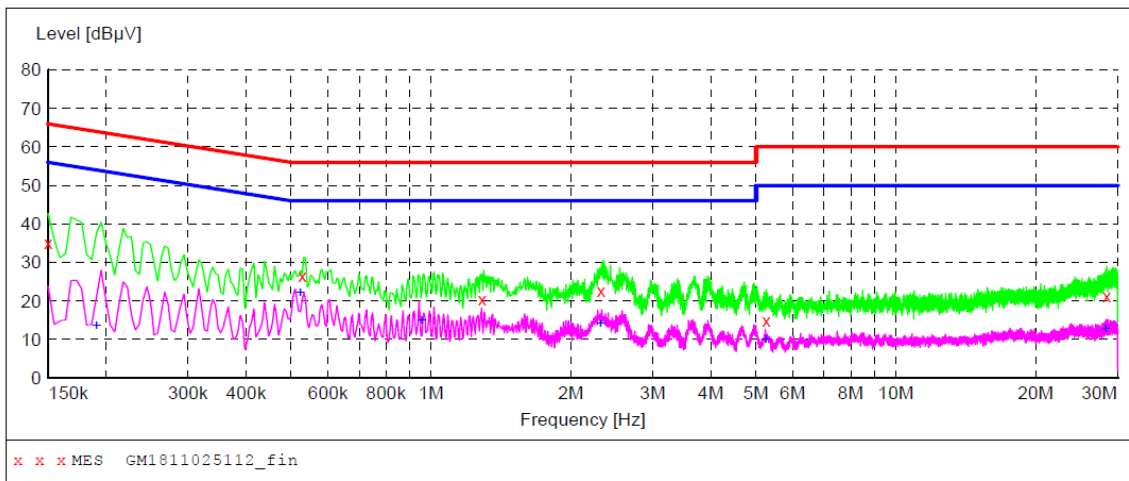

MEASUREMENT RESULT: "GM1811025112_fin"

11/2/2018 8:02PM

Frequency MHz	Level dBµV	Transd dB	Limit dBµV	Margin dB	Detector	Line	PE
0.150000	35.00	10.1	66	31.0	QP	L1	GND
0.528000	26.60	10.0	56	29.4	QP	L1	GND
1.288500	20.50	10.0	56	35.5	QP	L1	GND
2.319000	22.50	10.0	56	33.5	QP	L1	GND
5.257500	14.90	10.0	60	45.1	QP	L1	GND
28.446000	21.20	10.5	60	38.8	QP	L1	GND

MEASUREMENT RESULT: "GM1811025112_fin2"

11/2/2018 8:02PM

Frequency MHz	Level dBµV	Transd dB	Limit dBµV	Margin dB	Detector	Line	PE
0.190500	13.60	10.1	54	40.4	AV	L1	GND
0.523500	22.20	10.0	46	23.8	AV	L1	GND
0.955500	14.80	9.9	46	31.2	AV	L1	GND
2.314500	14.20	10.0	46	31.8	AV	L1	GND
5.248500	9.90	10.0	50	40.1	AV	L1	GND
28.270500	12.60	10.5	50	37.4	AV	L1	GND

Polarity: N

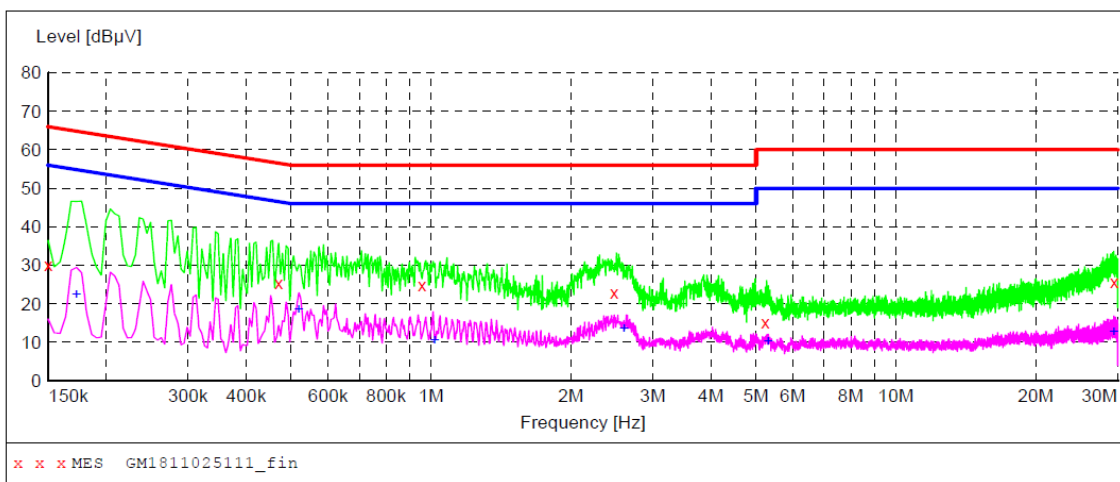

MEASUREMENT RESULT: "GM1811025111_fin"

11/2/2018 7:59PM

Frequency MHz	Level dBµV	Transd dB	Limit dBµV	Margin dB	Detector	Line	PE
0.150000	30.10	10.1	66	35.9	QP	N	GND
0.469500	25.30	10.1	57	31.2	QP	N	GND
0.955500	25.00	9.9	56	31.0	QP	N	GND
2.476500	22.90	10.0	56	33.1	QP	N	GND
5.235000	15.20	10.0	60	44.8	QP	N	GND
29.472000	25.80	10.5	60	34.2	QP	N	GND

MEASUREMENT RESULT: "GM1811025111_fin2"

11/2/2018 7:59PM

Frequency MHz	Level dBµV	Transd dB	Limit dBµV	Margin dB	Detector	Line	PE
0.172500	22.30	10.1	55	32.5	AV	N	GND
0.519000	18.40	10.0	46	27.6	AV	N	GND
1.018500	10.50	10.0	46	35.5	AV	N	GND
2.598000	13.50	10.0	46	32.5	AV	N	GND
5.307000	10.20	10.0	50	39.8	AV	N	GND
29.400000	12.70	10.5	50	37.3	AV	N	GND

5.12 Radiated Emission

LIMIT

For unintentional device, according to § 15.109(a) except for Class A digital devices, the field strength of radiated emissions from unintentional radiators at a distance of 3 meters shall not exceed the following values:

Frequency of emission (MHz)	Field strength (microvolts/meter)
30-88	100
88-216	150
216-960	200
Above 960	500

For intentional device, according to § 15.209(a), the general requirement of field strength of radiated emissions from intentional radiators at a distance of 3 meters shall not exceed the above table.

TEST CONFIGURATION

(A) Radiated Emission Test Set-Up, Frequency below 1000MHz

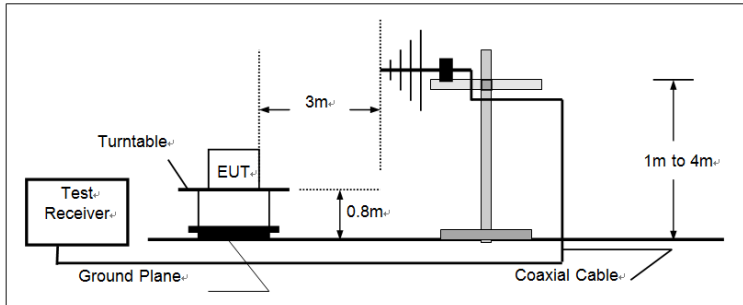

(B) Radiated Emission Test Set-Up, Frequency above 1000MHz

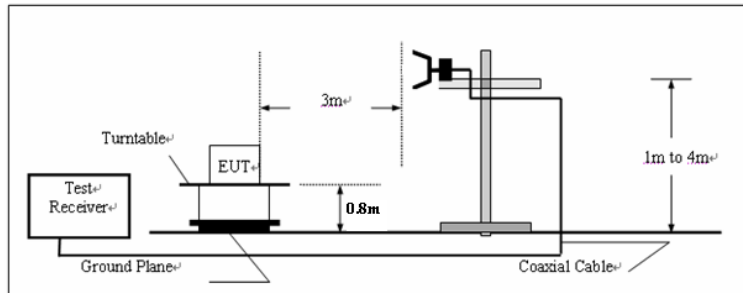

TEST PROCEDURE

- 1 The EUT was placed on a turn table which is 0.8m above ground plane.
- 2 Maximum procedure was performed by raising the receiving antenna from 1m to 4m and rotating the turn table from 0° to 360° to acquire the highest emissions from EUT
- 3 And also, each emission was to be maximized by changing the polarization of receiving antenna both horizontal and vertical.
- 4 Repeat above procedures until all frequency measurements have been completed.

TEST MODE

Please reference to the section 3.4

TEST RESULTS

Passed Not Applicable

Note:

The EUT shall be scanned from 30 MHz to the 5th harmonic of the highest oscillator frequency in the digital devices or 1 GHz whichever is higher.

Polarity: Horizontal

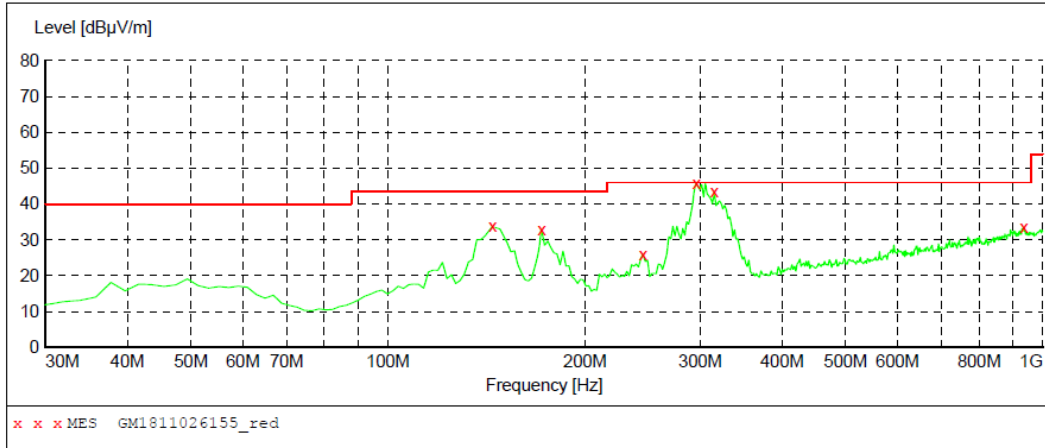

MEASUREMENT RESULT: "GM1811026155_red"

11/2/2018 11:35PM

Frequency MHz	Level dBuV/m	Transd dB	Limit dBuV/m	Margin dB	Det.	Height cm	Azimuth deg	Polarization
144.460000	33.70	-13.7	43.5	9.8	QP	300.0	0.00	HORIZONTAL
171.620000	33.00	-12.6	43.5	10.5	QP	100.0	356.00	HORIZONTAL
245.340000	26.00	-8.2	46.0	20.0	QP	100.0	119.00	HORIZONTAL
295.780000	45.70	-7.0	46.0	0.3	QP	100.0	320.00	HORIZONTAL
315.180000	43.40	-6.5	46.0	2.6	QP	100.0	170.00	HORIZONTAL
935.980000	33.50	8.1	46.0	12.5	QP	300.0	70.00	HORIZONTAL

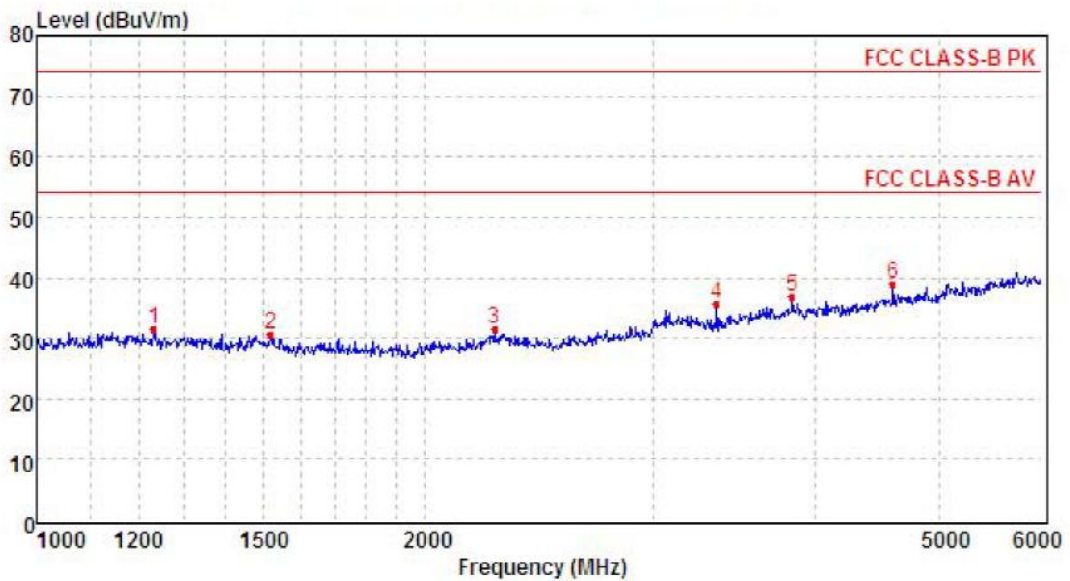

Mark	Frequency MHz	Reading dBuV/m	Antenna dB	Cable dB	Preamp dB	Level dBuV/m	Limit dBuV/m	Over limit	Remark
1	1233.23	37.7	26.3	4.7	37.2	31.5	74.0	-42.5	Peak
2	1518.13	36.7	25.6	5.3	37.1	30.5	74.0	-43.5	Peak
3	2263.79	34.6	27.9	6.5	37.6	31.4	74.0	-42.6	Peak
4	3363.63	36.8	28.2	7.9	37.3	35.6	74.0	-38.4	Peak
5	3847.42	35.7	29.6	8.6	36.9	37.0	74.0	-37.0	Peak
6	4602.41	34.7	30.9	9.5	36.1	39.0	74.0	-35.0	Peak

Polarity: Vertical

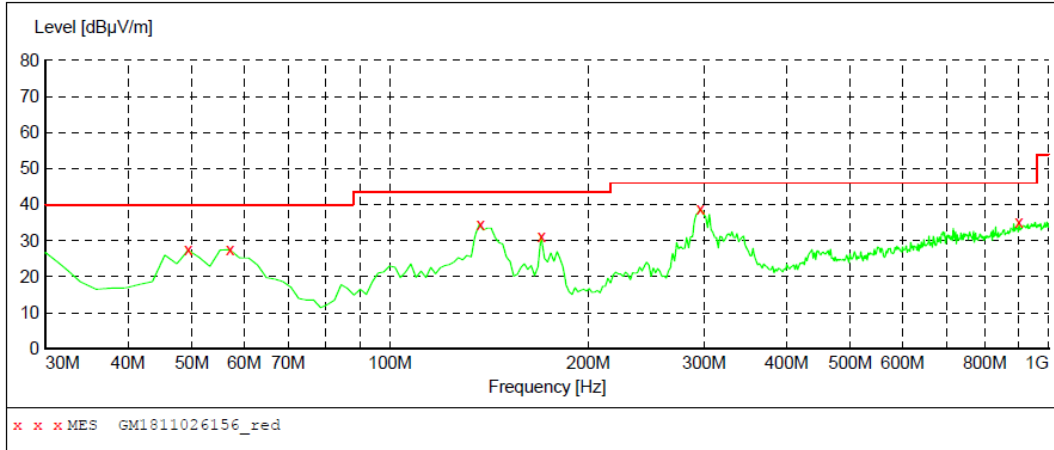

MEASUREMENT RESULT: "GM1811026156_red"

11/2/2018 11:38PM

Frequency MHz	Level dBuV/m	Transd dB	Limit dBuV/m	Margin dB	Det.	Height cm	Azimuth deg	Polarization
49.400000	27.40	-8.7	40.0	12.6	QP	100.0	109.00	VERTICAL
57.160000	27.50	-9.3	40.0	12.5	QP	100.0	31.00	VERTICAL
136.700000	34.50	-13.5	43.5	9.0	QP	100.0	56.00	VERTICAL
169.680000	31.30	-12.7	43.5	12.2	QP	100.0	22.00	VERTICAL
295.780000	38.70	-7.0	46.0	7.3	QP	100.0	159.00	VERTICAL
901.060000	35.20	7.6	46.0	10.8	QP	100.0	81.00	VERTICAL

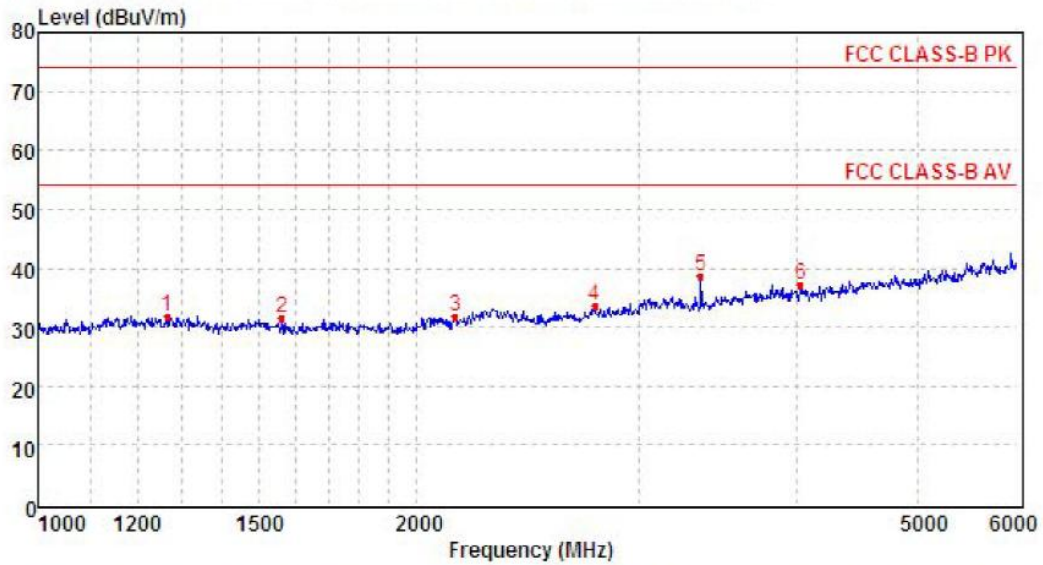

Mark	Frequency MHz	Reading dBuV/m	Antenna dB	Cable dB	Preamp dB	Level dBuV/m	Limit dBuV/m	Over limit	Remark
1	1266.82	38.0	26.2	4.8	37.2	31.8	74.0	-42.2	Peak
2	1562.28	37.8	25.2	5.5	37.1	31.4	74.0	-42.6	Peak
3	2145.32	36.0	27.1	6.4	37.6	31.9	74.0	-42.1	Peak
4	2766.88	35.7	28.1	7.3	37.6	33.5	74.0	-40.5	Peak
5	3363.63	39.8	28.2	7.9	37.3	38.6	74.0	-35.4	Peak
6	4038.13	35.3	29.8	8.8	36.7	37.2	74.0	-36.8	Peak

6 TEST SETUP PHOTOS OF THE EUT

Transmitter Radiated Spurious Emission:

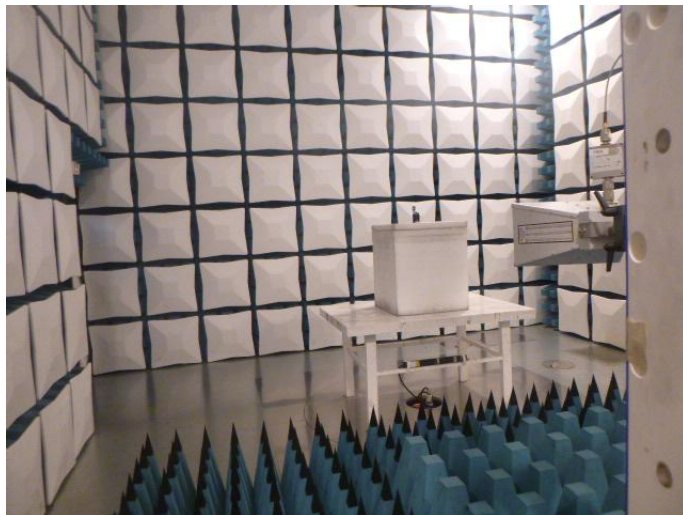
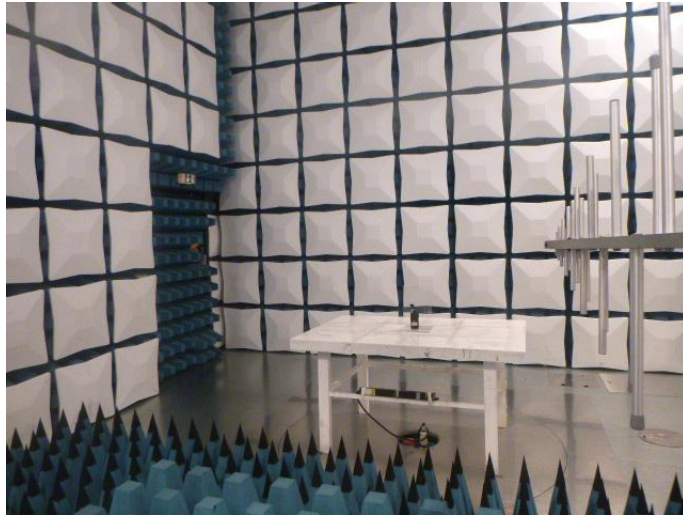

Frequency Stability:



Radiated Emission:

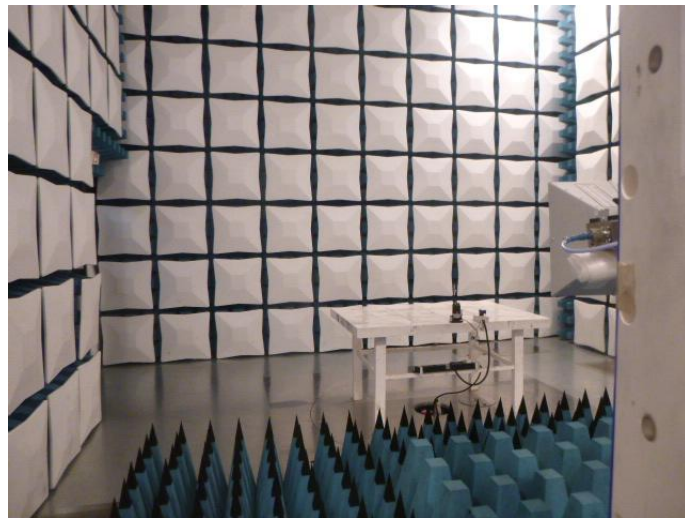

Conducted Emission:



7 EXTERNAL AND INTERNAL PHOTOS OF THE EUT

External Photos of the EUT

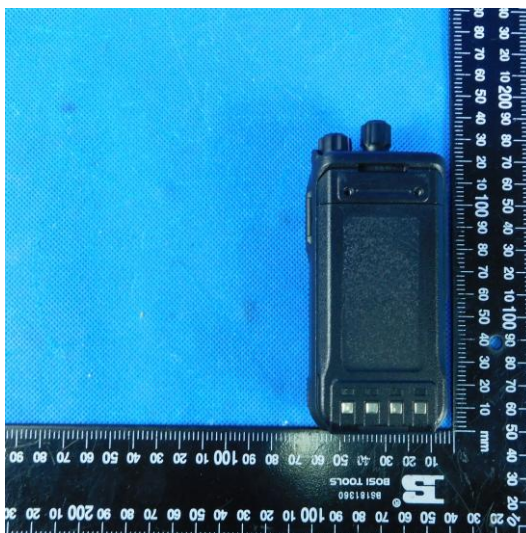





Internal Photos of the EUT



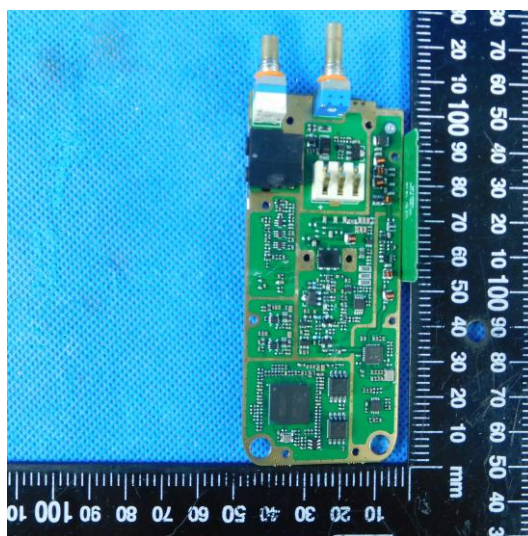
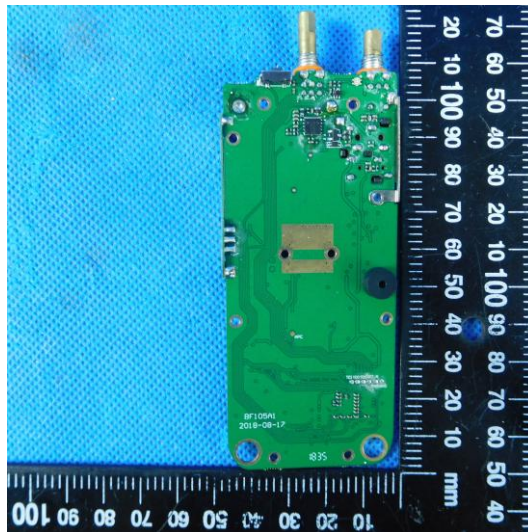
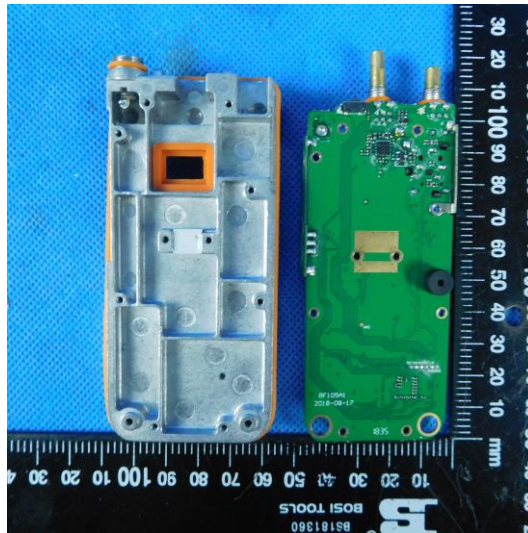

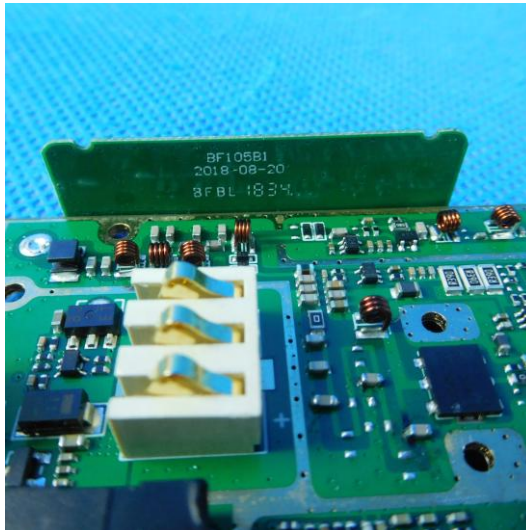
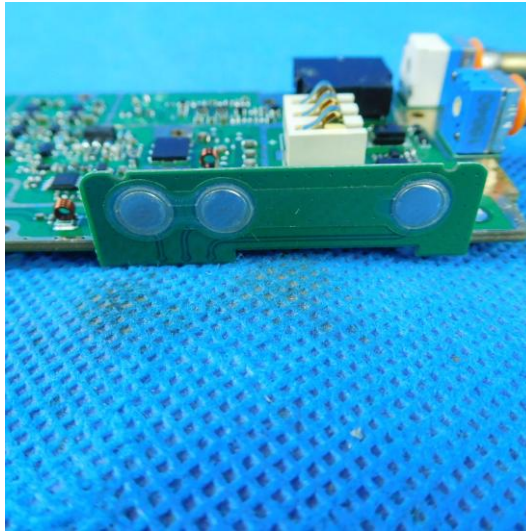

8 APPENDIX REPORT

**Appendix A:Maximum Transmitter Power**

Operation Mode	Modulation Type	Test Channel	Measured Power(dBm)	Measured Power(W)	Rated Power(W)	Percentage (%)	Limit (%)	Result
TX-DNH	4FSK	CH _L	36.5	4.47	5.00	-10.7	±20	PASS
TX-DNH	4FSK	CH _{M1}	36.6	4.57	5.00	-8.6	±20	PASS
TX-DNH	4FSK	CH _{M2}	36.6	4.57	5.00	-8.6	±20	PASS
TX-DNH	4FSK	CH _{M3}	36.7	4.68	5.00	-6.5	±20	PASS
TX-DNH	4FSK	CH _H	36.5	4.47	5.00	-10.7	±20	PASS
TX-DNL	4FSK	CH _L	30.7	1.17	1.00	17.5	±20	PASS
TX-DNL	4FSK	CH _{M1}	30.2	1.05	1.00	4.7	±20	PASS
TX-DNL	4FSK	CH _{M2}	30.7	1.17	1.00	17.5	±20	PASS
TX-DNL	4FSK	CH _{M3}	30.3	1.07	1.00	7.2	±20	PASS
TX-DNL	4FSK	CH _H	30.4	1.10	1.00	9.6	±20	PASS

**Appendix B:Occupied Bandwidth**

Operation Mode	Modulation Type	Test Channel	Occupied Bandwidth		99% Limit(kHz)	Result
			99%(kHz)	26dB(kHz)		
TX-DNH	4FSK	CH _L	6.007	8.551	≤11.25	PASS
TX-DNH	4FSK	CH _{M1}	6.367	8.343	≤11.25	PASS
TX-DNH	4FSK	CH _{M2}	6.575	8.669	≤11.25	PASS
TX-DNH	4FSK	CH _{M3}	6.318	8.347	≤11.25	PASS
TX-DNH	4FSK	CH _H	6.652	8.938	≤11.25	PASS
TX-DNL	4FSK	CH _L	6.244	8.228	≤11.25	PASS
TX-DNL	4FSK	CH _{M1}	6.458	8.791	≤11.25	PASS
TX-DNL	4FSK	CH _{M2}	6.596	8.770	≤11.25	PASS
TX-DNL	4FSK	CH _{M3}	6.243	8.409	≤11.25	PASS
TX-DNL	4FSK	CH _H	6.464	8.881	≤11.25	PASS



Appendix B:Occupied Bandwidth

Operation Mode	Modulation Type	Test Channel	TEST PLOT RESULT
TX-DNH	4FSK	CH _L	<p>Agilent Spectrum Analyzer - Occupied BW Center Freq 400.012500 MHz Center Freq: 400.012500 MHz Radio Std: None Trig: Free Run AvgHold>10/10 #IFGain:Low #Atten: 8 dB Radio Device: BTS</p> <p>10 dB/div Ref 24.01 dBm Center 400 MHz Span 50 kHz #Res BW 100 Hz #VBW 300 Hz Sweep FFT</p> <p>Occupied Bandwidth 6.000 kHz Total Power 26.1 dBm Transmit Freq Error 42 Hz OBW Power 99.00 % x dB Bandwidth 8.556 kHz x dB -26.00 dB</p> <p>Frequency: Center Freq 400.012500 MHz CF Step 5.000 kHz Freq Offset 0 Hz</p>
TX-DNH	4FSK	CH _{M1}	<p>Agilent Spectrum Analyzer - Occupied BW Center Freq 405.987500 MHz Center Freq: 405.987500 MHz Radio Std: None Trig: Free Run AvgHold>10/10 #IFGain:Low #Atten: 8 dB Radio Device: BTS</p> <p>10 dB/div Ref 24.23 dBm Center 406 MHz Span 50 kHz #Res BW 100 Hz #VBW 300 Hz Sweep FFT</p> <p>Occupied Bandwidth 6.327 kHz Total Power 26.5 dBm Transmit Freq Error 124 Hz OBW Power 99.00 % x dB Bandwidth 8.309 kHz x dB -26.00 dB</p> <p>Frequency: Center Freq 405.987500 MHz CF Step 5.000 kHz Freq Offset 0 Hz</p>
TX-DNH	4FSK	CH _{M2}	<p>Agilent Spectrum Analyzer - Occupied BW Center Freq 406.112500 MHz Center Freq: 406.112500 MHz Radio Std: None Trig: Free Run AvgHold>10/10 #IFGain:Low #Atten: 8 dB Radio Device: BTS</p> <p>10 dB/div Ref 24.19 dBm Center 406.1 MHz Span 50 kHz #Res BW 100 Hz #VBW 300 Hz Sweep FFT</p> <p>Occupied Bandwidth 6.575 kHz Total Power 26.2 dBm Transmit Freq Error 78 Hz OBW Power 99.00 % x dB Bandwidth 8.669 kHz x dB -26.00 dB</p> <p>Frequency: Center Freq 406.112500 MHz CF Step 5.000 kHz Freq Offset 0 Hz</p>



Appendix B:Occupied Bandwidth

Operation Mode	Modulation Type	Test Channel	TEST PLOT RESULT
TX-DNH	4FSK	CH _{M3}	<p>Agilent Spectrum Analyzer - Occupied BW Center Freq 443.050000 MHz Center Freq: 443.050000 MHz Trig: Free Run Avg/Hold: >10/10 Radio Std: None Radio Device: BTS</p> <p>10 dB/div Ref 22.45 dBm</p> <p>Center 443.1 MHz #Res BW 100 Hz #VBW 300 Hz Span 50 kHz Sweep FFT</p> <p>Occupied Bandwidth 6.309 kHz Total Power 24.7 dBm</p> <p>Transmit Freq Error 16 Hz x dB Bandwidth 8.347 kHz</p> <p>OBW Power 99.00 % x dB -26.00 dB</p> <p>Frequency: 443.050000 MHz CF Step: 5.000 kHz Freq Offset: 0 Hz</p>
TX-DNH	4FSK	CH _H	<p>Agilent Spectrum Analyzer - Occupied BW Center Freq 479.987500 MHz Center Freq: 479.987500 MHz Trig: Free Run Avg/Hold: >10/10 Radio Std: None Radio Device: BTS</p> <p>10 dB/div Ref 24.64 dBm</p> <p>Center 480 MHz #Res BW 100 Hz #VBW 300 Hz Span 50 kHz Sweep FFT</p> <p>Occupied Bandwidth 6.670 kHz Total Power 26.5 dBm</p> <p>Transmit Freq Error 23 Hz x dB Bandwidth 8.938 kHz</p> <p>OBW Power 99.00 % x dB -26.00 dB</p> <p>Frequency: 479.987500 MHz CF Step: 5.000 kHz Freq Offset: 0 Hz</p>
TX-DNL	4FSK	CH _L	<p>Agilent Spectrum Analyzer - Occupied BW Center Freq 400.012500 MHz Center Freq: 400.012500 MHz Trig: Free Run Avg/Hold: >10/10 Radio Std: None Radio Device: BTS</p> <p>10 dB/div Ref 23.28 dBm</p> <p>Center 400 MHz #Res BW 100 Hz #VBW 300 Hz Span 50 kHz Sweep FFT</p> <p>Occupied Bandwidth 6.238 kHz Total Power 25.2 dBm</p> <p>Transmit Freq Error 83 Hz x dB Bandwidth 8.228 kHz</p> <p>OBW Power 99.00 % x dB -26.00 dB</p> <p>Frequency: 400.012500 MHz CF Step: 5.000 kHz Freq Offset: 0 Hz</p>



Appendix B:Occupied Bandwidth

Operation Mode	Modulation Type	Test Channel	TEST PLOT RESULT
TX-DNL	4FSK	CH _{M1}	<p>Agilent Spectrum Analyzer - Occupied BW</p> <p>Center Freq 405.987500 MHz Center Freq: 405.987500 MHz Radio Std: None</p> <p>Trig: Free Run Avg/Hold: >10/10 Radio Device: BTS</p> <p>Ref 23.04 dBm</p> <p>Center 406 MHz Span 50 kHz</p> <p>#Res BW 100 Hz #VBW 300 Hz Sweep FFT</p> <p>Occupied Bandwidth Total Power 25.1 dBm</p> <p>6.406 kHz</p> <p>Transmit Freq Error 54 Hz OBW Power 99.00 %</p> <p>x dB Bandwidth 8.720 kHz x dB -26.00 dB</p> <p>Frequency: 405.987500 MHz</p> <p>CF Step: 5.000 kHz</p> <p>Freq Offset: 0 Hz</p>
TX-DNL	4FSK	CH _{M2}	<p>Agilent Spectrum Analyzer - Occupied BW</p> <p>Center Freq 406.112500 MHz Center Freq: 406.112500 MHz Radio Std: None</p> <p>Trig: Free Run Avg/Hold: >10/10 Radio Device: BTS</p> <p>Ref 23.02 dBm</p> <p>Center 406.1 MHz Span 50 kHz</p> <p>#Res BW 100 Hz #VBW 300 Hz Sweep FFT</p> <p>Occupied Bandwidth Total Power 24.9 dBm</p> <p>6.601 kHz</p> <p>Transmit Freq Error 131 Hz OBW Power 99.00 %</p> <p>x dB Bandwidth 8.845 kHz x dB -26.00 dB</p> <p>Frequency: 406.112500 MHz</p> <p>CF Step: 5.000 kHz</p> <p>Freq Offset: 0 Hz</p>
TX-DNL	4FSK	CH _{M3}	<p>Agilent Spectrum Analyzer - Occupied BW</p> <p>Center Freq 443.050000 MHz Center Freq: 443.050000 MHz Radio Std: None</p> <p>Trig: Free Run Avg/Hold: >10/10 Radio Device: BTS</p> <p>Ref 16.18 dBm</p> <p>Center 443.1 MHz Span 50 kHz</p> <p>#Res BW 100 Hz #VBW 300 Hz Sweep FFT</p> <p>Occupied Bandwidth Total Power 18.1 dBm</p> <p>6.242 kHz</p> <p>Transmit Freq Error 38 Hz OBW Power 99.00 %</p> <p>x dB Bandwidth 8.409 kHz x dB -26.00 dB</p> <p>Frequency: 443.050000 MHz</p> <p>CF Step: 5.000 kHz</p> <p>Freq Offset: 0 Hz</p>