

Notice to the user

Government law prohibits the operation of unlicensed radio transmitters within the territories under government control.

Illegal operation is punishable by fine or imprisonment or both.

THANK YOU!

We are grateful you choose BeiFeng series professional radio communications products!

Since 1989, BeiFeng has been always engaging in research and exploration of radio communications technologies, In order to lead intelligent technologies in the industry. We still make every effort to research and design products according to modern complicated communications environment, and we offer complete and customized communication solutions to clients. Our products will satisfy you because of its excellent performance and outstanding communications strength. No matter what field you are in. You will be Satisfied with the radio.

This manual is applicable to

UHF digital transceiver model: BF-TD371

RF Exposure Compliance and Control Guidelines and Operating Instructions:

Mandatory RF exposure training is required for workers to qualify devices for occupational exposure limits.

To control your exposure and ensure compliance with the occupational/controlled environment exposure limits always adhere to the following procedures.

Guidelines:

- Do not remove the RF Exposure Label from the device.
- User awareness instructions should accompany device when transferred to other users.
- Do not use this device if the operational requirements described herein are not met.

Operating Instructions:

- Transmit no more than the rated duty factor of 50% of the time. To transmit (talk), push the Push-To-Talk (PTT) button. To receive calls, release the PTT button.

Transmitting 50 % of the time, or less, is important because this radio generates measurable RF energy exposure only when transmitting (in terms of measuring for standards compliance).

- Hold the radio in a vertical position in front of face with the microphone (and the other parts of the radio, including the antenna) at least one inch (2.5 cm) away from the nose. Keeping the radio at the proper distance is important because RF exposures decrease with distance from the antenna. Antenna should be kept away from eyes.
- When worn on the body, always place the radio in an approved clip, holder, holster, case, or body harness for this product. Using approved body-worn accessories is important because the use of Beifeng's or other manufacturer's non-approved accessories may result in exposure levels, which exceed the FCC's occupational/controlled environment RF exposure limits.
- Use only manufacturer's name approved supplied or replacement antennas, batteries, and accessories. Use of non-manufacturer-name approved antennas, batteries, and accessories may exceed the FCC RF exposure guidelines.

CE 1313 

IC radiation exposure statement

This radio is intended for use in occupational/controlled applications where users have been made aware of the potential risks for exposure and can exercise control over their exposure.

This product is not authorised for general population, consumer or similar use. This transmitter must not be co-located or operating in conjunction with any other antenna or transmitter.

This transmitter must not be co-located or operated in conjunction with any other antenna or transmitter. Your radio should be used in its normal operating position when hand-held, worn on the body or secured within a cradle. Always ensure that the antenna is pointed away from the body, particularly the eyes. When body-worn, the radio must be secured using a Sepura approved attachment. Ensure the antenna is at least 2.5 cm (1 in.) away from the body when transmitting.

Cette radio a été conçue pour un usage professionnel dans un environnement contrôlé, où les utilisateurs sont pleinement conscients du danger potentiel de l'exposition à laquelle ils sont soumis et peuvent exercer un contrôle sur cette exposition. Ce dispositif radio N'EST PAS autorisé pour l'ensemble de la population, les consommateurs en général, ni pour une utilisation similaire. Cet émetteur ne doit pas être co-localisés ou fonctionner en conjonction avec une autre antenne ou émetteur.

It's important that the operator is aware of and understands hazards common to the operation of any radio .Please observe the following safety precautions to prevent radio damage or personal injury. The following precautions shall be observed during operation, service and repair of this radio.

◆ The recommended usage rate is 1 minute for TX and 4 minutes for RX, when the radio is used for transmission for many hours continuously, the

radiator and chassis will become hot, allow the rear panel of the radio to

contact surface of low melting point /low Ignition point object;

◆ Don't leave the transceiver in direct sunlight for a long time, don't place the transceiver on extremely heat, damp, dusty area, and don't put it on unstable surfaces;

◆ When restriction or warnings are posted regarding the use of radio devices, please obey the regulation turn the transceiver power off;

◆ Use of the radio while you are driving may be against traffic laws, please prohibit using it ;

◆ If you notice any problems on the radio, please turn off at first. Then contact with local dealer. Do not modify this radio unless instructed by this manual or refer service to a qualified licensed or certified technician only;

◆ If you want to use the machine for secondary development, please contact with BeiFeng's technical engineer or dealer for technical assistance;

◆ Please keep the surface of radio is clean and dry, clean the radio using a cloth moistened with clean water and a mild dishwashing liquid.

Contents

Supplied accessories	5
Accessories	6
Installation of Accessories	7
Getting Acquainted	11
Basic Operation	13
Turning the power on /off.....	13
Adjusting the volume	13

Selecting a Channel	13
Selecting a Zone.....	14
Calls on Digital channel	14
Functions and Operations.....	17
Scan	17
Auto Scan	18
Monitor and Permanent Monitor	18
Message	18
One Touch Call.....	18
Talk around.....	20
Squelch Level	20
Digital Emergency	20
Time Out Timer (TOT)	22
Voice Encryption.....	22
VOX.....	23
Warning Tones	23
Reject Stranger Call.....	24
TX Permission	24
Battery Saver.....	25
Lowery Battery Alert	25
PC Mode.....	26
Statement.....	27

Supplied accessories

Notes: The accessories listed below are covered by BeiFeng dealer, authorized BeiFeng agents or factories.

After carefully unpacking the transceiver, identify the items listed in the table below. If any items are missing or have been damaged during shipment

please contact with dealer immediately.

Accessories

Items	Number	Quantity
Antenna		1
Strap		1
Belt Clip		1
Charger		1
Li-ion Battery		1
Screws		2
Instruction Manual		1
Warranty Card		1
Certificate		1

Antenna



Strap

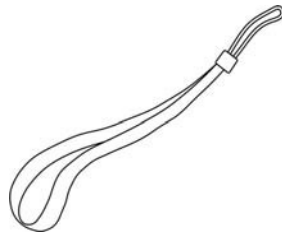

Belt Clip



Charger

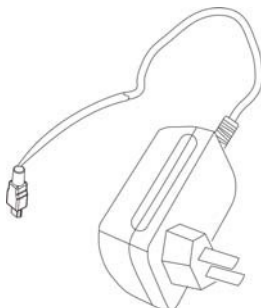

Li-ion Battery

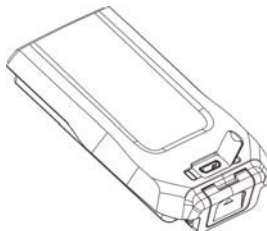

Screws



Installation of Accessories

Installation/ removing the antenna

Hold the supplied antenna by its base, then screw it into the connector on the top panel of the radio until fasten.

Turn the antenna anti-clockwise to remove it.

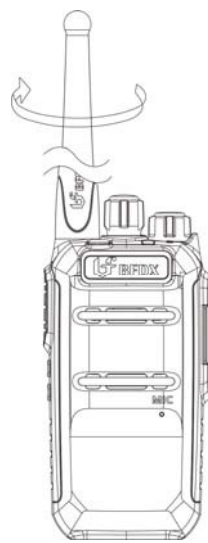

Attaching/Removing the belt clip

Attach the belt clip using the two supplied 3*4mm binding screws.

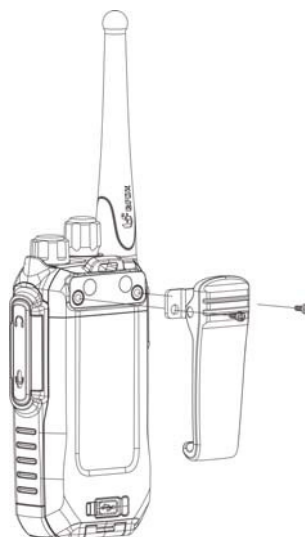

Attaching/Removing the Strap

Thread the hand strap to the loop back of your radio.

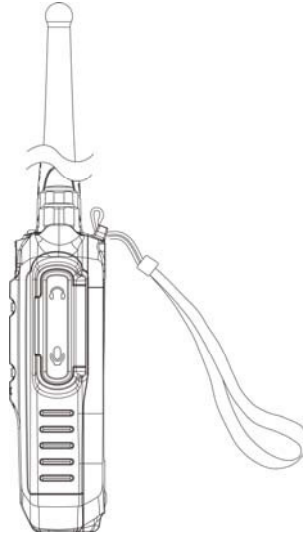

Attaching/Removing the Battery

Warning !

- ◆ Don't short-circuit the battery, it may cause the battery damaged or burst into flame;
- ◆ Never attempt to remove the casing from battery, that avoid to short the battery terminal;
- ◆ Battery is flammable objects, don't throw it into fire or don't use it on dangerous area.

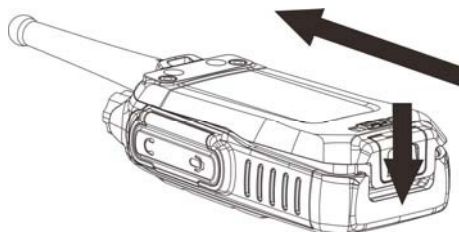

To remove the battery, please turn the power off then press the release latch to unlock the battery pull the battery away from the radio.

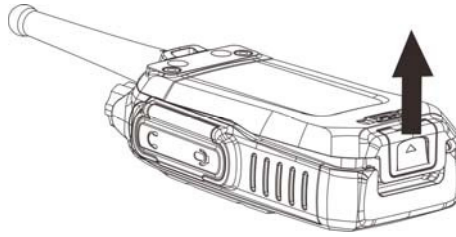

Note: Don't attach / remove the battery if the transceiver turned on.

Li-ion battery features

- New batteries are activated from factory; please charge your battery before using it. The maximum battery capacity and performance is achieved after three full charge/ discharge cycles.
- The service life of batteries: Charge cycles time is limited, to prolong battery life try to reduce make charge by the battery remained.
- To reduce self-discharge, please remove the battery before you not in use for a long time, and store your battery in a cool, dry location.
- Charge your battery about 50% before you store it for a long time, so that can prevent to decrease the battery performance.
- As the battery is charged and discharged repeatedly, the battery capacity decreases, even if the battery is unused, the battery degrades, and store battery in a high temperature will shorten its lifecycle.

Charging the Li-ion battery

- When the battery power runs low, the radio will send alert sounds, please recharge the battery.

- Please only use the battery and charger specified by BeiFeng.
- When charging a battery attached to a radio, please turn the radio off.
- Please don't remove the battery from the charger before fully charge, or the battery could suffer damage.
- Please remove the battery timely when the battery is fully charged.

Note: While the battery is charged, the ambient temperature must be within 0~40, Temperature out of the limit may reduce working life or Charging efficiency.

Charging Steps

- 1、 Plug the USB of charger into the rear battery USB.(Only the battery or the radio is attached with battery charging)
- 2、 Plug the AC connector of the charger into the outlet socket.
- 3、 Making sure the battery is connected to the charger, the charging process initiates when the charger indicator glows red.
- 4、 The charger indicator glows green when the battery is fully charged.

Note: Mack sure the battery is connected to the charger, but the charger indicator not glow, Maybe the battery /charger has damaged or temperature out of the limit.

Attaching the Speaker/Microphone

Open the accessory jack cover, then align the plug with the accessory jack and tighten the screw on the plug.

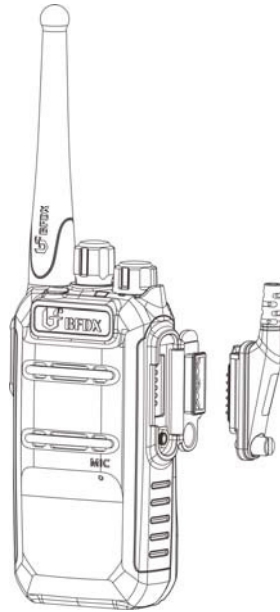

Getting Acquainted

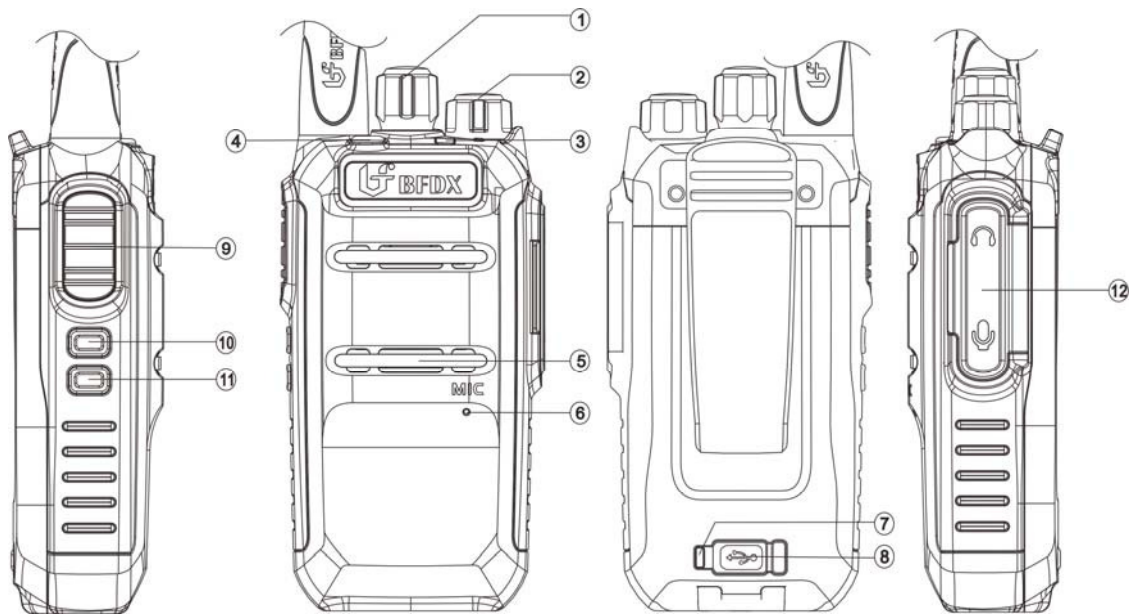

① Channel Selector Knob

Turn the knob to select channel 1-16, if a channel is available, there will be a channel number sounds.

② Power switch/volume adjust keys

Turn clockwise to switch the radio power on, when the radio is turned on,

rotate clockwise to increased volume, counter- clockwise to decrease the volume. Turn counterclockwise fully to switch the radio off.

③ **LED Indicator**

When transmitting LED glows red; when receiving LED glows green; when scanning LED flashes red; when battery gets low, LED flashes red.

④ **Orange Button**

Press to activate the programmable function. Emergency On/Off feature is set to orange button only. (The detailed consult to basic operation)

⑤ **Speaker**

⑥ **Microphone**

⑦ **LED indicator of charging**

When charging LED glows red, when battery full LED glows green.

⑧ **USB**

Plug in the USB to charge

⑨ **PTT Key**

Press and hold down the PTT key then speak into the microphone to transmit.

⑩ **Button 1**

Press to activate the programmable function. (The detailed consult to basic operation)

⑪ **Button 2**

Press to activate the programmable function. (The detailed consult to basic

operation)

⑫ MIC-SP Jack

Connect to optional speaker/MIC and programming cable.

Basic Operation

Turning the power on /off

Rotate the power switch/volume adjusts keys clockwise to turn the power on.

A current channel number and current zone number sounds.

Rotate the power switch/volume adjusts keys anti-clockwise to turn the power off.

Adjusting the volume

After the radio is power on, you can rotate the power switch/volume adjust keys to adjust the volume level, rotate the knob clockwise to increase the volume, or rotate the knob anti-clockwise to decrease the volume.

Selecting a Channel

Turn the channel selector knob to select channel 1 to 16, rotate the knob clockwise to increase the channel number, or rotate the knob anti-clockwise to decrease the channel number.

Note: While the channel is un-programmed, a prompt tone:" no channel "sounds.

Selecting a Zone

The radio supports up to 32 zones, each with a maximum of 16 channels, 32 zones all support up to 160 channels. Via the programming software you can select 2 desire zones at most to write in. You may select a desire zone through by setting zone toggle function to button 1 or button 2, then handover zone.

While enable all tone alert, select zone will hear a zone number.

Calls on Digital channel

To transmit press and hold down the PTT key, LED indication glows red, speak into the microphone, hold the palm microphone approximately 3 to 4 centimeters away from your mouth.

1.) Group Call

If you want to transmit a group call, the radio must be set with group call contact and preset a group call contact for current digital channel, press PTT key to transmit a group call. Or you can set the One Touch Call key as group call feature, then press programmed key to transmit a group call. Release PTT key to receive.

2.) Private Call

If you want to transmit a private call, the radio must be set with private call contact and preset a private call contact for current digital channel, press PTT key to transmit a private call. Or you can set the One Touch Call key as private call feature, then press programmed key to transmit a private call. If the feature

“private call ACK” is enabled, to transmit a private call need to confirm whether it is power on or activate on the current channel , while private call is failed, a low-pitched tone sounds. Release PTT key to receive.

3.) All Call

If you preset an all call contact for current digital channel. Press PTT key to transmit an all call; Release PTT key to receive.

Button Setting

For enhanced convenience, you may program the keys orange button, button1, button2, short and Long press of a key can be assigned with different functions.

Programmable keys are including functions listed below:

- **Unassigned** : The key is not assigned with any function.
- **One Touch Call 1~6** :Allow user to initiate digital group call, digital private call, or send preset message or send call alert via the one touch call function.
- **Emergency on/off**: Allow user to make an emergency call.

Note: Emergency On/Off feature is set to orange button only.

- **Monitor** : Enable monitor function.
- **Scan on/off**: Allow user to enable or disable the scan function.
- **All alert tone on/off**: Allow user to enable or disable all alert tones.
- **Battery Indication** :It's convenient to know battery capacity. If battery strength level is 70%-100%, a “Power High” sound; if battery strength level is 30%-70%,

a "Power Middle" sounds; if battery strength level is 15%-30%, a "Power Low" sound.

Note: If the battery gets lower, a "Please Charger" tone will sound, at the time press programmed "Battery Indicator" key, you can't hear battery capacity indication sound.

● **Zone Toggle:** Allow user to change zones, if the radio contains 2 zones, press programmed button will be a zone number sounds. If the radio only add a zone, this feature is useless.

● **Repeater/talk around :** Allow radio set to connect through repeater or achieve standalone communication in talk around mode.

● **Vox on/off:** If set vox level as 1 to 8 via programming software, press the programmed VOX on/off key to enable or disable the VOX feature. Press to activate the VOX feature a VOX on sounds; disable the VOX feature a VOX off sounds.

Note: Plug the dedicated earpiece into the accessory jack of the radio, the VOX feature is effective.

● **Nuisance Delete:** While scanning on, If you don't want to receive activities on the channel, press the programmed Nuisance Delete key to remove the channel from the scan list temporarily. When restart scanning, the nuisance channel will return to scan list.

● **Permanent Monitor:** Permanent monitor feature is the same as monitor, but permanent monitor feature only can be set as long press key. And you should long press the programmed Permanent Monitor key to exit this feature.

Functions and Operations

Scan

Scan is useful for monitoring signals on the radio channels, the channels include in the scan list. While scanning, the radio checks for a signal on each channel and only stops on a channel if a signal is present. Press programmed Scan on/off key to begin scanning, while scanning on, a “scan on” sounds, LED indicator flash red. While scanning off, a “scan off” sounds

Via programmable software to set it: Scan folder(Scan hang time) → A desired scan list → add available channel to members channel → a digital or analog channel to select scan list

- **Scan Hang Time** : When a signal is detected on a channel, scan pauses on that channel, the radio will remain on the busy channel until the signal is no longer present. When the signal “ drop out” the radio will remain on the channel momentarily before scan resumes. The delay time is programmed 500 to 10000 milliseconds.

- **Talkback** : When a signal is detected on a channel, scan pauses on that channel, press PTT key can talk back on the channel if enable “Talk Back’ feature; if “Talk Back” isn’t checked, press PTT key may talk back on the designated channel.

- **TX Designated Channel** : During scanning, Press PTT key will transmit on TX designated channel. You can set TX Designated Channel as Last Active Channel, Selected channel or a desired channel from scan list.

Auto Scan

If Auto Scan feature is enabled for a channel, the radio will automatically enter scan mode when it is switched to this channel. To stop scanning, press programmed Scan On/Off key or switch to other channels. If return to the channel will enter scan mode directly.

Monitor and Permanent Monitor

Monitor: On analog or digital channel, enable the Monitor feature to monitor current channel activities and receive weak signals. Press the programmed Monitor key to activate the monitor function, if a signal is detected, until the signal is no longer present the radio will exit monitor mode.

Permanent Monitor: Permanent monitor feature is the same as monitor, but long press the Permanent Monitor key to enter monitor mode, the radio will remain on monitor mode until long press it again to exit.

Message

On digital channel, you can send preset messages by programmed one touch call key. Edit message text via programming software, the message list save up to 10 entries, and each of a message contains 140 characters at most.

One Touch Call

On digital channel, one touch call feature contains: to send messages or transmit to a group call contact, to send messages or send call alert and

transmit to a private call contact.

●Group Call

On digital channel, one touch call feature contains: to send messages or transmit to a group call contact, to send messages or send call alert and transmit to a private call contact.

●Group Message

On one touch call menu, the call member select group call contact, and the call type select short message, message text select from preset message list. Then the programmed key set as one touch call, press the programmed key to send a message to a group call.

●Private Call

On one touch call menu, the call member select private call contact, and the call type select private call. Then the programmed key set as one touch call, press the programmed key a high-pitched tone sound, with 5 seconds press PTT key to transmit a private call.

●Private Message

On one touch call menu, the call member select private call contact, and the call type select short message, message text select from preset message list. Then the programmed key set as one touch call, press the programmed key to send a message to a private call.

●Call Alert

On one touch call menu, the call member select private call contact, and the

call type select call alert, then the programmed key set as one touch call, press the programmed key to send call alert to a private call.

Talk around

Talk Around: When your repeater malfunctions, or when radio is out of repeater's range, you can continue to communicate in talk around mode. While enable talk around feature, by this time TX frequency the same as to RX frequency. Press the programmed Repeater/Talk Around key to switch between repeater modes and talk around mode. Switch to talk around, a "talk around" sound; switch to repeater mode, a "repeater" sounds.

Via programmable software to set it: Channel folder → Zone → a digital or analog channel → Allow Talk Around

Note : To enable this function, TX frequency should be different from RX frequency, and the channel will set as allow talk around on the programming software.

Squelch Level

On analog mode, this feature allows you to adjust the squelch threshold for the radio to receive audio. You can set squelch level as 0~9. High level requires stronger signal for the radio to un-mute.

Via programmable software to set it: Channel folder → Zone → an analog channel
→Squelch Level

Digital Emergency

In case of an emergency you can enter emergency mode to ask for help, short press programmed "Emergency on" key to send emergency information, To exit emergency mode, long press "Emergency off". On regular type alarm, after send emergency information then receive ACK command or the alarm cycles

expire, the radio will exit the emergency mode automatically. On silent type alarm, after send emergency information then press PTT key to exit emergency mode.

Via programmable software to set it: Signaling Systems folder → Digital Red Alert → add system1 to set parameters → Channel folder → add

Emergency system

- **Emergency Type:** Disable, Regular, Silent, Silent with voice, the Disable option is unable to transmit emergency information.

- **Emergency Mode:** Emergency Alarm, emergency alarm with call, emergency alarm with voice to follow.

- **Revert Channel:** Revert channel is used for digital emergency, only the channel default address is set as group call contact, the channel is available for revert channel.

- **Impolite Retries:** If the current channel is busy, press programmed key also can send emergency information, number of impolite retries can be set as 1 to 15.

- **Polite Retries:** Only when the current channel is free, press programmed key to send emergency information, number of polite retries can be set as 0 to 14 and endless.

- **Hot MIC Duration:** If the emergency mode set as emergency alarm with voice to follow, after send emergency information, you voice and background noise to be transmitted automatically as you don't need to press PTT key within hot MIC duration.

Note: while the short press is set as emergency on, the long press will be set as emergency off default.

Time Out Timer (TOT)

The purpose of TOT is to prevent any user occupy a channel for an extended period. If a channel is busy, the time will be shorter. If the preset time expires, the radio will generate beep and terminate transmission automatically. Via programming software, you can set TOT as 15-495 second.

Via programmable software to set it: Channels folder → Zone → A digital or analog channel → TX Parameters → TOT-TOT Rekey Delay

Voice Encryption

The voice encryption can encrypt your audio signals to guarantee the privacy of your communication, via the programming software user can select encryption type as static or dynamic. If the encrypt feature is enabled, the transmitter and receiver will be set as the same encryption type and same voice encryption key, otherwise the receiver is mute.

Via programmable software to set it: General Settings folder → Voice Encryption Type → Voice Encryption Key

Note: This feature is effective on digital channel, if enable voice encryption feature, the voice encryption key must be 10 characters, there are including letters and numbers.

VOX

If enable VOX feature you can enjoy hands-free communication, the radio will automatically begin transmitting when you speaking, and terminate transmitting when you stop talking with no need of PTT press. You may set VOX level as 1~8 or disable (Off). When the environment too much noise, VOX level will be higher, when the environment is quiet, VOX level will be lower. It allow user to set VOX delay as 500 to 10000 milliseconds. If the VOX level is set as off via the programming software, press programmed VOX on/off key can't enable VOX feature, if the VOX level is set as 1 to 8, press programmed VOX on/off key can enable or disable VOX feature

Via programmable software to set it: General Settings folder →VOX level→ VOX delay(ms)

Note: The VOX feature shall work with a dedicated earpiece.

Warning Tones

Voice Indication

If enable voice indication feature, the radio will give tone indication for channel change, zone change, power level switch, scan feature enable or disable, VOX on or off, low battery alert, repeater mode or talk around mode switch and etc.

Channel Free Indication

On digital mode, if enable Channel Free Indication feature, the receiver gives a high-pitched tone indication while the transmitter release PTT key to stop

transmitting.

Channel Free Indication

There are four options are available for Talk Permit Indication feature: None (the radio does not give any tone indication for transmission on analog and digital channel), Analog (the radio gives tone indication for transmission on analog channel), Analog& Digital (the radio gives tone indication for transmission on analog and digital channel), Digital (the radio gives tone indication for transmission on digital channel).

Via programmable software to set it: General Settings folder → Tone Alerts → Voice Indication → Channel Free Indication → Talk Permit Indication

Reject Stranger Call

On digital mode, if enable reject strange call feature, while the call ID not exist in the contacts list, it's unable to transmit or receive. When received group call or all call, the device ID of transmitter and group call ID or all call ID preset on address list.

Via programmable software to set it: General Settings folder → Reject Strange Call

TX Permission

Digital Channel

This feature can restrict the channel if it is already in use you will be unable to

transmit. There are three options available: always, color code free, channel free, if choose always, whenever press PTT key to transmit directly; If choose color code free, you will be unable to transmit on the channel if the color code is already in use; If choose channel free, you will be unable to transmit on the channel if it is already in use. If the channel is busy, press PTT key a low-pitched tone will sound.

Via programmable software to set it: Channels folder → Zone → a digital channel → TX Parameters → Admit Criteria

Battery Saver

This feature allows an idler radio to automatically enter battery saver mode, the mode will extend battery service life, but response time may be delayed. You can set battery saver time ratio as : 1:1、 1 : 2、 1:3、 1:4, the time rate is smaller, the power saving more evidently.

Via programmable software to set it: General Setting folder → Battery Saver

Lowery Battery Alert

When your battery gets low, LED indicator glows red and with a warning tone: “Please Charge” , please replace the battery or charge the battery in time. The radio will turn off automatically while battery is too low.

Via programmable software to set it: General Setting folder → Tone Alerts → RX low battery interval (sec)

PC Mode

At first, connecting the radio with computer by data line then turn on two-way radio; Secondly , start the software (BFP-DH500) that the data will be write or read by users.

Statement

Our Company endeavors to achieve the accuracy and completeness of this manual, if you have any question, you can contact with us, we will make a detailed answer to you in time. All the above specifications and design are subject to change without prior notice due to continuous development.