



TEST REPORT

Report Reference No...... : **TRE18100220** R/C.....: 52870

FCC ID..... : 2AAR8RETEKESST116

Applicant's name..... : **HENAN ESHOW ELECTRONIC COMMERCE CO., LTD**

Address..... : Room 722,Sanjiang Building,No.170 Nanyang Road,Huiji District, Zhengzhou, Henan, China

Manufacturer..... : HENAN ESHOW ELECTRONIC COMMERCE CO., LTD

Address..... : Room 722,Sanjiang Building,No.170 Nanyang Road,Huiji District, Zhengzhou, Henan, China

Test item description : **Queue Wireless Calling System Transmitter**

Trade Mark : Reteless

Model/Type reference..... : T116

Listed Model(s) : T111,T112,T113,T113S,T115,T118,T119

Standard : **FCC CFR Title 47 Part 15 Subpart C Section 15.231(a)**

Date of receipt of test sample..... : Oct.25,2018

Date of testing..... : Oct.25,2018 ~ Nov.13,2018

Date of issue..... : Nov.13,2018

Result..... : **PASS**

Compiled by
(position+printed name+signature)...: File administrators Yueming Li

Yueming Li

Supervised by
(position+printed name+signature)...: Project Engineer Tom Ouyang

Tom ouyang

Approved by
(position+printed name+signature)...: RF Manager Hans Hu

Hans hu

Testing Laboratory Name : **Shenzhen Huatongwei International Inspection Co., Ltd**

Address..... : 1/F, Bldg 3, Hongfa Hi-tech Industrial Park, Genyu Road, Tianliao, Gongming, Shenzhen, China

Shenzhen Huatongwei International Inspection Co., Ltd. All rights reserved.

This publication may be reproduced in whole or in part for non-commercial purposes as long as the Shenzhen Huatongwei International Inspection Co., Ltd is acknowledged as copyright owner and source of the material. Shenzhen Huatongwei International Inspection Co., Ltd takes no responsibility for and will not assume liability for damages resulting from the reader's interpretation of the reproduced material due to its placement and context.

The test report merely correspond to the test sample.

Contents

1.	<u>TEST STANDARDS AND REPORT VERSION</u>	3
1.1.	Test Standards	3
1.2.	Report version	3
2.	<u>TEST DESCRIPTION</u>	4
3.	<u>SUMMARY</u>	5
3.1.	Client Information	5
3.2.	Product Description	5
3.3.	EUT operation mode	6
3.4.	EUT configuration	6
3.5.	Modifications	6
4.	<u>TEST ENVIRONMENT</u>	7
4.1.	Address of the test laboratory	7
4.2.	Test Facility	7
4.3.	Environmental conditions	8
4.4.	Statement of the measurement uncertainty	8
4.5.	Equipments Used during the Test	9
5.	<u>TEST CONDITIONS AND RESULTS</u>	10
5.1.	Antenna requirement	10
5.2.	Conducted Emission (AC Main)	11
5.3.	Field Strength of the Fundamental	14
5.4.	20 dB Bandwidth	16
5.5.	Continue Transmission Time	18
5.6.	Radiated Emission	20
6.	<u>TEST SETUP PHOTOS OF THE EUT</u>	23
7.	<u>EXTERNAL AND INTERNAL PHOTOS OF THE EUT</u>	24

1. TEST STANDARDS AND REPORT VERSION

1.1. Test Standards

The tests were performed according to following standards:

[FCC Rules Part 15.231\(a\)](#): Periodic operation in the band 40.66–40.70 MHz and above 70 MHz.

[ANSI C63.10-2013](#): American National Standard for Testing Unlicensed Wireless Devices.

1.2. Report version

Revision No.	Date of issue	Description
N/A	2018-11-14	Original

2. TEST DESCRIPTION

Test Item	Section in CFR 47	Result	Test Engineer
Antenna requirement	15.203	Pass	Xiaokang Tan
Conducted Emissions	15.207	Pass	Tony Duan
Field Strength of the Fundamental	15.231(b)	Pass	Tony Duan
20dB Bandwidth	15.231(c)	Pass	Xiaokang Tan
Continue Transmission Time	15.231(a)	Pass	Xiaokang Tan
Radiated Emissions	15.209/15.231(b)	Pass	Michael Jie

Note: The measurement uncertainty is not included in the test result.

3. SUMMARY

3.1. Client Information

Applicant:	HENAN ESHOW ELECTRONIC COMMERCE CO., LTD
Address:	Room 722, Sanjiang Building, No.170 Nanyang Road, Huiji District, Zhengzhou, Henan, China
Manufacturer:	HENAN ESHOW ELECTRONIC COMMERCE CO., LTD
Address:	Room 722, Sanjiang Building, No.170 Nanyang Road, Huiji District, Zhengzhou, Henan, China

3.2. Product Description

Name of EUT:	Queue Wireless Calling System Transmitter
Trade Mark:	Retekess
Model No.:	T116
Listed Model(s):	T111, T112, T113, T113S, T115, T118, T119
Test Voltage:	AC 120V, 60Hz
Power supply:	DC 5.0V From adapter
Adapter information:	Model: JYH32-0506000 Input: 100-240Va.c., 50/60Hz 1.5A Output: 5.0Vd.c., 6.0A
RF Specification	
Operation frequency:	433.92MHz
Channel number:	1
Modulation Type:	AM
Antenna type:	External antenna
Antenna gain:	0 dBi

3.3. EUT operation mode

The EUT has been tested under typical operating condition. The Applicant provides software to control the EUT for staying in continuous transmitting mode for testing.

3.4. EUT configuration

The following peripheral devices and interface cables were connected during the measurement:

- - supplied by the manufacturer
- - supplied by the lab

/	Manufacturer :	/
	Model No. :	/
/	Manufacturer :	/
	Model No. :	/

3.5. Modifications

No modifications were implemented to meet testing criteria.

4. TEST ENVIRONMENT

4.1. Address of the test laboratory

Laboratory: Shenzhen Huatongwei International Inspection Co., Ltd.

Address: 1/F, Bldg 3, Hongfa Hi-tech Industrial Park, Genyu Road, Tianliao, Gongming, Shenzhen, China

Phone: 86-755-26748019 Fax: 86-755-26748089

4.2. Test Facility

The test facility is recognized, certified, or accredited by the following organizations:

CNAS-Lab Code: L1225

Shenzhen Huatongwei International Inspection Co., Ltd. has been assessed and proved to be in compliance with CNAS-CL01 Accreditation Criteria for Testing and Calibration Laboratories (identical to ISO/IEC17025: 2005 General Requirements) for the Competence of Testing and Calibration Laboratories.

A2LA-Lab Cert. No. 3902.01

Shenzhen Huatongwei International Inspection Co., Ltd. EMC Laboratory has been accredited by A2LA for technical competence in the field of electrical testing, and proved to be in compliance with ISO/IEC 17025: 2005 General Requirements for the Competence of Testing and Calibration Laboratories and any additional program requirements in the identified field of testing.

FCC-Registration No.: 762235

Shenzhen Huatongwei International Inspection Co., Ltd. EMC Laboratory has been registered and fully described in a report filed with the FCC (Federal Communications Commission). The acceptance letter from the FCC is maintained in our files. Registration 762235.

IC-Registration No.: 5377B-1

Two 3m Alternate Test Site of Shenzhen Huatongwei International Inspection Co., Ltd. has been registered by Certification and Engineering Bureau of Industry Canada for the performance of radiated measurements with Registration No. 5377B-1.

ACA

Shenzhen Huatongwei International Inspection Co., Ltd. EMC Laboratory can also perform testing for the Australian C-Tick mark as a result of our A2LA accreditation.

4.3. Environmental conditions

During the measurement the environmental conditions were within the listed ranges:

Temperature:	15~35°C
Relative Humidity:	30~60 %
Air Pressure:	950~1050mba

4.4. Statement of the measurement uncertainty

The data and results referenced in this document are true and accurate. The reader is cautioned that there may be errors within the calibration limits of the equipment and facilities. The measurement uncertainty was calculated for all measurements listed in this test report acc. to TR-100028-01 "Electromagnetic compatibility and Radio spectrum Matters (ERM);Uncertainties in the measurement of mobile radio equipment characteristics;Part 1" and TR-100028-02 "Electromagnetic compatibilityand Radio spectrum Matters (ERM);Uncertainties in the measurementof mobile radio equipment characteristics;Part 2 " and is documented in the Shenzhen Huatongwei International Inspection Co., Ltd quality system acc. to DIN EN ISO/IEC 17025. Furthermore, component and process variability of devices similar to that tested may result in additional deviation. The manufacturer has the sole responsibility of continued compliance of the device.

Hereafter the best measurement capability for Shenzhen Huatongwei laboratory is reported:

Test Items	Measurement Uncertainty	Notes
Transmitter power conducted	0.63 dB	(1)
Transmitter power Radiated	2.38 dB	(1)
Conducted spurious emissions 9kHz~40GHz	0.63 dB	(1)
Conducted Disturbance 150kHz~30MHz	3.35 dB	(1)
Radiated Emissions below 1GHz	4.28 dB	(1)
Radiated Emissions above 1GHz	5.16 dB	(1)
Occupied Bandwidth	18 Hz	(1)

(1) This uncertainty represents an expanded uncertainty expressed at approximately the 95% confidence level using a coverage factor of k=1.96.

4.5. Equipments Used during the Test

RF Conducted Method						
Item	Test Equipment	Manufacturer	Model No.	Serial No.	Last Cal. (mm-dd-yy)	Next Cal. (mm-dd-yy)
1	Signal and spectrum analyzer	R&S	FSV40	100048	11/11/2018	11/10/2019

Radiated Emissions						
Item	Test Equipment	Manufacturer	Model No.	Serial No.	Last Cal. (mm-dd-yy)	Next Cal. (mm-dd-yy)
1	Semi-Anechoic Chamber	Albatross projects	SAC-3m-01	C11121	10/16/2016	10/15/2019
2	EMI Test Receiver	R&S	ESCI	100900	11/11/2018	11/10/2019
3	Loop Antenna	R&S	HFH2-Z2	100020	11/20/2017	11/19/2020
4	Ultra-Broadband Antenna	SCHWARZBECK	VULB9163	538	4/5/2017	4/4/2020
5	Horn Antenna	SCHWARZBECK	9120D	1011	3/27/2017	3/26/2020
6	Pre-amplifier	SCHWARZBECK	BBV 9743	9743-0022	10/18/2018	10/17/2019
7	Broadband Pre-amplifier	SCHWARZBECK	BBV 9718	9718-248	10/18/2018	10/17/2019
8	Spectrum Analyzer	R&S	FSP40	100597	11/11/2018	11/10/2019
9	RF Connection Cable	HUBER+SUHNE R	RE-7-FL	N/A	11/21/2017	11/20/2018
10	RF Connection Cable	HUBER+SUHNE R	RE-7-FH	N/A	11/21/2017	11/20/2018
11	Test Software	Audix	E3	N/A	N/A	N/A
12	Test Software	R&S	ES-K1	N/A	N/A	N/A
13	Turntable	Maturo Germany	TT2.0-1T	N/A	N/A	N/A
14	Antenna Mast	Maturo Germany	CAM-4.0-P-12	N/A	N/A	N/A

5. TEST CONDITIONS AND RESULTS

5.1. Antenna requirement

Requirement

FCC CFR Title 47 Part 15 Subpart C Section 15.203:

An intentional radiator shall be designed to ensure that no antenna other than that furnished by the responsible party shall be used with the device. The use of a permanently attached antenna or of an antenna that uses a unique coupling to the intentional radiator, the manufacturer may design the unit so that a broken antenna can be replaced by the user, but the use of a standard antenna jack or electrical connector is prohibited.

TEST RESULTS

Passed Not Applicable

The directional gain of the antenna less than 6 dBi, please refer to the below antenna photo.



5.2. Conducted Emission (AC Main)

LIMIT

FCC CFR Title 47 Part 15 Subpart C Section 15.207:

Frequency range (MHz)	Limit (dBuV)	
	Quasi-peak	Average
0.15-0.5	66 to 56*	56 to 46*
0.5-5	56	46
5-30	60	50

* Decreases with the logarithm of the frequency.

TEST CONFIGURATION

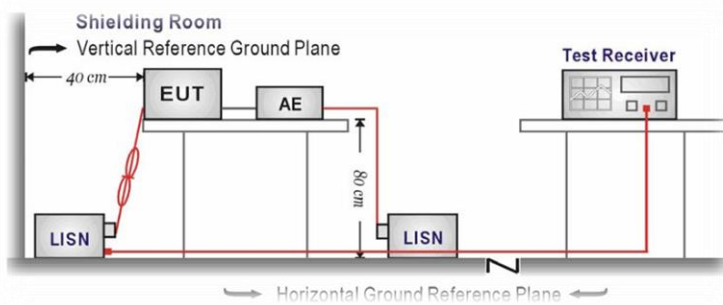

TEST PROCEDURE

1. The EUT was setup according to ANSI C63.10:2013 for compliance to FCC 47CFR 15.247 requirements.
2. The EUT was placed on a platform of nominal size, 1 m by 1.5 m, raised 80 cm above the conducting ground plane. The vertical conducting plane was located 40 cm to the rear of the EUT. All other surfaces of EUT were at least 80 cm from any other grounded conducting surface.
3. The EUT and simulators are connected to the main power through a line impedance stabilization network (LISN). The LISN provides a 50 ohm /50uH coupling impedance for the measuring equipment.
4. The peripheral devices are also connected to the main power through a LISN. (Please refer to the block diagram of the test setup and photographs)
5. Each current-carrying conductor of the EUT power cord, except the ground (safety) conductor, was individually connected through a LISN to the input power source.
6. The excess length of the power cord between the EUT and the LISN receptacle were folded back and forth at the center of the lead to form a bundle not exceeding 40 cm in length.
7. Conducted emissions were investigated over the frequency range from 0.15MHz to 30MHz using a receiver bandwidth of 9 kHz.
8. During the above scans, the emissions were maximized by cable manipulation.

TEST MODE:

Please refer to the clause 3.3

TEST RESULTS

Passed Not Applicable

Note:

- 1) Transd = Cable lose + Pulse Limiter Factor + Artificial Mains Factor
- 2) Margin = Limit - Level

Test Line:

L

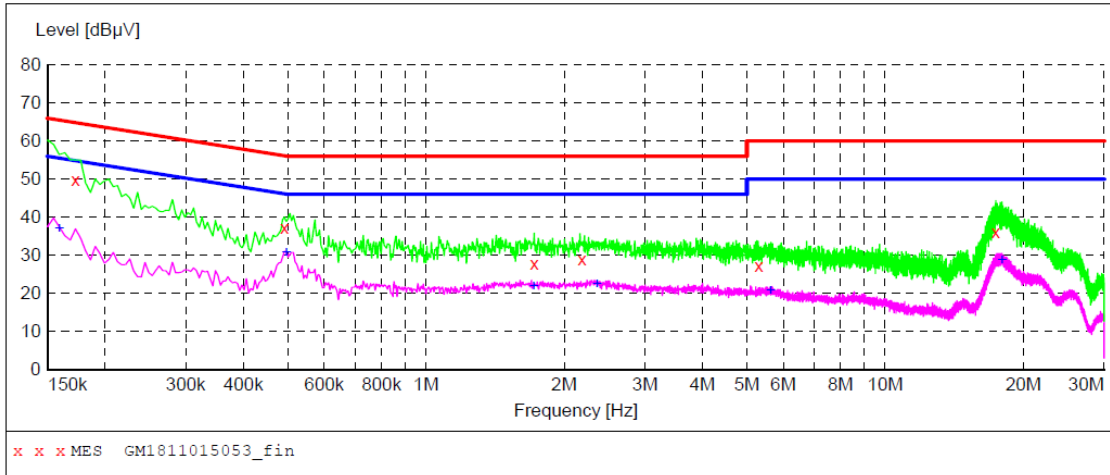

MEASUREMENT RESULT: "GM1811015053_fin"

11/1/2018 6:07PM

Frequency MHz	Level dBµV	Transd dB	Limit dBµV	Margin dB	Detector	Line	PE
0.172500	49.80	10.1	65	15.0	QP	L1	GND
0.492000	37.30	10.0	56	18.8	QP	L1	GND
1.720500	27.90	10.0	56	28.1	QP	L1	GND
2.184000	28.90	10.0	56	27.1	QP	L1	GND
5.307000	27.10	10.0	60	32.9	QP	L1	GND
17.380500	36.20	10.3	60	23.8	QP	L1	GND

MEASUREMENT RESULT: "GM1811015053_fin2"

11/1/2018 6:07PM

Frequency MHz	Level dBµV	Transd dB	Limit dBµV	Margin dB	Detector	Line	PE
0.159000	36.90	10.1	56	18.6	AV	L1	GND
0.496500	30.70	10.0	46	15.4	AV	L1	GND
1.716000	21.90	10.0	46	24.1	AV	L1	GND
2.355000	22.30	10.0	46	23.7	AV	L1	GND
5.631000	20.70	10.0	50	29.3	AV	L1	GND
17.956500	28.60	10.3	50	21.4	AV	L1	GND

Test Line:

N

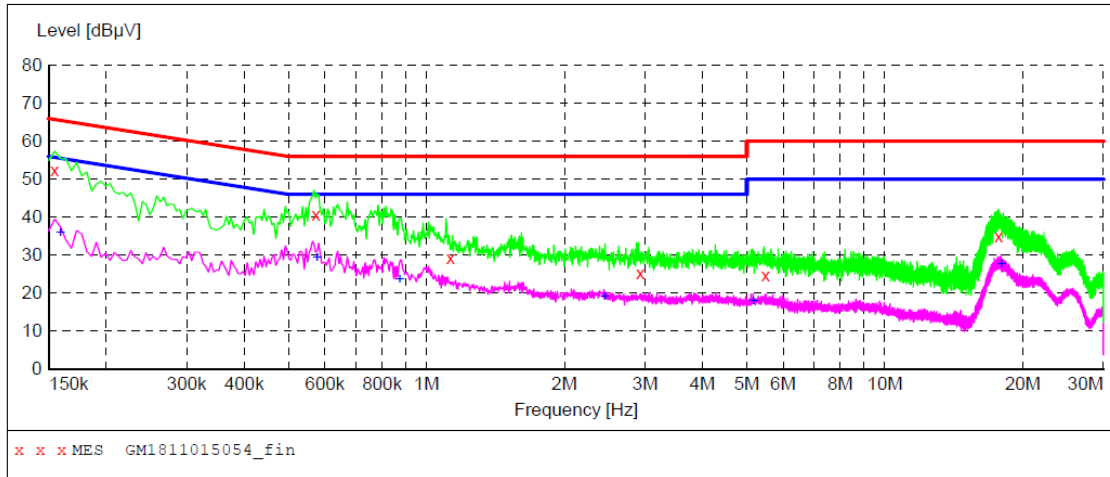

MEASUREMENT RESULT: "GM1811015054_fin"

11/1/2018 6:11PM

Frequency MHz	Level dBµV	Transd dB	Limit dBµV	Margin dB	Detector	Line	PE
0.154500	52.40	10.1	66	13.4	QP	N	GND
0.573000	40.60	10.0	56	15.4	QP	N	GND
1.126500	29.30	10.0	56	26.7	QP	N	GND
2.926500	25.10	10.0	56	30.9	QP	N	GND
5.487000	24.70	10.0	60	35.3	QP	N	GND
17.695500	34.80	10.3	60	25.2	QP	N	GND

MEASUREMENT RESULT: "GM1811015054_fin2"

11/1/2018 6:11PM

Frequency MHz	Level dBµV	Transd dB	Limit dBµV	Margin dB	Detector	Line	PE
0.159000	35.70	10.1	56	19.8	AV	N	GND
0.577500	29.10	10.0	46	16.9	AV	N	GND
0.874500	23.50	9.9	46	22.5	AV	N	GND
2.449500	18.90	10.0	46	27.1	AV	N	GND
5.172000	17.90	10.0	50	32.1	AV	N	GND
17.974500	27.50	10.3	50	22.5	AV	N	GND

5.3. Field Strength of the Fundamental

LIMIT

FCC CFR Title 47 Part 15 Subpart C Section 15.231(b).

The field strength of emissions from intentional radiators operated **average value** under this section shall not exceed the following

Fundamental frequency	Field strength of fundamental (millivolts/meter)	Unwanted emissions (millivolts/meter)
260 - 470 MHz	3,750 to 12,500 **	375 to 1,250 **

** linear interpolation with frequency, f, in MHz:

F is **433.92MHz**

Field strength of fundamental: Limit at 3 meters = $41.67 * F - 7083.34 = 80.83$ dBuV/m

Field strength of harmonics: Limit at 3 meters = $4.167 * F - 708.334 = 60.83$ dBuV/m

TEST CONFIGURATION

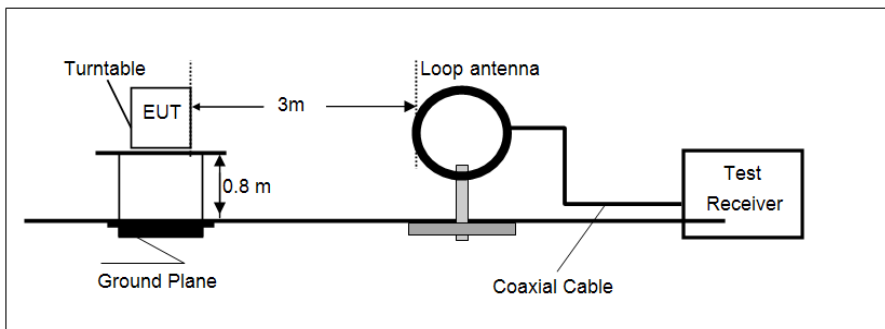

TEST PROCEDURE

1. The EUT was setup and tested according to ANSI C63.10:2013 requirements.
2. The EUT is placed on a turn table which is 0.8 meter above ground. The turn table is rotated 360 degrees to determine the position of the maximum emission level.
3. The EUT was positioned such that the distance from antenna to the EUT was 3 meters.
4. The antenna is scanned from 1 meter to 4 meters to find out the maximum emission level. This is repeated for both horizontal and vertical polarization of the antenna. In order to find the maximum emission, all of the interface cables were manipulated according to ANSI C63.10:2013 on radiated measurement.

TEST MODE:

Please refer to the clause 3.3

TEST RESULTS

Passed Not Applicable

Peak value:

Frequency(MHz)	Level(dBuV/m)	Limit(dBuV/m)	Polarization	Test Result
433.92	82.81	100.83	Horizontal	Pass
433.92	79.38	100.83	Vertical	Pass

Average value:

Frequency(MHz)	Peak Level (dBuV/m)	Dutycycle Factor	Average Level (dBuV/m)	Limit (dBuV/m)	Polarization	Test Result
433.92	82.81	-6.83	75.98	80.83	Horizontal	Pass
433.92	79.38	-6.83	72.55	80.83	Vertical	Pass

Average value:	
Calculate Formula:	Average value=Peak value + Duty Cycle Factor
	Duty cycle factor=20 log(Duty cycle)
	Duty cycle= T_{on} / T_{period}
Test data:	T_{on} time =243.48us
	T_{period} =534.78us
	Duty cycle=0.4553
	Duty cycle factor=-6.83

Test plot as follows:

T_{on} & T_{period} time:

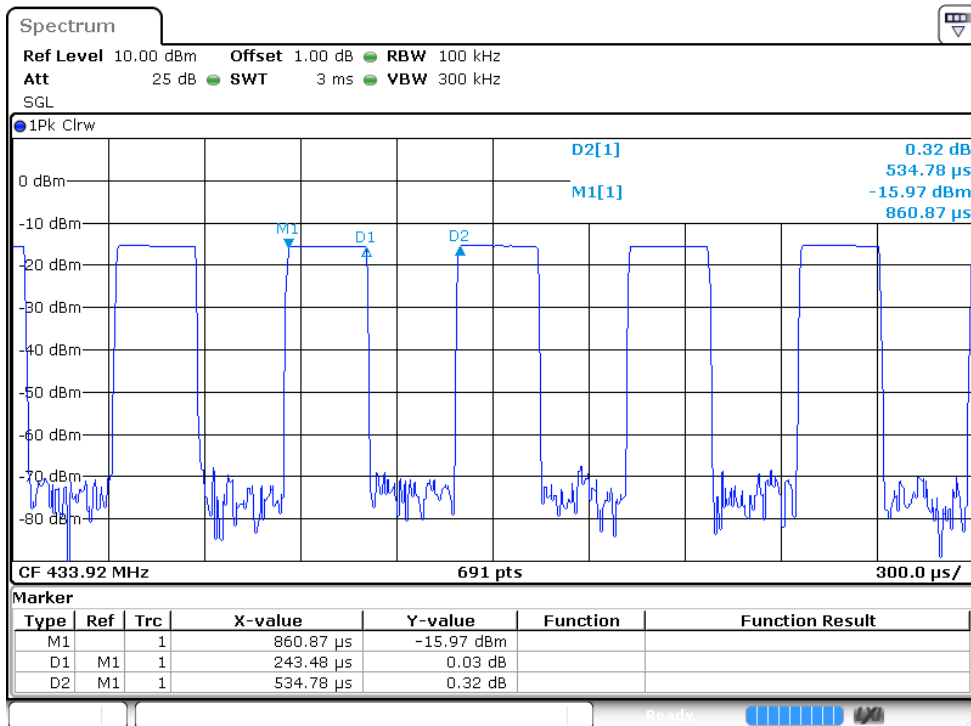

5.4. 20 dB Bandwidth

LIMIT

FCC CFR Title 47 Part 15 Subpart C Section 15.231(c).

The bandwidth of the emission shall be no wider than 0.25% of the center frequency for devices operating above 70 MHz and below 900 MHz. For devices operating above 900 MHz, the emission shall be no wider than 0.5% of the center frequency. Bandwidth is determined at the points 20 dB down from the modulated carrier.

$$433.92\text{MHz} \times 0.25\% = 1.085\text{MHz}$$

TEST CONFIGURATION

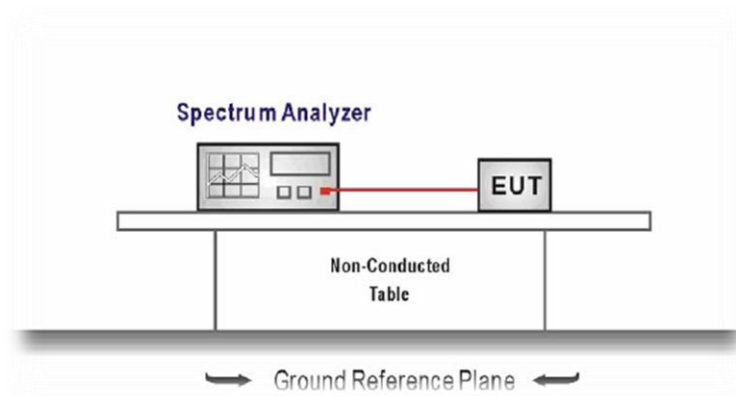

TEST PROCEDURE

1. The transmitter output was connected to the spectrum analyzer through an attenuator, the path loss was compensated to the results for each measurement.
2. Set to the maximum power setting and enable the EUT transmit continuously
3. Use the following spectrum analyzer settings:
Span = approximately 2 to 3 times the 20 dB bandwidth, centered on a operation channel
RBW \geq 1% of the 20 dB bandwidth, VBW \geq RBW
Sweep = auto, Detector function = peak, Trace = max hold
4. Measure and record the results in the test report.

TEST MODE:

Please refer to the clause 3.3

TEST RESULTS

Passed Not Applicable

Channel Frequency(MHz)	20dB Bandwidth(kHz)	Limit (MHz)	Result
433.92	58.44	1.085	PASS

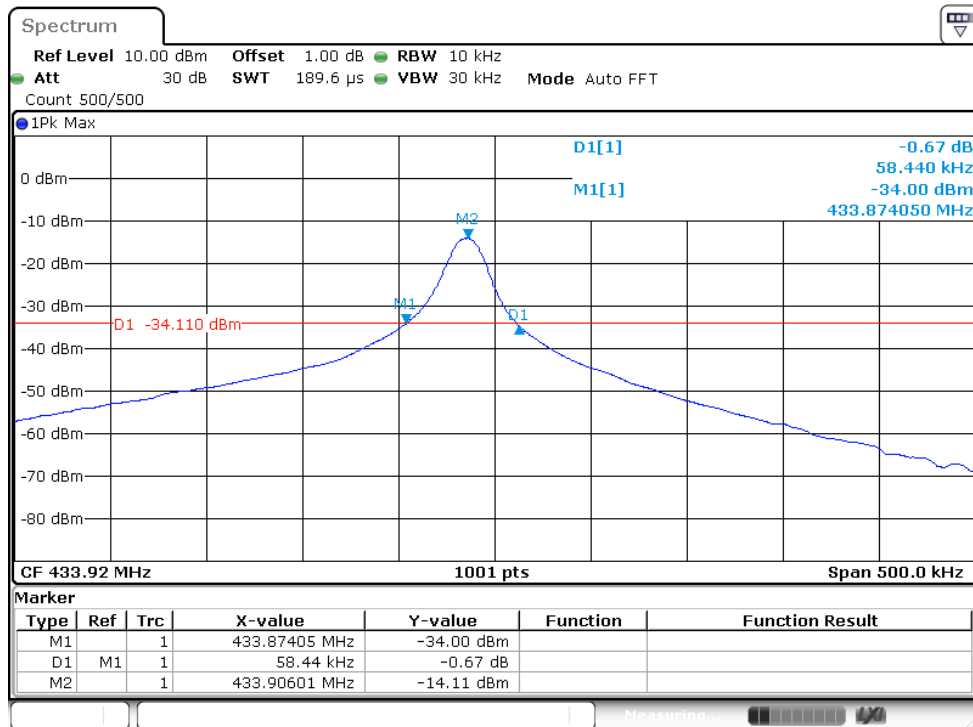

5.5. Continue Transmission Time

LIMIT

FCC CFR Title 47 Part 15 Subpart C Section 15.231(a).

A manually operated transmitter shall employ a switch that will auto-matically deactivate the transmitter within not more than 5 seconds of being released.

TEST CONFIGURATION

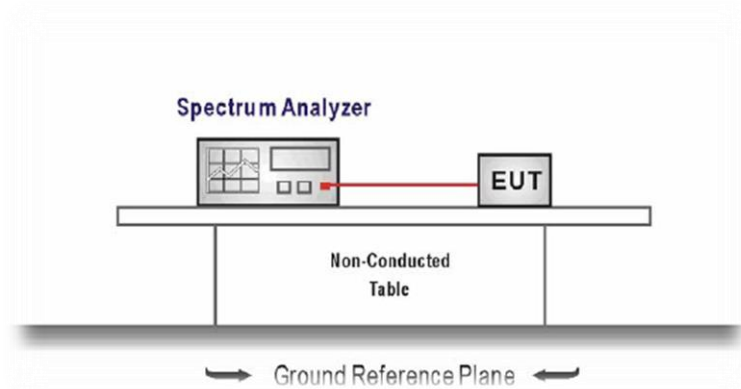

TEST PROCEDURE

1. The transmitter output was connected to the spectrum analyzer through an attenuator, the path loss was compensated to the results for each measurement.
2. Set to the maximum power setting and enable the EUT transmit continuously
3. Use the following spectrum analyzer settings:
 Frequency=Center carrier frequency
 RBW=100KHz, VBW=300KHz, Span= 0,
 Sweep time= 10second, Detector function = peak, Trace = single
4. Measure and record the results in the test report.

TEST RESULTS

Passed **Not Applicable**

Frequency (MHz)	Transmission time (s)	Limit (s)	Result
433.92	1.5797	<5.00	Pass

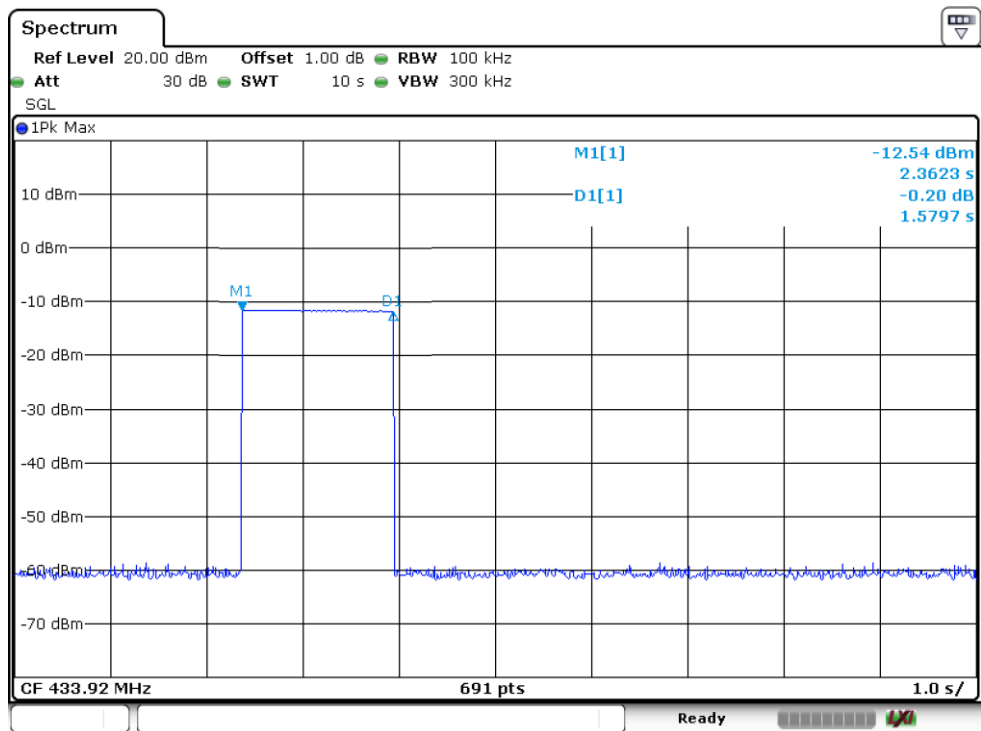

5.6. Radiated Emission

LIMIT

FCC CFR Title 47 Part 15 Subpart C Section 15.231(b) and 15.209.

Limit for frequency below 30MHz:

Frequency	Limit (uV/m)	Measurement Distance(m)	Remark
0.009~0.490	2400/F(kHz)	300	Quasi-peak
0.490~1.705	24000/F(kHz)	30	Quasi-peak
1.705~30.0	30	30	Quasi-peak

Note: Limit dBuV/m @3m = Limit dBuV/m @300m + 40*log(300/3)= Limit dBuV/m @300m +80,

Limit dBuV/m @3m = Limit dBuV/m @30m +40*log(30/3)= Limit dBuV/m @30m + 40.

Limit for frequency above 30MHz:

Frequency	Limit (dBuV/m@3m)	Remark
30MHz~88MHz	40.00	Quasi-peak
88MHz~216MHz	43.50	Quasi-peak
216MHz~960MHz	46.00	Quasi-peak
960MHz-1GHz	54.00	Quasi-peak
Above 1GHz	54.00	Average
	74.00	Peak

Unwanted emissions of the harmonic level:

Fundamental frequency	Field strength of fundamental (millivolts/meter)	Unwanted emissions (millivolts/meter)
260 - 470 MHz	3,750 to 12,500 **	375 to 1,250 **

** linear interpolation with frequency, f, in MHz:

F is 433.92MHz

Field strength of harmonics: Limit at 3 meters = 4.167*F – 708.334=60.83dBuV/m

TEST CONFIGURATION

1) 9KHz ~30MHz

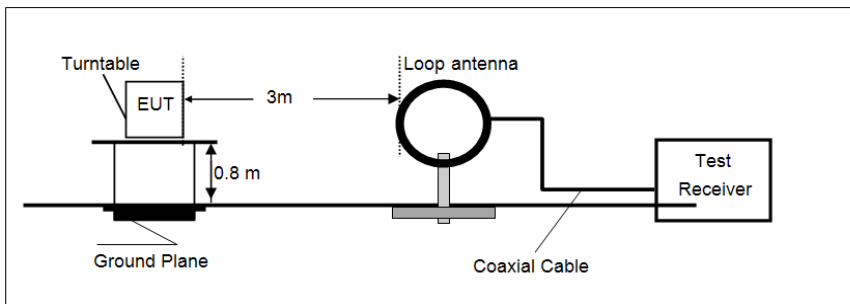

2) 30MHz ~ 1GHz

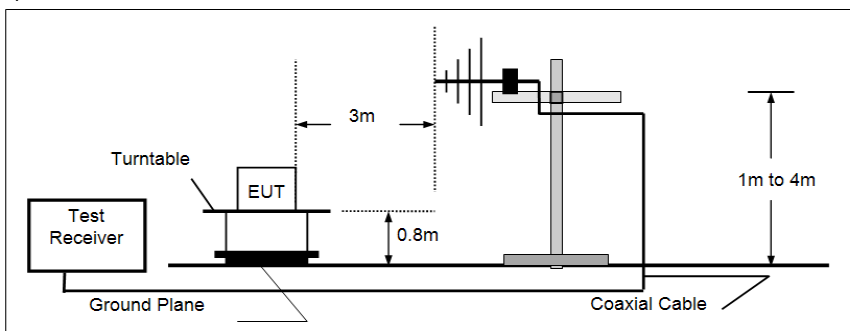

3) Above 1GHz

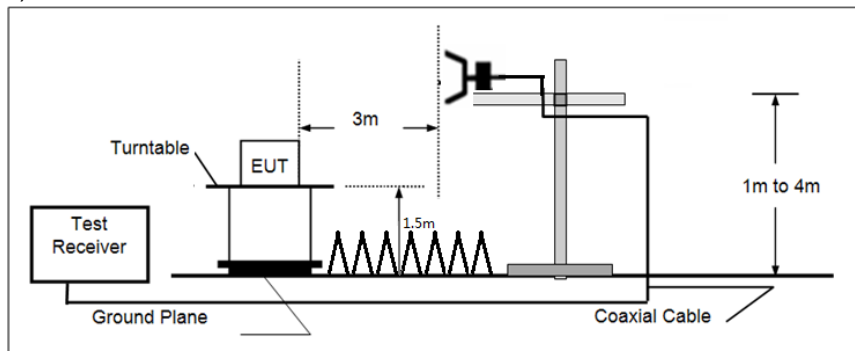
**TEST PROCEDURE**

1. The EUT was tested according to ANSI C63.10:2013 requirements.
2. The EUT is placed on a turn table which is 0.8/1.5 meter above ground. The turn table is rotated 360 degrees to determine the position of the maximum emission level.
3. The EUT was positioned such that the distance from antenna to the EUT was 3 meters.
4. The antenna is scanned from 1 meter to 4 meters to find out the maximum emission level. This is repeated for both horizontal and vertical polarization of the antenna.

TEST RESULTS

Passed **Not Applicable**

Below 30MHz:

The EUT was pre-scanned the frequency band (9KHz~30MHz), found the radiated level lower than the limit, so don't show on the report.

Above 30MHz:**Peak value:**

Frequency (MHz)	Level (dBuV/m)	Limit (dBuV/m)	Over Limit (dBuV/m)	Polarization	Test Result
867.84	58.80	80.83	-22.03	Vertical	Pass
1301.76	47.50	74.00	-26.50	Vertical	Pass
1735.68	47.10	74.00	-26.90	Vertical	Pass
2169.60	41.10	74.00	-32.90	Vertical	Pass
2603.52	46.50	74.00	-27.50	Vertical	Pass
3037.44	46.00	74.00	-28.00	Vertical	Pass
867.84	56.90	80.83	-23.93	Horizontal	Pass
1301.76	43.70	74.00	-30.30	Horizontal	Pass
1735.68	42.40	74.00	-31.60	Horizontal	Pass
2169.60	40.80	74.00	-33.20	Horizontal	Pass
2603.52	48.00	74.00	-26.00	Horizontal	Pass
3037.44	45.50	74.00	-28.50	Horizontal	Pass

Average value:

Frequency (MHz)	Peak Value (dBuV/m)	Dutycycle Factor	Average Value(dBuV/m)	Limit (dBuV/m)	Over Limit (dBuV/m)	Polarization	Test Result
867.84	58.80	-6.83	51.97	60.83	-8.86	Vertical	Pass
1301.76	47.50	-6.83	40.67	54.00	-13.33	Vertical	Pass
1735.68	47.10	-6.83	40.27	54.00	-13.73	Vertical	Pass
2169.60	41.10	-6.83	34.27	54.00	-19.73	Vertical	Pass
2603.52	46.50	-6.83	39.67	54.00	-14.33	Vertical	Pass
3037.44	46.00	-6.83	39.17	54.00	-14.83	Vertical	Pass
867.84	56.90	-6.83	50.07	60.83	-10.76	Horizontal	Pass
1301.76	43.70	-6.83	36.87	54.00	-17.13	Horizontal	Pass
1735.68	42.40	-6.83	35.57	54.00	-18.43	Horizontal	Pass
2169.60	40.80	-6.83	33.97	54.00	-20.03	Horizontal	Pass
2603.52	48.00	-6.83	41.17	54.00	-12.83	Horizontal	Pass
3037.44	45.50	-6.83	38.67	54.00	-15.33	Horizontal	Pass

6. Test Setup Photos of the EUT

Conducted Emission:



Radiated Emission

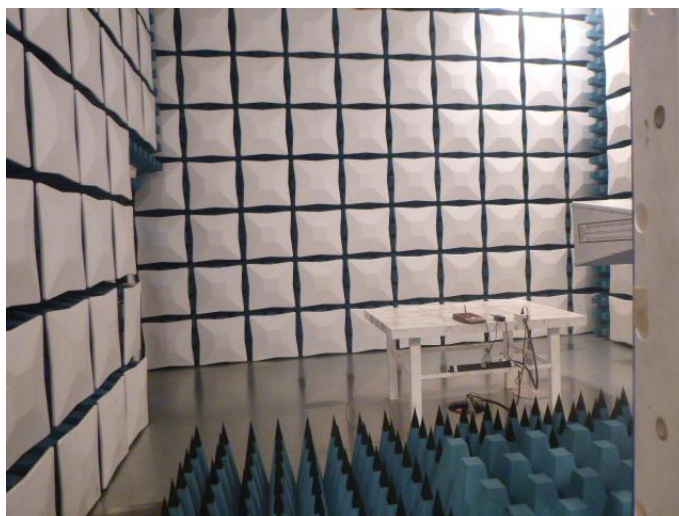

7. External and Internal Photos of the EUT

External photo

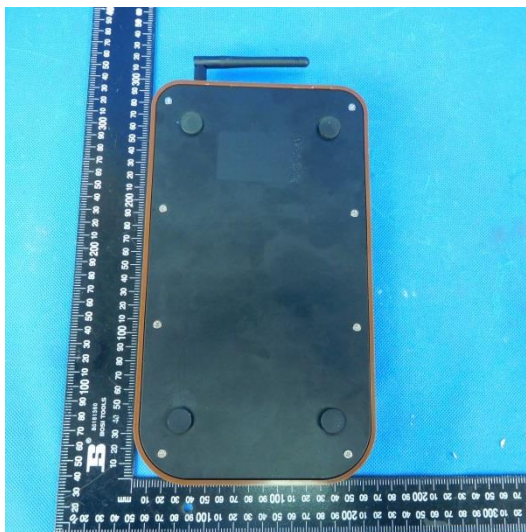

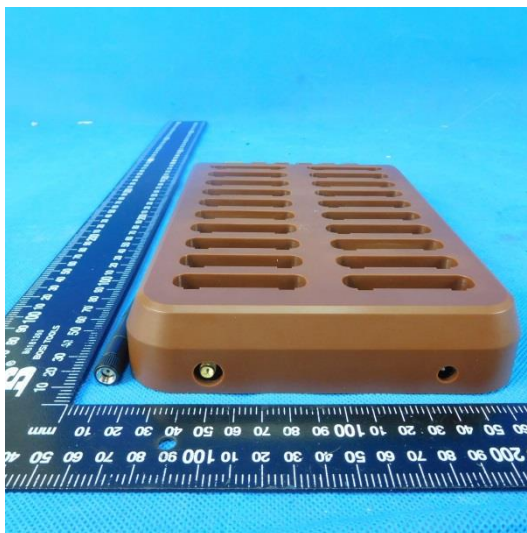



Internal photo

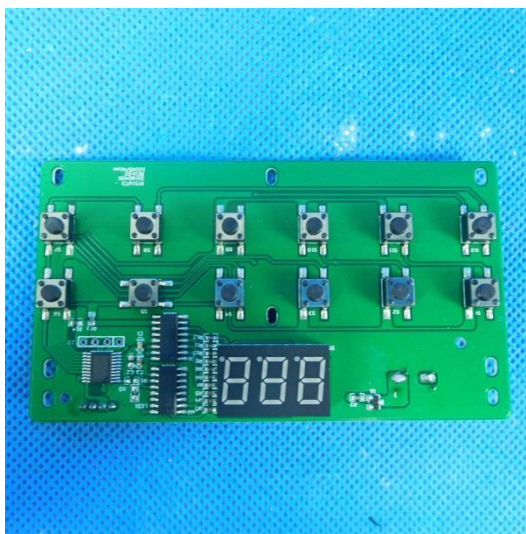
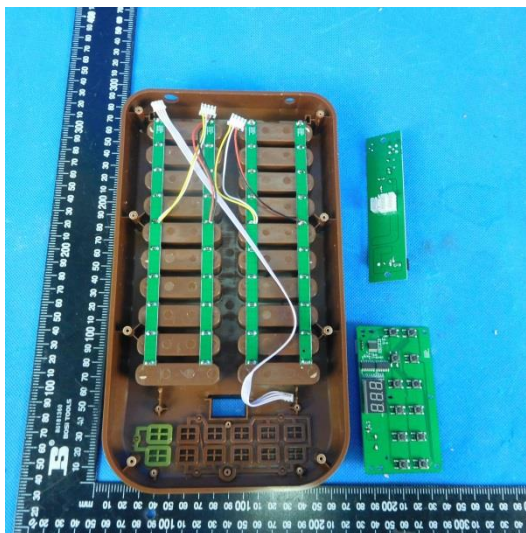
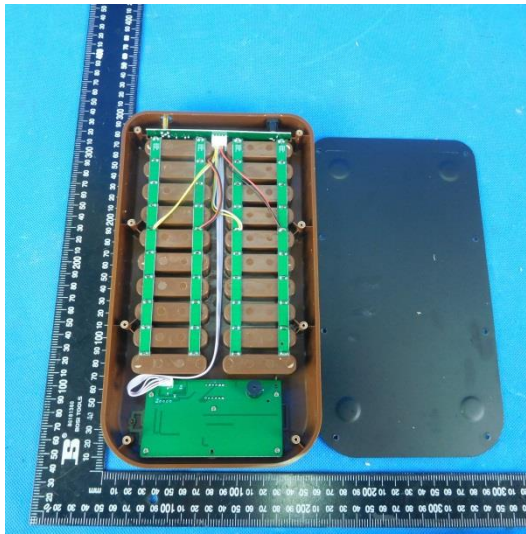

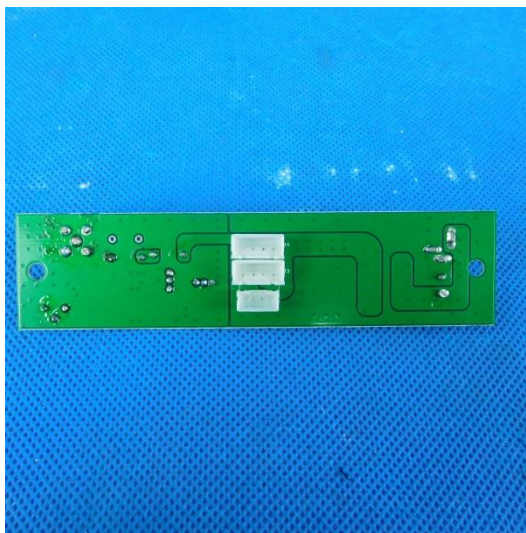
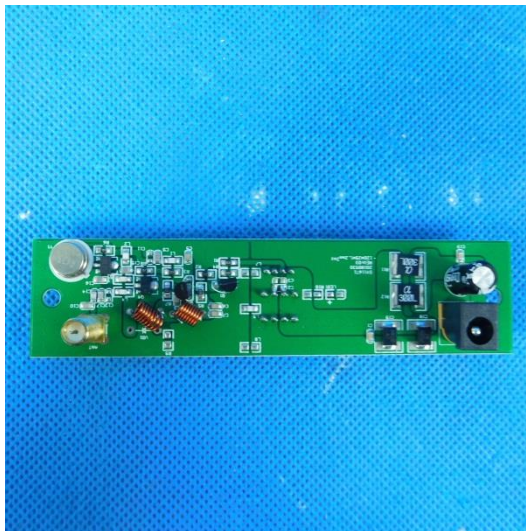
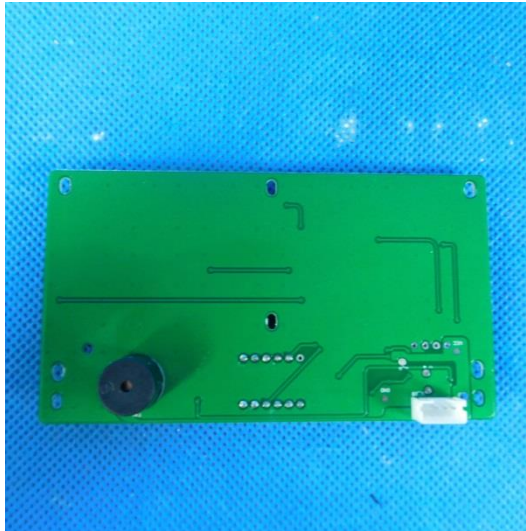

.....End of Report.....