

FCC Test Report

Part 15 subpart C

Client Information:

Applicant : China Electronics Shenzhen Company
Applicant add. : 33/F, BLOCK A, ELECTRONICS SCIENCE & TECHNOLOGY
BUILDING, 2070 SHENNAN ZHONGLU SHENZHEN, P.R. CHINA

EUT Information:

EUT Name : BLUETOOTH SPEAKER
Model No. : X403, IJOY-BEACH-B, IJOY-BEACH-B-FLM, IJOY-BEACH-B-IND,
IJOY-BEACH-B-LEM, IJOY-BEACH-B-MAR, IJOY-BEACH-B-MNT,
IJOY-BEACH-B-VLT
Brand Name : N/A
FCC ID : 2AAQFX403

Prepared By:

Shenzhen ECT Testing Technology Co., Ltd.
Add. : Room 1106, Era Innovation Center, Xixiang gushu second road,
Baoan district, Shenzhen city, China

Date of Receipt: Dec. 13, 2016 Date of Test: Dec. 13~20, 2016
Date of Issue: Dec. 21, 2016 Test Result: **Pass**

Test procedure used: ANSI C63.10-2013

This device described above has been tested by Shenzhen ECT Testing Technology Co., Ltd., and the test results show that the equipment under test (EUT) is in compliance with the FCC requirements. And it is applicable only to the tested sample identified in the report.

*This test report must not be used by the client to claim product endorsement by any agency of the U.S. government.

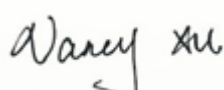
Reviewed by: 
Nancy Xu

Approved by: 
kelly Jiang

1 Contents

	Page
COVER PAGE	
1 CONTENTS	2
2 TEST SUMMARY	4
2.1 COMPLIANCE WITH FCC PART 15 SUBPART C	4
2.2 MEASUREMENT UNCERTAINTY	4
3 GENERAL INFORMATION	5
3.1 GENERAL DESCRIPTION OF EUT	5
3.2 TEST LOCATION	6
3.3 DESCRIPTION OF TEST CONDITIONS	7
3.4 EUT PERIPHERAL LIST	8
3.5 TEST PERIPHERAL LIST	8
4 EQUIPMENTS LIST FOR ALL TEST ITEMS	9
5 TEST RESULT	10
5.1 ANTENNA REQUIREMENT	10
5.1.1 Standard requirement	10
5.1.2 EUT Antenna	10
5.2 CONDUCTION EMISSIONS MEASUREMENT	11
5.2.1 Applied procedures / Limit	11
5.2.2 Test procedure	11
5.2.3 Test setup	11
5.2.4 Test results	12
5.3 RADIATED EMISSIONS MEASUREMENT	14
5.3.1 Applied procedures / Limit	14
5.3.2 Test setup	15
5.3.3 Test procedure	17
5.3.4 Test Result	18
5.3.5 TEST RESULTS (Restricted Bands Requirements).....	26
5.4 BANDWIDTH TEST	28
5.4.1 Applied procedures / Limit	28
5.4.2 Test procedure	28
5.4.3 Deviation from standard	28
5.4.4 Test setup	28
5.4.5 Test results	29
5.5 CARRIER FREQUENCIES SEPARATED	35
5.5.1 Applied procedures / Limit	35
5.5.2 Test procedure	35
5.5.3 Deviation from standard	35

5.5.4	Test setup	35
5.5.5	Test results	36
5.6	HOPPING CHANNEL NUMBER.....	40
5.6.1	Applied procedures / Limit	40
5.6.2	Test procedure.....	40
5.6.3	Deviation from standard.....	40
5.6.4	Test setup	40
5.6.5	Test result	40
5.7	DWELL TIME.....	42
5.7.1	Applied procedures / Limit	42
5.7.2	Test procedure.....	42
5.7.3	Deviation from standard.....	42
5.7.4	TEST SETUP.....	42
5.7.5	Test result	43
5.8	MAXIMUM PEAK OUTPUT POWER.....	47
5.8.1	Applied procedures / Limit	47
5.8.2	Test procedure.....	47
5.8.3	Deviation from standard.....	47
5.8.4	Test setup	47
5.8.5	Test results	48
5.9	BAND EDGE	49
5.9.1	Applied procedures / Limit	49
5.9.2	Test procedure.....	49
5.9.3	Deviation from standard.....	49
5.9.4	Test setup	49
5.9.5	Test results	50
	Conducted Band edge	50
5.10	CONDUCTED SPURIOUS EMISSIONS	57
5.10.1	Applied procedures / Limit	57
5.10.2	Test procedure.....	57
5.10.3	Deviation from standard.....	57
5.10.4	Test setup	57
5.10.5	Test results	58
6	PHOTOGRAPHS.....	70
6.1	CONDUCTED EMISSIONS TEST SETUP	70
6.2	RADIATED SPURIOUS EMISSIONS TEST SETUP(BELOW 1GHZ)	70
6.3	RADIATED SPURIOUS EMISSIONS TEST SETUP(ABOVE 1GHZ).....	71
6.4	EUT CONSTRUCTIONAL DETAILS	72

2 Test Summary

2.1 Compliance with FCC Part 15 subpart C

Test	Test Requirement	Standard Paragraph	Result
Antenna Requirement	FCC Part 15 C:2016	Section 15.247(c)	PASS
Conduction Emissions	FCC Part 15 C:2016	Section 15.207(a)	PASS
Radiated Emissions	FCC Part 15 C:2016	Section 15.247(d)	PASS
Carrier Frequencies Separated	FCC Part 15 C:2016	Section 15.247(a)(1)	PASS
Hopping Channel Number	FCC Part 15 C:2016	Section 15.247(a)(1) (iii)	PASS
Dwell Time	FCC Part 15 C:2016	Section 15.247(a)(1) (iii)	PASS
Maximum Peak Output Power	FCC Part 15 C:2016	Section 15.247(b)	PASS
Band edge	FCC Part 15 C:2016	Section 15.247(d)	PASS
Conducted Spurious Emissions	FCC Part 15 C:2016	Section 15.247(d)	PASS

According to the declaration from the applicant, the electrical circuit design, layout, components used and internal wiring were identical for all models, with only difference being the model name & exterior color.

Therefore only one model X403 was tested in this report.

2.2 Measurement Uncertainty

All measurements involve certain levels of uncertainties, The following measurements uncertainty Levels have estimated based on ANSI C63.10:2013, the maximum value of the uncertainty as below

No.	Item	Uncertainty
1	Conducted Emission Test	±1.38dB
2	Radiated Emission Test	±3.57dB

3 General Information

3.1 General Description of EUT

Manufacturer:	Shenzhen Best Shine Technology Co., Ltd.	
Address:	4th Floor, D Bldg., Hongwanbang Bldg., Tongfucun Park, Dalang, Longhua, Shenzhen, China	
BUYER:	QUEST USA CORP.	
EUT Name:	BLUETOOTH SPEAKER	
Model No:	X403	
Derivative model No.:	IJOY-BEACH-B, IJOY-BEACH-B-FLM, IJOY-BEACH-B-IND, IJOY-BEACH-B-LEM, IJOY-BEACH-B-MAR, IJOY-BEACH-B-MNT, IJOY-BEACH-B-VLT	
Operation frequency:	2402MHz to 2480MHz	
Channel Number:	79	
Modulation Technology:	GFSK, ($\pi/4$)DQPSK, 8DPSK	
Bluetooth version:	Bluetooth 2.1+ EDR	
H/W No.:	V3.0	
S/W No.:	V1.0	
Antenna Type:	PCB antenna	
Antenna Gain:	Maximum 0 dBi	
Brand Name:	N/A	
Power Supply Range:	DC 5V from adapter, AC 120V/60Hz for adapter or DC3.7V from battery.	
Power Supply:	DC 5V from adapter, AC 120V/60Hz for adapter or DC3.7V from battery.	
Power Cord:	N/A	
Signal Cord:	N/A	
Effective Isotropic Radiated Power(max):	1Mbps: 1.44dBm	Peak detector
	3Mbps: 0.31dBm	

Note:

1. For a more detailed features description, please refer to the manufacturer's specifications or the User's Manual.

2.

Channel List					
Channel	Frequency (MHz)	Channel	Frequency (MHz)	Channel	Frequency (MHz)
00	2402	27	2429	54	2456
01	2403	28	2430	55	2457
02	2404	29	2431	56	2458
03	2405	30	2432	57	2459
04	2406	31	2433	58	2460
05	2407	32	2434	59	2461
06	2408	33	2435	60	2462
07	2409	34	2436	61	2463
08	2410	35	2437	62	2464
09	2411	36	2438	63	2465
10	2412	37	2439	64	2466
11	2413	38	2440	65	2467
12	2414	39	2441	66	2468
13	2415	40	2442	67	2469
14	2416	41	2443	68	2470
15	2417	42	2444	69	2471
16	2418	43	2445	70	2472
17	2419	44	2446	71	2473
18	2420	45	2447	72	2474
19	2421	46	2448	73	2475
20	2422	47	2449	74	2476
21	2423	48	2450	75	2477
22	2424	49	2451	76	2478
23	2425	50	2452	77	2479
24	2426	51	2453	78	2480
25	2427	52	2454		
26	2428	53	2455		

3.2 Test Location

All tests were performed at:

Dongguan Yaxu (AiT) Technology Limited

No.22, Jinqianling Third Street, Jitigang, Huangjiang, Dongguan, Guangdong, China

Tel.: +86.769.82020499 Fax.: +86.769.82020495

The FCC Registration No. of Dongguan Yaxu (AiT) Technology Limited is 248337.

3.3 Description of Test conditions

(1) EUT was tested in normal configuration (Please See following Block diagram)

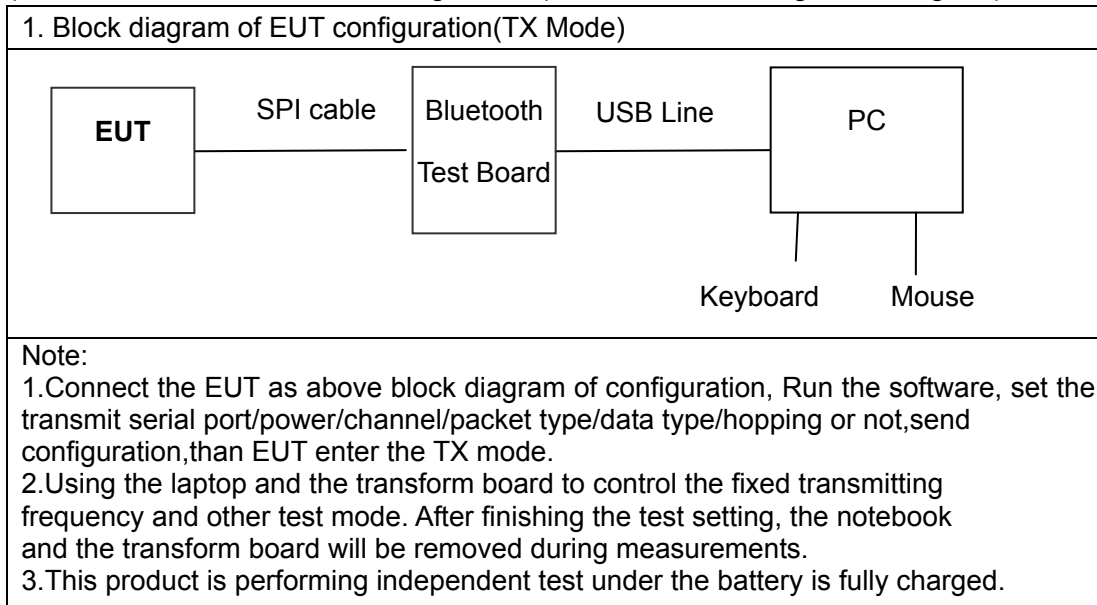

(2) E.U.T. test conditions:

15.31(e): For intentional radiators, measurements of the variation of the input power or the adiated signal level of the fundamental frequency component of the emission, as appropriate, shall be performed with the supply voltage varied between 85% and 115% of the nominal rated supply voltage. For battery operated equipment, the equipment tests shall be performed using a new battery.

(3) Test frequencies:

According to the 15.31(m) Measurements on intentional radiators or receivers, other than TV broadcast receivers, shall be performed and. If required reported for each band in which the device can be operated with the device operating at the number of frequencies in each band specified in the following table:

Frequency range over which device operates	Number of frequencies	Location in the range of operation
1 MHz or less	1	Middle
1 to 10 MHz	2	1 near top and 1 near bottom
More than 10 MHz	3	1 near top, 1 near middle and 1 near bottom

(4) Frequency range of radiated measurements:

According to the 15.33, The test range will be up to the tenth harmonic of the highest fundamental frequency .

(5) Pre-test the EUT in all transmitting mode at the lowest (2402 MHz), middle (2441 MHz) and highest (2480 MHz) channel with different data packet and conducted to determine the worst-case mode, only the worst-case results(1Mbps/3Mbps) are recorded in this report.

(6) The radiation measurements are performed in X, Y, Z axis positioning. And found the X axis positioning which it is worse case, only the test worst case mode is recorded in the report.

3.4 EUT Peripheral List

No.	Equipment	Manufacturer	EMC Compliance	Model No.	Serial No.	Power cord	signal cable
1	USB Cable	N/A	N/A	N/A	N/A	0.5m x 2 wires unscreened	N/A
2	AUX Cable	N/A	N/A	N/A	N/A	0.5 x 2 wires unscreened	N/A

3.5 Test Peripheral List

No.	Equipment	Manufacturer	EMC Compliance	Model No.	Serial No.	Power cord	signal cable
1	Lap top	ASUS	N/A	X401A	X16-9 6072	N/A	N/A
2	Adapter (laptop)	ASUS	N/A	EXA0703YH	N/A	1.8m/unshielded /detachable	N/A
3	Bluetooth Test Board	N/A	N/A	N/A	N/A	N/A	N/A
4	Adapter	N/A	N/A	SCO602BTA	N/A	0.8m x 2 wires unscreened	N/A

4 Equipments List for All Test Items

No	Test Equipment	Manufacturer	Model No	Serial No	Cal. Date	Cal. Due Date
1	Spectrum Analyzer	ADVANTEST	R3182	150900201	2016.06.29	2017.06.28
2	EMI Measuring Receiver	Schaffner	SCR3501	235	2016.06.29	2017.06.28
3	Low Noise Pre Amplifier	Tsj	MLA-10K01-B01-27	1205323	2016.06.29	2017.06.28
4	Low Noise Pre Amplifier	Tsj	MLA-0120-A02-34	2648A04738	2016.06.29	2017.06.28
5	TRILOG Super Broadband test Antenna	SCHWARZBECK	VULB9160	9160-3206	2016.06.29	2017.06.28
6	Broadband Horn Antenna	SCHWARZBECK	BBHA9120D	452	2016.06.29	2017.06.28
7	SHF-EHF Horn Antenna	SCHWARZBECK	BBHA9170	BBHA9170367	2016.06.29	2017.06.28
8	50Ω Coaxial Switch	Anritsu	MP59B	6200264416	2016.06.29	2017.06.28
9	EMI Test Receiver	R&S	ESCI	100124	2016.06.29	2017.06.28
10	LISN	Kyoritsu	KNW-242	8-837-4	2016.06.29	2017.06.28
11	LISN	Kyoritsu	KNW-407	8-1789-3	2016.06.29	2017.06.28
12	50Ω Coaxial Switch	Anritsu	MP59B	6200264417	2016.06.29	2017.06.28
13	Loop Antenna	ARA	PLA-1030/B	1029	2016.06.29	2017.06.28
14	Power Meter	R&S	NRVS	101336	2016.06.29	2017.06.28
15	EMI Test Receiver	Rohde & Schwarz	ESIB26	100394	2016.06.29	2017.06.28
16	Radiated Cable 1# (30MHz-1GHz)	FUJIKURA	5D-2W	01	2016.06.29	2017.06.28
17	Radiated Cable 2# (1GHz -25GHz)	FUJIKURA	10D2W	02	2016.06.29	2017.06.28
18	Conducted Cable 1#(9KHz-30MHz)	FUJIKURA	1D-2W	01	2016.06.29	2017.06.28
19	SMA Antenna connector (Impedance:50OHM, cable loss:0.5dBm)	Dosin	Dosin-SMA	N/A	N/A	N/A
20	Power sensor	Anritsu	MA2411B	1126168	2016.06.29	2017.06.28

Note: The temporary antenna connector is soldered on the PCB board in order to perform conducted tests and this temporary antenna connector is listed in the equipment list.

5 Test Result

5.1 Antenna Requirement

5.1.1 Standard requirement

15.203 requirement: For intentional device, according to 15.203: an intentional radiator shall be designed to ensure that no antenna other than that furnished by the responsible party shall be used with the device.

15.247(c) (1)(i) requirement: (i) Systems operating in the 2400-2483.5 MHz band that is used exclusively for fixed. Point-to-point operations may employ transmitting antennas with directional gain greater than 6dBi provided the maximum conducted output power of the intentional radiator is reduced by 1 dB for every 3 dB that the directional gain of the antenna exceeds 6dBi.

5.1.2 EUT Antenna

The antenna is integrated on the main PCB and no consideration of replacement. Antenna gain is maximum 0 dBi from 2.4GHz to 2.5GHz.

5.2 Conduction Emissions Measurement

5.2.1 Applied procedures / Limit

Frequency of Emission (MHz)	Conducted Limit (dB μ V)	
	Quasi-peak	Average
0.15-0.5	66 to 56 *	56 to 46 *
0.5-5	56	46
5-30	60	50

Note: Decreases with the logarithm of the frequency.

5.2.2 Test procedure

EUT was placed upon a wooden test table 0.8m above the horizontal metal reference plane and 0.4m from the vertical ground plane, and it was connected to an AMN. The closest distance between the boundary of the EUT and the surface of the AMN is 0.8m. All peripherals were connected to another AMN, and placed at a distance of 10cm from each other. A spectrum and receiver was connected to the RF output port of the AMN. Both average and quasi-peak value were detected.

5.2.3 Test setup

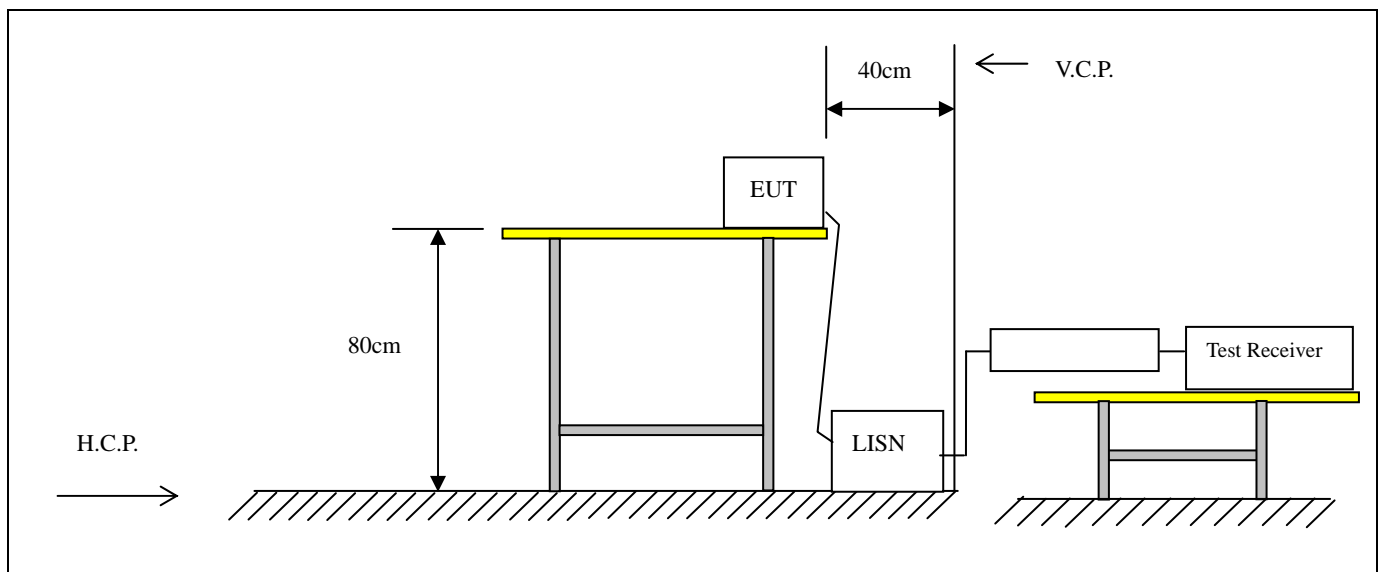

5.2.4 Test results

EUT:	BLUETOOTH SPEAKER	Model Name. :	X403
Temperature:	26 °C	Relative Humidity:	54%
Pressure:	1010hPa	Test Date :	2016-12-16
Test Mode:	TX (1Mbps) CH00 (worst case)	Phase :	Line
Test Voltage :	DC 5V from adapter, AC 120V/60Hz for adapter		

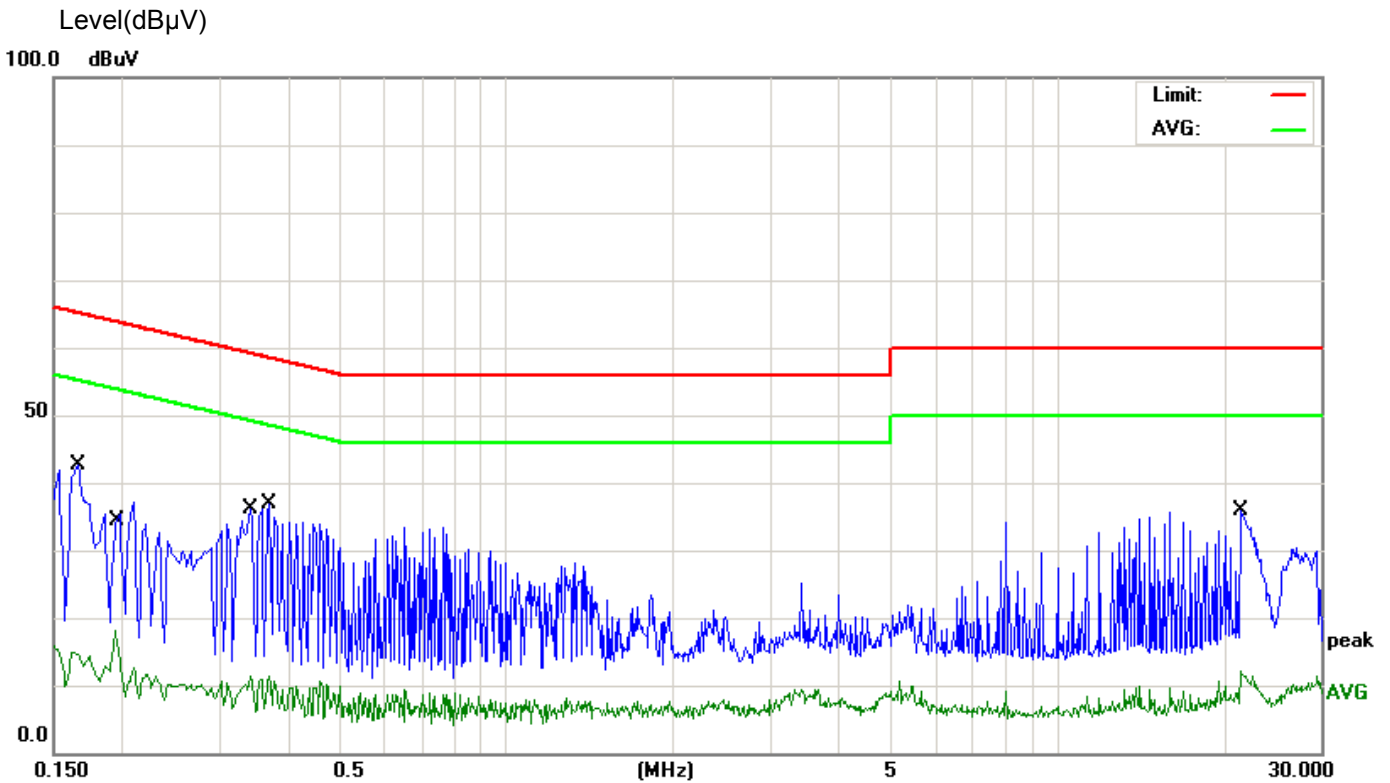

Measure data:

No.	Mk.	Freq. MHz	Reading Level dBμV	Correct Factor dB	Measure- ment dBμV	Limit dBμV	Over dB	Detector
1		0.1660	30.94	11.61	42.55	65.15	-22.60	QP
2		0.1940	6.86	11.21	18.07	53.86	-35.79	AVG
3		0.3420	1.15	10.17	11.32	49.15	-37.83	AVG
4	*	0.3700	26.71	10.16	36.87	58.50	-21.63	QP
5		21.4619	33.84	2.06	35.90	60.00	-24.10	QP
6		21.5500	9.96	2.06	12.02	50.00	-37.98	AVG

EUT:	BLUETOOTH SPEAKER	Model Name. :	X403
Temperature:	26 °C	Relative Humidity:	54%
Pressure:	1010hPa	Test Date :	2016-12-16
Test Mode:	TX (1Mbps) CH00 (worst case)	Phase :	Neutral
Test Voltage :	DC 13.5V from adapter,AC 120V/60Hz for adapter		

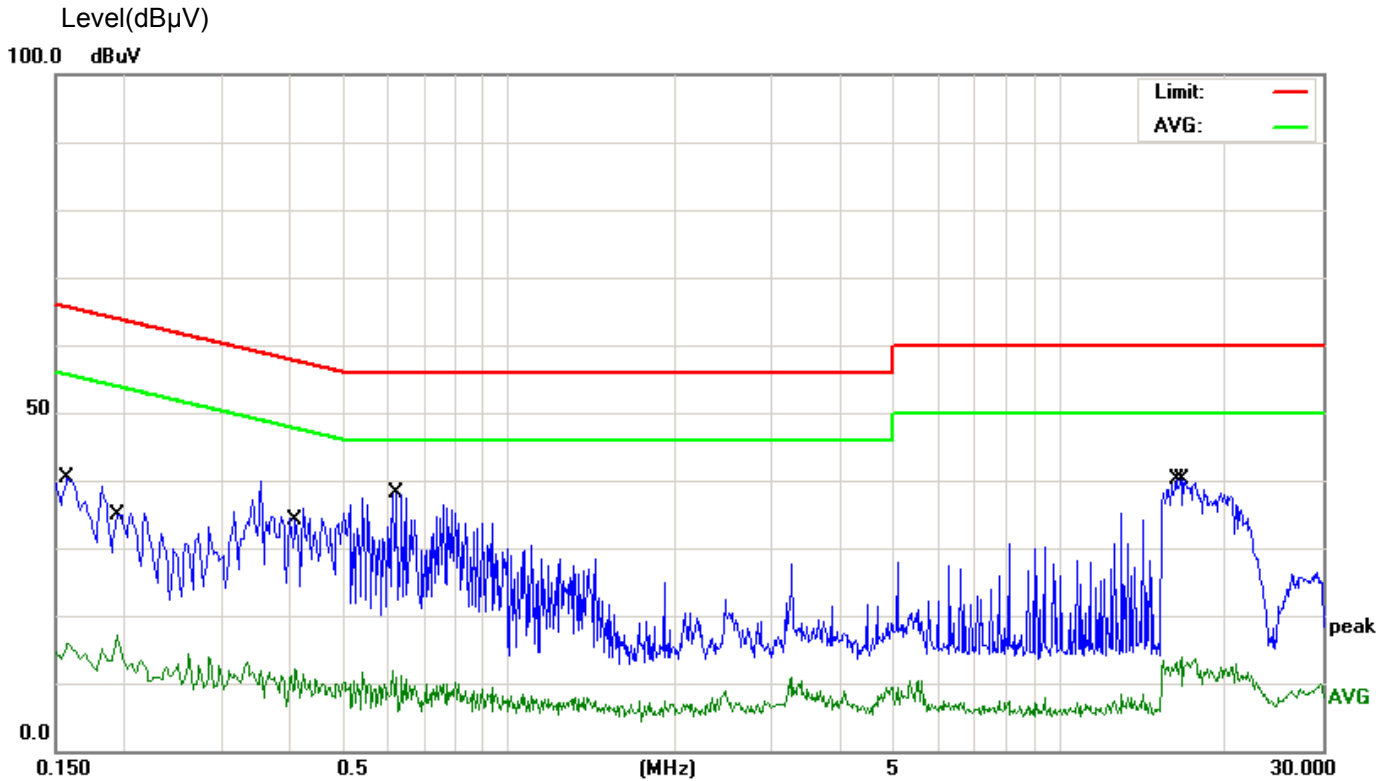

Measure result:

No.	Mk.	Freq. MHz	Reading Level dBμV	Correct Factor dB	Measure- ment dBμV	Limit dBμV	Over dB	Detector
1		0.1580	28.61	11.75	40.36	65.56	-25.20	QP
2		0.1940	5.85	11.21	17.06	53.86	-36.80	AVG
3		0.4100	1.95	10.12	12.07	47.65	-35.58	AVG
4	*	0.6260	28.01	9.99	38.00	56.00	-18.00	QP
5		16.2819	38.51	1.56	40.07	60.00	-19.93	QP
6		16.6459	12.20	1.61	13.81	50.00	-36.19	AVG

Factor = LISN factor + Cable Loss + Pulse limiter factor.

5.3 Radiated Emissions Measurement

5.3.1 Applied procedures / Limit

15.247(d) In any 100 kHz bandwidth outside the frequency band in which the spread spectrum or digitally modulated intentional radiator is operating, the radio frequency power that is produced by the intentional radiator shall be at least 20 dB below that in the 100 kHz bandwidth within the band that contains the highest level of the desired power, based on either an RF conducted or a radiated measurement, provided the transmitter demonstrates compliance with the peak conducted power limits. If the transmitter complies with the conducted power limits based on the use of RMS averaging over a time interval, as permitted under paragraph (b)(3) of this section, the attenuation required under this paragraph shall be 30 dB instead of 20 dB. Attenuation below the general limits specified in Section 15.209(a) is not required. In addition, radiated emissions which fall in the restricted bands, as defined in Section 15.205(a), must also comply with the radiated emission limits specified in Section 15.209(a) (see Section 15.205(c)).

Frequency of Emission (MHz)	Field Strength		Measurement Distance (meters)
	$\mu\text{V/m}$	$\text{dB}\mu\text{V/m}$	
0.009-0.49	2400/F(kHz)		300
0.49-1.705	24000/F(kHz)		30
1.705-30	30		30
30-88	100	40	3
88-216	150	43.5	3
216-960	200	46	3
Above 960	500	54	3

5.3.2 Test setup

Test Configuration:

- 1) 9 kHz to 30 MHz emissions:

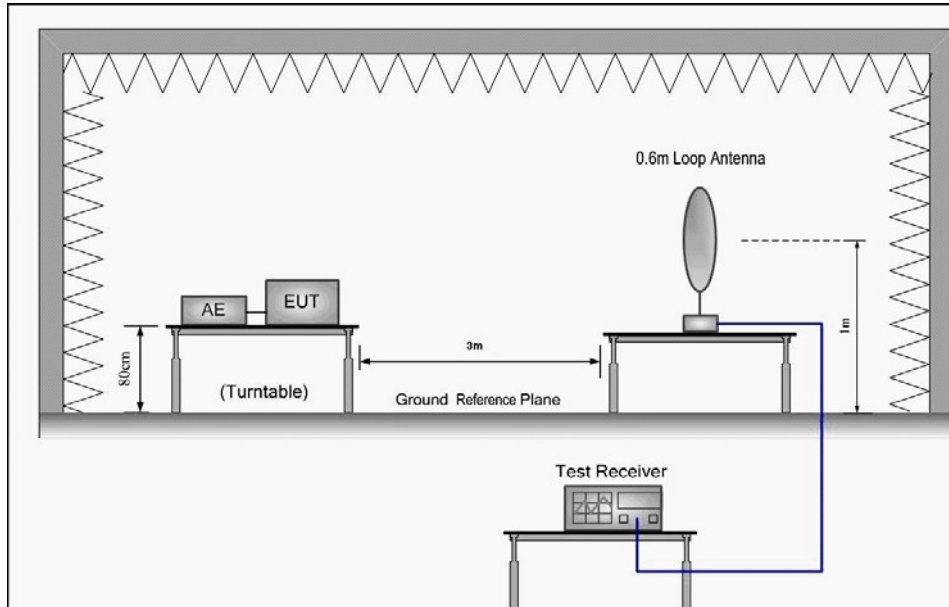

- 2) 30 MHz to 1 GHz emissions:

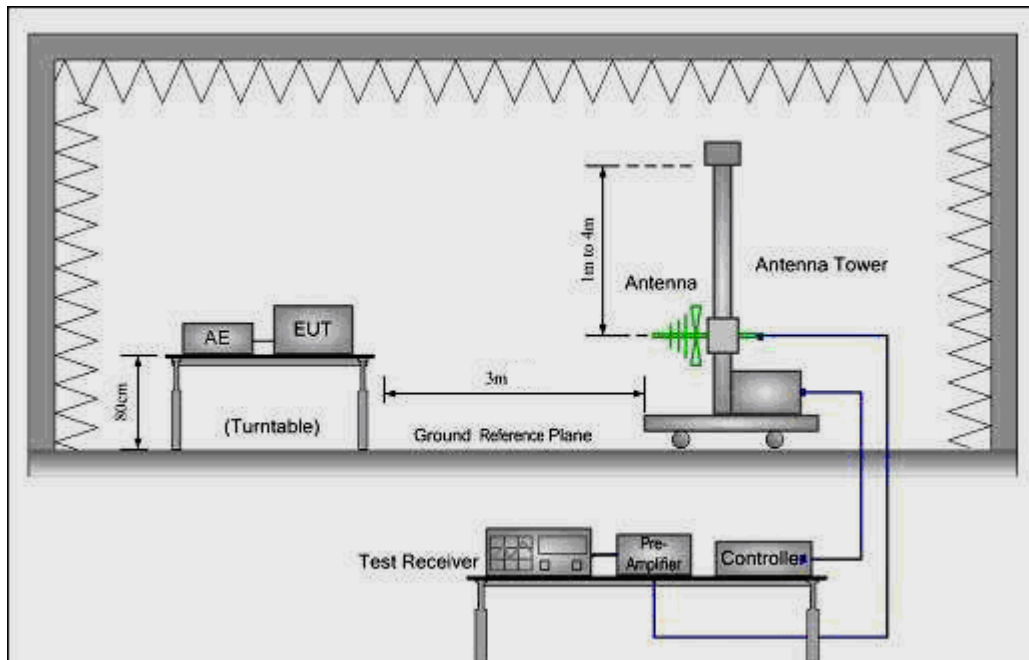

3) 1 GHz to 25 GHz emissions:

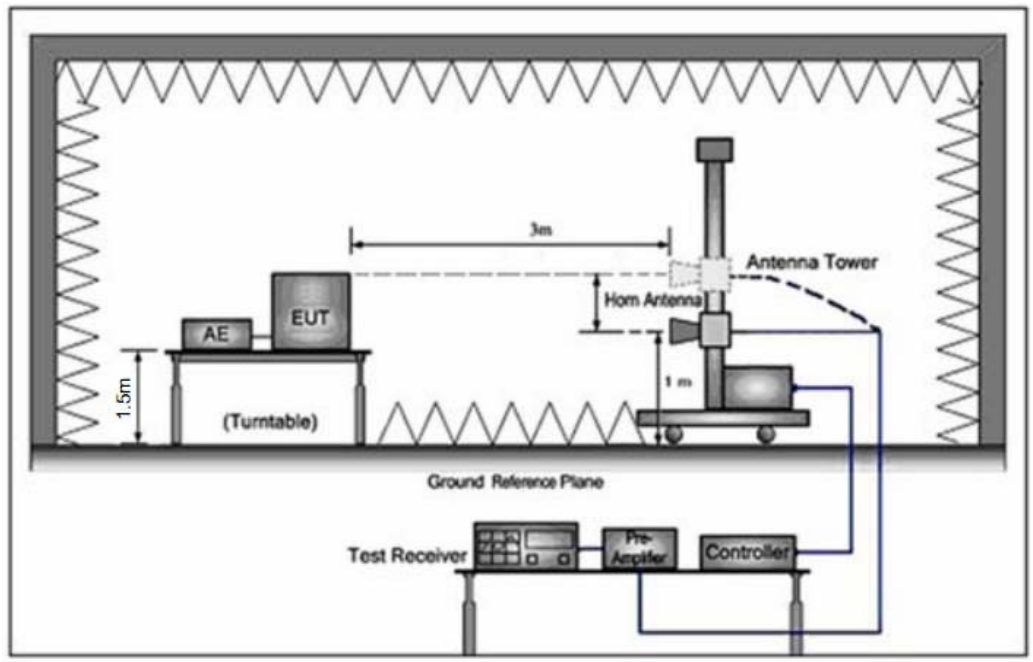

5.3.3 Test procedure

- a. The EUT was placed on the top of a wooden table 0.8 meters above the ground at a 3 meter semi-anechoic chamber. The table was rotated 360 degrees to determine the position of the highest radiation.
- b. The EUT was set 3 meters away from the interference-receiving antenna, which was mounted on the top of a variable-height antenna tower.
- c. The antenna height is varied from one meter to four meters above the ground to determine the maximum value of the field strength. Both horizontal and vertical polarizations of the antenna are set to make the measurement.
- d. For each suspected emission, the EUT was arranged to its worst case and then the antenna was tuned to heights from 1 meter to 4 meters (for the test frequency of below 30MHz, the antenna was tuned to heights 1 meter, for the test frequency of above 1GHz, horn antenna opening in the test would have been facing the EUT when rise or fall) and the table was turned from 0 degrees to 360 degrees to find the maximum reading.
- e. The test-receiver system was set to Peak Detect Function and Specified Bandwidth with Maximum Hold Mode.
- f. If the emission level of the EUT in peak mode was 10dB lower than the limit specified, then testing could be stopped and the peak values of the EUT would be reported. Otherwise the emissions that did not have 10dB margin would be re-tested one by one using peak, quasi-peak or average method as specified and then reported in a data sheet. The resolution bandwidth and video bandwidth of the test receiver was 1MHz and 1MHz for Peak detection at frequency above 1GHz.
- g. Test the EUT in the lowest channel (2402MHz), the middle channel (2441MHz), the Highest channel (2480MHz)
- h. Repeat above procedures until all frequencies measured was complete.

For measurement at frequency above 1GHz

EUT was placed upon a wooden test table which was placed on the turn table 1.5m above the horizontal metal ground plane.

Place the measurement antenna away from each area of the EUT determined to be a source of emissions at the specified measurement distance, while keeping the measurement antenna aimed at the source of emissions at each frequency of significant emissions, with polarization oriented for maximum response. The measurement antenna may have to be higher or lower than the EUT, depending on the radiation pattern of the emission and staying aimed at the emission source for receiving the maximum signal. The final measurement antenna elevation shall be that which maximizes the emissions. The measurement antenna elevation for maximum emissions shall be restricted to a range of heights of from 1 m to 4 m above the ground or reference ground plane.

In 18GHz to 25GHz, The EUT was checked by Horn ANT. But the test result at least have 20dB margin. The EUT was tested in Chamber Site.

5.3.4 Test Result

Radiated Emissions Test Data Below 30MHz

EUT:	BLUETOOTH SPEAKER	Model Name :	X403
Temperature:	25 °C	Test Data	2016-12-16
Pressure:	1010 hPa	Relative Humidity:	60%
Test Mode :	TX	Test Voltage :	DC3.7V from battery
Measurement Distance	3 m	Frenqucy Range	9KHz to 30MHz
RBW/VBW	9KHz~150KHz/RB 200Hz for QP, 150KHz~30MHz/RB 9KHz for QP		

No emission found between lowest internal used/generated frequencies to 30MHz.

Radiated Emissions Test Data Below 1GHz

EUT:	BLUETOOTH SPEAKER	Model Name :	X403
Temperature:	25 °C	Test Data	2016-12-16
Pressure:	1010 hPa	Relative Humidity:	60%
Test Mode :	TX (1Mbps) CH00 (worst case)	Test Voltage :	DC3.7V from battery
Measurement Distance	3 m	Frenqucy Range	30MHz to 1GHz
RBW/VBW	100KHz / 300KHz for spectrum, RBW=120KHz for receiver.		

(a) Antenna polarization: Horizontal

Frequency (MHz)	Reading Level (dBuV)	Correct Factor (dB)	Measure Level (dBuV/m)	Limit (dBuV/m)	Margin (dB)	Detector Type
33.7986	30.03	-16.96	13.07	40.00	-26.93	QUASIPeAK
97.4560	33.48	-15.66	17.82	43.50	-25.68	QUASIPeAK
209.3129	35.79	-16.76	19.03	43.50	-24.47	QUASIPeAK
280.0237	31.03	-11.26	19.77	46.00	-26.23	QUASIPeAK
601.4265	31.95	-0.89	31.06	46.00	-14.94	QUASIPeAK
798.9797	29.70	3.44	33.14	46.00	-12.86	QUASIPeAK

(b) Antenna polarization: vertical

Frequency (MHz)	Reading Level (dBuV)	Correct Factor (dB)	Measure Level (dBuV/m)	Limit (dBuV/m)	Margin (dB)	Detector Type
45.8553	29.62	-14.36	15.26	40.00	-24.74	QUASIPeAK
97.4560	31.46	-16.28	15.18	43.50	-28.32	QUASIPeAK
182.5592	30.19	-11.36	18.83	43.50	-24.67	QUASIPeAK
312.1794	32.33	-9.11	23.22	46.00	-22.78	QUASIPeAK
699.3046	30.40	0.44	30.84	46.00	-15.16	QUASIPeAK
952.0937	32.30	3.77	36.07	46.00	-9.93	QUASIPeAK

Note:

Measurement Level = Reading Level + Factor

Remark: Factor = Antenna Factor + Cable Loss - Pre-amplifier

Radiated Emissions Test Data Above 1GHz

EUT:	BLUETOOTH SPEAKER	Model Name :	X403
Temperature:	25 °C	Test Data	2016-12-16
Pressure:	1010 hPa	Relative Humidity:	60%
Test Mode :	1Mbps	Test Voltage :	DC3.7V from battery
Measurement Distance	3 m	Frenqucy Range	1GHz to 25GHz
RBW/VBW	1MHz/1MHz for Peak, 1MHz/10Hz for Average.		

1~25 GHz Harmonics & Spurious Emissions. Peak & Average Measurement

Vertical Measurement:

Frequency (MHz)	Reading Level (dB μ V)	factor (dB)	Emission Level (dB μ V/m)	Limit (dB μ V/m)	Margin (dB)	Antenna polarization
4804.000	50.44	5.06	55.50	74.00	-18.50	peak
4804.000	36.25	5.06	41.31	54.00	-12.69	AVG
7206.000	49.78	7.03	56.81	74.00	-17.19	peak
7206.000	31.15	7.03	38.18	54.00	-15.82	AVG
9608.000	42.36	10.63	52.99	74.00	-21.01	peak
9608.000	28.09	10.63	38.72	54.00	-15.28	AVG

Horizontal Measurement:

Frequency (MHz)	Reading Level (dB μ V)	factor (dB)	Emission Level (dB μ V/m)	Limit (dB μ V/m)	Margin (dB)	Antenna polarization
4804.000	52.78	5.06	57.84	74.00	-16.16	peak
4804.000	36.42	5.06	41.48	54.00	-12.52	AVG
7206.000	48.87	7.03	55.90	74.00	-18.10	peak
7206.000	33.54	7.03	40.57	54.00	-13.43	AVG
9608.000	43.26	10.63	53.89	74.00	-20.11	peak
9608.000	28.53	10.63	39.16	54.00	-14.84	AVG

Note:

Measurement Level = Reading Level + Factor
Factor=Ant Factor + Cable Loss-Preamp Factor
Low Channel 00: 2402 MHz
Data rate: 1Mbps

1~25 GHz Harmonics & Spurious Emissions. Peak & Average Measurement

Vertical Measurement:

Frequency (MHz)	Reading Level (dB μ V)	factor (dB)	Emission Level (dB μ V/m)	Limit (dB μ V/m)	Margin (dB)	Antenna polarization
4882.000	51.12	5.14	56.26	74.00	-17.74	peak
4882.000	36.47	5.14	41.61	54.00	-12.39	AVG
7323.000	45.83	7.54	53.37	74.00	-20.63	peak
7323.000	31.59	7.54	39.13	54.00	-14.87	AVG
9764.000	40.66	11.39	52.05	74.00	-21.95	peak
9764.000	28.74	11.39	40.13	54.00	-13.87	AVG

Horizontal Measurement:

Frequency (MHz)	Reading Level (dB μ V)	factor (dB)	Emission Level (dB μ V/m)	Limit (dB μ V/m)	Margin (dB)	Antenna polarization
4882.000	52.31	5.14	57.45	74.00	-16.55	peak
4882.000	35.74	5.14	40.88	54.00	-13.12	AVG
7323.000	45.39	7.54	52.93	74.00	-21.07	peak
7323.000	32.85	7.54	40.39	54.00	-13.61	AVG
9764.000	41.57	11.39	52.96	74.00	-21.04	peak
9764.000	25.68	11.39	37.07	54.00	-16.93	AVG

Note:

Measurement Level = Reading Level + Factor
 Factor=Ant Factor + Cable Loss-Preamp Factor
 Middle Channel 39: 2441 MHz
 Data rate: 1Mbps

1~25 GHz Harmonics & Spurious Emissions. Peak & Average Measurement

Vertical Measurement:

Frequency (MHz)	Reading Level (dB μ V)	factor (dB)	Emission Level (dB μ V/m)	Limit (dB μ V/m)	Margin (dB)	Antenna polarization
4960.000	50.43	5.22	55.65	74.00	-18.35	peak
4960.000	35.51	5.22	40.73	54.00	-13.27	AVG
7440.000	46.19	8.06	54.25	74.00	-19.75	peak
7440.000	33.85	8.06	41.91	54.00	-12.09	AVG
9920.000	42.56	12.10	54.66	74.00	-19.34	peak
9920.000	28.39	12.10	40.49	54.00	-13.51	AVG

Horizontal Measurement:

Frequency (MHz)	Reading Level (dB μ V)	factor (dB)	Emission Level (dB μ V/m)	Limit (dB μ V/m)	Margin (dB)	Antenna polarization
4960.000	52.24	5.22	57.46	74.00	-16.54	peak
4960.000	37.64	5.22	42.86	54.00	-11.14	AVG
7440.000	45.26	8.06	53.32	74.00	-20.68	peak
7440.000	33.41	8.06	41.47	54.00	-12.53	AVG
9920.000	40.57	12.10	52.67	74.00	-21.33	peak
9920.000	25.45	12.10	37.55	54.00	-16.45	AVG

Note:

Measurement Level = Reading Level + Factor
 Factor=Ant Factor + Cable Loss-Preamp Factor
 High Channel 78: 2480 MHz
 Data rate: 1Mbps

EUT:	BLUETOOTH SPEAKER	Model Name :	X403
Temperature:	25 °C	Test Data	2016-12-16
Pressure:	1010 hPa	Relative Humidity:	60%
Test Mode :	3Mbps	Test Voltage :	DC3.7V from battery
Measurement Distance	3 m	Frenqucy Range	1GHz to 25GHz
RBW/VBW	1MHz/1MHz for Peak, 1MHz/10Hz for Average.		

1~25 GHz Harmonics & Spurious Emissions. Peak & Average Measurement

Vertical Measurement:

Frequency (MHz)	Reading Level (dB μ V)	factor (dB)	Emission Level (dB μ V/m)	Limit (dB μ V/m)	Margin (dB)	Antenna polarization
4804.000	50.83	5.06	55.89	74.00	-18.11	peak
4804.000	35.67	5.06	40.73	54.00	-13.27	AVG
7206.000	43.71	7.03	50.74	74.00	-23.26	peak
7206.000	27.50	7.03	34.53	54.00	-19.47	AVG
9608.000	39.38	10.63	50.01	74.00	-23.99	peak
9608.000	24.42	10.63	35.05	54.00	-18.95	AVG

Horizontal Measurement:

Frequency (MHz)	Reading Level (dB μ V)	factor (dB)	Emission Level (dB μ V/m)	Limit (dB μ V/m)	Margin (dB)	Antenna polarization
4804.000	52.48	5.06	57.54	74.00	-16.46	peak
4804.000	36.27	5.06	41.33	54.00	-12.67	AVG
7206.000	46.60	7.03	53.63	74.00	-20.37	peak
7206.000	32.71	7.03	39.74	54.00	-14.26	AVG
9608.000	42.43	10.63	53.06	74.00	-20.94	peak
9608.000	26.25	10.63	36.88	54.00	-17.12	AVG

Note:

Measurement Level = Reading Level + Factor
 Factor=Ant Factor + Cable Loss-Preamp Factor
 Low Channel 00: 2402 MHz
 Data rate: 3Mbps

1~25 GHz Harmonics & Spurious Emissions. Peak & Average Measurement

Vertical Measurement:

Frequency (MHz)	Reading Level (dB μ V)	factor (dB)	Emission Level (dB μ V/m)	Limit (dB μ V/m)	Margin (dB)	Antenna polarization
4882.000	49.85	5.14	54.99	74.00	-19.01	peak
4882.000	36.76	5.14	41.90	54.00	-12.10	AVG
7323.000	42.51	7.54	50.05	74.00	-23.95	peak
7323.000	32.30	7.54	39.84	54.00	-14.16	AVG
9764.000	39.63	11.39	51.02	74.00	-22.98	peak
9764.000	26.81	11.39	38.20	54.00	-15.80	AVG

Horizontal Measurement:

Frequency (MHz)	Reading Level (dB μ V)	factor (dB)	Emission Level (dB μ V/m)	Limit (dB μ V/m)	Margin (dB)	Antenna polarization
4882.000	51.42	5.14	56.56	74.00	-17.44	peak
4882.000	36.59	5.14	41.73	54.00	-12.27	AVG
7323.000	47.47	7.54	55.01	74.00	-18.99	peak
7323.000	31.60	7.54	39.14	54.00	-14.86	AVG
9764.000	42.49	11.39	53.88	74.00	-20.12	peak
9764.000	28.42	11.39	39.81	54.00	-14.19	AVG

Note:

Measurement Level = Reading Level + Factor
 Factor=Ant Factor + Cable Loss-Preamp Factor
 Middle Channel 39: 2441 MHz
 Data rate: 3Mbps

1~25 GHz Harmonics & Spurious Emissions. Peak & Average Measurement

Vertical Measurement:

Frequency (MHz)	Reading Level (dB μ V)	factor (dB)	Emission Level (dB μ V/m)	Limit (dB μ V/m)	Margin (dB)	Antenna polarization
4960.000	50.86	5.22	56.08	74.00	-17.92	peak
4960.000	36.77	5.22	41.99	54.00	-12.01	AVG
7440.000	46.69	8.06	54.75	74.00	-19.25	peak
7440.000	31.21	8.06	39.27	54.00	-14.73	AVG
9920.000	40.50	12.10	52.60	74.00	-21.40	peak
9920.000	28.43	12.10	40.53	54.00	-13.47	AVG

Horizontal Measurement:

Frequency (MHz)	Reading Level (dB μ V)	factor (dB)	Emission Level (dB μ V/m)	Limit (dB μ V/m)	Margin (dB)	Antenna polarization
4960.000	51.03	5.22	56.25	74.00	-17.75	51.03
4960.000	36.45	5.22	41.67	54.00	-12.33	36.45
7440.000	48.73	8.06	56.79	74.00	-17.21	48.73
7440.000	34.58	8.06	42.64	54.00	-11.36	34.58
9920.000	42.40	12.10	54.50	74.00	-19.50	42.40
9920.000	25.57	12.10	37.67	54.00	-16.33	25.57

Note:

Measurement Level = Reading Level + Factor

Factor=Ant Factor + Cable Loss-Preamp Factor

High Channel 78: 2480 MHz

Data rate: 3Mbps

5.3.5 TEST RESULTS (Restricted Bands Requirements)

EUT:	BLUETOOTH SPEAKER	Model Name :	X403
Temperature:	26 °C	Relative Humidity:	60%
Pressure:	1010 hPa	Test Voltage :	DC3.7V from battery
Test Mode :	TX 2402MHz/2480MHz (1Mbps)		
Note:	1. The transmitter was setup to transmit at the lowest channel (CH00). Then the field strength was measured at 2310-2390 MHz. 2. The transmitter was setup to transmit at the highest channel (CH78). Then the field strength was measured at 2483.5-2500 MHz. 3. The data of 2390MHz and 2483.5MHz was the worst.		

Freq. (MHz)	Ant.Pol. H/V	Reading		Ant/CF CF(dB)	Act		Limit		Note
		Peak (dBuv)	AV (dBuv)		Peak (dBuv/m)	AV (dBuv/m)	Peak (dBuv/m)	AV (dBuv/m)	
2390.00	V	39.99	26.87	-5.79	34.20	21.08	74.00	54.00	CH00
2390.00	H	39.67	26.58	-5.79	33.88	20.79	74.00	54.00	CH00
2483.50	V	39.74	29.82	-4.98	34.76	24.84	74.00	54.00	CH78
2483.50	H	38.48	29.37	-4.98	33.50	24.39	74.00	54.00	CH78

Remark:

- (1) Radiated emissions measured in frequency range above 1000MHz were made with an instrument using Peak detector mode
- (2) During the measurements above 1 GHz it is taken care of that the EUT is always within the 3 dB cone of radiation BW of the used antenna
- (3) Corr.Factor = Antenna Factor + Cable Loss – Pre-amplifier.

EUT:	BLUETOOTH SPEAKER	Model Name :	X403
Temperature:	26°C	Relative Humidity:	60%
Pressure:	1010 hPa	Test Voltage :	DC3.7V from battery
Test Mode :	TX 2402MHz/2480MHz (3Mbps)		
Note:	1. The transmitter was setup to transmit at the lowest channel (CH00). Then the field strength was measured at 2310-2390 MHz. 2. The transmitter was setup to transmit at the highest channel (CH78). Then the field strength was measured at 2483.5-2500 MHz. 3. The data of 2390MHz and 2483.5MHz was the worst.		

Freq. (MHz)	Ant.Pol. H/V	Reading		Ant/CF CF(dB)	Act		Limit		Note
		Peak (dBuv)	AV (dBuv)		Peak (dBuv/m)	AV (dBuv/m)	Peak (dBuv/m)	AV (dBuv/m)	
2390.00	V	39.29	26.98	-5.79	33.50	21.19	74.00	54.00	CH00
2390.00	H	38.94	27.81	-5.79	33.15	22.02	74.00	54.00	CH00
2483.50	V	40.54	29.34	-4.98	35.56	24.36	74.00	54.00	CH78
2483.50	H	38.95	29.72	-4.98	33.97	24.74	74.00	54.00	CH78

Remark:

- (1) Radiated emissions measured in frequency range above 1000MHz were made with an instrument using Peak detector mode
- (2) During the measurements above 1 GHz it is taken care of that the EUT is always within the 3 dB cone of radiation BW of the used antenna
- (3) Corr.Factor = Antenna Factor + Cable Loss – Pre-amplifier.

Remark: No any other emission which falls in restricted bands can be detected and be reported.

Test result: The unit does meet the FCC requirements.

5.4 BANDWIDTH TEST

5.4.1 Applied procedures / Limit

For frequency hopping system operating in the 2400-2483.5MHz, If the 20dB bandwidth of hopping channel is greater than 25kHz, two-thirds 20dB bandwidth of hopping channel shall be a minimum limit for the hopping channel separation.

5.4.2 Test procedure

- a. The EUT was directly connected to the spectrum analyzer and antenna output port as show in the block diagram below.
- b. Spectrum Setting: RBW= 100KHz, VBW \geq RBW, Sweep time = Auto.

5.4.3 Deviation from standard

No deviation.

5.4.4 Test setup



5.4.5 Test results

EUT:	BLUETOOTH SPEAKER	Model Name :	X403
Temperature:	26 °C	Relative Humidity:	53%
Pressure:	1010 hPa	Test Power :	DC3.7V from battery
Test Mode :	TX 1Mbps\ 2Mbps\ 3Mbps		

Test result:

Normal mode:

Test Channel	Bandwidth(MHz)	2/3 bandwidth(MHz)
Lowest	1.0984	0.7323
Middle	1.1158	0.7439
Highest	1.0897	0.7265

2EDR mode:

Test Channel	bandwidth	2/3 bandwidth
Lowest	1.3502	0.9001
Middle	1.3589	0.9059
Highest	1.3589	0.9059

3EDR mode:

Test Channel	bandwidth	2/3 bandwidth
Lowest	1.3502	0.9001
Middle	1.3459	0.8973
Highest	1.3415	0.8943

CH00-1Mbps

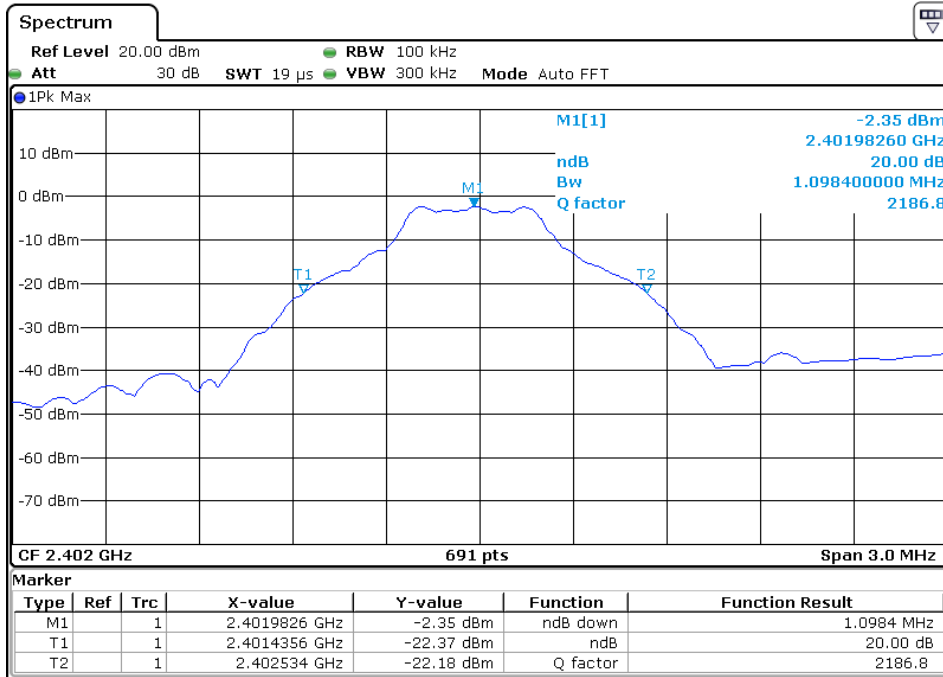

CH 39-1Mbps

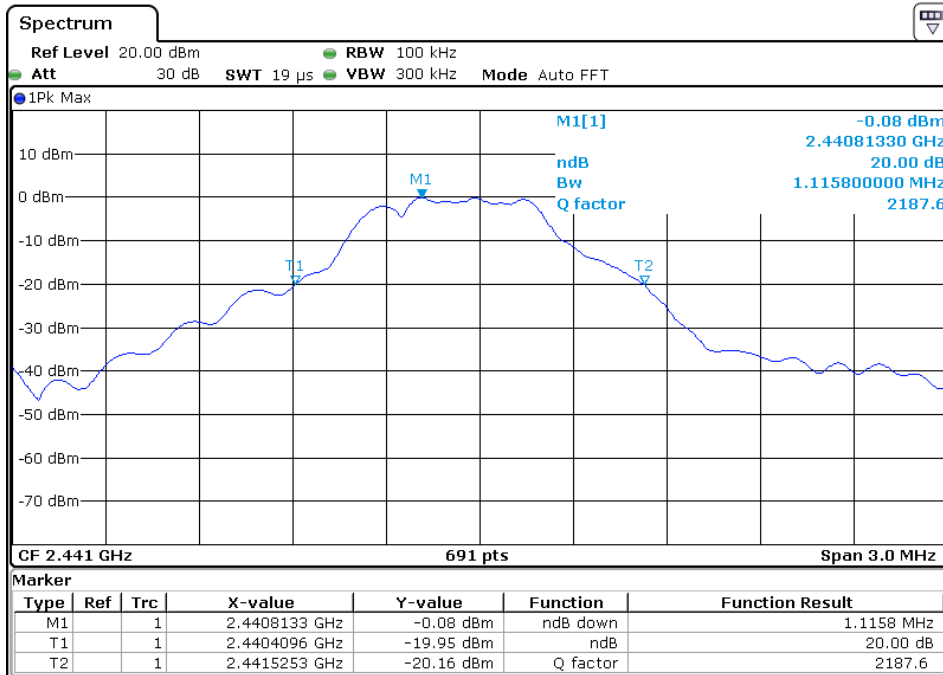

CH 78-1Mbps

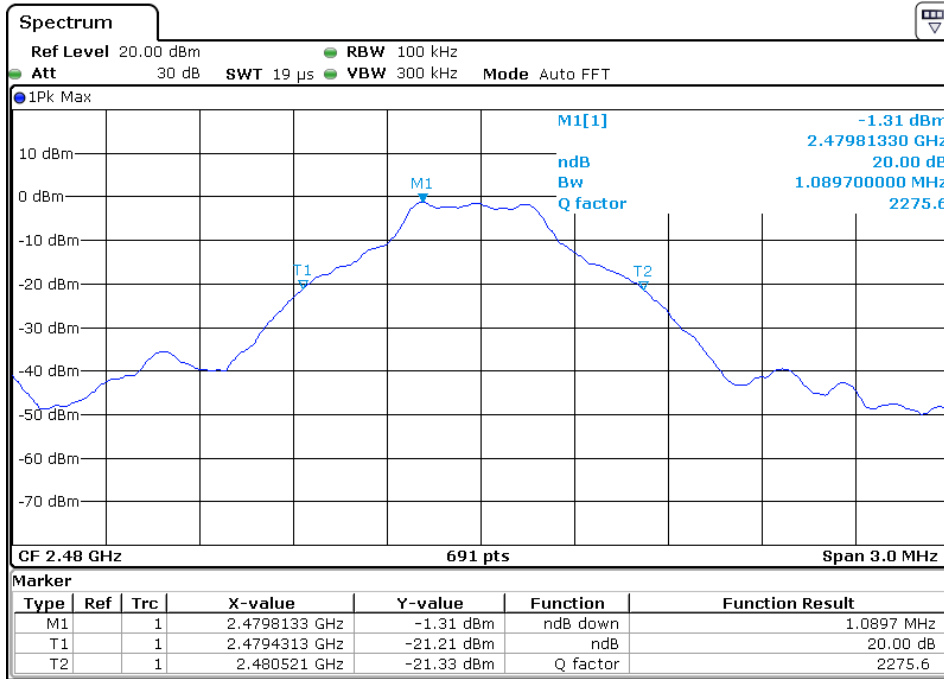

CH 00-2Mbps

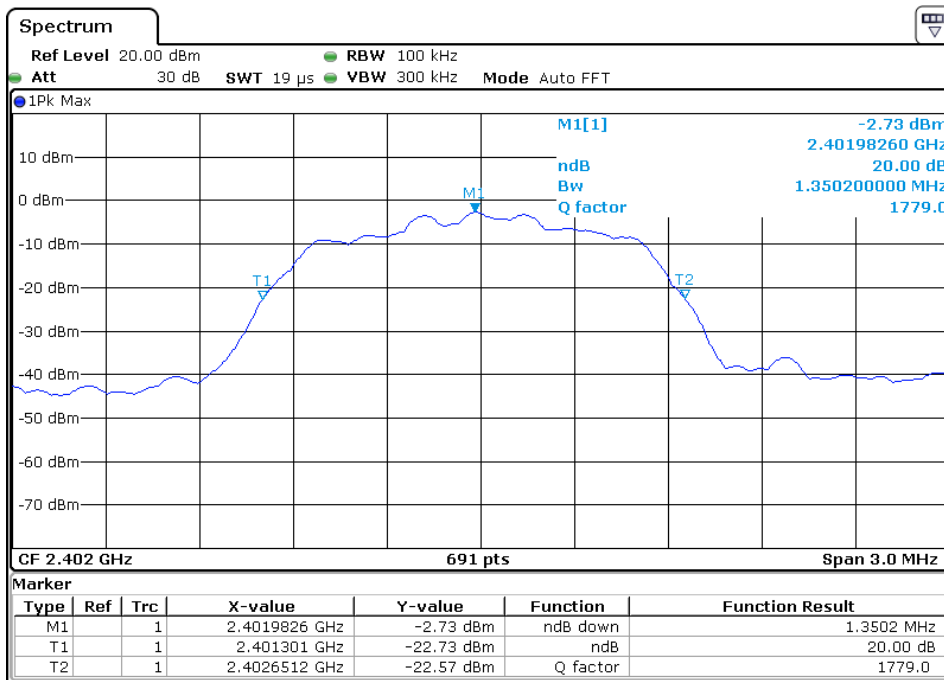

CH 39-2Mbps

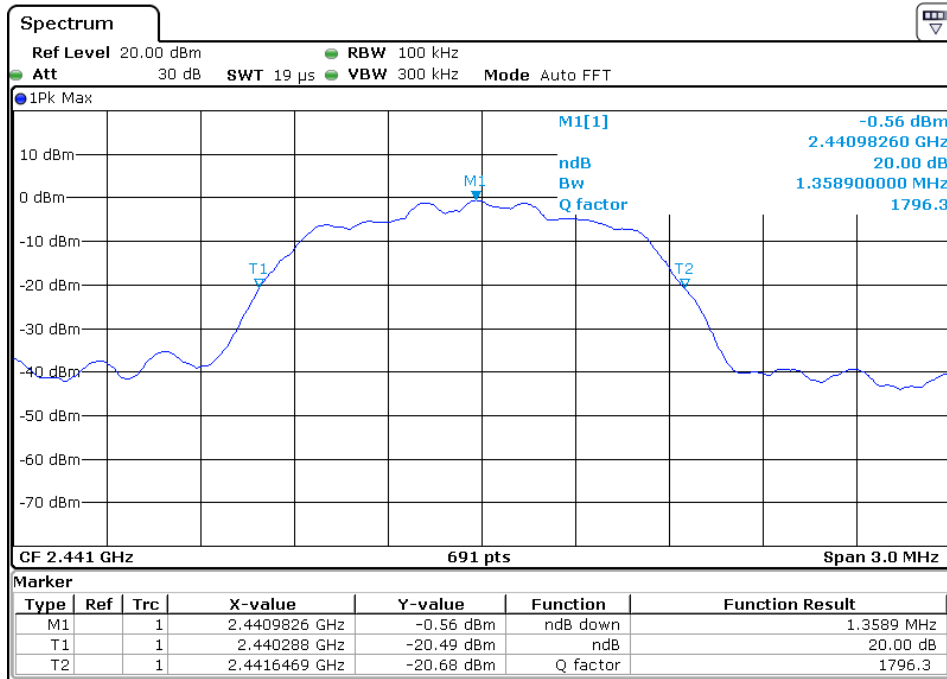

CH 78-2Mbps

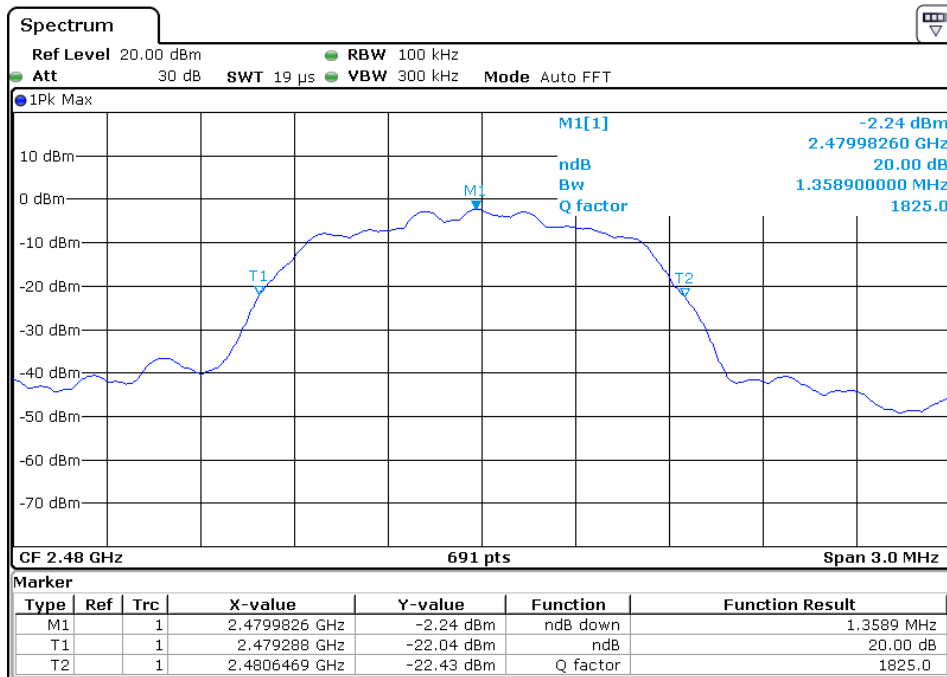

CH 00-3Mbps

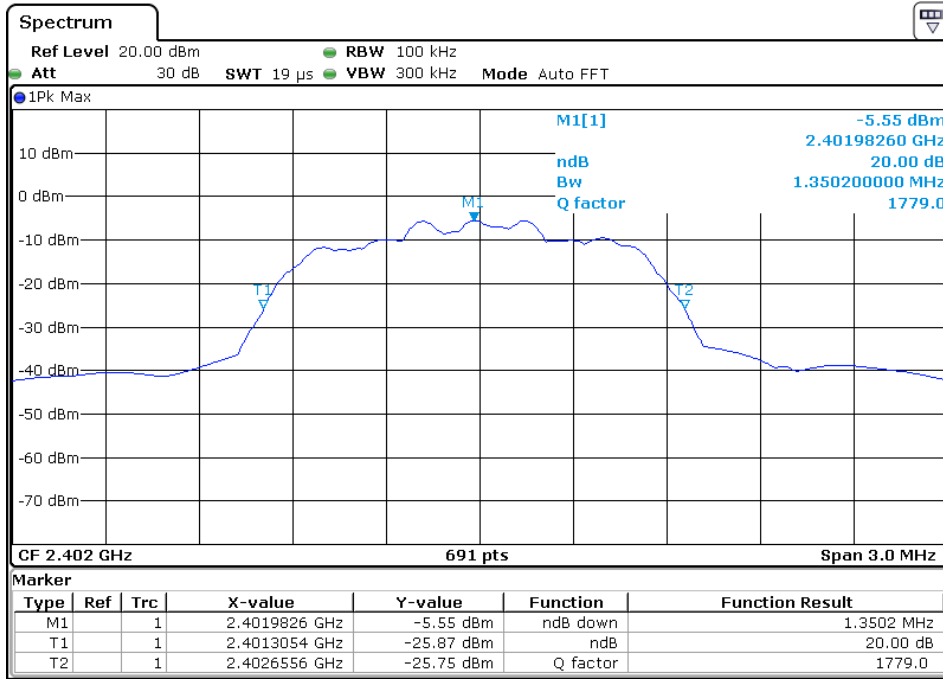

CH 39-3Mbps

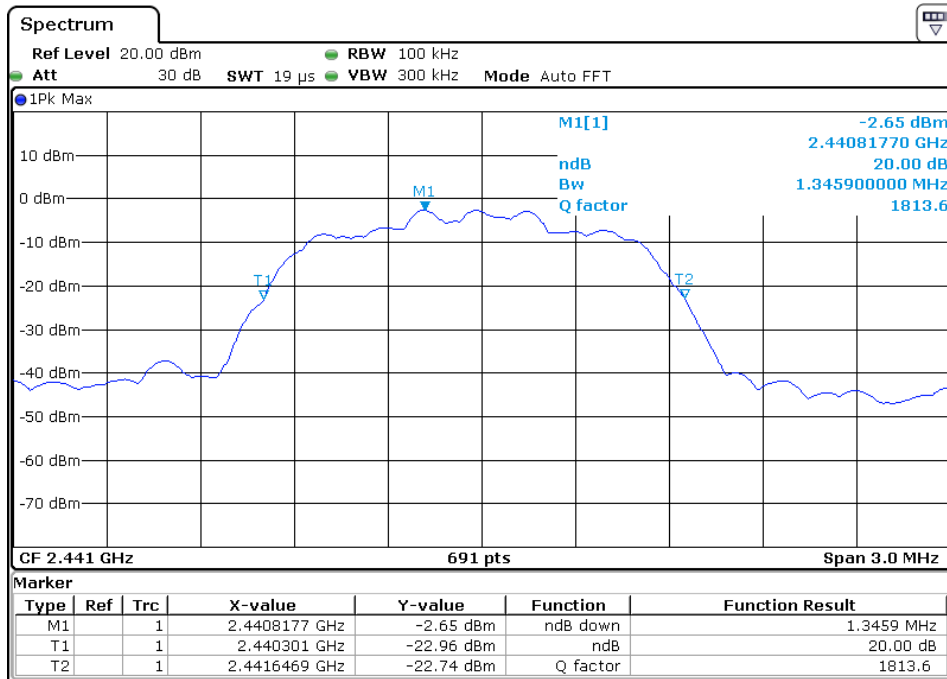

CH 78-3Mbps

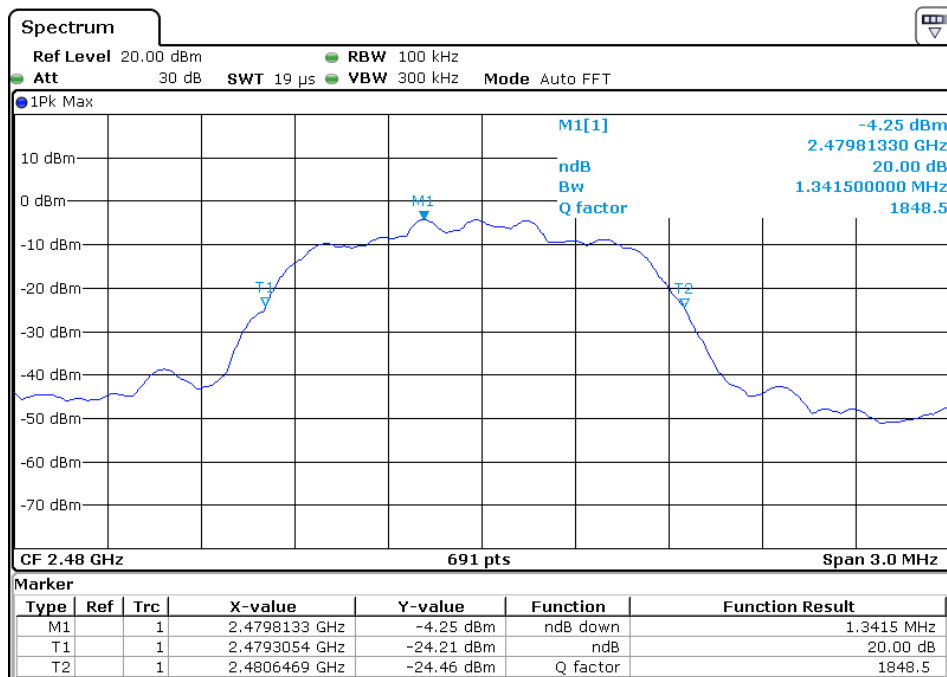

5.5 Carrier Frequencies Separated

5.5.1 Applied procedures / Limit

15.247(a) (1) Frequency hopping systems shall have hopping channel carrier frequencies separated by a minimum of 25 kHz or the 20 dB bandwidth of the hopping channel, whichever is greater. Alternatively, frequency hopping systems operating in the 2400-2483.5 MHz band may have hopping channel carrier frequencies that are separated by 25 kHz or two-thirds of the 20 dB bandwidth of the hopping channel, whichever is greater, provided the systems operate with an output power no greater than 125 mW.

5.5.2 Test procedure

- (1) Connected the antenna port to the Spectrum Analyzer, set the Spectrum Analyzer as RBW=100kHz, VBW \geq RBW, Sweep time=Auto, Detector Function=Peak.
- (2) The EUT should be transmitting at its maximum data rate. Use the marker-delta function to determine the separation between the peaks of the adjacent channels.
- (3) The above procedure shall be repeated at the lowest, the middle, and the highest frequency of the stated frequency range with modulated mode. also shall be performed at different modes of operation.

5.5.3 Deviation from standard

No deviation.

5.5.4 Test setup



5.5.5 Test results

EUT:	BLUETOOTH SPEAKER	Model Name :	X403
Temperature:	22 °C	Relative Humidity:	53%
Pressure:	1010 hPa	Test Power :	DC3.7V from battery
Test Mode :	TX 1Mbps/ 3Mbps		

Test result:

1Mbps

Test Channel	Carrier Frequencies Separated	Pass/Fail
Lower Channels (channel 0 and channel 1)	998.6 KHz	Pass
Middle Channels (channel 39 and channel 40)	998.6 KHz	Pass
Upper Channels (channel 77 and channel 78)	998.6 KHz	Pass

3Mbps

Test Channel	Carrier Frequencies Separated	Pass/Fail
Lower Channels (channel 0 and channel 1)	1002.9 KHz	Pass
Middle Channels (channel 39 and channel 40)	1007.2 KHz	Pass
Upper Channels (channel 77 and channel 78)	1007.2 KHz	Pass

Remark:

The limit is maximum two-thirds of the 20 dB bandwidth: 905.9 KHz.

CH 00-1Mbps

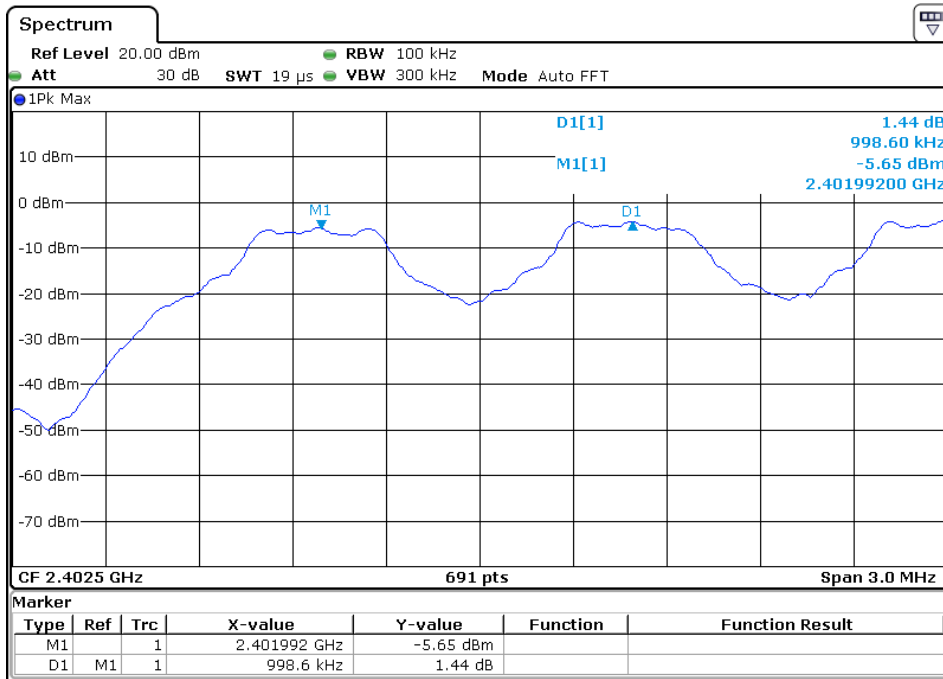

CH 39-1Mbps

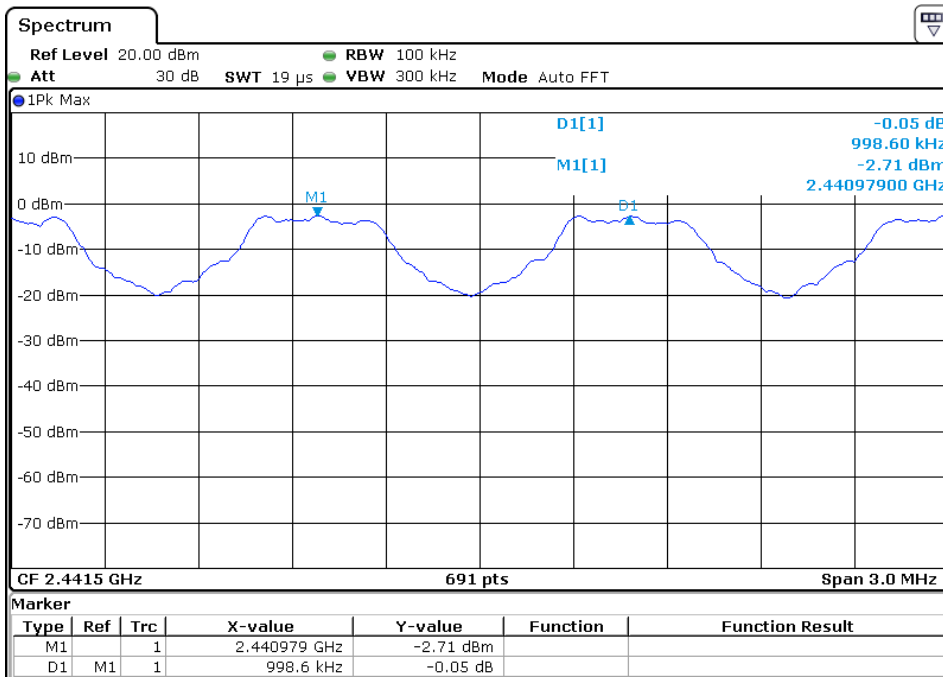

CH 78-1Mbps

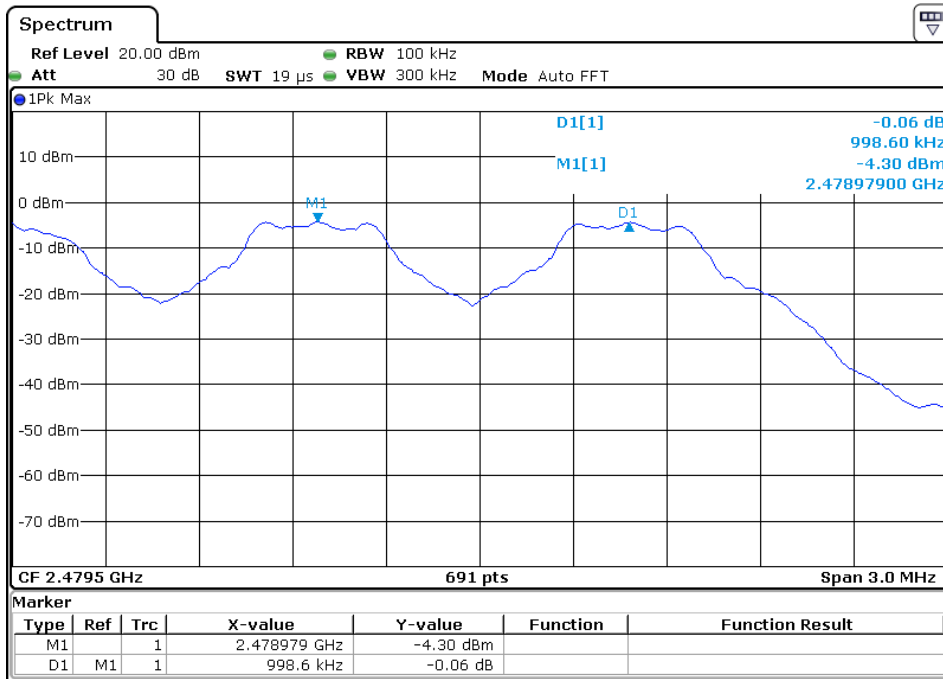

CH00 -3Mbps

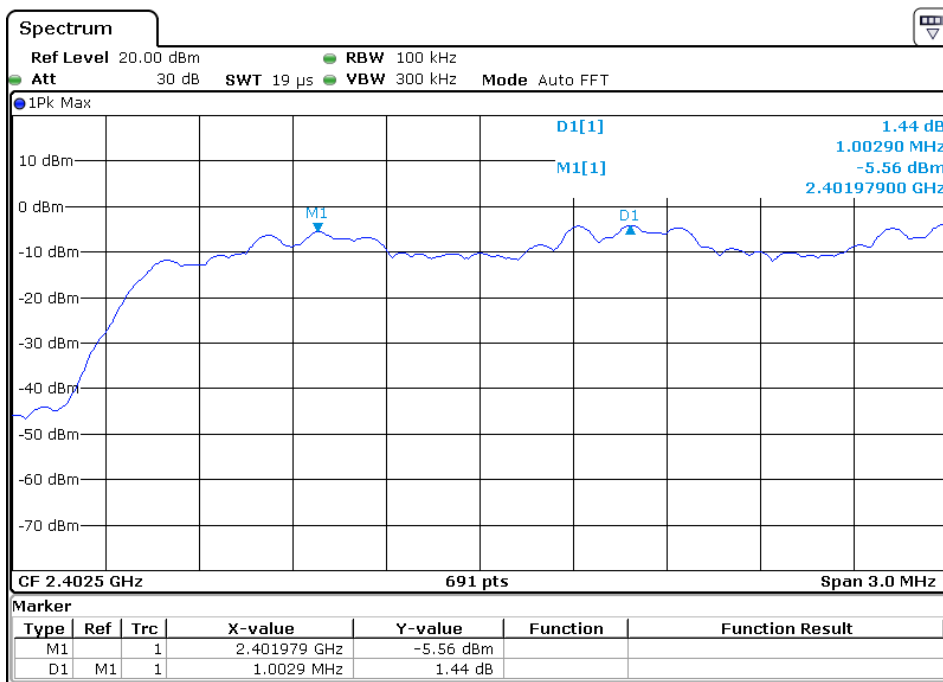

CH39 -3Mbps

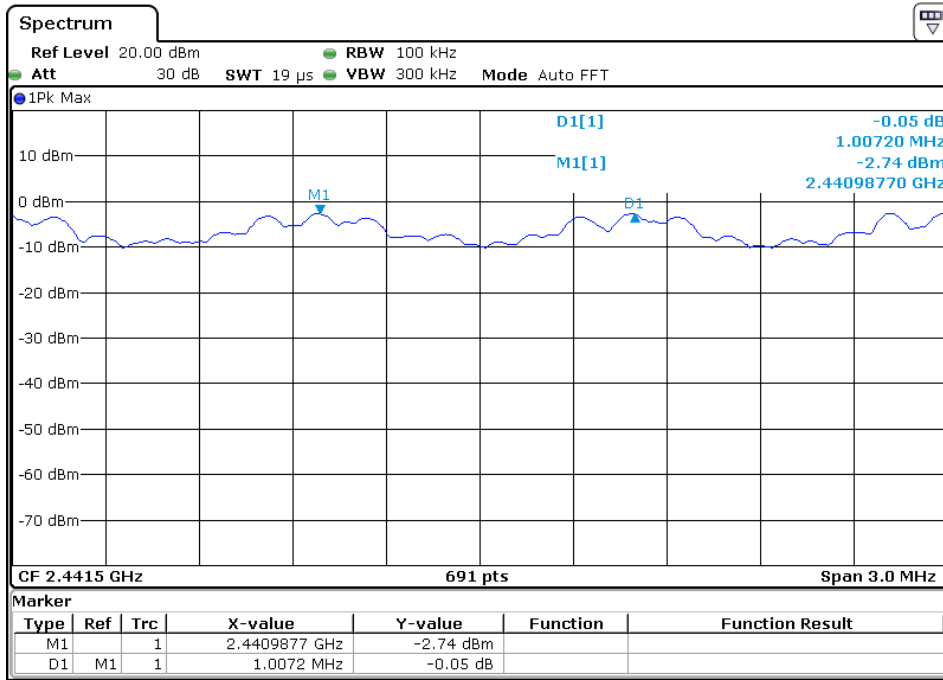

CH78 -3Mbps

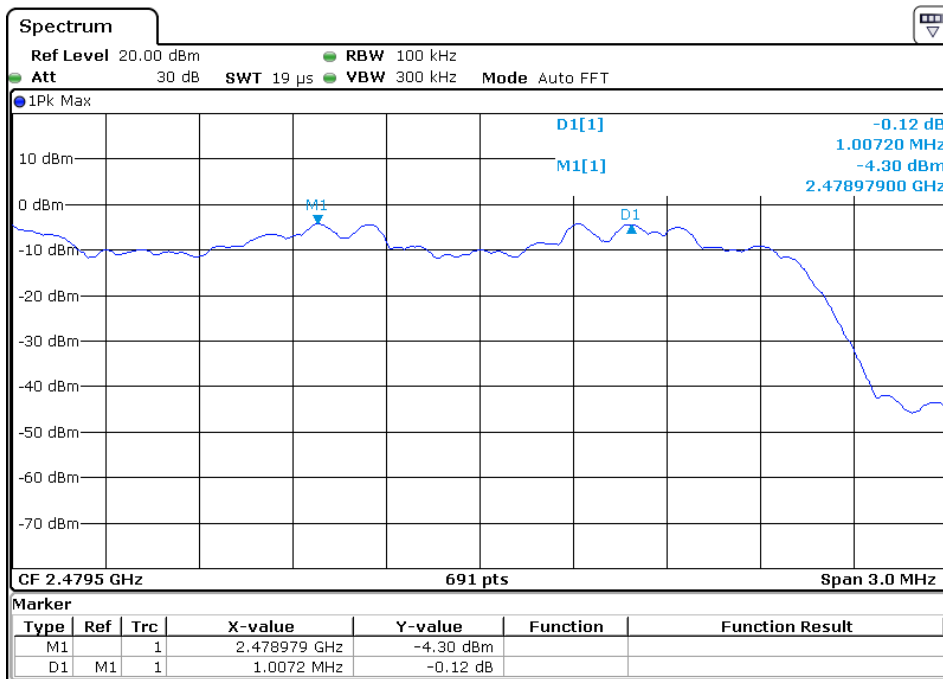

Test result: The unit does meet the FCC requirements.

5.6 Hopping Channel Number

5.6.1 Applied procedures / Limit

15.247(a) (1) (iii) Frequency hopping systems in the 2400-2483.5 MHz band shall use at least 15 channels. The average time of occupancy on any channel shall not be greater than 0.4 seconds within a period of 0.4 seconds multiplied by the number of hopping channels employed. Frequency hopping systems may avoid or suppress transmissions on a particular hopping frequency provided that a minimum of 15 channels are used.

5.6.2 Test procedure

- (1) Connected the antenna port to the Spectrum Analyzer , set the Spectrum Analyzer as RBW=100kHz,VBW \geq RBW, Sweep time=Auto, Detector Function=Peak Trace=Maxhold.
- (2) The EUT should be have its hopping function enabled. Maxhold and record hopping channels It may prove necessary to break the span up to sections, in order to clearly show all of the hopping frequencies.

5.6.3 Deviation from standard

No deviation.

5.6.4 Test setup



5.6.5 Test result

Hopping Channel Number result		
Operating Mode: 1Mbps\ 3Mbps Mode		Test date:2016-12-16
Result	Limit	Conclusion
79	15	Pass

EUT:	BLUETOOTH SPEAKER	Model Name :	X403
Temperature:	22 °C	Relative Humidity:	53%
Pressure:	1010 hPa	Test Power :	DC3.7V from battery
Test Mode :	TX 1Mbps/ 3Mbps		

1Mbps

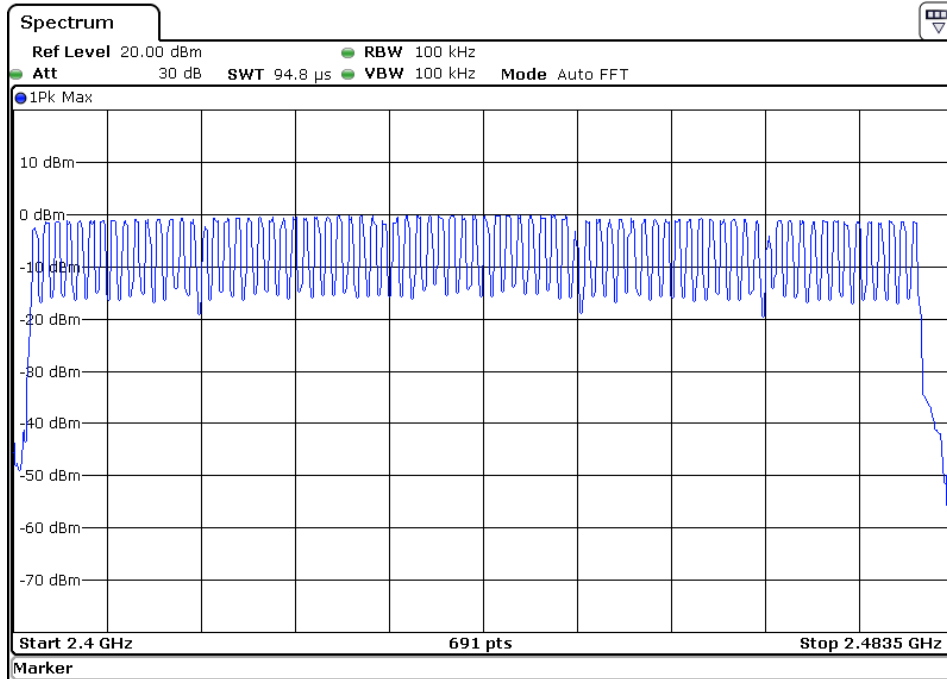

3Mbps

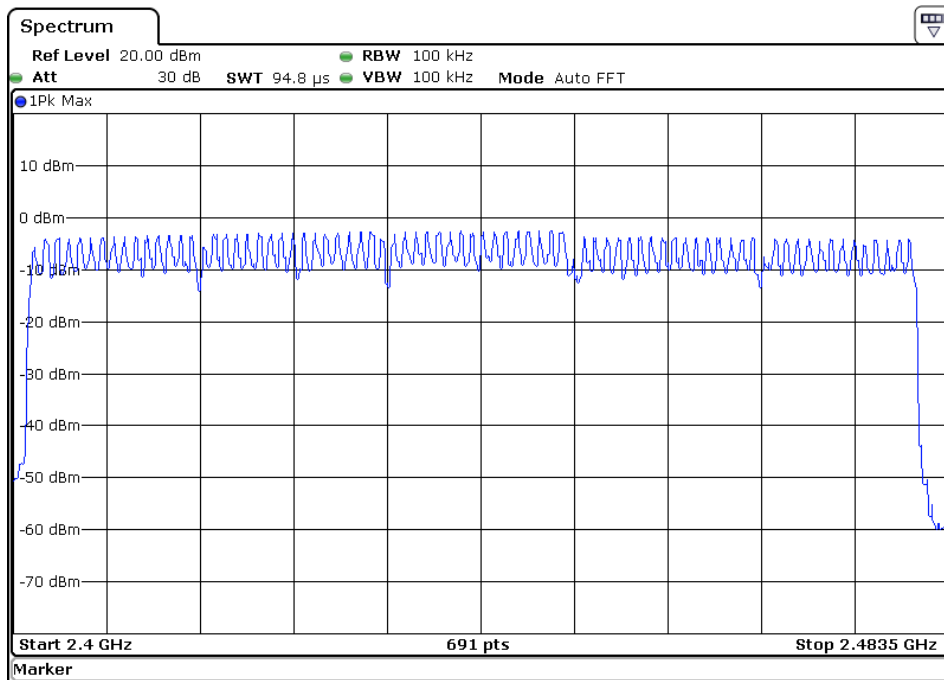

Test result: The unit does meet the FCC requirements.

5.7 Dwell time

5.7.1 Applied procedures / Limit

15.247(a) (1) (iii) Frequency hopping systems in the 2400-2483.5 MHz band shall use at least 15 channels. The average time of occupancy on any channel shall not be greater than 0.4 seconds within a period of 0.4 seconds multiplied by the number of hopping channels employed. Frequency hopping systems may avoid or suppress transmissions on a particular hopping frequency provided that a minimum of 15 channels are used.

5.7.2 Test procedure

- (1) Place the EUT on the table in the chamber or connect the antenna port of the EUT to spectrum analyzer and set it in transmitting mode.
- (2) Set RBW of spectrum analyzer to 1MHz, $VBW \geq RBW$
- (3) Use a video trigger with the trigger level set to enable triggering only on full pulses.
- (4) Sweep Time is more than once pulse time.
- (5) Set the center frequency on any frequency would be measure and set the frequency span to zero span.
- (6) Measure the maximum time duration of one single pulse.
- (7) Set the EUT for DH5, DH3 and DH1 packet transmitting.
- (8) Measure the maximum time duration of one single pulse.
- (9) A Period Time = $79 \times 0.4 = 31.6$ S
DH1 Time Slot: Reading * $(1600/2) \times 31.6/79$
DH3 Time Slot: Reading * $(1600/4) \times 31.6/79$
DH5 Time Slot: Reading * $(1600/6) \times 31.6/79$

5.7.3 Deviation from standard

No deviation.

5.7.4 TEST SETUP



5.7.5 Test result

EUT:	BLUETOOTH SPEAKER	Model Name :	X403
Temperature:	26 °C	Relative Humidity:	60%
Pressure:	1012 hPa	Test Voltage :	DC3.7V from battery
Test Mode :	CH0-DH1/DH3/DH5 (1Mbps Mode)		

Data Packet	Frequency	Pulse Duration (ms)	Dwell Time (s)	Limits (s)
DH1	2402 MHz	0.463	0.148	0.4000
DH3	2402 MHz	1.698	0.271	0.4000
DH5	2402 MHz	2.950	0.314	0.4000

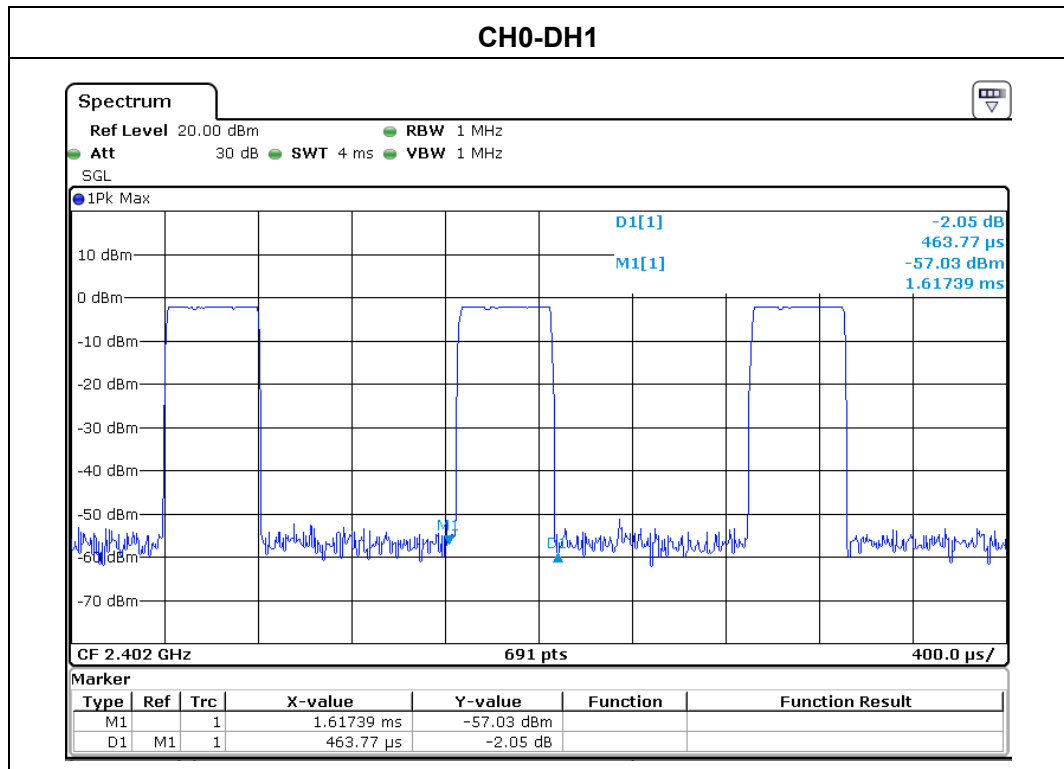

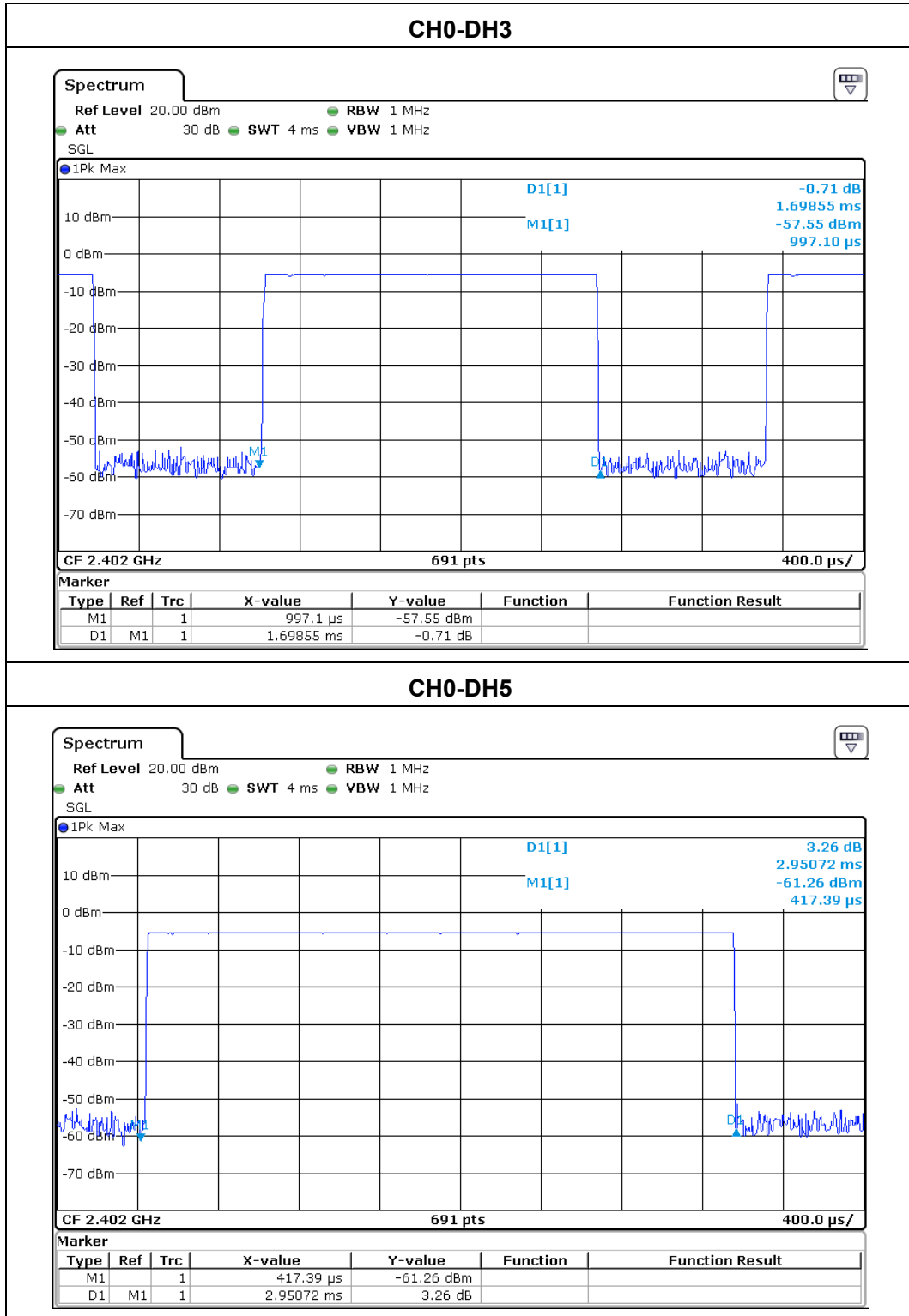

EUT:	BLUETOOTH SPEAKER	Model Name :	X403
Temperature:	26 °C	Relative Humidity:	60%
Pressure:	1012 hPa	Test Voltage :	DC3.7V from battery
Test Mode :	CH0-3DH1/3DH3/3DH5 (3Mbps Mode)		

Data Packet	Frequency	Pulse Duration (ms)	Dwell Time (s)	Limits (s)
DH1	2402 MHz	0.434	0.138	0.4000
DH3	2402 MHz	1.692	0.270	0.4000
DH5	2402 MHz	2.944	0.314	0.4000

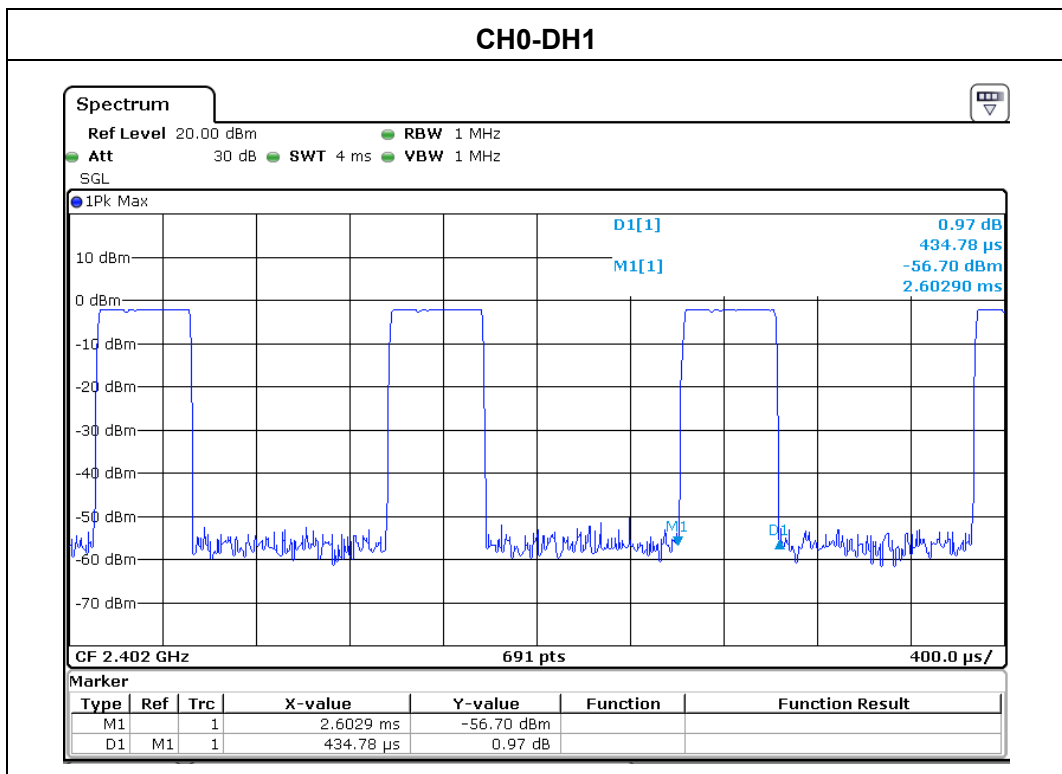

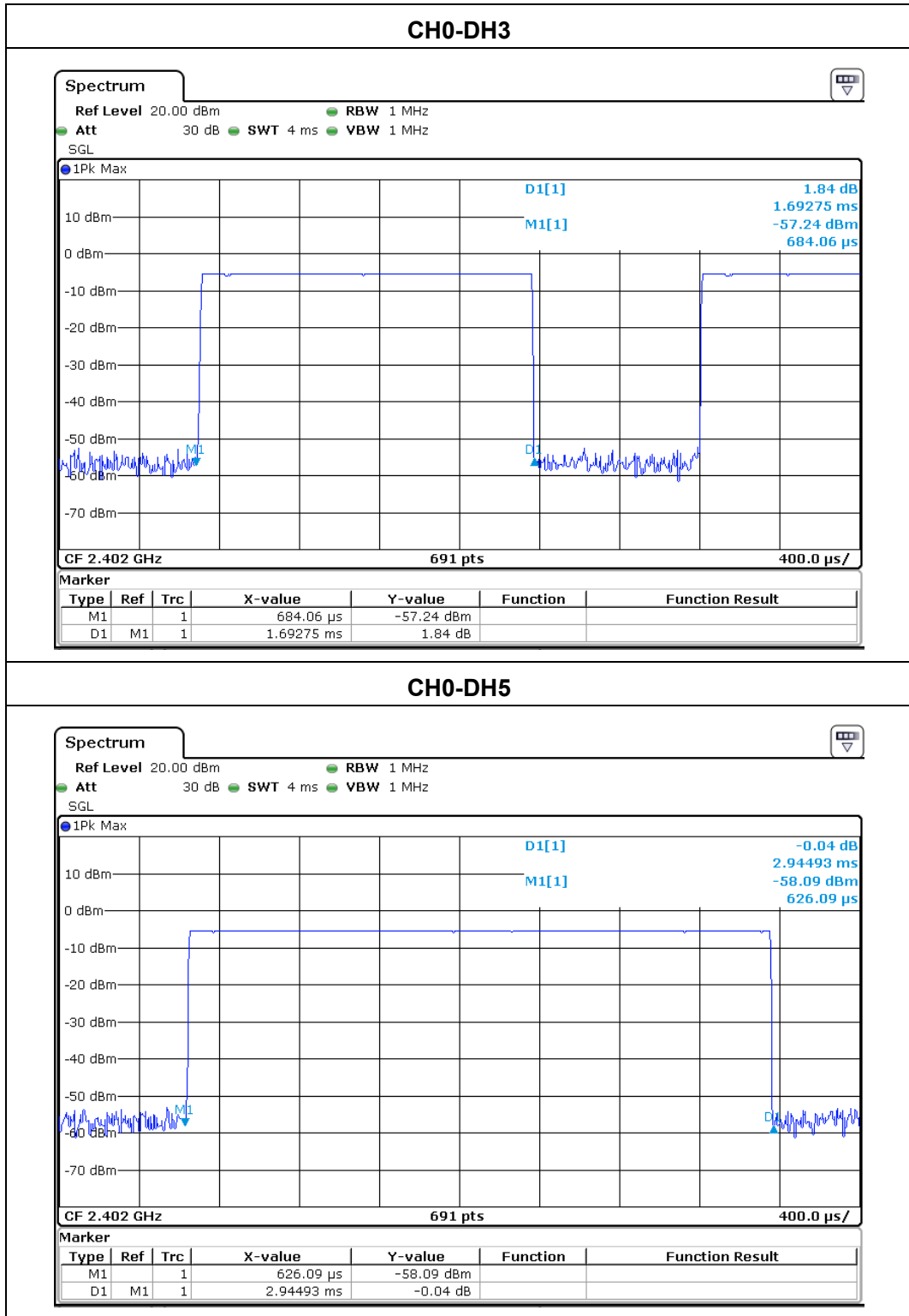

5.8 Maximum Peak Output Power

5.8.1 Applied procedures / Limit

5.247(a) (1) Frequency hopping systems shall have hopping channel carrier frequencies separated by a minimum of 25 kHz or the 20 dB bandwidth of the hopping channel, whichever is greater. Alternatively, frequency hopping systems operating in the 2400–2483.5 MHz band may have hopping channel carrier frequencies that are separated by 25 kHz or two-thirds of the 20 dB bandwidth of the hopping channel, whichever is greater, provided the systems operate with an output power no greater than 125 mW.

15.247(b) (1) For frequency hopping systems operating in the 2400-2483.5 MHz band employing at least 75 non-overlapping hopping channels, and all frequency hopping systems in the 5725-5850 MHz band: 1 watt. For all other frequency hopping systems in the 2400-2483.5 MHz band: 0.125 watts.

5.8.2 Test procedure

- (1) Connected the antenna port to the broadband peak RF power meter, Allow the transmitted power to stabilize, record the max peak value.
- (2) The EUT should be transmitting at its maximum data rate.
- (3) The above procedure shall be repeated at the lowest, the middle, and the highest frequency of the stated frequency range with modulated mode. also shall be performed at different modes of operation.

5.8.3 Deviation from standard

No deviation.

5.8.4 Test setup

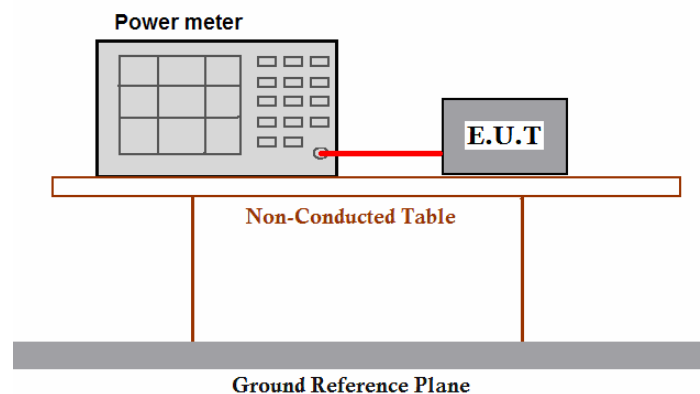

5.8.5 Test results

EUT:	BLUETOOTH SPEAKER	Model Name :	X403
Temperature:	22 °C	Relative Humidity:	60%
Pressure:	1010 hPa	Test Voltage :	DC3.7V from battery
Test Mode :	TX		
Note: All the data rates have be tested and the worst-case as the table below.			

Test Result:				
Normal mode:				
Test Channel	Fundamental Frequency (MHz)	Output Power (dBm)	Limit (dBm)	Result
Lowest	2402	-2.27	21.0	Pass
Middle	2441	1.44	21.0	Pass
Highest	2480	0.06	21.0	Pass
2EDR mode:				
Test Channel	Fundamental Frequency (MHz)	Output Power (dBm)	Limit (dBm)	Result
Lowest	2402	-1.53	21.0	Pass
Middle	2441	0.28	21.0	Pass
Highest	2480	-1.46	21.0	Pass
3EDR mode:				
Test Channel	Fundamental Frequency (MHz)	Output Power (dBm)	Limit (dBm)	Result
Lowest	2402	-2.16	21.0	Pass
Middle	2441	0.31	21.0	Pass
Highest	2480	-1.38	21.0	Pass
Test result: The unit does meet the FCC requirements.				

5.9 Band edge

5.9.1 Applied procedures / Limit

15.247(d) In any 100 kHz bandwidth outside the frequency band in which the spread spectrum or digitally modulated intentional radiator is operating, the radio frequency power that is produced by the intentional radiator shall be at least 20 dB below that in the 100 kHz bandwidth within the band that contains the highest level of the desired power, based on either an RF conducted or a radiated measurement, provided the transmitter demonstrates compliance with the peak conducted power limits. If the transmitter complies with the conducted power limits based on the use of RMS averaging over a time interval, as permitted under paragraph (b)(3) of this section, the attenuation required under this paragraph shall be 30 dB instead of 20 dB. Attenuation below the general limits specified in Section 15.209(a) is not required. In addition, radiated emissions which fall in the restricted bands, as defined in Section 15.205(a), must also comply with the radiated emission limits specified in Section 15.209(a) (see Section 15.205(c)).

5.9.2 Test procedure

- a. The EUT was directly connected to the spectrum analyzer and antenna output port as show in the block diagram below.
- b. Span = wide enough to capture the peak level of the emission operating on the channel closest to the bandedge, as well as any modulation products which fall outside of the authorized band of operation, RBW \geq 1% of the span, VBW \geq RBW, Sweep = auto, Detector function = peak, Trace = max hold

5.9.3 Deviation from standard

No deviation.

5.9.4 Test setup

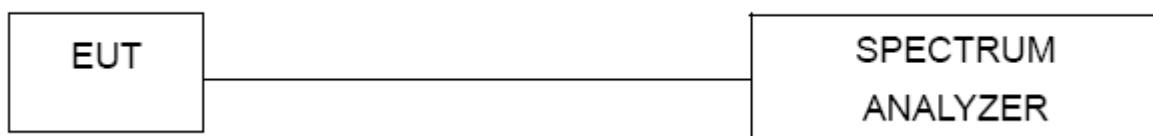

5.9.5 Test results

Conducted Band edge CH00 (Lower) Data rate 1Mbps

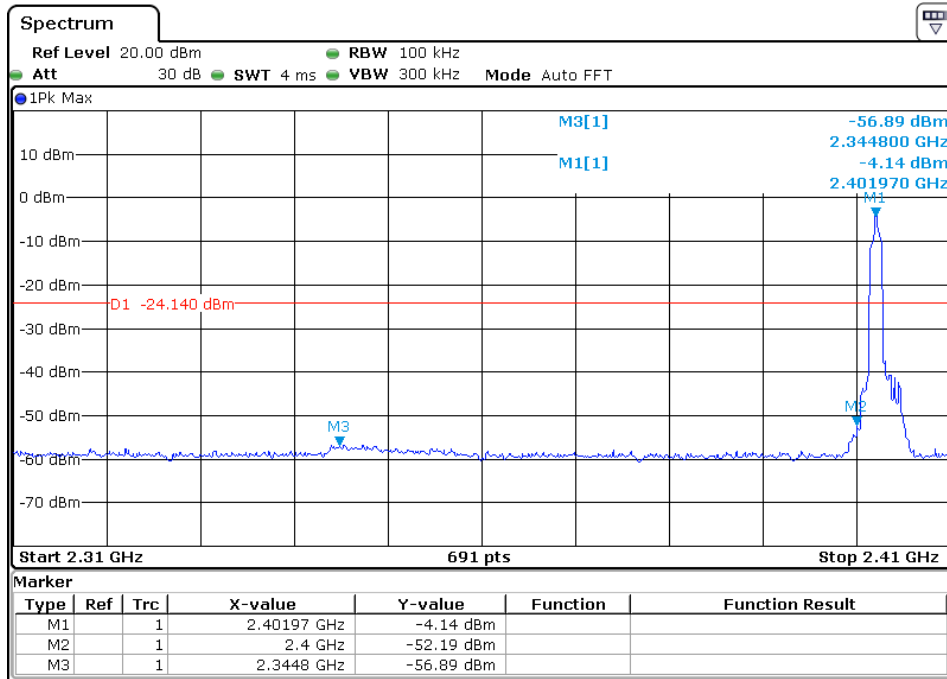

CH 78 (Upper) Data rate 1Mbps

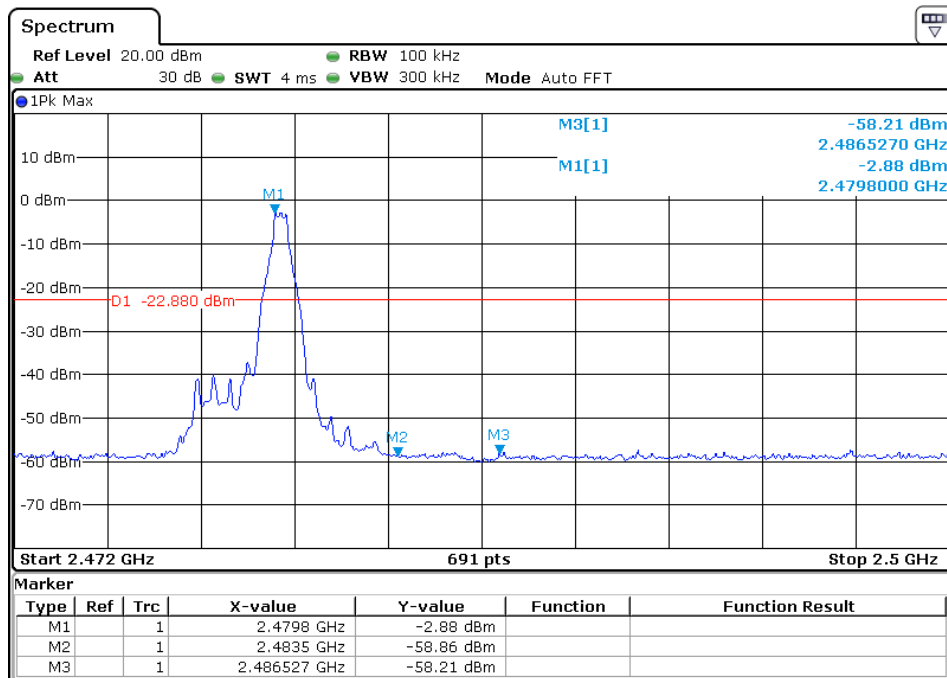

CH00 (Lower) Data rate 3Mbps

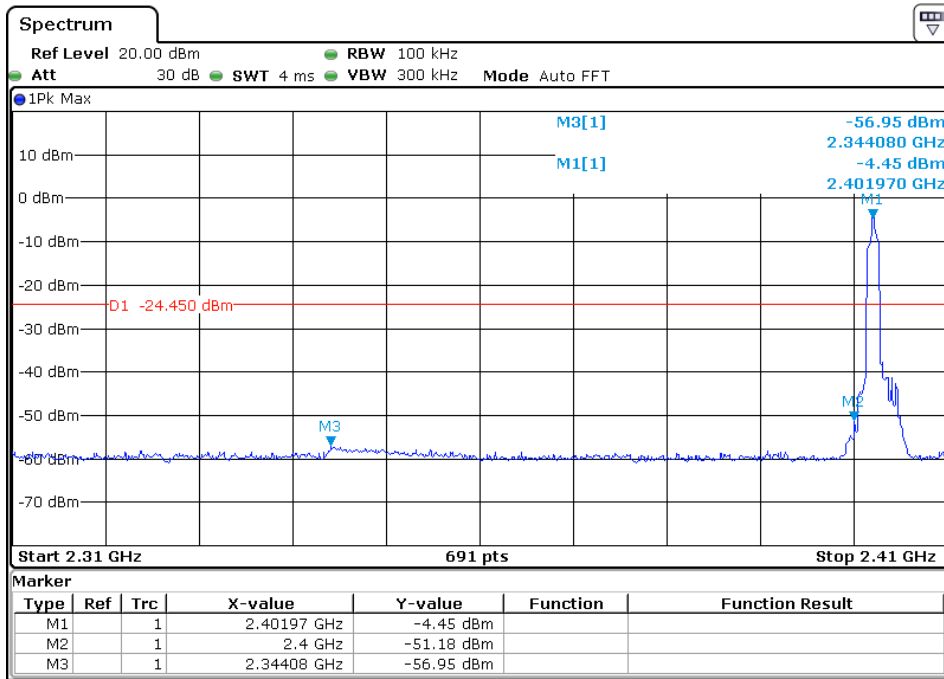

CH 78 (Upper) Data rate 3Mbps

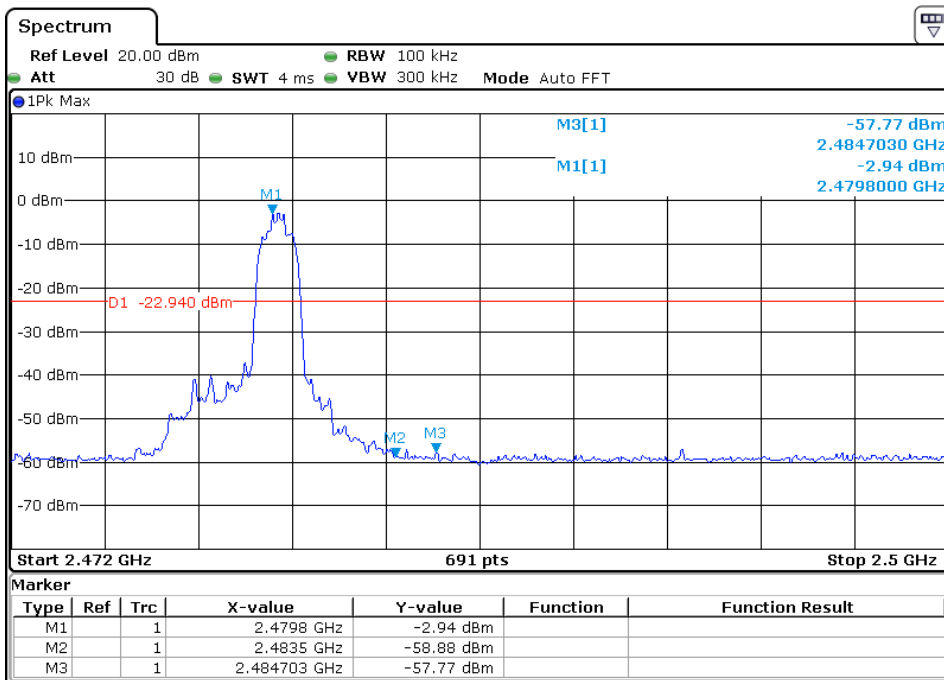

CH00 (Lower) Data rate 1Mbps

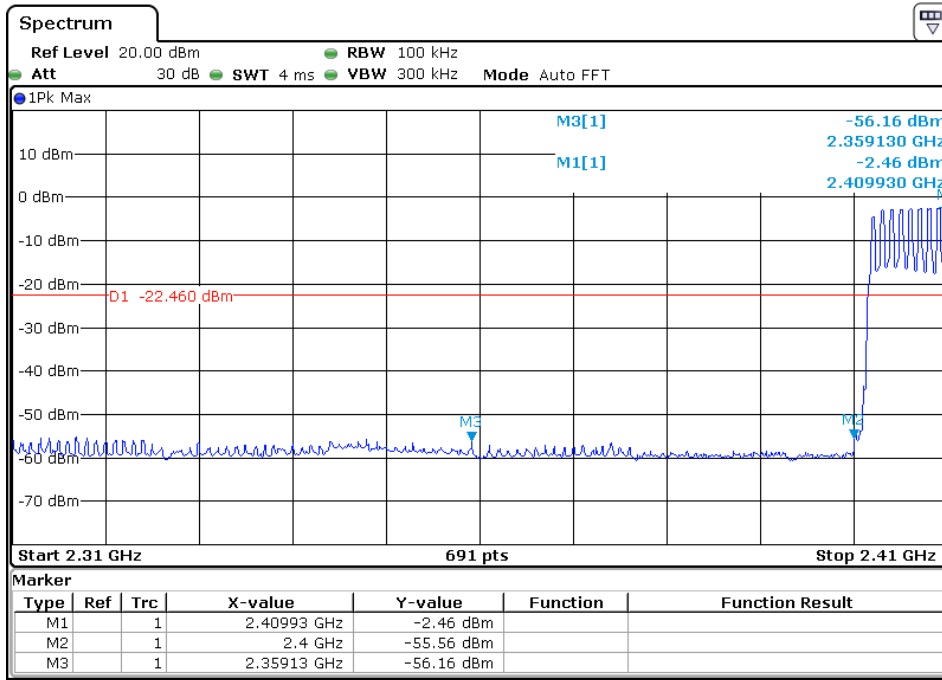

CH 78 (Upper) Data rate 1Mbps

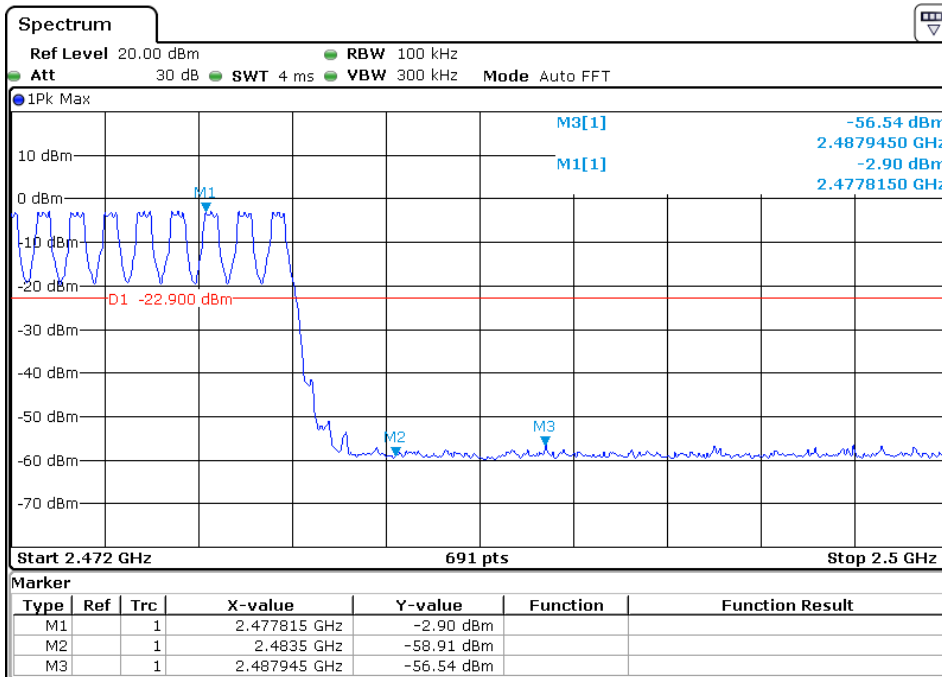

CH00 (Lower) Data rate 3Mbps

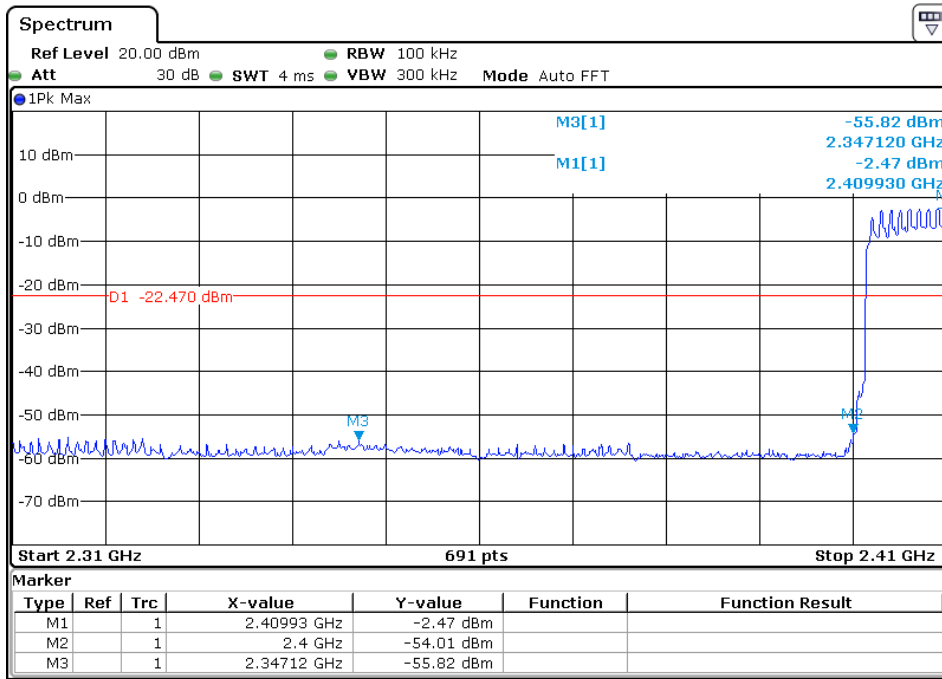

CH 78 (Upper) Data rate 3Mbps

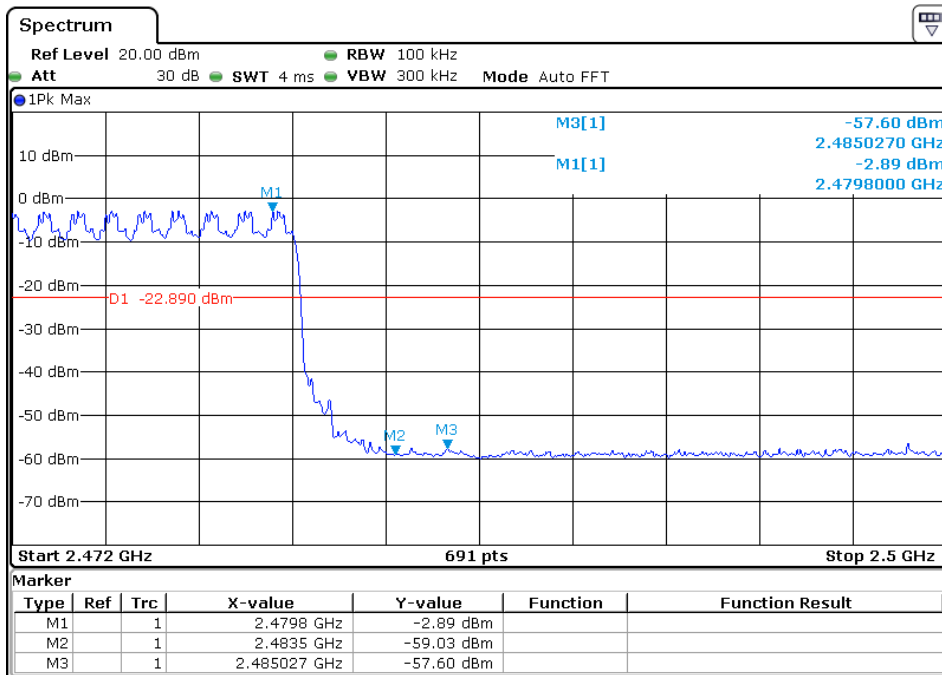

Radiated Band edge

Data rate 1Mbps						
Peak Measurement:						
Frequency (MHz)	Reading Level (dB μ V)	Factor (dB)	Emission Level (dB μ V/m)	Limits (dB μ V/m)	Margin (dB)	Antenna polarization
2400.00	40.21	-5.70	34.51	74.00	-39.49	V
2483.50	39.88	-4.98	34.90	74.00	-39.10	V
2400.00	39.98	-5.70	34.28	74.00	-39.72	H
2483.50	39.21	-4.98	34.23	74.00	-39.77	H
Average Measurement:						
Frequency (MHz)	Reading Level (dB μ V)	Factor (dB)	Emission Level (dB μ V/m)	Limits (dB μ V/m)	Margin (dB)	Antenna polarization
2400.00	26.97	-5.70	21.27	54.00	-32.73	V
2483.50	30.03	-4.98	25.05	54.00	-28.95	V
2400.00	26.85	-5.70	21.15	54.00	-32.85	H
2483.50	30.12	-4.98	25.14	54.00	-28.86	H

Data rate 3Mbps						
Peak Measurement:						
Frequency (MHz)	Reading Level (dB μ V)	Factor (dB)	Emission Level (dB μ V/m)	Limits (dB μ V/m)	Margin (dB)	Antenna polarization
2400.00	39.57	-5.70	33.87	74.00	-40.13	V
2483.50	41.11	-4.98	36.13	74.00	-37.87	V
2400.00	39.15	-5.70	33.45	74.00	-40.55	H
2483.50	39.87	-4.98	34.89	74.00	-39.11	H
Average Measurement:						
Frequency (MHz)	Reading Level (dB μ V)	Factor (dB)	Emission Level (dB μ V/m)	Limits (dB μ V/m)	Margin (dB)	Antenna polarization
2400.00	27.42	-5.70	21.72	54.00	-32.28	V
2483.50	30.32	-4.98	25.34	54.00	-28.66	V
2400.00	28.01	-5.70	22.31	54.00	-31.69	H
2483.50	30.24	-4.98	25.26	54.00	-28.74	H

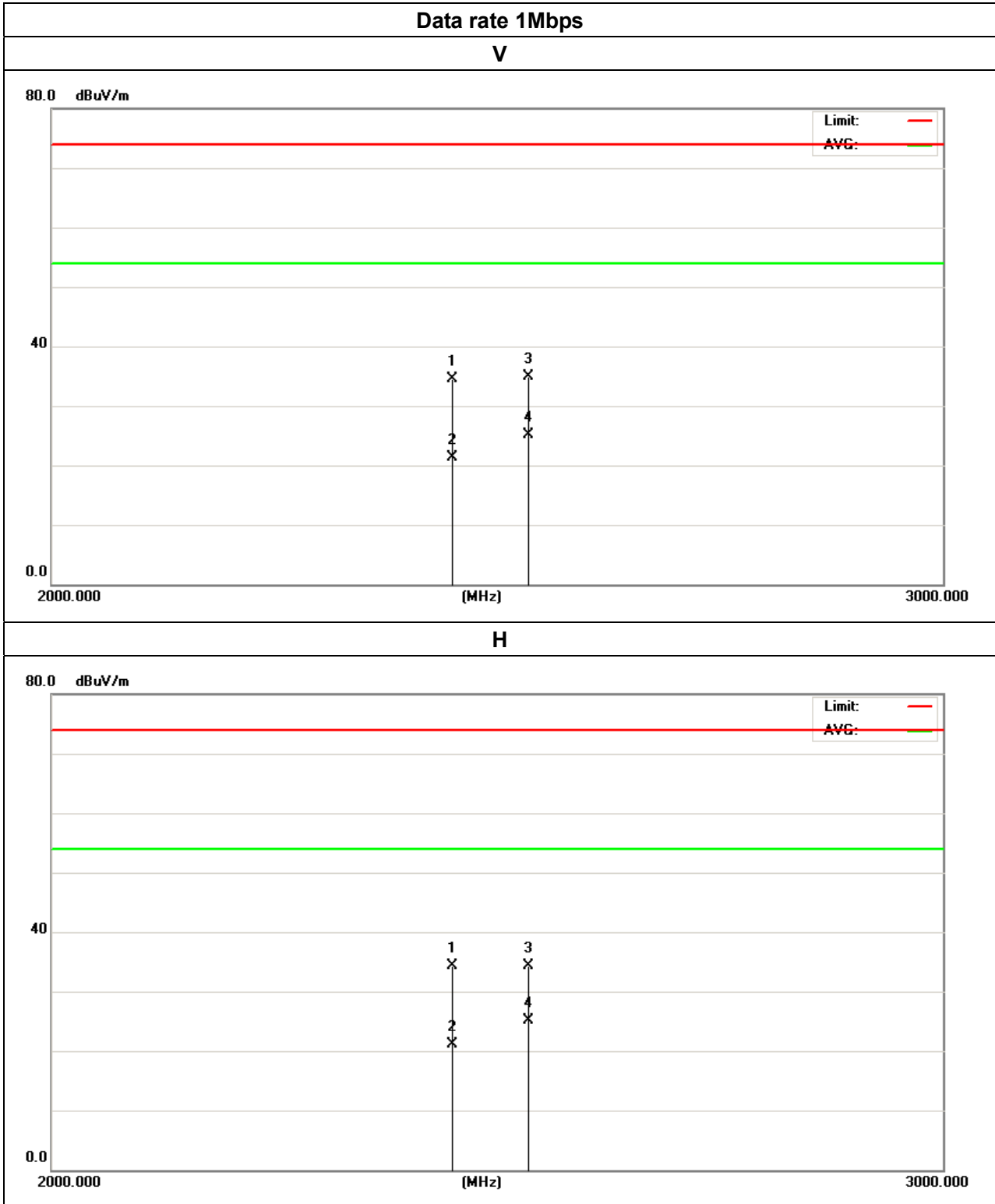

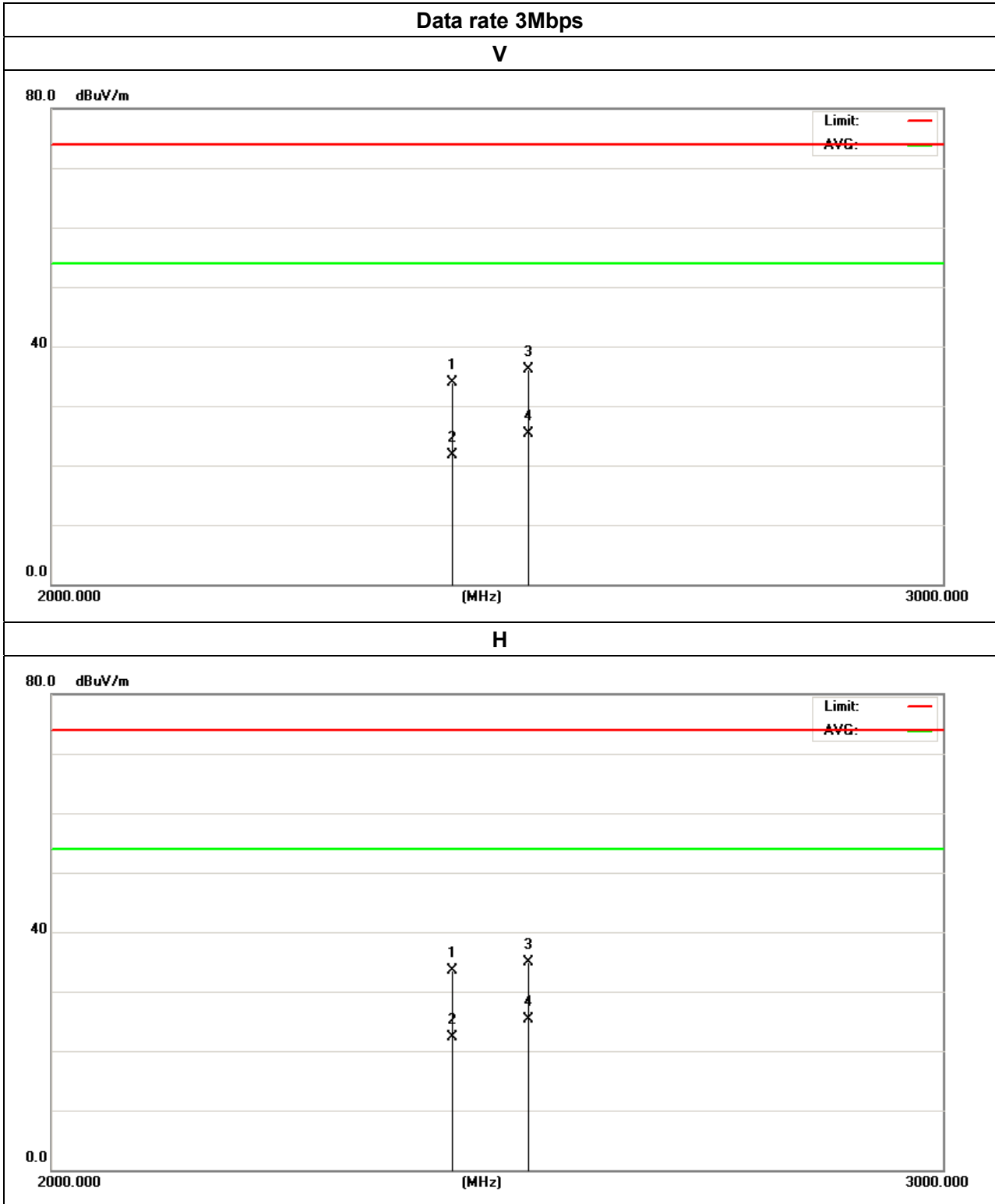

5.10 Conducted Spurious Emissions

5.10.1 Applied procedures / Limit

15.247(d) In any 100 kHz bandwidth outside the frequency band in which the spread spectrum or digitally modulated intentional radiator is operating, the radio frequency power that is produced by the intentional radiator shall be at least 20 dB below that in the 100 kHz bandwidth within the band that contains the highest level of the desired power, based on either an RF conducted or a radiated measurement, provided the transmitter demonstrates compliance with the peak conducted power limits. If the transmitter complies with the conducted power limits based on the use of RMS averaging over a time interval, as permitted under paragraph (b)(3) of this section, the attenuation required under this paragraph shall be 30 dB instead of 20 dB. Attenuation below the general limits specified in Section 15.209(a) is not required. In addition, radiated emissions which fall in the restricted bands, as defined in Section 15.205(a), must also comply with the radiated emission limits specified in Section 15.209(a) (see Section 15.205(c)).

5.10.2 Test procedure

- a. The EUT was directly connected to the spectrum analyzer and antenna output port as show in the block diagram below.
- b. Span = wide enough to capture the peak level of the in-band emission and all spurious emissions (e.g., harmonics) from the lowest frequency generated in the EUT up through the 10th harmonic. Typically, several plots are required to cover this entire span. RBW = 100 kHz
VBW \geq RBW, Sweep = auto, Detector function = peak, Trace = max hold
sweep points \geq investigated frequency range/RBW.

5.10.3 Deviation from standard

No deviation.

5.10.4 Test setup



5.10.5 Test results

CH00 Data rate 1Mbps 30MHz to 25GHz

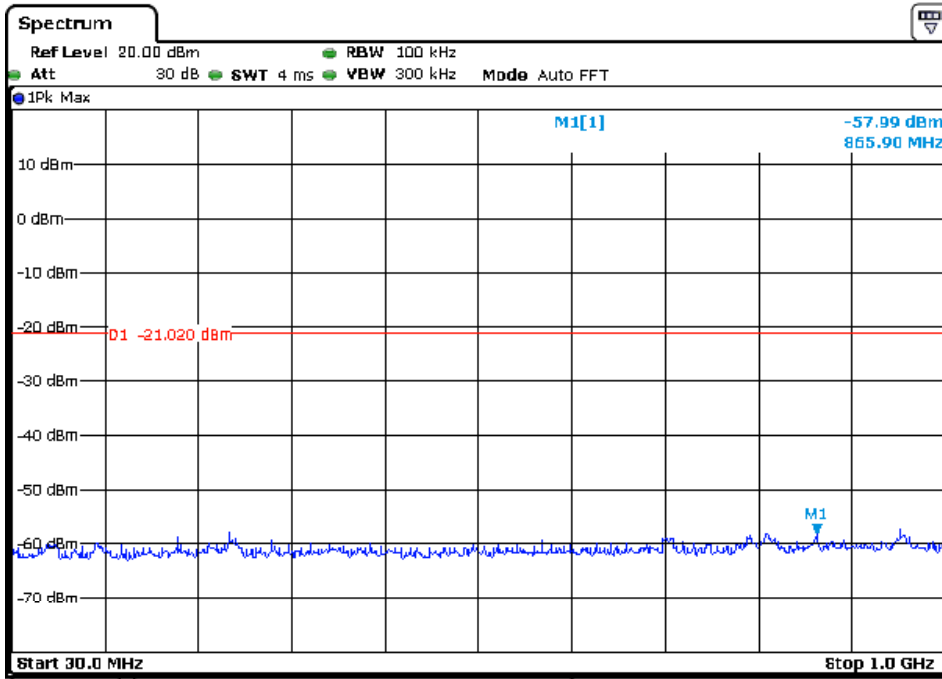

Note: Sweep Points=9700

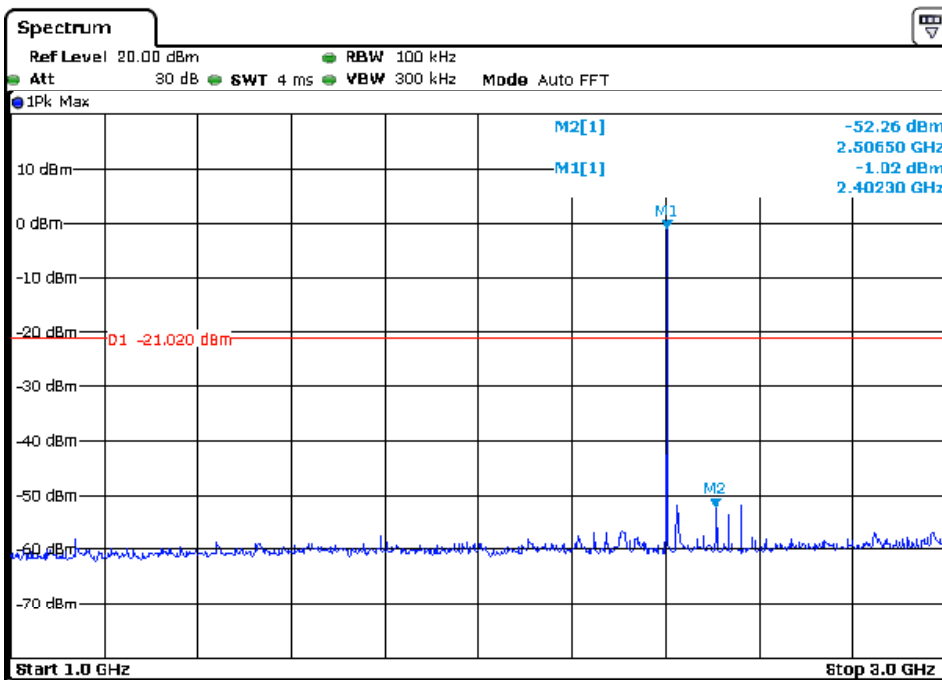

Note: Sweep Points=20000

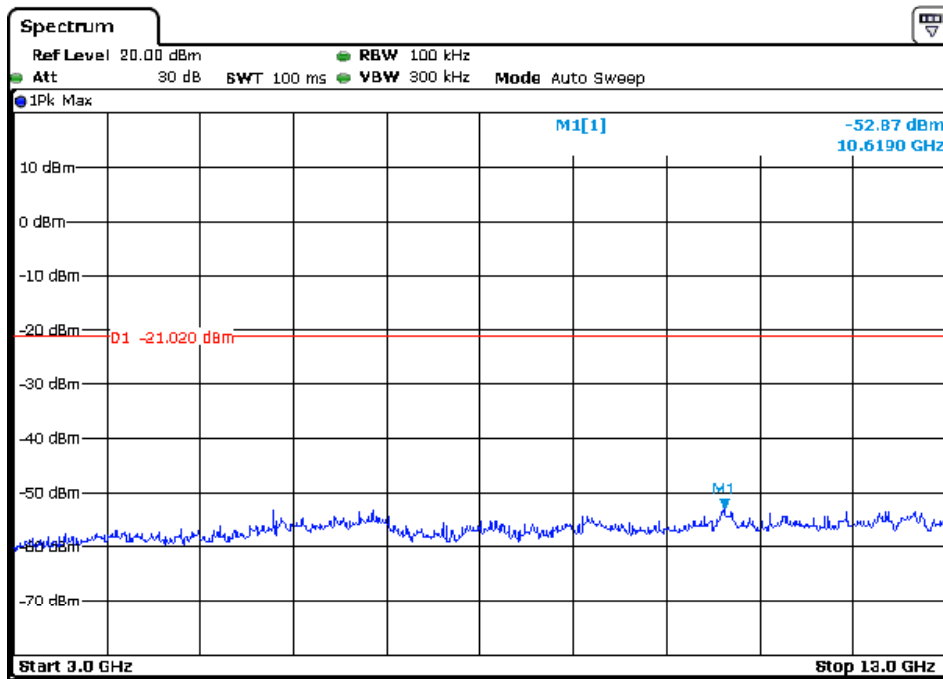

Note: Sweep Points=100000

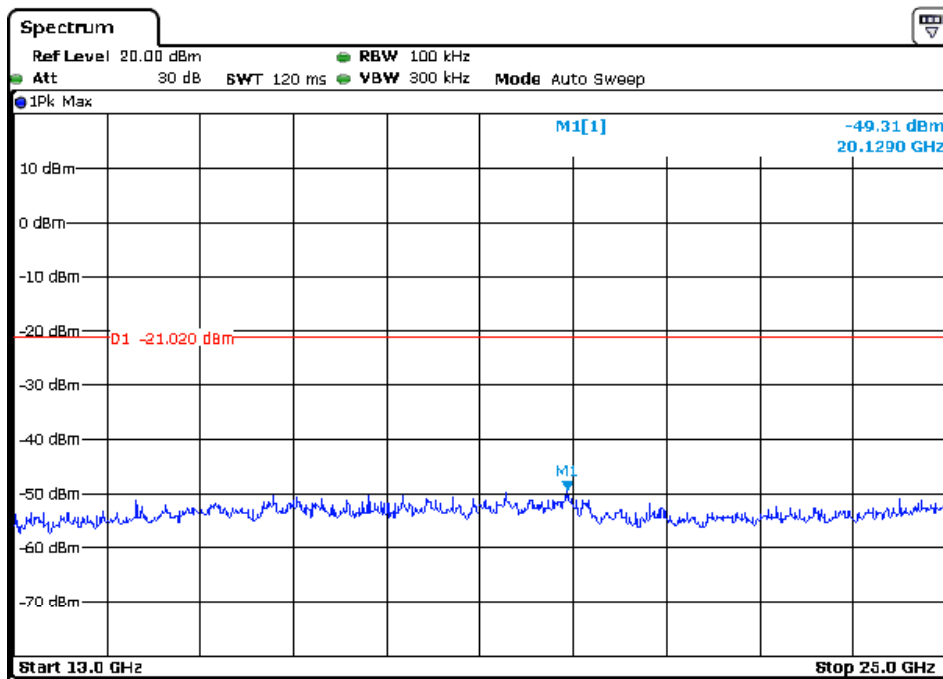

Note: Sweep Points=120000

CH39 Data rate 1Mbps 30MHz to 25GHz

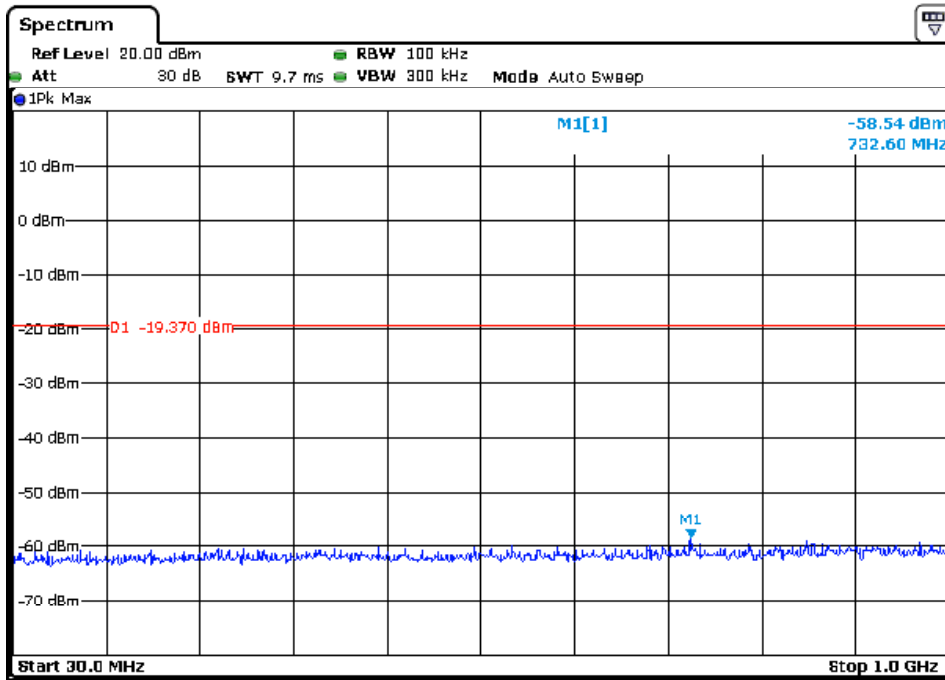

Note: Sweep Points=9700

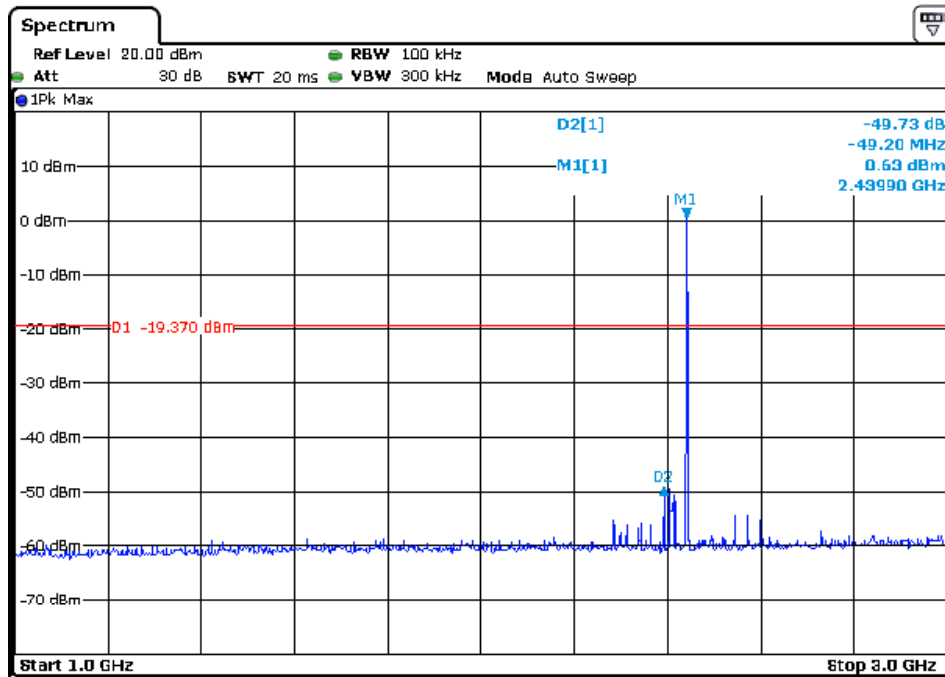

Note: Sweep Points=20000

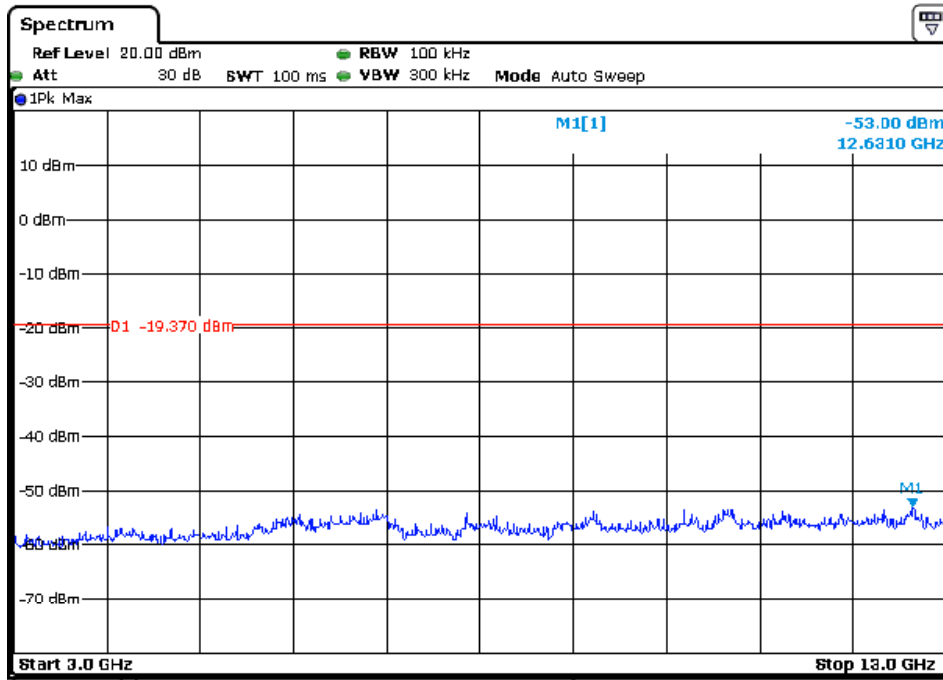

Note: Sweep Points=100000

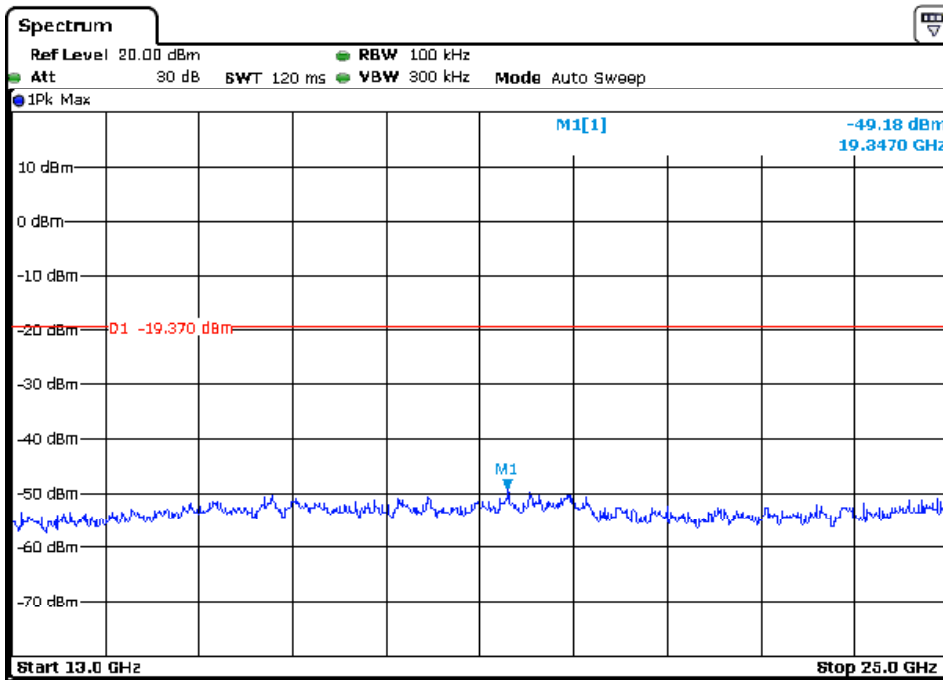

Note: Sweep Points=120000

CH78 Data rate 1Mbps 30MHz to 25GHz

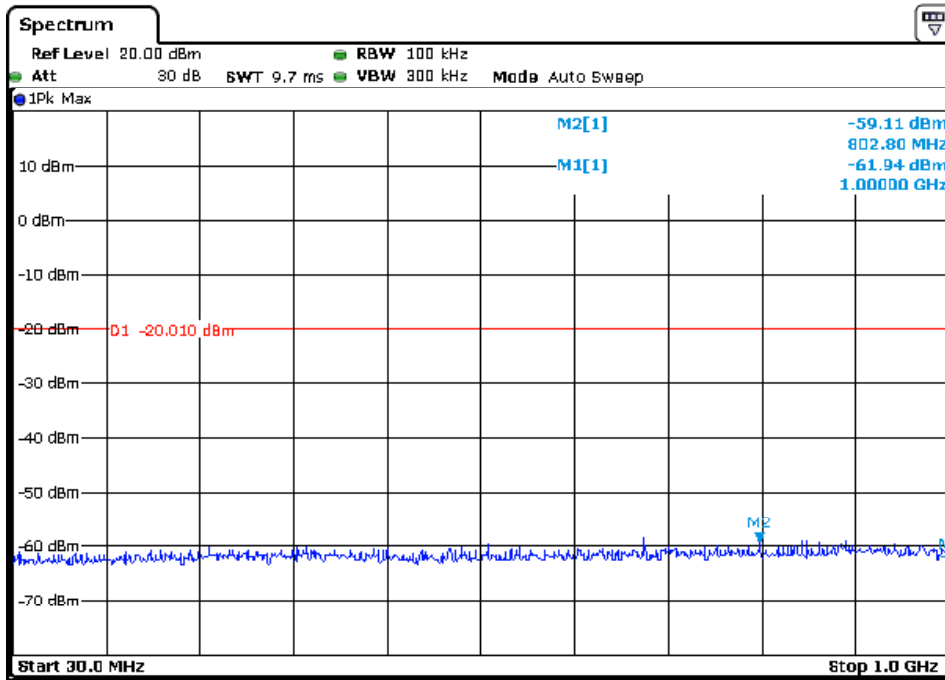

Note: Sweep Points=9700

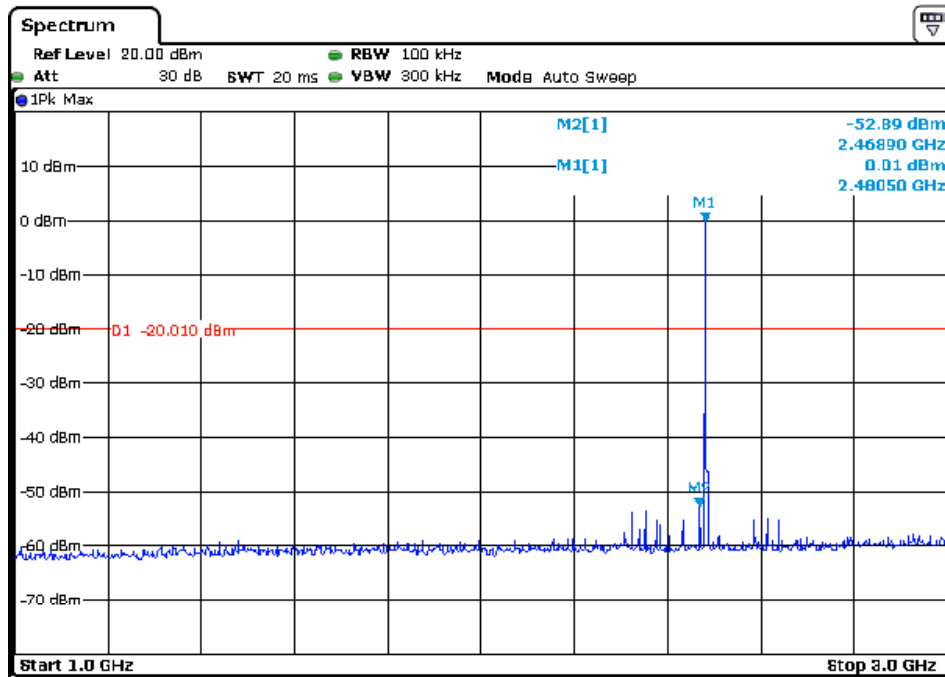

Note: Sweep Points=20000

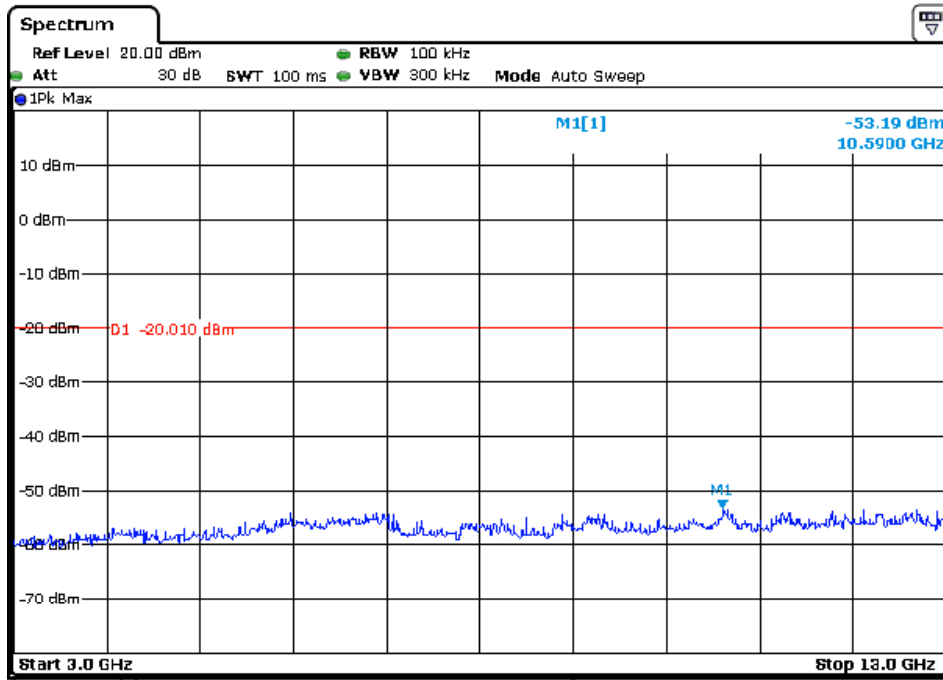

Note: Sweep Points=100000

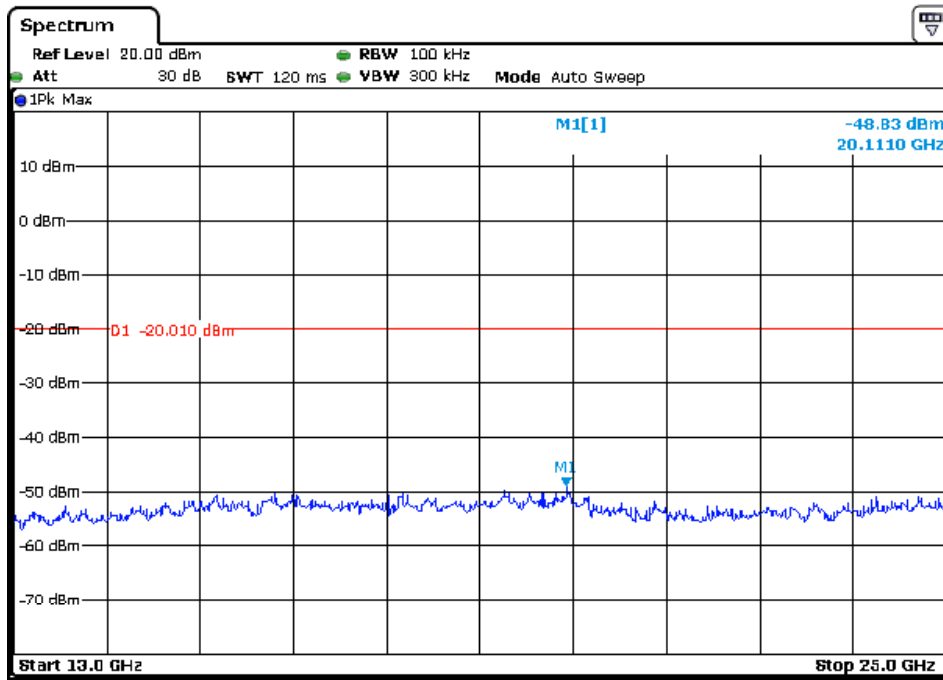

Note: Sweep Points=120000

CH00 Data rate 3Mbps 30MHz to 25GHz

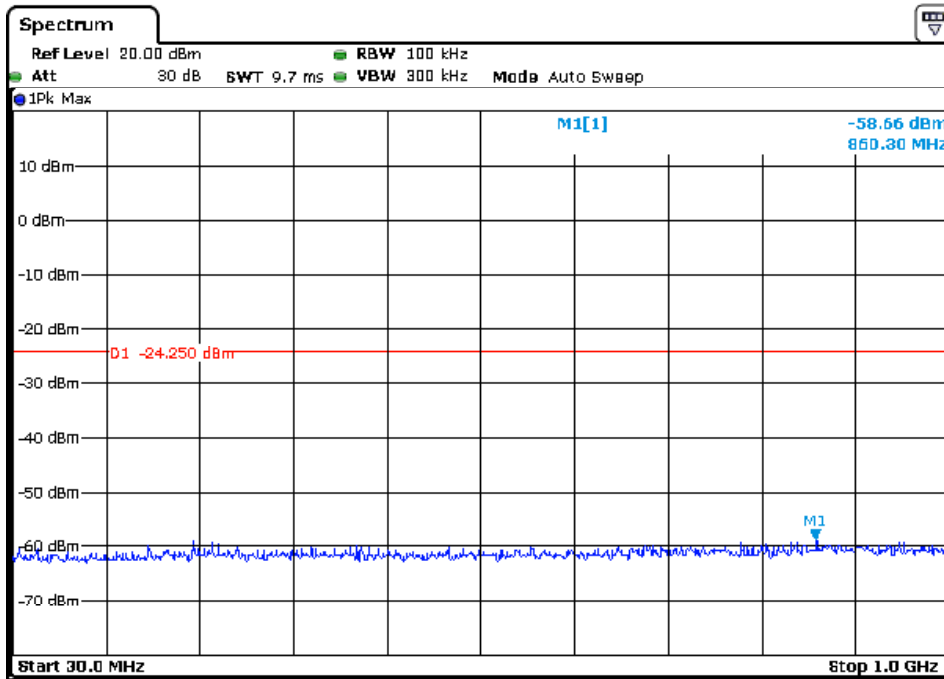

Note: Sweep Points=9700

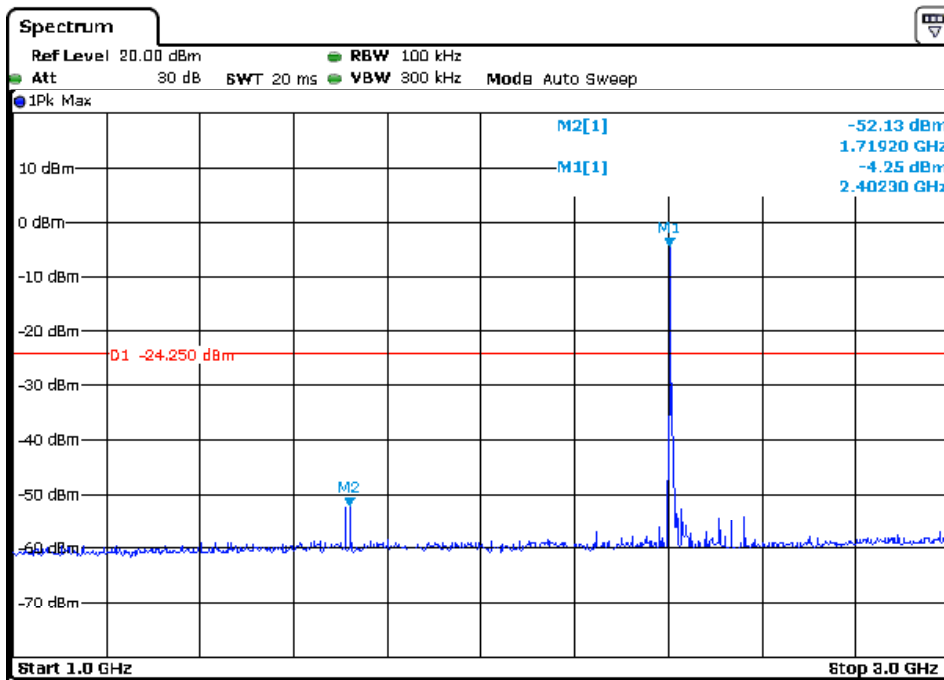

Note: Sweep Points=20000

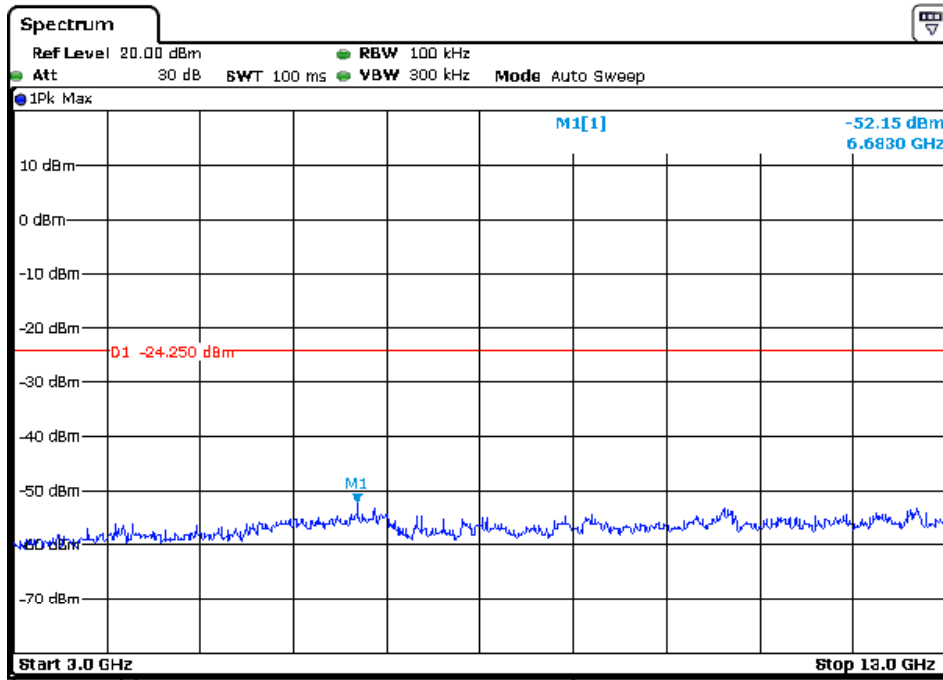

Note: Sweep Points=100000

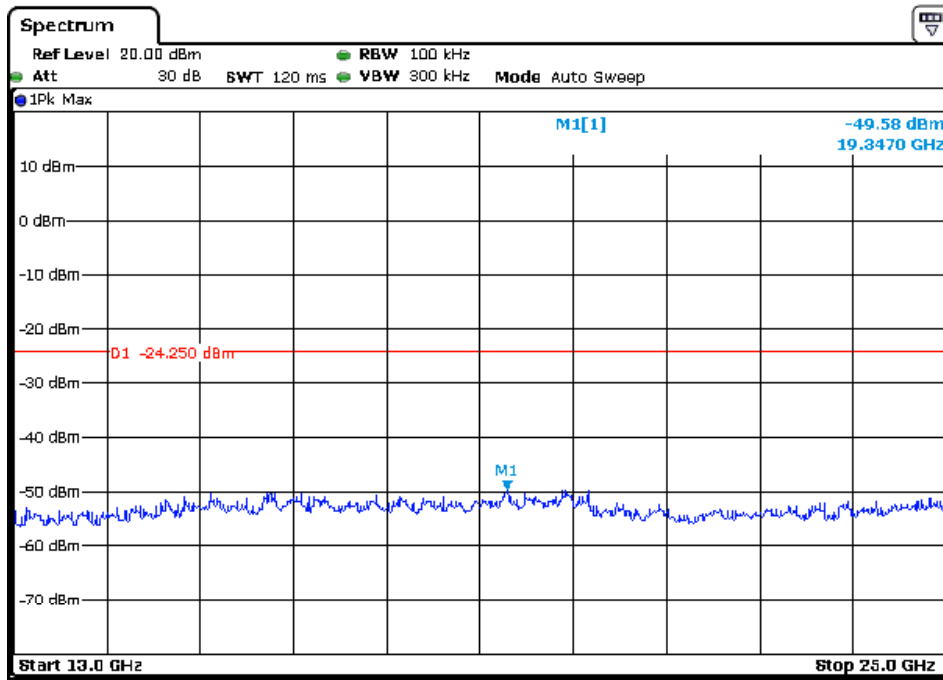

Note: Sweep Points=120000

CH39 Data rate 3Mbps 30MHz to 25GHz

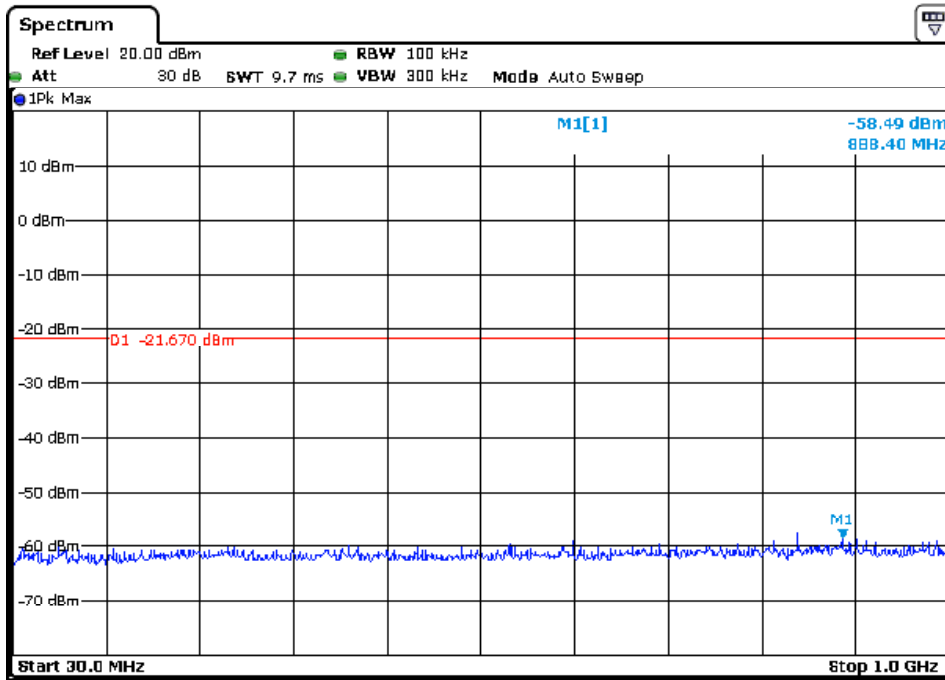

Note: Sweep Points=9700

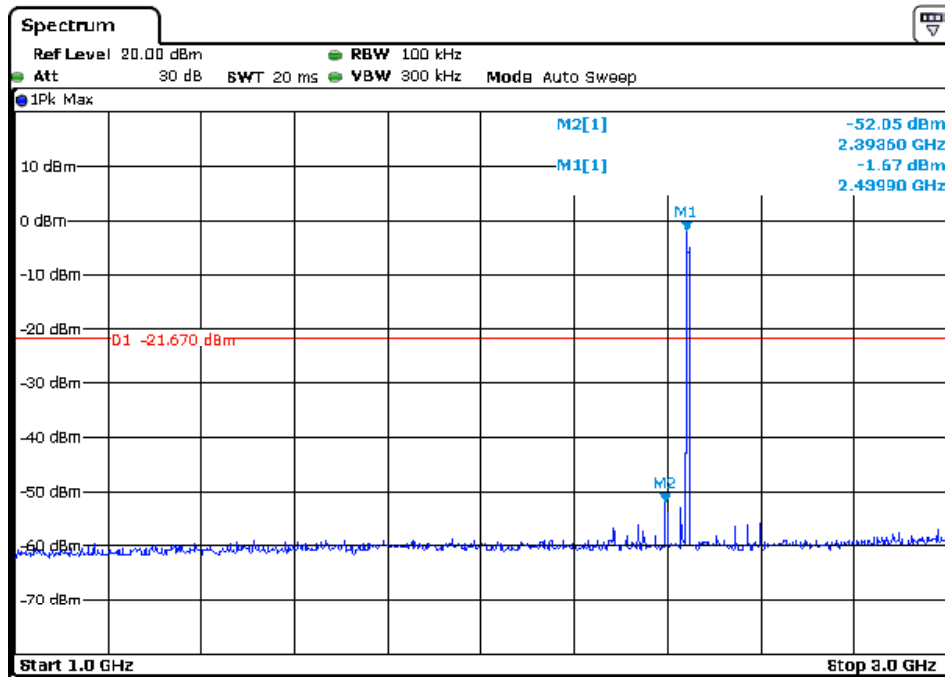

Note: Sweep Points=20000

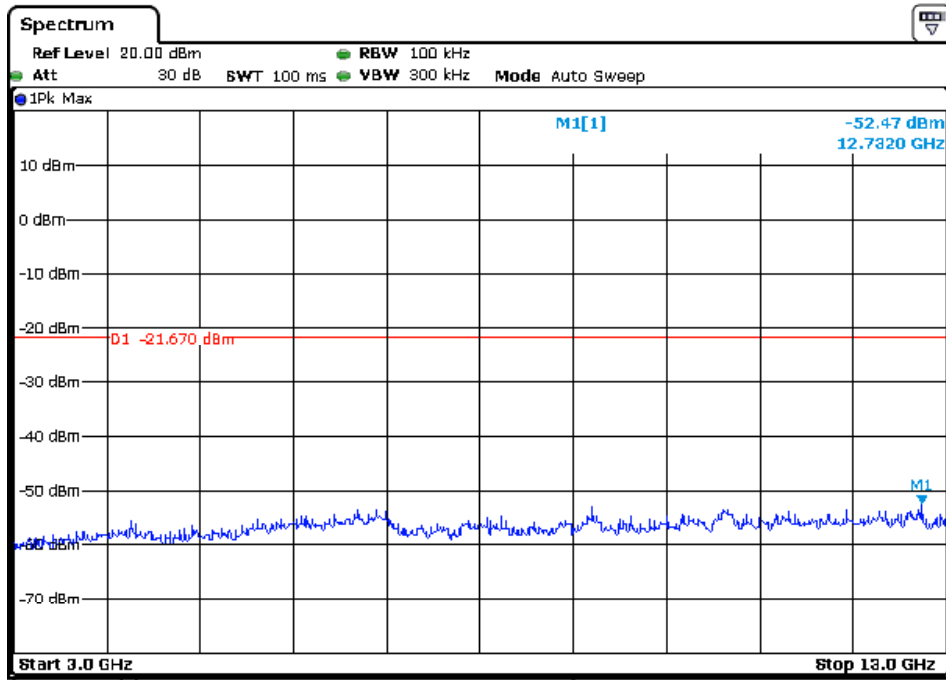

Note: Sweep Points=100000

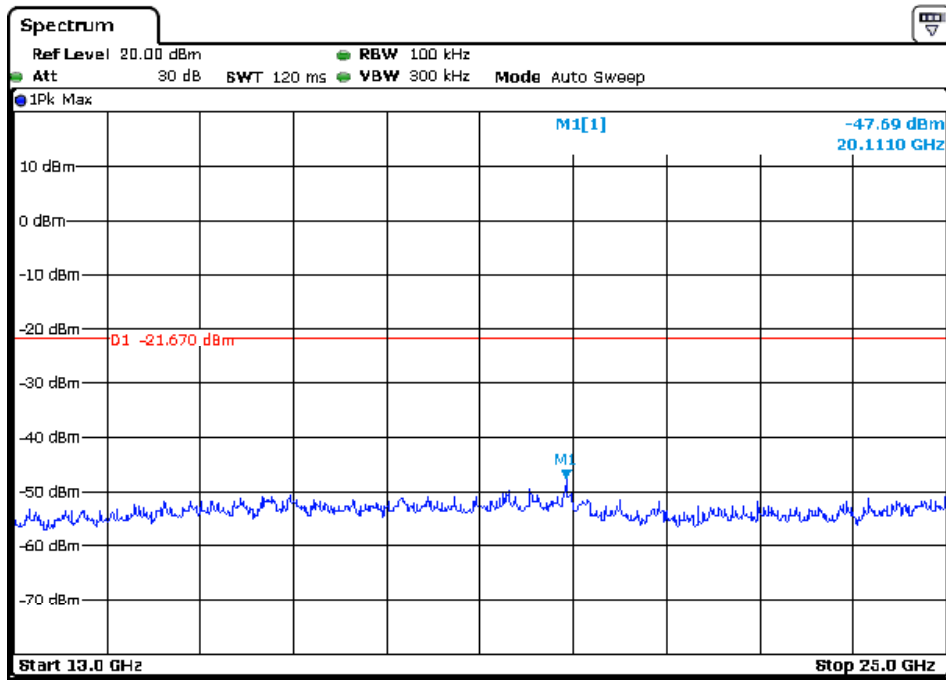

Note: Sweep Points=120000

CH78 Data rate 3Mbps 30MHz to 25GHz

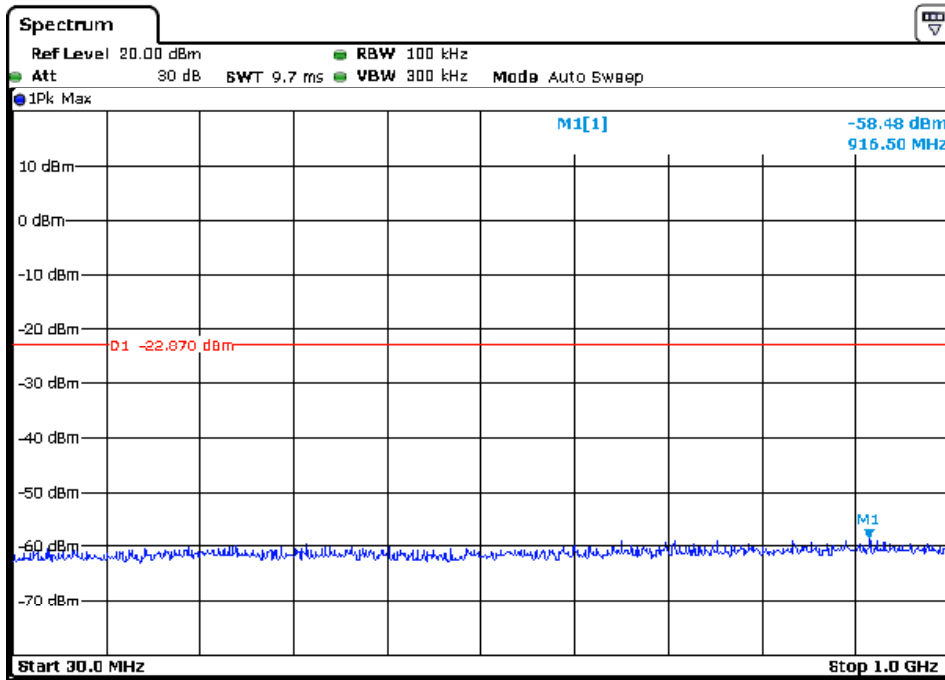

Note: Sweep Points=9700

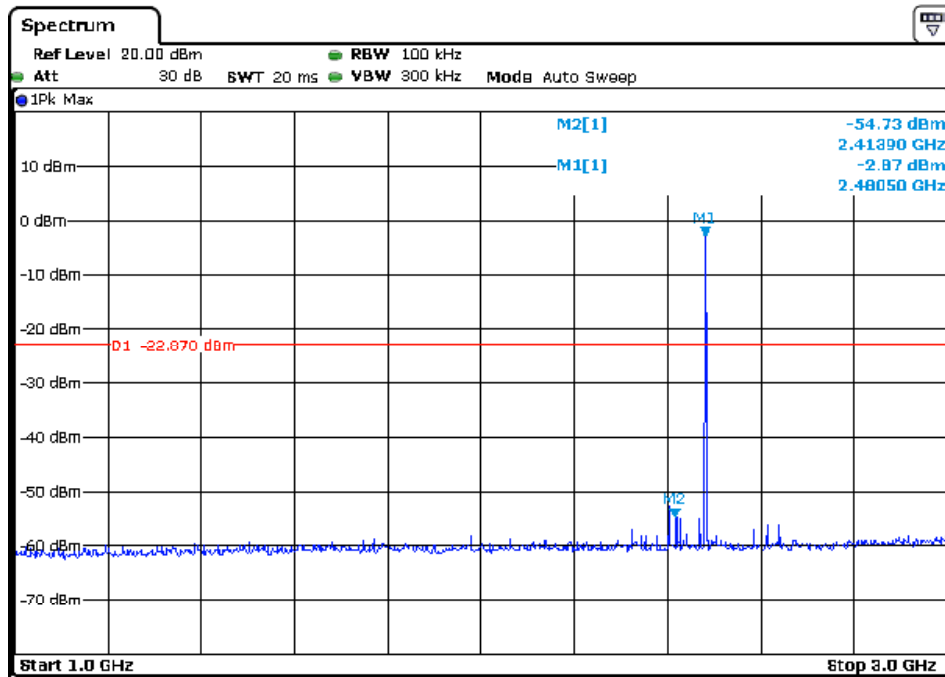

Note: Sweep Points=20000

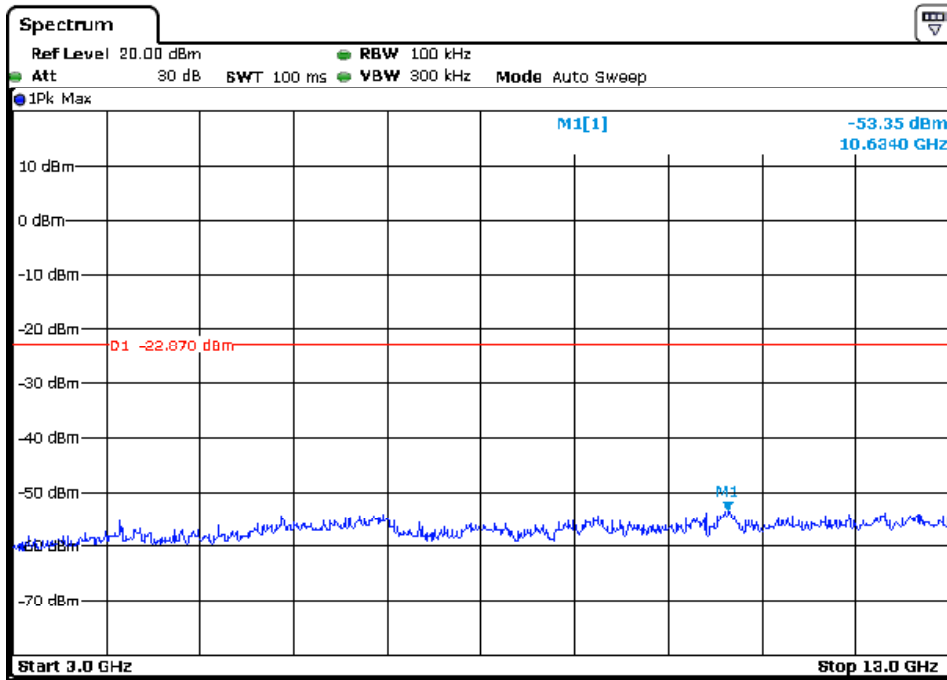

Note: Sweep Points=100000

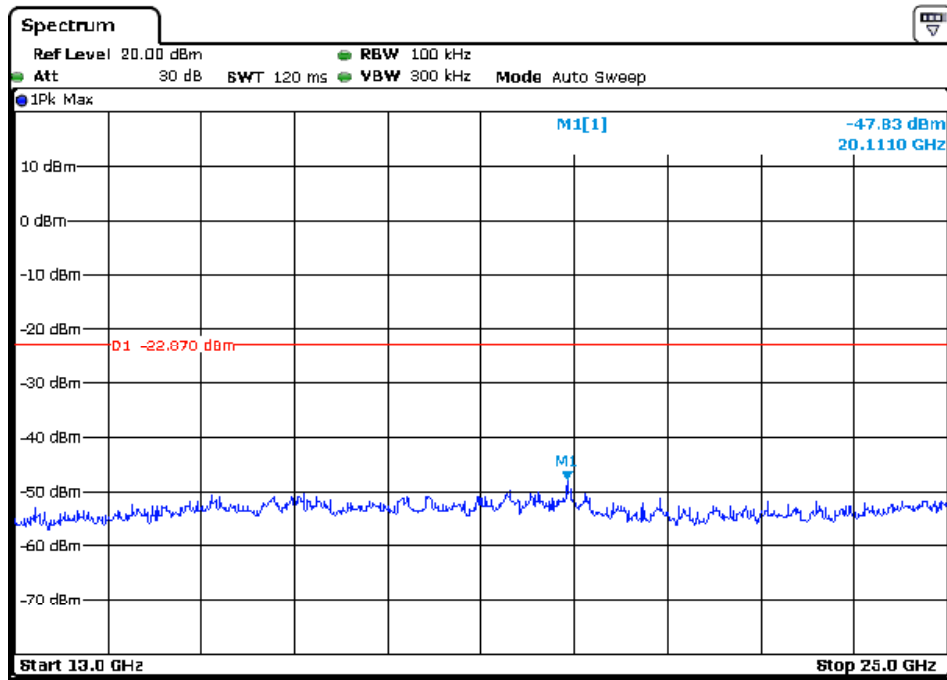

Note: Sweep Points=120000

6 Photographs

6.1 Conducted emissions Test Setup



6.2 Radiated spurious emissions Test Setup(below 1GHz)

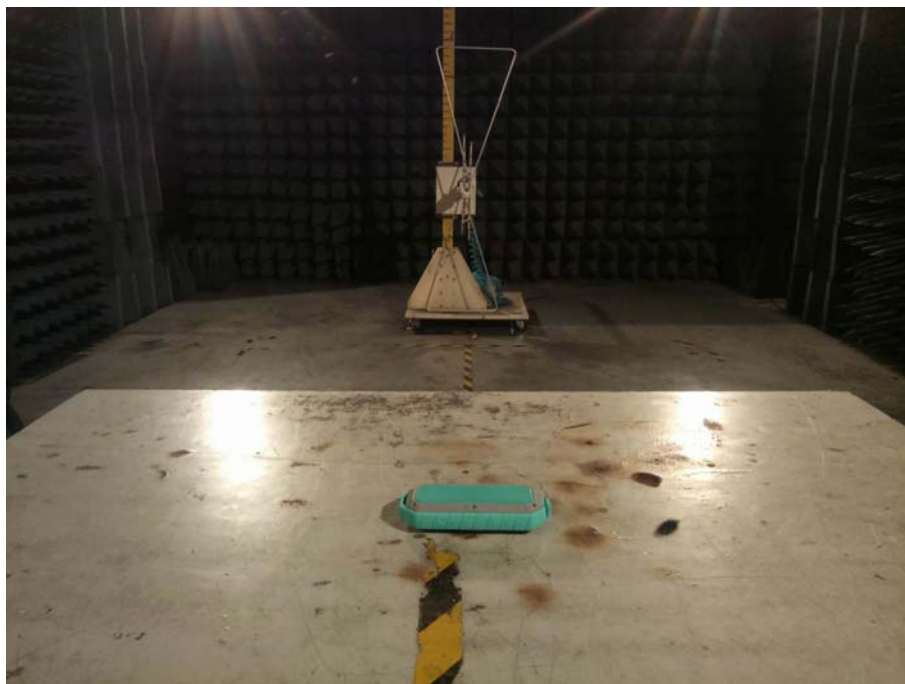

6.3 Radiated spurious emissions Test Setup(above 1GHz)

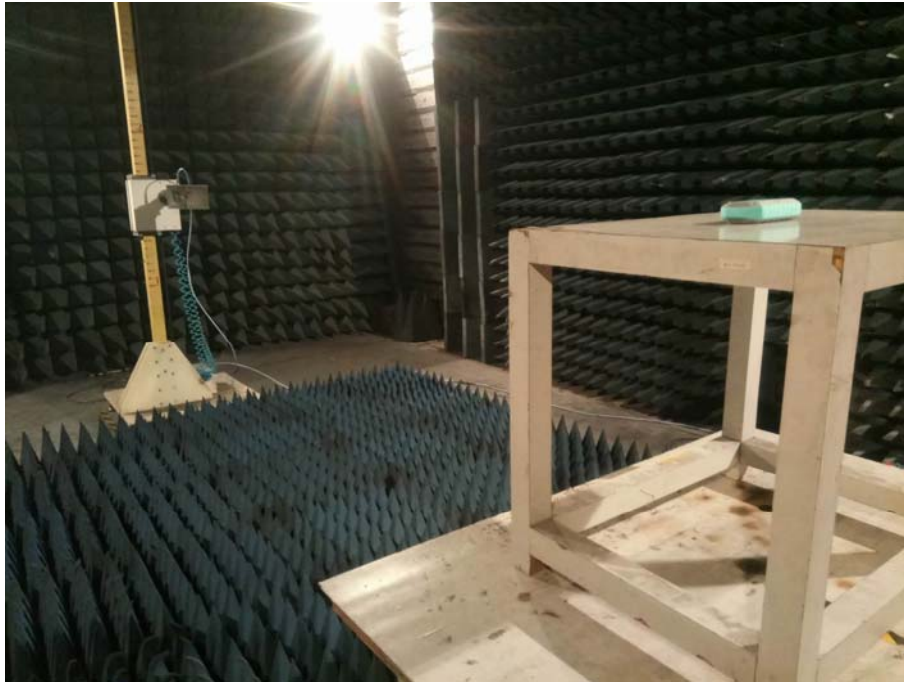

6.4 EUT Constructional Details

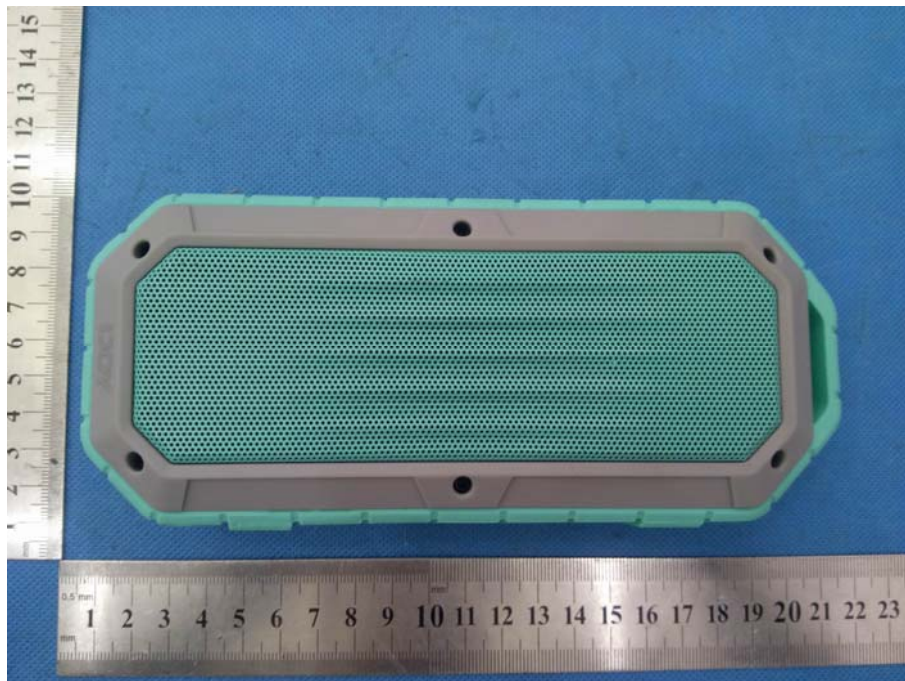



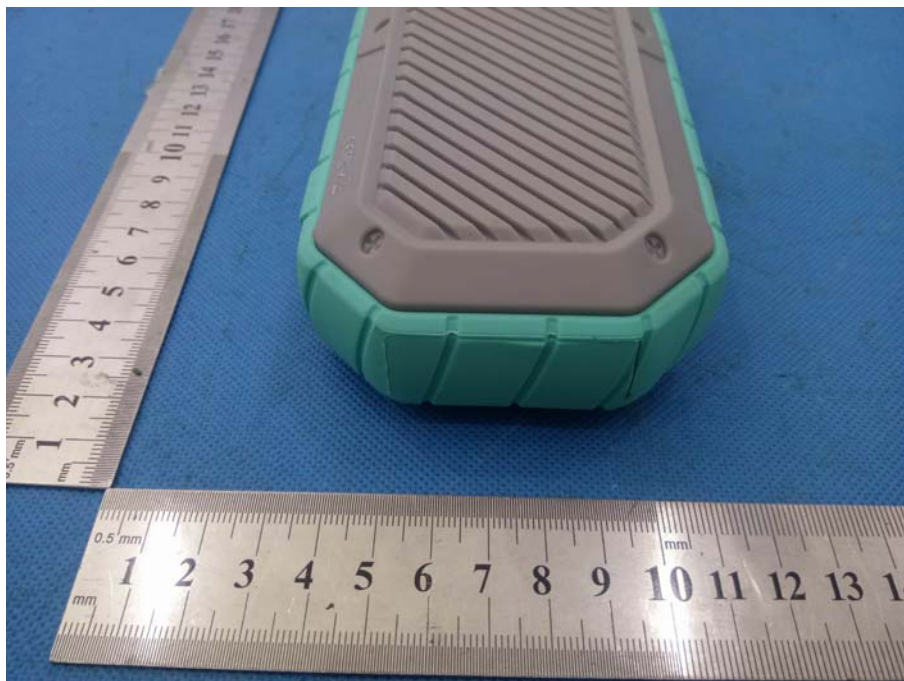

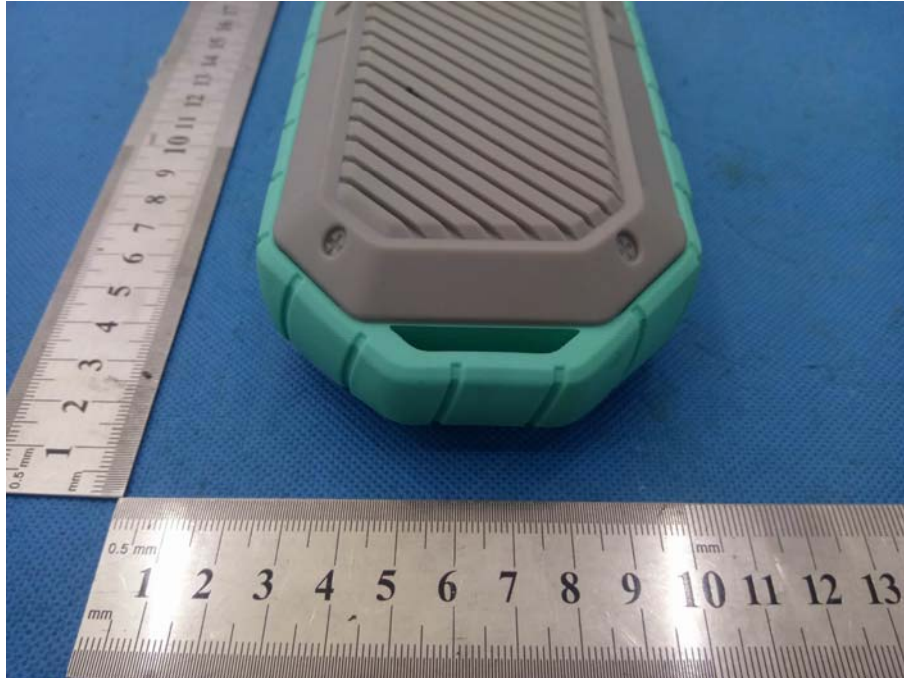

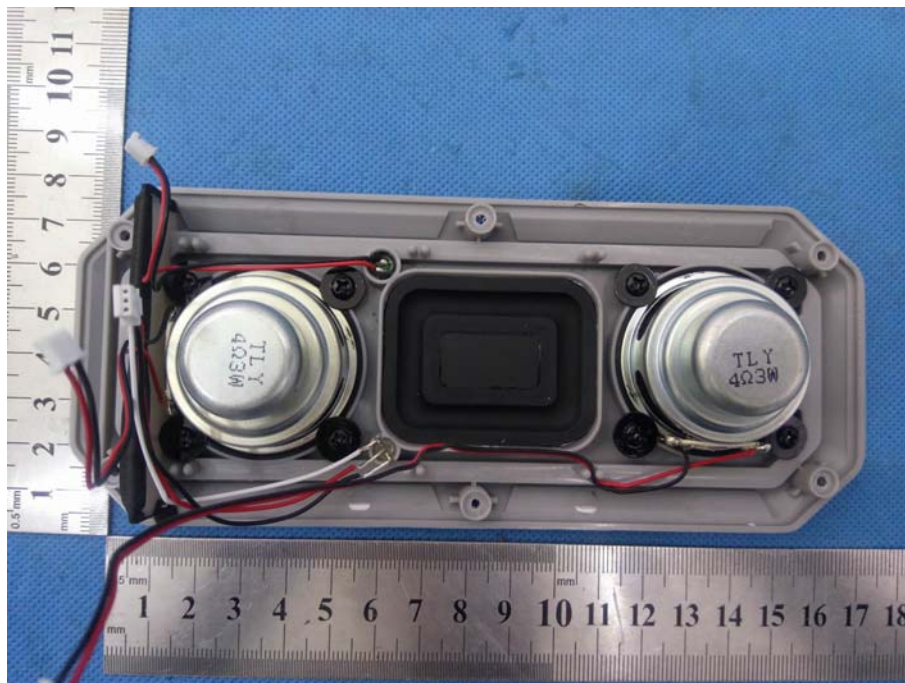
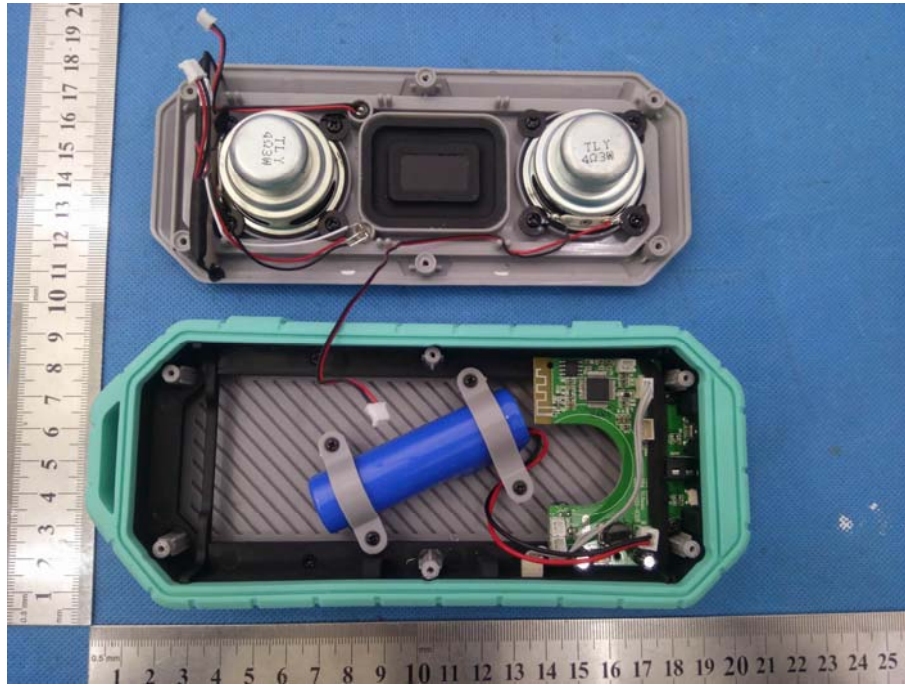

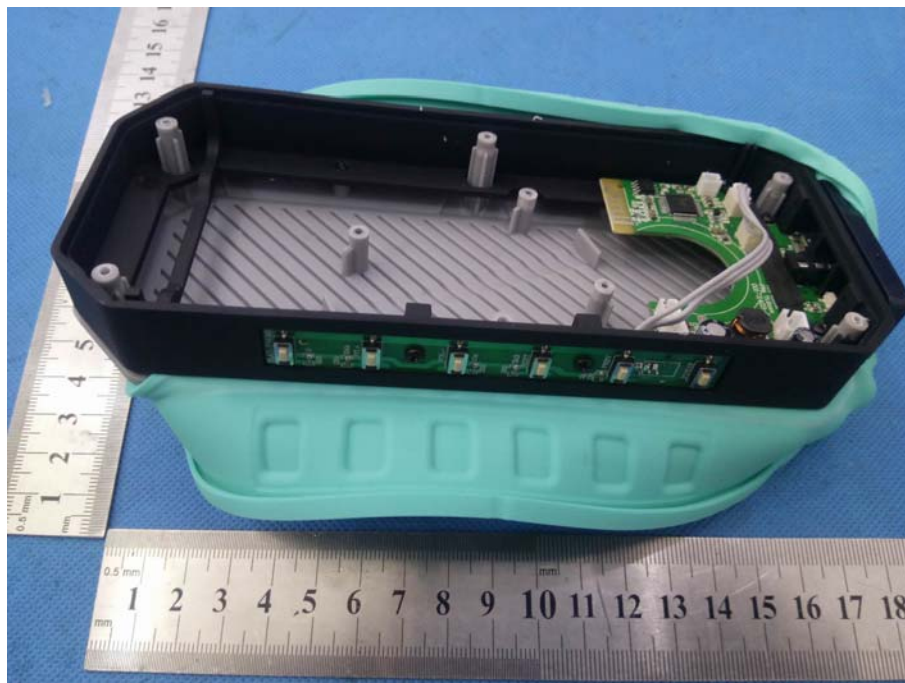

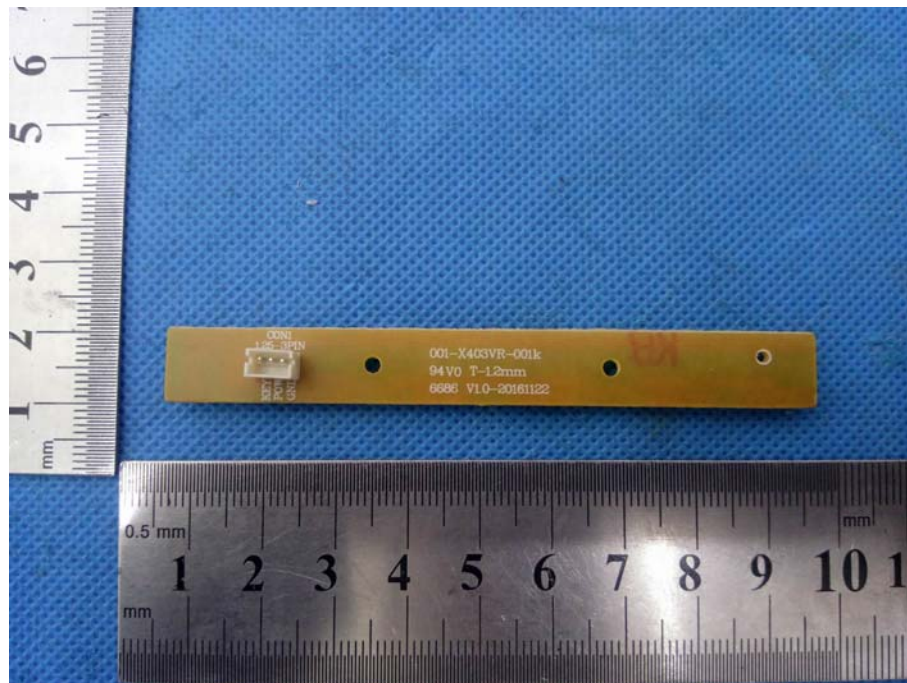
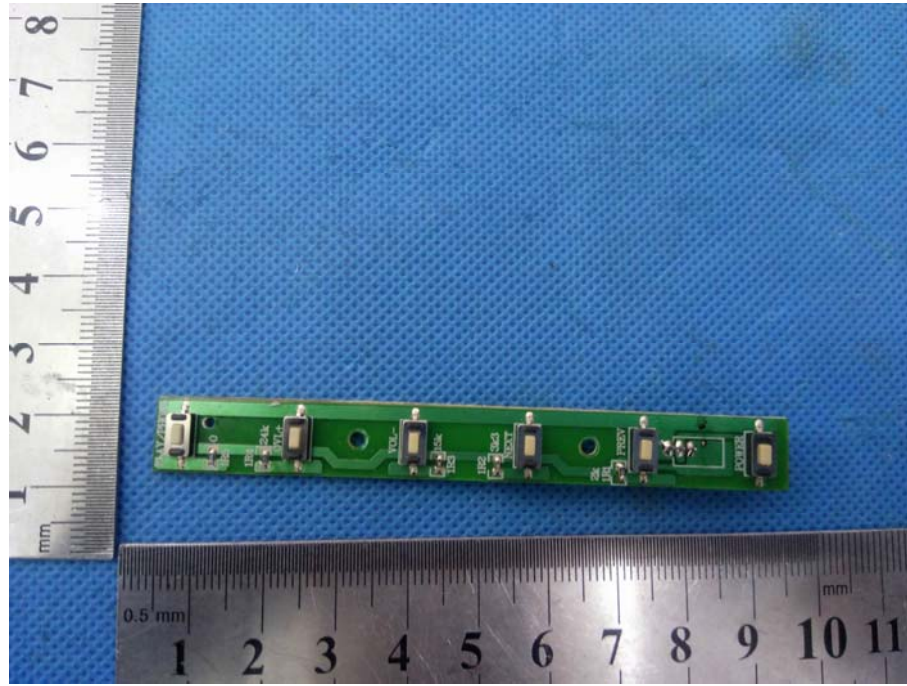

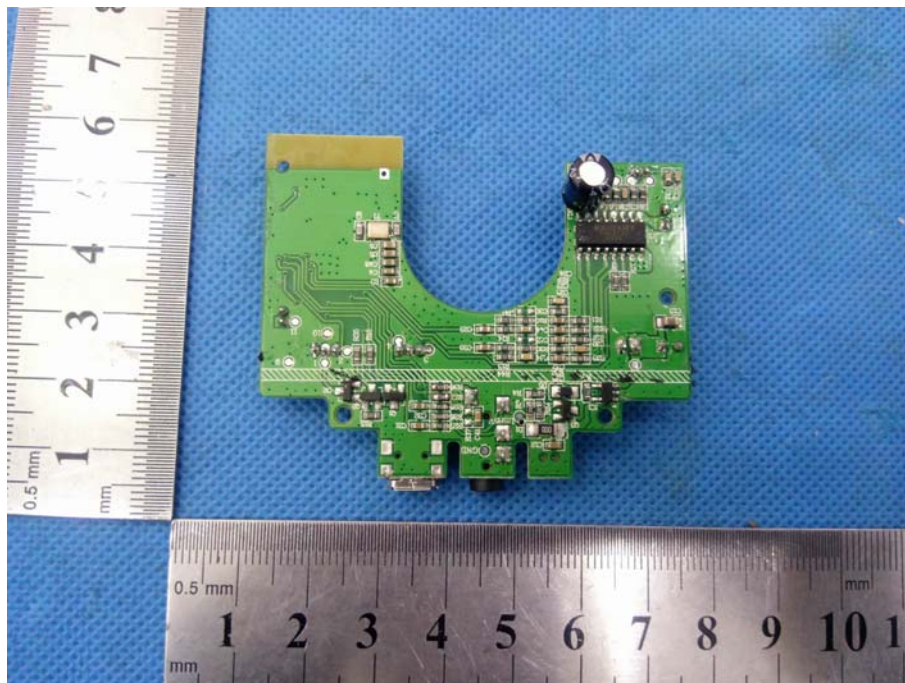
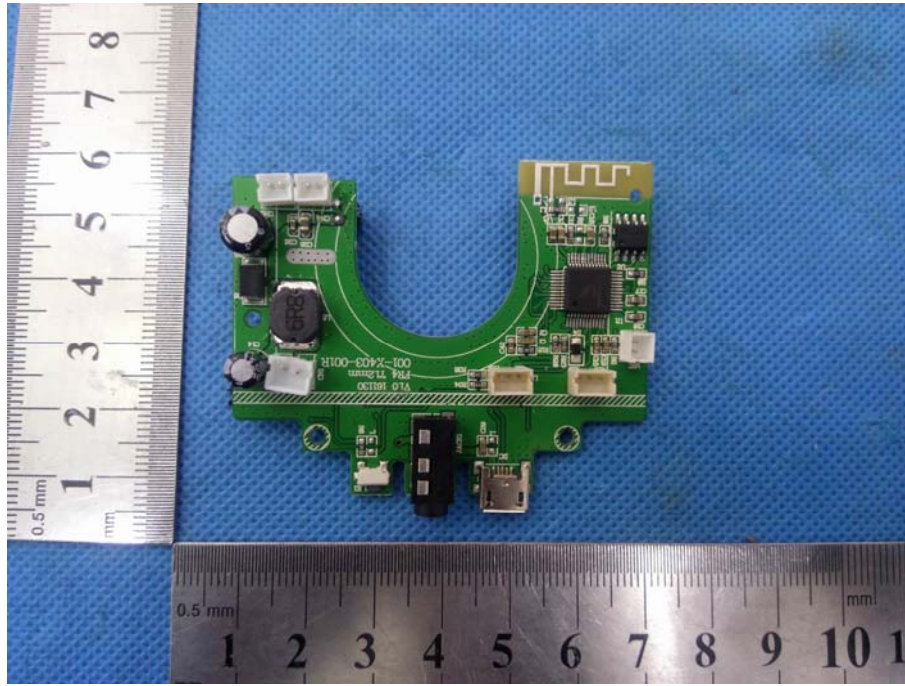

****End of report****