

FCC RADIO TEST REPORT

FCC ID: 2AAQFSPB60

Product : Bluetooth speaker

Trade Name : Merkury

Model Name : SPB60

Serial Model : BT-2008

Prepared for

China Electronics Shenzhen Company
F35/F., Electronics Science& Technology Building, Shennan Zhong
Road,Shenzhen, China

Prepared by

Shenzhen STONE Testing Technology Co.,Ltd.
F/6, Bldg.12, Zhongxing Industrial City, Chuangye Rd., Nanshan District
Shenzhen P.R. China

TEST RESULT CERTIFICATION

Applicant's name : China Electronics Shenzhen Company
 Address : F35/F., Electronics Science& Technology Building, Shennan
 Zhong Road,Shenzhen, China

Manufacture's Name..... : China Electronics Shenzhen Company
 Address : F35/F., Electronics Science& Technology Building, Shennan
 Zhong Road,Shenzhen, China

Product description

Product name : Bluetooth speaker
 Model and/or type reference : SPB60
 Serial Model : BT-2008

Standards : FCC Part15.247

Test procedure ANSI C63.4-2003

This device described above has been tested by STT, and the test results show that the equipment under test (EUT) is in compliance with the FCC requirements. And it is applicable only to the tested sample identified in the report.

This report shall not be reproduced except in full, without the written approval of STT, this document may be altered or revised by STT, personal only, and shall be noted in the revision of the document.

Date of Test :
 Date (s) of performance of tests : 15 Oct. 2013 ~25 Oct. 2013
 Date of Issue..... : 25 Oct. 2013
 Test Result..... : **Pass**

Testing Engineer : Eric Wang
 (Eric Wang)

Technical Manager : Jerry You
 (Jerry You)

Authorized Signatory : Jack Yu
 (Jack Yu)

Table of Contents

	Page
1 . SUMMARY OF TEST RESULTS	5
1.1 TEST FACILITY	6
1.2 MEASUREMENT UNCERTAINTY	6
2 . GENERAL INFORMATION	7
2.1 GENERAL DESCRIPTION OF EUT	7
2.2 DESCRIPTION OF TEST MODES	9
2.3 TABLE OF PARAMETERS OF TEXT SOFTWARE SETTING	9
2.4 BLOCK DIGRAM SHOWING THE CONFIGURATION OF SYSTEM TESTED	10
2.5 DESCRIPTION OF SUPPORT UNITS(CONDUCTED MODE)	11
2.6 EQUIPMENTS LIST FOR ALL TEST ITEMS	12
3 . EMC EMISSION TEST	13
3.1 CONDUCTED EMISSION MEASUREMENT	13
3.1.1 POWER LINE CONDUCTED EMISSION LIMITS	13
3.1.2 TEST PROCEDURE	14
3.1.3 DEVIATION FROM TEST STANDARD	14
3.1.4 TEST SETUP	14
3.1.5 EUT OPERATING CONDITIONS	14
3.1.6 TEST RESULTS	15
3.2 RADIATED EMISSION MEASUREMENT	17
3.2.1 RADIATED EMISSION LIMITS	17
3.2.2 TEST PROCEDURE	18
3.2.3 DEVIATION FROM TEST STANDARD	18
3.2.4 TEST SETUP	19
3.2.5 EUT OPERATING CONDITIONS	20
3.2.6 TEST RESULTS (BELOW 30 MHZ)	21
3.2.7 TEST RESULTS (BETWEEN 30M – 1000 MHZ)	22
3.2.8 TEST RESULTS (ABOVE 1000 MHZ)	23
4 . NUMBER OF HOPPING CHANNEL	33
4.1 APPLIED PROCEDURES / LIMIT	33
4.1.1 TEST PROCEDURE	33
4.1.2 DEVIATION FROM STANDARD	33
4.1.3 TEST SETUP	33
4.1.4 EUT OPERATION CONDITIONS	33
4.1.5 TEST RESULTS	34
5 . AVERAGE TIME OF OCCUPANCY	36
5.1 APPLIED PROCEDURES / LIMIT	36

Table of Contents

	Page
5.1.1 TEST PROCEDURE	36
5.1.2 DEVIATION FROM STANDARD	36
5.1.3 TEST SETUP	37
5.1.4 EUT OPERATION CONDITIONS	37
5.1.5 TEST RESULTS	38
6 . HOPPING CHANNEL SEPARATION MEASUREMENT	44
6.1 APPLIED PROCEDURES / LIMIT	44
6.1.1 TEST PROCEDURE	44
6.1.2 DEVIATION FROM STANDARD	44
6.1.3 TEST SETUP	44
6.1.4 EUT OPERATION CONDITIONS	44
6.1.5 TEST RESULTS	45
7 . BANDWIDTH TEST	51
7.1 APPLIED PROCEDURES / LIMIT	51
7.1.1 TEST PROCEDURE	51
7.1.2 DEVIATION FROM STANDARD	51
7.1.3 TEST SETUP	51
7.1.4 EUT OPERATION CONDITIONS	51
7.1.5 TEST RESULTS	52
8 . PEAK OUTPUT POWER TEST	58
8.1 APPLIED PROCEDURES / LIMIT	58
8.1.1 TEST PROCEDURE	58
8.1.2 DEVIATION FROM STANDARD	58
8.1.3 TEST SETUP	58
8.1.4 EUT OPERATION CONDITIONS	58
8.1.5 TEST RESULTS	59
9 . 100 KHZ BANDWIDTH OF FREQUENCY BAND EDGE	65
9.1 DEVIATION FROM STANDARD	65
9.2 TEST SETUP	65
9.3 EUT OPERATION CONDITIONS	65
9.4 TEST RESULTS	66
10 . ANTENNA REQUIREMENT	74
10.1 STANDARD REQUIREMENT	74
10.2 EUT ANTENNA	74
11 . EUT TEST PHOTO	75
APPENDIX-PHOTOGRAPHS OF EUT CONSTRUCTIONAL DETAILS	

1. SUMMARY OF TEST RESULTS

Test procedures according to the technical standards:

FCC Part15 (15.247) , Subpart C			
Standard Section	Test Item	Judgment	Remark
15.207	Conducted Emission	PASS	
15.247(a)(1)	Hopping Channel Separation	PASS	
15.247(b)(1)	Peak Output Power	PASS	
15.247(c)	Radiated Spurious Emission	PASS	
15.247(a)(iii)	Number of Hopping Frequency	PASS	
15.247(a)(iii)	Dwell Time	PASS	
15.247(a)(1)	Bandwidth	PASS	
15.205	Band Edge Emission	PASS	
15.203	Antenna Requirement	PASS	

NOTE:

(1) "N/A" denotes test is not applicable in this Test Report

1.1 TEST FACILITY

Shenzhen STONE Testing Technology Co.,Ltd.

Add. : F/1, Bldg.12, Zhongxing Industrial City, Chuangye Rd., Nanshan District
Shenzhen China

FCC Registration No.: 323508; IC Registration No.: 11043A

1.2 MEASUREMENT UNCERTAINTY

The reported uncertainty of measurement $y \pm U$, where expanded uncertainty U is based on a standard uncertainty multiplied by a coverage factor of $k=2$, providing a level of confidence of approximately **95 %**.

No.	Item	Uncertainty
1	Conducted Emission Test	$\pm 1.38\text{dB}$
2	RF power,conducted	$\pm 0.16\text{dB}$
3	Spurious emissions,conducted	$\pm 0.21\text{dB}$
4	All emissions,radiated(<1G)	$\pm 4.68\text{dB}$
5	All emissions,radiated(>1G)	$\pm 4.89\text{dB}$
6	Temperature	$\pm 0.5^{\circ}\text{C}$
7	Humidity	$\pm 2\%$

2. GENERAL INFORMATION

2.1 GENERAL DESCRIPTION OF EUT

Equipment	Bluetooth speaker	
Trade Name	Merkury	
Model Name	SPB60	
Serial Model	BT-2008	
Model Difference	All models are identical except model names.	
Product Description	The EUT is a Bluetooth speaker	
	Operation Frequency:	2402~2480 MHz
	Modulation Type:	BT(1Mbps): GFSK BT EDR(2Mbps): $\pi/4$ -DQPSK BT EDR(3Mbps): 8-DPSK
	Bit Rate of Transmitter	1Mbps/2Mbps/3Mbps
	Number Of Channel	79 CH
	Antenna Designation:	Please see Note 3.
	Output Power(Conducted):	BT(1Mbps): 1.841dBm BT EDR(2Mbps): 1.515dBm BT EDR(3Mbps):1.860dBm
	Based on the application, features, or specification exhibited in User's Manual, the EUT is considered as an ITE/Computing Device. More details of EUT technical specification, please refer to the User's Manual.	
Channel List	Please refer to the Note 2.	
Adapter	N/A	
Battery	DC 3.7V	
Connecting I/O Port(s)	Please refer to the User's Manual	

Note:

1. For a more detailed features description, please refer to the manufacturer's specifications or the User's Manual.

2.

Channel List					
Channel	Frequency (MHz)	Channel	Frequency (MHz)	Channel	Frequency (MHz)
00	2402	27	2429	54	2456
01	2403	28	2430	55	2457
02	2404	29	2431	56	2458
03	2405	30	2432	57	2459
04	2406	31	2433	58	2460
05	2407	32	2434	59	2461
06	2408	33	2435	60	2462
07	2409	34	2436	61	2463
08	2410	35	2437	62	2464
09	2411	36	2438	63	2465
10	2412	37	2439	64	2466
11	2413	38	2440	65	2467
12	2414	39	2441	66	2468
13	2415	40	2442	67	2469
14	2416	41	2443	68	2470
15	2417	42	2444	69	2471
16	2418	43	2445	70	2472
17	2419	44	2446	71	2473
18	2420	45	2447	72	2474
19	2421	46	2448	73	2475
20	2422	47	2449	74	2476
21	2423	48	2450	75	2477
22	2424	49	2451	76	2478
23	2425	50	2452	77	2479
24	2426	51	2453	78	2480
25	2427	52	2454		
26	2428	53	2455		

3.

Table for Filed Antenna

Ant	Brand	Model Name	Antenna Type	Connector	Gain (dBi)	NOTE
1	N/A	N/A	PCB Antenna	N/A	0	BT Antenna

2.2 DESCRIPTION OF TEST MODES

To investigate the maximum EMI emission characteristics generates from EUT, the test system was pre-scanning tested base on the consideration of following EUT operation mode or test configuration mode which possible have effect on EMI emission level. Each of these EUT operation mode(s) or test configuration mode(s) mentioned above was evaluated respectively.

Pretest Mode	Description
Mode 1	CH00
Mode 2	CH39
Mode 3	CH78
Mode 4	Link Mode

For Conducted Emission	
Final Test Mode	Description
Mode 4	Link Mode

For Radiated Emission	
Final Test Mode	Description
Mode 1	CH00
Mode 2	CH39
Mode 3	CH78

Note:

- (1) The measurements are performed at the highest, middle, lowest available channels.
- (2) The EUT use new battery.
- (3)The data rate was set in 1Mbps for radiated emission due to the highest RF output power.

2.3 TABLE OF PARAMETERS OF TEXT SOFTWARE SETTING

During testing channel & power controlling software provided by the customer was used to control the operating channel as well as the output power level. The RF output power selection is for the setting of RF output power expected by the customer and is going to be fixed on the firmware of the final end product power parameters of FHSS

Test software Version	Test program: N/A		
Frequency	2402 MHz	2441 MHz	2480 MHz
Parameters(1/2/3Mbps)	DEF	DEF	DEF

2.4 BLOCK DIGRAM SHOWING THE CONFIGURATION OF SYSTEM TESTED

CE

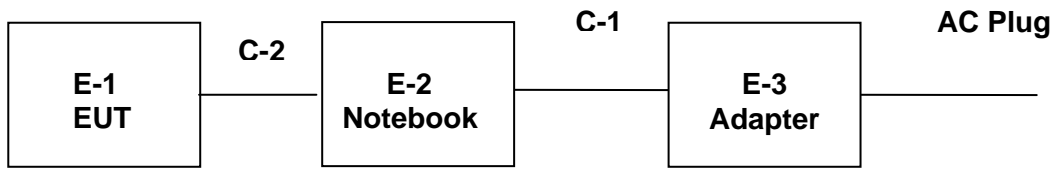

RE

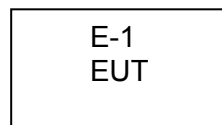

2.5 DESCRIPTION OF SUPPORT UNITS(CONDUCTED MODE)

The EUT has been tested as an independent unit together with other necessary accessories or support units. The following support units or accessories were used to form a representative test configuration during the tests.

Item	Equipment	Brand	Model/Type No.	Series No.	Note
E-1	Bluetooth speaker	Merkury	SPB60	N/A	EUT
E-2	Notebook	Dell	D2234	22544	
E-3	Adapter	Dell	D195000200	N/A	

Item	Shielded Type	Ferrite Core	Length	Note
C-1	NO	NO	100cm	
C-2	NO	NO	120cm	

Note:

- (1) The support equipment was authorized by Declaration of Confirmation.
- (2) For detachable type I/O cable should be specified the length in cm in 『Length』 column.
- (3) “YES” is means “shielded” “with core”; “NO” is means “unshielded” “without core”.

2.6 EQUIPMENTS LIST FOR ALL TEST ITEMS

Radiation Test equipment

Item	Kind of Equipment	Manufacturer	Type No.	Serial No.	Last calibration	Calibrated until	Calibration period
1	Spectrum Analyzer	Agilent	E4407B	MY45108040	2013.07.06	2014.07.05	1 year
2	Test Receiver	R&S	ESPI	101318	2013.06.07	2014.06.06	1 year
3	Bilog Antenna	TESEQ	CBL6111D	31216	2013.07.06	2014.07.05	1 year
4	50Ω Coaxial Switch	Anritsu	MP59B	6200264416	2013.06.07	2014.06.06	1 year
5	Spectrum Analyzer	ADVANTEST	R3132	150900201	2013.06.07	2014.06.06	1 year
6	Horn Antenna	EM	EM-AH-10180	2011071402	2013.07.06	2014.07.05	1 year
7	Horn Ant	Schwarzbeck	BBHA 9170	9170-181	2013.07.06	2014.07.05	1 year
8	Amplifier	EM	EM-30180	060538	2012.12.22	2013.12.21	1 year
9	Loop Antenna	ARA	PLA-1030/B	1029	2013.06.08	2014.06.07	1 year
10	Power Meter	R&S	NRVS	100696	2013.07.06	2014.07.05	1 year
11	Power Sensor	R&S	URV5-Z4	0395.1619.05	2013.07.06	2014.07.05	1 year

Conduction Test equipment

Item	Kind of Equipment	Manufacturer	Type No.	Serial No.	Last calibration	Calibrated until	Calibration period
1	Test Receiver	R&S	ESCI	101160	2013.06.06	2014.06.05	1 year
2	LISN	R&S	ENV216	101313	2013.08.24	2014.08.23	1 year
3	LISN	EMCO	3816/2	00042990	2013.08.24	2014.08.23	1 year
4	50Ω Coaxial Switch	Anritsu	MP59B	6200264417	2013.06.07	2014.06.06	1 year
5	Passive Voltage Probe	R&S	ESH2-Z3	100196	2013.06.07	2014.06.06	1 year
6	Absorbing clamp	R&S	MOS-21	100423	2013.06.08	2014.06.07	1 year

1	Attenuation	MCE	24-10-34	BN9258	2013.06.08	2014.06.07	1 year
---	-------------	-----	----------	--------	------------	------------	--------

3. EMC EMISSION TEST

3.1 CONDUCTED EMISSION MEASUREMENT

3.1.1 POWER LINE CONDUCTED EMISSION Limits (Frequency Range 150KHz-30MHz)

FREQUENCY (MHz)	Class A (dBuV)		Class B (dBuV)		Standard
	Quasi-peak	Average	Quasi-peak	Average	
0.15 -0.5	79.00	66.00	66 - 56 *	56 - 46 *	CISPR
0.50 -5.0	73.00	60.00	56.00	46.00	CISPR
5.0 -30.0	73.00	60.00	60.00	50.00	CISPR

0.15 -0.5	79.00	66.00	66 - 56 *	56 - 46 *	FCC
0.50 -5.0	73.00	60.00	56.00	46.00	FCC
5.0 -30.0	73.00	60.00	60.00	50.00	FCC

Note:

- (1) The tighter limit applies at the band edges.
- (2) The limit of " * " marked band means the limitation decreases linearly with the logarithm of the frequency in the range.

The following table is the setting of the receiver

Receiver Parameters	Setting
Attenuation	10 dB
Start Frequency	0.15 MHz
Stop Frequency	30 MHz
IF Bandwidth	9 kHz

3.1.2 TEST PROCEDURE

- a. The EUT was placed 0.8 meters from the horizontal ground plane with EUT being connected to the power mains through a line impedance stabilization network (LISN). All other support equipments powered from additional LISN(s). The LISN provide 50 Ohm/ 50uH of coupling impedance for the measuring instrument.
- b. Interconnecting cables that hang closer than 40 cm to the ground plane shall be folded back and forth in the center forming a bundle 30 to 40 cm long.
- c. I/O cables that are not connected to a peripheral shall be bundled in the center. The end of the cable may be terminated, if required, using the correct terminating impedance. The overall length shall not exceed 1 m.
- d. LISN at least 80 cm from nearest part of EUT chassis.
- e. For the actual test configuration, please refer to the related Item –EUT Test Photos.

3.1.3 DEVIATION FROM TEST STANDARD

No deviation

3.1.4 TEST SETUP

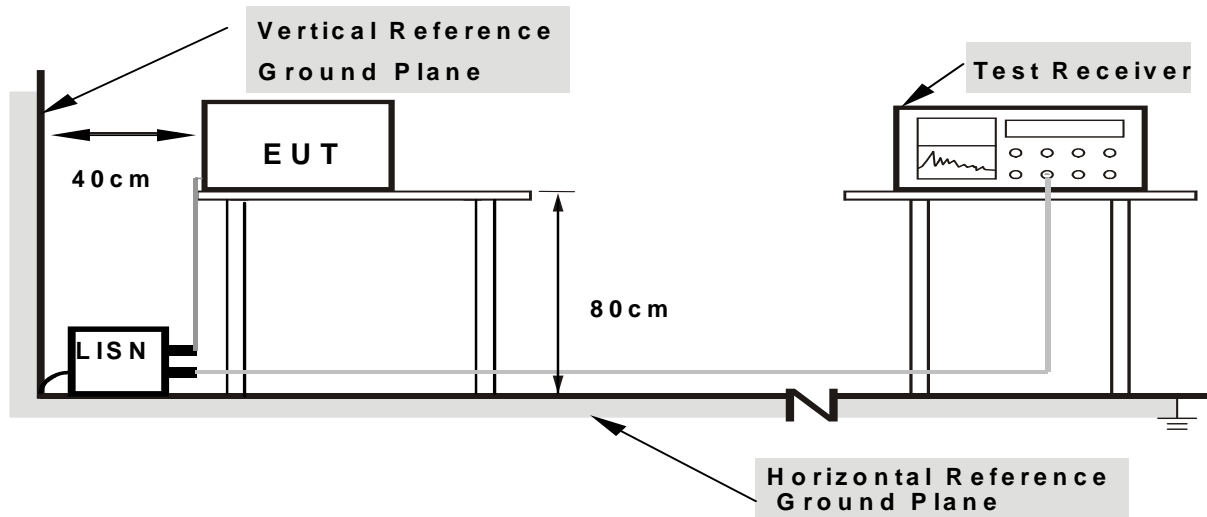

Note: 1. Support units were connected to second LISN.

2. Both of LISNs (AMN) are 80 cm from EUT and at least 80 cm from other units and other metal planes

3.1.5 EUT OPERATING CONDITIONS

The EUT was configured for testing in a typical fashion (as a customer would normally use it). The EUT has been programmed to continuously transmit during test. This operating condition was tested and used to collect the included data.

3.1.6 TEST RESULTS

EUT :	Bluetooth speaker	Model Name :	SPB60
Temperature :	26 °C	Relative Humidity :	54%
Pressure :	1010hPa	Phase :	L
Test Voltage :	DC 5V from PC AC 120V/60Hz	Test Mode :	Mode 4

Frequency (MHz)	Reading Level (dBµV)	Correct Factor (dB)	Measure-ment (dBµV)	Limits (dBµV)	Margin (dB)	Detector Type
0.1660	42.01	11.23	53.24	65.15	-11.91	QP
0.1660	21.47	11.23	32.70	55.15	-22.45	AVG
0.1860	43.43	10.90	54.33	64.21	-9.88	QP
0.1860	21.97	10.90	32.87	54.21	-21.34	AVG
0.6340	27.73	10.54	38.27	56.00	-17.73	QP
0.6340	21.78	10.54	32.32	46.00	-13.68	AVG
1.2700	20.89	10.52	31.41	56.00	-24.59	QP
1.2700	12.64	10.52	23.16	46.00	-22.84	AVG
14.0979	29.41	10.91	40.32	60.00	-19.68	QP
14.0979	19.47	10.91	30.38	50.00	-19.62	AVG
18.7779	30.66	11.04	41.70	60.00	-18.30	QP
18.7779	19.04	11.04	30.08	50.00	-19.92	AVG

Remark:

1. All readings are Quasi-Peak and Average values.
2. Factor = Insertion Loss + Cable Loss.

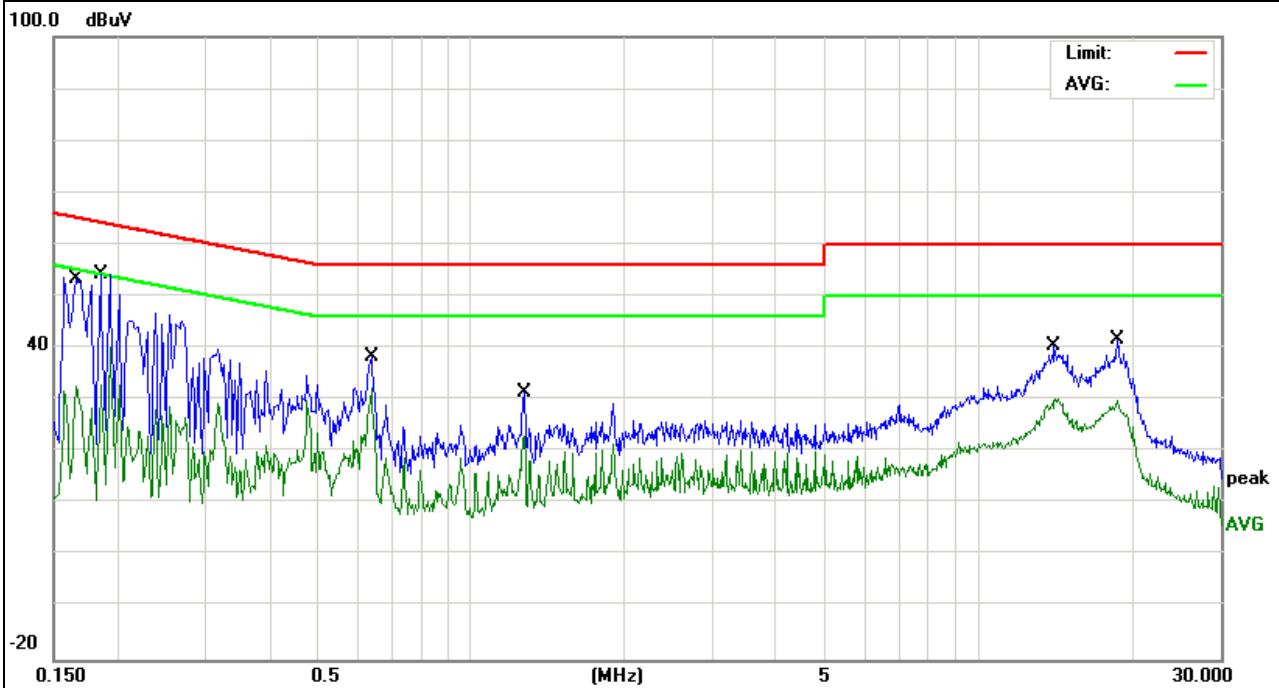

EUT :	Bluetooth speaker	Model Name :	SPB60
Temperature :	26 °C	Relative Humidity :	54%
Pressure :	1010hPa	Phase :	N
Test Voltage :	DC 5V from PC AC 120V/60Hz	Test Mode :	Mode 4

Frequency (MHz)	Reading Level (dBμV)	Correct Factor (dB)	Measure-ment (dBμV)	Limits (dBμV)	Margin (dB)	Detector Type
0.1580	42.05	11.36	53.41	65.56	-12.15	QP
0.1580	24.16	11.36	35.52	55.56	-20.04	AVG
0.1900	42.22	10.83	53.05	64.03	-10.98	QP
0.1900	24.62	10.83	35.45	54.03	-18.58	AVG
0.6340	28.07	10.54	38.61	56.00	-17.39	QP
0.6340	22.14	10.54	32.68	46.00	-13.32	AVG
1.2700	22.06	10.52	32.58	56.00	-23.42	QP
1.2700	16.99	10.52	27.51	46.00	-18.49	AVG
14.3019	27.02	10.91	37.93	60.00	-22.07	QP
14.3019	18.00	10.91	28.91	50.00	-21.09	AVG
18.1979	28.60	11.01	39.61	60.00	-20.39	QP
18.1979	17.95	11.01	28.96	50.00	-21.04	AVG

Remark:

1. All readings are Quasi-Peak and Average values.
2. Factor = Insertion Loss + Cable Loss.

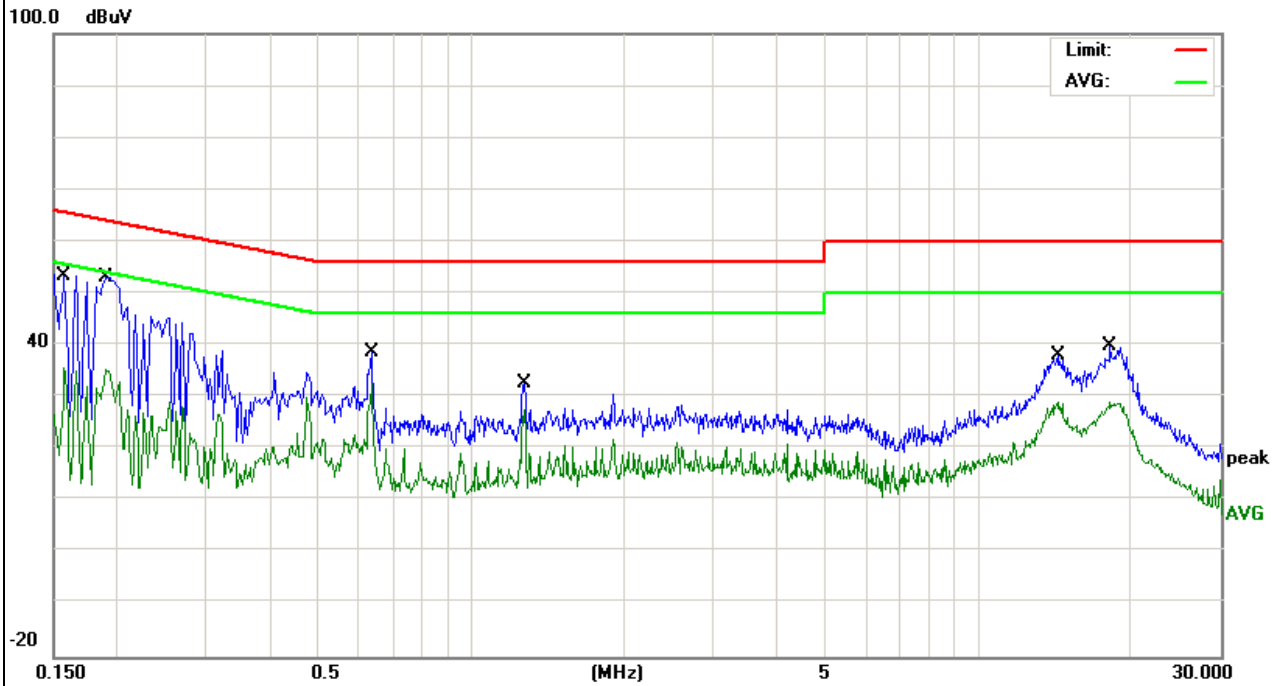

3.2 RADIATED EMISSION MEASUREMENT

3.2.1 RADIATED EMISSION LIMITS (Frequency Range 9kHz-1000MHz)

20dBc in any 100 kHz bandwidth outside the operating frequency band. In case the emission fall within the restricted band specified on 15.205(a), then the 15.209(a) limit in the table below has to be followed.

Frequencies (MHz)	Field Strength (micorvolts/meter)	Measurement Distance (meters)
0.009~0.490	2400/F(KHz)	300
0.490~1.705	24000/F(KHz)	30
1.705~30.0	30	30
30~88	100	3
88~216	150	3
216~960	200	3
Above 960	500	3

LIMITS OF RADIATED EMISSION MEASUREMENT (Above 1000MHz)

FREQUENCY (MHz)	Class A (dBuV/m) (at 3M)		Class B (dBuV/m) (at 3M)	
	PEAK	AVERAGE	PEAK	AVERAGE
Above 1000	80	60	74	54

Notes:

- (1) The limit for radiated test was performed according to FCC PART 15C.
- (2) The tighter limit applies at the band edges.
- (3) Emission level (dBuV/m)=20log Emission level (uV/m).

FREQUENCY RANGE OF RADIATED MEASUREMENT (For unintentional radiators)

Highest frequency generated or Upper frequency of measurement used in the device or on which the device operates or tunes (MHz)	Range (MHz)
Below 1.705	30
1.705 – 108	1000
108 – 500	2000
500 – 1000	5000
Above 1000	5 th harmonic of the highest frequency or 40 GHz, whichever is lower

Spectrum Parameter	Setting
Attenuation	Auto
Start Frequency	1000 MHz
Stop Frequency	10th carrier harmonic
RB / VB (emission in restricted band)	1 MHz / 1 MHz for Peak, 1 MHz / 10Hz for Average

Receiver Parameter	Setting
Attenuation	Auto
Start ~ Stop Frequency	9kHz~150kHz / RB 200Hz for QP
Start ~ Stop Frequency	150kHz~30MHz / RB 9kHz for QP
Start ~ Stop Frequency	30MHz~1000MHz / RB 120kHz for QP

3.2.2 TEST PROCEDURE

- a. The measuring distance of at 3 m shall be used for measurements at frequency up to 1GHz. For frequencies above 1GHz, any suitable measuring distance may be used.
- b. The EUT was placed on the top of a rotating table 0.8 meters above the ground at a 3 meter open area test site. The table was rotated 360 degrees to determine the position of the highest radiation.
- c. The height of the equipment or of the substitution antenna shall be 0.8 m; the height of the test antenna shall vary between 1 m to 4 m. Both horizontal and vertical polarizations of the antenna are set to make the measurement.
- d. The initial step in collecting conducted emission data is a spectrum analyzer peak detector mode pre-scanning the measurement frequency range. Significant peaks are then marked and then Quasi Peak detector mode re-measured.
- e. If the Peak Mode measured value compliance with and lower than Quasi Peak Mode Limit, the EUT shall be deemed to meet QP Limits and then no additional QP Mode measurement performed.
- f. For the actual test configuration, please refer to the related Item –EUT Test Photos.

Note:

Both horizontal and vertical antenna polarities were tested and performed pretest to three orthogonal axis. The worst case emissions were reported

3.2.3 DEVIATION FROM TEST STANDARD

No deviation

3.2.4 TEST SETUP

(A) Radiated Emission Test-Up Frequency Below 30MHz

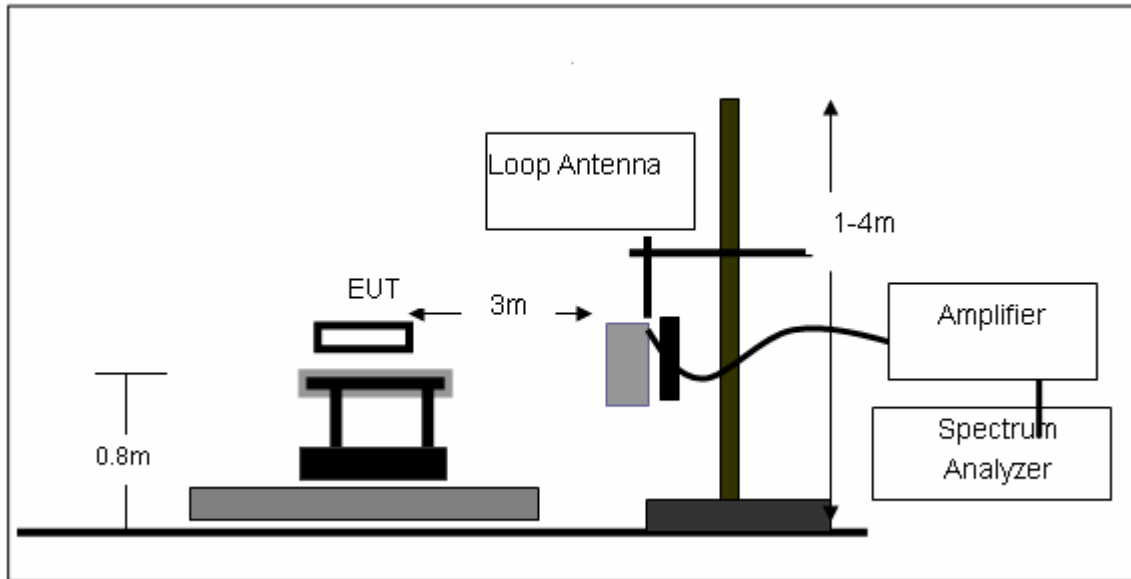

(B) Radiated Emission Test-Up Frequency 30MHz~1GHz

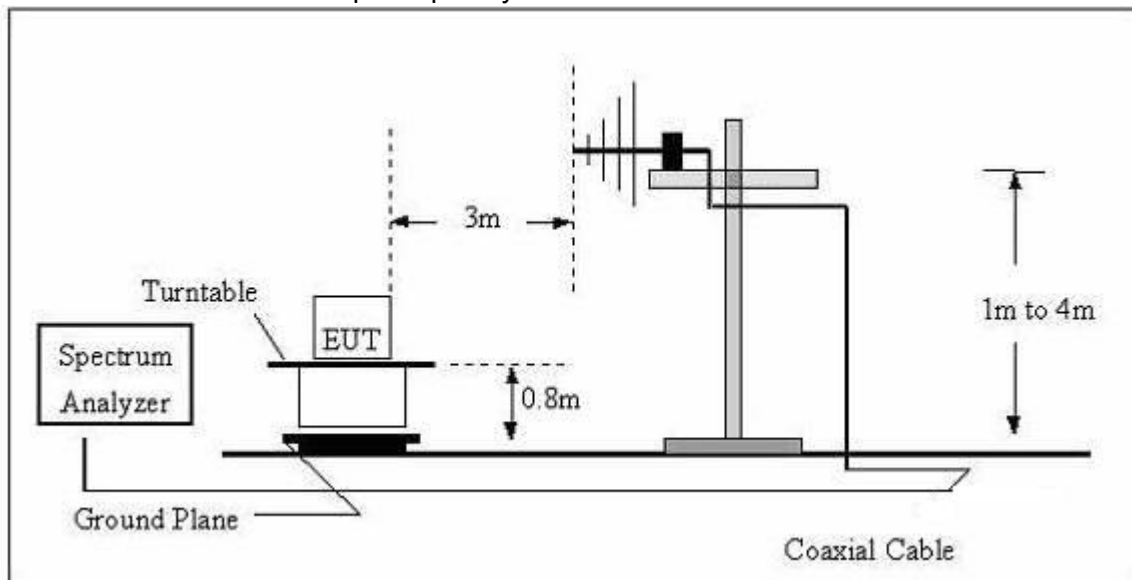

(C) Radiated Emission Test-Up Frequency Above 1GHz

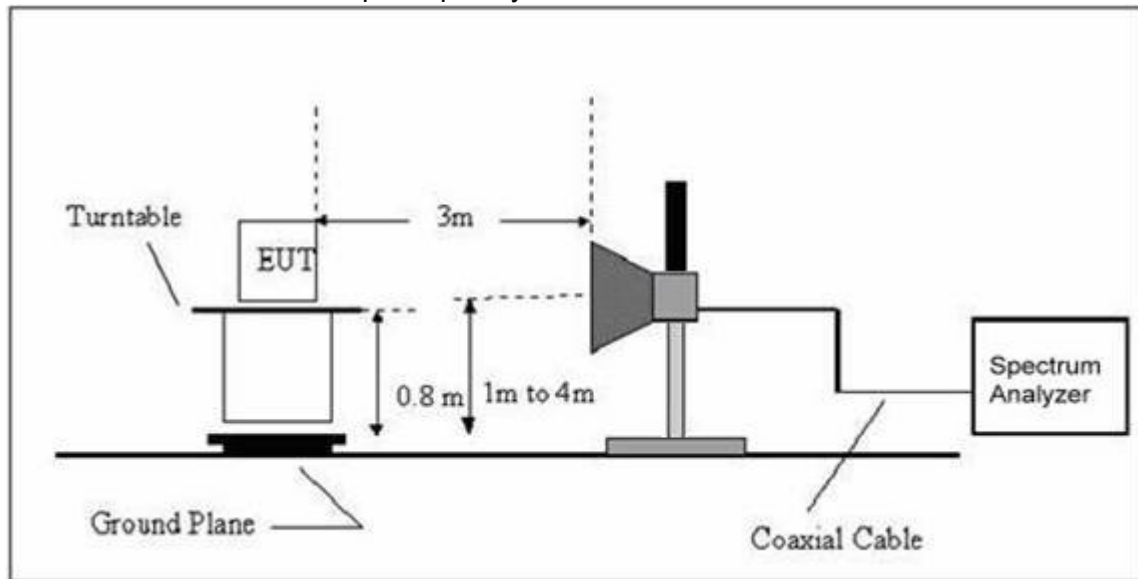
**3.2.5 EUT OPERATING CONDITIONS**

The EUT tested system was configured as the statements of 2.4 Unless otherwise a special operating condition is specified in the follows during the testing.

3.2.6 TEST RESULTS (BELOW 30 MHZ)

EUT :	Bluetooth speaker	Model Name :	SPB60
Temperature :	20 °C	Relative Humidity :	48%
Pressure :	1010 hPa	Test Voltage :	DC 3.7V
Test Mode :	TX	Polarization :	---

Freq.	Reading	Limit	Margin	State
(MHz)	(dBuV/m)	(dBuV/m)	(dB)	P/F
--	--	--	--	PASS
--	--	--	--	PASS

NOTE:

The amplitude of spurious emissions which are attenuated by more than 20dB below the permissible value has no need to be reported.

Distance extrapolation factor = $20 \log (\text{specific distance}/\text{test distance})(\text{dB})$;

Limit line = specific limits(dBuv) + distance extrapolation factor.

3.2.7 TEST RESULTS (BETWEEN 30M – 1000 MHZ)

EUT :	Bluetooth speaker	Model Name :	SPB60
Temperature :	20 °C	Relative Humidity :	48%
Pressure :	1010 hPa	Test Voltage :	DC 3.7V
Test Mode :	TX		

Polar (H/V)	Frequency	Meter Reading	Factor	Emission Level	Limits	Margin	Detector Type
	(MHz)	(dBuV)	(dB)	(dBuV/m)	(dBuV/m)	(dB)	
V	148.441	26.96	11.83	38.79	43.5	-4.71	QP
V	222.9499	28.33	10.58	38.91	46	-7.09	QP
V	520.8881	18.45	20.86	39.31	46	-6.69	QP
V	627.2738	16.96	23.59	40.55	46	-5.45	QP
V	752.7432	14.41	26.39	40.8	46	-5.20	QP
V	818.8341	13.14	26.56	39.7	46	-6.30	QP
H	222.95	28.83	10.58	39.41	46	-6.59	QP
H	293.0842	23.34	14.56	37.9	46	-8.10	QP
H	423.5403	18.76	18.94	37.7	46	-8.30	QP
H	520.8881	18.71	20.86	39.57	46	-6.43	QP
H	668.1422	18	23.81	41.81	46	-4.19	QP
H	734.4913	13.44	26.36	39.8	46	-6.20	QP

Remark:

Absolute Level= ReadingLevel+ Factor, Margin= Absolute Level - Limit

3.2.8 TEST RESULTS (ABOVE 1000 MHZ)

EUT :	Bluetooth speaker	Model Name :	SPB60
Temperature :	20 °C	Relative Humidity :	48%
Pressure :	1010 hPa	Test Voltage :	DC 3.7V
Test Mode :	TX 2402MHz/2441MHz/2480MHz (1Mbps)		

Polar (H/V)	Frequency	Meter Reading	Factor	Emission Level	Limits	Margin	Detector Type
	(MHz)	(dBuV)	(dB)	(dBuV/m)	(dBuV/m)	(dB)	
Frequency:2402MHz							
V	4804.556	53.96	-3.64	50.32	74	-23.68	peak
V	7207.069	50.76	-0.95	49.81	74	-24.19	peak
H	4804.556	50.83	-3.64	47.19	74	-26.81	peak
H	7207.069	45.3	-0.95	44.35	74	-29.65	peak
Frequency:2441MHz							
V	4882.302	55.93	-3.67	52.26	74	-21.74	peak
V	7324.396	51.56	-0.82	50.74	74	-23.26	peak
H	4882.302	54.73	-3.68	51.05	74	-22.95	peak
H	7324.396	48.74	-0.82	47.92	74	-26.08	peak
Frequency:2480MHz							
V	4961.207	53.65	-3.59	50.06	74	-23.94	peak
V	7440.981	47.49	-0.68	46.81	74	-27.19	peak
H	4961.207	53.97	-3.59	50.38	74	-23.62	peak
H	7440.981	49.41	-0.68	48.73	74	-25.27	peak
Remark:							
Absolute Level= ReadingLevel+ Factor, Margin= Absolute Level - Limit							

Note: Mode 1Mbps is the worst mode.

Conducted Spurious Emissions at Antenna Port:
CH00 -1Mbps

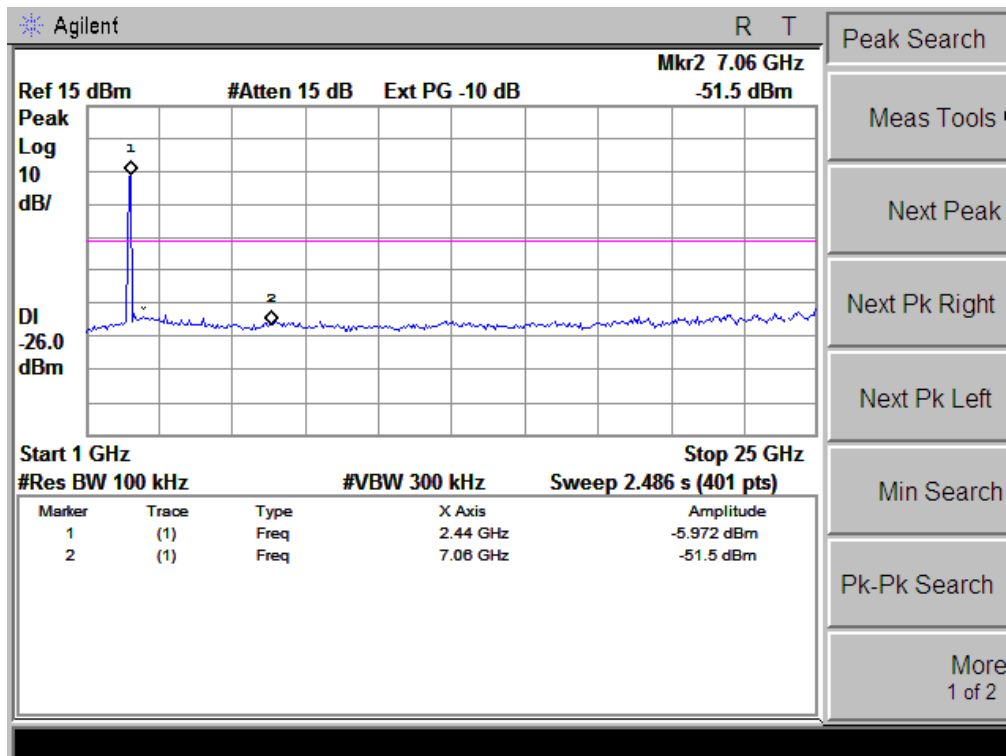
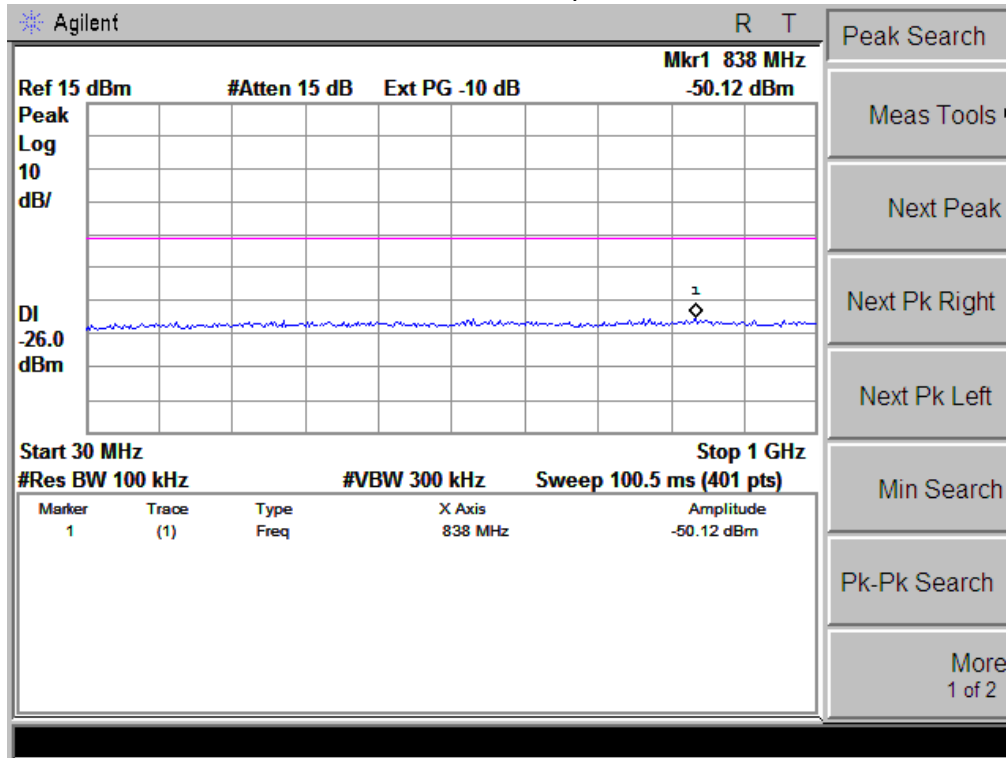

CH39 -1Mbps

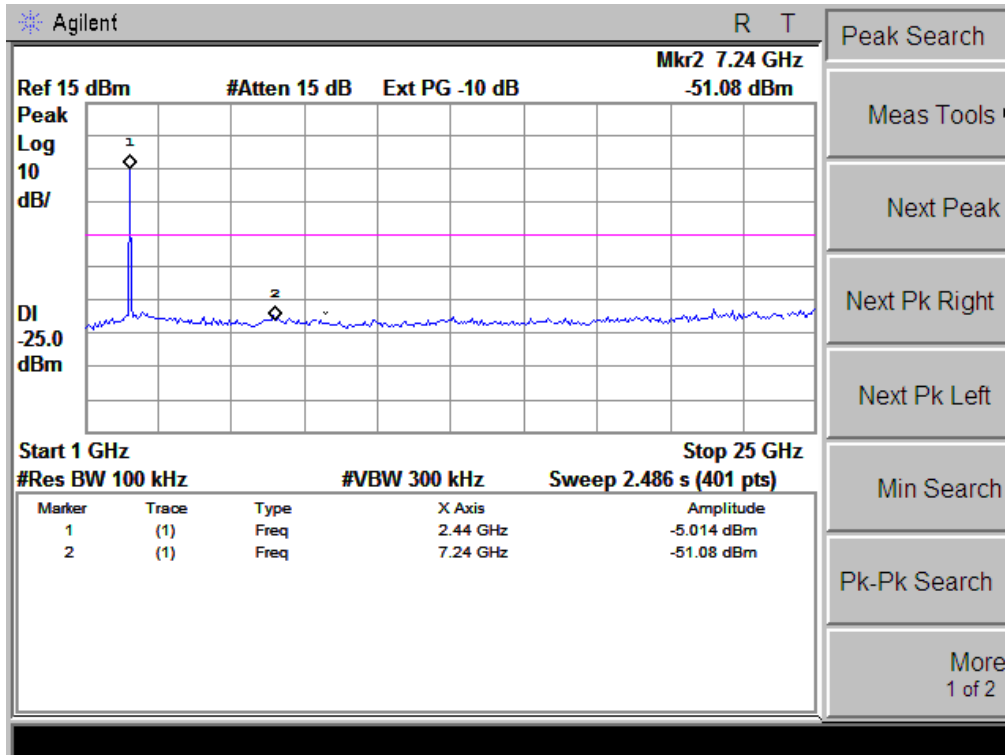
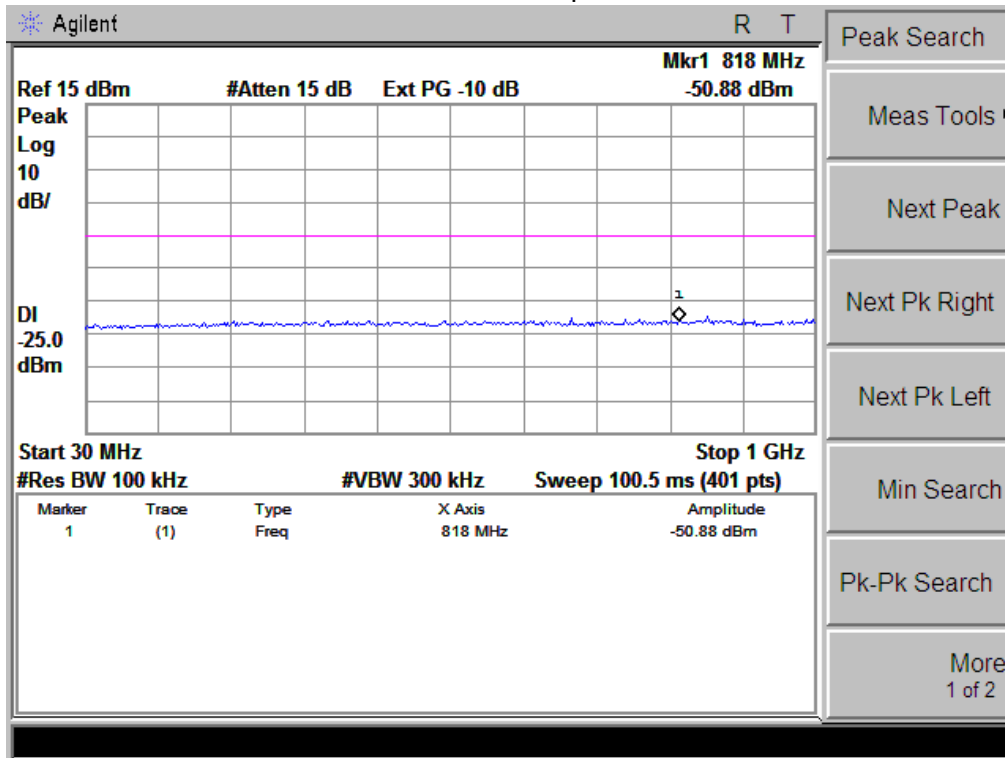

CH78 -1Mbps

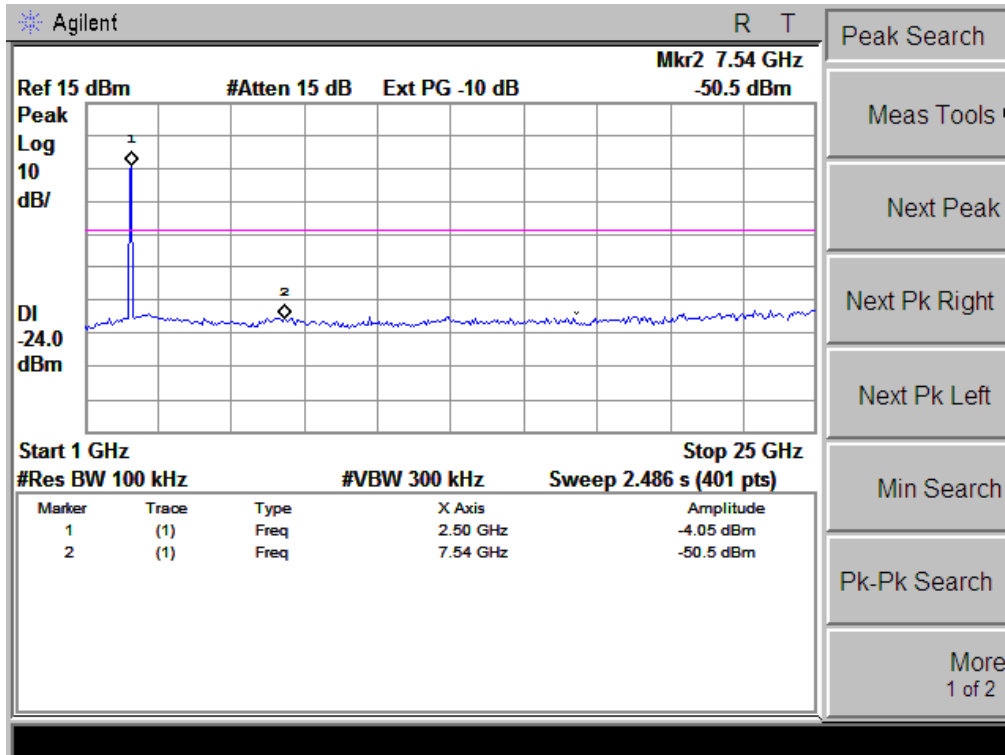
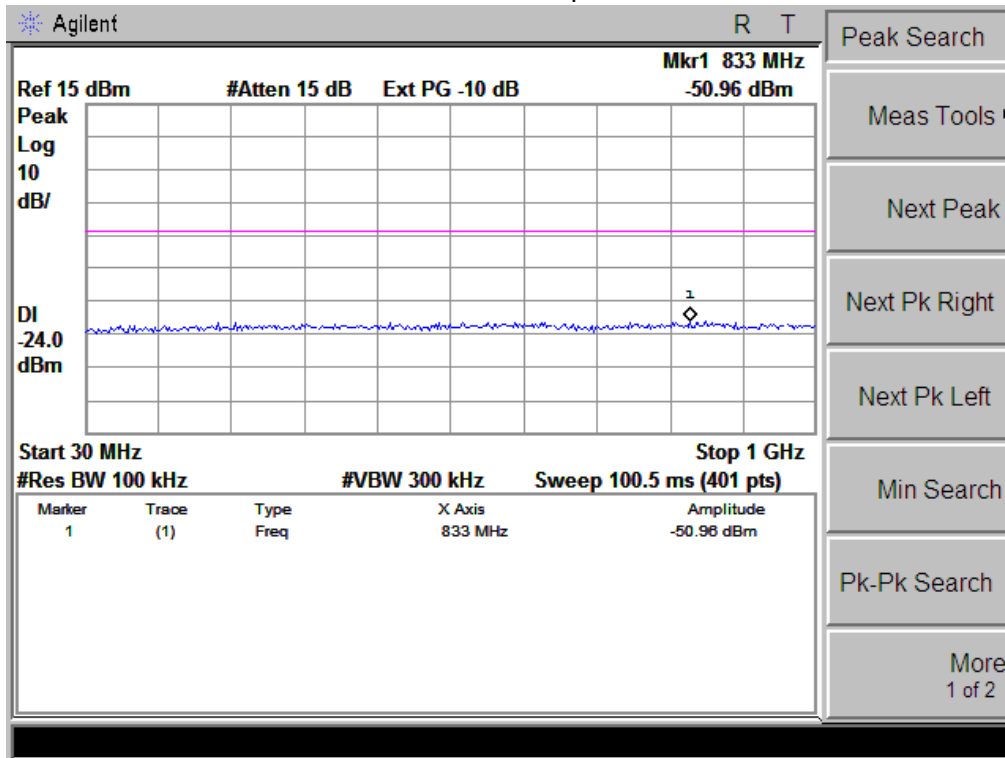

CH00 -2Mbps

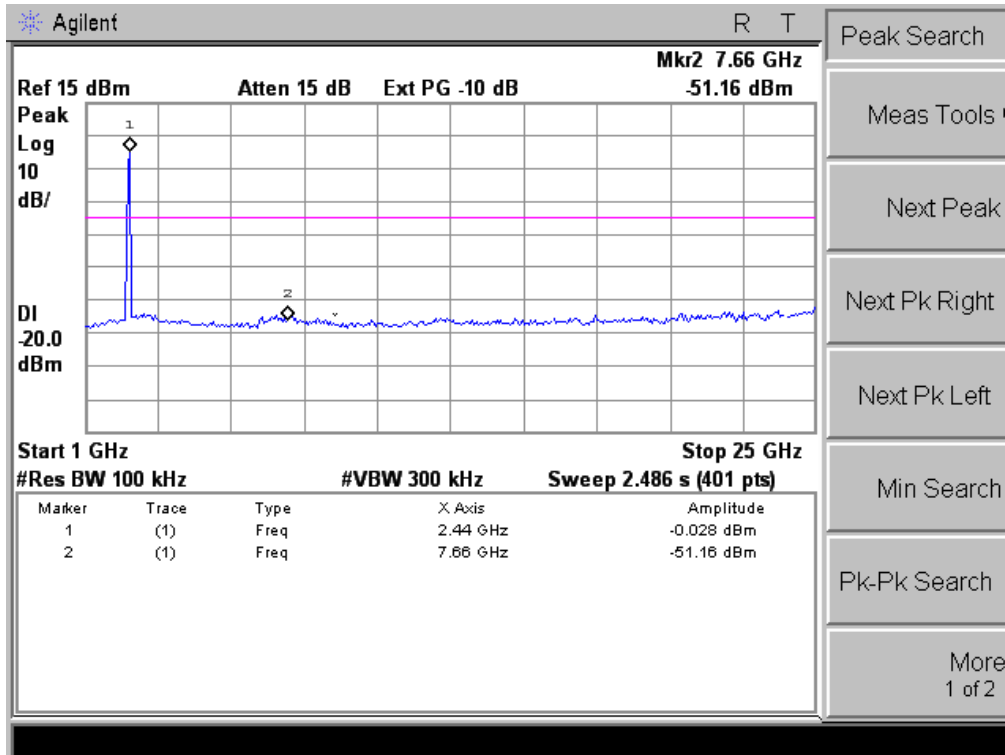
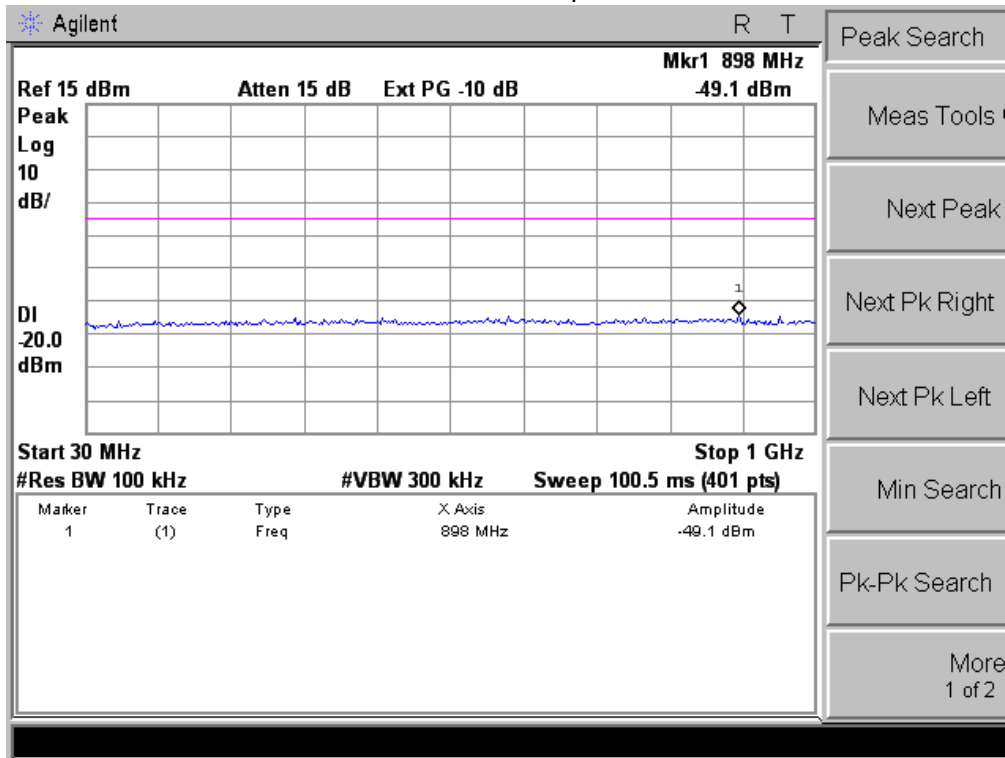

CH39 -2Mbps

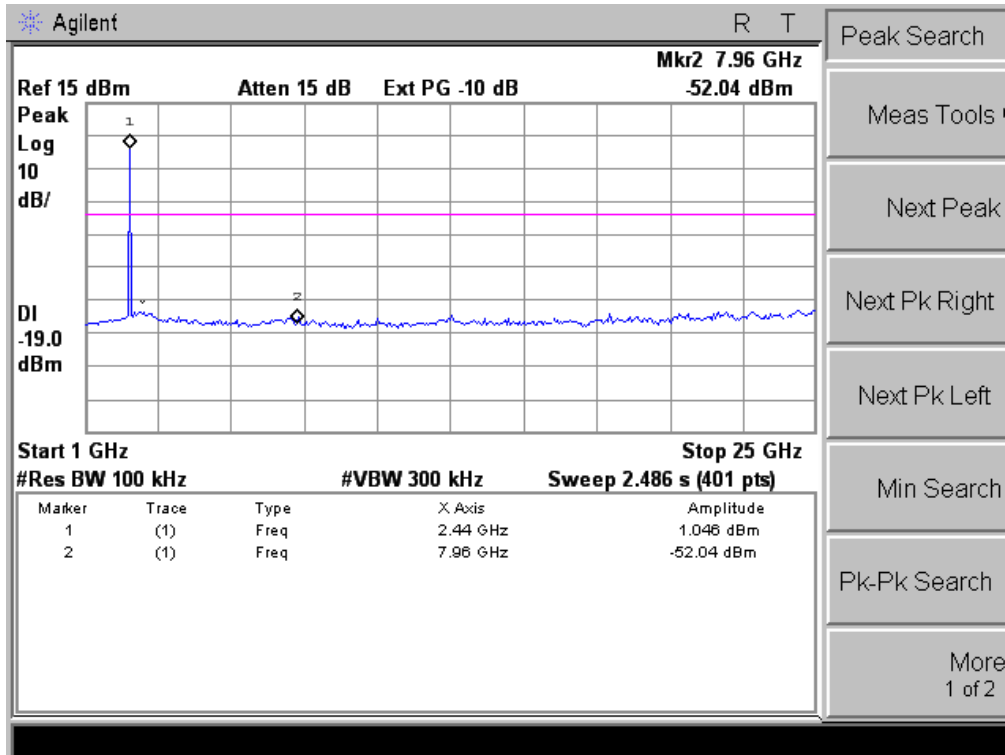
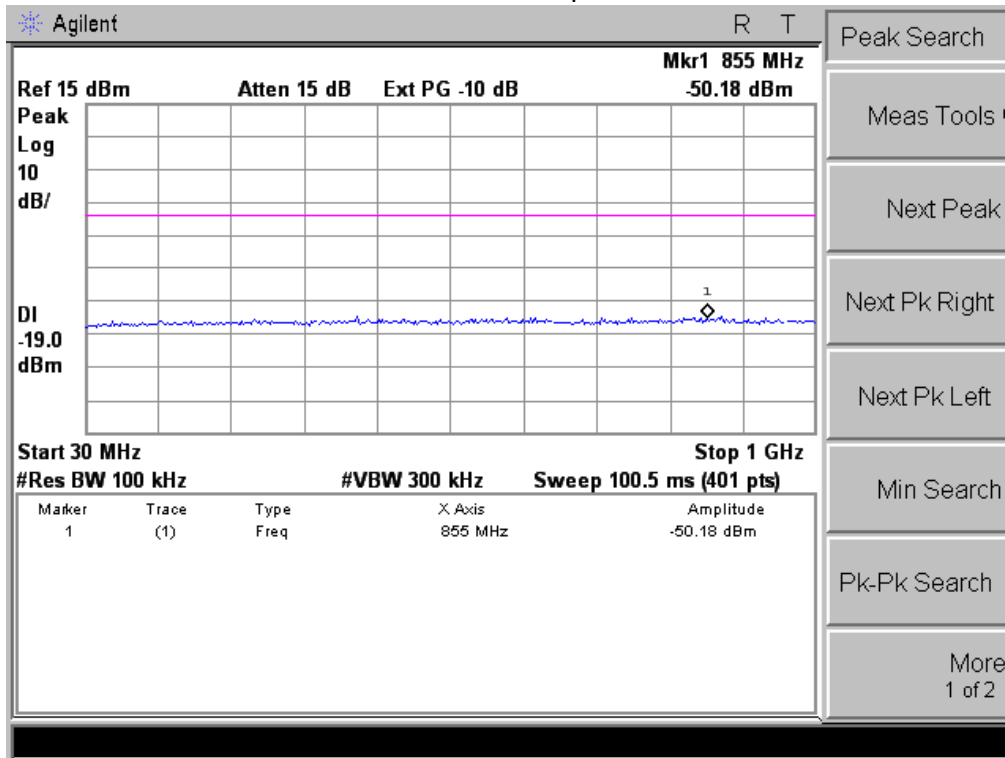

CH78 -2Mbps

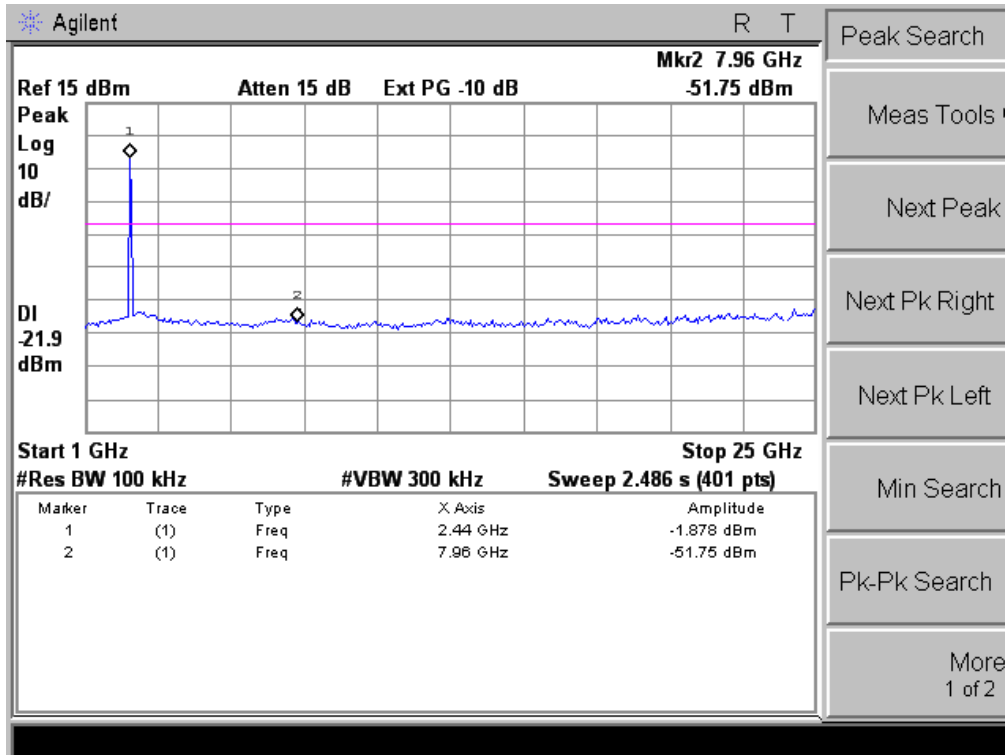
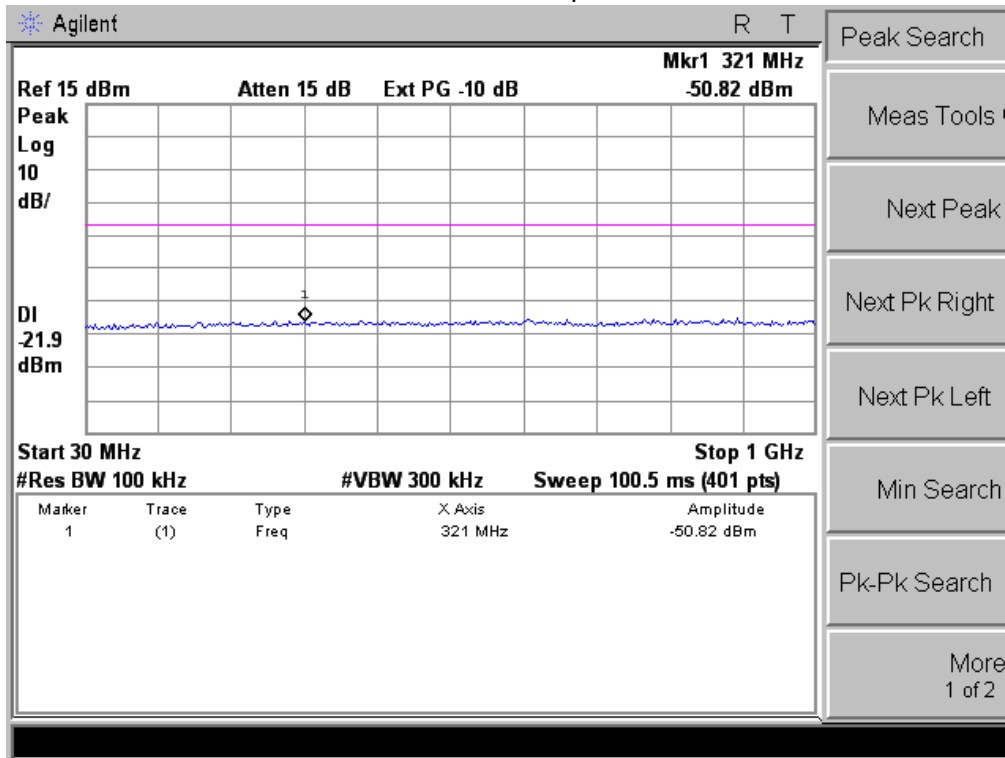

CH00 -3Mbps

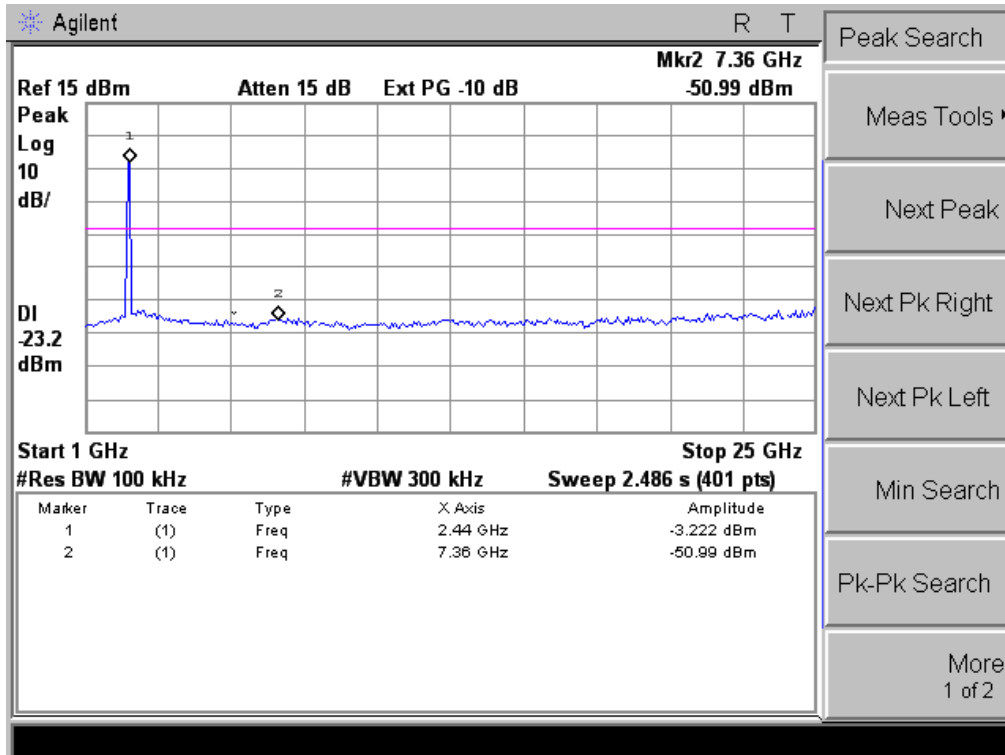
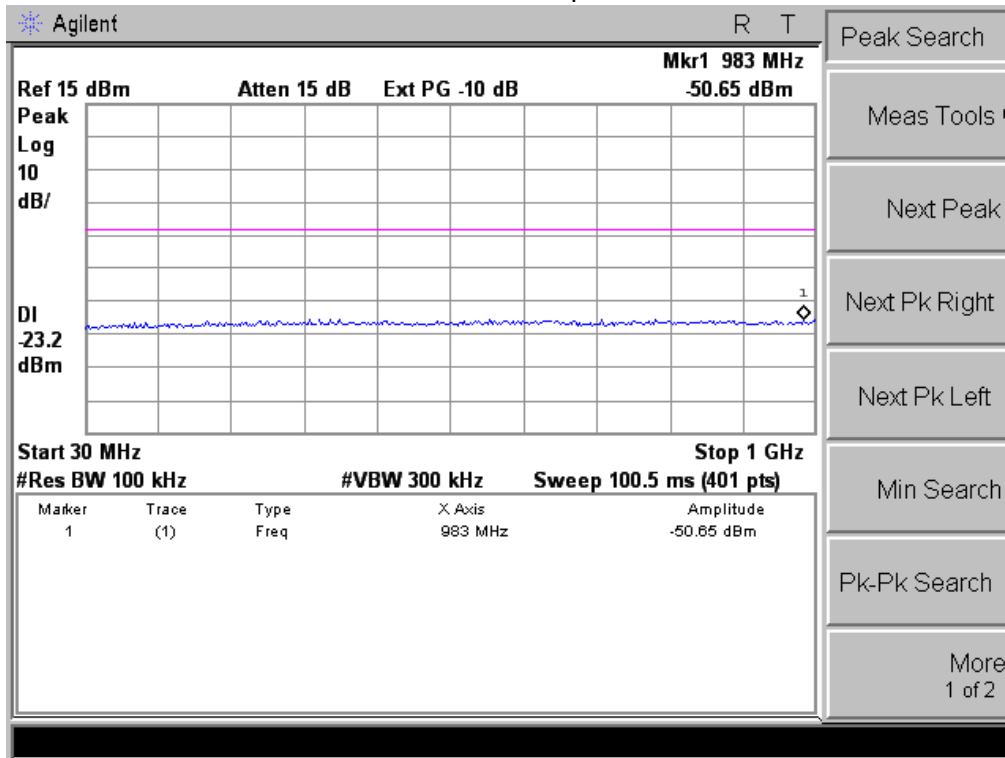

CH39 -3Mbps

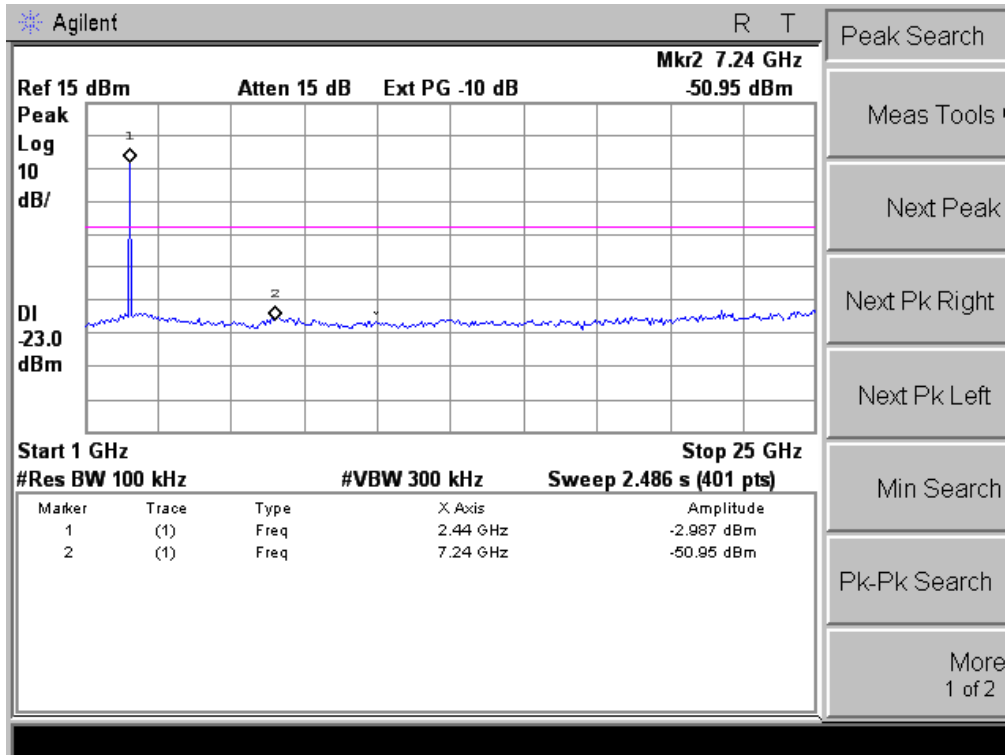
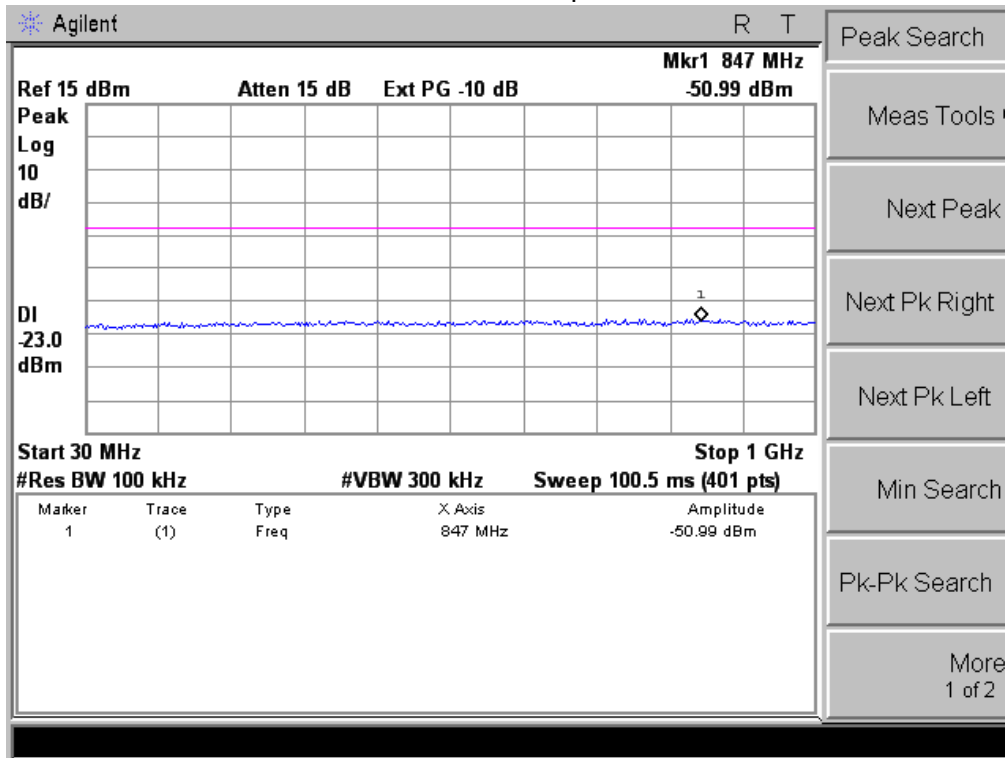

CH78 -3Mbps

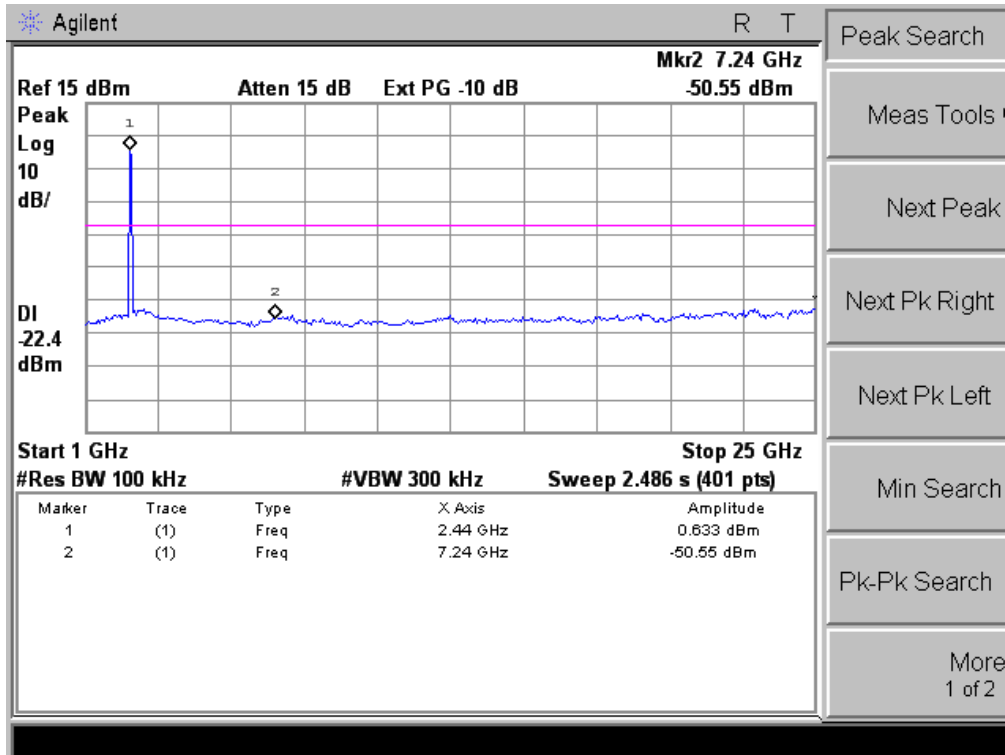
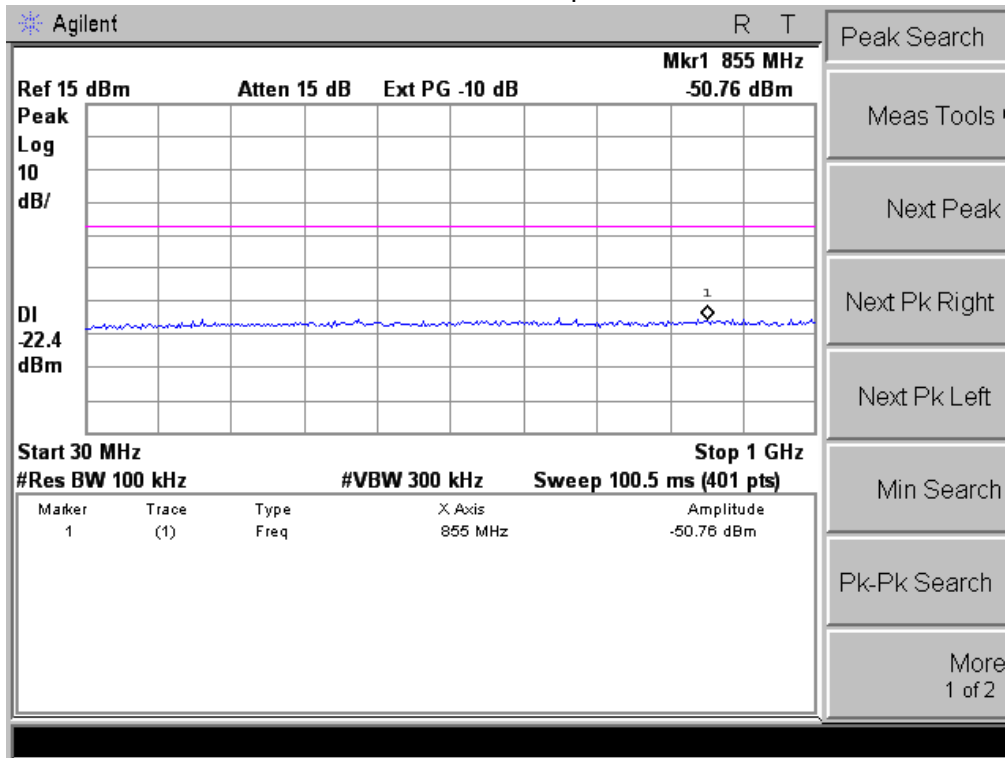

4. NUMBER OF HOPPING CHANNEL

4.1 APPLIED PROCEDURES / LIMIT

FCC Part15 (15.247) , Subpart C				
Section	Test Item	Limit	Frequency Range (MHz)	Result
15.247 (a)(1)(iii)	Number of Hopping Channel	≥15	2400-2483.5	PASS

Spectrum Parameters	Setting
Attenuation	Auto
Span Frequency	= the frequency band of operation
RB	RBW ≥ 1% of the span
VB	VBW ≥ RBW
Detector	Peak
Trace	Max Hold
Sweep Time	Auto

4.1.1 TEST PROCEDURE

- a. The EUT was directly connected to the spectrum analyzer and antenna output port as show in the block diagram below,
- b. Spectrum Setting : RBW= 1MHz, VBW=3MHz, Sweep time = Auto.

4.1.2 DEVIATION FROM STANDARD

No deviation.

4.1.3 TEST SETUP



4.1.4 EUT OPERATION CONDITIONS

The EUT tested system was configured as the statements of 2.4 Unless otherwise a special operating condition is specified in the follows during the testing.

4.1.5 TEST RESULTS

EUT :	Bluetooth speaker	Model Name :	SPB60
Temperature :	25 °C	Relative Humidity :	60%
Pressure :	1015 hPa	Test Voltage :	DC 3.7V
Test Mode :	Hopping Mode		

Number of Hopping Channel	79
---------------------------	----

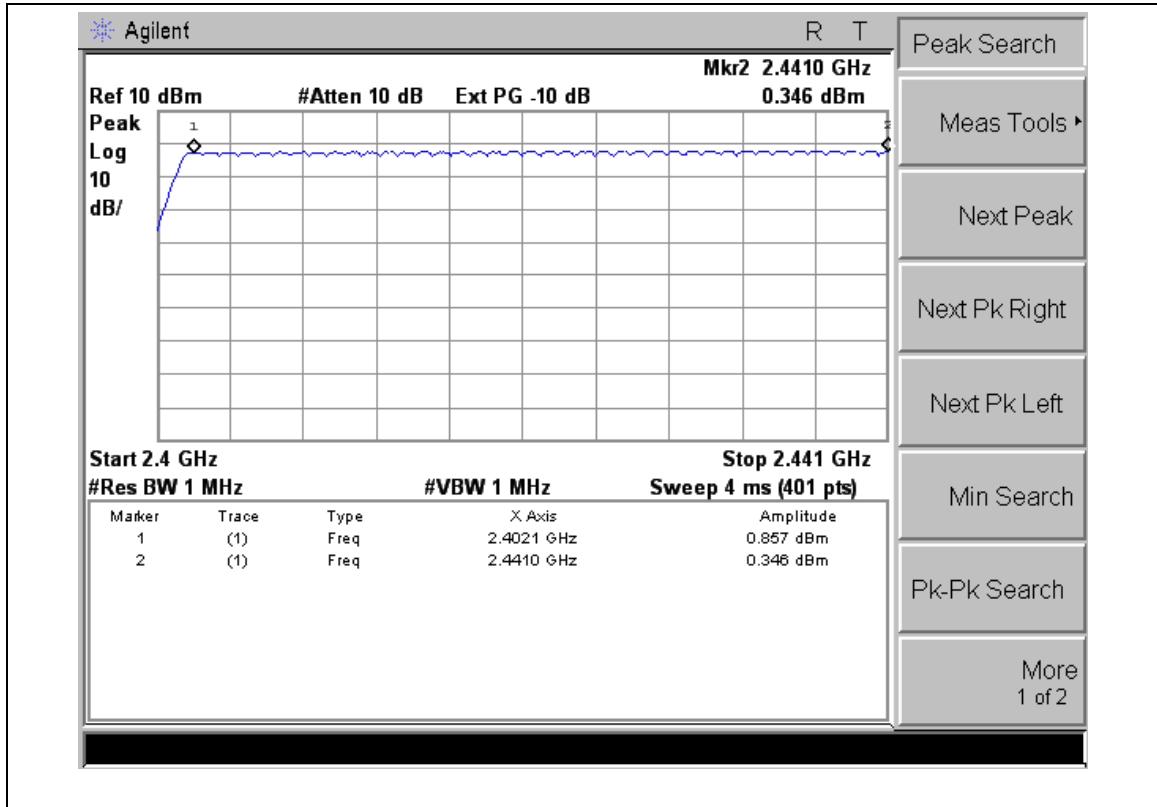

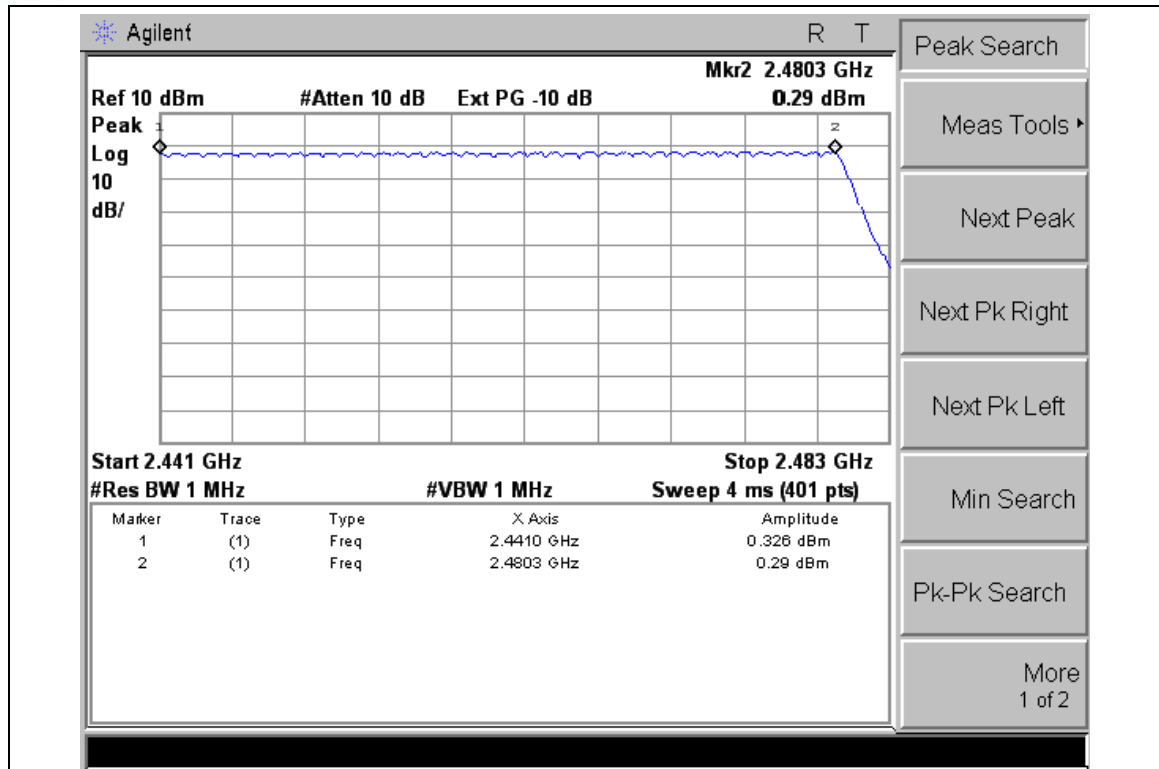

5. AVERAGE TIME OF OCCUPANCY

5.1 APPLIED PROCEDURES / LIMIT

FCC Part15 (15.247) , Subpart C				
Section	Test Item	Limit	Frequency Range (MHz)	Result
15.247 (a)(1)(iii)	Average Time of Occupancy	0.4sec	2400-2483.5	PASS

5.1.1 TEST PROCEDURE

- a. The transmitter output (antenna port) was connected to the spectrum analyzer
- b. Set RBW of spectrum analyzer to 1MHz and VBW to 1MHz.
- c. Use a video trigger with the trigger level set to enable triggering only on full pulses.
- d. Sweep Time is more than once pulse time.
- e. Set the center frequency on any frequency would be measure and set the frequency span to zero span.
- f. Measure the maximum time duration of one single pulse.
- g. Set the EUT for DH5, DH3 and DH1 packet transmitting.
- h. Measure the maximum time duration of one single pulse.
- i. A Period Time = (channel number)*0.4
 DH1 Time Slot: Reading * (1600/2)*31.6/(channel number)
 DH3 Time Slot: Reading * (1600/4)*31.6/(channel number)
 DH5 Time Slot: Reading * (1600/6)*31.6/(channel number)

5.1.2 DEVIATION FROM STANDARD

No deviation.

5.1.3 TEST SETUP

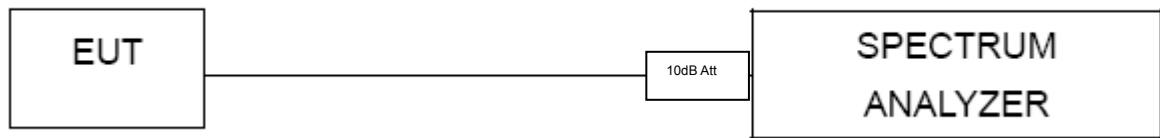

5.1.4 EUT OPERATION CONDITIONS

The EUT tested system was configured as the statements of 2.4 Unless otherwise a special operating condition is specified in the follows during the testing.

5.1.5 TEST RESULTS

EUT :	Bluetooth speaker	Model Name :	SPB60
Temperature :	25 °C	Relative Humidity :	60%
Pressure :	1012 hPa	Test Voltage :	DC 3.7V
Test Mode :	CH39-DH5,2DH5,3DH5		

Data Packet	Frequency	Pulse Duration (ms)	Dwell Time (s)	Limits (s)
DH5	2441 MHz	2.95	0.31	0.4
2DH5	2441 MHz	2.99	0.32	0.4
3DH5	2441 MHz	2.98	0.32	0.4

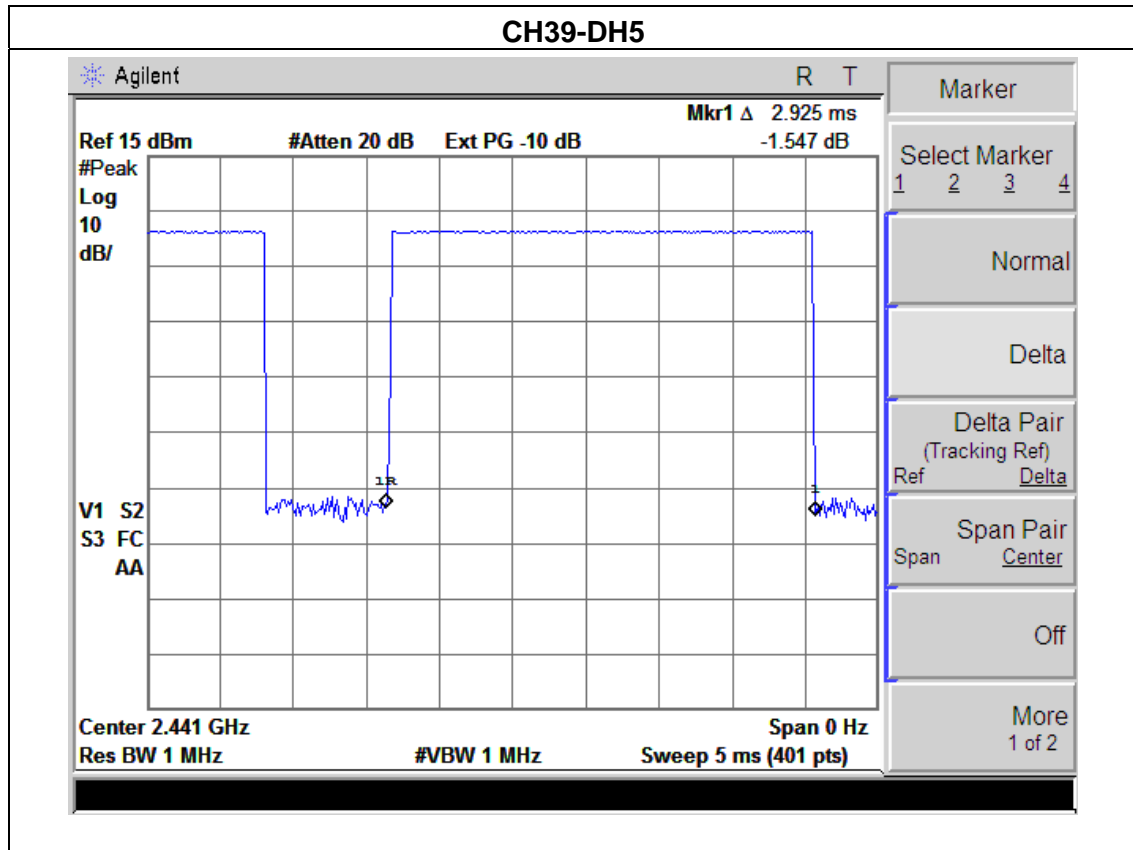

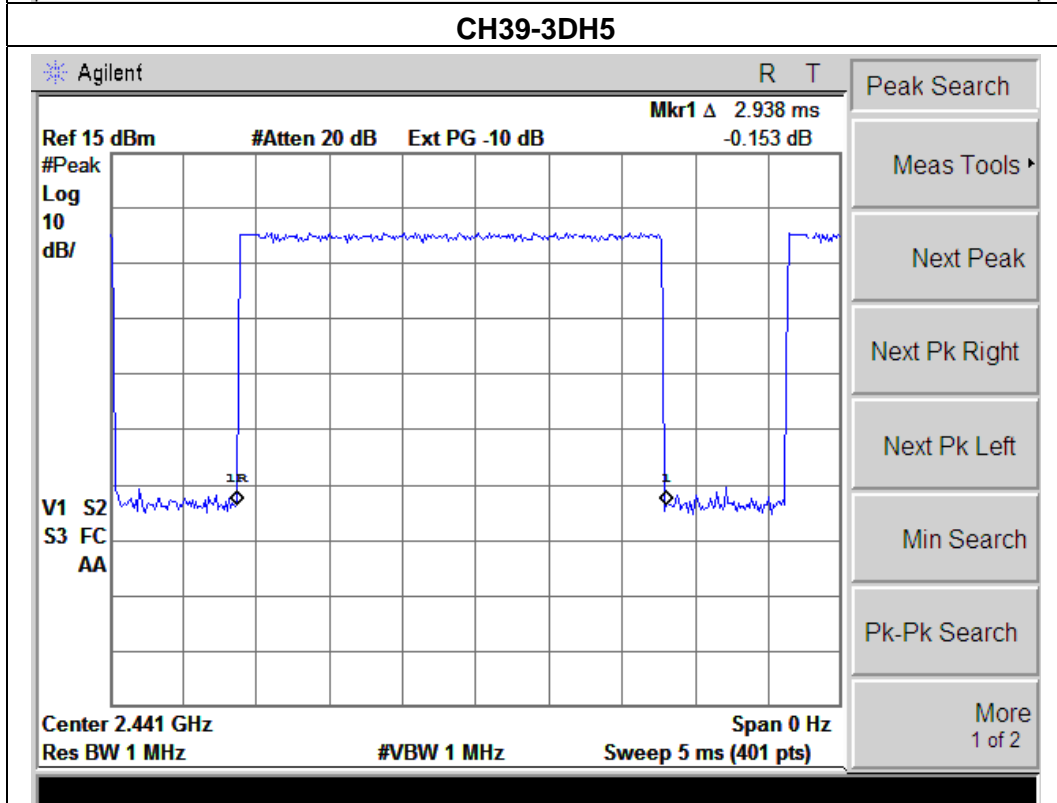
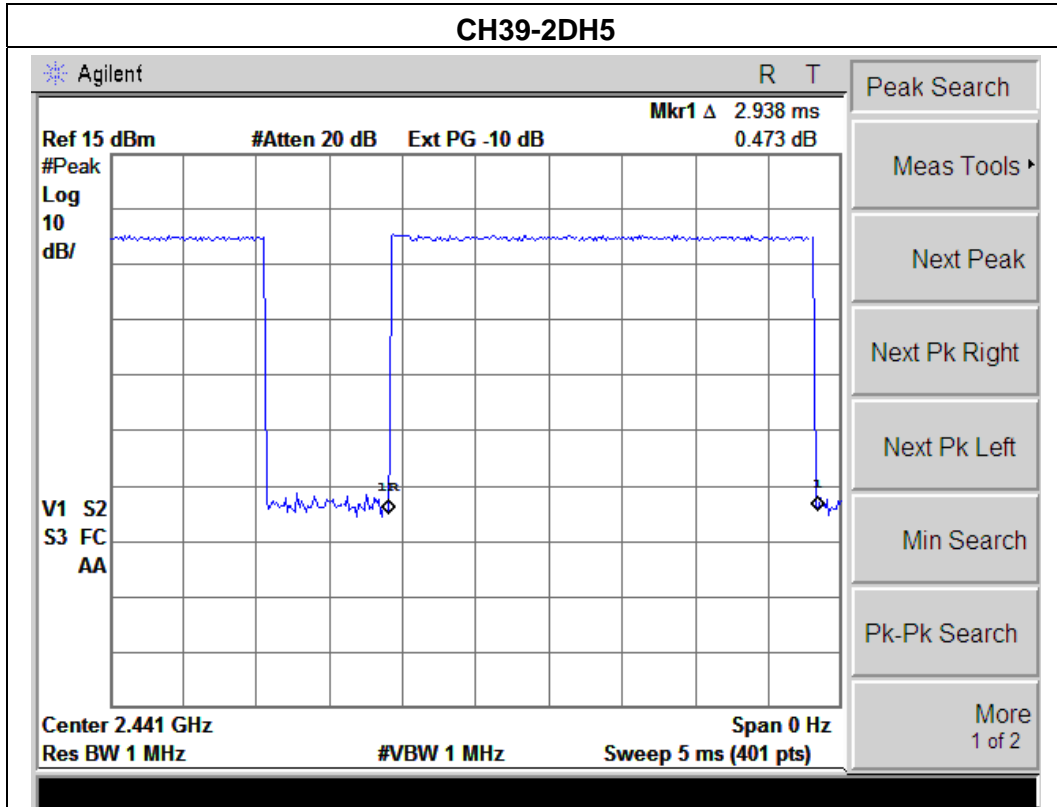

EUT :	Bluetooth speaker	Model Name :	SPB60
Temperature :	25 °C	Relative Humidity :	60%
Pressure :	1012 hPa	Test Voltage :	DC 3.7V
Test Mode :	CH39-DH3,2DH3,3DH3		

Data Packet	Frequency	Pulse Duration (ms)	Dwell Time (s)	Limits (s)
DH3	2441 MHz	1.72	0.18	0.4
2DH3	2441 MHz	1.69	0.18	0.4
3DH3	2441 MHz	1.70	0.18	0.4

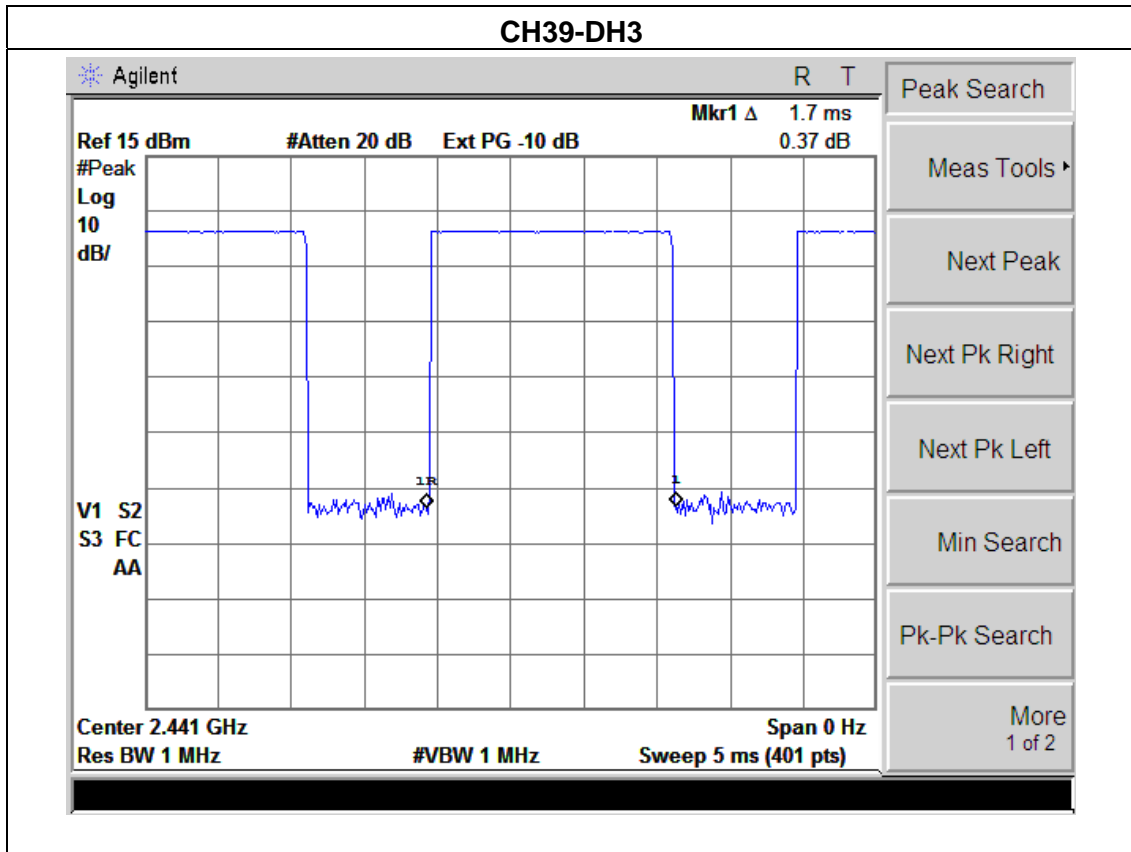

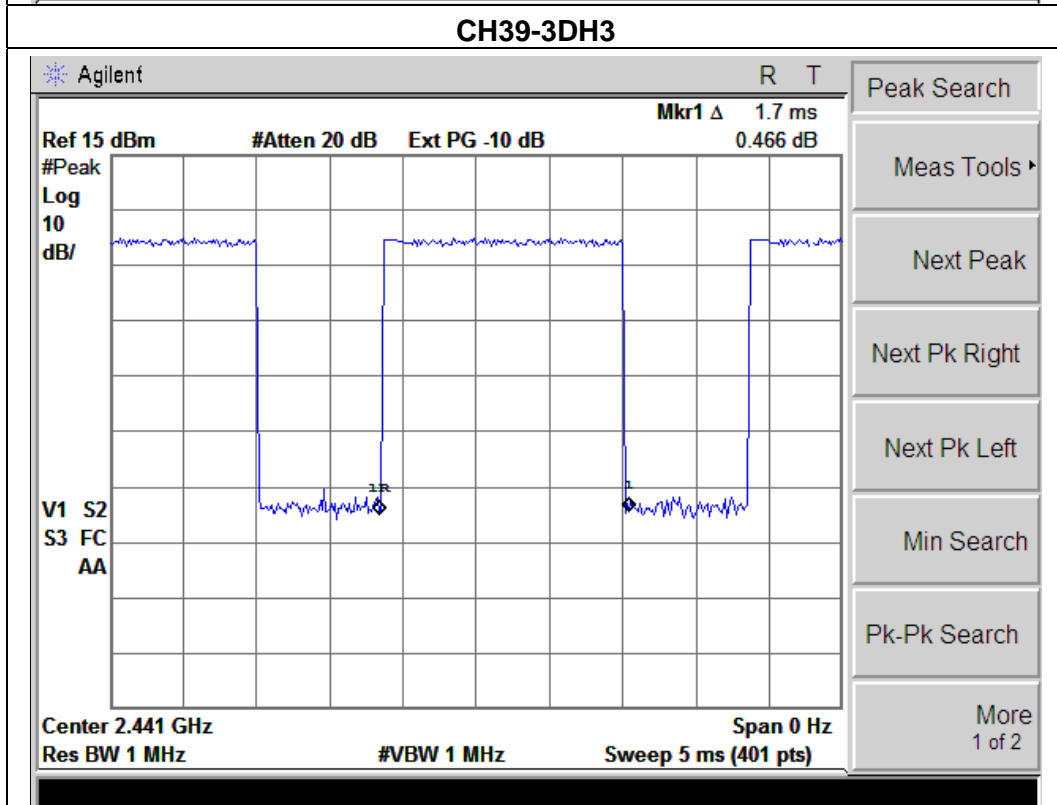
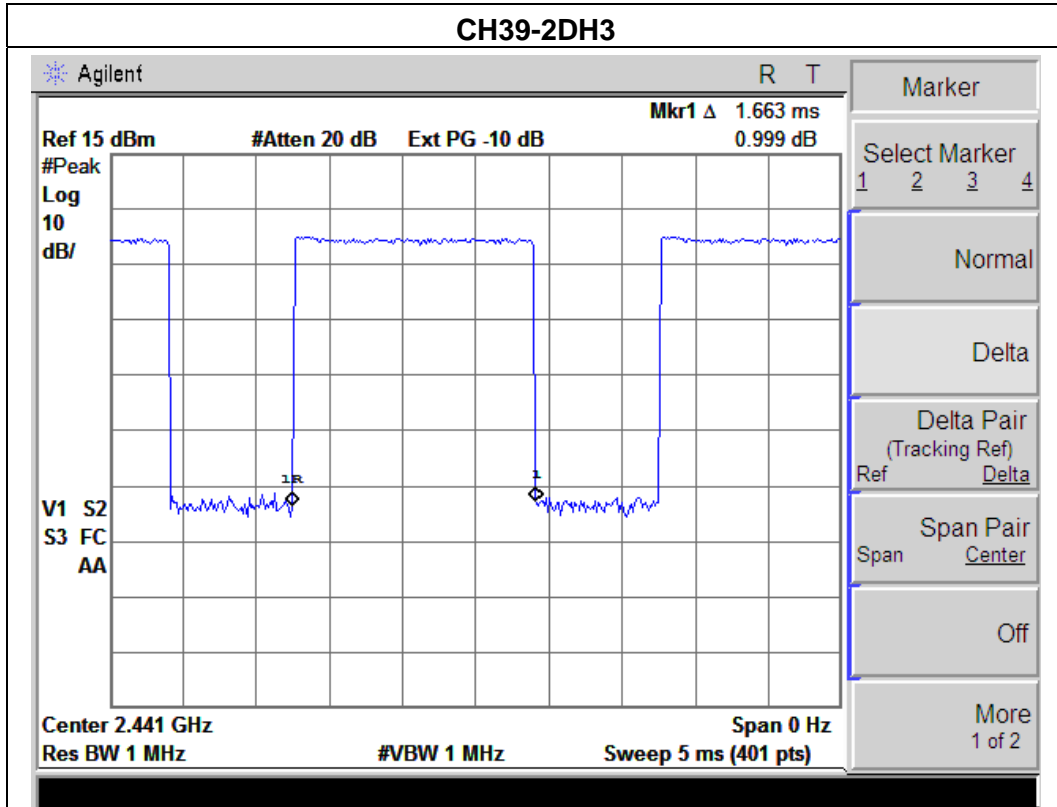

EUT :	Bluetooth speaker	Model Name :	SPB60
Temperature :	25 °C	Relative Humidity :	60%
Pressure :	1012 hPa	Test Voltage :	DC 3.7V
Test Mode :	CH39-DH1,2DH1,3DH1		

Data Packet	Frequency	Pulse Duration (ms)	Dwell Time (s)	Limits (s)
DH1	2441 MHz	0.45	0.05	0.4
2DH1	2441 MHz	0.45	0.05	0.4
3DH1	2441 MHz	0.46	0.05	0.4

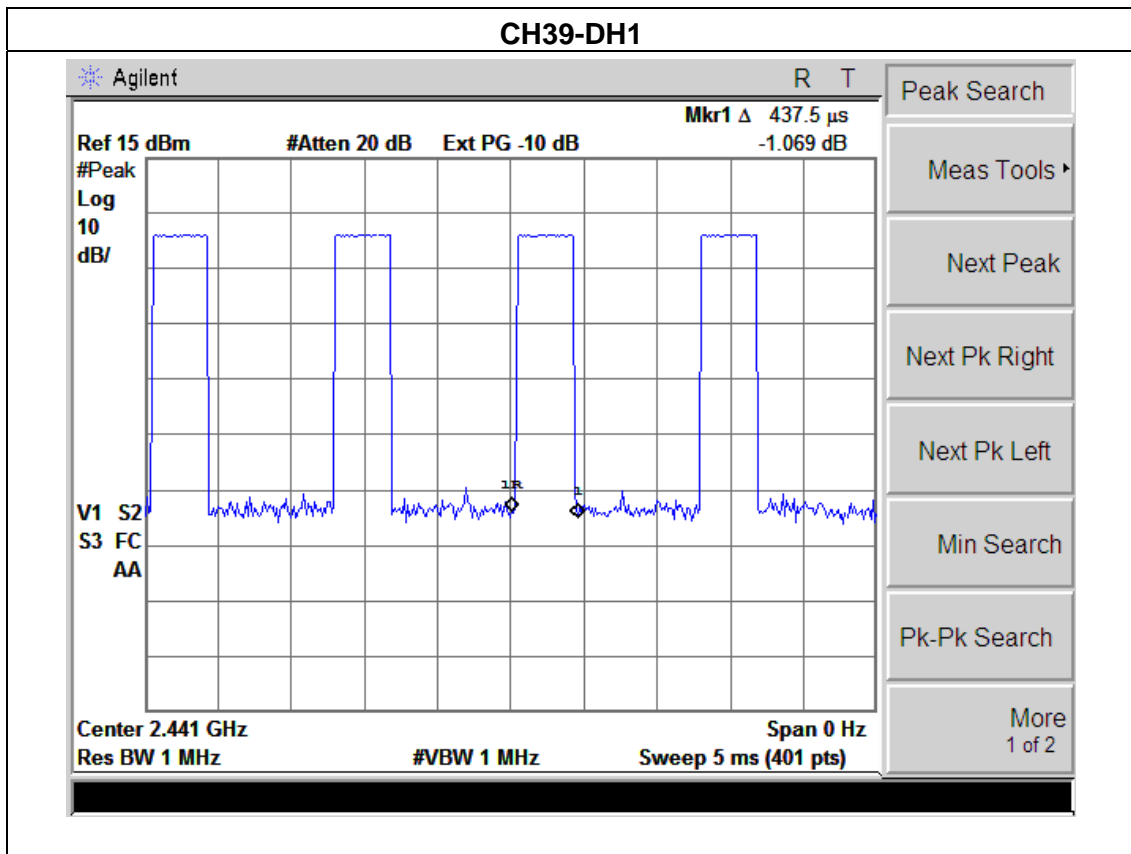

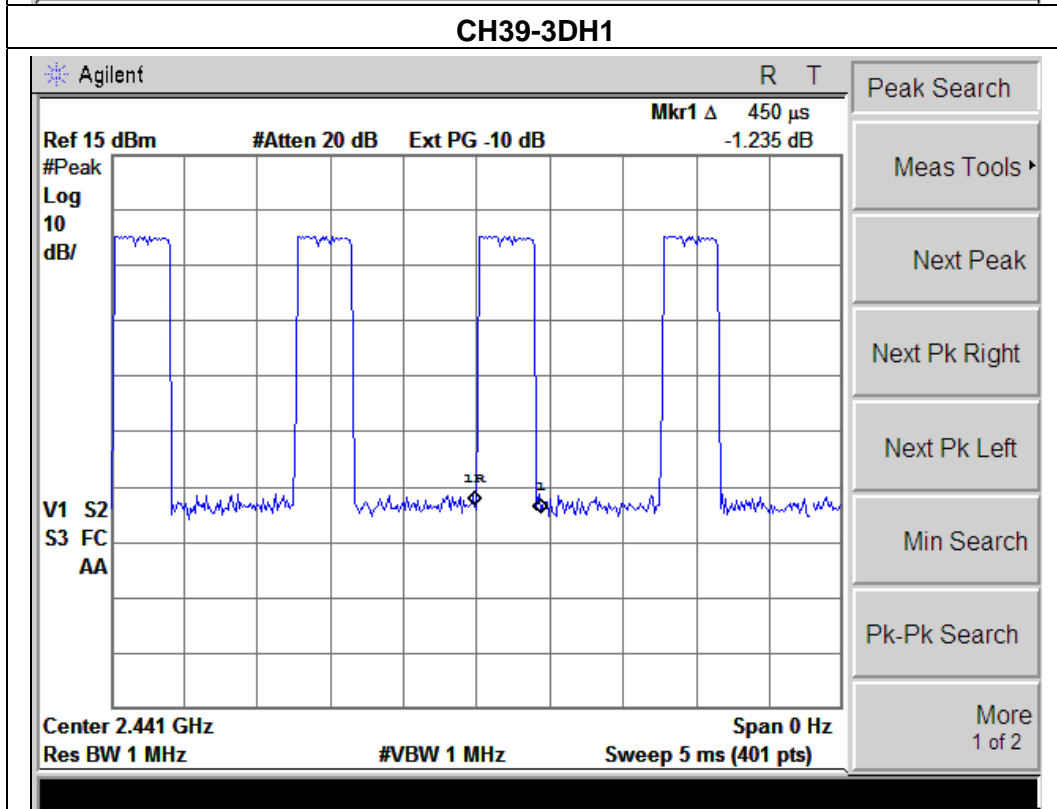
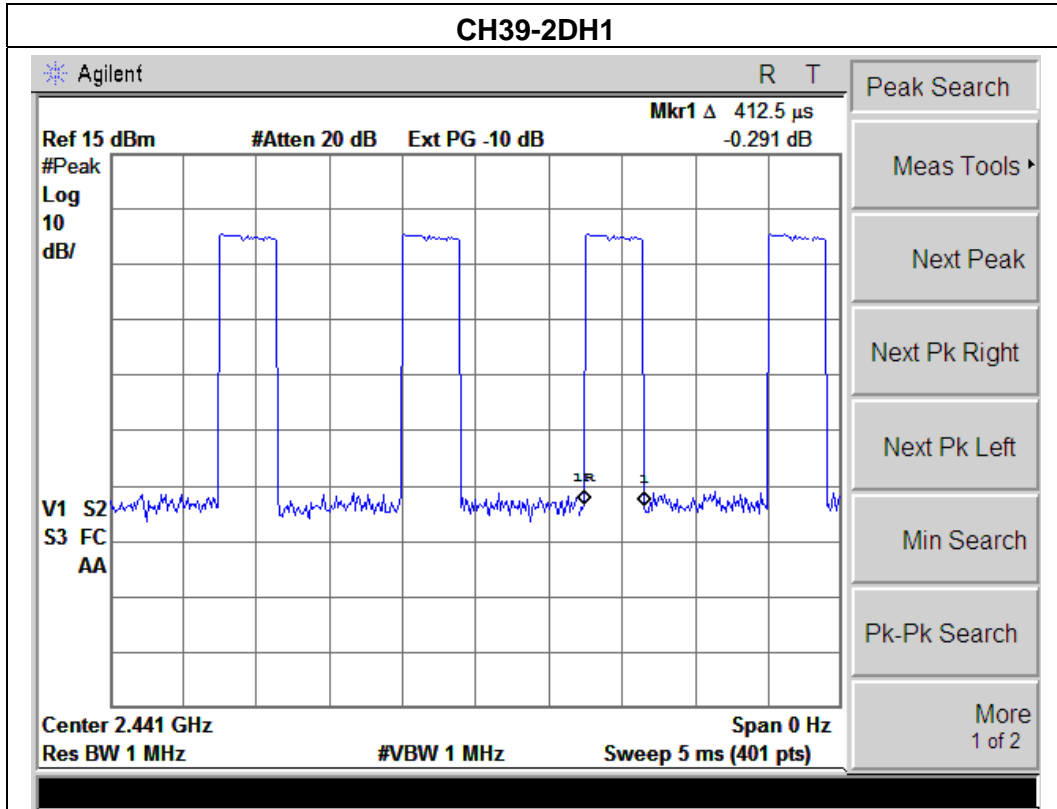

6. HOPPING CHANNEL SEPARATION MEASUREMENT

6.1 APPLIED PROCEDURES / LIMIT

Frequency hopping systems operating in the 2400-2483.5 MHz band may have hopping channel carrier frequencies that are separated by 25 kHz or two-thirds of the 20 dB bandwidth of the hopping channel, whichever is greater.

Spectrum Parameter	Setting
Attenuation	Auto
Span Frequency	> Measurement Bandwidth or Channel Separation
RB	30 kHz
VB	100 kHz
Detector	Peak
Trace	Max Hold
Sweep Time	Auto

6.1.1 TEST PROCEDURE

- a. The transmitter output (antenna port) was connected to the spectrum analyser in peak hold mode.
- b. The resolution bandwidth of 30 kHz and the video bandwidth of 100 kHz were utilised for channel separation measurement.

6.1.2 DEVIATION FROM STANDARD

No deviation.

6.1.3 TEST SETUP

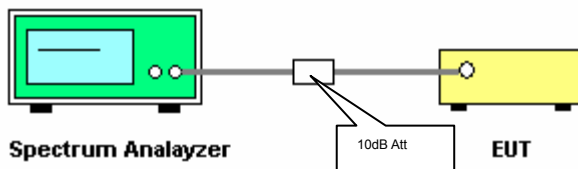

6.1.4 EUT OPERATION CONDITIONS

The EUT was programmed to be in continuously transmitting mode.

6.1.5 TEST RESULTS

EUT :	Bluetooth speaker	Model Name :	SPB60
Temperature :	25 °C	Relative Humidity :	60%
Pressure :	1012 hPa	Test Voltage :	DC 3.7V
Test Mode :	CH00 / CH39 /CH78 (1Mbps Mode)		

Frequency	Ch. Separation (MHz)	Result
2402 MHz	1.013	Complies
2441 MHz	1.005	Complies
2480 MHz	1.020	Complies

Ch. Separation Limits: >20dB bandwidth

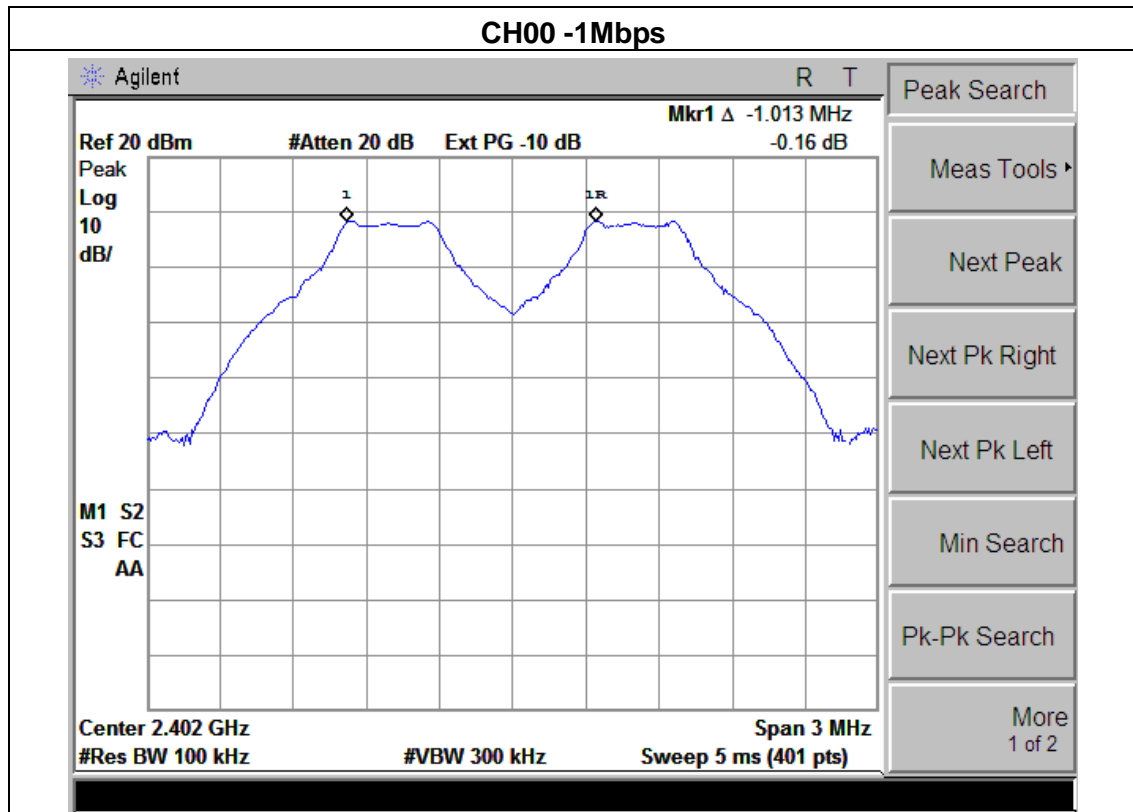

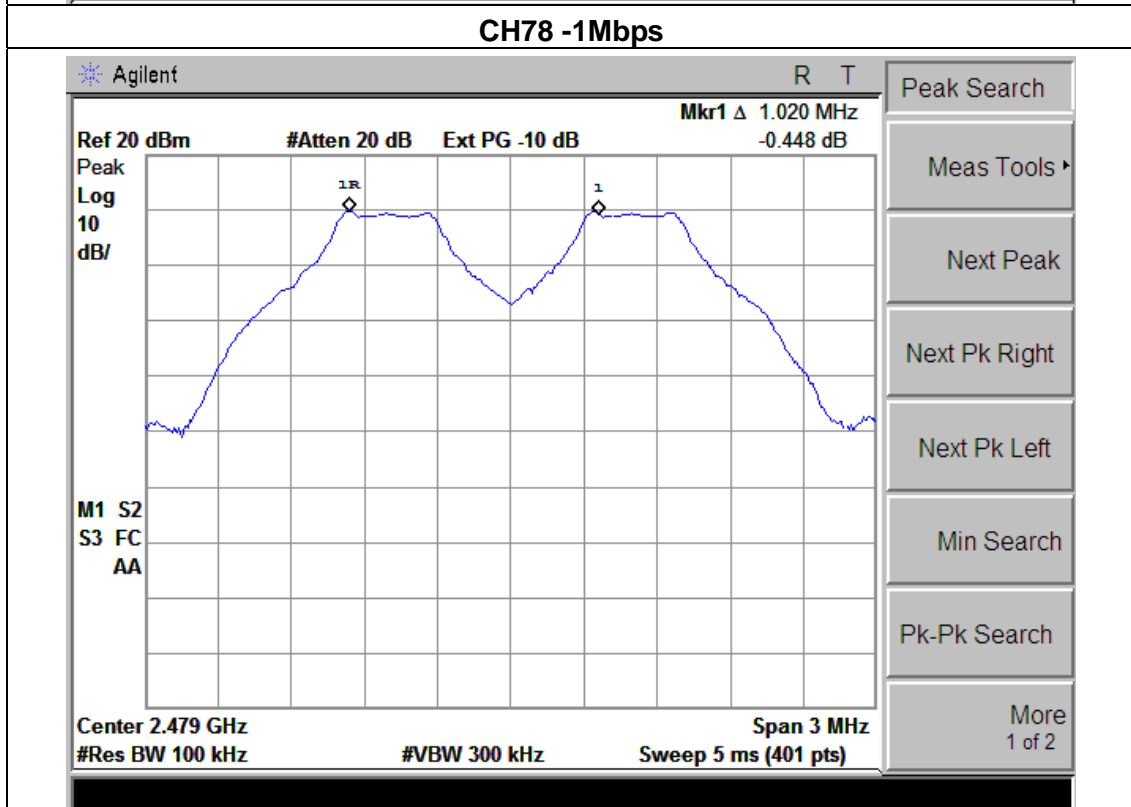
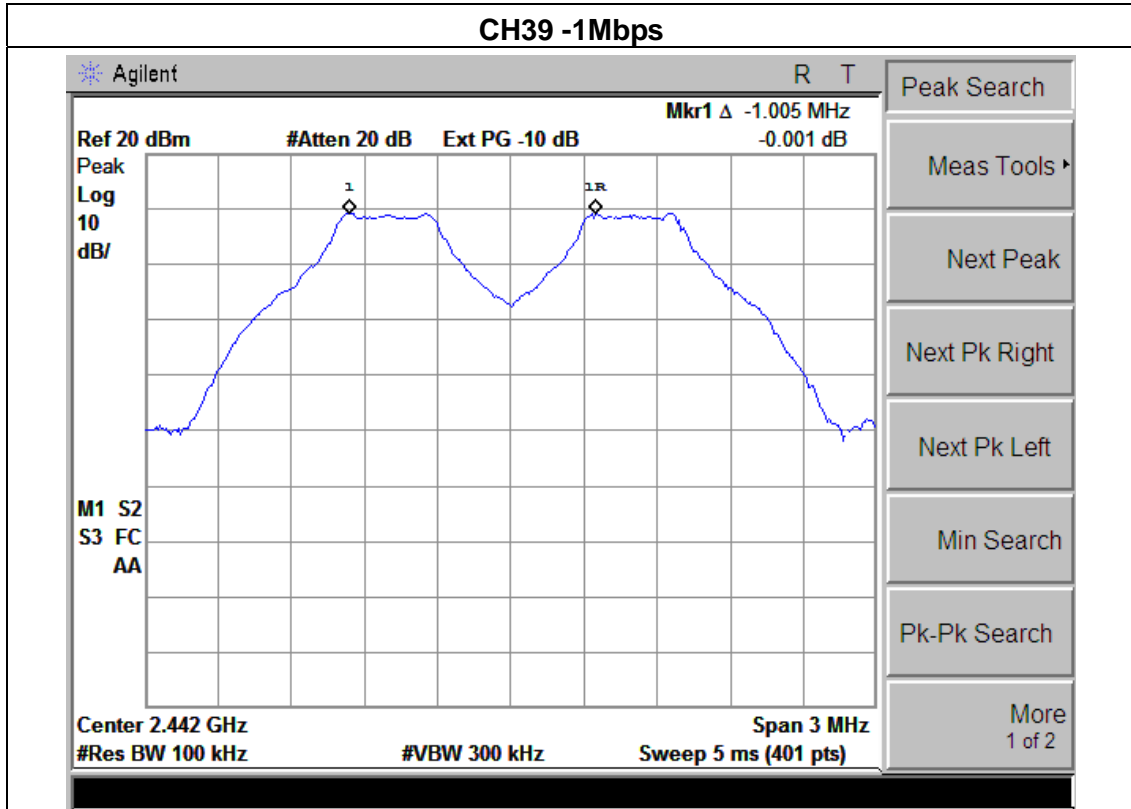

EUT :	Bluetooth speaker	Model Name :	SPB60
Temperature :	25 °C	Relative Humidity :	60%
Pressure :	1012 hPa	Test Voltage :	DC 3.7V
Test Mode :	CH00 / CH39 /CH78 (2Mbps Mode)		

Frequency	Ch. Separation (MHz)	Result
2402 MHz	1.005	Complies
2441 MHz	1.005	Complies
2480 MHz	1.006	Complies

Ch. Separation Limits: >2/3 of 20dB bandwidth

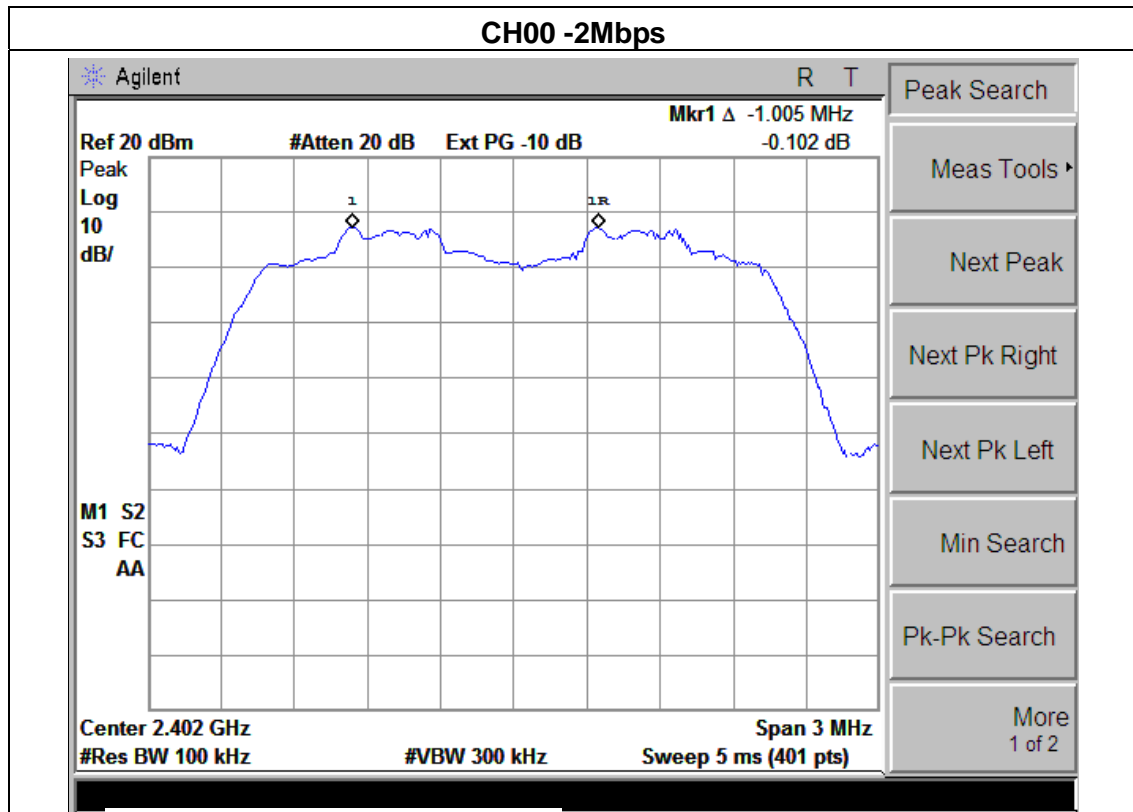

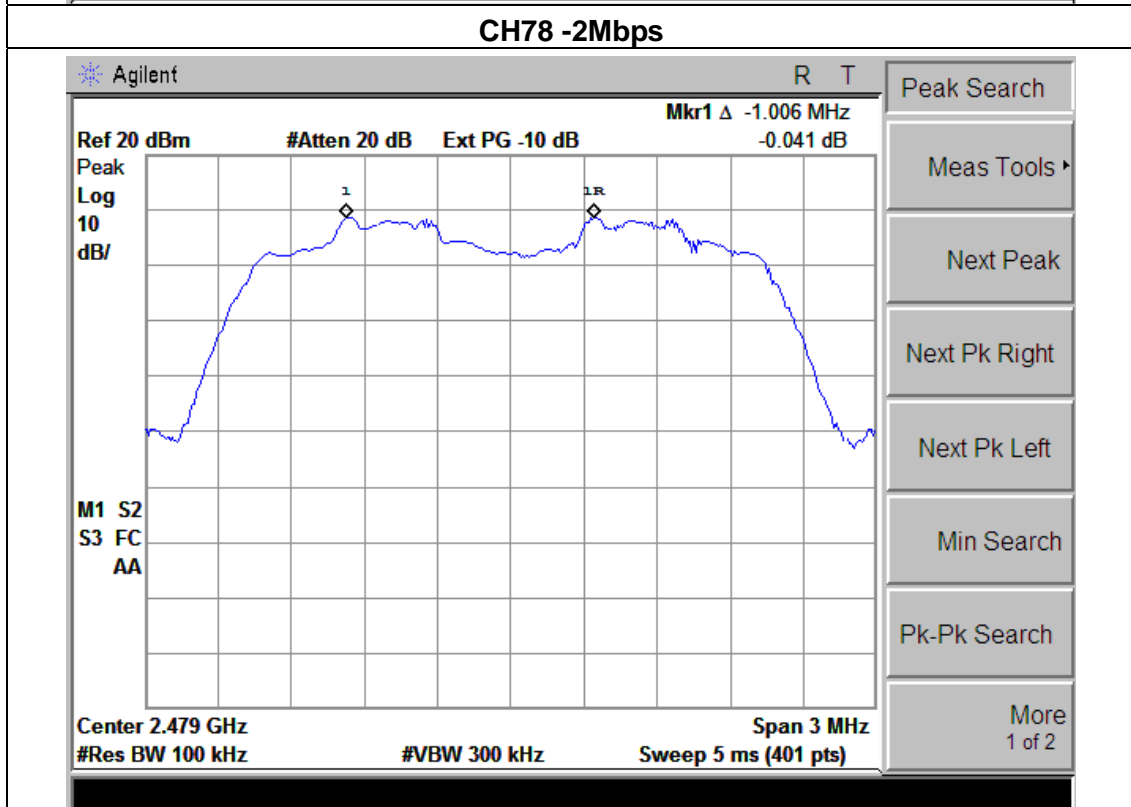
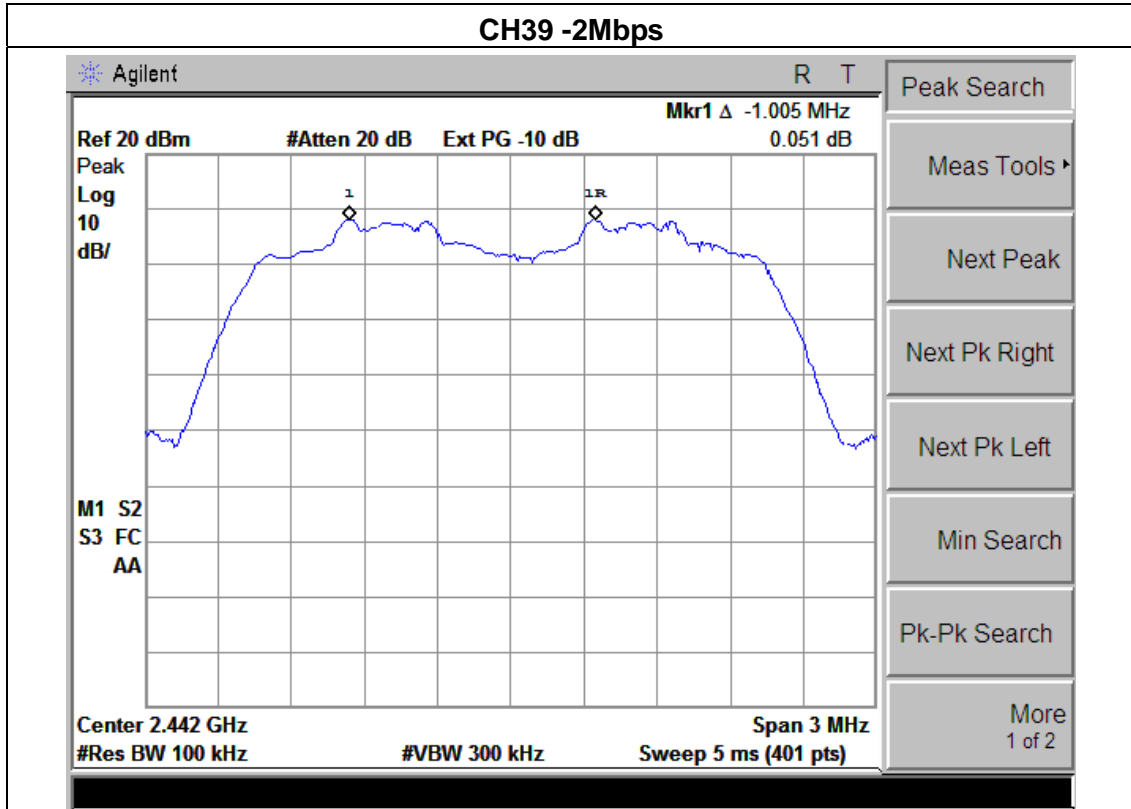

EUT :	Bluetooth speaker	Model Name :	SPB60
Temperature :	25 °C	Relative Humidity :	60%
Pressure :	1012 hPa	Test Voltage :	DC 3.7V
Test Mode :	CH00 / CH39 /CH78 (3Mbps Mode)		

Frequency	Ch. Separation (MHz)	Result
2402 MHz	1.006	Complies
2441 MHz	1.005	Complies
2480 MHz	1.005	Complies

Ch. Separation Limits: >2/3 of 20dB bandwidth

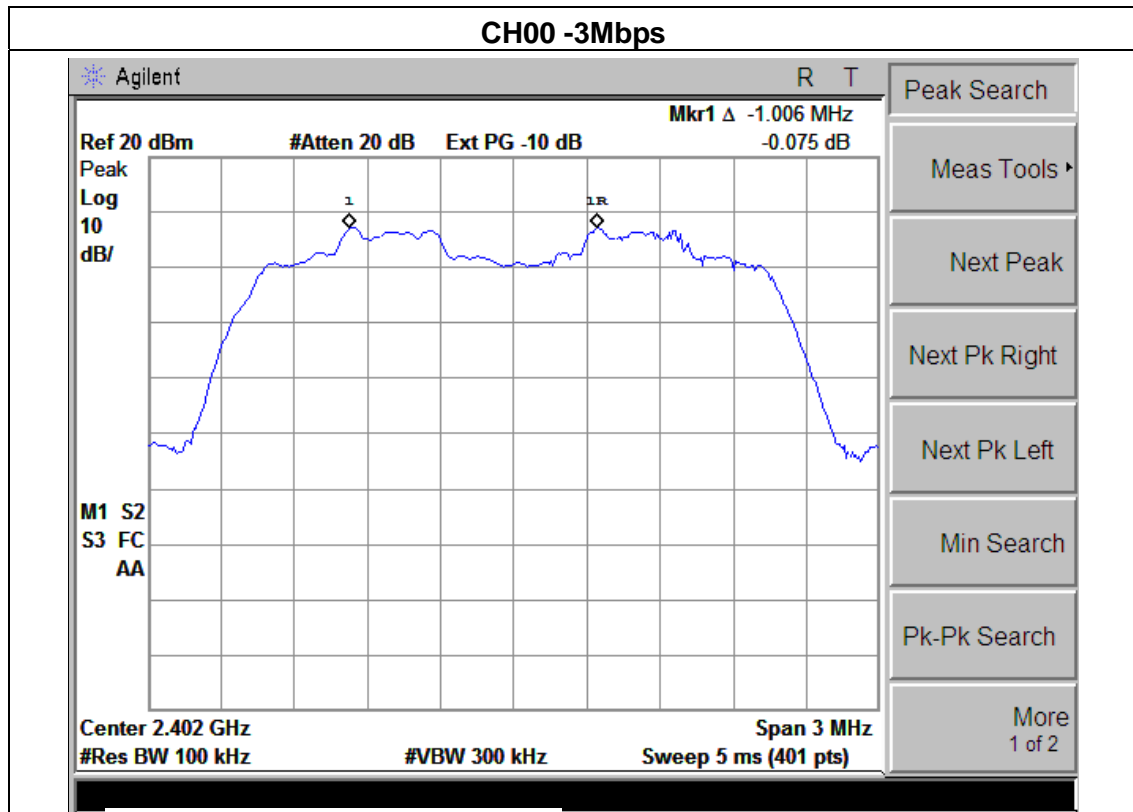

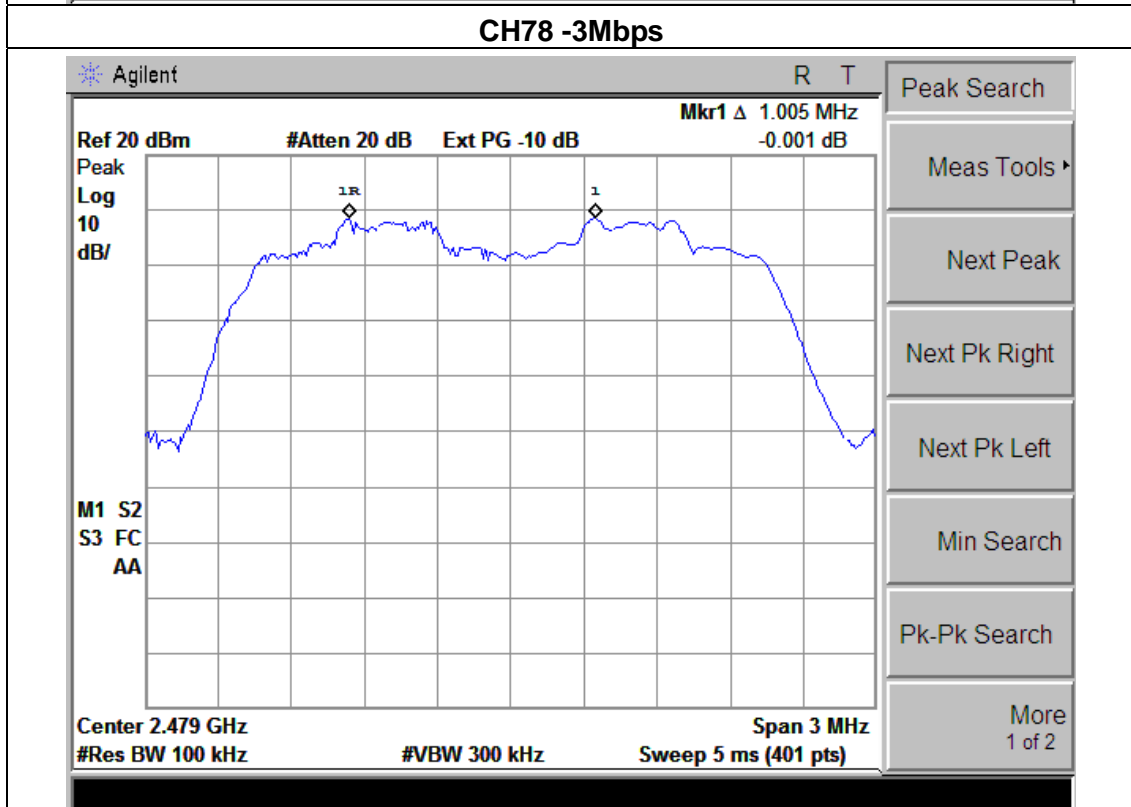
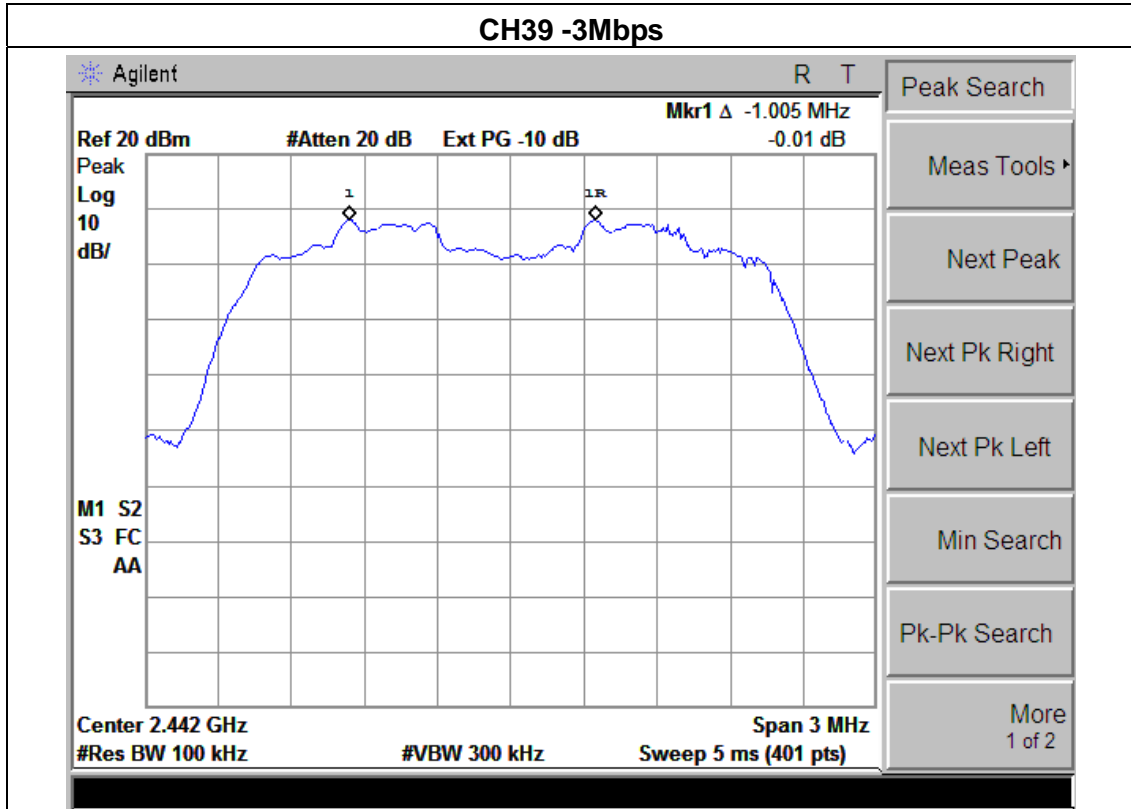

7. BANDWIDTH TEST

7.1 APPLIED PROCEDURES / LIMIT

FCC Part15 (15.247) , Subpart C			
Section	Test Item	Frequency Range (MHz)	Result
15.247 (a)(1)	Bandwidth	2400-2483.5	PASS

Spectrum Parameter	Setting
Attenuation	Auto
Span Frequency	> Measurement Bandwidth or Channel Separation
RB	30 kHz
VB	100 kHz
Detector	Peak
Trace	Max Hold
Sweep Time	Auto

7.1.1 TEST PROCEDURE

- a. The EUT was directly connected to the spectrum analyzer and antenna output port as show in the block diagram below,
- b. Spectrum Setting : RBW= 30KHz, VBW=100KHz, Sweep time = Auto.

7.1.2 DEVIATION FROM STANDARD

No deviation.

7.1.3 TEST SETUP

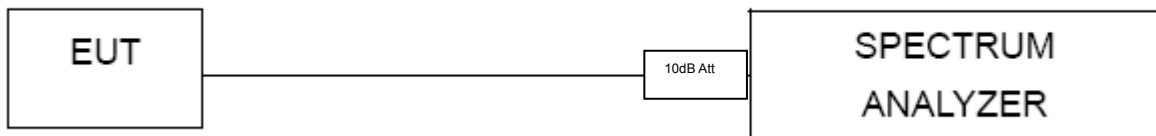

7.1.4 EUT OPERATION CONDITIONS

The EUT tested system was configured as the statements of 2.4 Unless otherwise a special operating condition is specified in the follows during the testing.

7.1.5 TEST RESULTS

EUT :	Bluetooth speaker	Model Name :	SPB60
Temperature :	25 °C	Relative Humidity :	60%
Pressure :	1012 hPa	Test Voltage :	DC 3.7V
Test Mode :	CH00 / CH39 /CH78(1Mbps)		

Frequency	20dB Bandwidth (kHz)	Result
2402 MHz	933.510	PASS
2441 MHz	933.204	PASS
2480 MHz	929.440	PASS

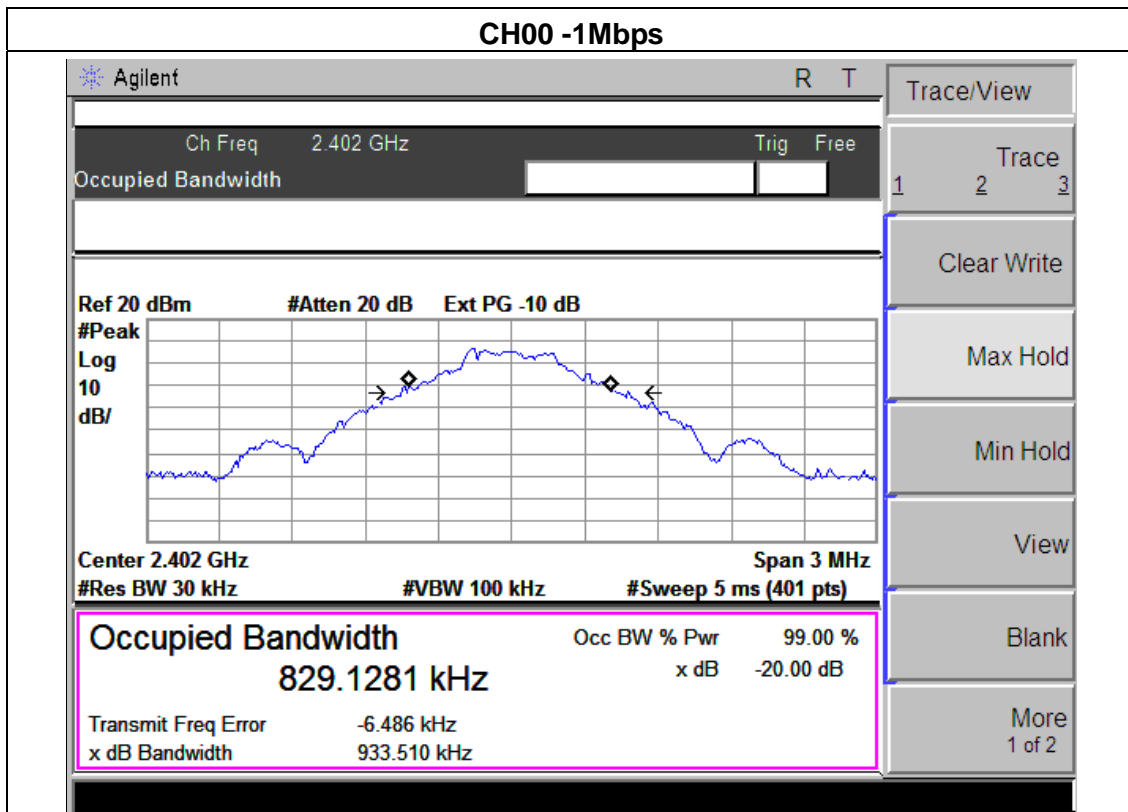

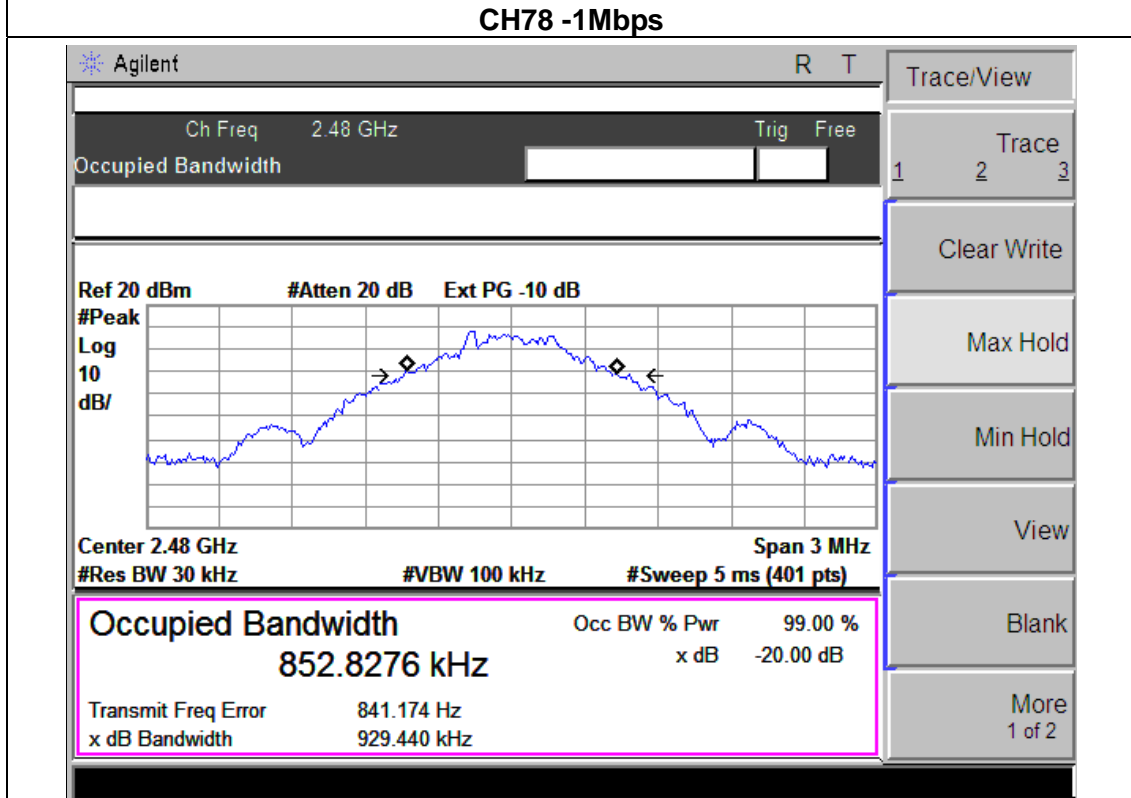
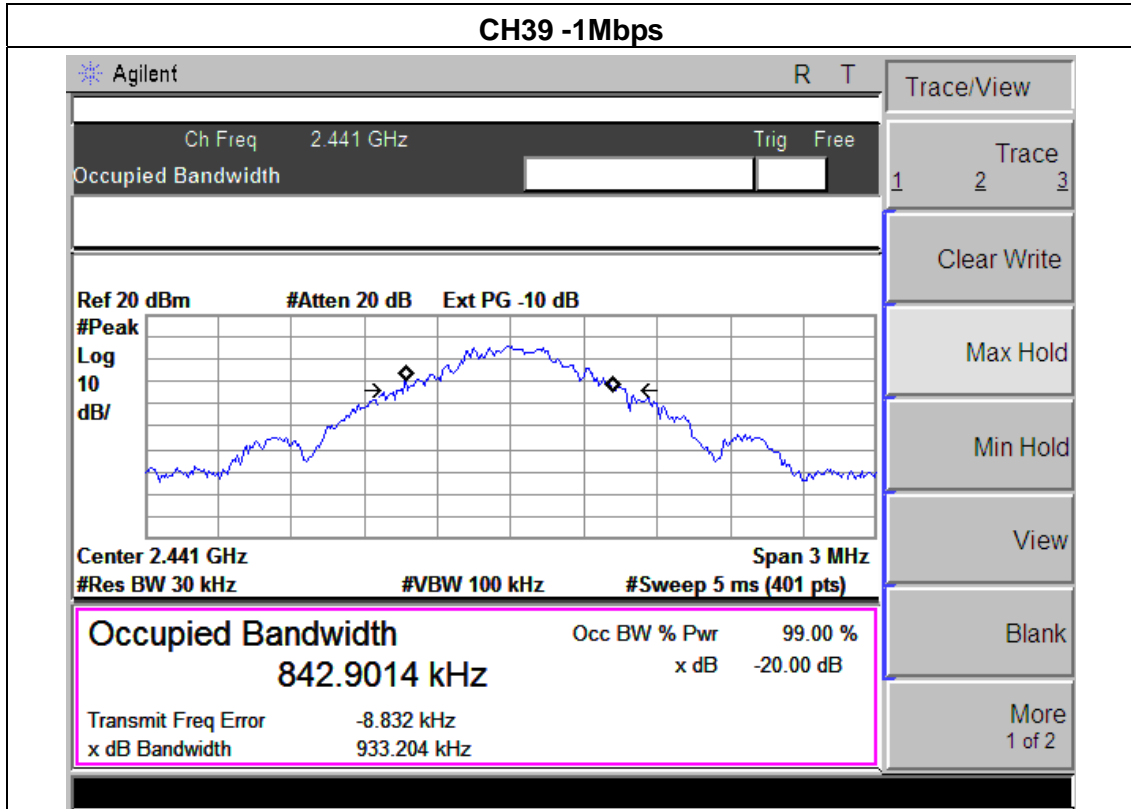

EUT :	Bluetooth speaker	Model Name :	SPB60
Temperature :	25 °C	Relative Humidity :	60%
Pressure :	1012 hPa	Test Voltage :	DC 3.7V
Test Mode :	CH00 / CH39 /CH78(2Mbps)		

Frequency	20dB Bandwidth (MHz)	Result
2402 MHz	1.239	PASS
2441 MHz	1.258	PASS
2480 MHz	1.211	PASS

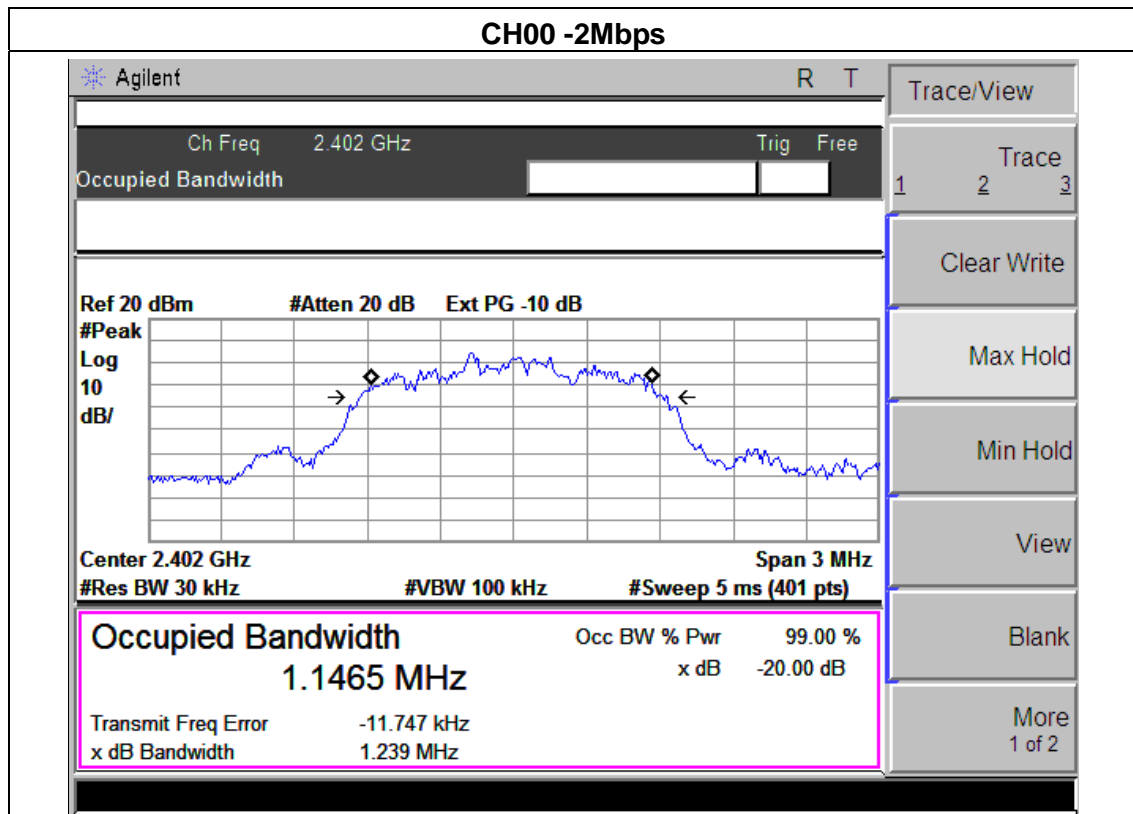

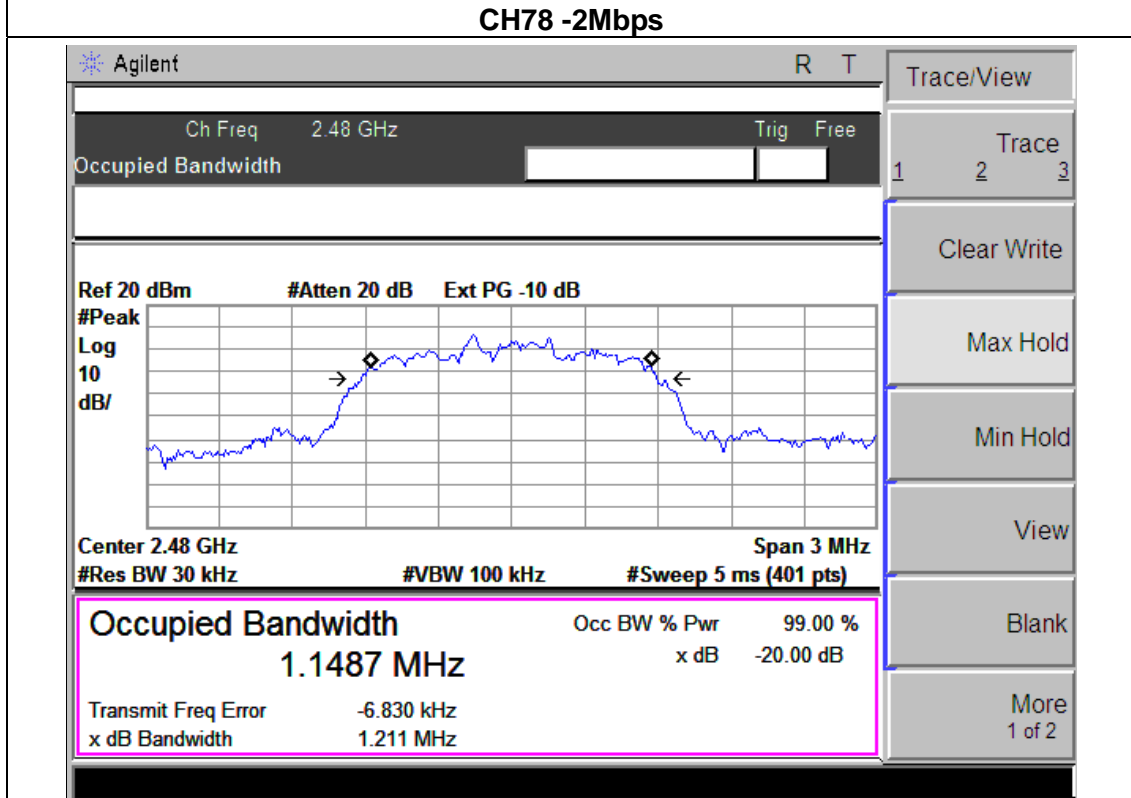
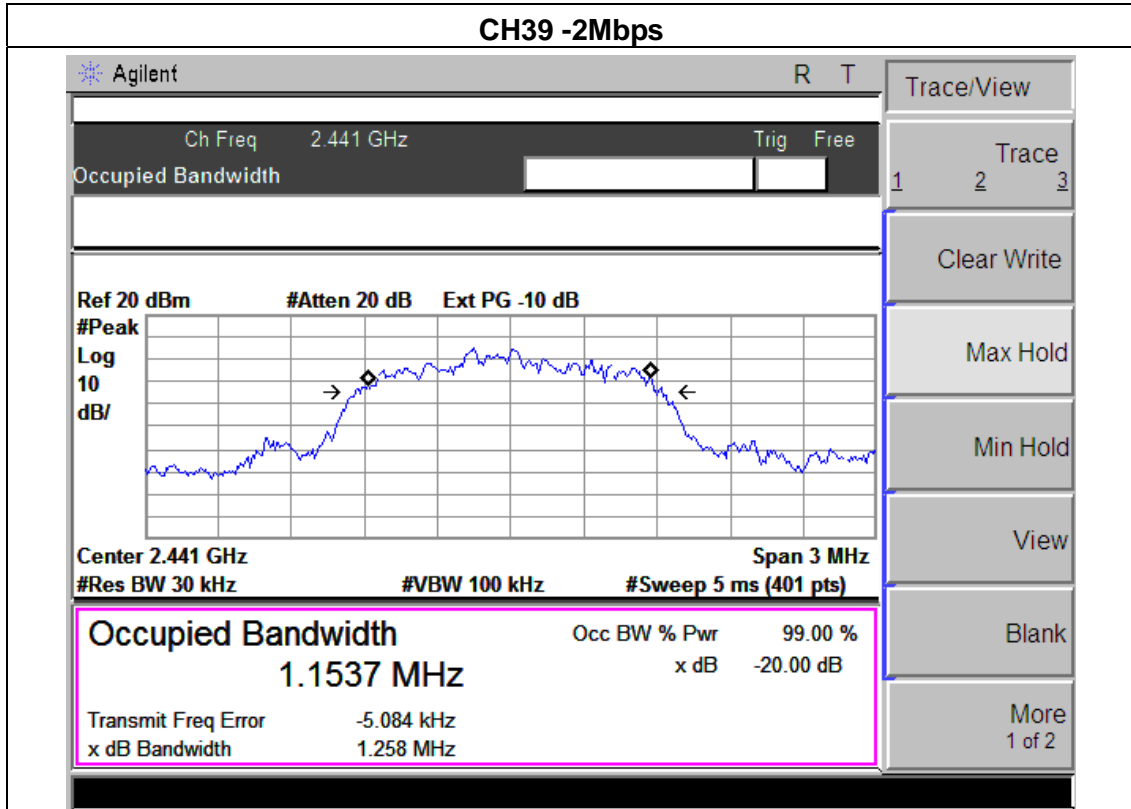

EUT :	Bluetooth speaker	Model Name :	SPB60
Temperature :	25 °C	Relative Humidity :	60%
Pressure :	1012 hPa	Test Voltage :	DC 3.7V
Test Mode :	CH00 / CH39 /CH78(3Mbps)		

Frequency	20dB Bandwidth (MHz)	Result
2402 MHz	1.247	PASS
2441 MHz	1.247	PASS
2480 MHz	1.244	PASS

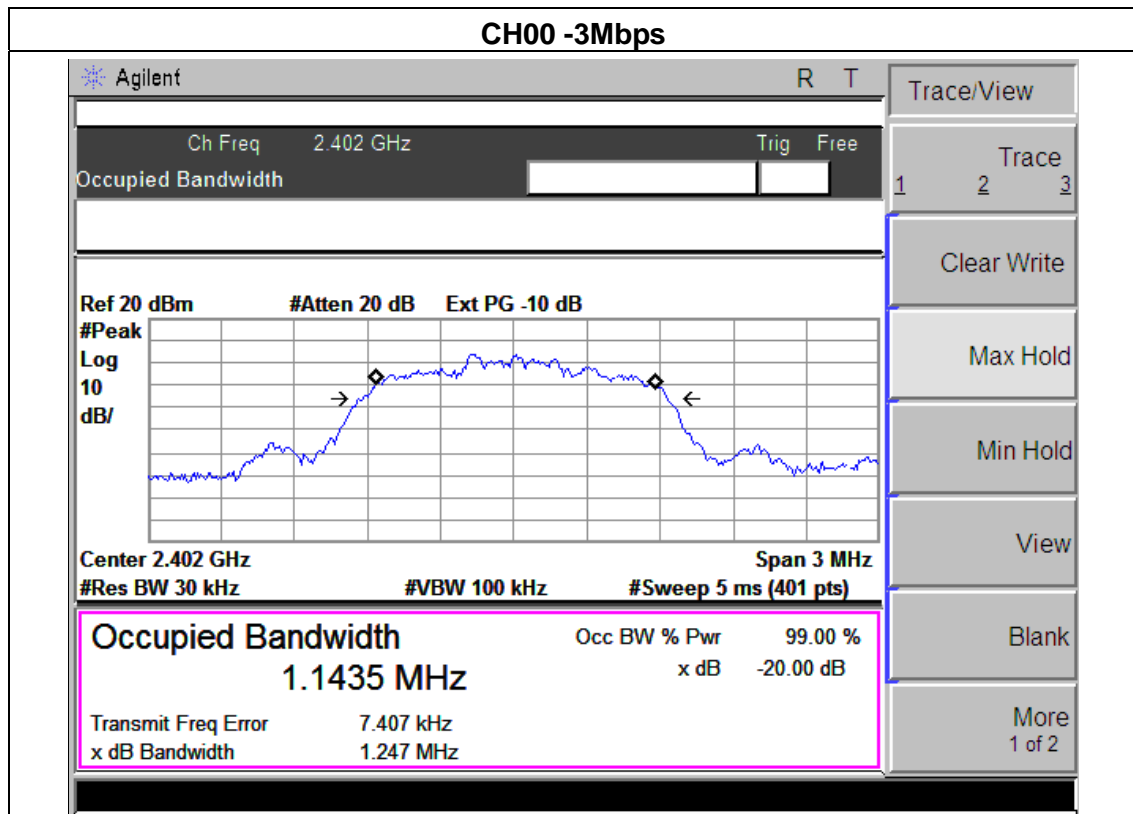

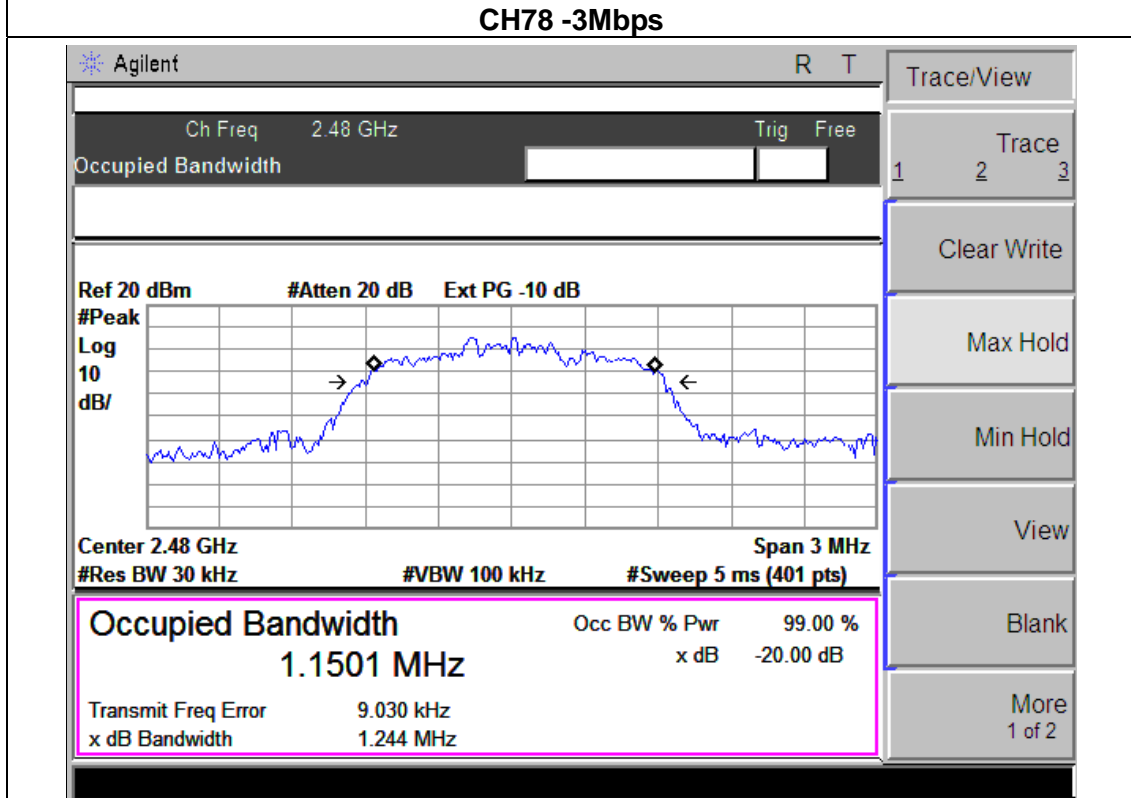
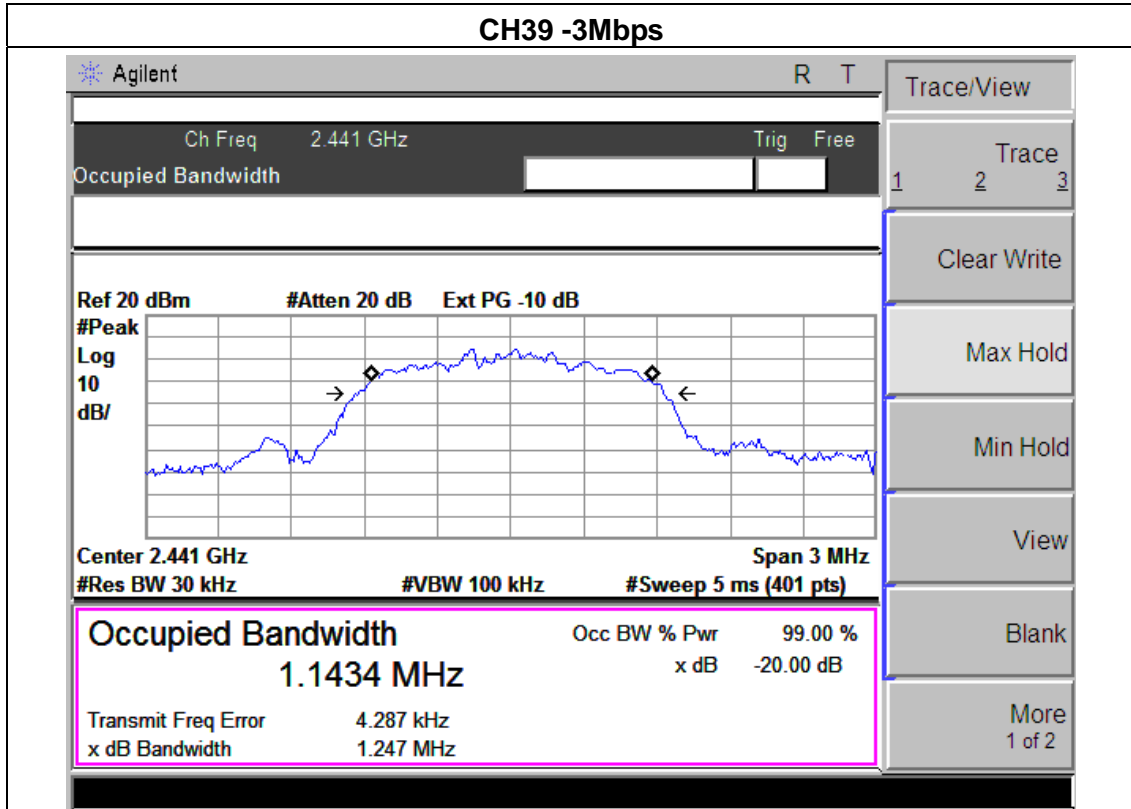

8. PEAK OUTPUT POWER TEST

8.1 APPLIED PROCEDURES / LIMIT

FCC Part15 (15.247) , Subpart C				
Section	Test Item	Limit	Frequency Range (MHz)	Result
15.247 (b)(i)	Peak Output Power	0.125 w or 1w	2400-2483.5	PASS

8.1.1 TEST PROCEDURE

- a. The EUT was directly connected to the spectrum analyzer and antenna output port as show in the block diagram below,
- b. Spectrum Setting : RBW > the 20 dB bandwidth of the emission being measured
 - Span = approximately 5 times the 20 dB bandwidth, centered on a hopping channel
 - VBW ≥ RBW
 - Sweep = auto
 - Detector function = peak
 - Trace = max hold

8.1.2 DEVIATION FROM STANDARD

No deviation.

8.1.3 TEST SETUP

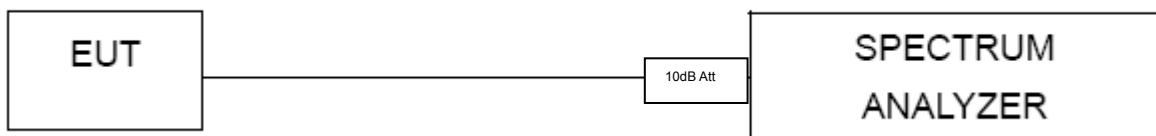

8.1.4 EUT OPERATION CONDITIONS

The EUT tested system was configured as the statements of 2.4 Unless otherwise a special operating condition is specified in the follows during the testing.

8.1.5 TEST RESULTS

EUT :	Bluetooth speaker	Model Name :	SPB60
Temperature :	25 °C	Relative Humidity :	60%
Pressure :	1012 hPa	Test Voltage :	DC 3.7V
Test Mode :	CH00/ CH39 /CH78 (1M/2M/3Mbps Mode)		

1Mbps			
Test Channel	Frequency (MHz)	Peak Output Power (dBm)	LIMIT (dBm)
CH00	2402	0.532	30
CH39	2441	1.441	30
CH78	2480	1.841	30
2Mbps			
CH00	2402	0.113	20.96
CH39	2441	0.986	20.96
CH78	2480	1.515	20.96
3Mbps			
CH00	2402	0.483	20.96
CH39	2441	1.414	20.96
CH78	2480	1.860	20.96

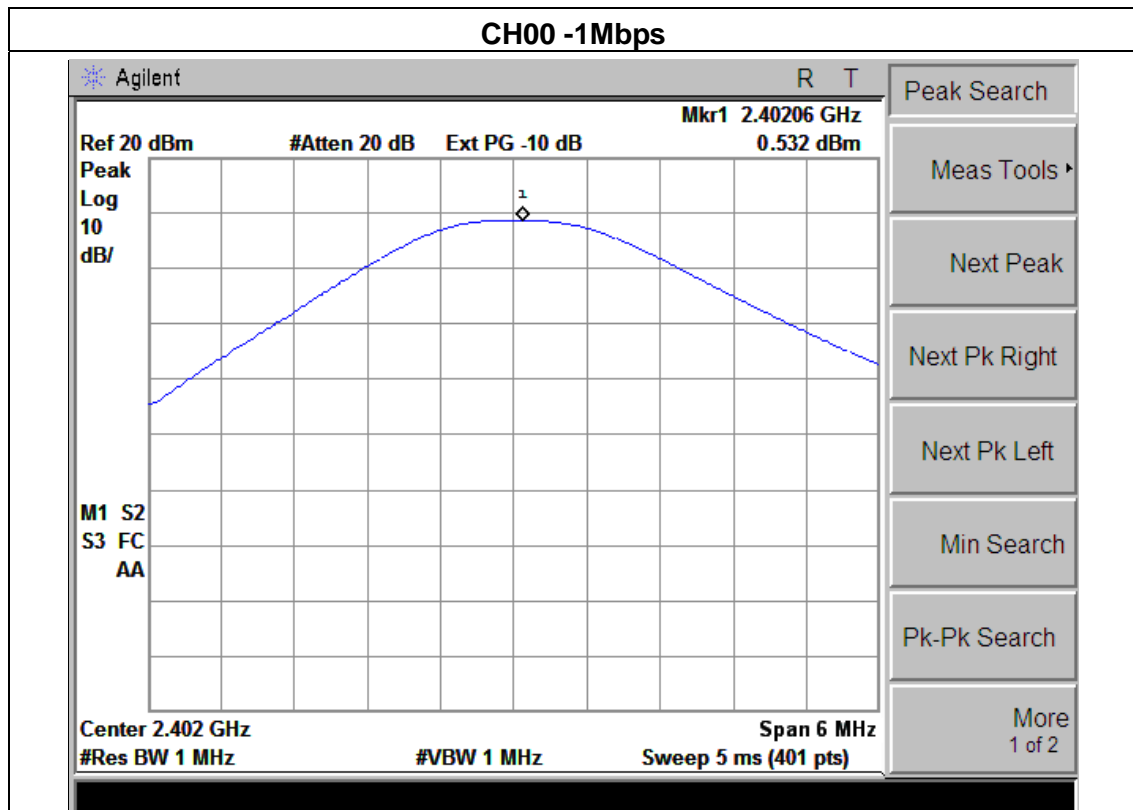

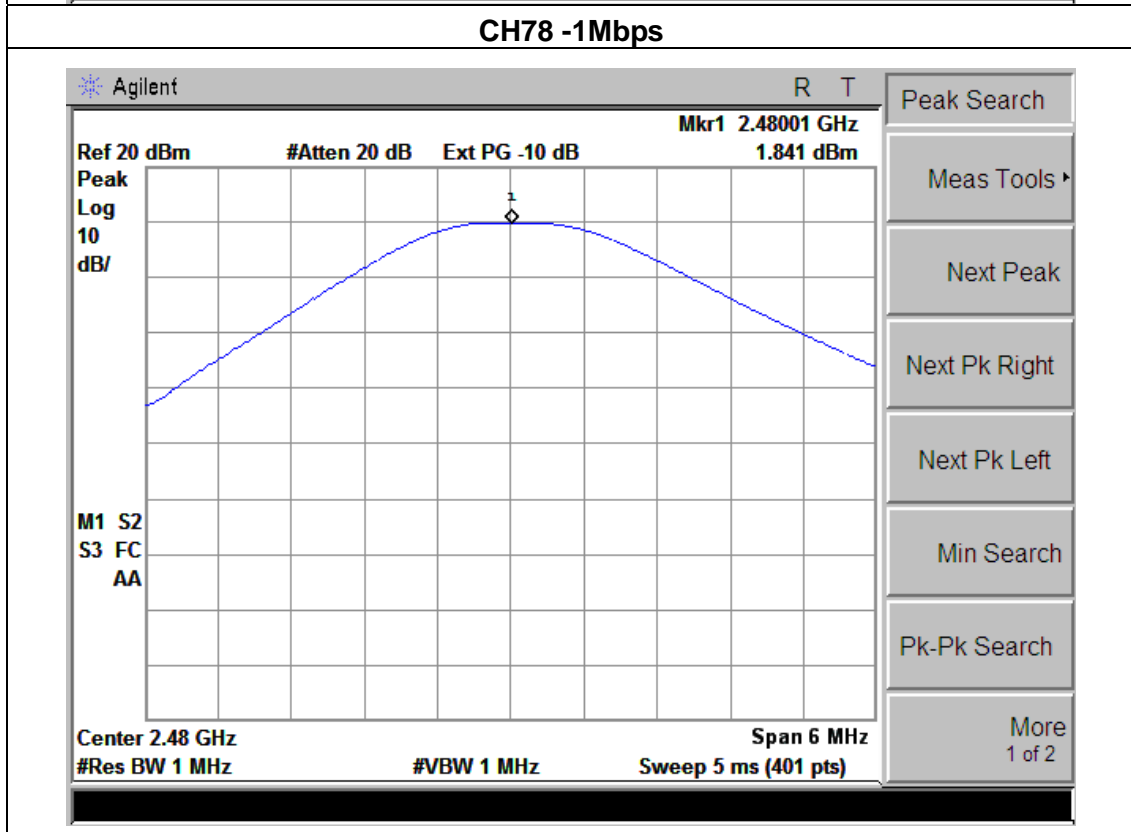
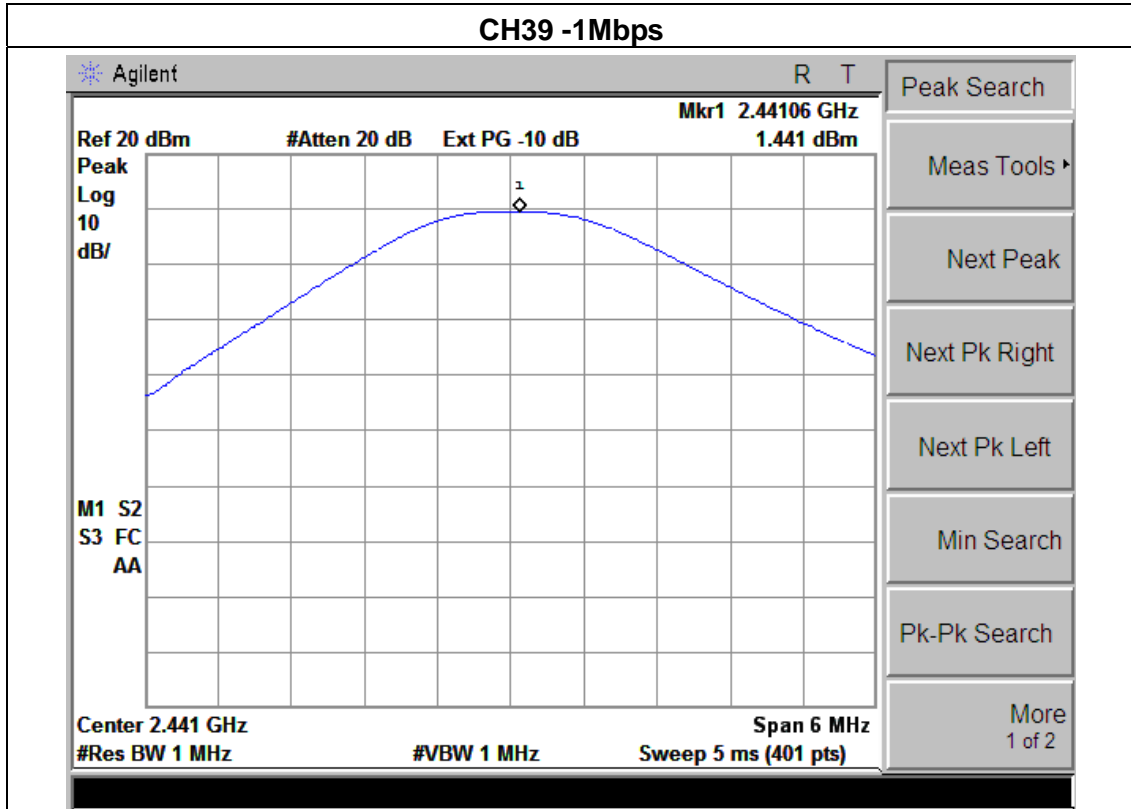

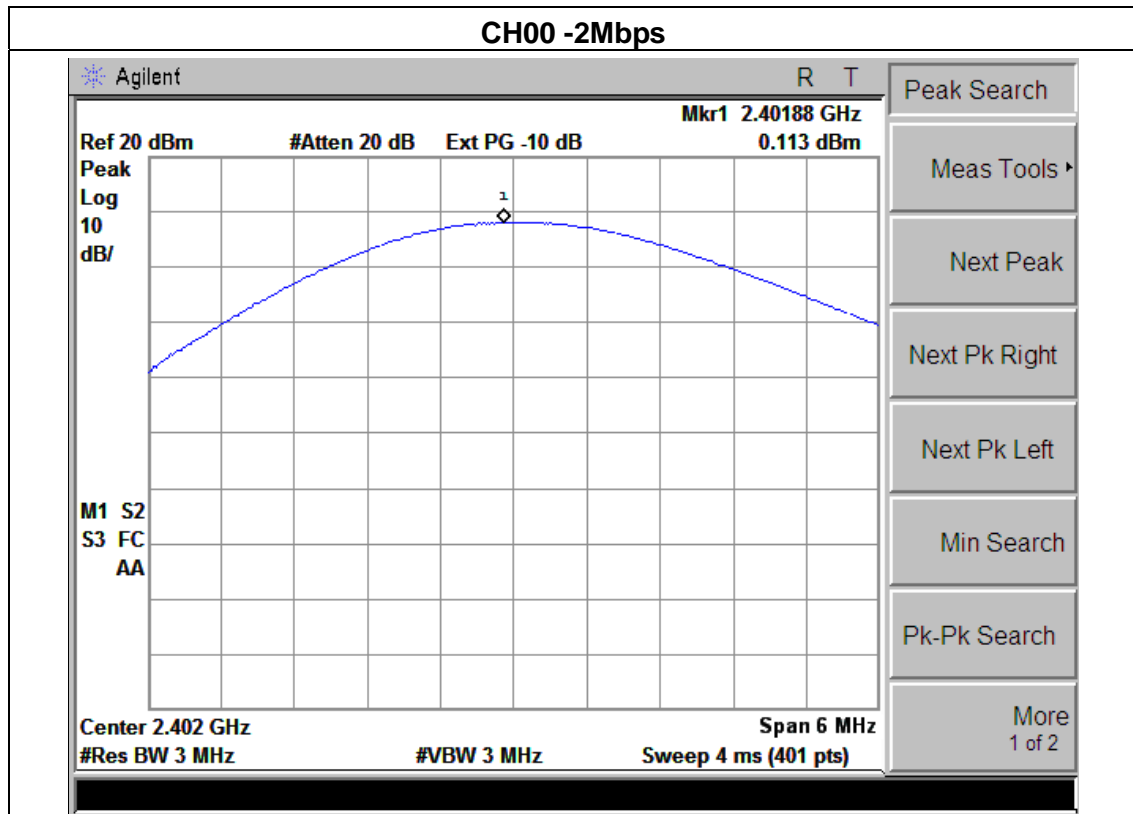

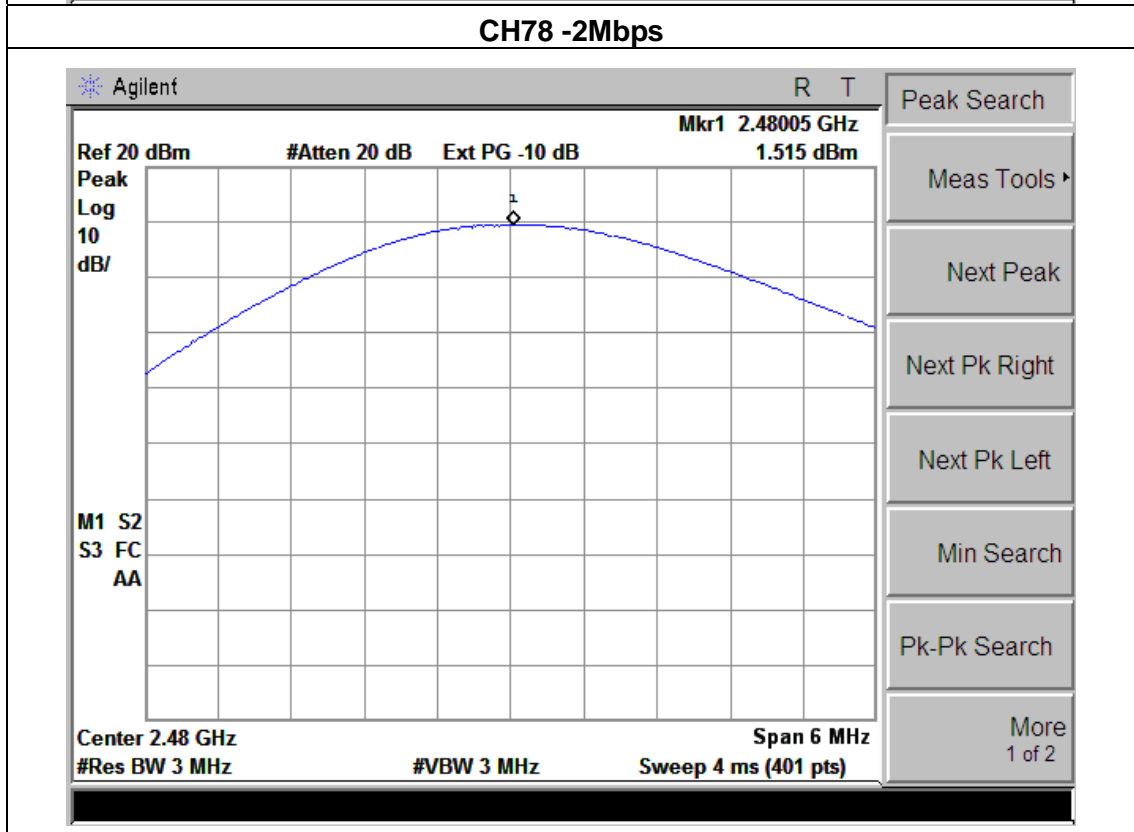
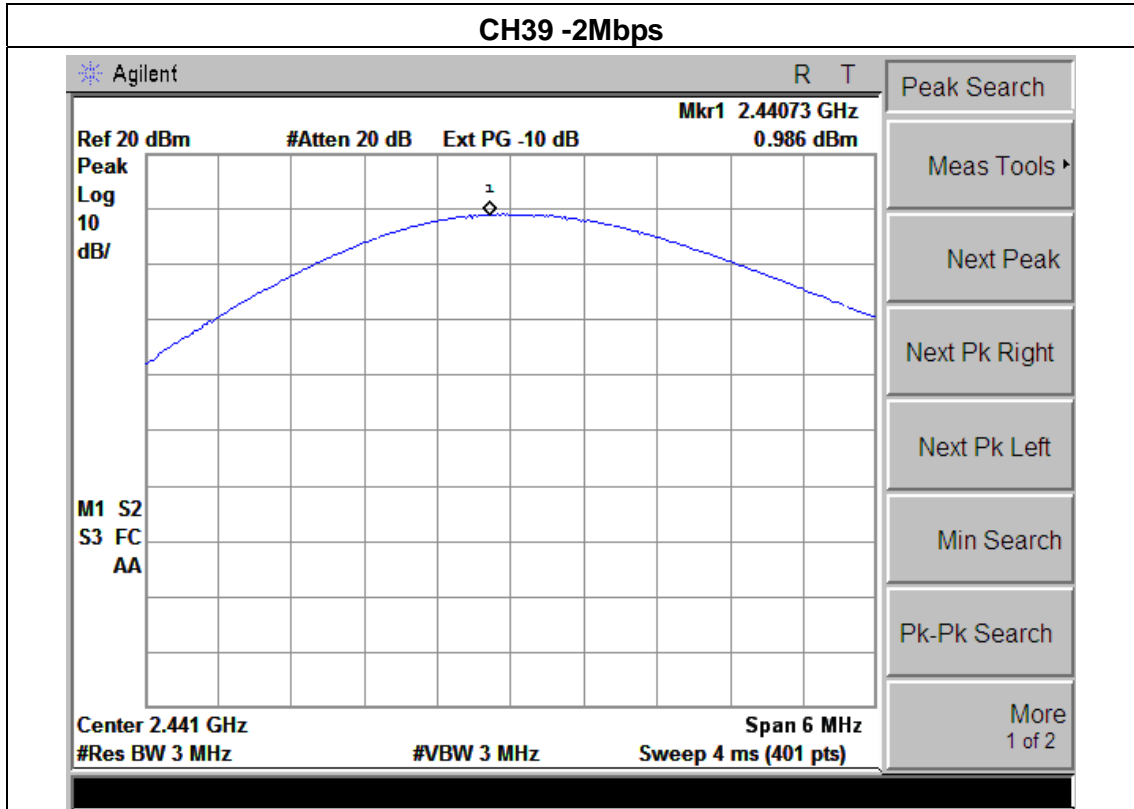

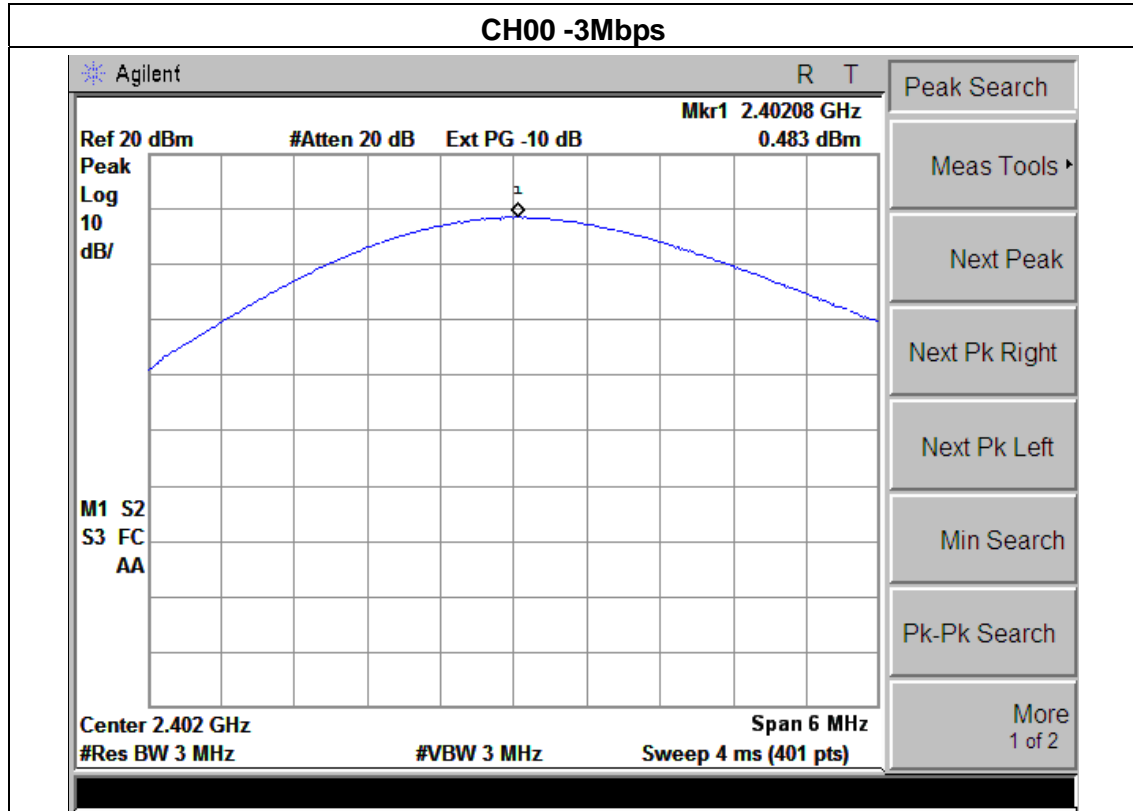

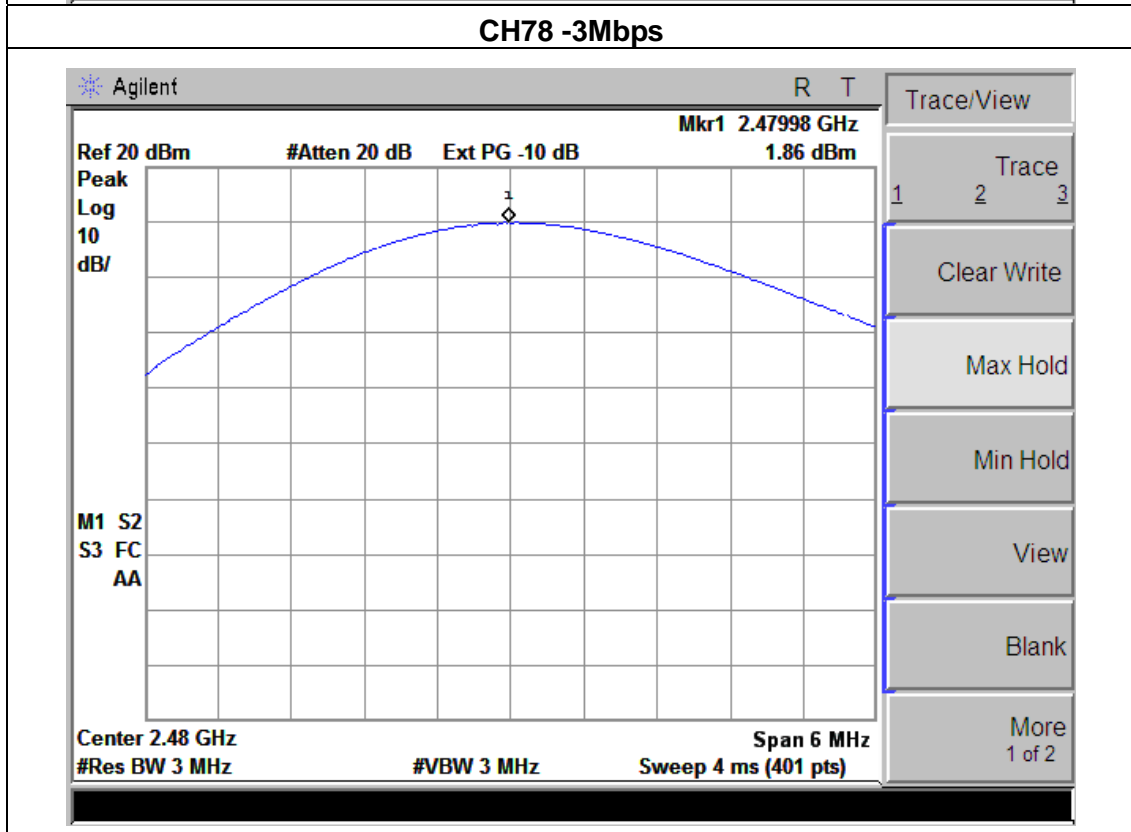
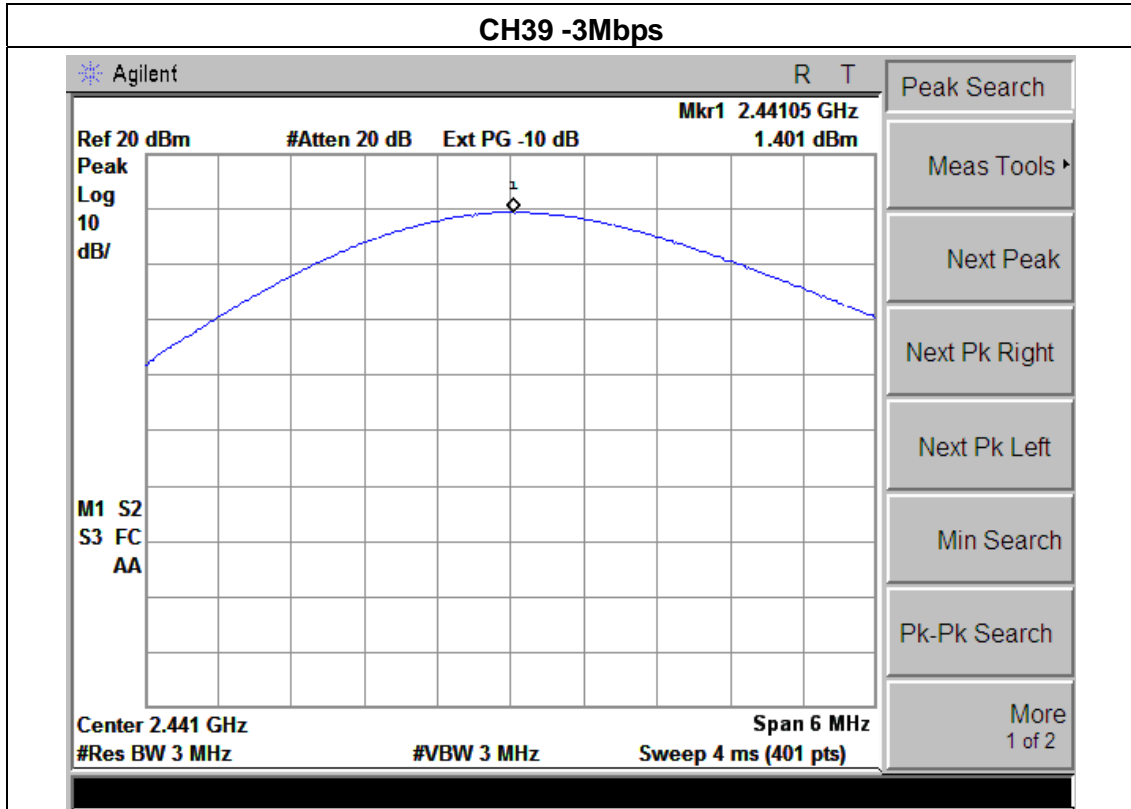

9. 100 KHZ BANDWIDTH OF FREQUENCY BAND EDGE APPLICABLE STANDARD

In any 100 kHz bandwidth outside the frequency band in which the spread spectrum or digitally modulated intentional radiator is operating, the radio frequency power that is produced by the intentional radiator shall be at least 20 dB below that in the 100 kHz bandwidth within the band that contains the highest level of the desired power, based on either an RF conducted or a radiated measurement, provided the transmitter demonstrates compliance with the peak conducted power limits. If the transmitter complies with the conducted power limits based on the use of RMS averaging over a time interval, as permitted under paragraph (b)(3) of this section, the attenuation required under this paragraph shall be 30 dB instead of 20 dB. Attenuation below the general limits specified in §15.209(a) is not required. In addition, radiated emissions which fall in the restricted bands, as defined in §15.205(a), must also comply with the radiated emission limits specified in §15.209(a) (see §15.205(c)).

TEST PROCEDURE

- a) Check the calibration of the measuring instrument using either an internal calibrator or a known signal from an external generator.
- b) Position the EUT without connection to measurement instrument. Turn on the EUT and connect its antenna terminal to measurement instrument via a low loss cable. Then set it to any one measured frequency within its operating range, and make sure the instrument is operated in its linear range.
- c) Set RBW to 100 kHz and VBW of spectrum analyzer to 300 kHz with a convenient frequency span including 100 kHz bandwidth from band edge.
- d) Measure the highest amplitude appearing on spectral display and set it as a reference level. Plot the graph with marking the highest point and edge frequency.
- e) Repeat above procedures until all measured frequencies were complete.

9.1 DEVIATION FROM STANDARD

No deviation.

9.2 TEST SETUP

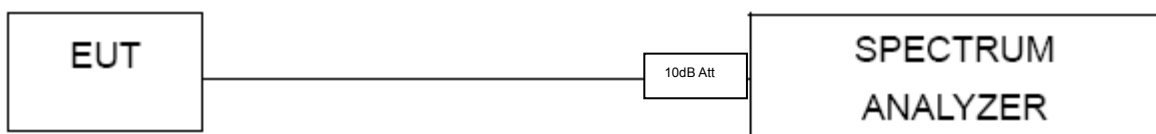

9.3 EUT OPERATION CONDITIONS

The EUT tested system was configured as the statements of 2.4 Unless otherwise a special operating condition is specified in the follows during the testing.

9.4 TEST RESULTS

EUT :	Bluetooth speaker	Model Name :	SPB60
Temperature :	25 °C	Relative Humidity :	60%
Pressure :	1012 hPa	Test Voltage :	DC 3.7V

Frequency Band	Delta Peak to band emission(Hopping) (dBc)	Delta Peak to band emission(Non-hopping) (dBc)	> Limit (dBc)	Result
1Mbps				
Left-band	56.51	53.37	20	Pass
Right-band	50.82	49.49	20	Pass
2Mbps				
Left-band	49.83	49.95	20	Pass
Right-band	49.28	47.98	20	Pass
3Mbps				
Left-band	48.92	51.77	20	Pass
Right-band	50.83	50.06	20	Pass

Frequency (MHz)	Meter Reading (dBμV)	Factor (dB)	Emission Level (dBμV/m)	Limits (dBμV/m)	Margin (dB)	Detector Type	Comment
1Mbps Non-hopping							
2390	62.19	-13.06	49.13	74	-24.87	peak	Vertical
2390	60.57	-13.06	47.51	74	-26.49	peak	Horizontal
2483.5	58.54	-12.78	45.76	74	-28.24	peak	Vertical
2483.5	57.62	-12.78	44.84	74	-29.16	peak	Horizontal
2Mbps Non-hopping							
2390	59.63	-13.06	46.57	74	-27.43	peak	Vertical
2390	58.15	-13.06	45.09	74	-28.91	peak	Horizontal
2483.5	58.36	-12.78	45.58	74	-28.42	peak	Vertical
2483.5	57.73	-12.78	44.95	74	-29.05	peak	Horizontal
3Mbps Non-hopping							
2390	58.69	-13.06	45.63	74	-28.37	peak	Vertical
2390	60.60	-13.06	47.54	74	-26.46	peak	Horizontal
2483.5	57.07	-12.78	44.29	74	-29.71	peak	Vertical
2483.5	58.31	-12.78	45.53	74	-28.47	peak	Horizontal

Frequency	Meter Reading	Factor	Emission Level	Limits	Margin	Detector	Comment
(MHz)	(dBμV)	(dB)	(dBμV/m)	(dBμV/m)	(dB)	Type	
1Mbps hopping							
2390	58.43	-13.06	45.37	74	-28.63	peak	Vertical
2390	57.58	-13.06	44.52	74	-29.48	peak	Horizontal
2483.5	57.02	-12.78	44.24	74	-29.76	peak	Vertical
2483.5	59.71	-12.78	46.93	74	-27.07	peak	Horizontal
2Mbps hopping							
2390	57.88	-13.06	44.82	74	-29.18	peak	Vertical
2390	59.64	-13.06	46.58	74	-27.42	peak	Horizontal
2483.5	58.33	-12.78	45.55	74	-28.45	peak	Vertical
2483.5	57.11	-12.78	44.33	74	-29.67	peak	Horizontal
3Mbps hopping							
2390	56.84	-13.06	43.78	74	-30.22	peak	Vertical
2390	57.44	-13.06	44.38	74	-29.62	peak	Horizontal
2483.5	58.49	-12.78	45.71	74	-28.29	peak	Vertical
2483.5	57.37	-12.78	44.59	74	-29.41	peak	Horizontal

Note: Test method to see chapter 3.2

1Mbps: Band Edge, Left Side

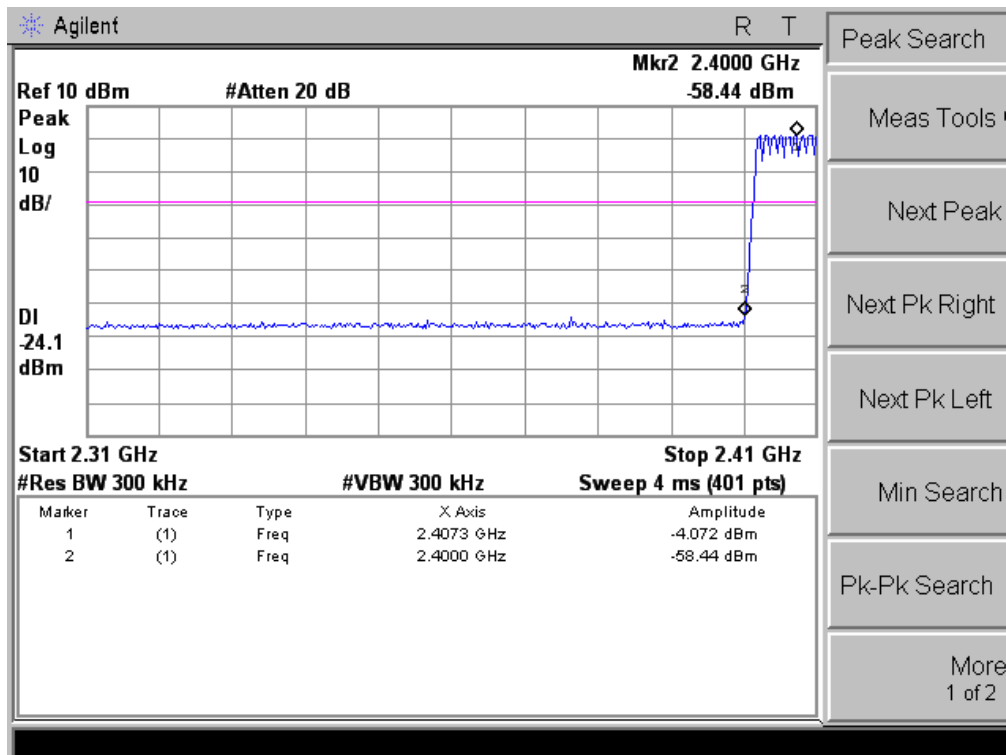
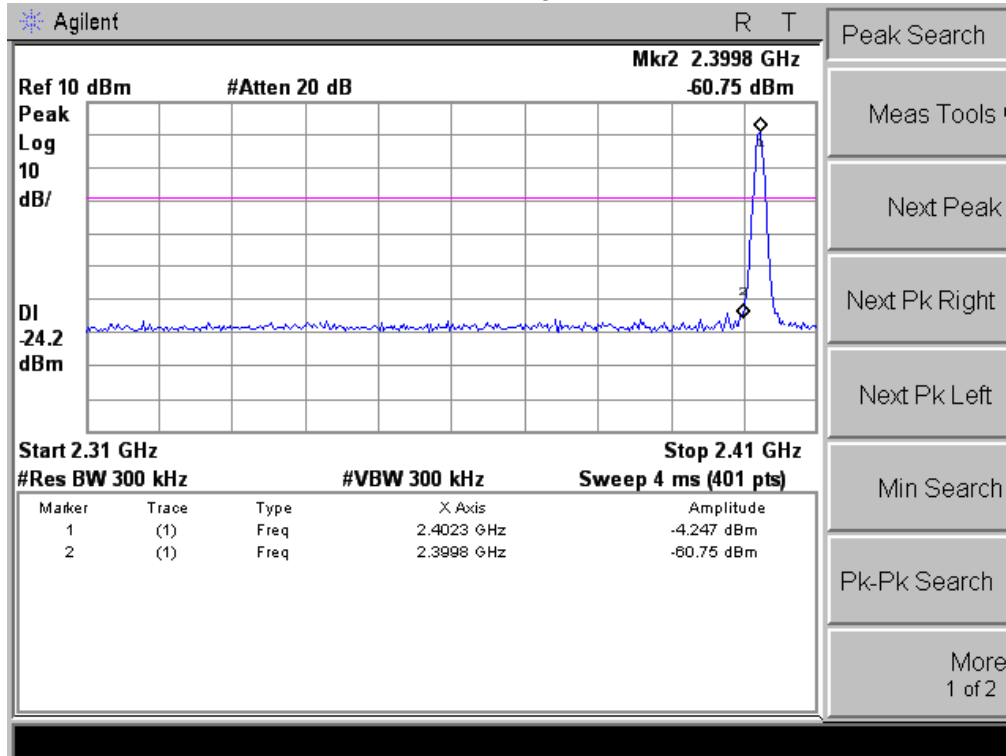

1Mbps: Band Edge, Right Side

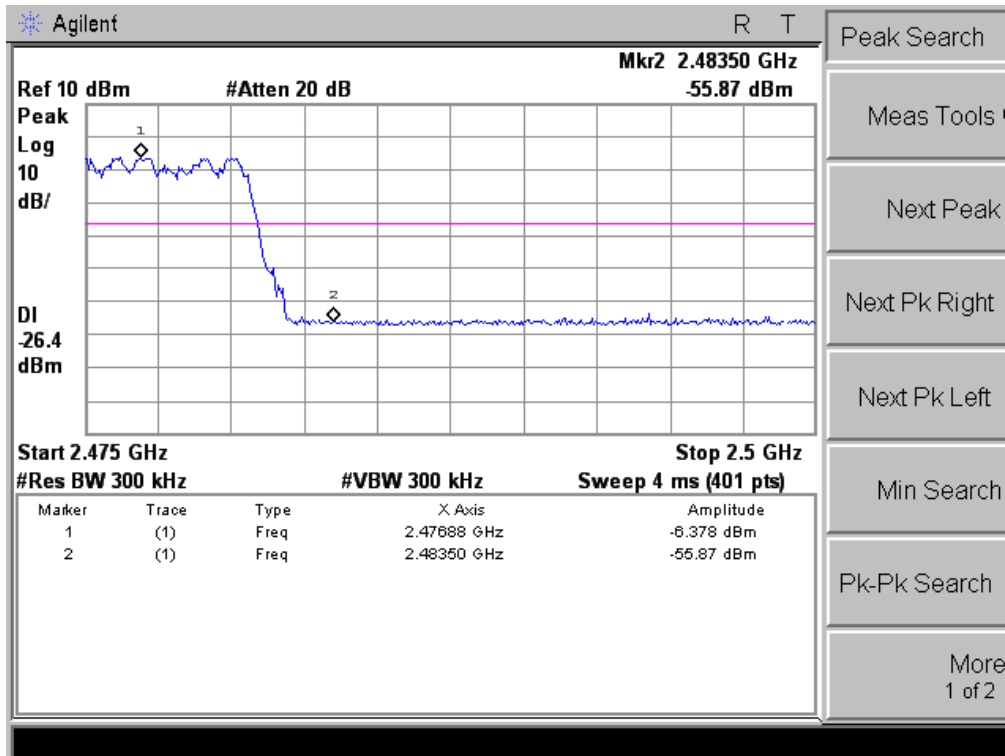
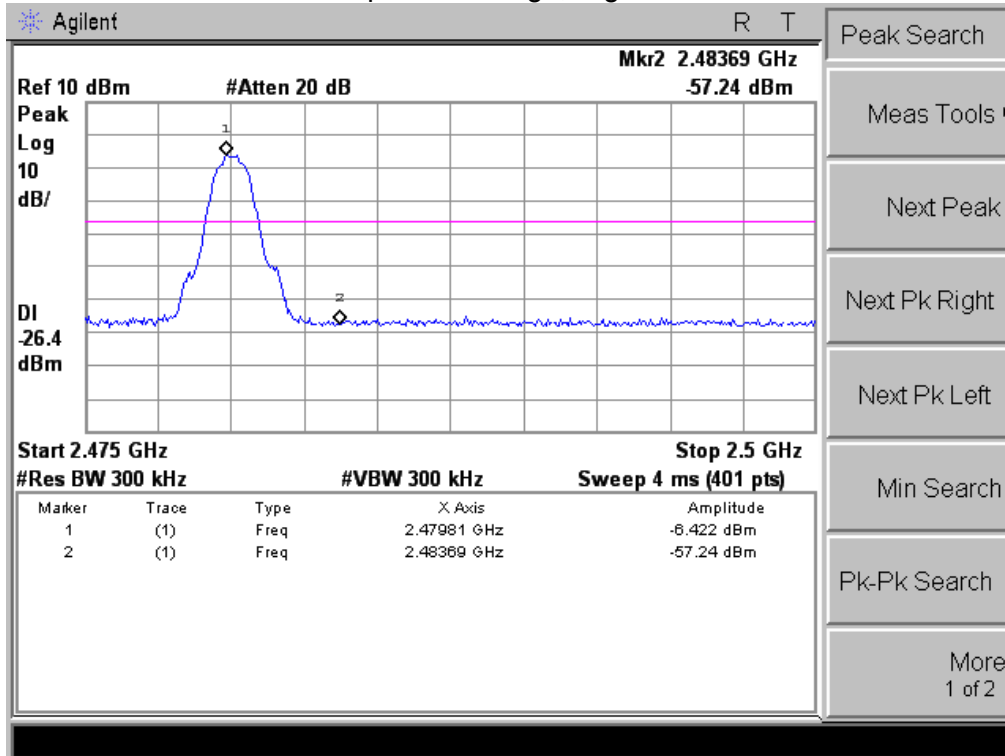

2Mbps: Band Edge, Left Side

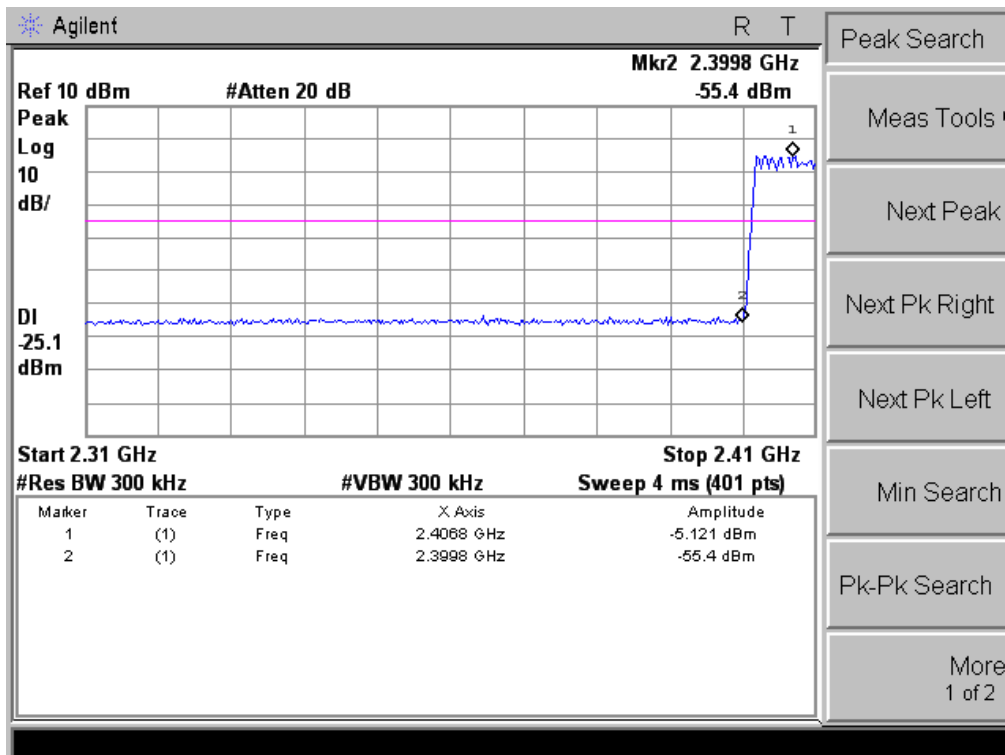
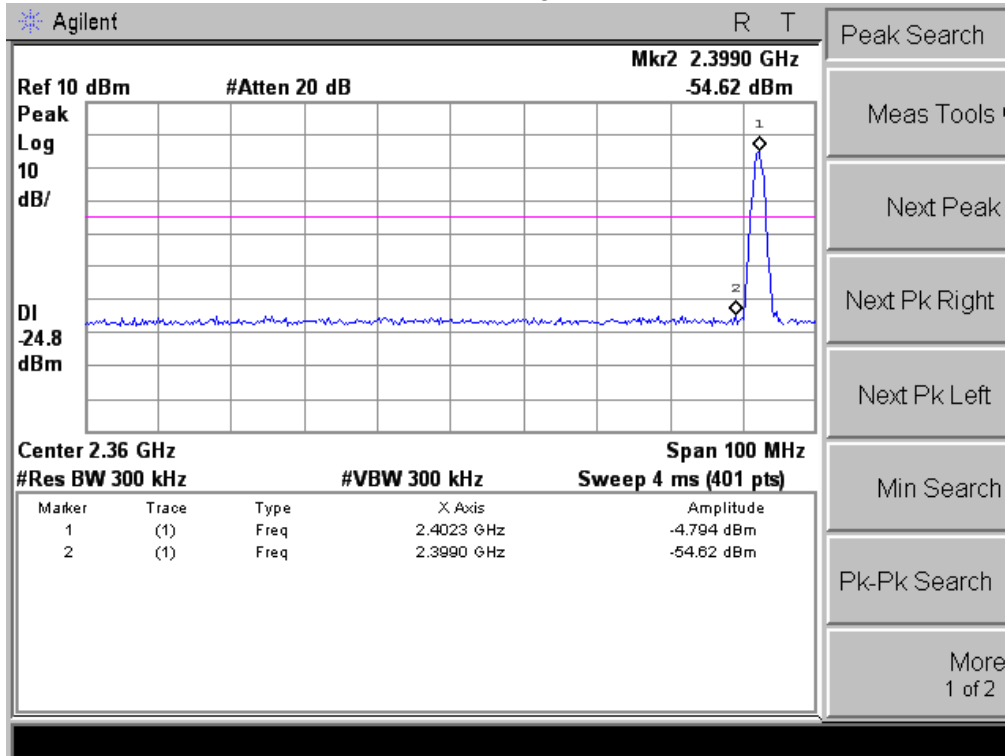

2Mbps: Band Edge, Right Side

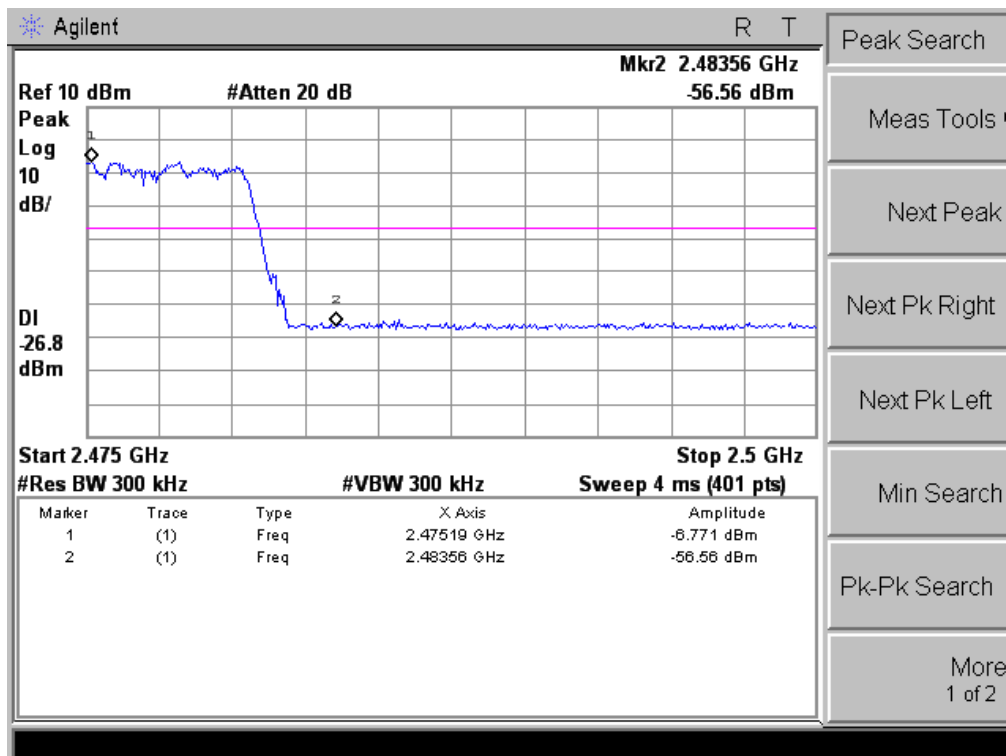
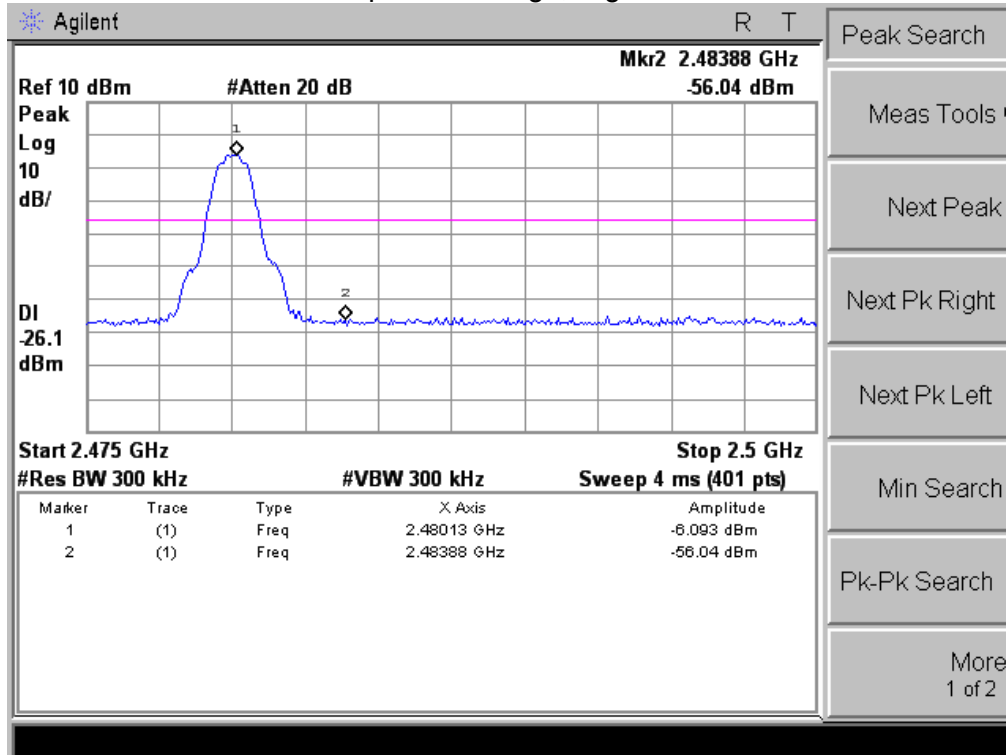

3Mbps: Band Edge, Left Side

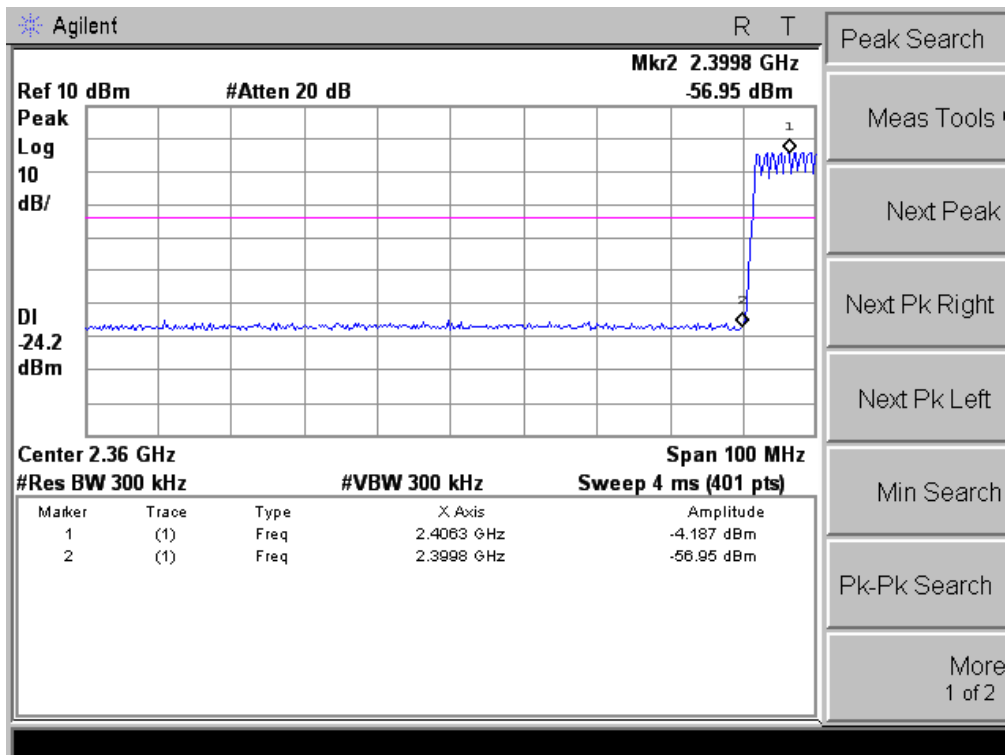
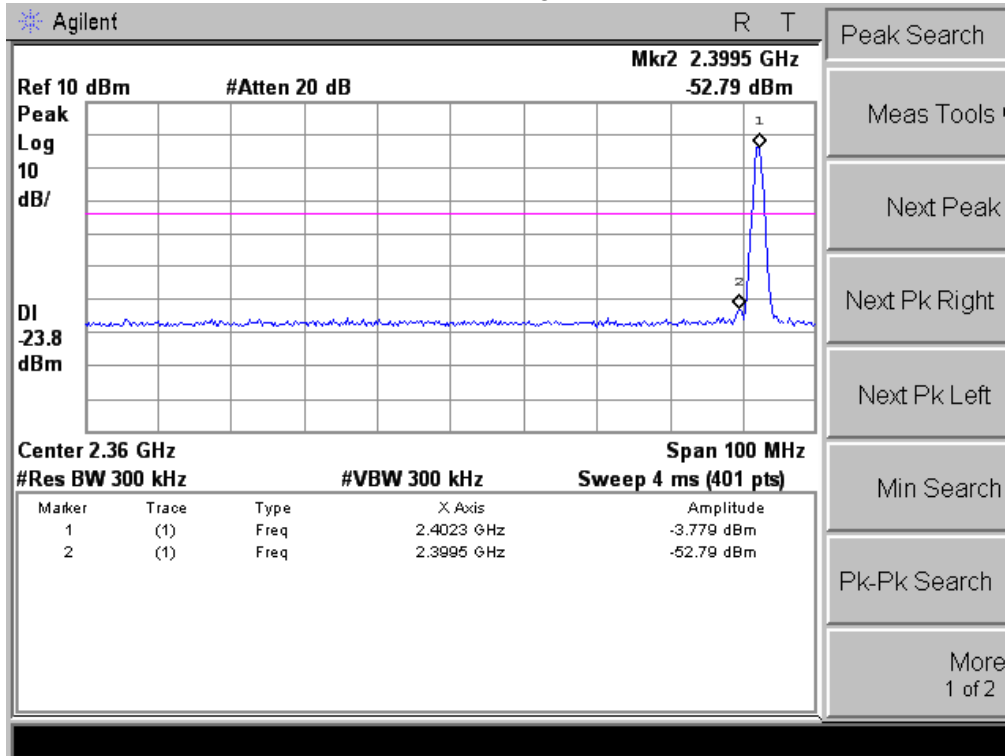

3Mbps: Band Edge, Right Side

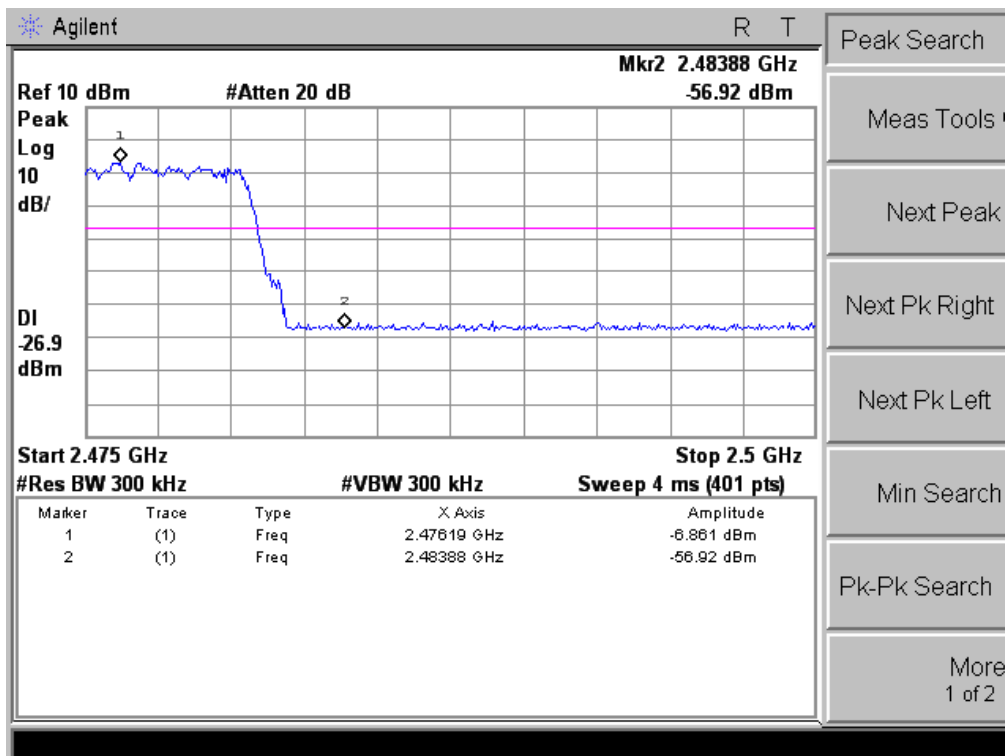
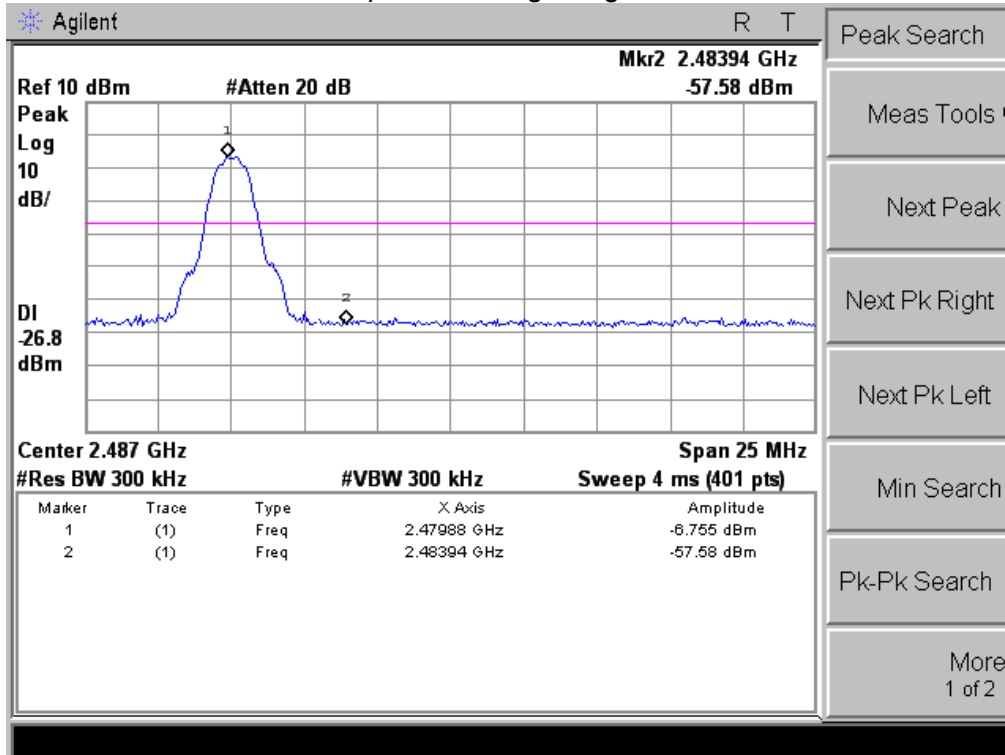

10. ANTENNA REQUIREMENT

10.1 STANDARD REQUIREMENT

15.203 requirement: For intentional device, according to 15.203: an intentional radiator shall be designed to ensure that no antenna other than that furnished by the responsible party shall be used with the device.

10.2 EUT ANTENNA

The EUT antenna is Integrated(PCB) antenna. It comply with the standard requirement.

11. EUT TEST PHOTO

Radiated Measurement Photos

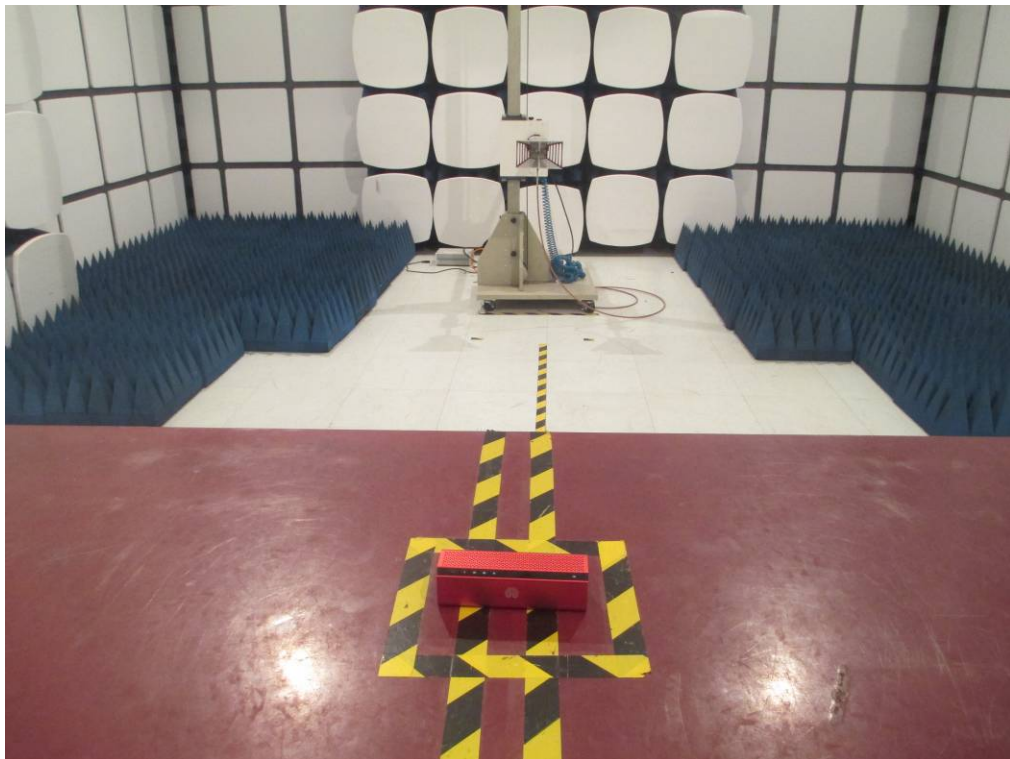
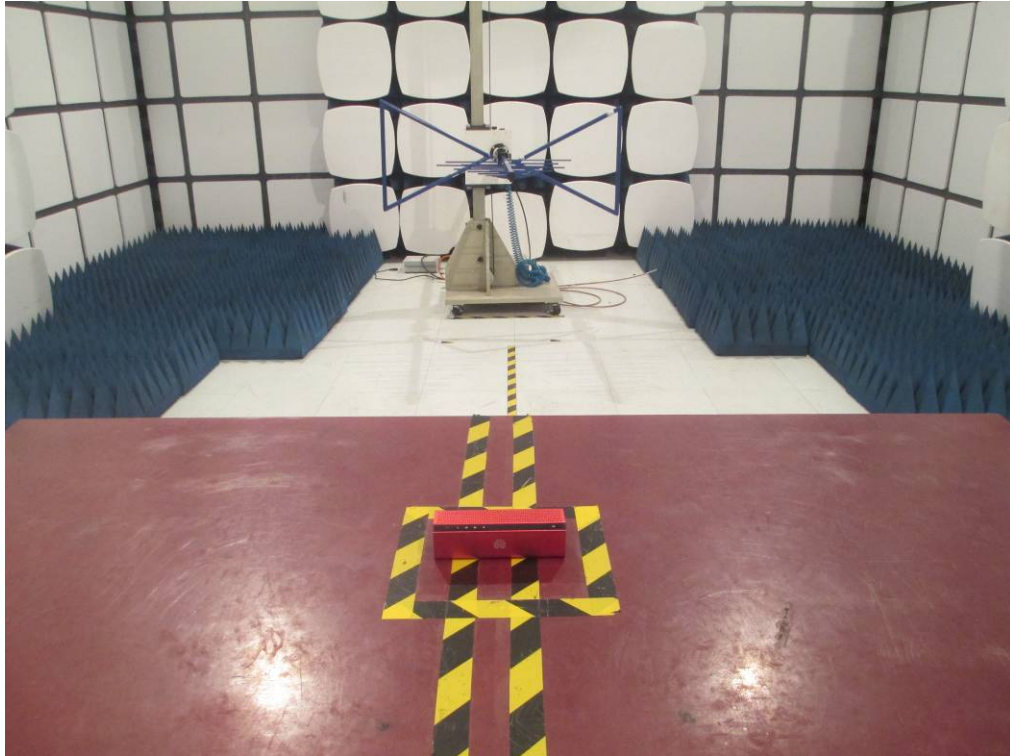

CONDUCTED EMISSION Photos

