

FCC Test Report

Part 15 subpart C

Client Information:

Applicant : CHINA ELECTRONICS SHENZHEN COMPANY
Applicant add.: F35/F, ELECTRONICS SCIENCE AND TECHNOLOGY BUILDING,
SHENNANZHONG ROAD, SHENZHEN, CHINA

EUT Information:

EUT Name : BLUETOOTH SPEAKER
Model No. : PH-BT1000, BT-2005
Brand Name : photive
FCC ID : 2AAQFPH-BT1000

Prepared By:

Shenzhen ECT Testing Technology Co., Ltd.
Add. : No Room 808, Era Innovation Center, Xixiang gushu second road,
Baoan district, Shenzhen city, China
Date of Receipt: Feb. 20, 2014 Date of Test: Feb. 20~ Feb. 25, 2014
Date of Issue: Feb. 25, 2014 Test Result: **Pass**

Test procedure used: ANSI C63.4-2009

This device described above has been tested by Shenzhen ECT Testing Technology Co., Ltd., and the test results show that the equipment under test (EUT) is in compliance with the FCC requirements. And it is applicable only to the tested sample identified in the report.

*This test report must not be used by the client to claim product endorsement by any agency of the U.S. government.



Reviewed by: Nancy Xu
Nancy Xu

Approved by: Kelly Jiang
Kelly Jiang

1 Contents

	Page
COVER PAGE	
1 CONTENTS	2
2 TEST SUMMARY	4
2.1 COMPLIANCE WITH FCC PART 15 SUBPART C	4
2.2 MEASUREMENT UNCERTAINTY	4
3 GENERAL INFORMATION	5
3.1 GENERAL DESCRIPTION OF EUT	5
3.2 DESCRIPTION OF TEST CONDITIONS	7
3.3 EUT PERIPHERAL LIST	8
3.4 TEST PERIPHERAL LIST	8
4 EQUIPMENTS LIST FOR ALL TEST ITEMS	9
5 TEST RESULT	10
5.1 ANTENNA REQUIREMENT	10
5.1.1 Standard requirement	10
5.1.2 EUT Antenna	10
5.2 CONDUCTION EMISSIONS MEASUREMENT	11
5.2.1 Applied procedures / Limit	11
5.2.2 Test procedure	11
5.2.3 Test results	12
5.3 RADIATED EMISSIONS MEASUREMENT	14
5.3.1 Applied procedures / Limit	14
5.3.2 Test procedure	14
5.3.3 Test Result	15
5.3.4 TEST RESULTS (Restricted Bands Requirements)	20
5.4 BANDWIDTH TEST	21
5.4.1 Applied procedures / Limit	21
5.4.2 Test procedure	21
5.4.3 Deviation from standard	21
5.4.4 Test setup	21
5.4.5 Test results	22
5.5 CARRIER FREQUENCIES SEPARATED	26
5.5.1 Applied procedures / Limit	26
5.5.2 Test procedure	26
5.5.3 Deviation from standard	26
5.5.4 Test results	27
5.6 HOPPING CHANNEL NUMBER	30
5.6.1 Applied procedures / Limit	30

5.6.2	Test procedure	30
5.6.3	Test result	30
5.7	DWELL TIME.....	32
5.7.1	Applied procedures / Limit	32
5.7.2	Test procedure.....	32
5.7.3	Test result	33
5.8	MAXIMUM PEAK OUTPUT POWER.....	43
5.8.1	Applied procedures / Limit	43
5.8.2	Test procedure.....	43
5.8.3	Deviation from standard.....	43
5.8.4	Test setup	43
5.8.5	Test results	44
5.9	BAND EDGE	48
5.9.1	Applied procedures / Limit	48
5.9.2	Test procedure.....	48
5.9.3	Deviation from standard.....	48
5.9.4	Test setup	48
5.9.5	Test results	49
5.10	CONDUCTED SPURIOUS EMISSIONS	51
5.10.1	Applied procedures / Limit	51
5.10.2	Test procedure.....	51
5.10.3	Deviation from standard.....	51
5.10.4	Test setup	51
5.10.5	Test results	52

2 Test Summary

2.1 Compliance with FCC Part 15 subpart C

Test	Test Requirement	Standard Paragraph	Result
Antenna Requirement	FCC Part 15 C:2008	Section 15.247(c)	PASS
Conduction Emissions	FCC Part 15 C:2008	Section 15.207(a)	PASS
Radiated Emissions	FCC Part 15 C:2008	Section 15.247(d)	PASS
Carrier Frequencies Separated	FCC Part 15 C:2008	Section 15.247(a)(1)	PASS
Hopping Channel Number	FCC Part 15 C:2008	Section 15.247(a)(1) (iii)	PASS
Dwell Time	FCC Part 15 C:2008	Section 15.247(a)(1) (iii)	PASS
Maximum Peak Output Power	FCC Part 15 C:2008	Section 15.247(b)	PASS
Band edge	FCC Part 15 C:2008	Section 15.247(d)	PASS
Conducted Spurious Emissions	FCC Part 15 C:2008	Section 15.247(d)	PASS

2.2 Measurement Uncertainty

All measurements involve certain levels of uncertainties, The following measurements uncertainty Levels have estimated based on ANSI C63.4:2009, the maximum value of the uncertainty as below

No.	Item	Uncertainty
1	Conducted Emission Test	±1.38dB
2	Radiated Emission Test	±3.57dB

3 General Information

3.1 General Description of EUT

Manufacturer:	SHENZHEN ZEJIA ELECTRONIC HARDWARE CO., LTD.
Manufacturer Address:	4/F, Building D, HongWanBang Technology Industrial Zone, TongFuTun Industrial Park, ShiAo, Dalang Village, LongHua Town, ShenZhen, P.R.C.
EUT Name:	BLUETOOTH SPEAKER
Model No:	PH-BT1000
Operation frequency:	2402MHz to 2480MHz
Channel Number:	79
Modulation Technology:	GFSK, ($\pi/4$)DQPSK, 8DPSK
Antenna Type:	Integral
Antenna Gain:	0 dBi
Brand Name:	photive
Serial No:	BT-2005
Power Supply Range:	DC 5V from Host unit DC 3.7V from Battery
Power Supply:	DC 5V from Host unit DC 3.7V from Battery
Power Cord:	0.5m x 2 wire unshielded USB cable; 0.5m x 2 wire unshielded AUX cable.
Effective Isotropic Radiated Power (max):	3.03dBm

Note:

1. For a more detailed features description, please refer to the manufacturer's specifications or the User's Manual.

2.

Channel List					
Channel	Frequency (MHz)	Channel	Frequency (MHz)	Channel	Frequency (MHz)
00	2402	27	2429	54	2456
01	2403	28	2430	55	2457
02	2404	29	2431	56	2458
03	2405	30	2432	57	2459
04	2406	31	2433	58	2460
05	2407	32	2434	59	2461
06	2408	33	2435	60	2462
07	2409	34	2436	61	2463
08	2410	35	2437	62	2464
09	2411	36	2438	63	2465
10	2412	37	2439	64	2466
11	2413	38	2440	65	2467
12	2414	39	2441	66	2468
13	2415	40	2442	67	2469
14	2416	41	2443	68	2470
15	2417	42	2444	69	2471
16	2418	43	2445	70	2472
17	2419	44	2446	71	2473
18	2420	45	2447	72	2474
19	2421	46	2448	73	2475
20	2422	47	2449	74	2476
21	2423	48	2450	75	2477
22	2424	49	2451	76	2478
23	2425	50	2452	77	2479
24	2426	51	2453	78	2480
25	2427	52	2454		
26	2428	53	2455		

3. The USB cable only can connect to PC for charging. It can't transfer data.

4. According to the declaration of the applicant, the electrical circuit design, layout, components used and internal wiring were identical for above models, with only difference being the model no.. Therefore, only one model **PH-BT1000** was tested in this report.

3.2 Description of Test conditions

(1) EUT was tested in normal configuration (Please See following Block diagram)

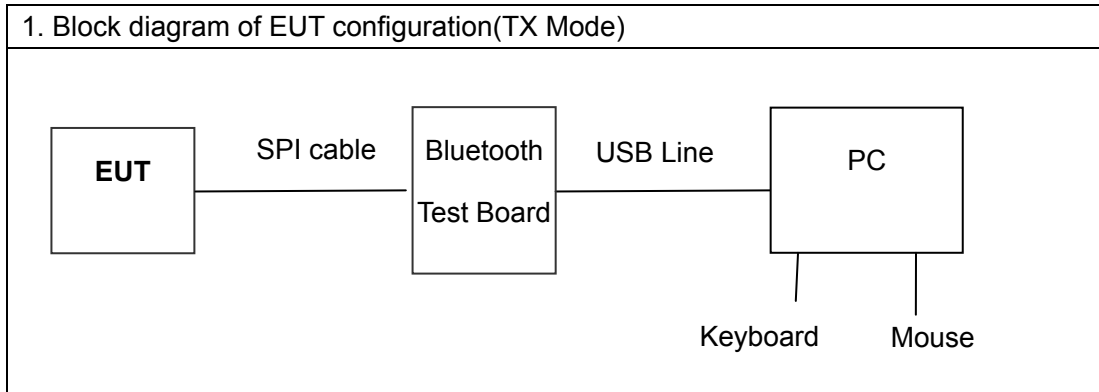

(2) E.U.T. test conditions:

15.31(e): For intentional radiators, measurements of the variation of the input power or the radiated signal level of the fundamental frequency component of the emission, as appropriate, shall be performed with the supply voltage varied between 85% and 115% of the nominal rated supply voltage. For battery operated equipment, the equipment tests shall be performed using a new battery.

(3) Test frequencies:

According to the 15.31(m) Measurements on intentional radiators or receivers, other than TV broadcast receivers, shall be performed and. If required reported for each band in which the device can be operated with the device operating at the number of frequencies in each band specified in the following table:

Frequency range over which device operates	Number of frequencies	Location in the range of operation
1 MHz or less	1	Middle
1 to 10 MHz	2	1 near top and 1 near bottom
More than 10 MHz	3	1 near top, 1 near middle and 1 near bottom

(4) Frequency range of radiated measurements:

According to the 15.33, The test range will be up to the tenth harmonic of the highest fundamental frequency .

3.3 EUT Peripheral List

No.	Equipment	Manufacturer	Model No.	Serial No.	Power cord	signal cable
1	USB Cable	Prototype	N/A	N/A	N/A	0.50m/ unshielded/ undetachable
2	AUX Cable	Prototype	N/A	N/A	N/A	0.50m/ shielded/ undetachable

3.4 Test Peripheral List

No.	Equipment	Manufacturer	EMC Compliance	Model No.	Serial No.	Power cord	signal cable
1	Personal computer	H P	CE 、 FCC	DX2310	CNG8250MZ3	1.8m/unshielded /detachable	N/A
2	Keyboard	DELL	CE	SK-8115	CN-ONM432- 71616-81M-OLK B	N/A	1.5m/unshielded /undetachable
3	Mouse	Microsoft	CE	X800898	30603	N/A	1.5m/unshielded /undetachable

4 Equipments List for All Test Items

No	Test Equipment	Manufacturer	Model No	Serial No	Cal. Date	Cal. Due Date
1	Spectrum Analyzer	ADVANTEST	R3182	150900201	2013.10.16	2014.10.15
2	EMI Measuring Receiver	Schaffner	SCR3501	235	2013.10.16	2014.10.15
3	Low Noise Pre Amplifier	Tsj	MLA-10K01-B01-27	1205323	2013.09.08	2014.09.07
4	Low Noise Pre Amplifier	Tsj	MLA-0120-A02-34	2648A04738	2013.04.08	2014.04.07
5	TRILOG Super Broadband test Antenna	SCHWARZBECK	VULB9160	9160-3206	2013.07.15	2014.07.14
6	Broadband Horn Antenna	SCHWARZBECK	BBHA9120A	451	2013.07.15	2014.07.14
7	50Ω Coaxial Switch	Anritsu	MP59B	6200264416	2013.09.08	2014.09.07
8	EMI Test Receiver	R&S	ESCI	100124	2013.12.29	2014.12.28
9	LISN	Kyoritsu	KNW-242	8-837-4	2013.04.08	2014.04.07
10	LISN	Kyoritsu	KNW-407	8-1789-3	2013.04.08	2014.04.07
11	50Ω Coaxial Switch	Anritsu	MP59B	6200264417	2013.09.08	2014.09.07
12	Loop Antenna	ARA	PLA-1030/B	1029	2013.03.19	2014.03.18
13	Power Meter	R&S	NRVS	101336	2013.04.08	2014.04.07
14	EMI Test Receiver	Rohde & Schwarz	ESIB26	100394	2013.04.08	2014.04.07

5 Test Result

5.1 Antenna Requirement

5.1.1 Standard requirement

15.203 requirement: For intentional device, according to 15.203: an intentional radiator shall be designed to ensure that no antenna other than that furnished by the responsible party shall be used with the device.

15.247(c) (1)(i) requirement: (i) Systems operating in the 2400-2483.5 MHz band that is used exclusively for fixed. Point-to-point operations may employ transmitting antennas with directional gain greater than 6dBi provided the maximum conducted output power of the intentional radiator is reduced by 1 dB for every 3 dB that the directional gain of the antenna exceeds 6dBi.

5.1.2 EUT Antenna

The antenna is integrated on the main PCB and no consideration of replacement. Antenna gain is max 0 dBi from 2.4GHz to 2.5GHz.

5.2 Conduction Emissions Measurement

5.2.1 Applied procedures / Limit

Frequency of Emission (MHz)	Conducted Limit (dB μ V)	
	Quasi-peak	Average
0.15-0.5	66 to 56 *	56 to 46 *
0.5-5	56	46
5-30	60	50

Note: Decreases with the logarithm of the frequency.

5.2.2 Test procedure

EUT was placed upon a wooden test table 0.8m above the horizontal metal reference plane and 0.4m from the vertical ground plane, and it was connected to an AMN. The closest distance between the boundary of the EUT and the surface of the AMN is 0.8m. All peripherals were connected to another AMN, and placed at a distance of 10cm from each other. A spectrum and receiver was connected to the RF output port of the AMN. Both average and quasi-peak value were detected.

5.2.3 Test results

EUT:	BLUETOOTH SPEAKER	Model Name. :	PH-BT1000
Temperature:	26 °C	Relative Humidity:	54%
Pressure:	1010hPa	Test Date :	2014-02-24
Test Mode:	TX	Phase :	Line
Test Voltage :	DC 5V from Adapter		

Level(dBμV)

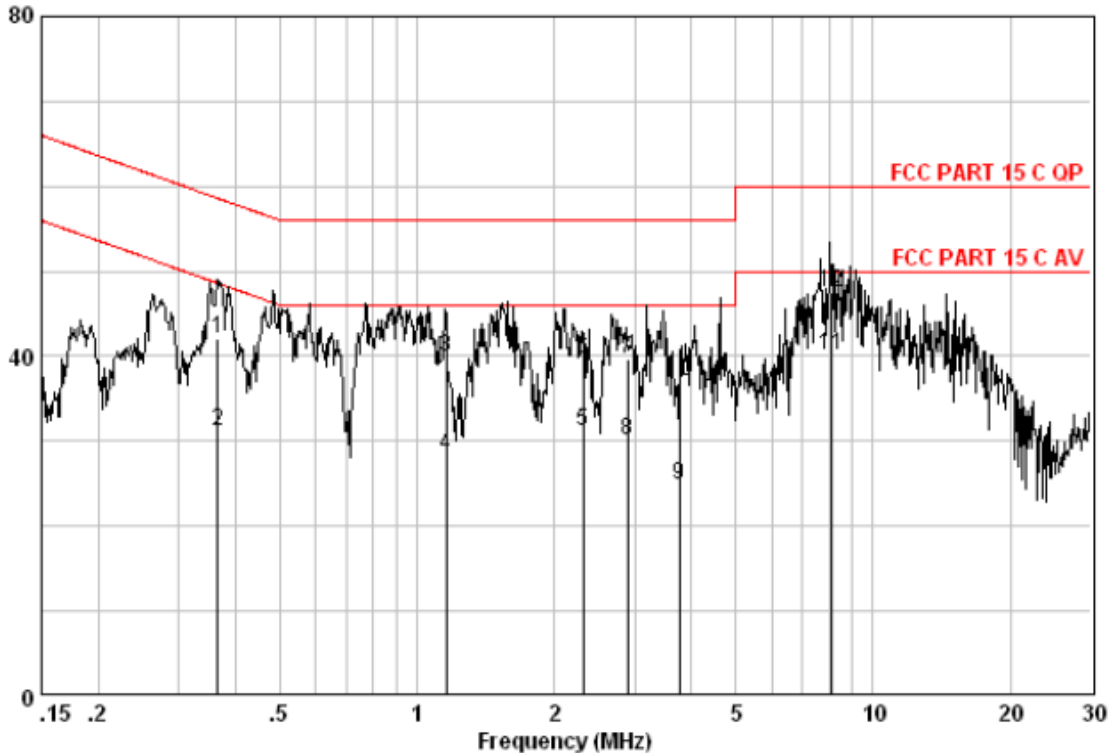

Measure data:

Freq	Read Level	Cable Loss	LISN Factor	Level	Limit Line	Over Limit	Remark
MHz	dBμV	dB	dB	dBμV	dBμV	dB	
0.365	32.48	0.05	9.63	42.16	58.61	-16.44	QP
0.365	21.47	0.05	9.63	31.15	48.61	-17.45	AVERAGE
1.160	30.17	0.03	9.64	39.84	56.00	-16.16	QP
1.160	18.77	0.03	9.64	28.44	46.00	-17.56	AVERAGE
2.316	21.41	0.08	9.68	31.17	46.00	-14.83	AVERAGE
2.316	29.81	0.08	9.68	39.57	56.00	-16.43	QP
2.897	29.82	0.12	9.70	39.63	56.00	-16.37	QP
2.897	20.29	0.12	9.70	30.10	46.00	-15.90	AVERAGE
3.759	15.06	0.14	9.72	24.92	46.00	-21.08	AVERAGE
3.759	27.19	0.14	9.72	37.05	56.00	-18.95	QP
8.105	30.04	0.16	9.86	40.06	50.00	-9.94	AVERAGE
8.105	37.51	0.16	9.86	47.53	60.00	-12.47	QP

EUT:	BLUETOOTH SPEAKER	Model Name. :	PH-BT1000
Temperature:	26 °C	Relative Humidity:	54%
Pressure:	1010hPa	Test Date :	2014-02-24
Test Mode:	TX	Phase :	Neutral
Test Voltage :	DC 5V from Adapter		

Level(dBμV)

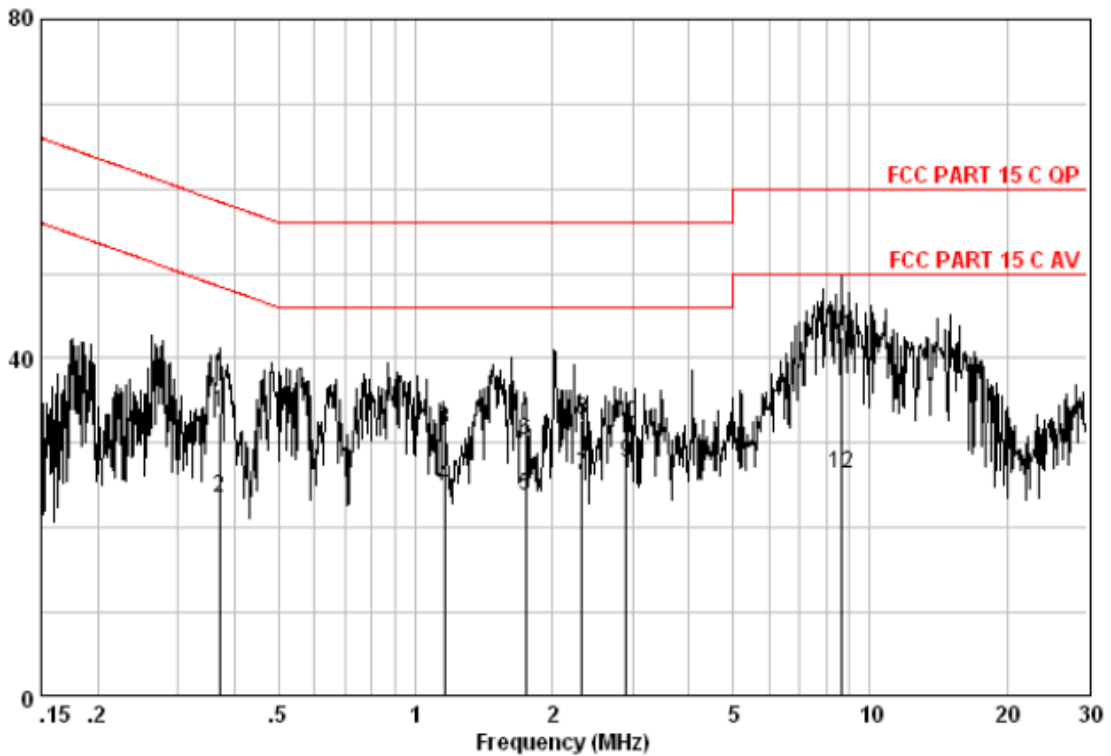

Measure result:

Freq	Read Level	Cable Loss	LISN Factor	Level	Limit Line	Over Limit	Remark
MHz	dBμV	dB	dB	dBμV	dBμV	dB	
0.371	23.84	0.05	9.63	33.52	58.47	-24.95	QP
0.371	13.88	0.05	9.63	23.56	48.47	-24.91	AVERAGE
1.160	21.92	0.03	9.69	31.64	56.00	-24.36	QP
1.160	15.06	0.03	9.69	24.78	46.00	-21.22	AVERAGE
1.744	13.94	0.05	9.70	23.70	46.00	-22.30	AVERAGE
1.744	20.59	0.05	9.70	30.35	56.00	-25.65	QP
2.321	16.42	0.08	9.71	26.21	46.00	-19.79	AVERAGE
2.321	22.85	0.08	9.71	32.64	56.00	-23.36	QP
2.902	17.76	0.12	9.73	27.60	46.00	-18.40	AVERAGE
2.902	22.35	0.12	9.73	32.19	56.00	-23.81	QP
8.637	32.46	0.17	9.90	42.53	60.00	-17.47	QP
8.637	16.38	0.17	9.90	26.45	50.00	-23.55	AVERAGE

Remark:

This test item was transferred to Asia Institute Technology (Dongguan) Limited which was confirmed to have enough capacity to perform this subcontract work. The FCC Registration No. of Asia Institute Technology (Dongguan) Limited is 248337.

5.3 Radiated Emissions Measurement

5.3.1 Applied procedures / Limit

15.247(d) In any 100 kHz bandwidth outside the frequency band in which the spread spectrum or digitally modulated intentional radiator is operating, the radio frequency power that is produced by the intentional radiator shall be at least 20 dB below that in the 100 kHz bandwidth within the band that contains the highest level of the desired power, based on either an RF conducted or a radiated measurement, provided the transmitter demonstrates compliance with the peak conducted power limits. If the transmitter complies with the conducted power limits based on the use of RMS averaging over a time interval, as permitted under paragraph (b)(3) of this section, the attenuation required under this paragraph shall be 30 dB instead of 20 dB. Attenuation below the general limits specified in Section 15.209(a) is not required. In addition, radiated emissions which fall in the restricted bands, as defined in Section 15.205(a), must also comply with the radiated emission limits specified in Section 15.209(a) (see Section 15.205(c)).

Frequency of Emission (MHz)	Field Strength		Measurement Distance (meters)
	$\mu\text{V/m}$	$\text{dB}\mu\text{V/m}$	
0.009-0.49	2400/F(kHz)		300
0.49-1.705	24000/F(kHz)		30
1.705-30	30		30
30-88	100	40	3
88-216	150	43.5	3
216-960	200	46	3
Above 960	500	54	3

5.3.2 Test procedure

EUT was placed upon a wooden test table which was placed on the turn table 0.8m above the horizontal metal ground plane, and operating in the mode as mentioned above. A receiving antenna was placed 3m away from the EUT. During testing, turn around the turn table and move the antenna from 1m to 4m to find the maximum field-strength reading. All peripherals were placed at a distance of 10cm between each other. Both horizontal and vertical antenna polarities were tested and performed pretest to three orthogonal axis. The worst case emissions were reported.

5.3.3 Test Result

There is not detected blow 30MHz.

EUT:	BLUETOOTH SPEAKER	Model Name :	PH-BT1000
Temperature:	25 °C	Test Data	2014-02-24
Pressure:	1010 hPa	Relative Humidity:	60%
Test Mode :	TX	Test Voltage :	DC 3.7V from battery
Measurement Distance	3 m	Frenqucy Range	30MHz to 1GHz
RBW/VBW	100KHz / 300KHz for spectrum, RBW=120KHz for receiver.		

(a) Antenna polarization: Horizontal

Peak scan

Level (dBμV/m)

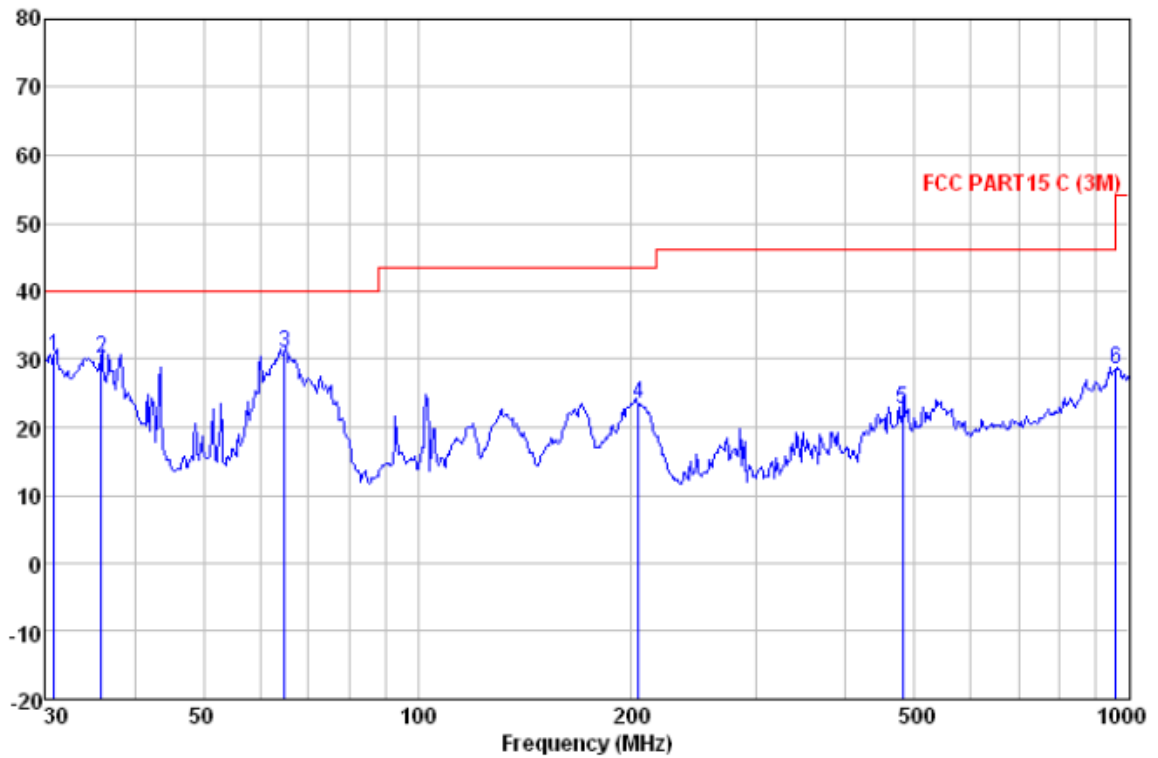

Quasi-peak measurement

Read Freq	Antenna Level	Antenna Factor	Cable Loss	Preamp Factor	Level	Limit Line	Over Limit	Remark
MHz	dBμV	dB/m	dB	dB	dBμV/m	dBμV/m	dB	
30.853	48.84	12.32	0.84	31.60	30.40	40.00	-9.60	QP
35.875	48.24	12.54	0.89	31.60	30.07	40.00	-9.93	QP
65.114	50.91	10.57	1.18	31.60	31.06	40.00	-8.94	QP
204.238	42.28	10.70	1.91	31.30	23.59	43.50	-19.91	QP
480.528	34.78	16.07	3.03	31.19	22.69	46.00	-23.31	QP
958.794	33.41	21.49	4.18	30.65	28.43	46.00	-17.57	QP

(b) Antenna polarization: vertical

Peak scan

Level (dB μ V/m)

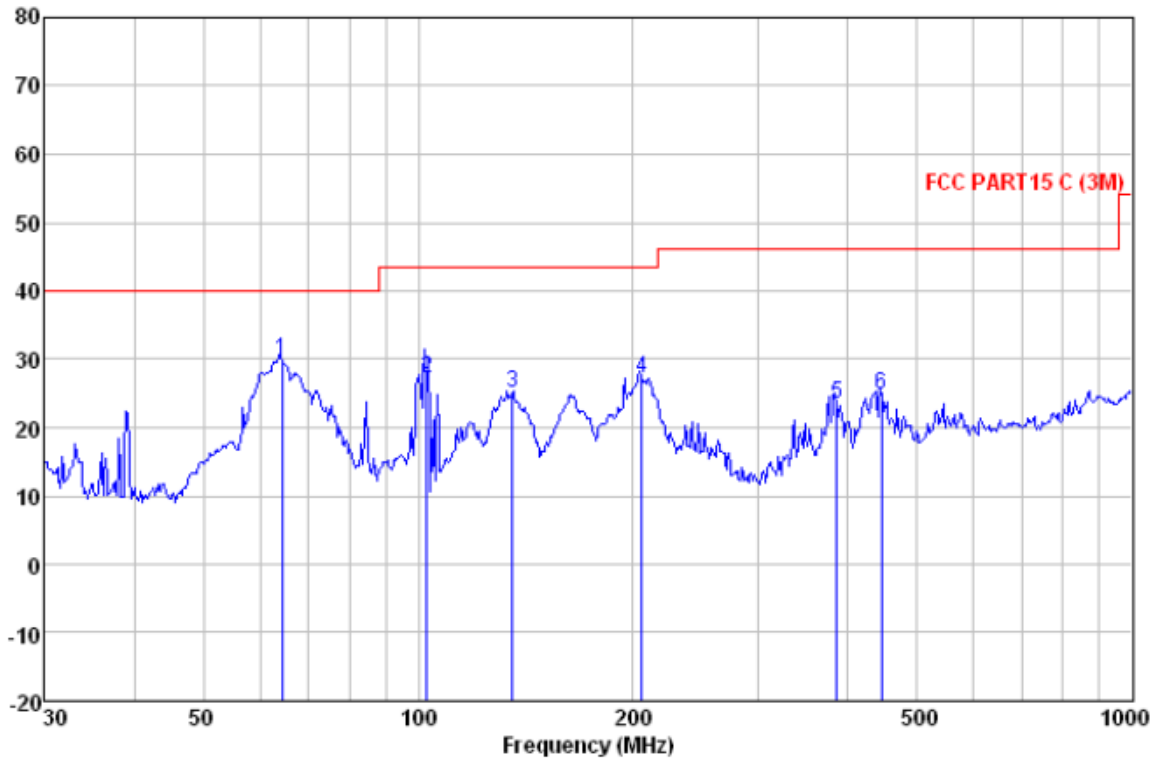

Quasi-peak measurement

ReadFreq	Antenna Level	Antenna Factor	Cable Loss	Preamp Factor	Level	Limit Line	Over Limit	Remark
MHz	dB μ V	dB/m	dB	dB	dB μ V/m	dB μ V/m	dB	
64.433	49.36	10.84	1.17	31.60	29.77	40.00	-10.23	QP
102.719	44.35	12.92	1.45	31.59	27.13	43.50	-16.37	QP
135.506	46.52	8.51	1.64	31.49	25.18	43.50	-18.32	QP
205.675	45.85	10.74	1.91	31.30	27.20	43.50	-16.30	QP
385.281	37.11	14.73	2.67	31.12	23.39	46.00	-22.61	QP
444.851	37.58	15.57	2.91	31.15	24.91	46.00	-21.09	QP

Note: '*' means the worst case

Measurement Level = Reading Level + Factor

Factor=Ant Factor + Cable Loss

EUT:	BLUETOOTH SPEAKER	Model Name :	PH-BT1000
Temperature:	25 °C	Test Data	2014-02-24
Pressure:	1010 hPa	Relative Humidity:	60%
Test Mode :	1Mbps(the worst case)	Test Voltage :	DC 3.7V from battery
Measurement Distance	3 m	Frenqucy Range	1GHz to 25GHz
RBW/VBW	1MHz/1MHz for Peak, 1MHz/10Hz for Average.		

1~25 GHz Harmonics & Spurious Emissions. Peak & Average Measurement

Peak Measurement:

Frequency (MHz)	Antenna factors (dB/m)	Cable loss (dB)	Preamp factor (dB)	Reading Level (dB μ V)	Emission Level (dB μ V/m)	Limit (dB μ V/m)	Antenna polarization
4804.00	31.53	11.11	49.30	64.54	57.88	74.00	V
7206.00	36.47	12.90	49.69	56.02	55.70	74.00	V
9608.00	38.08	15.16	49.88	55.11	58.47	74.00	V
4804.00	31.53	11.11	49.30	56.52	49.86	74.00	H
7206.00	36.47	12.90	49.69	56.92	56.60	74.00	H
9608.00	38.08	15.16	49.88	57.09	60.45	74.00	H

Average Measurement:

Frequency (MHz)	Antenna factors (dB/m)	Cable loss (dB)	Preamp factor (dB)	Reading Level (dB μ V)	Emission Level (dB μ V/m)	Limit (dB μ V/m)	Antenna polarization
4804.00	31.53	11.11	49.30	52.54	45.88	54.00	V
7206.00	36.47	12.90	49.69	49.02	48.70	54.00	V
9608.00	38.08	15.16	49.88	45.11	48.47	54.00	V
4804.00	31.53	11.11	49.30	47.52	40.86	54.00	H
7206.00	36.47	12.90	49.69	44.92	44.60	54.00	H
9608.00	38.08	15.16	49.88	42.09	45.45	54.00	H

Note: '*' means the worst case

Measurement Level = Reading Level + Factor

Factor=Ant Factor + Cable Loss

Low Channel 00: 2402 MHz

Data rate: 1Mbps

1~25 GHz Harmonics & Spurious Emissions. Peak & Average Measurement

Peak Measurement:

Frequency (MHz)	Antenna factors (dB/m)	Cable loss (dB)	Preamp factor (dB)	Reading Level (dB μ V)	Emission Level (dB μ V/m)	Limit (dB μ V/m)	Antenna polarization
4882.00	31.58	11.26	49.30	59.03	52.57	74.00	V
7323.00	36.50	13.28	49.71	57.57	57.64	74.00	V
9764.00	38.46	15.05	49.89	56.15	59.77	74.00	V
4882.00	31.58	11.26	49.30	58.72	52.26	74.00	H
7323.00	36.50	13.28	49.71	55.06	55.13	74.00	H
9764.00	38.46	15.05	49.89	54.09	57.71	74.00	H

Average Measurement:

Frequency (MHz)	Antenna factors (dB/m)	Cable loss (dB)	Preamp factor (dB)	Reading Level (dB μ V)	Emission Level (dB μ V/m)	Limit (dB μ V/m)	Antenna polarization
4882.00	31.58	11.26	49.30	49.03	42.57	54.00	V
7323.00	36.50	13.28	49.71	41.57	41.64	54.00	V
9764.00	38.46	15.05	49.89	41.15	44.77	54.00	V
4882.00	31.58	11.26	49.30	48.72	42.26	54.00	H
7323.00	36.50	13.28	49.71	47.06	47.13	54.00	H
9764.00	38.46	15.05	49.89	42.09	45.71	54.00	H

Note: '*' means the worst case

Measurement Level = Reading Level + Factor

Factor=Ant Factor + Cable Loss

Middle Channel 39: 2441 MHz

Data rate: 1Mbps

1~25 GHz Harmonics & Spurious Emissions. Peak & Average Measurement

Peak Measurement:

Frequency (MHz)	Antenna factors (dB/m)	Cable loss (dB)	Preamp factor (dB)	Reading Level (dB μ V)	Emission Level (dB μ V/m)	Limit (dB μ V/m)	Antenna polarization
4960.00	31.70	11.39	49.30	59.16	52.95	74.00	V
7440.00	36.60	13.60	49.72	56.76	57.24	74.00	V
9920.00	38.65	14.92	49.90	55.44	59.11	74.00	V
4960.00	31.70	11.39	49.30	58.64	52.43	74.00	H
7440.00	36.60	13.60	49.72	56.73	57.21	74.00	H
9920.00	38.65	14.92	49.90	56.09	59.76	74.00	H

Average Measurement:

Frequency (MHz)	Antenna factors (dB/m)	Cable loss (dB)	Preamp factor (dB)	Reading Level (dB μ V)	Emission Level (dB μ V/m)	Limit (dB μ V/m)	Antenna polarization
4960.00	31.70	11.39	49.30	51.16	44.95	54.00	V
7440.00	36.60	13.60	49.72	42.76	43.24	54.00	V
9920.00	38.65	14.92	49.90	42.44	46.11	54.00	V
4960.00	31.70	11.39	49.30	48.64	42.43	54.00	H
7440.00	36.60	13.60	49.72	40.73	41.21	54.00	H
9920.00	38.65	14.92	49.90	41.09	44.76	54.00	H

Note: '*' means the worst case

Measurement Level = Reading Level + Factor

Factor=Ant Factor + Cable Loss

High Channel 78: 2480 MHz

Data rate: 1Mbps

5.3.4 TEST RESULTS (Restricted Bands Requirements)

Test Result:

1. Low Channel

Frequency (MHz)	Antenna factors (dB/m)	Cable loss(dB)	Preamp factor(dB)	Peak Reading Level (dB μ V)	Average Reading Level (dB μ V)	Peak Emission Level (dB μ V/m)	Average Emission Level (dB μ V/m)
2310.000	27.93	6.70	35.60	47.62	40.62	46.65	39.65
2390.000	27.63	6.97	35.60	47.43	41.43	46.43	40.43
2500.000	27.55	7.29	35.60	47.08	41.08	46.32	40.32
2483.500	27.55	7.34	35.60	47.89	41.89	47.18	41.18

2. Middle Channel

Frequency (MHz)	Antenna factors (dB/m)	Cable loss(dB)	Preamp factor(dB)	Peak Reading Level (dB μ V)	Average Reading Level (dB μ V)	Peak Emission Level (dB μ V/m)	Average Emission Level (dB μ V/m)
2310.000	27.93	6.70	35.60	47.29	41.29	46.32	40.32
2390.000	27.63	6.97	35.60	47.31	41.31	46.31	40.31
2500.000	27.55	7.29	35.60	46.28	40.28	45.52	39.52
2483.500	27.55	7.34	35.60	47.29	40.29	46.58	39.58

3. High Channel

Frequency (MHz)	Antenna factors (dB/m)	Cable loss(dB)	Preamp factor(dB)	Peak Reading Level (dB μ V)	Average Reading Level (dB μ V)	Peak Emission Level (dB μ V/m)	Average Emission Level (dB μ V/m)
2310.000	27.93	6.70	35.60	50.14	43.14	49.17	42.17
2390.000	27.63	6.97	35.60	49.91	41.91	48.91	40.91
2500.000	27.55	7.29	35.60	50.67	41.67	49.91	40.91
2483.500	27.55	7.34	35.60	49.68	40.68	48.97	39.97

Remark:1. No any other emission which falls in restricted bands can be detected and be reported.

2. According to the test result, the Vertical data is worse than Horizontal. So the above is Vertical polarization data.

This test item was transferred to Asia Institute Technology (Dongguan) Limited which was confirmed to have enough capacity to perform this subcontract work. The FCC Registration No. of Asia Institute Technology (Dongguan) Limited is 248337.

Test result: The unit does meet the FCC requirements.

5.4 BANDWIDTH TEST

5.4.1 Applied procedures / Limit

For frequency hopping system operating in the 2400-2483.5MHz, If the 20dB bandwidth of hopping channel is greater than 25kHz, two-thirds 20dB bandwidth of hopping channel shall be a minimum limit for the hopping channel separation.

5.4.2 Test procedure

- a. The EUT was directly connected to the spectrum analyzer and antenna output port as show in the block diagram below.
- b. Spectrum Setting: RBW= 100KHz, VBW \geq RBW, Sweep time = Auto.

5.4.3 Deviation from standard

No deviation.

5.4.4 Test setup

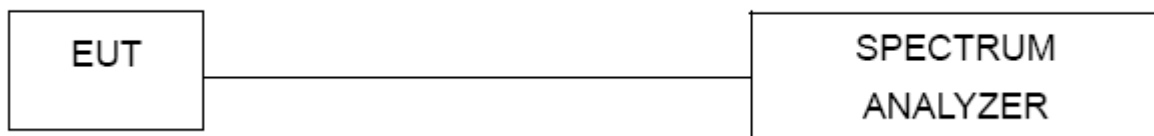

5.4.5 Test results

EUT:	BLUETOOTH SPEAKER	Model Name :	PH-BT1000
Temperature:	26 °C	Relative Humidity:	53%
Pressure:	1010 hPa	Test Power :	DC 3.7V from battery
Test Mode :	TX 1Mbps\ 3Mbps		

Test result:

Normal mode:

Test Channel	Bandwidth(MHz)	2/3 bandwidth(MHz)
Lowest	1.122	0.748
Middle	1.122	0.748
Highest	1.142	0.761

EDR mode:

Test Channel	bandwidth	2/3 bandwidth
Lowest	1.403	0.935
Middle	1.403	0.935
Highest	1.393	0.929

CH00-1Mbps

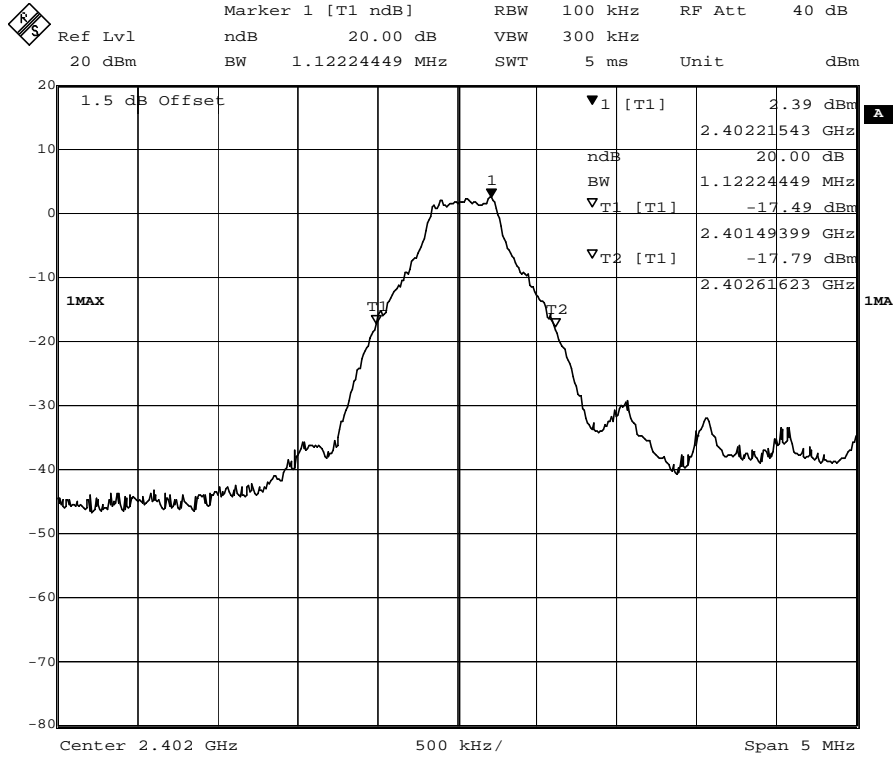

CH 39-1Mbps

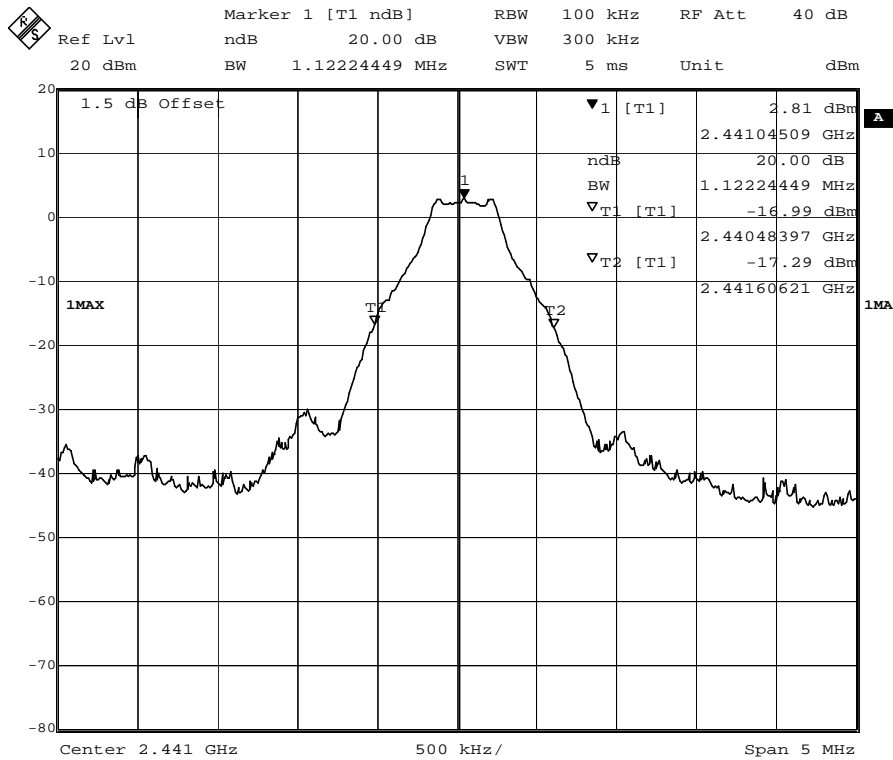

CH 78-1Mbps

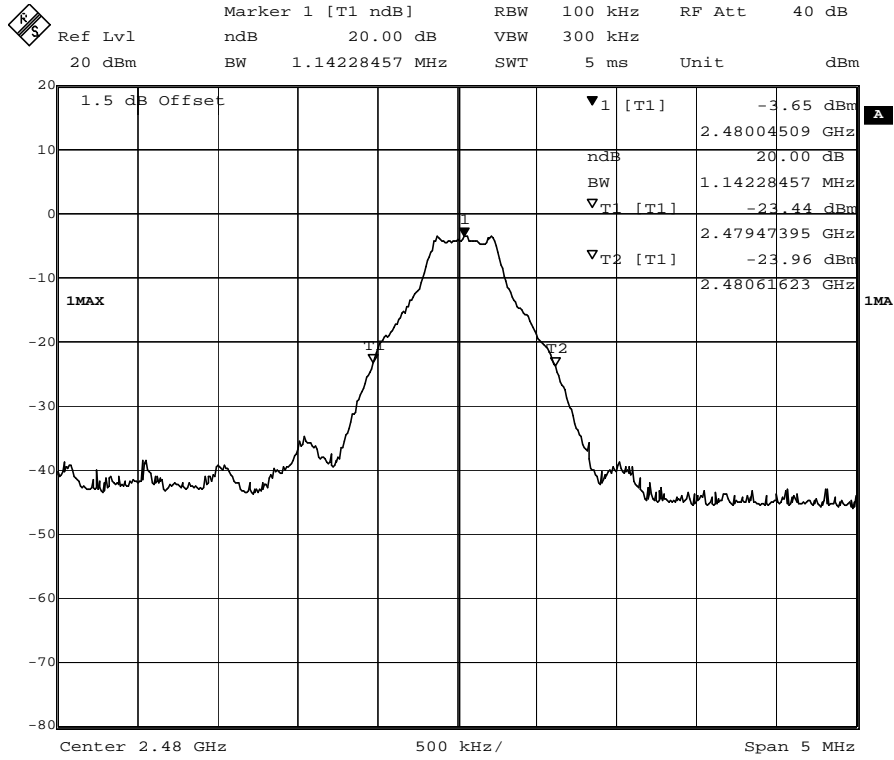

CH 00-3Mbps

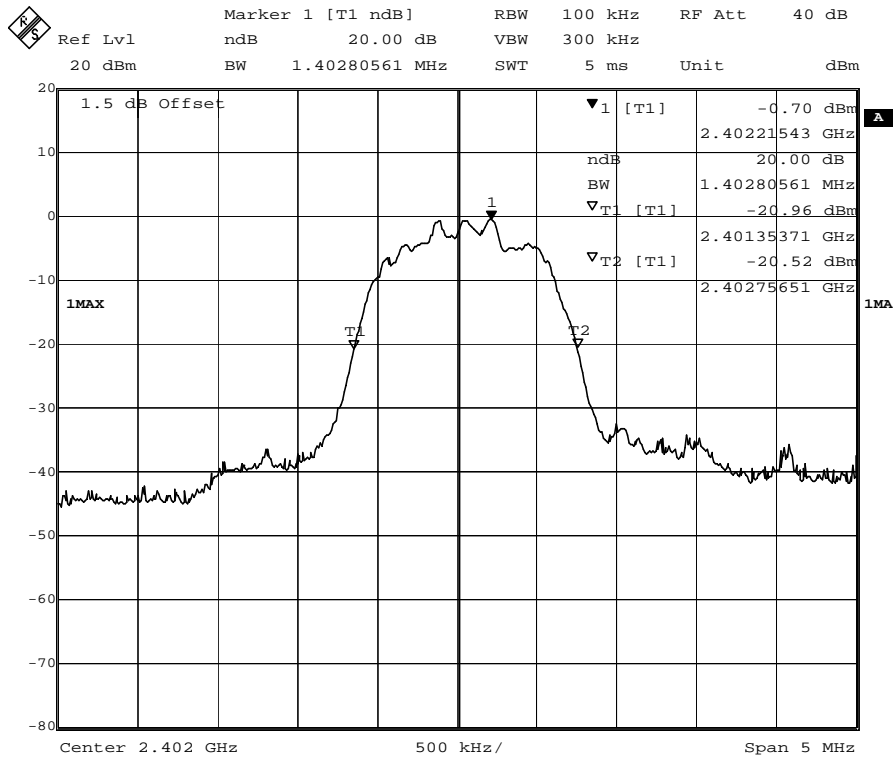

CH 39-3Mbps

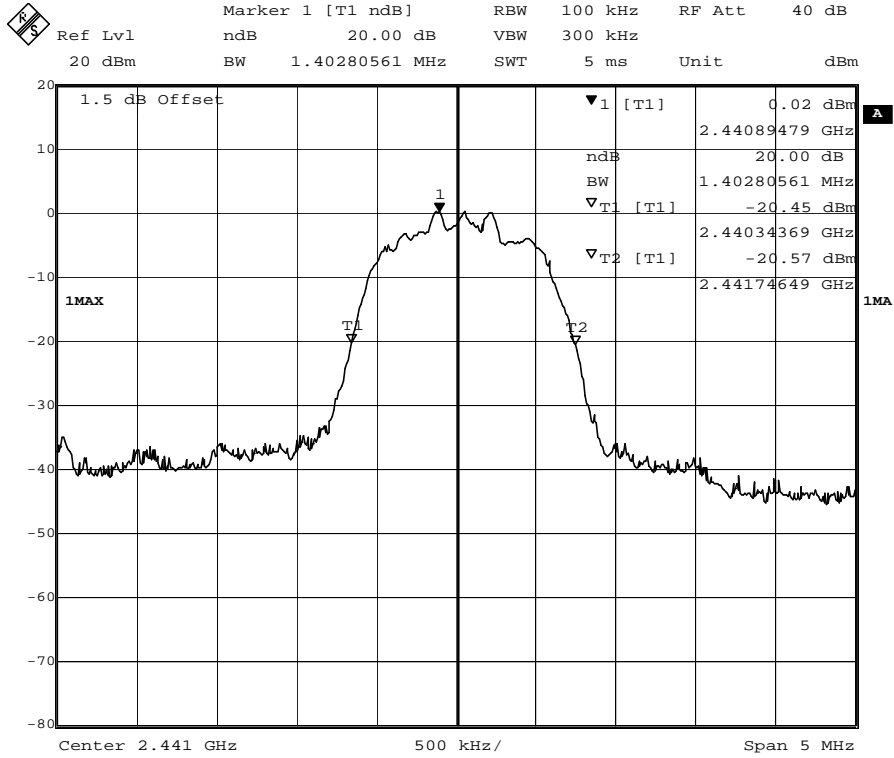

CH 78-3Mbps

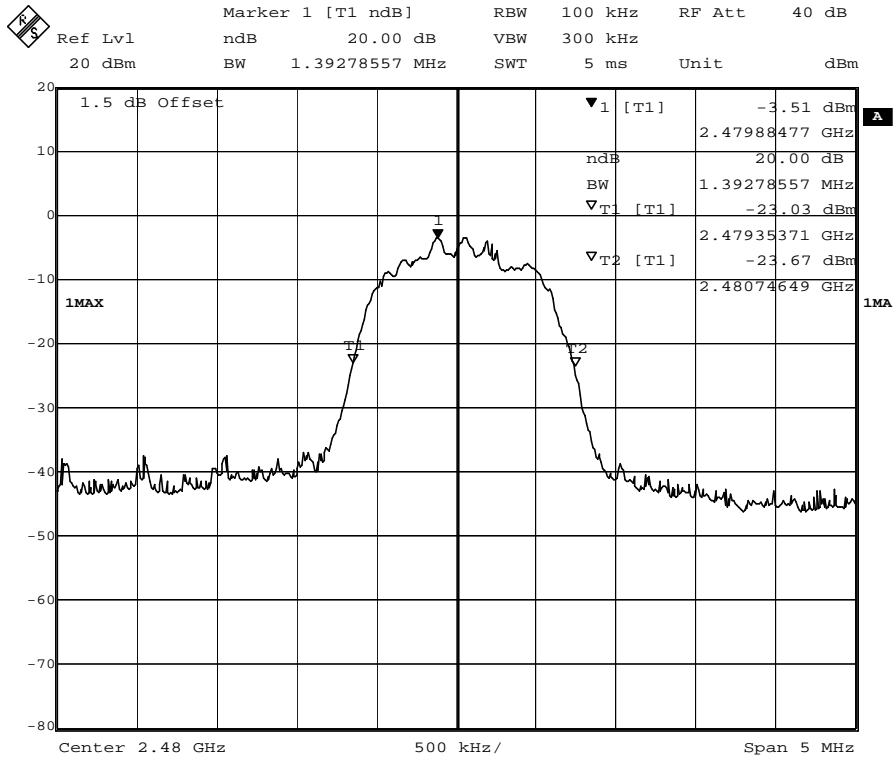

5.5 Carrier Frequencies Separated

5.5.1 Applied procedures / Limit

15.247(a) (1) Frequency hopping systems shall have hopping channel carrier frequencies separated by a minimum of 25 kHz or the 20 dB bandwidth of the hopping channel, whichever is greater. Alternatively, frequency hopping systems operating in the 2400-2483.5 MHz band may have hopping channel carrier frequencies that are separated by 25 kHz or two-thirds of the 20 dB bandwidth of the hopping channel, whichever is greater, provided the systems operate with an output power no greater than 125 mW.

5.5.2 Test procedure

- (1) Connected the antenna port to the Spectrum Analyzer, set the Spectrum Analyzer as RBW=100kHz, VBW \geq RBW, Sweep time=Auto, Detector Function=Peak.
- (2) The EUT should be transmitting at its maximum data rate. Use the marker-delta function to determine the separation between the peaks of the adjacent channels.
- (3) The above procedure shall be repeated at the lowest, the middle, and the highest frequency of the stated frequency range with modulated mode. also shall be performed at different modes of operation.

5.5.3 Deviation from standard

No deviation.

5.5.4 Test results

EUT:	BLUETOOTH SPEAKER	Model Name :	PH-BT1000
Temperature:	22 °C	Relative Humidity:	53%
Pressure:	1010 hPa	Test Power :	DC 3.7V from battery
Test Mode :	TX 3Mbps(the worst case)		

Test result:

Test Channel	Carrier Frequencies Separated	Pass/Fail
Lower Channels (channel 0 and channel 1)	1.022MHz	Pass
Middle Channels (channel 39 and channel 40)	1.042MHz	Pass
Upper Channels (channel 77 and channel 78)	1.022MHz	Pass

Remark:

The limit is maximum two-thirds of the 20 dB bandwidth: 935 KHz.

CH 00-1Mbps

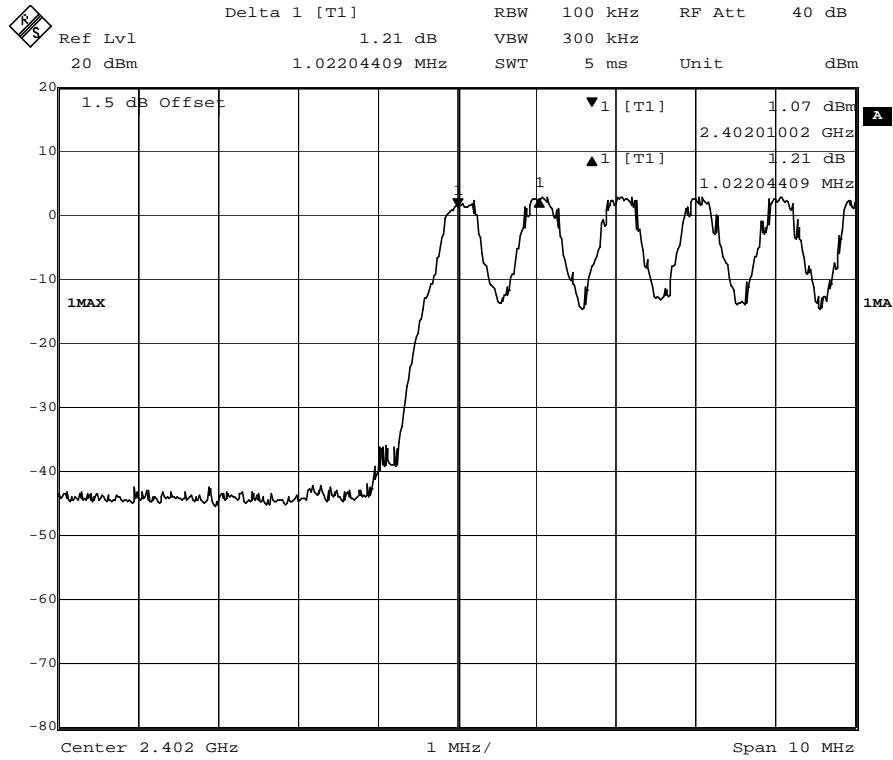

CH 39-1Mbps

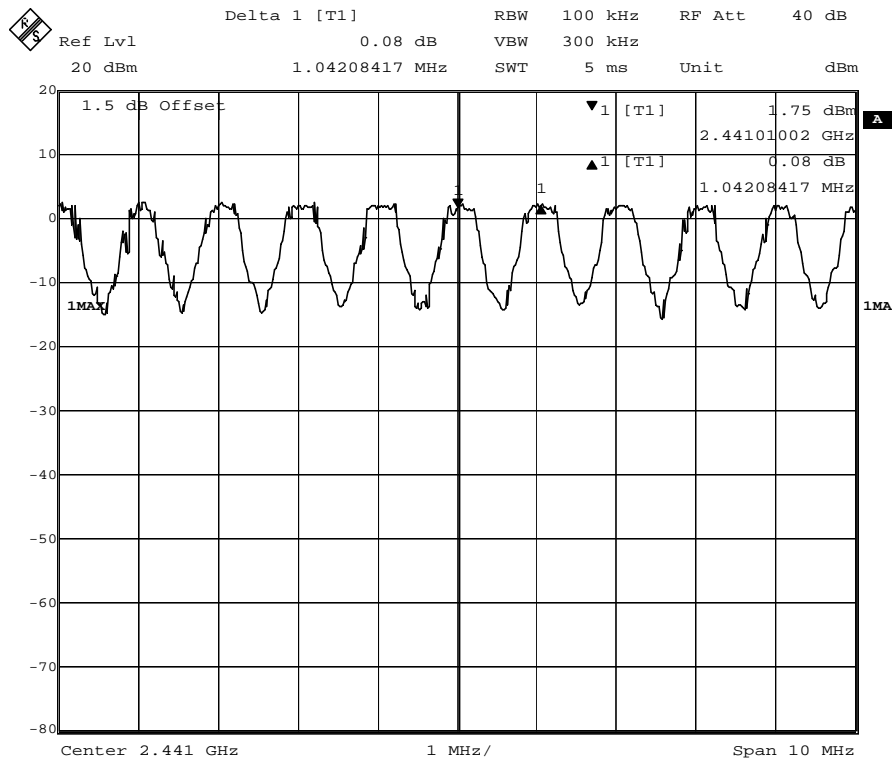

CH 78-1Mbps

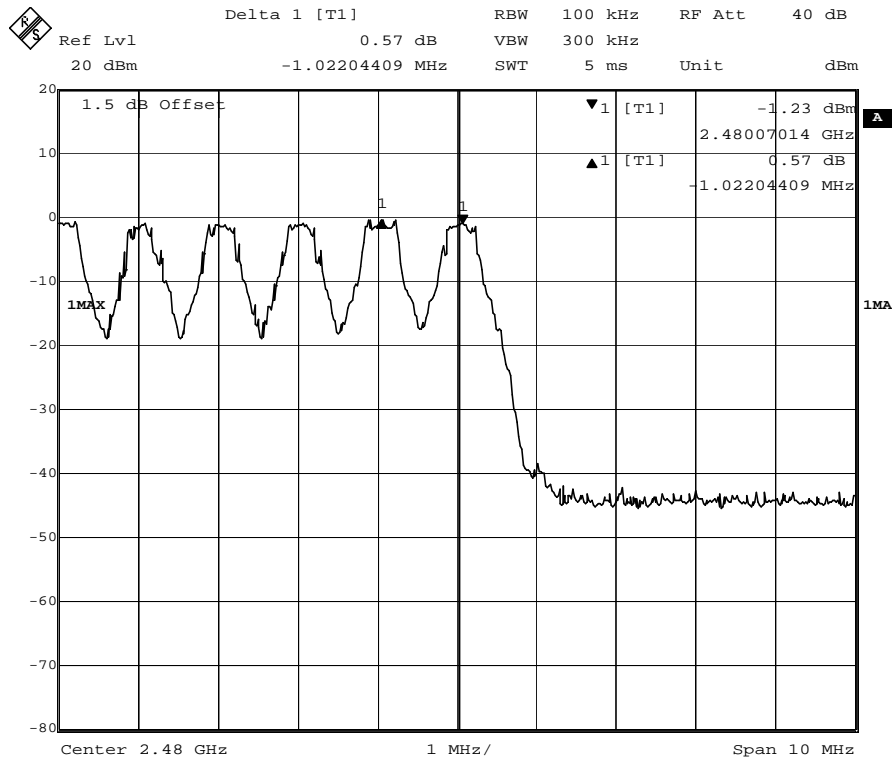

Test result: The unit does meet the FCC requirements.

5.6 Hopping Channel Number

5.6.1 Applied procedures / Limit

15.247(a) (1) (iii) Frequency hopping systems in the 2400-2483.5 MHz band shall use at least 15 channels. The average time of occupancy on any channel shall not be greater than 0.4 seconds within a period of 0.4 seconds multiplied by the number of hopping channels employed. Frequency hopping systems may avoid or suppress transmissions on a particular hopping frequency provided that a minimum of 15 channels are used.

5.6.2 Test procedure

- (1) Connected the antenna port to the Spectrum Analyzer , set the Spectrum Analyzer as RBW=100kHz,VBW \geq RBW, Sweep time=Auto, Detector Function=Peak Trace=Maxhold.
- (2) The EUT should be have its hopping function enabled. Maxhold and record hopping channels It may prove necessary to break the span up to sections, in order to clearly show all of the hopping frequencies.

5.6.3 Test result

Hopping Channel Number result		
Operating Mode: 1Mbps\ 3Mbps Mode		Test date:2012-07-18
Result	Limit	Conclusion
79	15	Pass

EUT:	BLUETOOTH SPEAKER	Model Name :	PH-BT1000
Temperature:	22 °C	Relative Humidity:	53%
Pressure:	1010 hPa	Test Power :	DC 3.7V from battery
Test Mode :	TX 1Mbps		

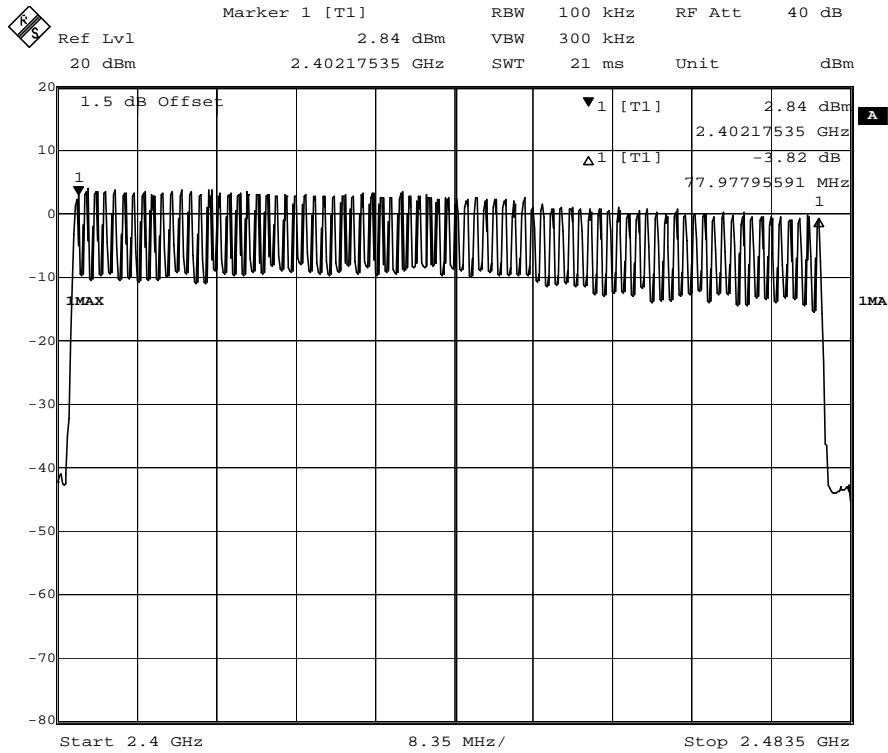

Test result: The unit does meet the FCC requirements.

5.7 Dwell time

5.7.1 Applied procedures / Limit

15.247(a) (1) (iii) Frequency hopping systems in the 2400-2483.5 MHz band shall use at least 15 channels. The average time of occupancy on any channel shall not be greater than 0.4 seconds within a period of 0.4 seconds multiplied by the number of hopping channels employed. Frequency hopping systems may avoid or suppress transmissions on a particular hopping frequency provided that a minimum of 15 channels are used.

5.7.2 Test procedure

1. Remove the antenna from the EUT and then connect a low attenuation RF cable from the antenna port to the spectrum.
2. Set spectrum analyzer span = 0. centered on a hopping channel;
3. Set RBW = 1 MHz and VBW = 1 MHz. Sweep = as necessary to capture the entire dwell time per hopping channel. Detector Function = Peak. Trace = Max hold;
4. Use the marker-delta function to determine the dwell time. If this value varies with different modes of operation (e.g.. data rate. modulation format. etc.). Repeat this test for each variation. The limit is specified in one of the subparagraphs of this Section. Submit this plot(s). An oscilloscope may be used instead of a spectrum analyzer.

5.7.3 Test result

EUT:	BLUETOOTH SPEAKER	Model Name :	PH-BT1000
Temperature:	22 °C	Relative Humidity:	53%
Pressure:	1010 hPa	Test Power :	DC 3.7V from battery
Test Mode :	3DH1/3DH3/3DH5		

The test period: T= 0.4 Second/Channel x 79 Channel = 31.6 s

1. Channel 0: 2.402GHz						
3DH1 time slot	=	0.405	(ms)	*	32	*
					(31.6/3.16)	=
						129.600
						ms
3DH3 time slot	=	1.657	(ms)	*	16	*
					(31.6/3.16)	=
						265.120
						ms
3DH5 time slot	=	2.919	(ms)	*	11	*
					(31.6/3.16)	=
						321.090
						ms
2. Channel 39: 2.441GHz						
3DH1 time slot	=	0.406	(ms)	*	32	*
					(31.6/3.16)	=
						129.920
						ms
3DH3 time slot	=	1.658	(ms)	*	16	*
					(31.6/3.16)	=
						265.280
						ms
3DH5 time slot	=	2.910	(ms)	*	11	*
					(31.6/3.16)	=
						320.100
						ms
3. Channel 78: 2.480GHz						
3DH1 time slot	=	0.406	(ms)	*	32	*
					(31.6/3.16)	=
						129.920
						ms
3DH3 time slot	=	1.658	(ms)	*	16	*
					(31.6/3.16)	=
						265.280
						ms
3DH5 time slot	=	2.910	(ms)	*	11	*
					(31.6/3.16)	=
						320.100
						ms

The average time of occupancy in the specified 31.6 second period is equal to pulse width*(# of pulse in observation period)*(test period / observation period)

The results are not greater than 0.4 seconds.

The unit does meet the FCC requirements.

Result plot as follows:

1. Lowest channel (2.402 GHz):

(1). 3DH1

Pulse Width:

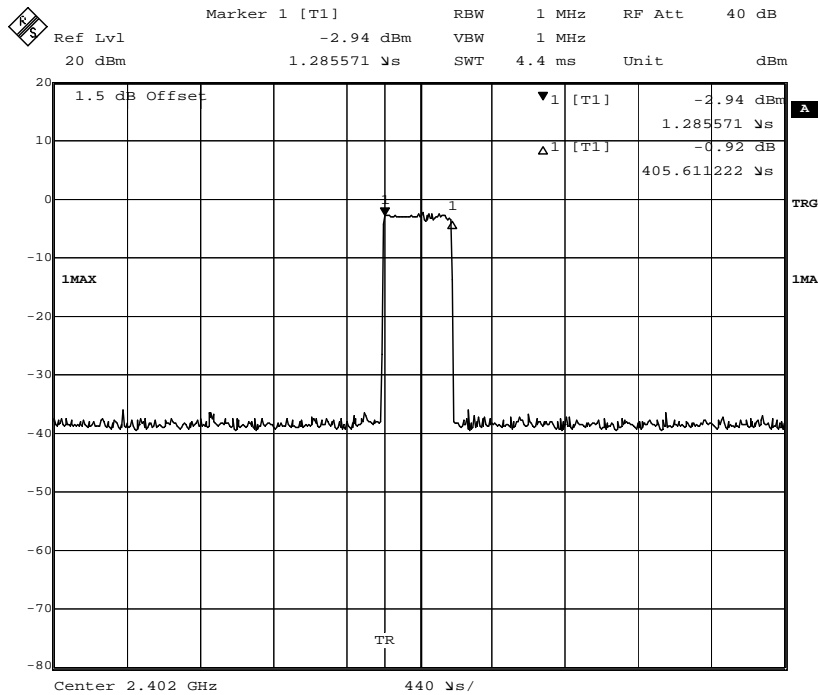

Number of Pulses in 3.16 S observation period:

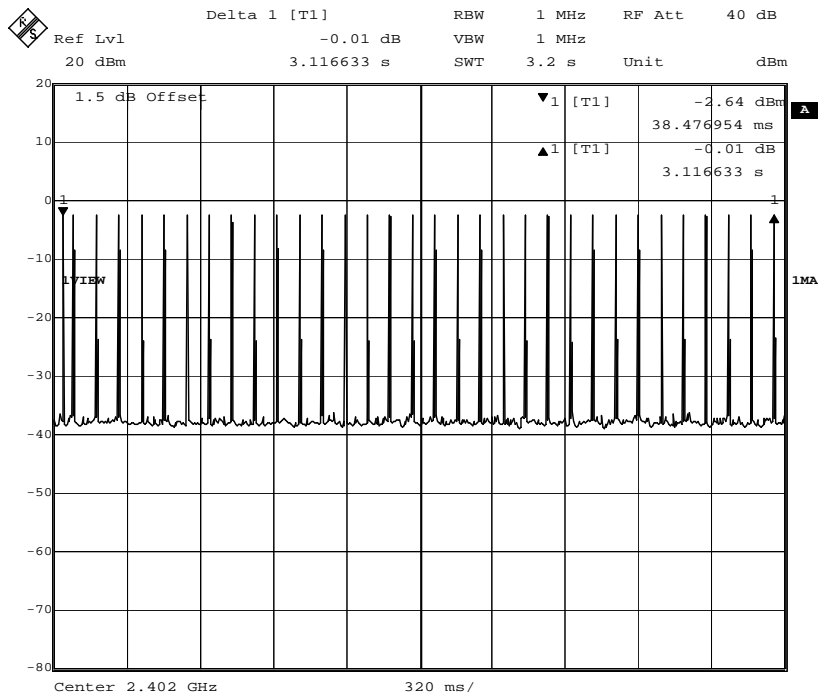

(2) 3DH3

Pulse Width:

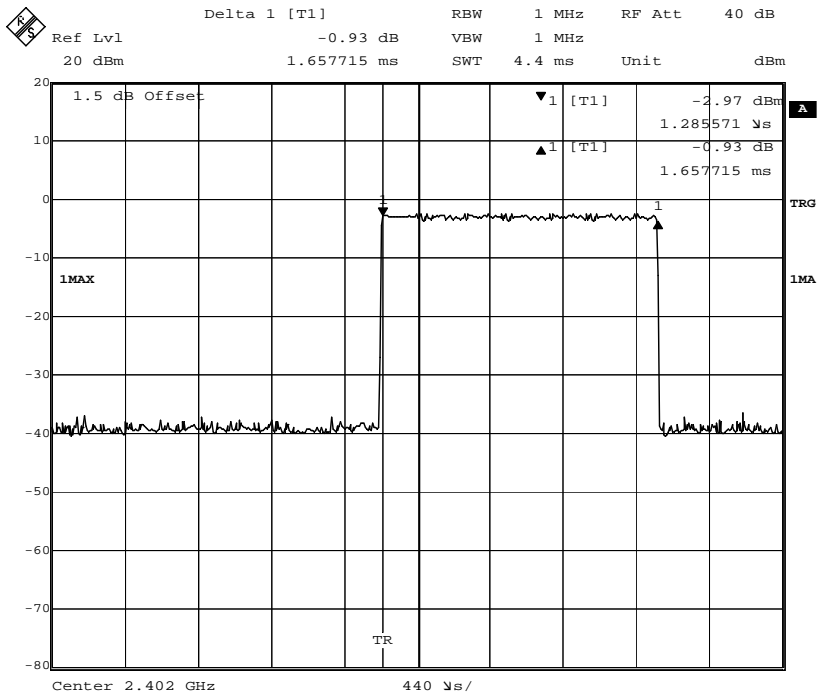

Number of Pulses in 3.16 S observation period:

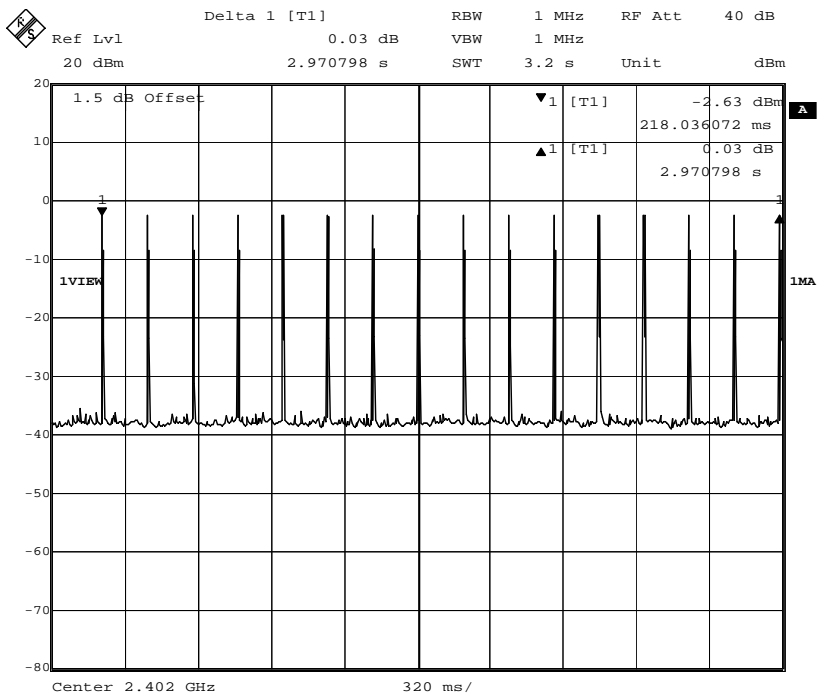

(3) 3DH5

Pulse Width:

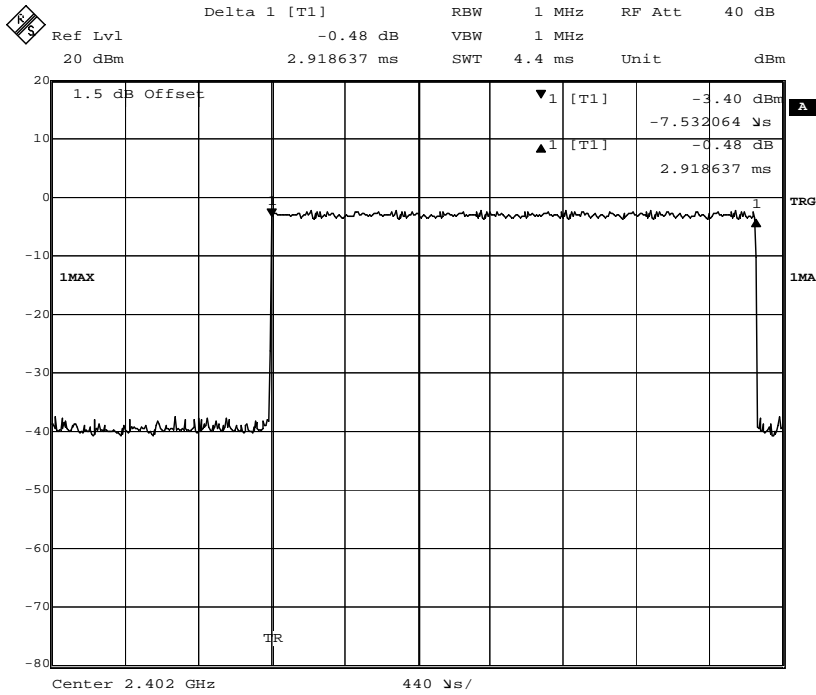

Number of Pulses in 3.16 S observation period:

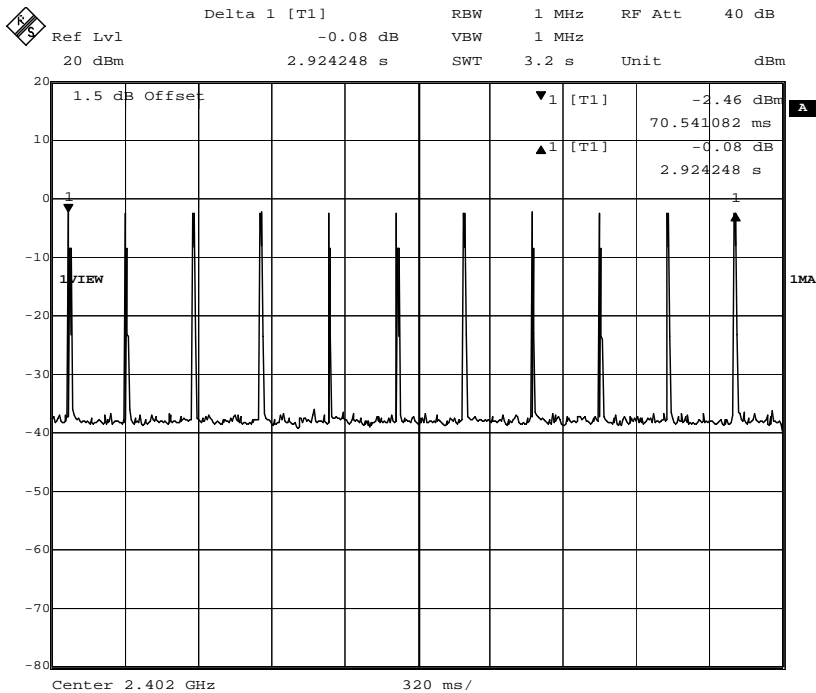

2. Middle Channel (2.441 GHz):

(1). 3DH1

Pulse Width:

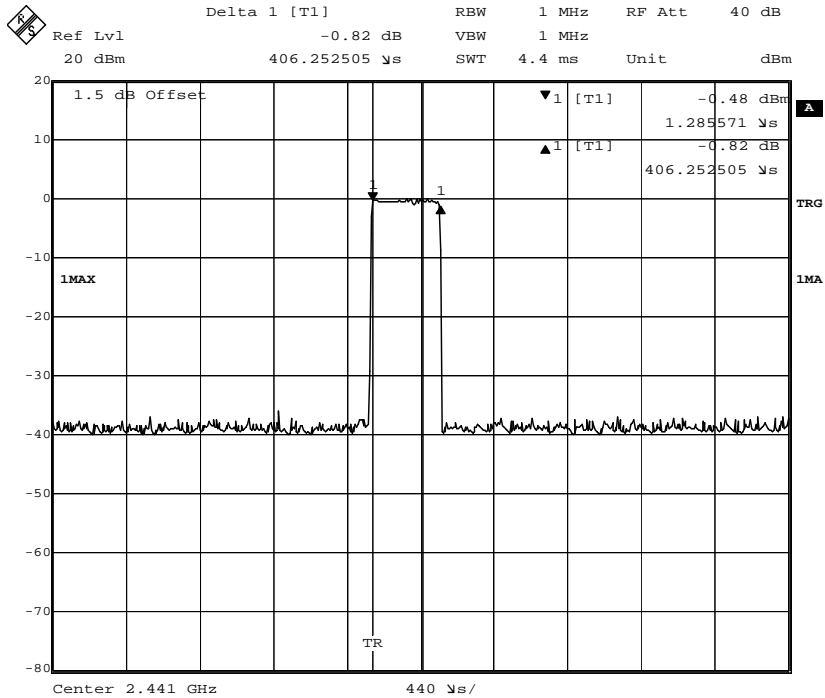

Number of Pulses in 3.16 S observation period:

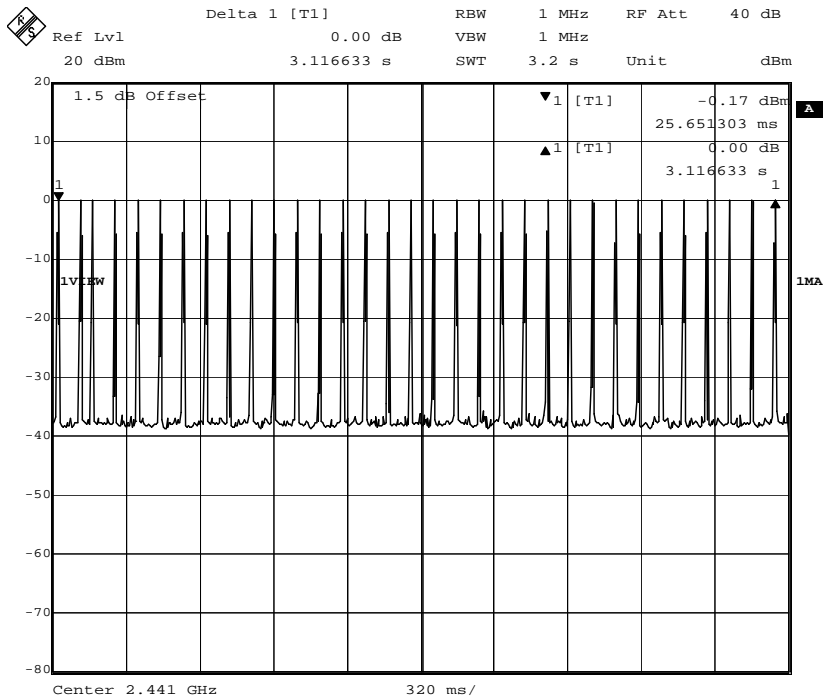

(2) 3DH3

Pulse Width:

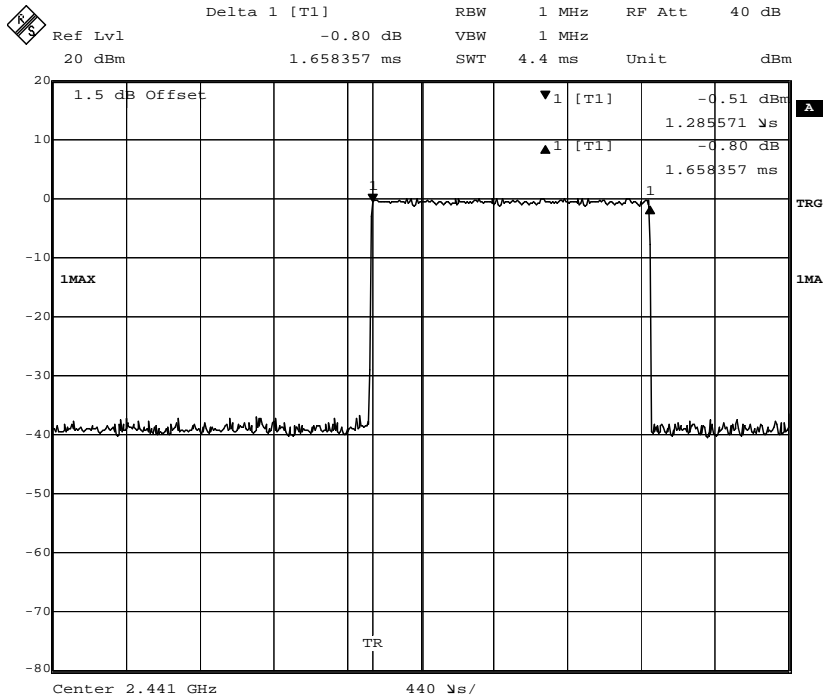

Number of Pulses in 3.16 S observation period:

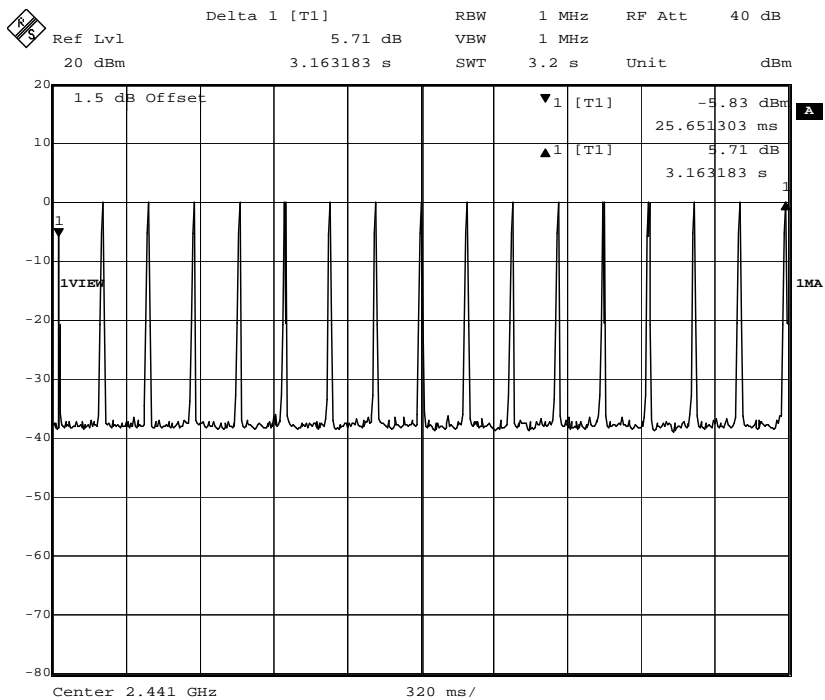

(3) 3DH5

Pulse Width:

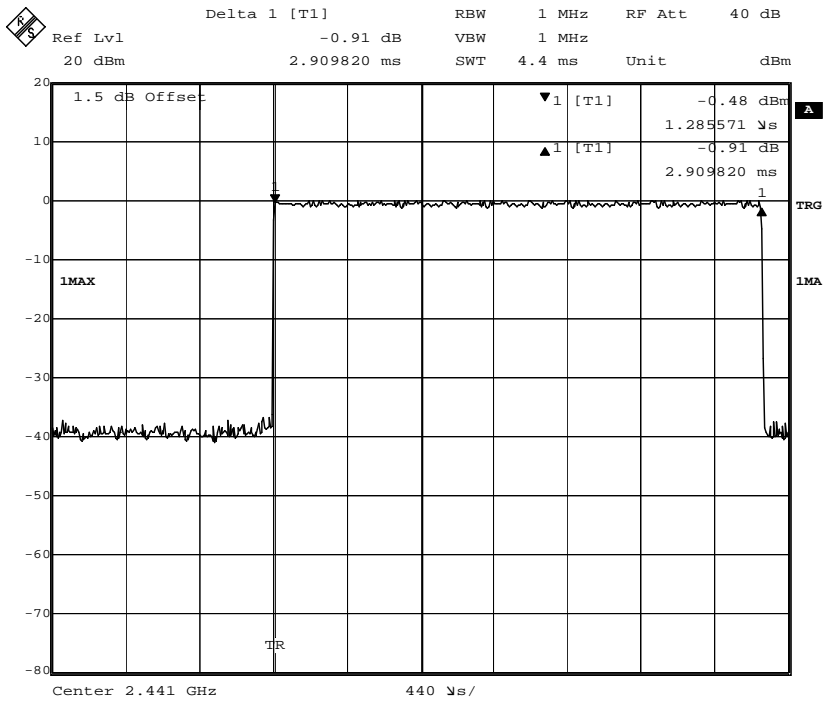

Number of Pulses in 3.16 S observation period:

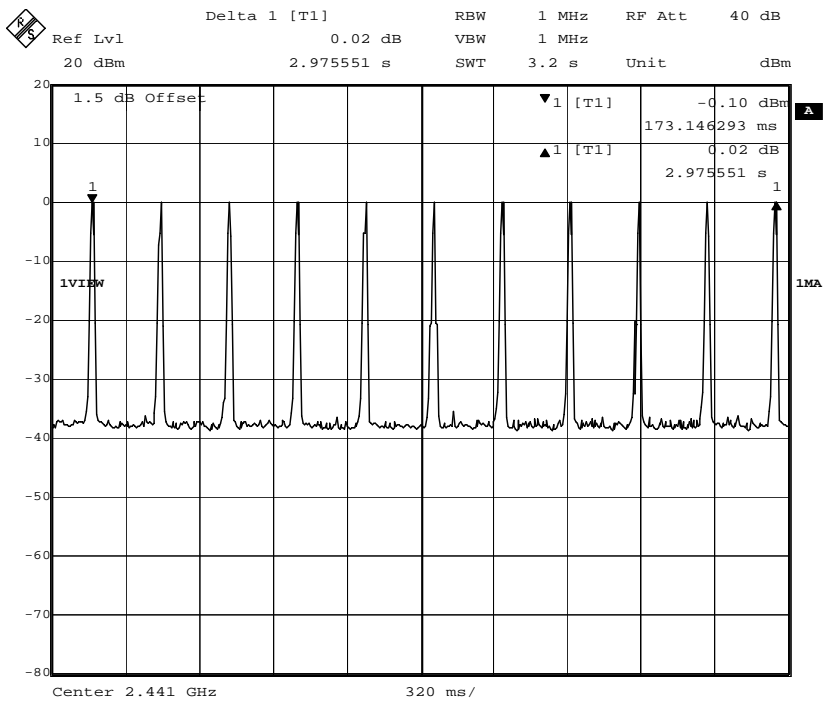

3. Highest Channel (2.480 GHz):

(1). 3DH1

Pulse Width:

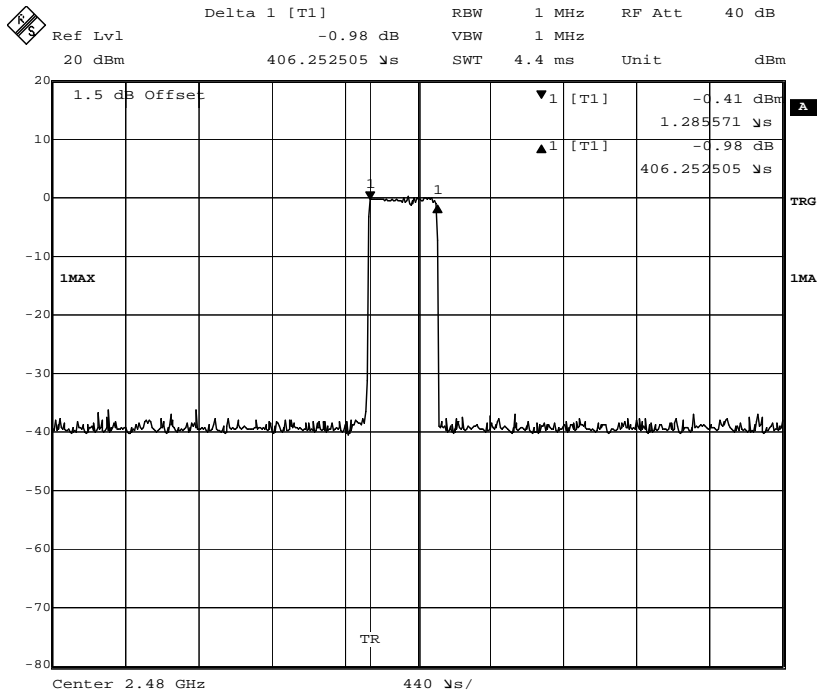

Number of Pulses in 3.16 S observation period:

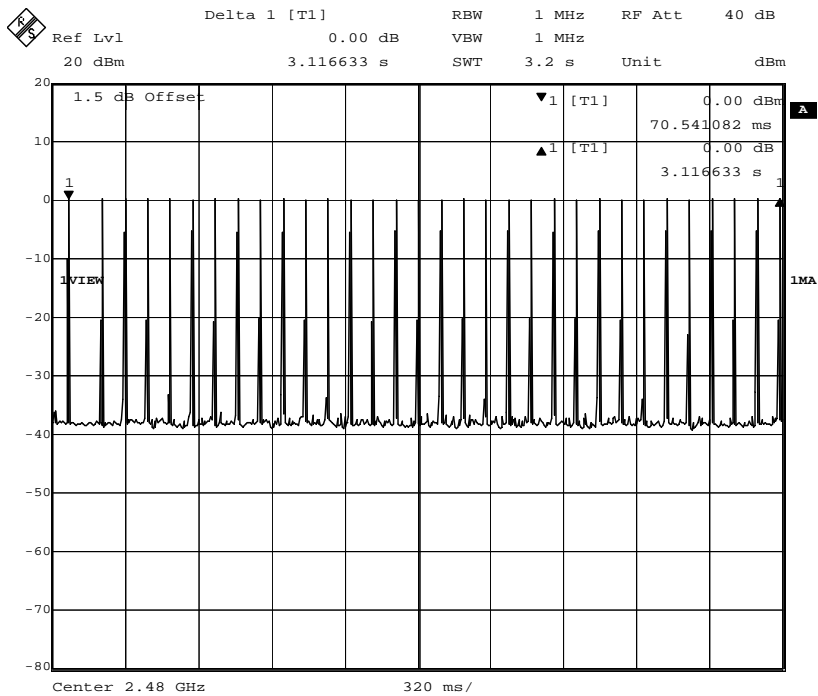

(2) 3DH3

Pulse Width:

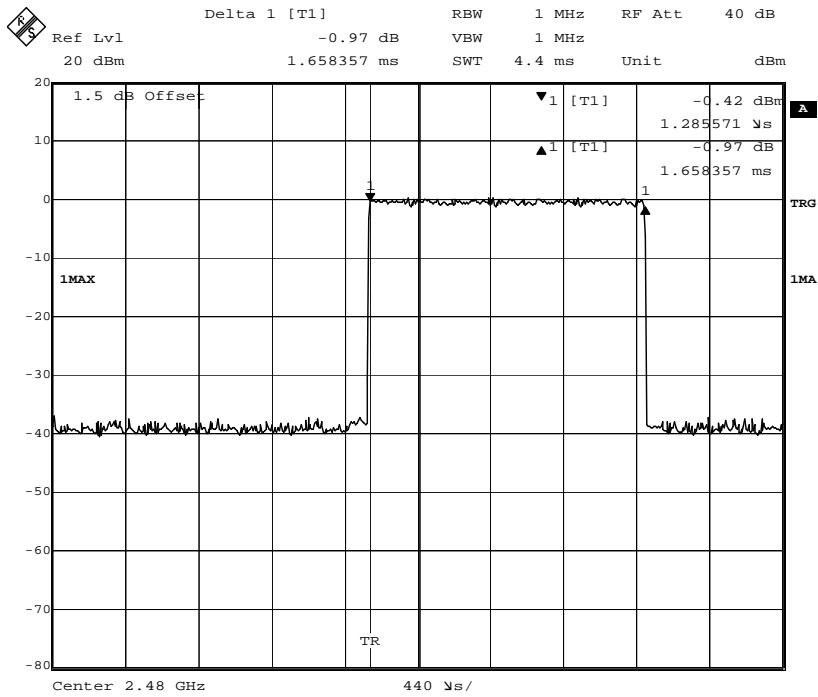

Number of Pulses in 3.16 S observation period:

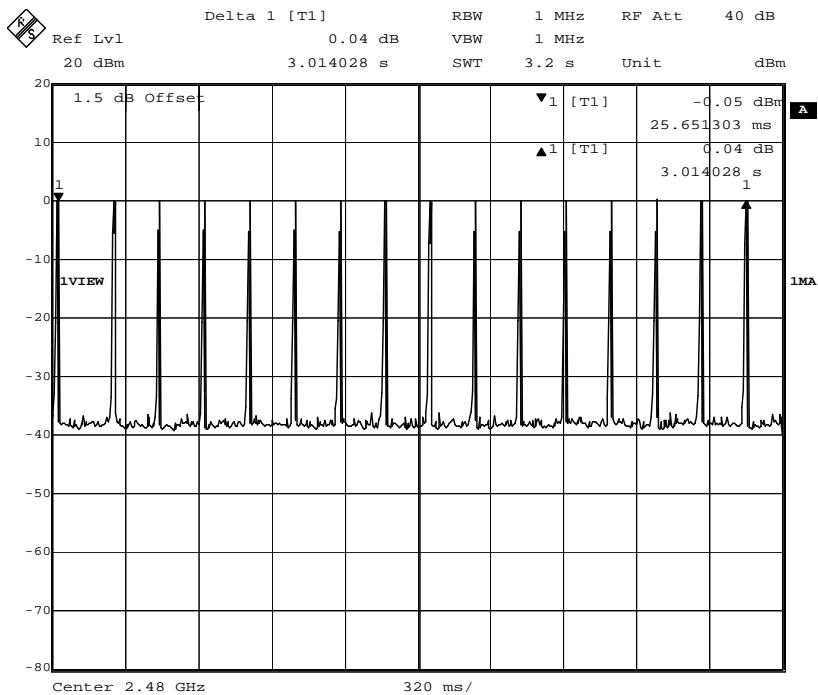

(3) 3DH5

Pulse Width:

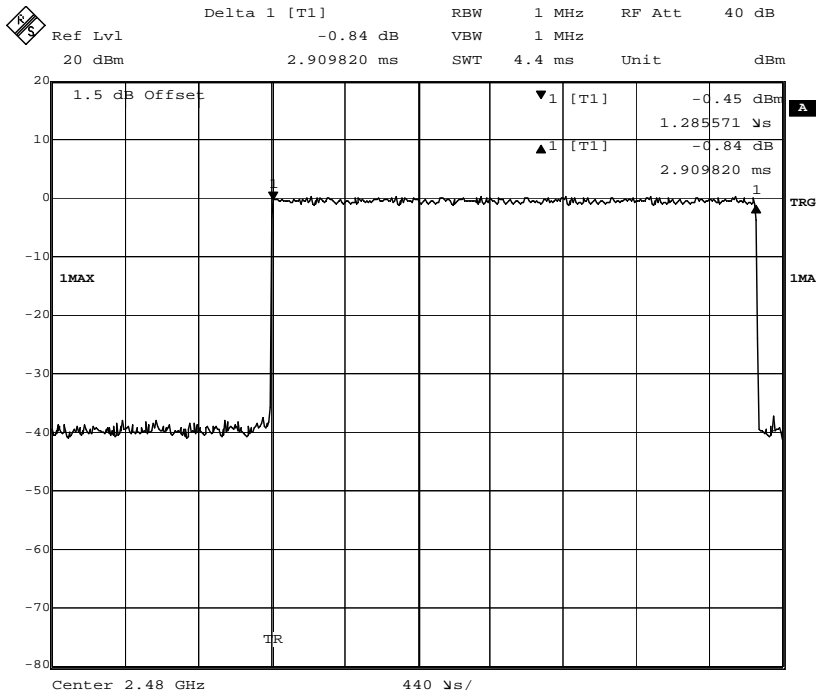

Number of Pulses in 3.16 S observation period:

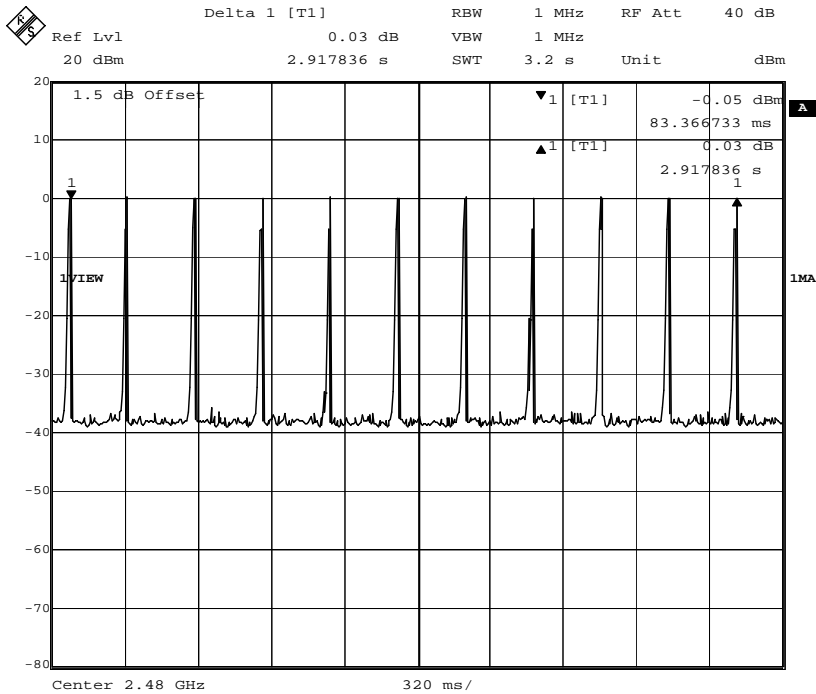

5.8 Maximum Peak Output Power

5.8.1 Applied procedures / Limit

15.247(b) (1) For frequency hopping systems operating in the 2400-2483.5 MHz band employing at least 75 non-overlapping hopping channels, and all frequency hopping systems in the 5725-5850 MHz band: 1watt. For all other frequency hopping systems in the 2400-2483.5 MHz band: 0.125 watts.

5.8.2 Test procedure

- (1) Connected the antenna port to the Spectrum Analyzer, set the Spectrum Analyzer as RBW=3MHz,VBW \geq RBW, Sweep time=Auto, Detector Function=Peak.
- (2) The EUT should be transmitting at its maximum data rate. Allow the trace to stabilize. Use the marker-to-peak function to set the marker to the peak of the emission. The indicated level is the peak output power.
- (3) The above procedure shall be repeated at the lowest, the middle, and the highest frequency of the stated frequency range with modulated mode. also shall be performed at different modes of operation.

5.8.3 Deviation from standard

No deviation.

5.8.4 Test setup



5.8.5 Test results

EUT:	BLUETOOTH SPEAKER	Model Name :	PH-BT1000
Temperature:	22 °C	Relative Humidity:	60%
Pressure:	1010 hPa	Test Voltage :	DC 3.7V from battery
Test Mode :	TX		
Note: All the data rates have be tested and the worst-case as the table below.			

Test Result:				
Normal mode:				
Test Channel	Fundamental Frequency (MHz)	Output Power (dBm)	Limit (dBm)	Result
Lowest	2402	2.60	30.0	Pass
Middle	2441	3.03	30.0	Pass
Highest	2480	-0.34	30.0	Pass
EDR mode:				
Test Channel	Fundamental Frequency (MHz)	Output Power (dBm)	Limit (dBm)	Result
Lowest	2402	0.80	30.0	Pass
Middle	2441	1.49	30.0	Pass
Highest	2480	-2.01	30.0	Pass
Remark: cable lose=1.5 dB				
Test result: The unit does meet the FCC requirements.				

CH 00-1Mbps

	Marker 1 [T1]	RBW	2 MHz	RF Att	40 dB
	Ref Lvl	2.60 dBm	VBW	2 MHz	
	20 dBm	2.40221042 GHz	SWT	5 ms	Unit dBm

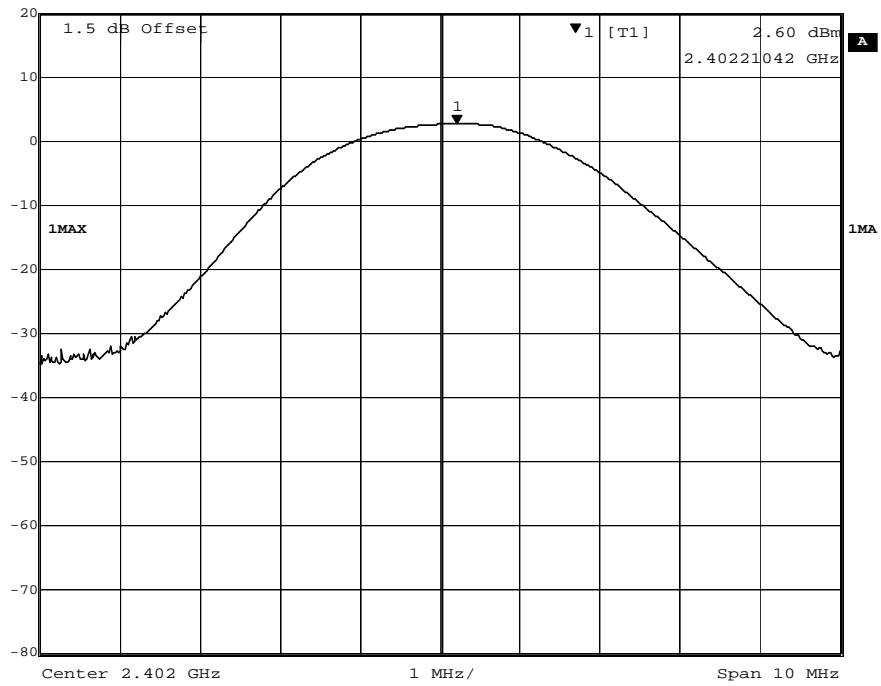

CH 39-1Mbps

	Marker 1 [T1]	RBW	2 MHz	RF Att	40 dB
	Ref Lvl	3.03 dBm	VBW	2 MHz	
	20 dBm	2.44086974 GHz	SWT	5 ms	Unit dBm

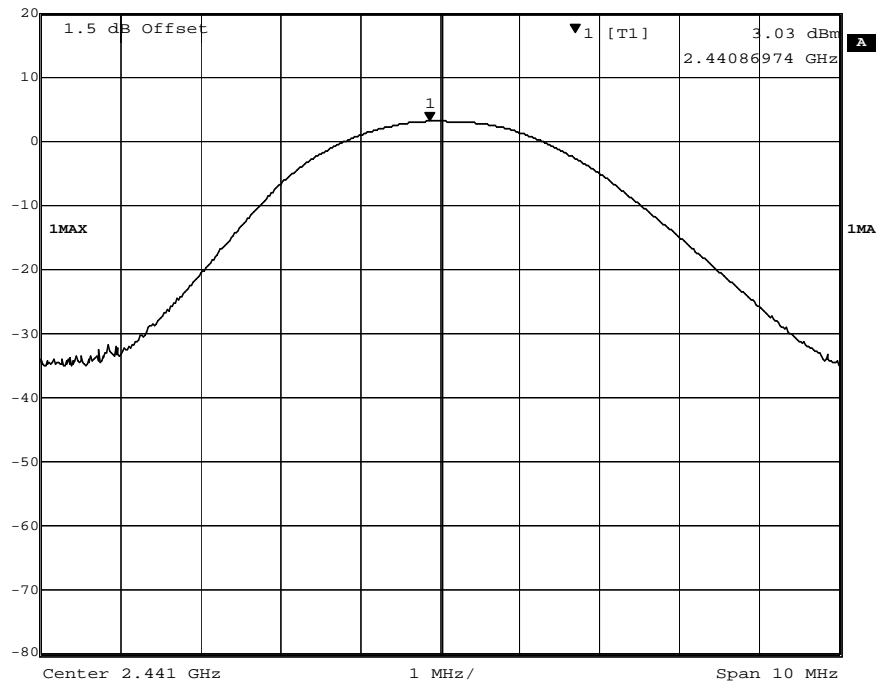

CH 78-1Mbps

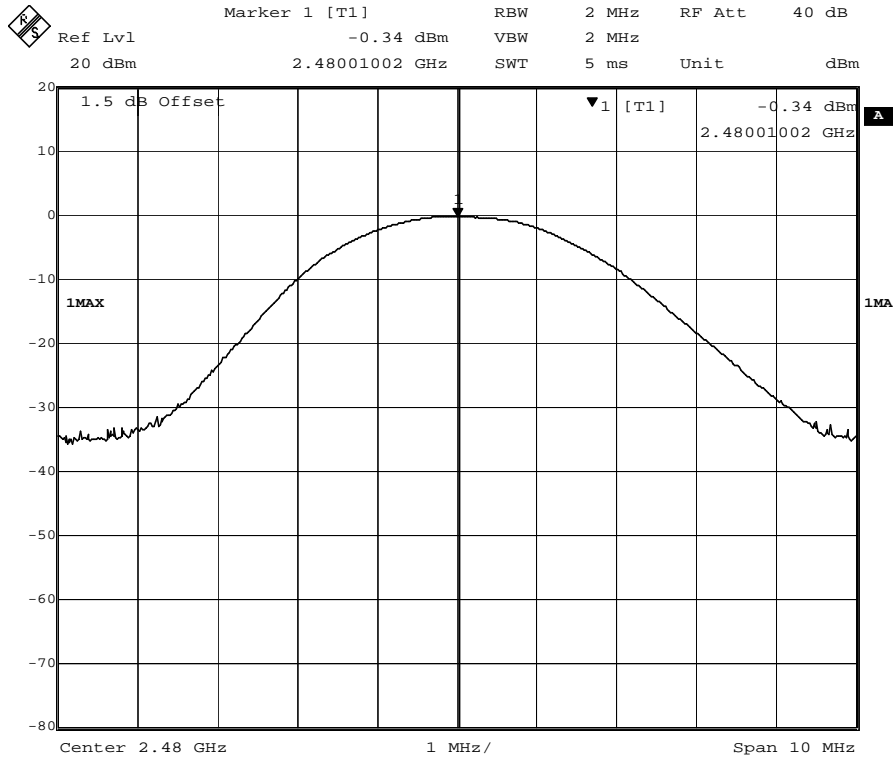

CH 00-3Mbps

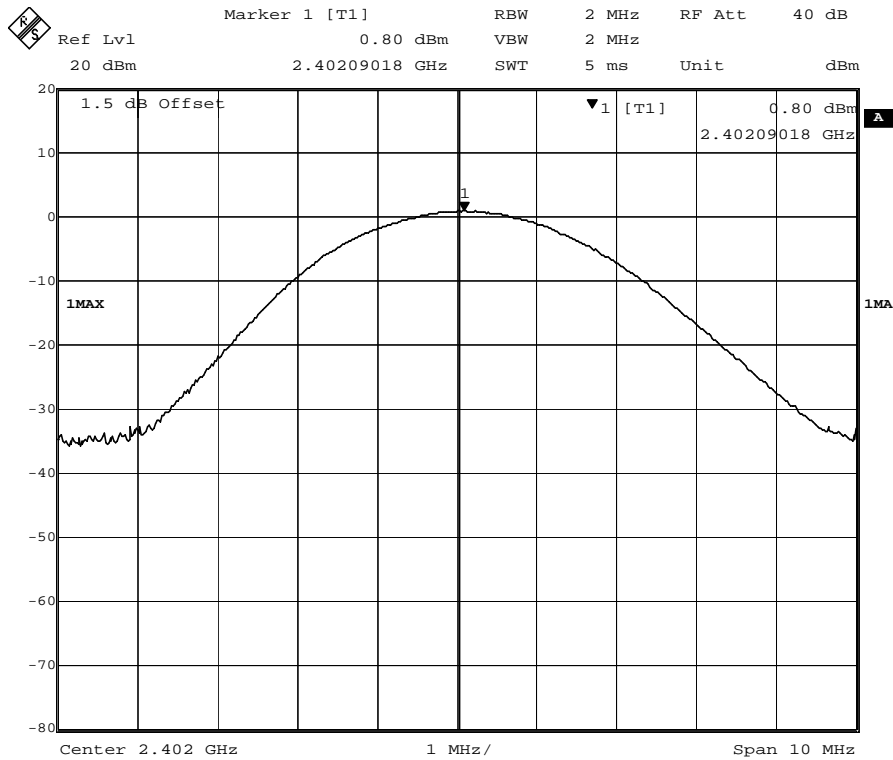

CH 39-3Mbps

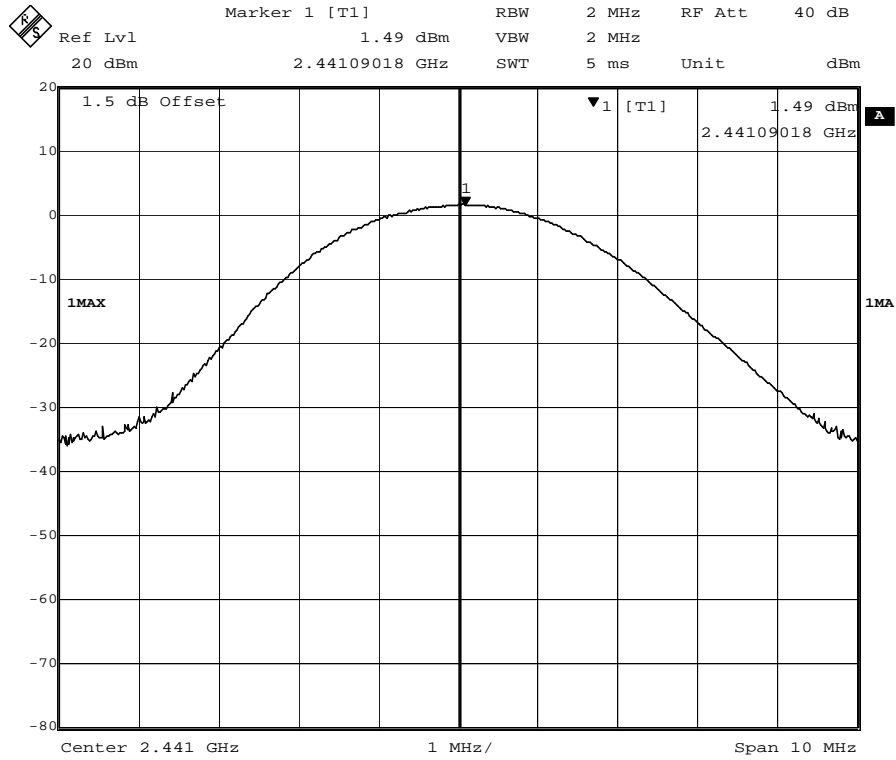

CH 78-3Mbps

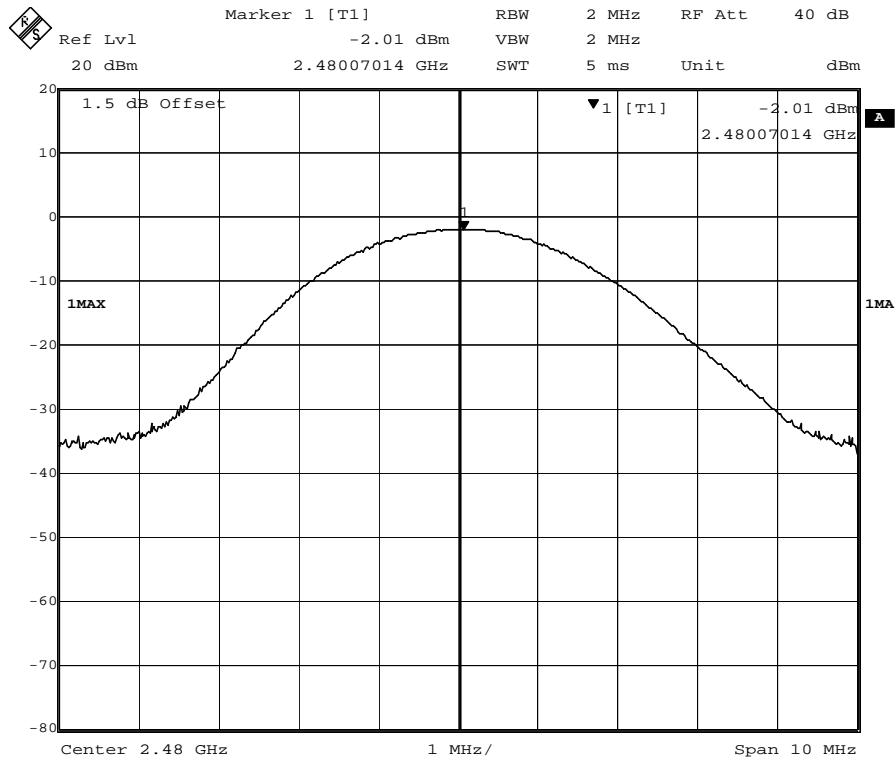

5.9 Band edge

5.9.1 Applied procedures / Limit

15.247(d) In any 100 kHz bandwidth outside the frequency band in which the spread spectrum or digitally modulated intentional radiator is operating, the radio frequency power that is produced by the intentional radiator shall be at least 20 dB below that in the 100 kHz bandwidth within the band that contains the highest level of the desired power, based on either an RF conducted or a radiated measurement, provided the transmitter demonstrates compliance with the peak conducted power limits. If the transmitter complies with the conducted power limits based on the use of RMS averaging over a time interval, as permitted under paragraph (b)(3) of this section, the attenuation required under this paragraph shall be 30 dB instead of 20 dB. Attenuation below the general limits specified in Section 15.209(a) is not required. In addition, radiated emissions which fall in the restricted bands, as defined in Section 15.205(a), must also comply with the radiated emission limits specified in Section 15.209(a) (see Section 15.205(c)).

5.9.2 Test procedure

- a. The EUT was directly connected to the spectrum analyzer and antenna output port as show in the block diagram below.
- b. Spectrum Setting: RBW=100kHz, VBW \geq RBW, Sweep time=Auto, Detector Function=Peak.

5.9.3 Deviation from standard

No deviation.

5.9.4 Test setup



5.9.5 Test results

CH00 (Lower) Data rate 1Mbps

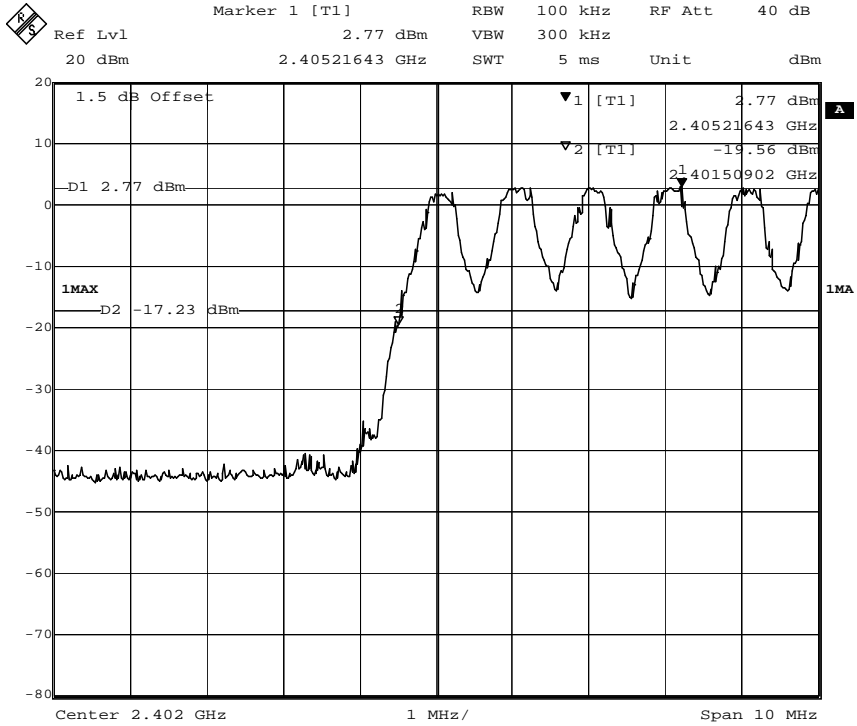

CH 78 (Upper) Data rate 1Mbps

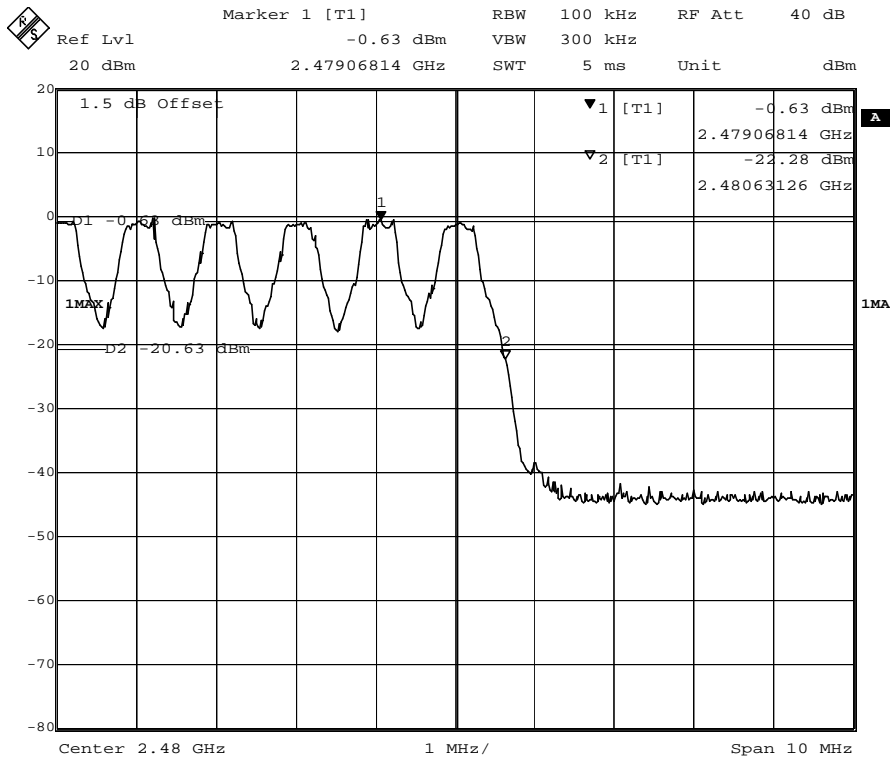

CH00 (Lower) Data rate 3Mbps

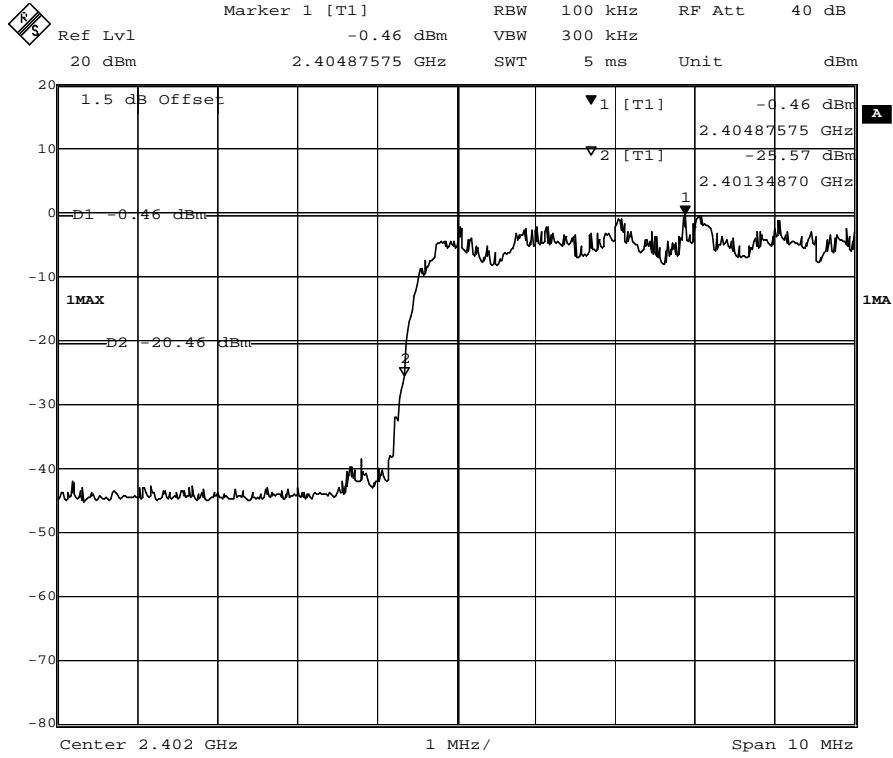

CH 78 (Upper) Data rate 3Mbps

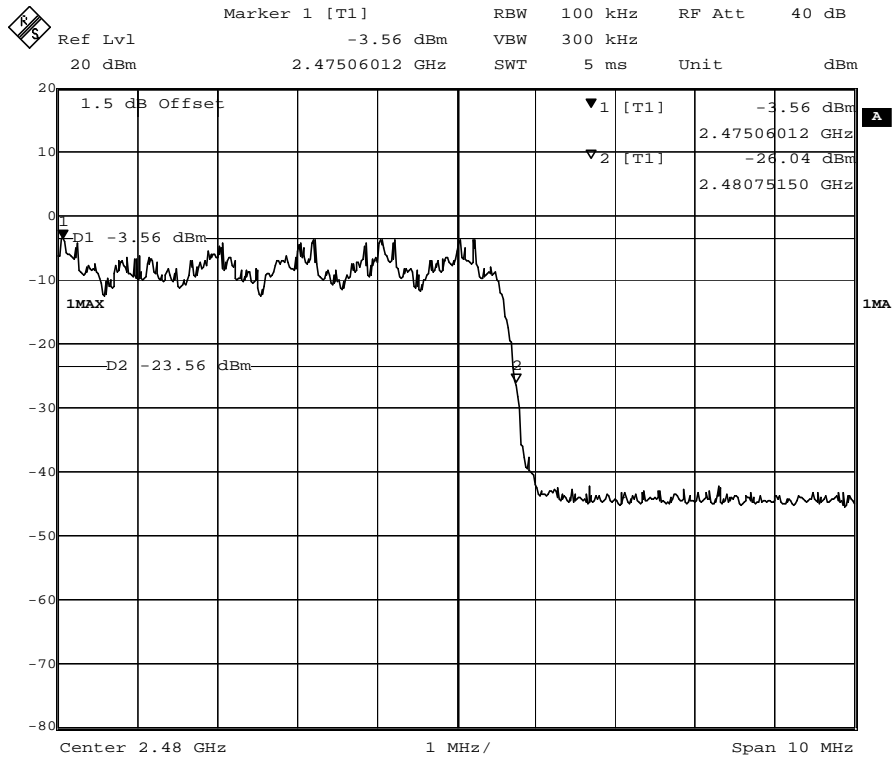

5.10 Conducted Spurious Emissions

5.10.1 Applied procedures / Limit

15.247(d) In any 100 kHz bandwidth outside the frequency band in which the spread spectrum or digitally modulated intentional radiator is operating, the radio frequency power that is produced by the intentional radiator shall be at least 20 dB below that in the 100 kHz bandwidth within the band that contains the highest level of the desired power, based on either an RF conducted or a radiated measurement, provided the transmitter demonstrates compliance with the peak conducted power limits. If the transmitter complies with the conducted power limits based on the use of RMS averaging over a time interval, as permitted under paragraph (b)(3) of this section, the attenuation required under this paragraph shall be 30 dB instead of 20 dB. Attenuation below the general limits specified in Section 15.209(a) is not required. In addition, radiated emissions which fall in the restricted bands, as defined in Section 15.205(a), must also comply with the radiated emission limits specified in Section 15.209(a) (see Section 15.205(c)).

5.10.2 Test procedure

- a. The EUT was directly connected to the spectrum analyzer and antenna output port as show in the block diagram below.
- b. Spectrum Setting: RBW=100kHz, VBW \geq RBW, Sweep time=Auto, Detector Function=Peak.

5.10.3 Deviation from standard

No deviation.

5.10.4 Test setup



5.10.5 Test results

CH00 Data rate 1Mbps

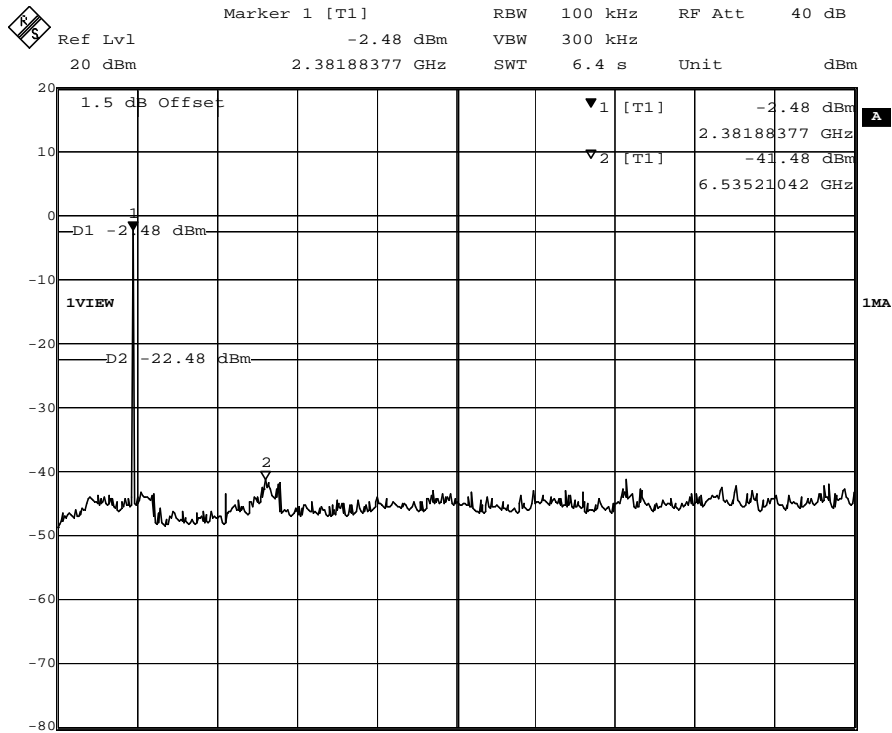

CH39 Data rate 1Mbps

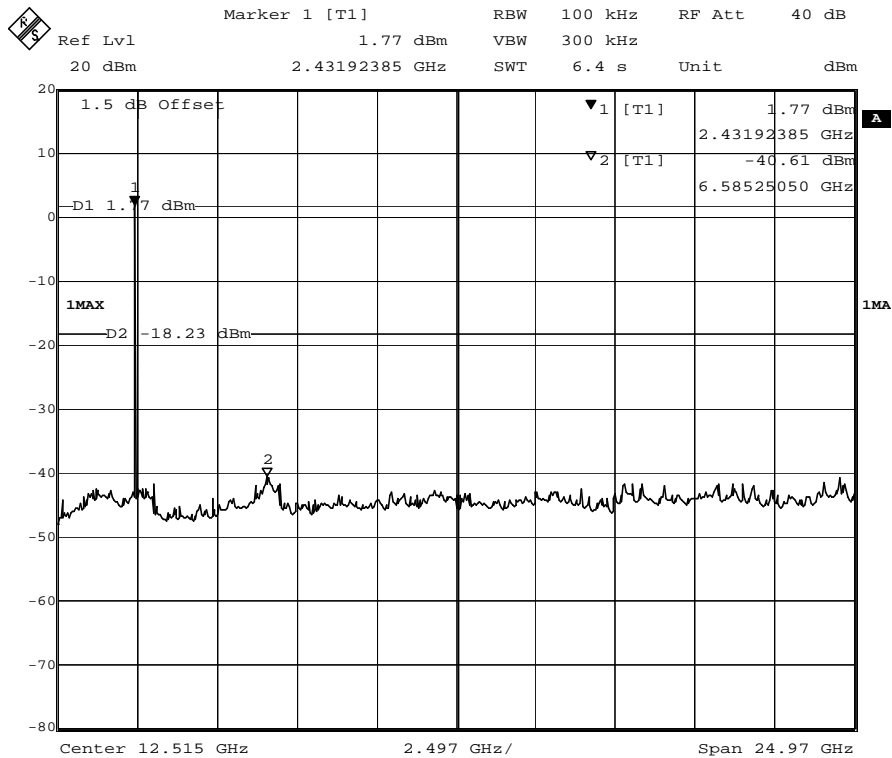

CH78 Data rate 1Mbps

