

Puma Top Core Label

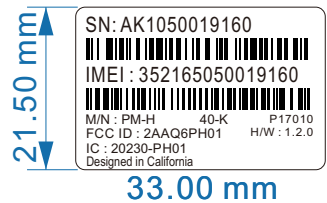

Extra Label

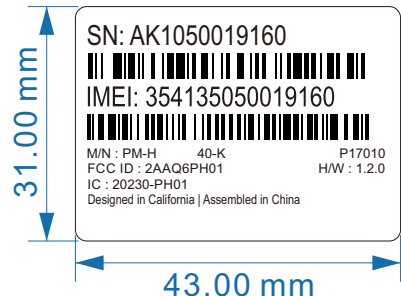
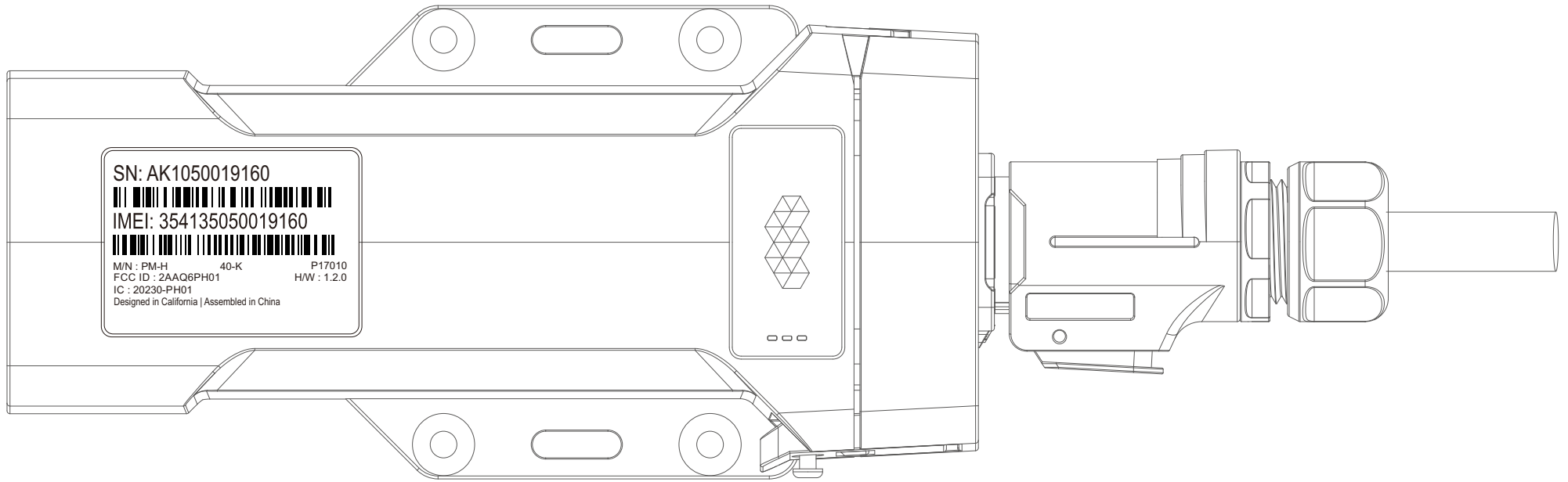
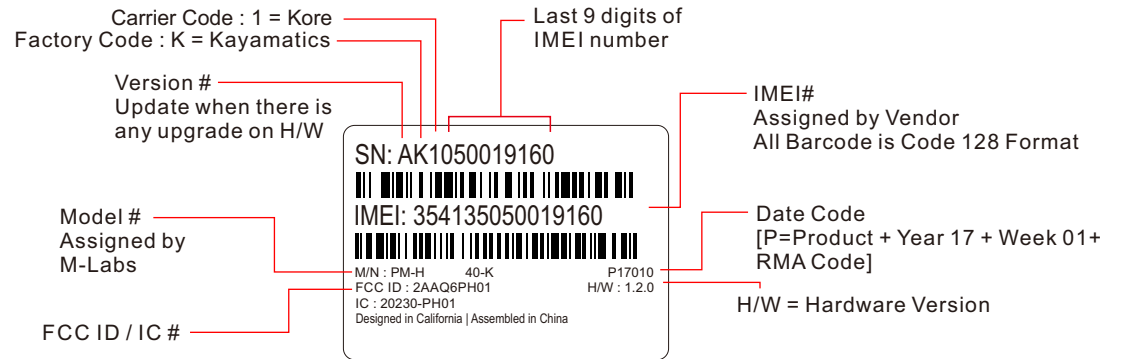

REV No.	GRID REF	DATE	CHANGE DESCRIPTION	DRAWN	CHKD

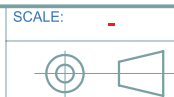

CLIENT: **M-LABS TECHNOLOGIES**
 CLIENT CODE: -
 PROJECT: **PUMA TRACKER**
 TITLE: **PUMA TOP CORE LABEL**

DRAWN:	SHEET: 1 OF 5
DRAWN DATE: 15-11-17	CHECKED: EDMUND
CAD FILE: -	GRADE:
MATERIAL:	COLOUR:
FINISH: -	A4
DWG. No.:	REV No.: 1.4

Previous issues to this drawing must be destroyed. All rights strictly reserved and all designs remain the property of M-Labs Technologies, LLC until fully assigned. Reproduction or disclosure to third parties in any form whatsoever is not permitted without written authority from M-Labs Technologies, LLC.

Puma Rear Core Label

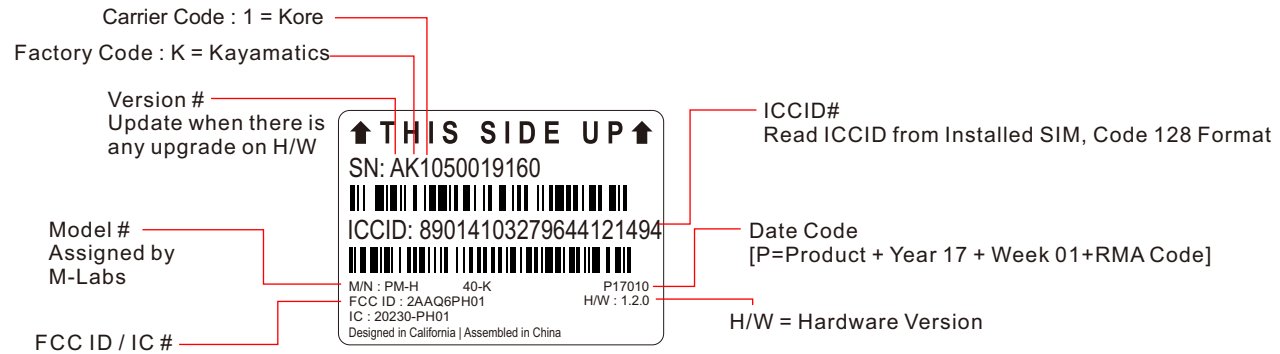
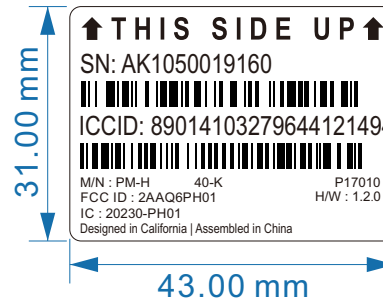

REV No.	GRID REF	DATE	CHANGE DESCRIPTION	DRAWN	CHKD



CLIENT: **M-LABS TECHNOLOGIES**

CLIENT CODE: -

PROJECT: **PUMA TRACKER**

TITLE: **PUMAREAR CORE LABEL**

DRAWN:	SHEET: 2 OF 5
DRAWN DATE: 15-11-17	CHECKED: EDMUND
CAD FILE: -	GRADE: -
MATERIAL: -	COLOUR: -
FINISH: -	REV No.: A4
DWG. No.:	1.4

Previous issues to this drawing must be destroyed. All rights strictly reserved and all designs remain the property of M-Labs Technologies, LLC until fully assigned. Reproduction or disclosure to third parties in any form whatsoever is not permitted without written authority from M-Labs Technologies, LLC.

Puma Cap Inner Label

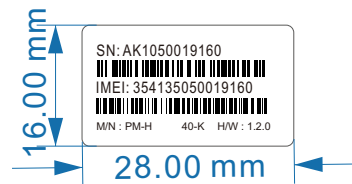
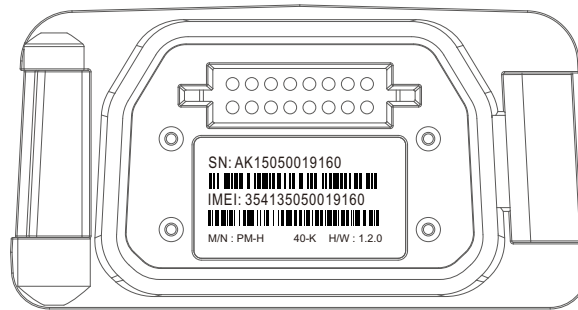

Carrier Code : 1 = Kore
 Factory Code : K = Kayamatics

Version #
 Update when there is
 any upgrade on H/W

Model #
 Assigned by
 M-Labs

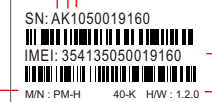

MEID/IMEI#
 Assigned by Vendor
 All Barcode is Code 128 Format

H/W = Hardware Version

REV No.	GRID REF	DATE	CHANGE DESCRIPTION	DRAWN	CHKD

Previous issues to this drawing must be destroyed. All rights strictly reserved and all designs remain the property of M-Labs Technologies, LLC until fully assigned. Reproduction or disclosure to third parties in any form whatsoever is not permitted without written authority from M-Labs Technologies, LLC.



CLIENT:
M-LABS TECHNOLOGIES

CLIENT CODE: -

PROJECT:
PUMA TRACKER

TITLE:
PUMA INNER CAP CORE LABEL

DRAWN:	SHEET: 3 OF 5
DRAWN DATE: 15-11-17	CHECKED: EDMUND
CAD FILE: -	GRADE: -
MATERIAL: -	COLOUR: -
FINISH: -	A4
DWG. No.:	REV No.: 1.4

Puma PCBA Frame Label

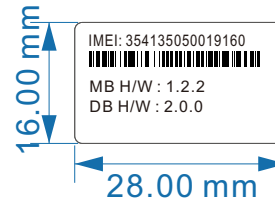
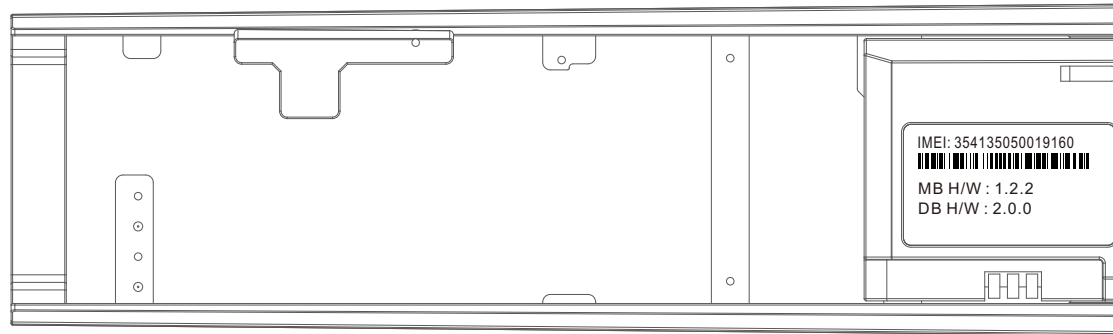

Mother Board HW Version

Daughter Board HW Version

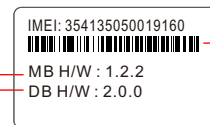

MEID/IMEI#
Assigned by Vendor
All Barcode is Code 128 Format

REV No.	GRID REF	DATE	CHANGE DESCRIPTION	DRAWN	CHKD

Previous issues to this drawing must be destroyed. All rights strictly reserved and all designs remain the property of M-Labs Technologies, LLC until fully assigned. Reproduction or disclosure to third parties in any form whatsoever is not permitted without written authority from M-Labs Technologies, LLC.



SCALE: -



CLIENT:
M-LABS TECHNOLOGIES

CLIENT CODE: -
PROJECT:
PUMA TRACKER

TITLE:
PUMA PCBA FRAME CORE LABEL

DRAWN:	SHEET: 4 OF 5
DRAWN DATE: 15-11-17	CHECKED: EDMUND
CAD FILE: -	GRADE:
MATERIAL: -	COLOUR:
FINISH: -	A4
DWG. No.:	REV No.: 1.4

Change Note :

V1.0 Initial Release	27 April 2017
V1.1 Add more labels	05 May, 2017
V1.2 Model Number Update to PM-H 40-K	14 Oct, 2017
V1.3 Add ICCID Number	25 Oct, 2017
V1.4 Adjust Core Label size	15 Nov, 2017

								CLIENT: M-LABS TECHNOLOGIES		DRAWN:		SHEET: 5 OF 5	
								CLIENT CODE: -		DRAWN DATE: 15-11-17		CHECKED: EDMUND	
						PROJECT: PUMA TRACKER LABELING		MATERIAL: -		GRADE: -			
						SCALE: -		FINISH: -		COLOUR: -		A4	
								TITLE: CHANGE NOTE		DWG. No.:		REV No.: 1.4	
REV No.	GRID REF	DATE	CHANGE DESCRIPTION	DRAWN	CHKD			CHANGE NOTE					

Previous issues to this drawing must be destroyed. All rights strictly reserved and all designs remain the property of until fully M-Labs Technologies LLC assigned. Reproduction or disclosure to third parties in any form whatsoever is not permitted without written authority from M-Labs Technologies LLC.