



# FCC RADIO TEST REPORT

## FCC ID: 2AAPS-NBMS

**Product :** Bluetooth Speaker

**Trade Name :** N/A

**Model Number :** WD-S01

WD-S02, WD-S03, WD-G01, WD-G02,  
WD-G03, WD-G04, WD-RK1, WD-RK2,

**Serial Model :** WD-RK3, WD-H01, WD-H02, WD-H03,  
WD-P01, WD-P02, WD-EL1, WD-EL2,  
WD-EL3

**Report No. :** BZT-140301003F

### Prepared for

Shenzhen UEMade Technology Co. Ltd.

3rd Floor, 3 Block, No. 3, West Zone, Shangxue Science Park, Bantian,  
Shenzhen, China

### Prepared by

BZT Testing Technology Co., Ltd.

1/F, Building E, Fenda Science Park, Sanwei Community, Xixiang Street  
Bao'an District, Shenzhen P.R. China

### TEST RESULT CERTIFICATION

**Applicant's name** ..... Shenzhen UEMade Technology Co. Ltd.  
Address..... 3rd Floor, 3 Block, No. 3, West Zone, Shangxue Science Park,  
Bantian, Shenzhen, China  
**Manufacture's Name** ..... Shenzhen UEMade Technology Co. Ltd.  
Address..... 3rd Floor, 3 Block, No. 3, West Zone, Shangxue Science Park,  
Bantian, Shenzhen, China

**Product description**

Product name ..... Bluetooth Speaker  
Model and/or type reference ..... WD-S01  
Serial Model : WD-S02, WD-S03, WD-G01, WD-G02, WD-G03, WD-G04,  
WD-RK1, WD-RK2, WD-RK3, WD-H01, WD-H02, WD-H03,  
WD-P01, WD-P02, WD-EL1, WD-EL2, WD-EL3  
Ratings DC 5V from PC AC 120V/60Hz or DC 3.7V from battery

**Standards** ..... FCC Part15.247

Test procedure ..... ANSI C63.4-2003

This device described above has been tested by BZT, and the test results show that the equipment under test (EUT) is in compliance with the FCC requirements. And it is applicable only to the tested sample identified in the report.

This report shall not be reproduced except in full, without the written approval of BZT, this document may be altered or revised by BZT, personal only, and shall be noted in the revision of the document.

**Date of Test**.....

Date (s) of performance of tests ..... 02 March. 2014 ~10 March. 2014  
Date of Issue..... 11 March. 2014

Test Result ..... **Pass**

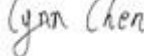
Testing Engineer :   
(Lynn Chen)

Technical Manager :   
(Carlen Liu)

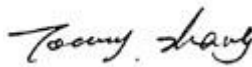
Authorized Signatory :   
(Tommy zhang)

**Table of Contents**

	<b>Page</b>
<b>1 . SUMMARY OF TEST RESULTS</b>	<b>5</b>
1.1 TEST FACILITY	6
1.2 MEASUREMENT UNCERTAINTY	6
<b>2 . GENERAL INFORMATION</b>	<b>7</b>
2.1 GENERAL DESCRIPTION OF EUT	7
2.2 DESCRIPTION OF TEST MODES	9
2.3 TABLE OF PARAMETERS OF TEXT SOFTWARE SETTING	9
2.4 BLOCK DIGRAM SHOWING THE CONFIGURATION OF SYSTEM TESTED	10
2.5 DESCRIPTION OF SUPPORT UNITS(CONDUCTED MODE)	11
2.6 EQUIPMENTS LIST FOR ALL TEST ITEMS	12
<b>3 . EMC EMISSION TEST</b>	<b>13</b>
3.1 CONDUCTED EMISSION MEASUREMENT	13
3.1.1 POWER LINE CONDUCTED EMISSION LIMITS	13
3.1.2 TEST PROCEDURE	14
3.1.3 DEVIATION FROM TEST STANDARD	14
3.1.4 TEST SETUP	14
3.1.5 EUT OPERATING CONDITIONS	14
3.1.6 TEST RESULTS	15
3.2 RADIATED EMISSION MEASUREMENT	17
3.2.1 RADIATED EMISSION LIMITS	17
3.2.2 TEST PROCEDURE	18
3.2.3 DEVIATION FROM TEST STANDARD	18
3.2.4 TEST SETUP	19
3.2.5 EUT OPERATING CONDITIONS	20
3.2.6 TEST RESULTS (BELOW 30 MHZ)	21
3.2.7 TEST RESULTS (BETWEEN 30M – 1000 MHZ)	22
3.2.8 TEST RESULTS (ABOVE 1000 MHZ)	24
3.2.9 TEST RESULTS (RESTRICTED BANDS REQUIREMENTS)	30
<b>4 . NUMBER OF HOPPING CHANNEL</b>	<b>46</b>
4.1 APPLIED PROCEDURES / LIMIT	46
4.1.1 TEST PROCEDURE	46
4.1.2 DEVIATION FROM STANDARD	46
4.1.3 TEST SETUP	46
4.1.4 EUT OPERATION CONDITIONS	46
4.1.5 TEST RESULTS	47

**Table of Contents**

	<b>Page</b>
<b>5 . AVERAGE TIME OF OCCUPANCY</b>	<b>50</b>
<b>5.1 APPLIED PROCEDURES / LIMIT</b>	<b>50</b>
5.1.1 TEST PROCEDURE	50
5.1.2 DEVIATION FROM STANDARD	50
5.1.3 TEST SETUP	50
5.1.4 EUT OPERATION CONDITIONS	50
5.1.5 TEST RESULTS	51
<b>6 . HOPPING CHANNEL SEPARATION MEASUREMENT</b>	<b>63</b>
<b>6.1 APPLIED PROCEDURES / LIMIT</b>	<b>63</b>
6.1.1 TEST PROCEDURE	63
6.1.2 DEVIATION FROM STANDARD	63
6.1.3 TEST SETUP	63
6.1.4 EUT OPERATION CONDITIONS	63
6.1.5 TEST RESULTS	64
<b>7 . BANDWIDTH TEST</b>	<b>69</b>
<b>7.1 APPLIED PROCEDURES / LIMIT</b>	<b>69</b>
7.1.1 TEST PROCEDURE	69
7.1.2 DEVIATION FROM STANDARD	69
7.1.3 TEST SETUP	69
7.1.4 EUT OPERATION CONDITIONS	69
7.1.5 TEST RESULTS	70
<b>8 . PEAK OUTPUT POWER TEST</b>	<b>74</b>
<b>8.1 APPLIED PROCEDURES / LIMIT</b>	<b>74</b>
8.1.1 TEST PROCEDURE	74
8.1.2 DEVIATION FROM STANDARD	74
8.1.3 TEST SETUP	74
8.1.4 EUT OPERATION CONDITIONS	74
8.1.5 TEST RESULTS	75
<b>9 . ANTENNA REQUIREMENT</b>	<b>76</b>
9.1 STANDARD REQUIREMENT	76
9.2 EUT ANTENNA	76
<b>10 . EUT TEST PHOTO</b>	<b>77</b>
<b>APPENDIX-PHOTOGRAPHS OF EUT CONSTRUCTIONAL DETAILS</b>	

## 1. SUMMARY OF TEST RESULTS

Test procedures according to the technical standards:

<b>FCC Part15 (15.247) , Subpart C</b>			
Standard Section	Test Item	Judgment	Remark
15.207	Conducted Emission	PASS	
15.247(a)(1)	Hopping Channel Separation	PASS	
15.247(b)(1)	Peak Output Power	PASS	
15.247(c)	Radiated Spurious Emission	PASS	
15.247(a)(iii)	Number of Hopping Frequency	PASS	
15.247(a)(iii)	Dwell Time	PASS	
15.247(a)(1)	Bandwidth	PASS	
15.205	Band Edge Emission	PASS	
15.203	Antenna Requirement	PASS	

**NOTE:**

(1) "N/A" denotes test is not applicable in this Test Report

## 1.1 TEST FACILITY

BZT Testing Technology Co., Ltd

Add. : 1/F, Building E, Fenda Science Park, Sanwei Community, Xixiang Street, Bao'an District, Shenzhen P.R. China.

FCC Registration No.: 701733

## 1.2 MEASUREMENT UNCERTAINTY

The reported uncertainty of measurement  $y \pm U$ , where expanded uncertainty  $U$  is based on a standard uncertainty multiplied by a coverage factor of  $k=2$ , providing a level of confidence of approximately **95 %**.

No.	Item	Uncertainty
1	Conducted Emission Test	$\pm 1.38\text{dB}$
2	RF power,conducted	$\pm 0.16\text{dB}$
3	Spurious emissions,conducted	$\pm 0.21\text{dB}$
4	All emissions,radiated(<1G)	$\pm 4.68\text{dB}$
5	All emissions,radiated(>1G)	$\pm 4.89\text{dB}$
6	Temperature	$\pm 0.5^\circ\text{C}$
7	Humidity	$\pm 2\%$

## 2. GENERAL INFORMATION

### 2.1 GENERAL DESCRIPTION OF EUT

Equipment	Bluetooth Speaker																
Trade Name	N/A																
Model Name	WD-S01																
Serial Model	WD-S02, WD-S03, WD-G01, WD-G02, WD-G03, WD-G04, WD-RK1, WD-RK2, WD-RK3, WD-H01, WD-H02, WD-H03, WD-P01, WD-P02, WD-EL1, WD-EL2, WD-EL3																
Model Difference	All model's the function, software and electric circuit are the same, only with a product color and model named different. Test model is WD-S01.																
Product Description	<p>The EUT is a Bluetooth Speaker</p> <table border="1"> <tr> <td>Operation Frequency:</td> <td>2402~2480 MHz</td> </tr> <tr> <td>Modulation Type:</td> <td>FHSS</td> </tr> <tr> <td>Bit Rate of Transmitter</td> <td>GFSK(1Mbps), <math>\pi/4</math> DQPSK(2Mbps), 8-DPSK(3Mbps)</td> </tr> <tr> <td>Number Of Channel</td> <td>79 CH</td> </tr> <tr> <td>Antenna Designation:</td> <td>Please see Note 3.</td> </tr> <tr> <td>Antenna Gain(Peak)</td> <td>0dBi</td> </tr> <tr> <td>Output Power(Conducted):</td> <td>2.65 dBm (Max.)</td> </tr> <tr> <td>EIRP:</td> <td>2.65 dBm(Max.)</td> </tr> </table> <p>Based on the application, features, or specification exhibited in User's Manual, the EUT is considered as an ITE/Computing Device. More details of EUT technical specification, please refer to the User's Manual.</p>	Operation Frequency:	2402~2480 MHz	Modulation Type:	FHSS	Bit Rate of Transmitter	GFSK(1Mbps), $\pi/4$ DQPSK(2Mbps), 8-DPSK(3Mbps)	Number Of Channel	79 CH	Antenna Designation:	Please see Note 3.	Antenna Gain(Peak)	0dBi	Output Power(Conducted):	2.65 dBm (Max.)	EIRP:	2.65 dBm(Max.)
Operation Frequency:	2402~2480 MHz																
Modulation Type:	FHSS																
Bit Rate of Transmitter	GFSK(1Mbps), $\pi/4$ DQPSK(2Mbps), 8-DPSK(3Mbps)																
Number Of Channel	79 CH																
Antenna Designation:	Please see Note 3.																
Antenna Gain(Peak)	0dBi																
Output Power(Conducted):	2.65 dBm (Max.)																
EIRP:	2.65 dBm(Max.)																
Channel List	Please refer to the Note 2.																
Adapter	N/A																
Battery	Rated Voltage: 3.7V Charge Limit: 4.2V capacity :400mah																
Connecting I/O Port(s)	Please refer to the User's Manual																

Note:

1. For a more detailed features description, please refer to the manufacturer's specifications or the User's Manual.

2.

Channel List					
Channel	Frequency (MHz)	Channel	Frequency (MHz)	Channel	Frequency (MHz)
00	2402	27	2429	54	2456
01	2403	28	2430	55	2457
02	2404	29	2431	56	2458
03	2405	30	2432	57	2459
04	2406	31	2433	58	2460
05	2407	32	2434	59	2461
06	2408	33	2435	60	2462
07	2409	34	2436	61	2463
08	2410	35	2437	62	2464
09	2411	36	2438	63	2465
10	2412	37	2439	64	2466
11	2413	38	2440	65	2467
12	2414	39	2441	66	2468
13	2415	40	2442	67	2469
14	2416	41	2443	68	2470
15	2417	42	2444	69	2471
16	2418	43	2445	70	2472
17	2419	44	2446	71	2473
18	2420	45	2447	72	2474
19	2421	46	2448	73	2475
20	2422	47	2449	74	2476
21	2423	48	2450	75	2477
22	2424	49	2451	76	2478
23	2425	50	2452	77	2479
24	2426	51	2453	78	2480
25	2427	52	2454		
26	2428	53	2455		

3.

Table for Filed Antenna

Ant	Brand	Model Name	Antenna Type	Connector	Gain (dBi)	NOTE
1	N/A	N/A	PCB Antenna	NA	0	BT Antenna

The EUT antenna is integral Antenna. no antenna other than that furnished by the responsible party shall be used with the device.



**2.2 DESCRIPTION OF TEST MODES**

To investigate the maximum EMI emission characteristics generates from EUT, the test system was pre-scanning tested base on the consideration of following EUT operation mode or test configuration mode which possible have effect on EMI emission level. Each of these EUT operation mode(s) or test configuration mode(s) mentioned above was evaluated respectively.

Pretest Mode	Description
Mode 1	CH00
Mode 2	CH39
Mode 3	CH78

For Conducted Emission	
Final Test Mode	Description
Mode4	Link mode

For Radiated Emission	
Final Test Mode	Description
Mode 1	CH00
Mode 2	CH39
Mode 3	CH78
Mode4	Link mode

Note:

- (1) The measurements are performed at the highest, middle, lowest available channels.

**2.3 TABLE OF PARAMETERS OF TEXT SOFTWARE SETTING**

During testing channel & power controlling software provided by the customer was used to control the operating channel as well as the output power level. The RF output power selection is for the setting of RF output power expected by the customer and is going to be fixed on the firmware of the final end product power parameters of FHSS

Test software Version	Test program: CSR		
Frequency	2402 MHz	2441 MHz	2480 MHz
Parameters(1Mbps)	DEF	DEF	DEF
Parameters(3Mbps)	DEF	DEF	DEF

## 2.4 BLOCK DIGRAM SHOWING THE CONFIGURATION OF SYSTEM TESTED

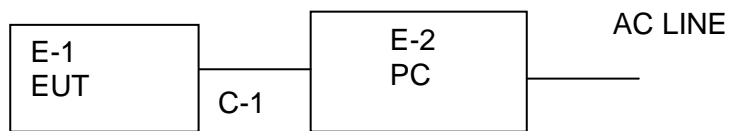

**2.5 DESCRIPTION OF SUPPORT UNITS(CONDUCTED MODE)**

The EUT has been tested as an independent unit together with other necessary accessories or support units. The following support units or accessories were used to form a representative test configuration during the tests.

Item	Equipment	Mfr/Brand	Model/Type No.	Series No.	Note
E-1	Bluetooth Speaker	N/A	WD-S01	N/A	EUT
E-2	PC	Dell	234	N/A	

Item	Shielded Type	Ferrite Core	Length	Note
C-1	No	No	0.4M	

**Note:**

- (1) The support equipment was authorized by Declaration of Confirmation.
- (2) For detachable type I/O cable should be specified the length in cm in 『Length』 column.
- (3) “YES” is means “shielded” “with core”; “NO” is means “unshielded” “without core”.

**2.6 EQUIPMENTS LIST FOR ALL TEST ITEMS**

Radiation Test equipment

Item	Kind of Equipment	Manufacturer	Type No.	Serial No.	Calibrated until
1	Spectrum Analyzer	Agilent	E4407B	160400005	Jul. 12. 2014
2	Test Receiver	R&S	ESPI	101318	Jul. 12. 2014
3	Bilog Antenna	TESEQ	CBL6111D	31216	Oct. 17. 2014
4	50Ω Coaxial Switch	Anritsu	MP59B	6200264416	Jul. 06. 2014
5	Spectrum Analyzer	ADVANTEST	R3132	150900201	Jul. 06. 2014
6	Horn Antenna	EM	EM-AH-10180	2011071402	Oct. 17. 2014
7	Horn Ant	Schwarzbeck	BBHA 9170	9170-181	Oct. 17. 2014
8	Amplifier	EM	EM-30180	060538	Jul. 12. 2014
9	Loop Antenna	ARA	PLA-1030/B	1029	Oct. 17. 2014
10	Power Meter	R&S	NRVS	100696	Jul. 06. 2014

Conduction Test equipment

Item	Kind of Equipment	Manufacturer	Type No.	Serial No.	Calibrated until
1	Test Receiver	R&S	ESCI	101160	Jul. 12. 2014
2	LISN	R&S	ENV216	101313	Jul. 06. 2014
3	LISN	EMCO	3816/2	00042990	Jul. 06. 2014
4	50Ω Coaxial Switch	Anritsu	MP59B	6200264417	Jul. 06. 2014
5	Passive Voltage Probe	R&S	ESH2-Z3	100196	Jul. 06. 2014
6	Absorbing clamp	R&S	MOS-21	100423	Jul. 06. 2014

### 3. EMC EMISSION TEST

#### 3.1 CONDUCTED EMISSION MEASUREMENT

##### 3.1.1 POWER LINE CONDUCTED EMISSION Limits (Frequency Range 150KHz-30MHz)

FREQUENCY (MHz)	Class A (dBuV)		Class B (dBuV)		Standard
	Quasi-peak	Average	Quasi-peak	Average	
0.15 -0.5	79.00	66.00	66 - 56 *	56 - 46 *	CISPR
0.50 -5.0	73.00	60.00	56.00	46.00	CISPR
5.0 -30.0	73.00	60.00	60.00	50.00	CISPR

0.15 -0.5	79.00	66.00	66 - 56 *	56 - 46 *	FCC
0.50 -5.0	73.00	60.00	56.00	46.00	FCC
5.0 -30.0	73.00	60.00	60.00	50.00	FCC

Note:

- (1) The tighter limit applies at the band edges.
- (2) The limit of " \* " marked band means the limitation decreases linearly with the logarithm of the frequency in the range.

The following table is the setting of the receiver

Receiver Parameters	Setting
Attenuation	10 dB
Start Frequency	0.15 MHz
Stop Frequency	30 MHz
IF Bandwidth	9 kHz

**3.1.2 TEST PROCEDURE**

- a. The EUT was placed 0.4 meters from the horizontal ground plane with EUT being connected to the power mains through a line impedance stabilization network (LISN). All other support equipments powered from additional LISN(s). The LISN provide 50 Ohm/ 50uH of coupling impedance for the measuring instrument.
- b. Interconnecting cables that hang closer than 40 cm to the ground plane shall be folded back and forth in the center forming a bundle 30 to 40 cm long.
- c. I/O cables that are not connected to a peripheral shall be bundled in the center. The end of the cable may be terminated, if required, using the correct terminating impedance. The overall length shall not exceed 1 m.
- d. LISN at least 80 cm from nearest part of EUT chassis.
- e. For the actual test configuration, please refer to the related Item –EUT Test Photos.

**3.1.3 DEVIATION FROM TEST STANDARD**

No deviation

**3.1.4 TEST SETUP**

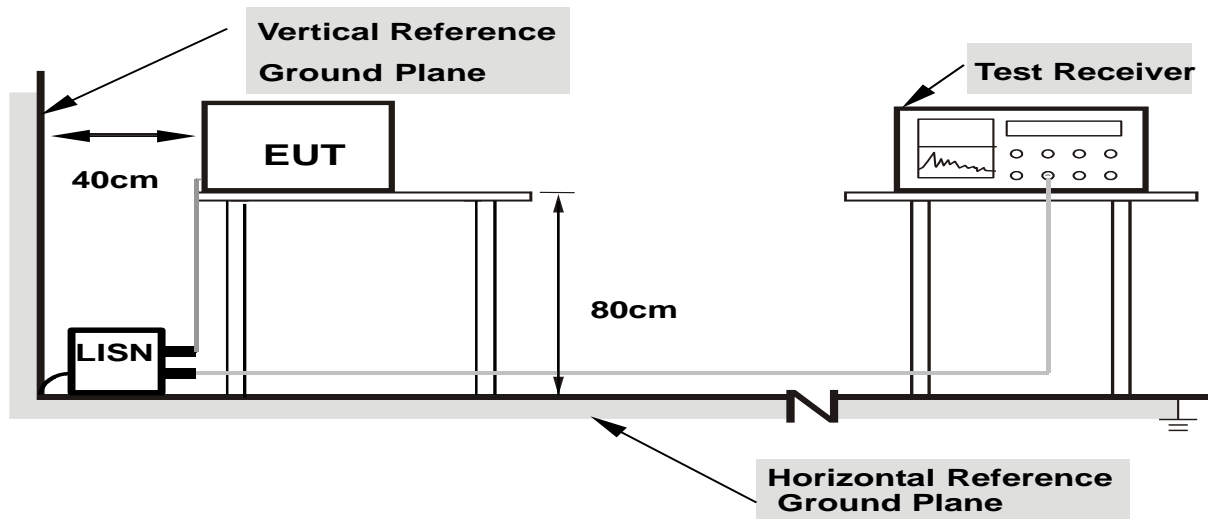

- Note:**
- 1.Support units were connected to second LISN.
  - 2.Both of LISNs (AMN) are 80 cm from EUT and at least 80 from other units and other metal planes

**3.1.5 EUT OPERATING CONDITIONS**

The EUT was configured for testing in a typical fashion (as a customer would normally use it). The EUT has been programmed to continuously transmit during test. This operating condition was tested and used to collect the included data.

### 3.1.6 TEST RESULTS

EUT :	Bluetooth Speaker	Model Name. :	WD-S01
Temperature :	26 °C	Relative Humidity :	54%
Pressure :	1010hPa	Phase :	L
Test Voltage :	DC 5V from PC AC 120V/60Hz	Test Mode :	Link mode

Frequency (MHz)	Meter Reading (dBμV)	Factor (dB)	Emission Level (dBμV/m)	Limits (dBμV/m)	Margin (dB)	Detector Type
0.174	36.55	11.1	47.65	64.76	-17.11	QP
0.174	21.91	11.1	33.01	54.76	-21.75	AVG
0.234	29.44	10.77	40.21	62.3	-22.09	QP
0.234	16.46	10.77	27.23	52.3	-25.07	AVG
0.29	22.93	10.93	33.86	60.52	-26.66	QP
0.29	11.74	10.93	22.67	50.52	-27.85	AVG
0.682	16.87	10.53	27.4	56	-28.6	QP
0.682	7.44	10.53	17.97	46	-28.03	AVG
4.6579	27.25	10.63	37.88	56	-18.12	QP
4.6579	20.49	10.63	31.12	46	-14.88	AVG
6.2299	21.27	10.7	31.97	60	-28.03	QP
6.2299	10.55	10.7	21.25	50	-28.75	AVG

Remark:

1. Factor = Antenna Factor + Cable Loss – Pre-amplifier.

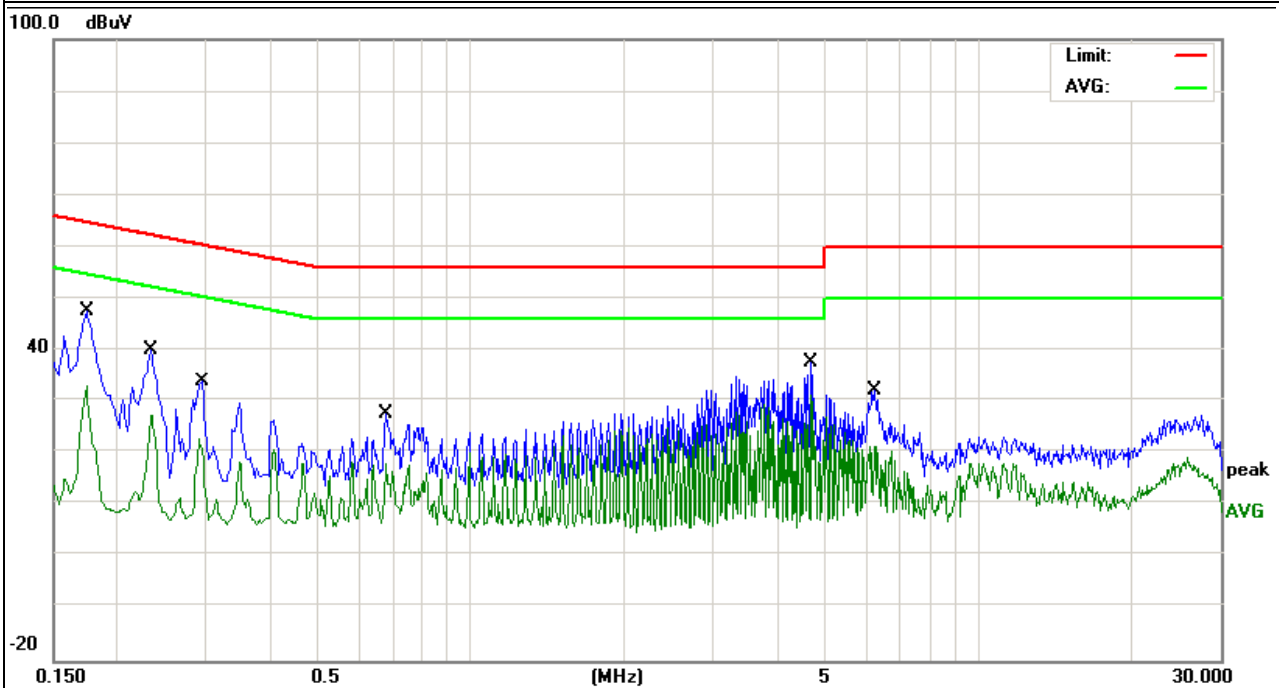

EUT :	Bluetooth Speaker	Model Name. :	WD-S01
Temperature :	26 °C	Relative Humidity :	54%
Pressure :	1010hPa	Phase :	N
Test Voltage :	DC 5V from PC AC 120V/60Hz	Test Mode :	Link mode

Frequency (MHz)	Meter Reading (dBμV)	Factor (dB)	Emission Level (dBμV/m)	Limits (dBμV/m)	Margin (dB)	Detector Type
0.174	35.69	11.37	47.06	64.76	-17.7	QP
0.174	22.07	11.37	33.44	54.76	-21.32	AVG
0.234	28.72	11.01	39.73	62.3	-22.57	QP
0.234	15.25	11.01	26.26	52.3	-26.04	AVG
0.29	21.8	10.89	32.69	60.52	-27.83	QP
0.29	11.27	10.89	22.16	50.52	-28.36	AVG
0.678	16.13	10.53	26.66	56	-29.34	QP
0.678	6.65	10.53	17.18	46	-28.82	AVG
3.726	24.41	10.58	34.99	56	-21.01	QP
3.726	20.65	10.58	31.23	46	-14.77	AVG
4.6579	26.2	10.62	36.82	56	-19.18	QP
4.6579	18.82	10.62	29.44	46	-16.56	AVG

Remark:

1. Factor = Antenna Factor + Cable Loss – Pre-amplifier.

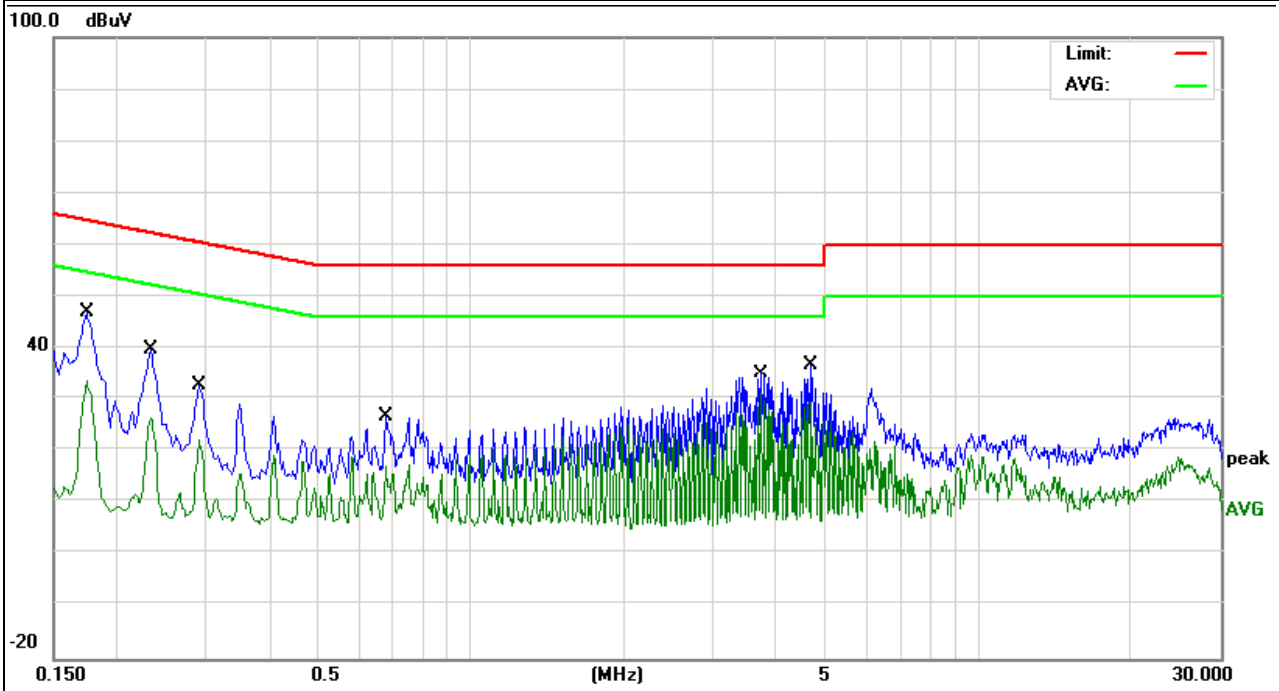



### 3.2 RADIATED EMISSION MEASUREMENT

#### 3.2.1 RADIATED EMISSION LIMITS (Frequency Range 9kHz-1000MHz)

20dBc in any 100 kHz bandwidth outside the operating frequency band. In case the emission fall within the restricted band specified on 15.205(a), then the 15.209(a) limit in the table below has to be followed.

Frequencies (MHz)	Field Strength (micorvolts/meter)	Measurement Distance (meters)
0.009~0.490	2400/F(KHz)	300
0.490~1.705	24000/F(KHz)	30
1.705~30.0	30	30
30~88	100	3
88~216	150	3
216~960	200	3
Above 960	500	3

#### LIMITS OF RADIATED EMISSION MEASUREMENT (Above 1000MHz)

FREQUENCY (MHz)	Class A (dBuV/m) (at 3M)		Class B (dBuV/m) (at 3M)	
	PEAK	AVERAGE	PEAK	AVERAGE
Above 1000	80	60	74	54

Notes:

- (1) The limit for radiated test was performed according to FCC PART 15C.
- (2) The tighter limit applies at the band edges.
- (3) Emission level (dBuV/m)=20log Emission level (uV/m).

#### FREQUENCY RANGE OF RADIATED MEASUREMENT (For unintentional radiators)

Highest frequency generated or Upper frequency of measurement used in the device or on which the device operates or tunes (MHz)	Range (MHz)
Below 1.705	30
1.705 – 108	1000
108 – 500	2000
500 – 1000	5000
Above 1000	5 <sup>th</sup> harmonic of the highest frequency or 40 GHz, whichever is lower

Spectrum Parameter	Setting
Attenuation	Auto
Start Frequency	1000 MHz
Stop Frequency	10th carrier harmonic
RB / VB (emission in restricted band)	1 MHz / 1 MHz for Peak, 1 MHz / 10Hz for Average

Receiver Parameter	Setting
Attenuation	Auto
Start ~ Stop Frequency	9kHz~150kHz / RB 200Hz for QP
Start ~ Stop Frequency	150kHz~30MHz / RB 9kHz for QP
Start ~ Stop Frequency	30MHz~1000MHz / RB 120kHz for QP

**3.2.2 TEST PROCEDURE**

- a. The measuring distance of at 3 m shall be used for measurements at frequency up to 1GHz. For frequencies above 1GHz, any suitable measuring distance may be used.
- b. The EUT was placed on the top of a rotating table 0.8 meters above the ground at a 3 meter open area test site. The table was rotated 360 degrees to determine the position of the highest radiation.
- c. The height of the equipment or of the substitution antenna shall be 0.8 m; the height of the test antenna shall vary between 1 m to 4 m. Both horizontal and vertical polarizations of the antenna are set to make the measurement.
- d. The initial step in collecting conducted emission data is a spectrum analyzer peak detector mode pre-scanning the measurement frequency range. Significant peaks are then marked and then Quasi Peak detector mode re-measured.
- e. If the Peak Mode measured value compliance with and lower than Quasi Peak Mode Limit, the EUT shall be deemed to meet QP Limits and then no additional QP Mode measurement performed.
- f. For the actual test configuration, please refer to the related Item –EUT Test Photos.

Note:

Both horizontal and vertical antenna polarities were tested and performed pretest to three orthogonal axis. The worst case emissions were reported

**3.2.3 DEVIATION FROM TEST STANDARD**

No deviation

### 3.2.4 TEST SETUP

(A) Radiated Emission Test-Up Frequency Below 30MHz

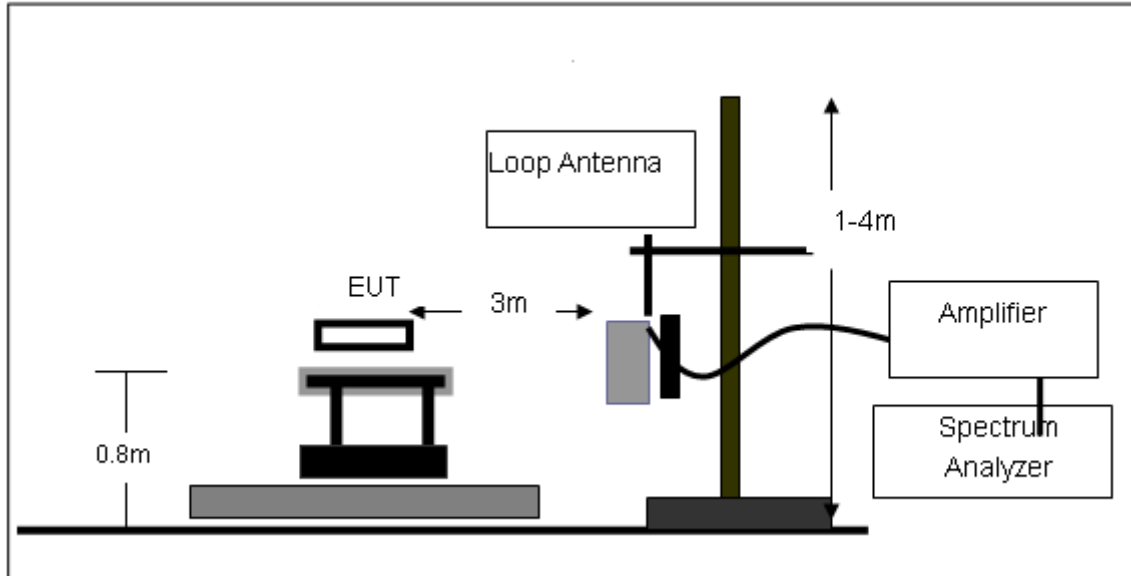

(B) Radiated Emission Test-Up Frequency 30MHz~1GHz

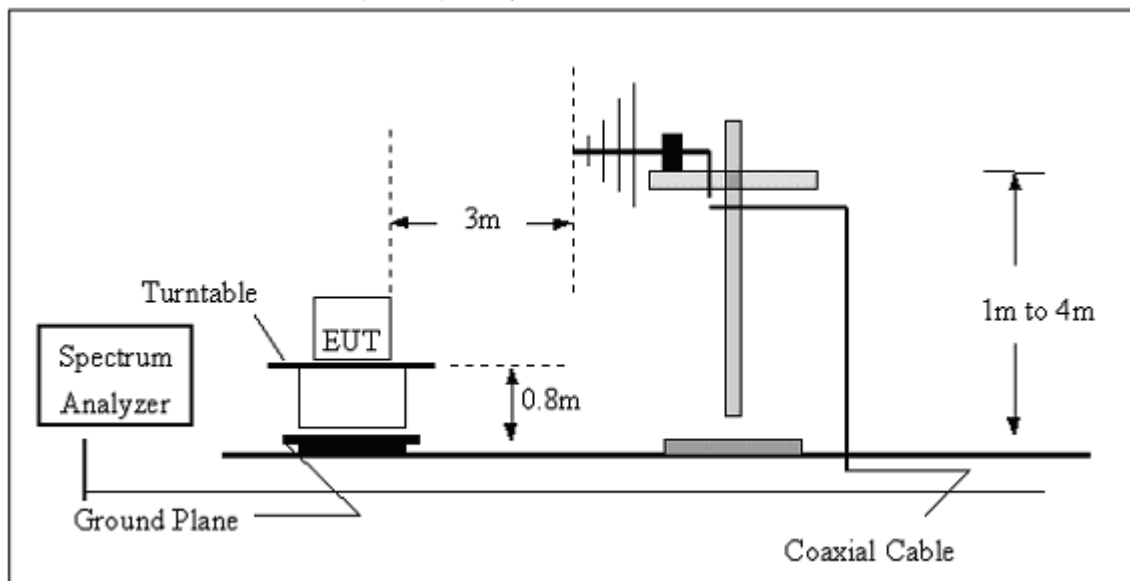

(C) Radiated Emission Test-Up Frequency Above 1GHz

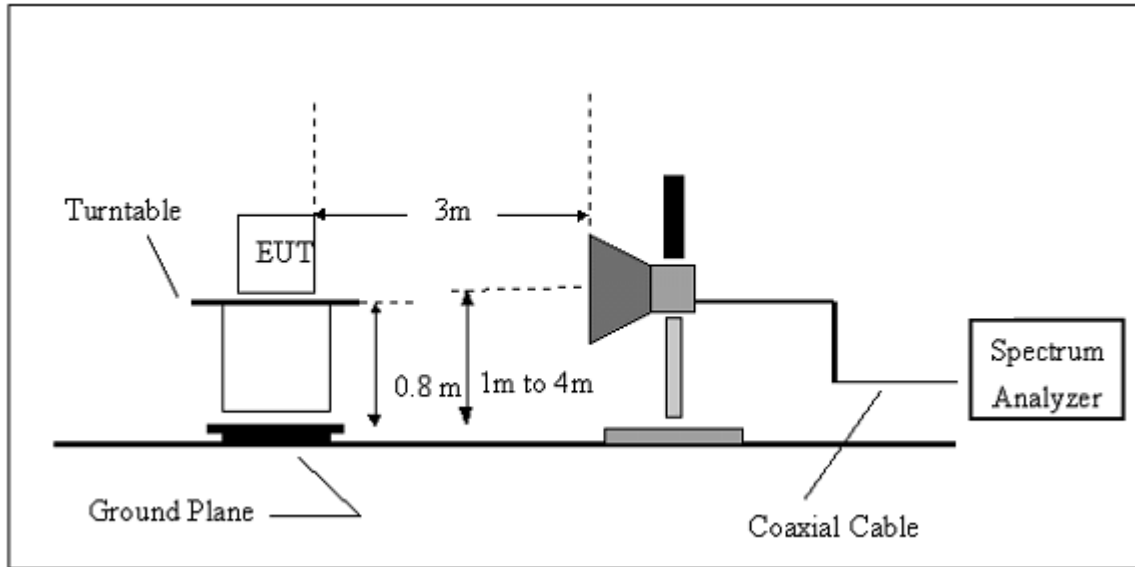

**3.2.5 EUT OPERATING CONDITIONS**

The EUT tested system was configured as the statements of 2.4 Unless otherwise a special operating condition is specified in the follows during the testing.

**3.2.6 TEST RESULTS (BELOW 30 MHZ)**

EUT :	Bluetooth Speaker	Model Name :	WD-S01
Temperature :	20 °C	Relative Humidity :	48%
Pressure :	1010 hPa	Polarization :	---
Test Voltage :	DC 5V from PC AC 120V/60Hz		
Test Mode :	Link mode		

Freq. (MHz)	Reading (dBuV/m)	Limit (dBuV/m)	Margin (dB)	State P/F
--	--	--	--	PASS
--	--	--	--	PASS

**NOTE:**

The amplitude of spurious emissions which are attenuated by more than 20dB below the permissible value has no need to be reported.

Distance extrapolation factor =  $40 \log (\text{specific distance}/\text{test distance})$ (dB);

Limit line = specific limits(dBuv) + distance extrapolation factor.

### 3.2.7 TEST RESULTS (BETWEEN 30M – 1000 MHZ)

EUT :	Bluetooth Speaker	Model Name :	WD-S01
Temperature :	20 °C	Relative Humidity :	48%
Pressure :	1010 hPa	Polarization :	Horizontal
Test Voltage :	DC 5V from PC AC 120V/60Hz		
Test Mode :	Link mode		

Frequency (MHz)	Meter Reading (dBμV)	Factor (dB)	Emission Level (dBμV/m)	Limits (dBμV/m)	Margin (dB)	Detector Type
125.0066	15.62	12.21	27.83	43.5	-15.67	QP
164.9071	15.69	10.81	26.5	43.5	-17.00	QP
287.9904	15.6	14.3	29.9	46	-16.10	QP
528.2458	15.56	21.12	36.68	46	-9.32	QP
721.7259	9.49	25.59	35.08	46	-10.92	QP
815.9678	11.96	26.46	38.42	46	-7.58	QP

Remark:

1. Factor = Antenna Factor + Cable Loss – Pre-amplifier.

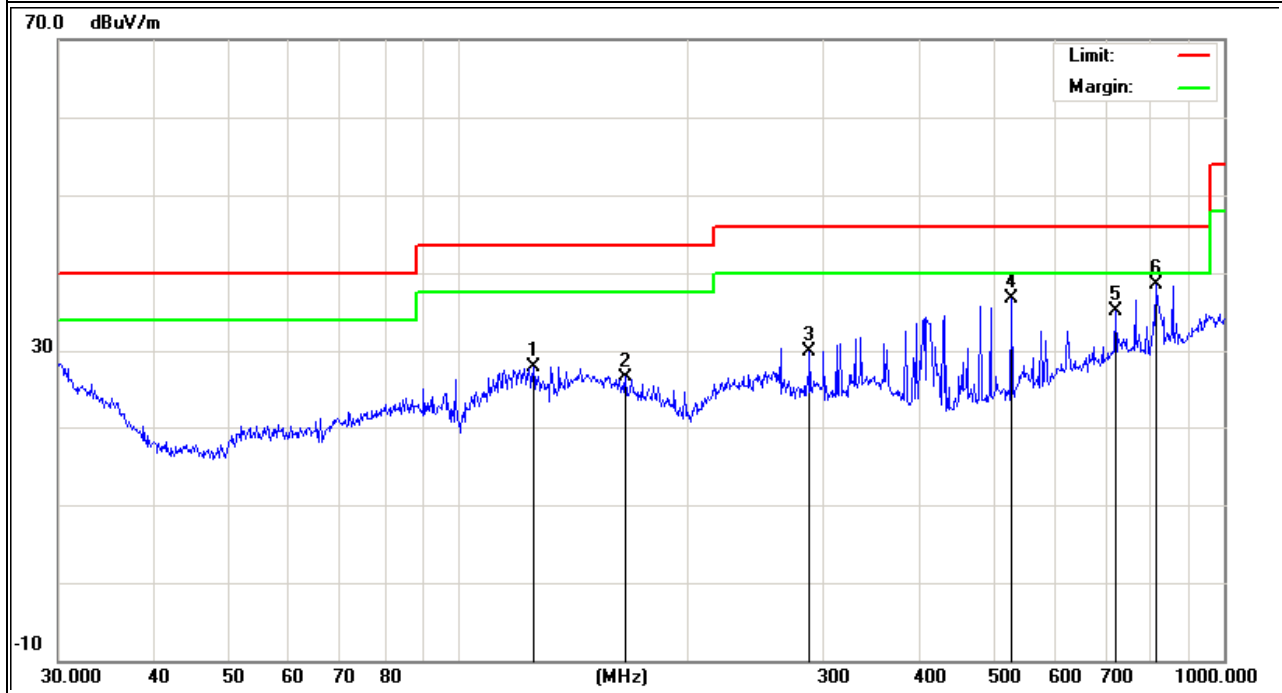

EUT :	Bluetooth Speaker	Model Name :	WD-S01
Temperature :	20 °C	Relative Humidity :	48%
Pressure :	1010 hPa	Polarization :	Vertical
Test Voltage :	DC 5V from PC AC 120V/60Hz		
Test Mode :	Link mode		

Frequency (MHz)	Meter Reading (dBµV)	Factor (dB)	Emission Level (dBµV/m)	Limits (dBµV/m)	Margin (dB)	Detector Type
135.0319	15.26	12.25	27.51	43.5	-15.99	QP
239.9874	13.69	11.65	25.34	46	-20.66	QP
406.088	15.21	18.54	33.75	46	-12.25	QP
495.9343	14.76	20.59	35.35	46	-10.65	QP
528.2458	15.19	21.12	36.31	46	-9.69	QP
815.9678	8.62	26.46	35.08	46	-10.92	QP

Remark:

1. Factor = Antenna Factor + Cable Loss – Pre-amplifier.

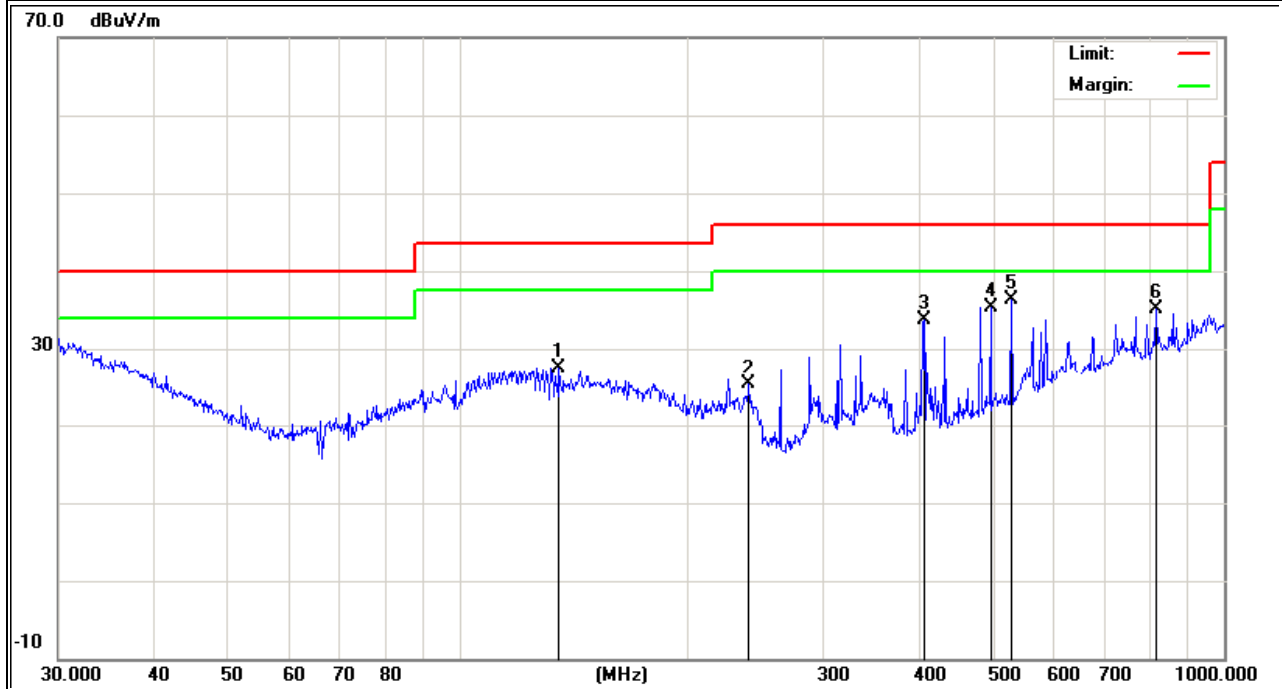

**3.2.8 TEST RESULTS (ABOVE 1000 MHZ)**

EUT :	Bluetooth Speaker	Model Name :	WD-S01
Temperature :	20 °C	Relative Humidity :	48%
Pressure :	1010 hPa	Test Voltage :	DC 5V from PC AC 120V/60Hz
Test Mode :	TX 2402MHz – CH 00(1Mbps)	Polarization :	Horizontal

Frequency (MHz)	Meter Reading (dBµV)	Factor (dB)	Emission Level (dBµV/m)	Limits (dBµV/m)	Margin (dB)	Detector Type
4804	53.79	-3.64	50.15	74	-23.85	peak
4804	43.38	-3.64	39.74	54	-14.26	AVG
7206	49.24	-0.95	48.29	74	-25.71	peak
7206	39.63	-0.95	38.68	54	-15.32	AVG
9608	48.46	2.15	50.61	74	-23.39	peak
9608	39.01	2.15	41.16	54	-12.84	AVG

Remark:  
Factor = Antenna Factor + Cable Loss – Pre-amplifier.

EUT :	Bluetooth Speaker	Model Name :	WD-S01
Temperature :	20 °C	Relative Humidity :	48%
Pressure :	1010 hPa	Test Voltage :	DC 5V from PC AC 120V/60Hz
Test Mode :	TX 2402MHz – CH 00(1Mbps)	Polarization :	Vertical

Frequency (MHz)	Meter Reading (dBµV)	Factor (dB)	Emission Level (dBµV/m)	Limits (dBµV/m)	Margin (dB)	Detector Type
4804	52.96	-3.64	49.32	74	-24.68	peak
4804	45.91	-3.64	42.27	54	-11.73	AVG
7206	51.03	-0.95	50.08	74	-23.92	peak
7206	41.90	-0.95	40.95	54	-13.05	AVG
9608	49.01	2.15	51.16	74	-22.84	peak
9608	39.29	2.15	41.44	54	-12.56	AVG

Remark:  
Factor = Antenna Factor + Cable Loss – Pre-amplifier.



EUT :	Bluetooth Speaker	Model Name :	WD-S01
Temperature :	20 °C	Relative Humidity :	48%
Pressure :	1010 hPa	Test Voltage :	DC 5V from PC AC 120V/60Hz
Test Mode :	TX 2441MHz – CH 39(1Mbps)	Polarization :	Horizontal

Frequency (MHz)	Meter Reading (dBμV)	Factor (dB)	Emission Level (dBμV/m)	Limits (dBμV/m)	Margin (dB)	Detector Type
4882	51.40	-3.68	47.72	74	-26.28	peak
4882	45.94	-3.68	42.26	54	-11.74	AVG
7323	52.23	-0.82	51.41	74	-22.59	peak
7323	41.67	-0.82	40.85	54	-13.15	AVG
9764	51.02	0.81	51.83	74	-22.17	peak
9764	40.55	0.81	41.36	54	-12.64	AVG

Remark:  
Factor = Antenna Factor + Cable Loss – Pre-amplifier.

EUT :	Bluetooth Speaker	Model Name :	WD-S01
Temperature :	20 °C	Relative Humidity :	48%
Pressure :	1010 hPa	Test Voltage :	DC 5V from PC AC 120V/60Hz
Test Mode :	TX 2441MHz – CH 39(1Mbps)	Polarization :	Vertical

Frequency (MHz)	Meter Reading (dBμV)	Factor (dB)	Emission Level (dBμV/m)	Limits (dBμV/m)	Margin (dB)	Detector Type
4882	52.36	-3.68	48.68	74	-25.32	peak
4882	45.20	-3.68	41.52	54	-12.48	AVG
7323	53.29	-0.82	52.47	74	-21.53	peak
7323	43.56	-0.82	42.74	54	-11.26	AVG
9764	48.90	0.81	49.71	74	-24.29	peak
9764	39.45	0.81	40.26	54	-13.74	AVG

Remark:  
Factor = Antenna Factor + Cable Loss – Pre-amplifier.

EUT :	Bluetooth Speaker	Model Name :	WD-S01
Temperature :	20 °C	Relative Humidity :	48%
Pressure :	1010 hPa	Test Voltage :	DC 5V from PC AC 120V/60Hz
Test Mode :	TX 2480MHz – CH 78(1Mbps)	Polarization :	Horizontal

Frequency (MHz)	Meter Reading (dBµV)	Factor (dB)	Emission Level (dBµV/m)	Limits (dBµV/m)	Margin (dB)	Detector Type
4960	52.27	-3.59	48.68	74	-25.32	peak
4960	42.63	-3.59	39.04	54	-14.96	AVG
7440	50.82	-0.69	50.13	74	-23.87	peak
7440	43.23	-0.69	42.54	54	-11.46	AVG
9920	48.54	1.14	49.68	74	-24.32	peak
9920	39.35	1.14	40.49	54	-13.51	AVG

Remark:  
Factor = Antenna Factor + Cable Loss – Pre-amplifier.

EUT :	Bluetooth Speaker	Model Name :	WD-S01
Temperature :	20 °C	Relative Humidity :	48%
Pressure :	1010 hPa	Test Voltage :	DC 5V from PC AC 120V/60Hz
Test Mode :	TX 2480MHz – CH 78(1Mbps)	Polarization :	Vertical

Frequency (MHz)	Meter Reading (dBµV)	Factor (dB)	Emission Level (dBµV/m)	Limits (dBµV/m)	Margin (dB)	Detector Type
4960	52.77	-3.59	49.18	74	-24.82	peak
4960	44.61	-3.59	41.02	54	-12.98	AVG
7440	51.05	-0.69	50.36	74	-23.64	peak
7440	42.96	-0.69	42.27	54	-11.73	AVG
9920	50.29	1.14	51.43	74	-22.57	peak
9920	40.43	1.14	41.57	54	-12.43`	AVG

Remark:  
Factor = Antenna Factor + Cable Loss – Pre-amplifier.

EUT :	Bluetooth Speaker	Model Name :	WD-S01
Temperature :	20 °C	Relative Humidity :	48%
Pressure :	1010 hPa	Test Voltage :	DC 5V from PC AC 120V/60Hz
Test Mode :	TX 2402MHz – CH 00(3 Mbps)	Polarization :	Horizontal

Frequency (MHz)	Meter Reading (dBμV)	Factor (dB)	Emission Level (dBμV/m)	Limits (dBμV/m)	Margin (dB)	Detector Type
4804	60.64	-3.64	57.00	74	-26.09	peak
4804	44.39	-3.64	40.75	54	-13.25	AVG
7206	53.21	-0.95	52.26	74	-21.74	peak
7206	42.12	-0.95	41.17	54	-12.83	AVG
9608	48.88	2.15	51.03	74	-22.97	peak
9608	40.31	2.15	42.46	54	-11.54	AVG

Remark:  
Factor = Antenna Factor + Cable Loss – Pre-amplifier.

EUT :	Bluetooth Speaker	Model Name :	WD-S01
Temperature :	20 °C	Relative Humidity :	48%
Pressure :	1010 hPa	Test Voltage :	DC 5V from PC AC 120V/60Hz
Test Mode :	TX 2402MHz – CH 00(3 Mbps)	Polarization :	Vertical

Frequency (MHz)	Meter Reading (dBμV)	Factor (dB)	Emission Level (dBμV/m)	Limits (dBμV/m)	Margin (dB)	Detector Type
4804	54.12	-3.64	50.48	74	-23.52	peak
4804	46.25	-3.64	42.61	54	-11.39	AVG
7206	50.89	-0.95	49.94	74	-24.06	peak
7206	41.20	-0.95	40.25	54	-13.75	AVG
9608	49.22	2.15	51.37	74	-22.63	peak
9608	39.14	2.15	41.29	54	-12.71	AVG

Remark:  
Factor = Antenna Factor + Cable Loss – Pre-amplifier.

EUT :	Bluetooth Speaker	Model Name :	WD-S01
Temperature :	20 °C	Relative Humidity :	48%
Pressure :	1010 hPa	Test Voltage :	DC 5V from PC AC 120V/60Hz
Test Mode :	TX 2441MHz – CH 39(3 Mbps)	Polarization :	Horizontal

Frequency (MHz)	Meter Reading (dBμV)	Factor (dB)	Emission Level (dBμV/m)	Limits (dBμV/m)	Margin (dB)	Detector Type
4882	54.30	-3.68	50.62	74	-23.38	peak
4882	45.93	-3.68	42.25	54	-11.75	AVG
7323	52.23	-0.82	51.41	74	-22.59	peak
7323	41.19	-0.82	40.37	54	-13.63	AVG
9764	49.48	0.81	50.29	74	-23.71	peak
9764	40.61	0.81	41.42	54	-12.58	AVG

Remark:

Factor = Antenna Factor + Cable Loss – Pre-amplifier.

EUT :	Bluetooth Speaker	Model Name :	WD-S01
Temperature :	20 °C	Relative Humidity :	48%
Pressure :	1010 hPa	Test Voltage :	DC 5V from PC AC 120V/60Hz
Test Mode :	TX 2441MHz – CH 39(3 Mbps)	Polarization :	Vertical

Frequency (MHz)	Meter Reading (dBμV)	Factor (dB)	Emission Level (dBμV/m)	Limits (dBμV/m)	Margin (dB)	Detector Type
4882	54.64	-3.68	50.96	74	-23.04	peak
4882	45.00	-3.68	41.32	54	-12.68	AVG
7323	52.09	-0.82	51.27	74	-22.73	peak
7323	43.33	-0.82	42.51	54	-11.49	AVG
9764	49.67	0.81	50.48	74	-23.52	peak
9764	40.37	0.81	41.18	54	-12.82	AVG

Remark:

Factor = Antenna Factor + Cable Loss – Pre-amplifier.

EUT :	Bluetooth Speaker	Model Name :	WD-S01
Temperature :	20 °C	Relative Humidity :	48%
Pressure :	1010 hPa	Test Voltage :	DC 5V from PC AC 120V/60Hz
Test Mode :	TX 2480MHz – CH 78(3Mbps)	Polarization :	Horizontal

Frequency (MHz)	Meter Reading (dBµV)	Factor (dB)	Emission Level (dBµV/m)	Limits (dBµV/m)	Margin (dB)	Detector Type
4960	52.84	-3.59	49.25	74	-24.75	peak
4960	44.11	-3.59	40.52	54	-13.48	AVG
7440	52.52	-0.69	51.83	74	-22.17	peak
7440	41.15	-0.69	40.46	54	-13.54	AVG
9920	49.77	1.14	50.91	74	-23.09	peak
9920	39.61	1.14	40.75	54	-13.25	AVG

Remark:  
Factor = Antenna Factor + Cable Loss – Pre-amplifier.

EUT :	Bluetooth Speaker	Model Name :	WD-S01
Temperature :	20 °C	Relative Humidity :	48%
Pressure :	1010 hPa	Test Voltage :	DC 5V from PC AC 120V/60Hz
Test Mode :	TX 2480MHz – CH 78(3Mbps)	Polarization :	Vertical

Frequency (MHz)	Meter Reading (dBµV)	Factor (dB)	Emission Level (dBµV/m)	Limits (dBµV/m)	Margin (dB)	Detector Type
4960	54.34	-3.59	50.75	74	-23.25	peak
4960	43.75	-3.59	40.16	54	-13.84	AVG
7440	52.73	-0.69	52.04	74	-21.96	peak
7440	41.80	-0.69	41.11	54	-12.89	AVG
9920	50.69	1.14	51.83	74	-22.17	peak
9920	40.84	1.14	41.98	54	-12.02	AVG

Remark:  
Factor = Antenna Factor + Cable Loss – Pre-amplifier.

### 3.2.9 TEST RESULTS (RESTRICTED BANDS REQUIREMENTS)

EUT :	Bluetooth Speaker	Model Name :	WD-S01
Temperature :	25 °C	Relative Humidity :	60%
Pressure :	1012 hPa	Polarization :	Horizontal
Test Voltage :	DC 5V from PC AC 120V/60Hz		
Test Mode :	CH00 for GFSK		

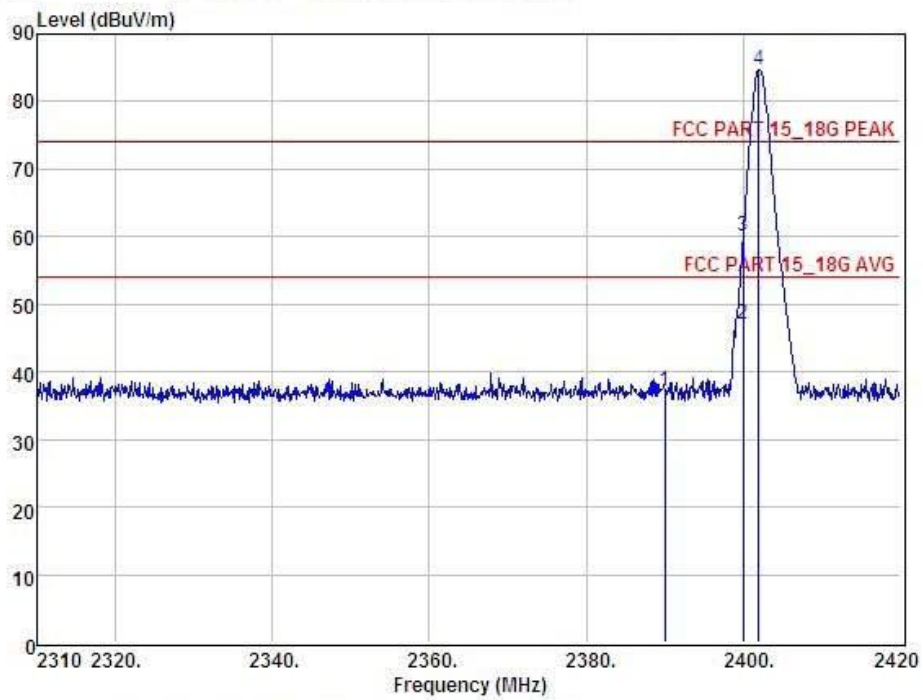

Condition : FCC PART 15\_18G PEAK 3m POL: HORIZONTAL

Item	Freq MHz	Read Level dBuV	Antenna Factor dB	Preamp Factor dB	Cable Loss dB	Level dBuV	Limit dBuV	Margin dBuV	Remark
1	2390.00	40.57	27.62	34.97	3.92	37.14	74.00	-36.86	Peak
2	2400.00	50.46	27.62	34.97	3.94	47.05	54.00	-6.95	Average
3	2400.00	63.49	27.62	34.97	3.94	60.08	74.00	-13.92	Peak
4	2402.00	88.03	27.62	34.97	3.94	84.62	74.00	10.62	Peak

Remark: Level = Read Level + Antenna Factor - Preamp Factor + Cable Loss

EUT :	Bluetooth Speaker	Model Name :	WD-S01
Temperature :	25 °C	Relative Humidity :	60%
Pressure :	1012 hPa	Polarization :	Vertical
Test Voltage :	DC 5V from PC AC 120V/60Hz		
Test Mode :	CH00 for GFSK		

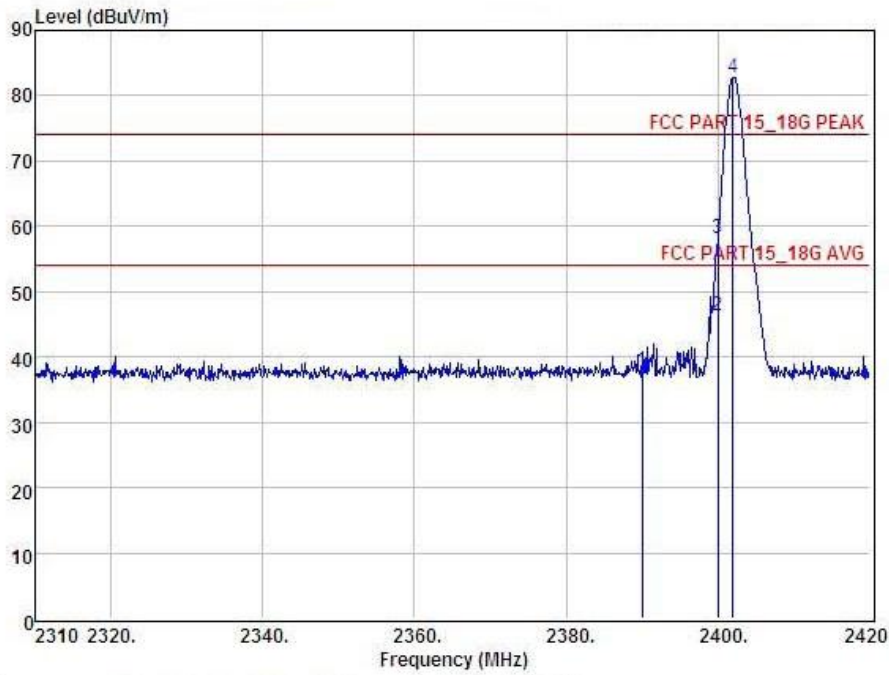

Condition : FCC PART 15\_18G PEAK 3m POL: VERTICAL

Item	Freq MHz	Read Level dBuV	Antenna Factor dB	Preamp Factor dB	Cable Loss dB	Level dBuV	Limit dBuV	Margin dBuV	Remark
1	2390.00	41.28	27.62	34.97	3.92	37.85	74.00	-36.15	Peak
2	2400.00	49.65	27.62	34.97	3.94	46.24	54.00	-7.76	Average
3	2400.00	61.68	27.62	34.97	3.94	58.27	74.00	-15.73	Peak
4	2402.00	86.16	27.62	34.97	3.94	82.75	74.00	8.75	Peak

Remark: Level = Read Level + Antenna Factor - Preamp Factor + Cable Loss

EUT :	Bluetooth Speaker	Model Name :	WD-S01
Temperature :	25 °C	Relative Humidity :	60%
Pressure :	1012 hPa	Polarization :	Horizontal
Test Voltage :	DC 5V from PC AC 120V/60Hz		
Test Mode :	CH78 for GFSK		

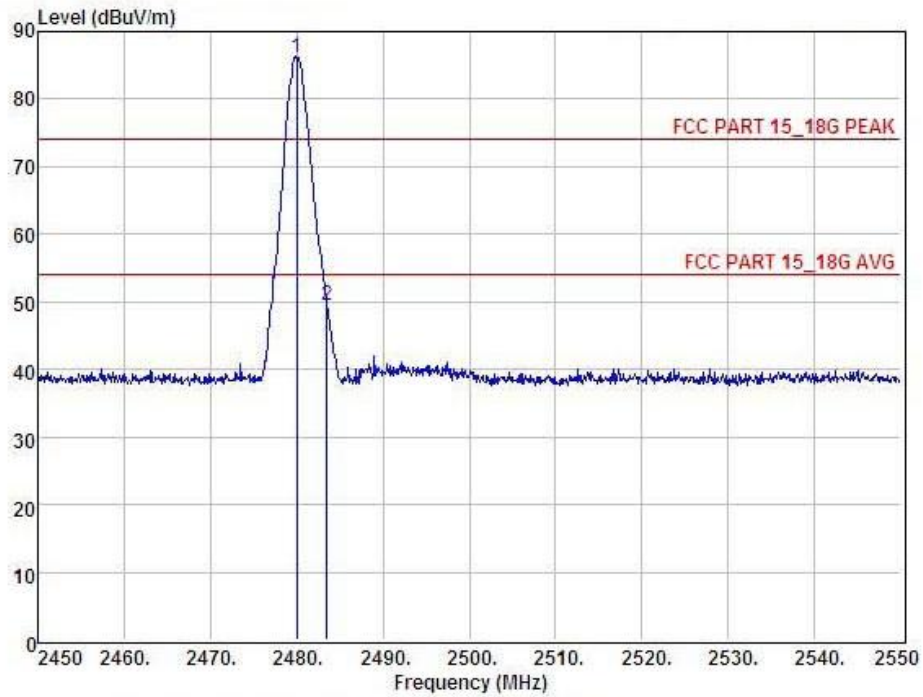

Condition : FCC PART 15_18G PEAK 3m POL: HORIZONTAL									
Item	Freq	Read Level	Antenna Factor	Preamp Factor	Cable Loss	Level	Limit	Margin	Remark
	MHz	dBuV	dB	dB	dB	dBuV	dBuV	dBuV	
1	2480.00	89.51	27.59	34.97	4.00	86.13	74.00	12.13	Peak
2	2483.50	52.91	27.59	34.97	4.00	49.53	74.00	-24.47	Peak

Remark: Level = Read Level + Antenna Factor - Preamp Factor + Cable Loss



EUT :	Bluetooth Speaker	Model Name :	WD-S01
Temperature :	25 °C	Relative Humidity :	60%
Pressure :	1012 hPa	Polarization :	Vertical
Test Voltage :	DC 5V from PC AC 120V/60Hz		
Test Mode :	CH78 for GFSK		

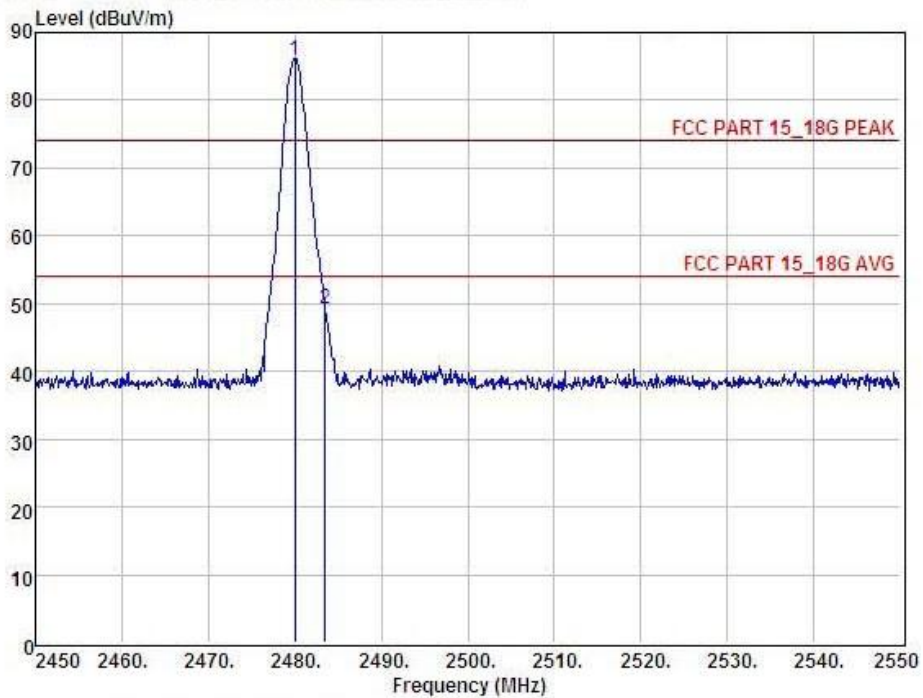

Condition : FCC PART 15\_18G PEAK 3m POL: VERTICAL

Item	Freq MHz	Read Level dBuV	Antenna Factor dB	Preamp Factor dB	Cable Loss dB	Level dBuV	Limit dBuV	Margin dBuV	Remark
1	2480.00	89.30	27.59	34.97	4.00	85.92	74.00	11.92	Peak
2	2483.50	52.63	27.59	34.97	4.00	49.25	74.00	-24.75	Peak

Remark: Level = Read Level + Antenna Factor - Preamp Factor + Cable Loss

EUT :	Bluetooth Speaker	Model Name :	WD-S01
Temperature :	25 °C	Relative Humidity :	60%
Pressure :	1012 hPa	Polarization :	Horizontal
Test Voltage :	DC 5V from PC AC 120V/60Hz		
Test Mode :	Hopping for GFSK		

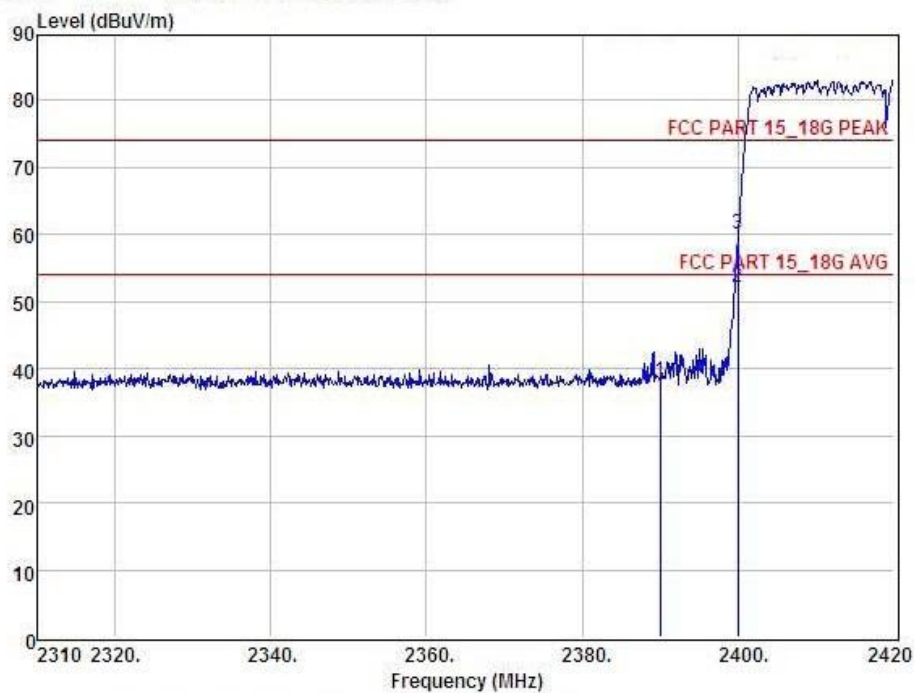

Condition : FCC PART 15_18G PEAK 3m POL: HORIZONTAL									
Item	Freq	Read	Antenna	Preamp	Cable	Level	Limit	Margin	Remark
	MHz	Level	Factor	Factor	Loss	dBuV	dBuV	dBuV	
		dBuV	dB	dB	dB				
1	2390.00	41.50	27.62	34.97	3.92	38.07	74.00	-35.93	Peak
2	2400.00	55.57	27.62	34.97	3.94	52.16	54.00	-1.84	Average
3	2400.00	63.59	27.62	34.97	3.94	60.18	74.00	-13.82	Peak

Remark: Level = Read Level + Antenna Factor - Preamp Factor + Cable Loss

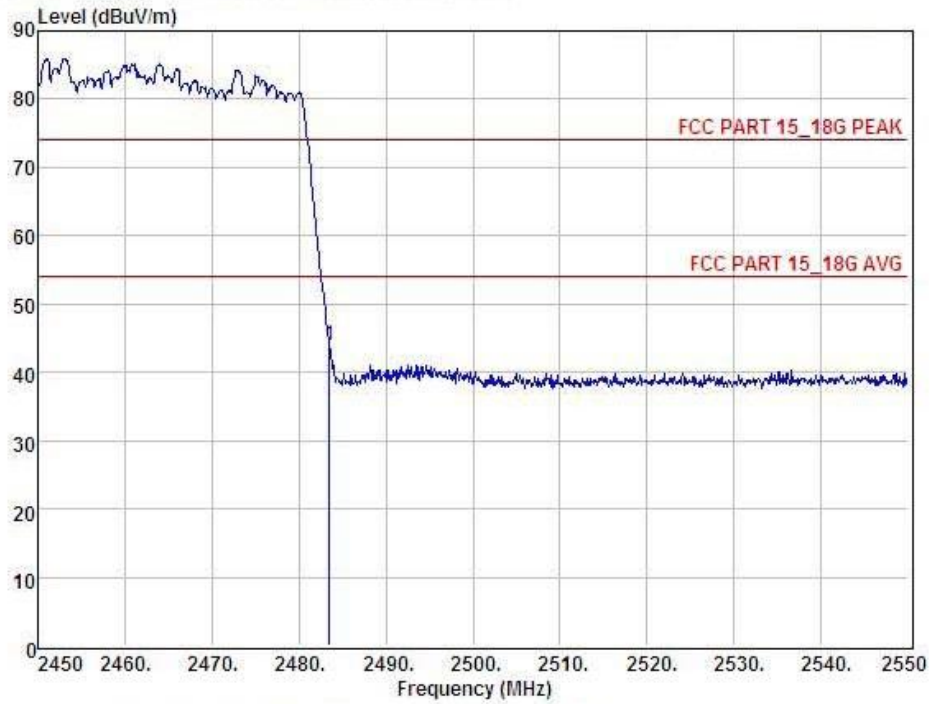

Condition : FCC PART 15\_18G PEAK 3m POL: HORIZONTAL

Item	Freq MHz	Read Level dBuV	Antenna Factor dB	Preamp Factor dB	Cable Loss dB	Level dBuV	Limit dBuV	Margin dBuV	Remark
1	2483.50	47.26	27.59	34.97	4.00	43.88	74.00	-30.12	Peak

Remark: Level = Read Level + Antenna Factor - Preamp Factor + Cable Loss

EUT :	Bluetooth Speaker	Model Name :	WD-S01
Temperature :	25 °C	Relative Humidity :	60%
Pressure :	1012 hPa	Polarization :	Vertical
Test Voltage :	DC 5V from PC AC 120V/60Hz		
Test Mode :	Hopping for GFSK		

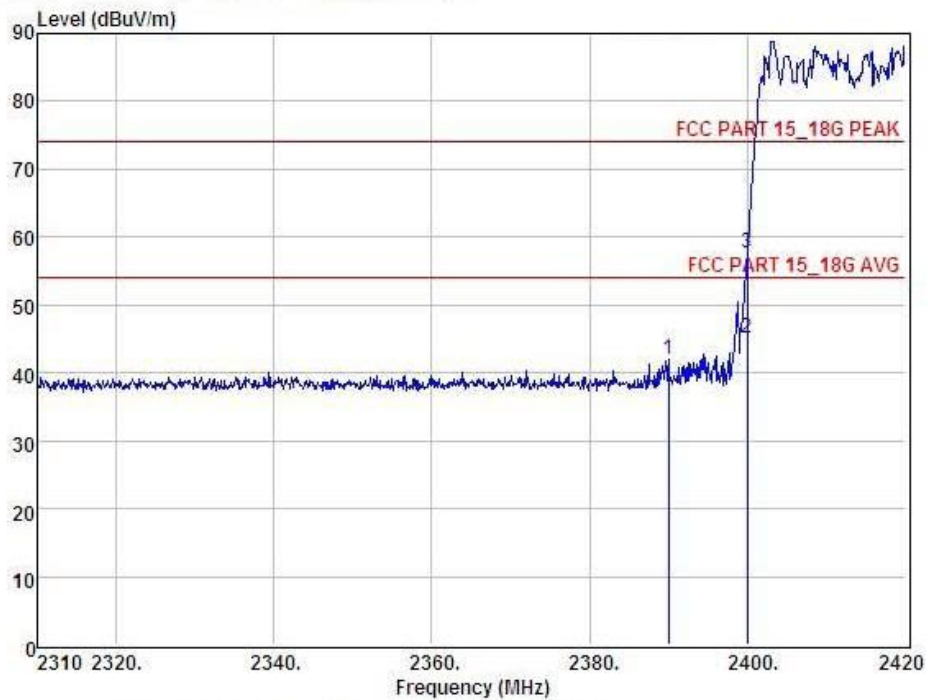

Condition : FCC PART 15\_18G PEAK 3m POL: VERTICAL

Item	Freq MHz	Read Level dBuV	Antenna Factor dB	Preamp Factor dB	Cable Loss dB	Level dBuV	Limit dBuV	Margin dBuV	Remark
1	2390.00	45.36	27.62	34.97	3.92	41.93	74.00	-32.07	Peak
2	2400.00	48.62	27.62	34.97	3.94	45.21	54.00	-8.79	Average
3	2400.00	60.98	27.62	34.97	3.94	57.57	74.00	-16.43	Peak

Remark: Level = Read Level + Antenna Factor - Preamp Factor + Cable Loss

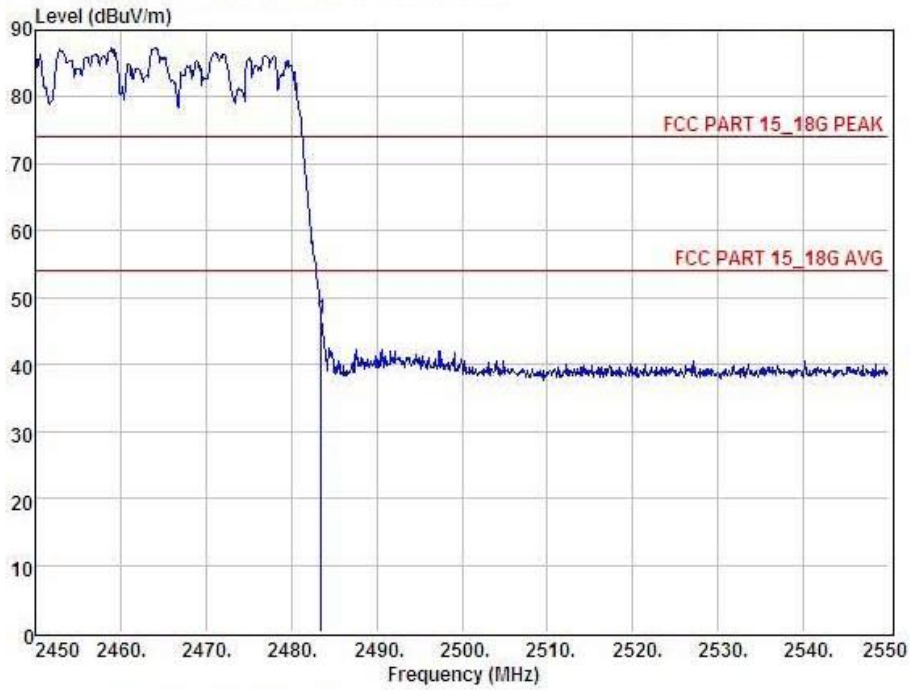

Condition : FCC PART 15_18G PEAK 3m POL: VERTICAL									
Item	Freq	Read	Antenna	Preamp	Cable	Level	Limit	Margin	Remark
	MHz	Level	Factor	Factor	Loss	dBuV	dBuV	dBuV	
		dBuV	dB	dB	dB				
1	2483.50	50.10	27.59	34.97	4.00	46.72	74.00	-27.28	Peak

Remark: Level = Read Level + Antenna Factor - Preamp Factor + Cable Loss

EUT :	Bluetooth Speaker	Model Name :	WD-S01
Temperature :	25 °C	Relative Humidity :	60%
Pressure :	1012 hPa	Polarization :	Horizontal
Test Voltage :	DC 5V from PC AC 120V/60Hz		
Test Mode :	CH00 for 8-DPSK		

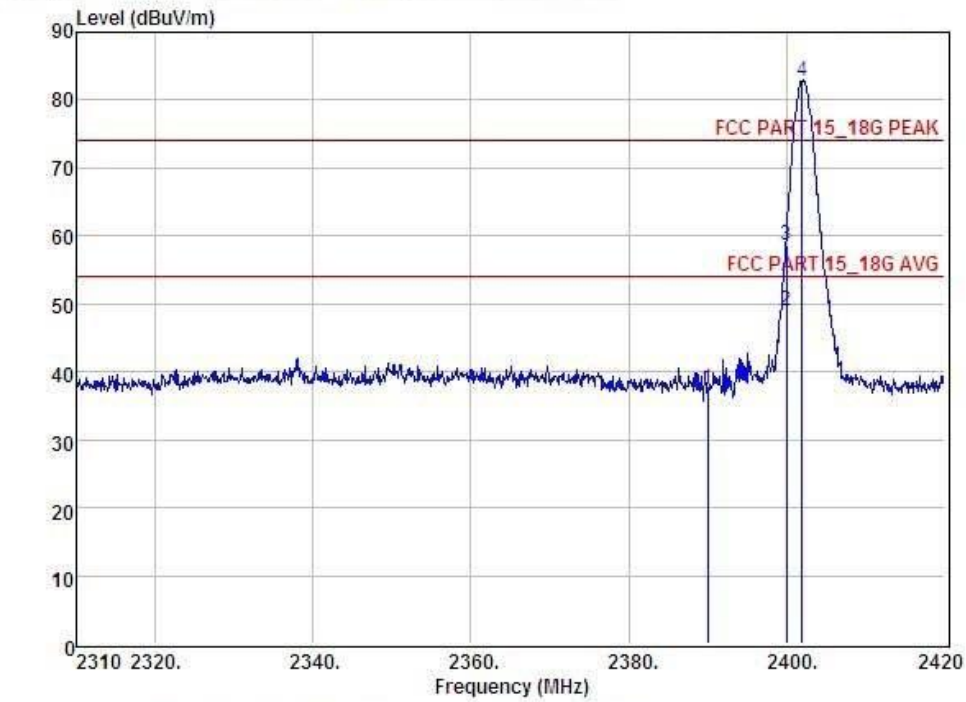

Condition : FCC PART 15\_18G PEAK 3m POL: HORIZONTAL

Item	Freq MHz	Read Level dBuV	Antenna Factor dB	Preamp Factor dB	Cable Loss dB	Level dBuV	Limit dBuV	Margin dBuV	Remark
1	2390.00	40.86	27.62	34.97	3.92	37.43	74.00	-36.57	Peak
2	2400.00	52.38	27.62	34.97	3.94	48.97	54.00	-5.03	Average
3	2400.00	62.06	27.62	34.97	3.94	58.65	74.00	-15.35	Peak
4	2402.00	86.25	27.62	34.97	3.94	82.84	74.00	8.84	Peak

Remark: Level = Read Level + Antenna Factor - Preamp Factor + Cable Loss

EUT :	Bluetooth Speaker	Model Name :	WD-S01
Temperature :	25 °C	Relative Humidity :	60%
Pressure :	1012 hPa	Polarization :	Vertical
Test Voltage :	DC 5V from PC AC 120V/60Hz		
Test Mode :	CH00 for 8-DPSK		

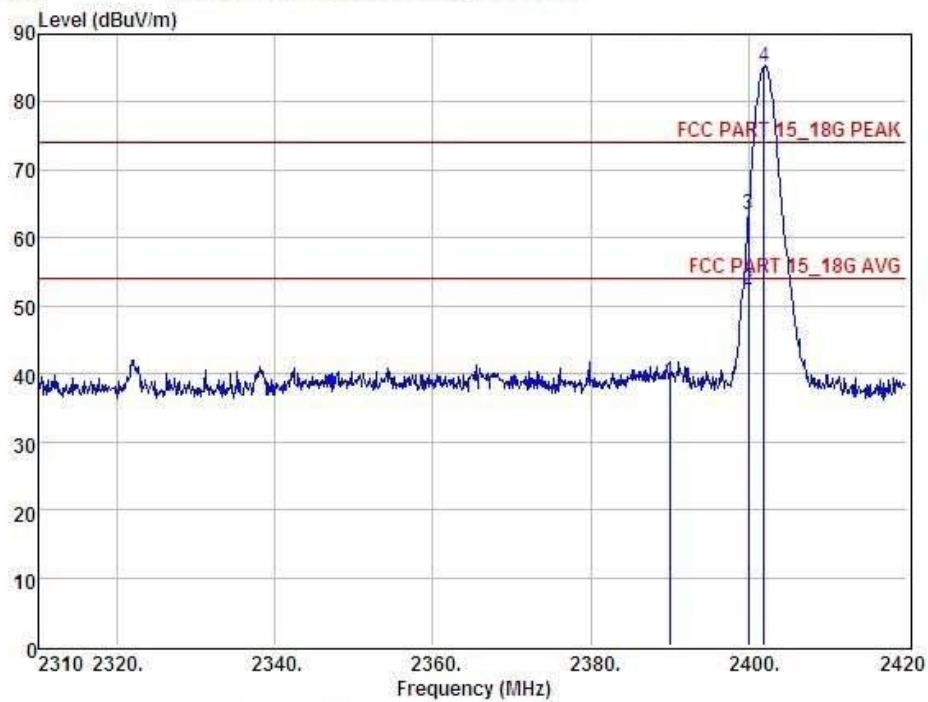

Condition : FCC PART 15\_18G PEAK 3m POL: VERTICAL

Item	Freq MHz	Read Level dBuV	Antenna Factor dB	Preamp Factor dB	Cable Loss dB	Level dBuV	Limit dBuV	Margin dBuV	Remark
1	2390.00	42.40	27.62	34.97	3.92	38.97	74.00	-35.03	Peak
2	2400.00	55.73	27.62	34.97	3.94	52.32	54.00	-1.68	Average
3	2400.00	66.98	27.62	34.97	3.94	63.57	74.00	-10.43	Peak
4	2402.00	68.70	27.62	34.97	3.94	65.29	74.00	11.29	Peak

Remark: Level = Read Level + Antenna Factor - Preamp Factor + Cable Loss



EUT :	Bluetooth Speaker	Model Name :	WD-S01
Temperature :	25 °C	Relative Humidity :	60%
Pressure :	1012 hPa	Polarization :	Horizontal
Test Voltage :	DC 5V from PC AC 120V/60Hz		
Test Mode :	CH78 for 8-DPSK		

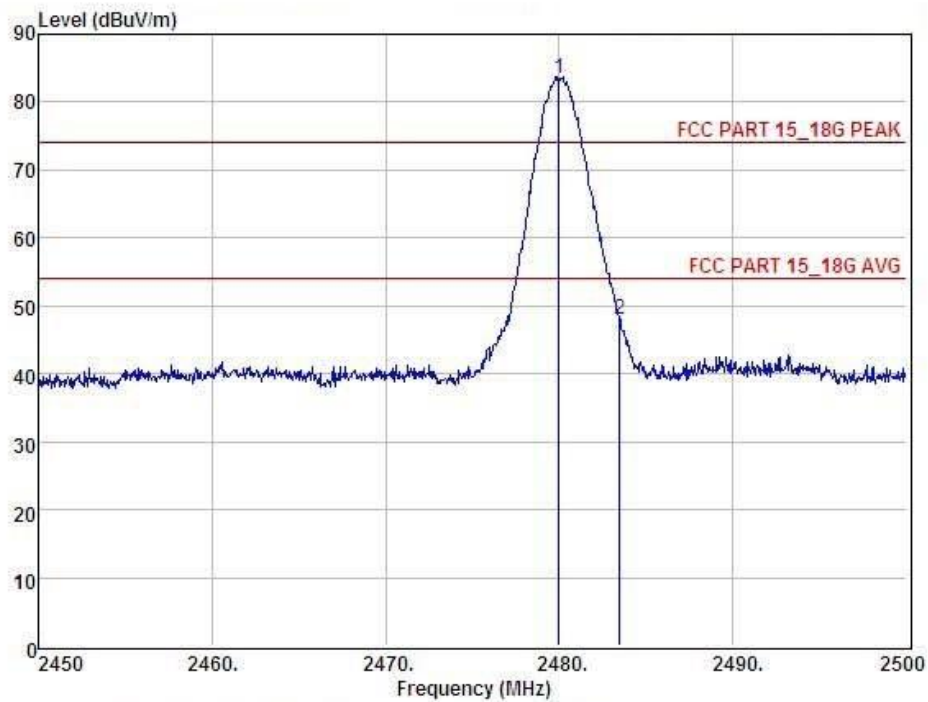

Condition : FCC PART 15\_18G PEAK 3m POL: HORIZONTAL

Item	Freq MHz	Read Level dBuV	Antenna Factor dB	Preamp Factor dB	Cable Loss dB	Level dBuV	Limit dBuV	Margin dBuV	Remark
1	2480.00	86.91	27.59	34.97	4.00	83.53	74.00	9.53	Peak
2	2483.50	51.48	27.59	34.97	4.00	48.10	74.00	-25.90	Peak

Remark: Level = Read Level + Antenna Factor - Preamp Factor + Cable Loss



EUT :	Bluetooth Speaker	Model Name :	WD-S01
Temperature :	25 °C	Relative Humidity :	60%
Pressure :	1012 hPa	Polarization :	Vertical
Test Voltage :	DC 5V from PC AC 120V/60Hz		
Test Mode :	CH78 for 8-DPSK		

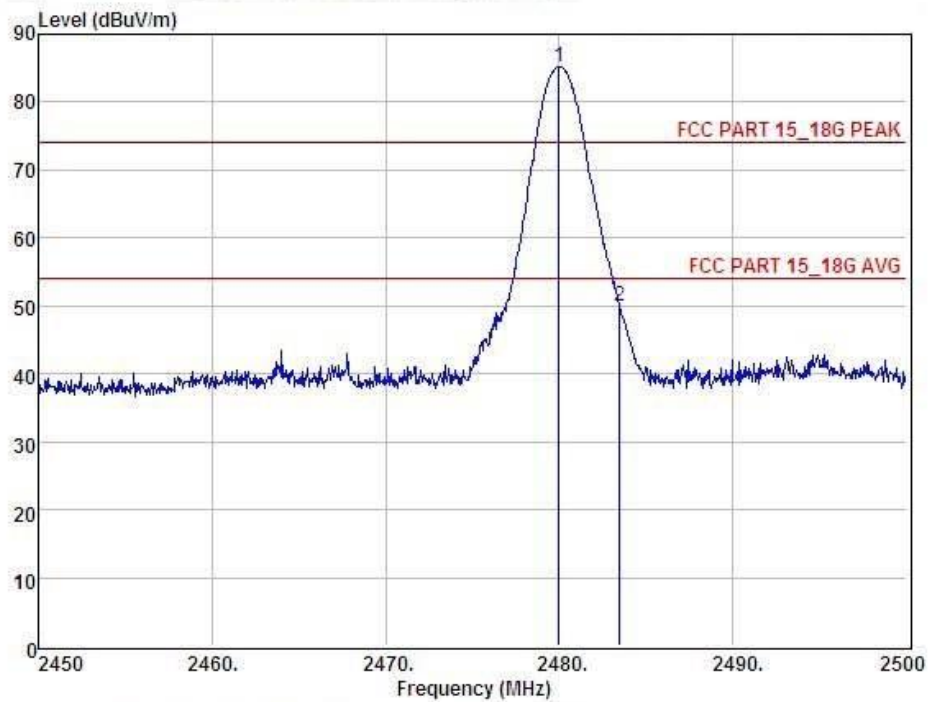

Condition : FCC PART 15_18G PEAK 3m POL: VERTICAL									
Item	Freq	Read	Antenna	Preamp	Cable	Level	Limit	Margin	Remark
	MHz	Level	Factor	Factor	Loss	dBuV	dBuV	dBuV	
		dBuV	dB	dB	dB				
1	2480.00	88.66	27.59	34.97	4.00	88.28	74.00	11.28	Peak
2	2483.50	53.24	27.59	34.97	4.00	49.86	74.00	-24.14	Peak

Remark: Level = Read Level + Antenna Factor - Preamp Factor + Cable Loss

EUT :	Bluetooth Speaker	Model Name :	WD-S01
Temperature :	25 °C	Relative Humidity :	60%
Pressure :	1012 hPa	Polarization :	Horizontal
Test Voltage :	DC 5V from PC AC 120V/60Hz		
Test Mode :	Hopping for 8-DPSK		

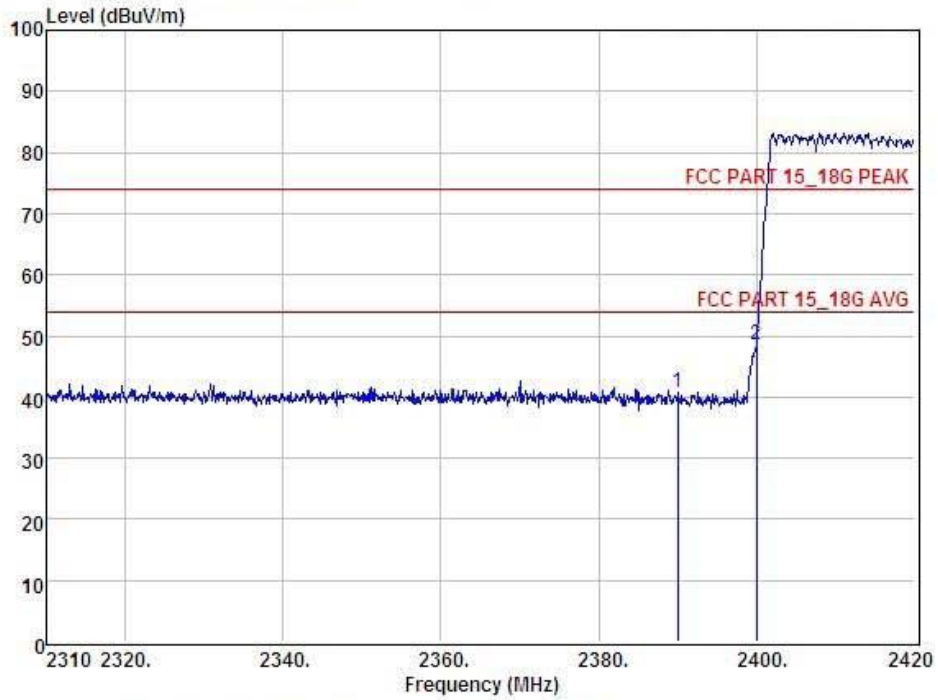

Condition : FCC PART 15_18G PEAK 3m POL: HORIZONTAL									
Item	Freq	Read	Antenna	Preamp	Cable	Level	Limit	Margin	Remark
	MHz	Level	Factor	Factor	Loss	dBuV	dBuV	dBuV	
		dBuV	dB	dB	dB				
1	2390.00	44.16	27.62	34.97	3.92	40.73	74.00	-33.27	Peak
2	2400.00	51.95	27.62	34.97	3.94	48.54	74.00	-25.46	Peak

Remark: Level = Read Level + Antenna Factor - Preamp Factor + Cable Loss

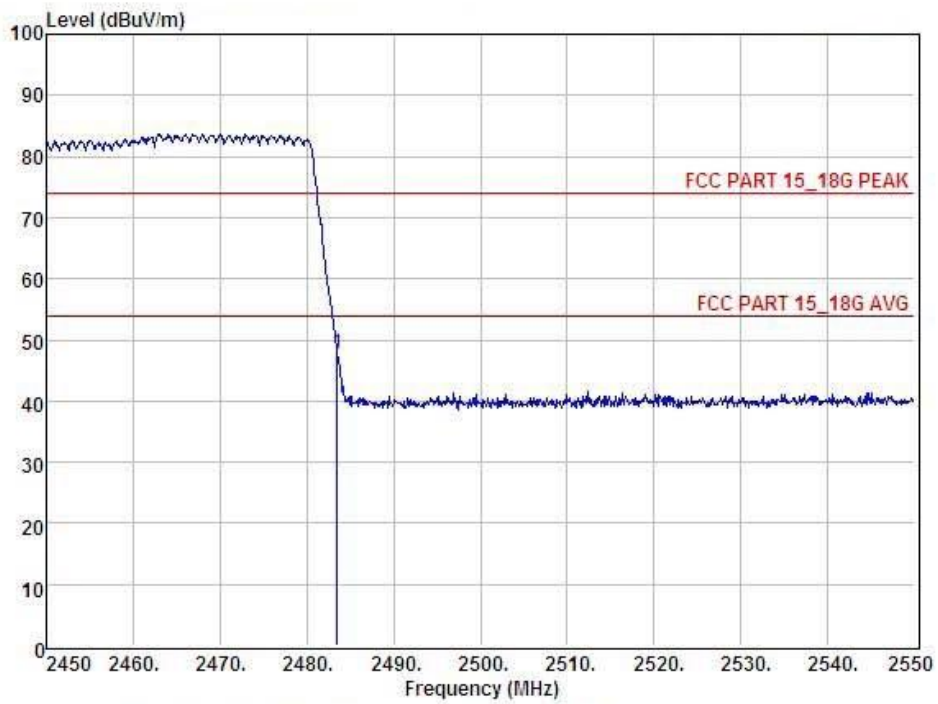

Condition : FCC PART 15_18G PEAK 3m POL: HORIZONTAL									
Item	Freq	Read Level	Antenna Factor	Preamp Factor	Cable Loss	Level	Limit	Margin	Remark
	MHz	dBuV	dB	dB	dB	dBuV	dBuV	dBuV	
1	2483.50	51.03	27.59	34.97	4.00	47.65	74.00	-26.35	Peak

Remark: Level = Read Level + Antenna Factor - Preamp Factor + Cable Loss

EUT :	Bluetooth Speaker	Model Name :	WD-S01
Temperature :	25 °C	Relative Humidity :	60%
Pressure :	1012 hPa	Polarization :	Vertical
Test Voltage :	DC 5V from PC AC 120V/60Hz		
Test Mode :	Hopping for 8-DPSK		

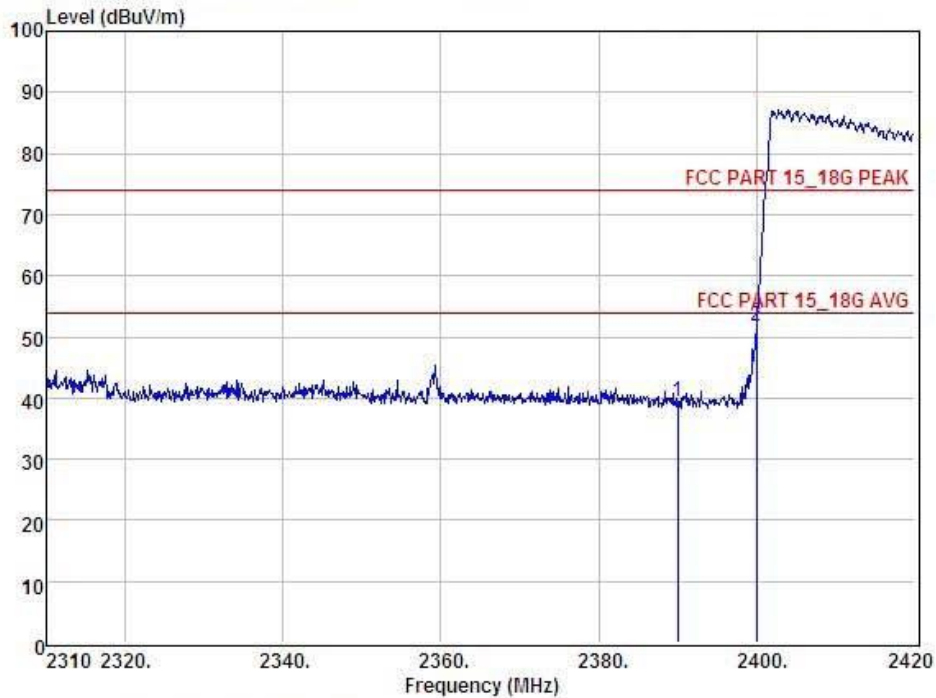

Condition : FCC PART 15_18G PEAK 3m POL: VERTICAL										
Item	Freq	Read Level	Antenna Factor	Preamp Factor	Cable Loss	Level	Limit	Margin	Remark	
	MHz	dBuV	dB	dB	dB	dBuV	dBuV	dBuV		
1	2390.00	42.84	27.62	34.97	3.92	39.41	74.00	-34.59	Peak	
2	2400.00	55.09	27.62	34.97	3.94	51.68	74.00	-22.32	Peak	

Remark: Level = Read Level + Antenna Factor - Preamp Factor + Cable Loss

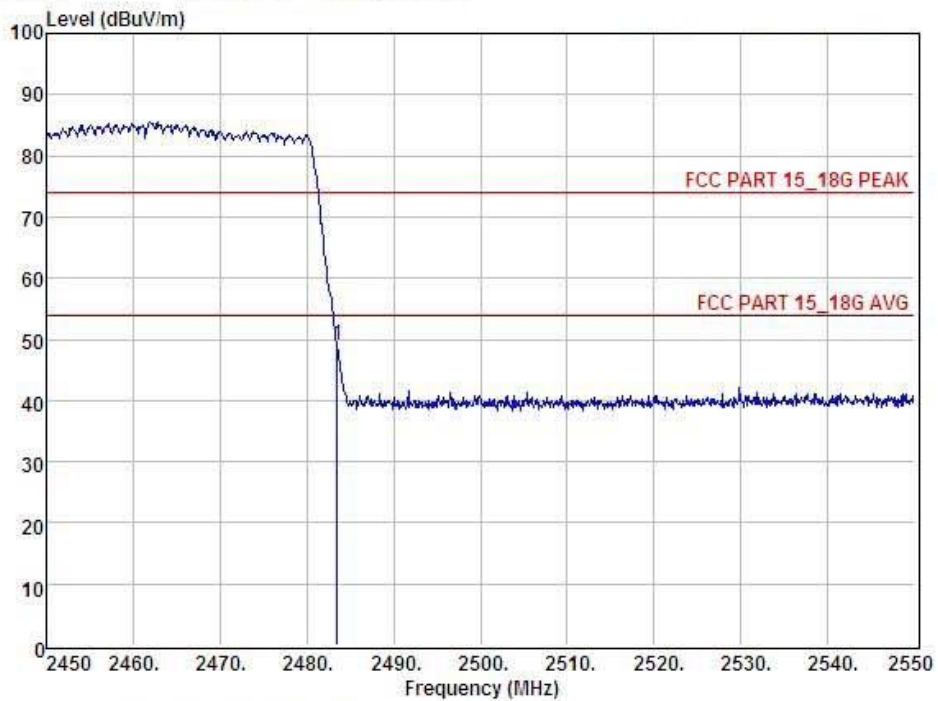

Condition : FCC PART 15\_18G PEAK 3m POL: VERTICAL

Item	Freq MHz	Read Level dBuV	Antenna Factor dB	Preamp Factor dB	Cable Loss dB	Level dBuV	Limit dBuV	Margin dBuV	Remark
1	2483.50	52.36	27.59	34.97	4.00	48.98	74.00	-25.02	Peak

Remark: Level = Read Level + Antenna Factor - Preamp Factor + Cable Loss

**4. NUMBER OF HOPPING CHANNEL**

**4.1 APPLIED PROCEDURES / LIMIT**

FCC Part15 (15.247) , Subpart C				
Section	Test Item	Limit	Frequency Range (MHz)	Result
15.247 (a)(1)(iii)	Number of Hopping Channel	≥15	2400-2483.5	PASS

Spectrum Parameters	Setting
Attenuation	Auto
Span Frequency	> Operating Frequency Range
RB	100 kHz
VB	100 kHz
Detector	Peak
Trace	Max Hold
Sweep Time	Auto

**4.1.1 TEST PROCEDURE**

- a. The EUT was directly connected to the spectrum analyzer and antenna output port as show in the block diagram below,
- b. Spectrum Setting : RBW= 100KHz, VBW=100KHz, Sweep time = Auto.

**4.1.2 DEVIATION FROM STANDARD**

No deviation.

**4.1.3 TEST SETUP**

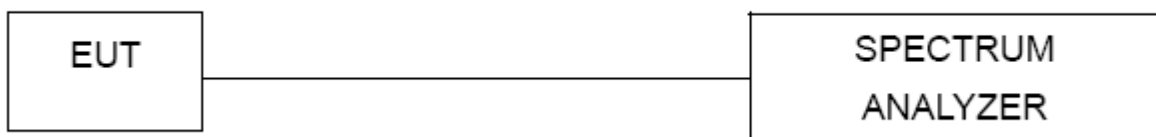

**4.1.4 EUT OPERATION CONDITIONS**

The EUT tested system was configured as the statements of 2.4 Unless otherwise a special operating condition is specified in the follows during the testing.

### 4.1.5 TEST RESULTS

EUT :	Bluetooth Speaker	Model Name :	WD-S01
Temperature :	25 °C	Relative Humidity :	60%
Pressure :	1015 hPa	Test Voltage :	DC 5V from PC AC 120V/60Hz
Test Mode :	Hopping Mode for GFSK		

Number of Hopping Channel	79
---------------------------	----

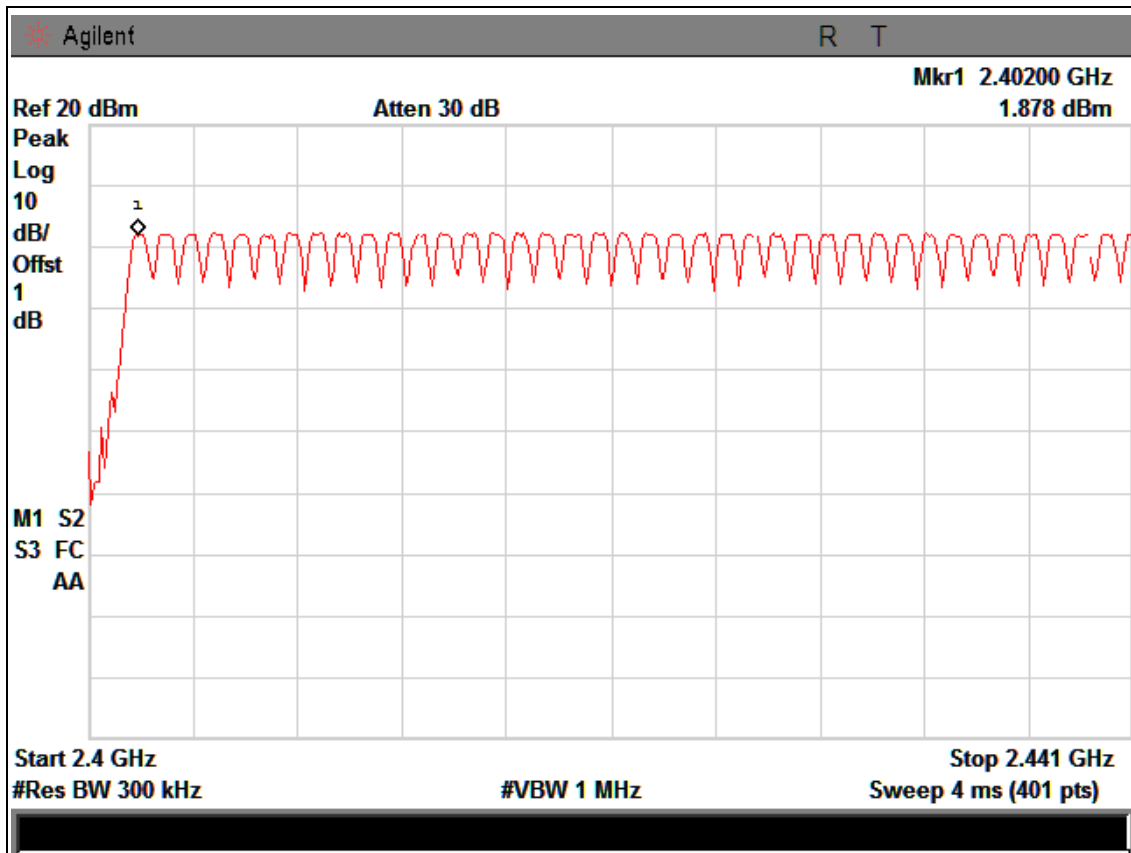

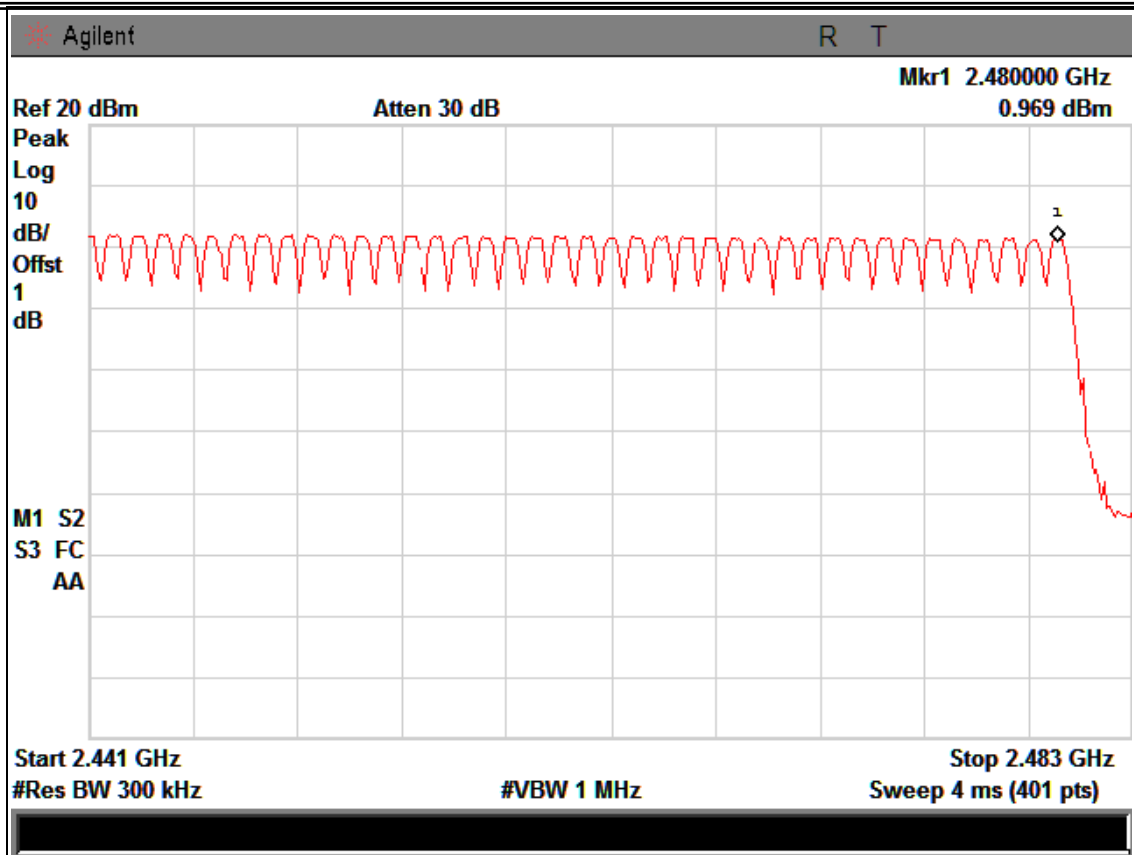



EUT :	Bluetooth Speaker	Model Name :	WD-S01
Temperature :	25 °C	Relative Humidity :	60%
Pressure :	1015 hPa	Test Voltage :	DC 5V from PC AC 120V/60Hz
Test Mode :	Hopping Mode for 8-DPSK		

Number of Hopping Channel	79
---------------------------	----

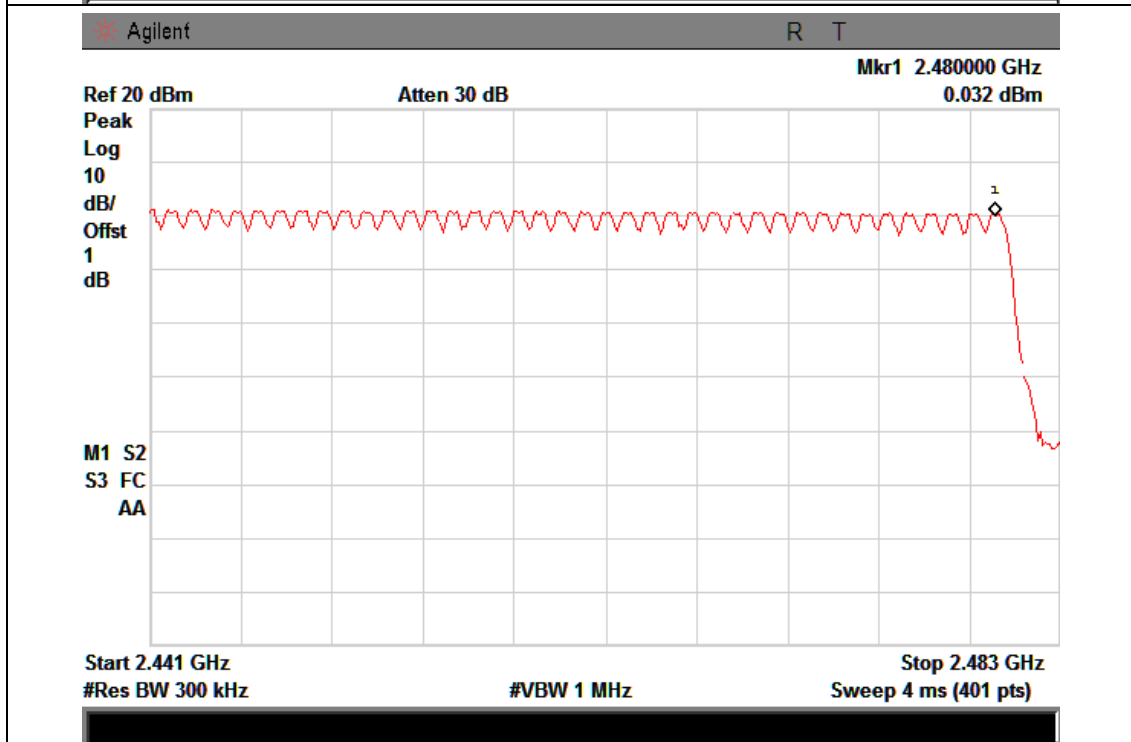
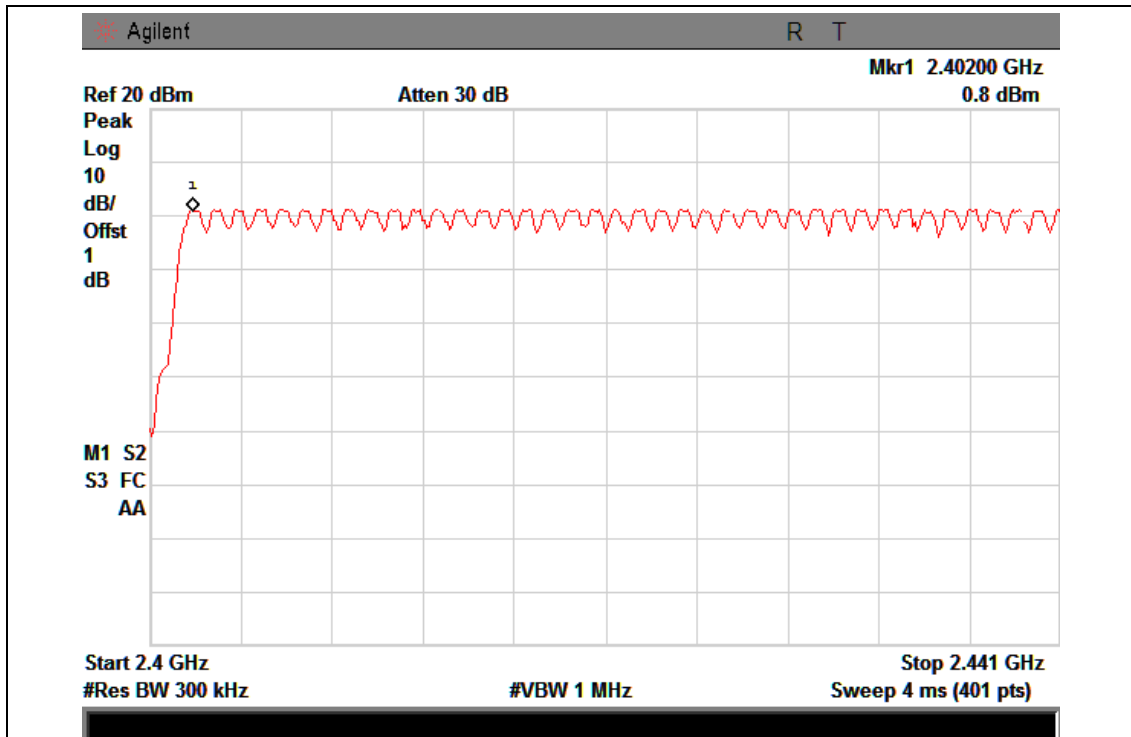

**5. AVERAGE TIME OF OCCUPANCY**

**5.1 APPLIED PROCEDURES / LIMIT**

FCC Part15 (15.247) , Subpart C				
Section	Test Item	Limit	Frequency Range (MHz)	Result
15.247 (a)(1)(iii)	Average Time of Occupancy	0.4sec	2400-2483.5	PASS

**5.1.1 TEST PROCEDURE**

- a. The transmitter output (antenna port) was connected to the spectrum analyzer
- b. Set RBW of spectrum analyzer to 1MHz and VBW to 1MHz.
- c. Use a video trigger with the trigger level set to enable triggering only on full pulses.
- d. Sweep Time is more than once pulse time.
- e. Set the center frequency on any frequency would be measure and set the frequency span to zero span.
- f. Measure the maximum time duration of one single pulse.
- g. Set the EUT for DH5, DH3 and DH1 packet transmitting.
- h. Measure the maximum time duration of one single pulse.
- i. DH5 Packet permit maximum  $1600 / 79 / 6 = 3.37$  hops per second in each channel (5 time slots RX, 1 time slot TX). So, the dwell time is the time duration of the pulse times  $3.37 \times 31.6 = 106.6$  within 31.6 seconds.
- j. DH3 Packet permit maximum  $1600 / 79 / 4 = 5.06$  hops per second in each channel (3 time slots RX, 1 time slot TX). So, the dwell time is the time duration of the pulse times  $5.06 \times 31.6 = 160$  within 31.6 seconds.
- k. DH1 Packet permit maximum  $1600 / 79 / 2 = 10.12$  hops per second in each channel (1 time slot RX, 1 time slot TX). So, the dwell time is the time duration of the pulse times  $10.12 \times 31.6 = 320$  within 31.6 seconds.

**5.1.2 DEVIATION FROM STANDARD**

No deviation.

**5.1.3 TEST SETUP**

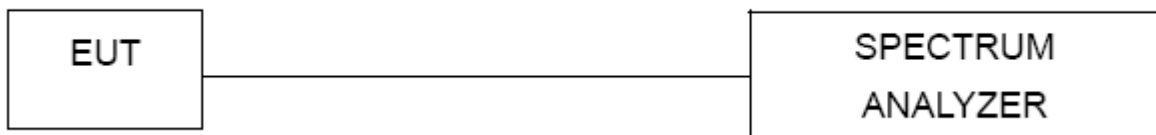

**5.1.4 EUT OPERATION CONDITIONS**

The EUT tested system was configured as the statements of 2.4 Unless otherwise a special operating condition is specified in the follows during the testing.

### 5.1.5 TEST RESULTS

EUT :	Bluetooth Speaker	Model Name :	WD-S01
Temperature :	25 °C	Relative Humidity :	60%
Pressure :	1012 hPa	Test Voltage :	DC 5V from PC AC 120V/60Hz
Test Mode :	CH00-DH1/DH3/DH5 (1Mbps Mode) for GFSK		

Data Packet	Frequency	Pulse Duration (ms)	Dwell Time (s)	Limits (s)
DH1	2402 MHz	0.39	0.12	0.4
DH3	2402 MHz	1.66	0.27	0.4
DH5	2402 MHz	2.92	0.31	0.4

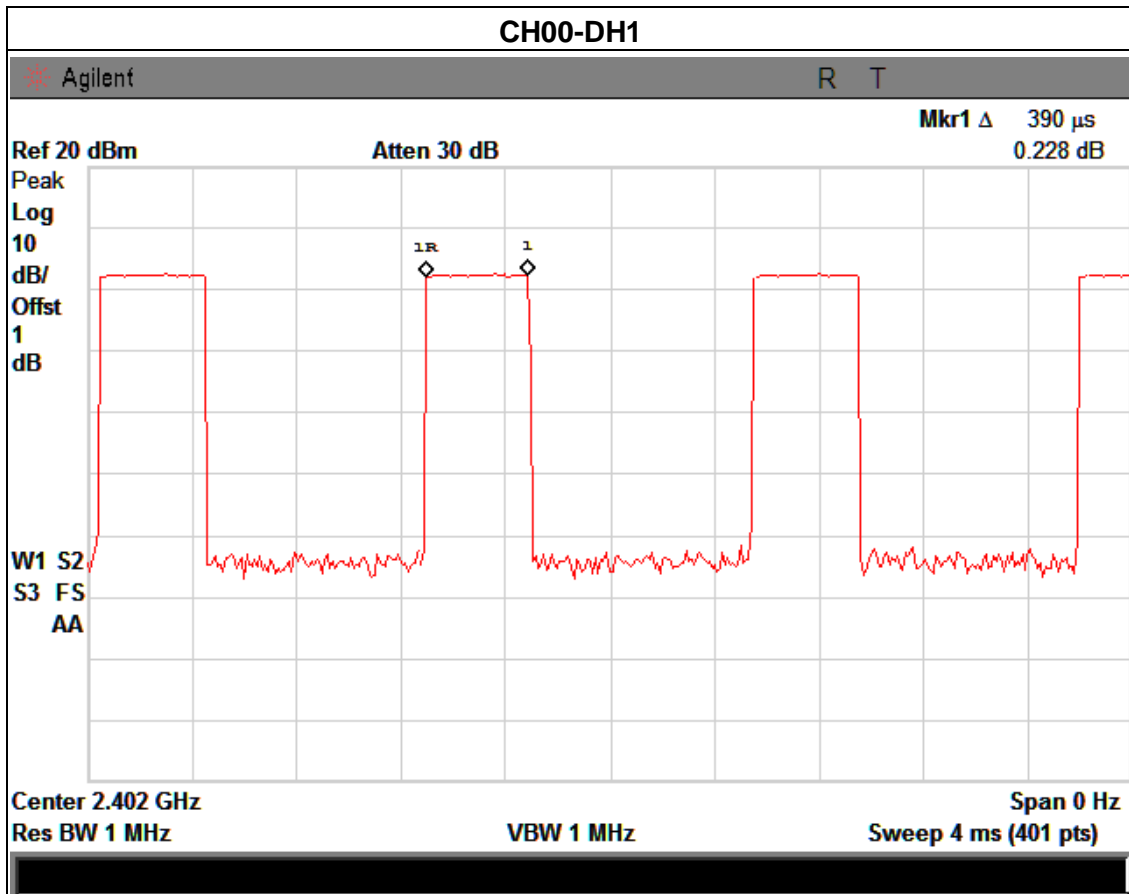

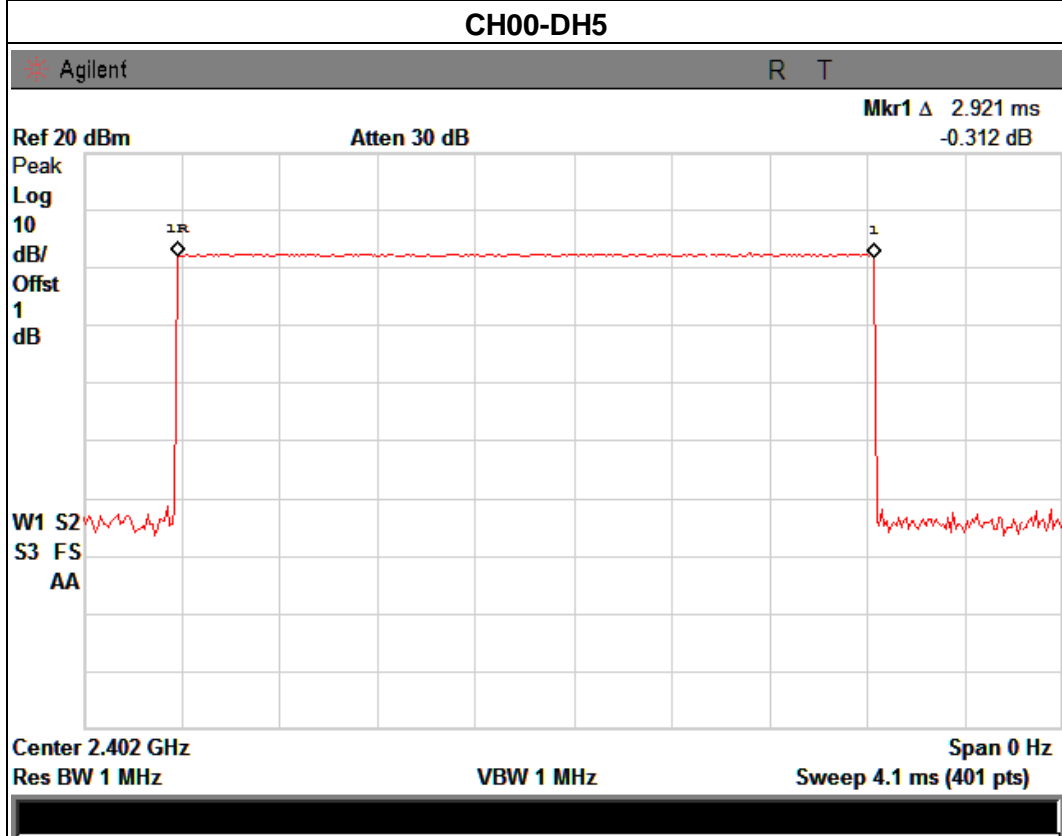
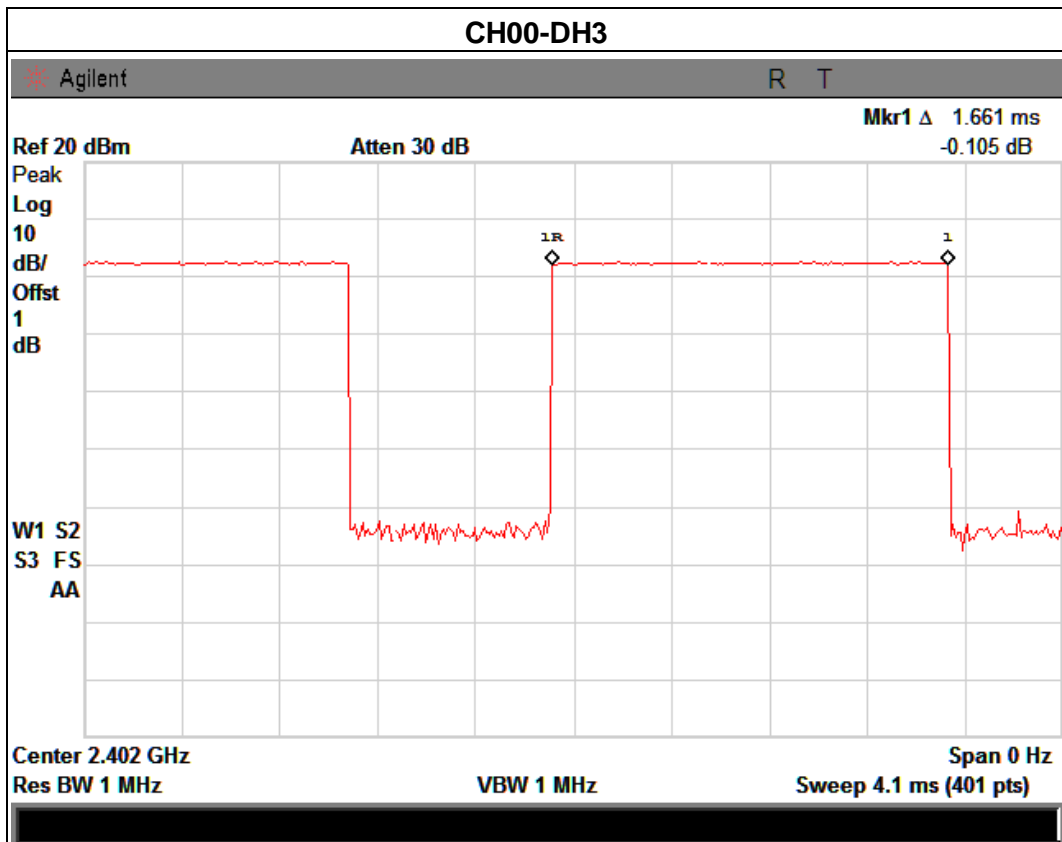

EUT :	Bluetooth Speaker	Model Name :	WD-S01
Temperature :	25 °C	Relative Humidity :	60%
Pressure :	1012 hPa	Test Voltage :	DC 5V from PC AC 120V/60Hz
Test Mode :	CH39 -DH1/DH3/DH5 (1Mbps Mode) for GFSK		

Data Packet	Frequenc y	Pulse Duration (ms)	Dwell Time (s)	Limits (s)
DH1	2441 MHz	0.40	0.13	0.4
DH3	2441 MHz	1.66	0.27	0.4
DH5	2441 MHz	2.91	0.31	0.4

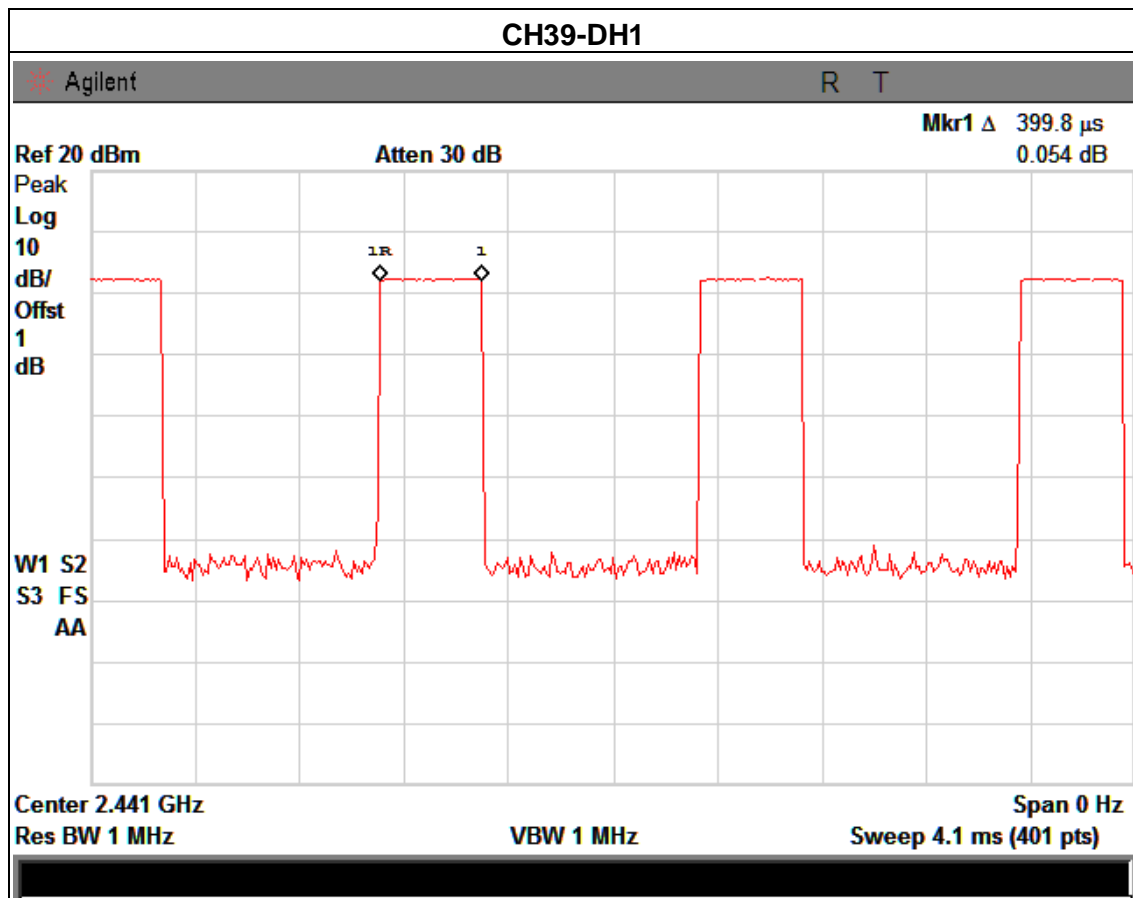

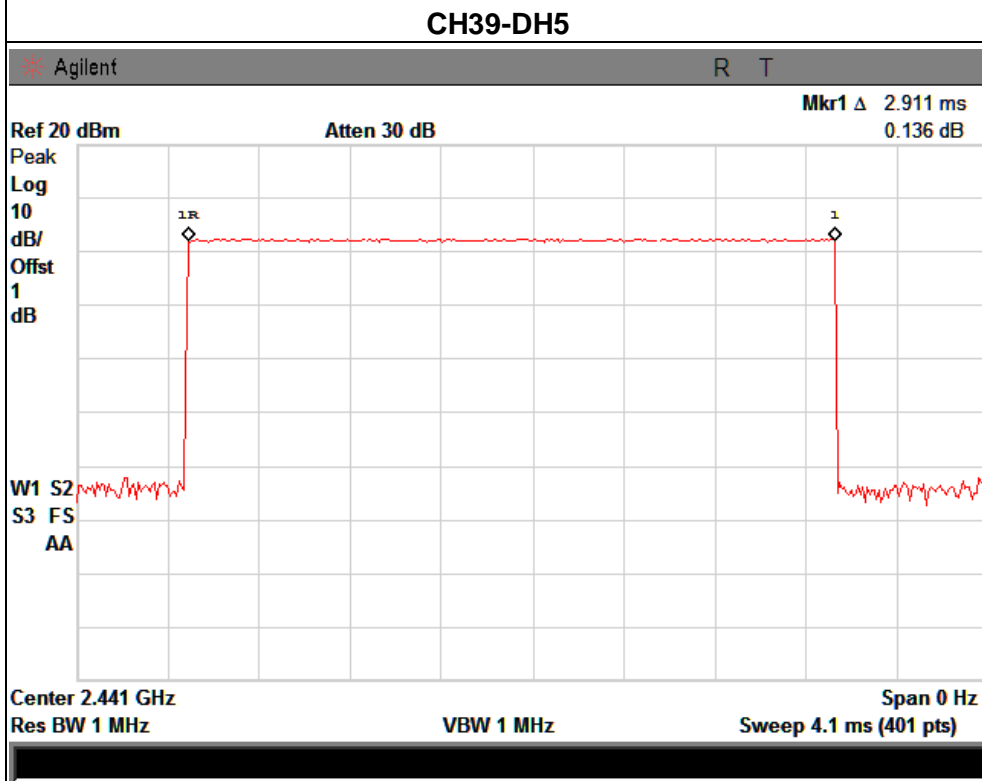
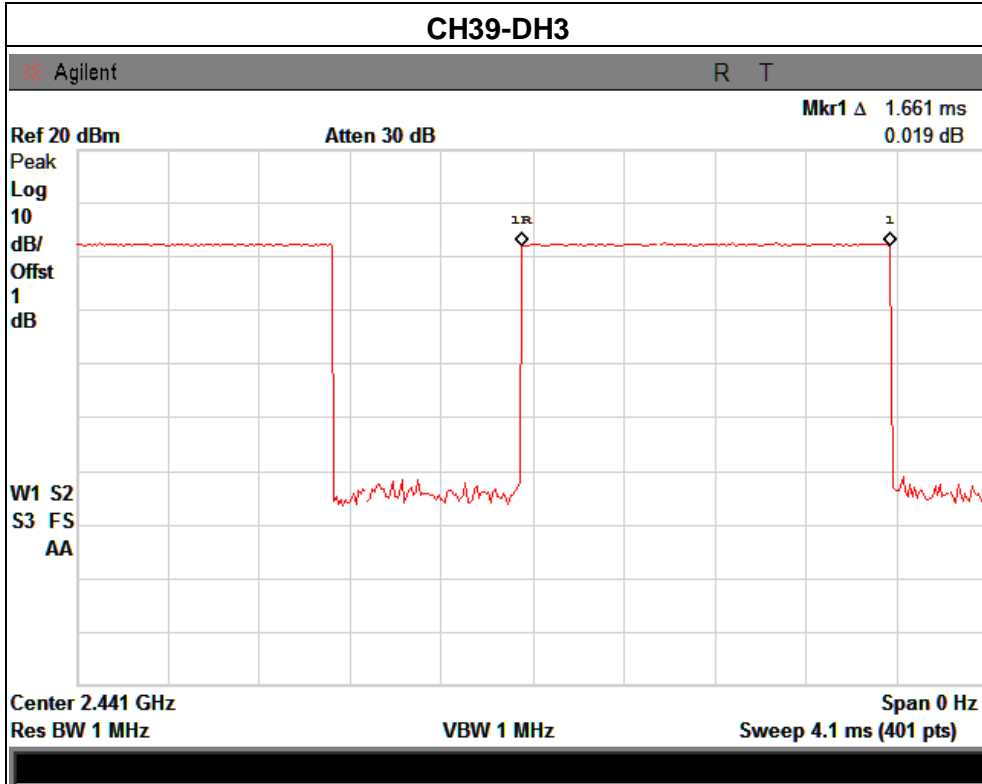

EUT :	Bluetooth Speaker	Model Name :	WD-S01
Temperature :	25 °C	Relative Humidity :	60%
Pressure :	1012 hPa	Test Voltage :	DC 5V from PC AC 120V/60Hz
Test Mode :	CH78 -DH1/DH3/DH5 (1Mbps Mode) for GFSK		

Data Packet	Frequency	Pulse Duration (ms)	Dwell Time (s)	Limits (s)
DH1	2480 MHz	0.40	0.13	0.4
DH3	2480 MHz	1.66	0.27	0.4
DH5	2480 MHz	2.91	0.31	0.4

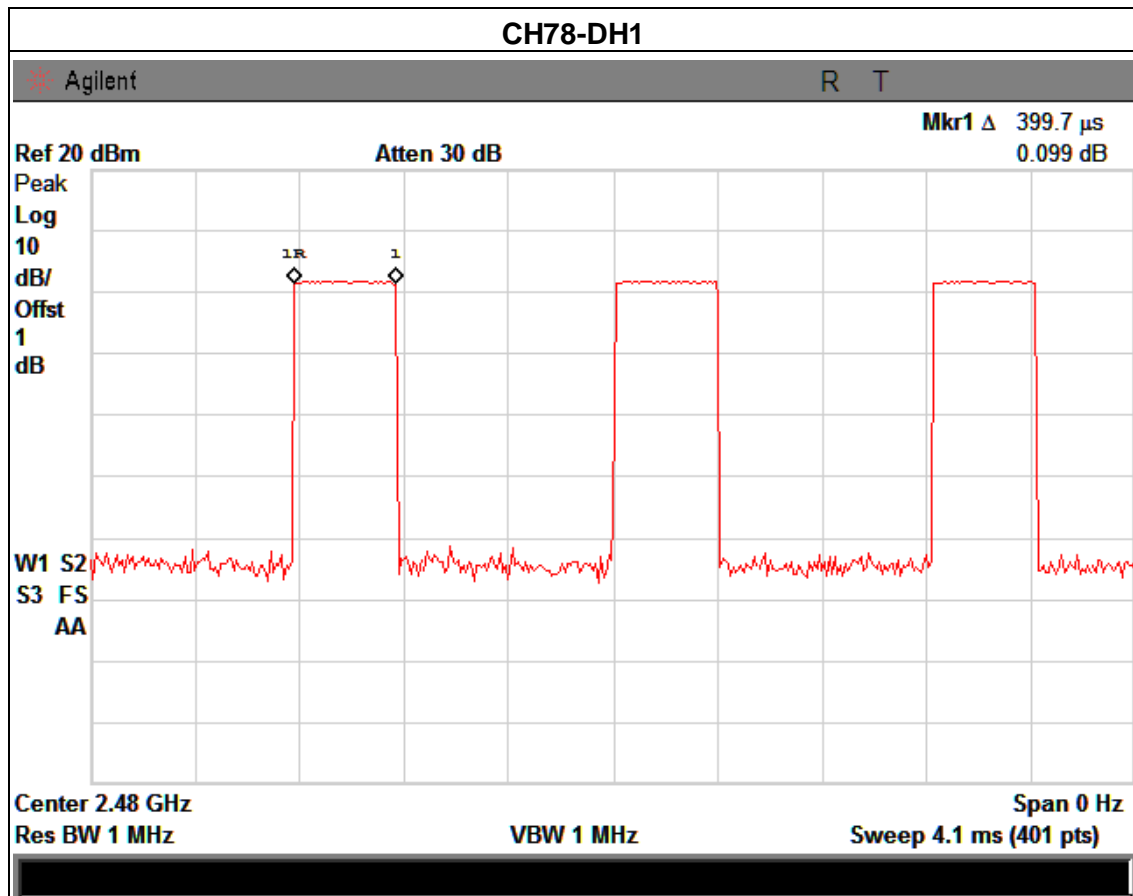

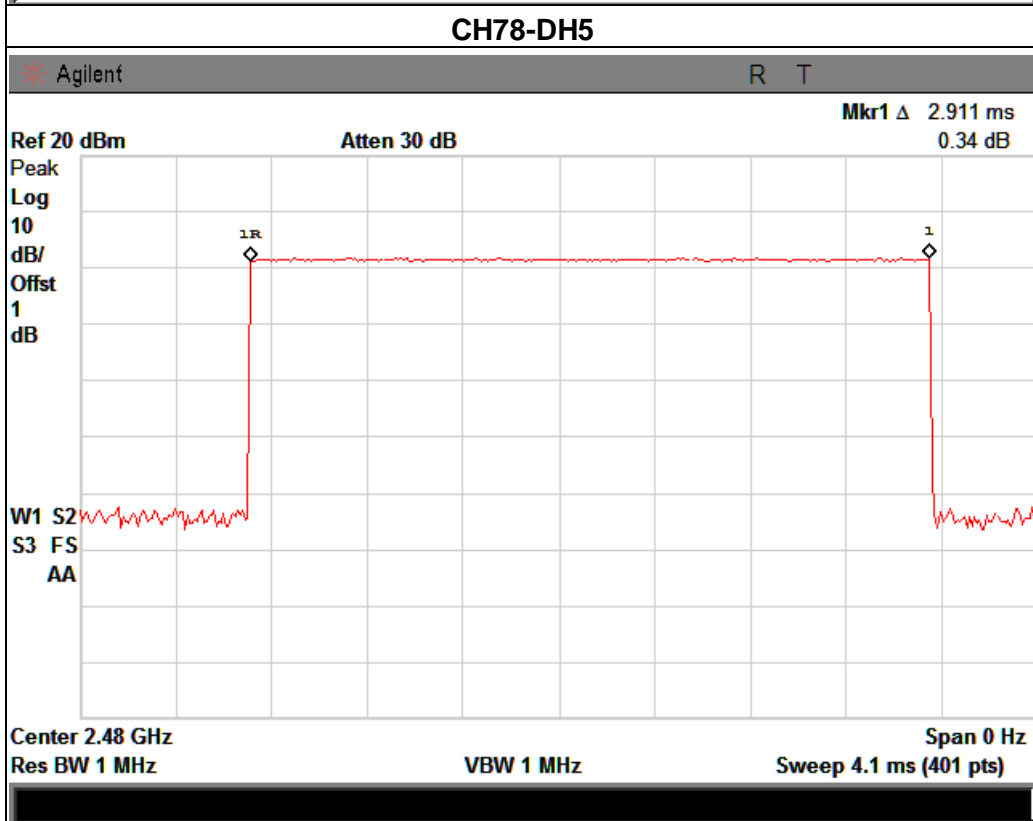
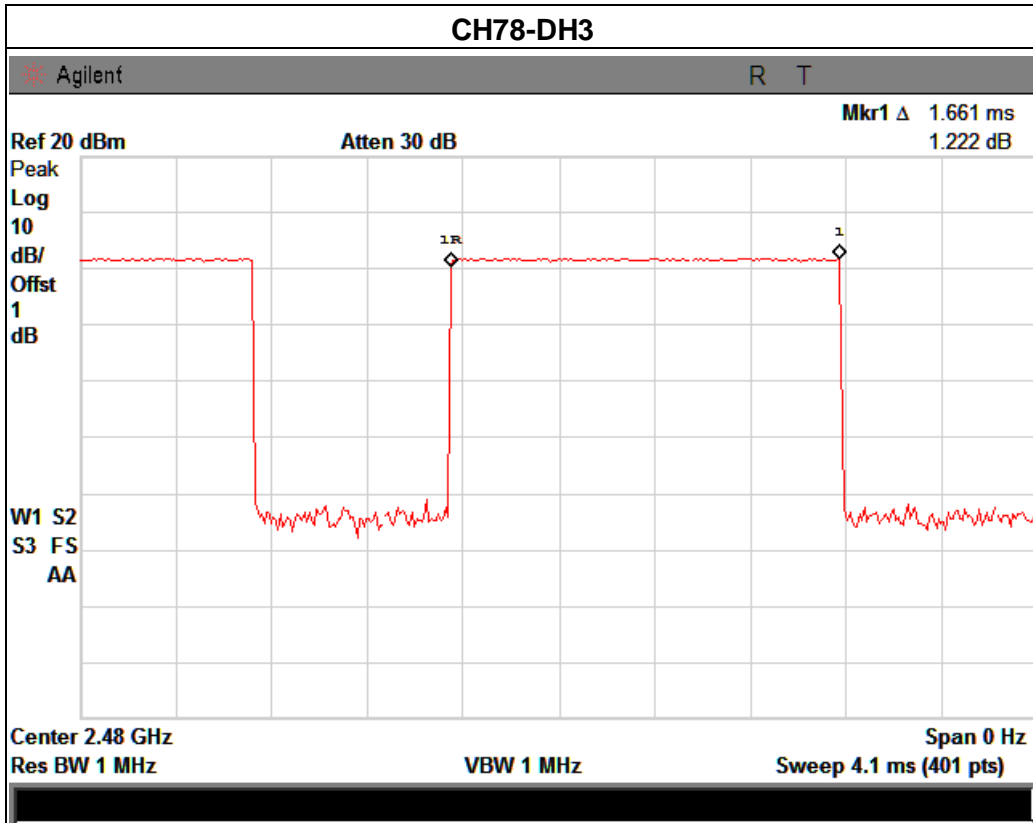



EUT :	Bluetooth Speaker	Model Name :	WD-S01
Temperature :	25 °C	Relative Humidity :	60%
Pressure :	1012 hPa	Test Voltage :	DC 5V from PC AC 120V/60Hz
Test Mode :	CH00-DH1/DH3/DH5 (3Mbps Mode) for 8-DPSK		

Data Packet	Frequency	Pulse Duration (ms)	Dwell Time (s)	Limits (s)
3DH1	2402 MHz	0.40	0.13	0.4
3DH3	2402 MHz	1.66	0.27	0.4
3DH5	2402 MHz	2.92	0.31	0.4

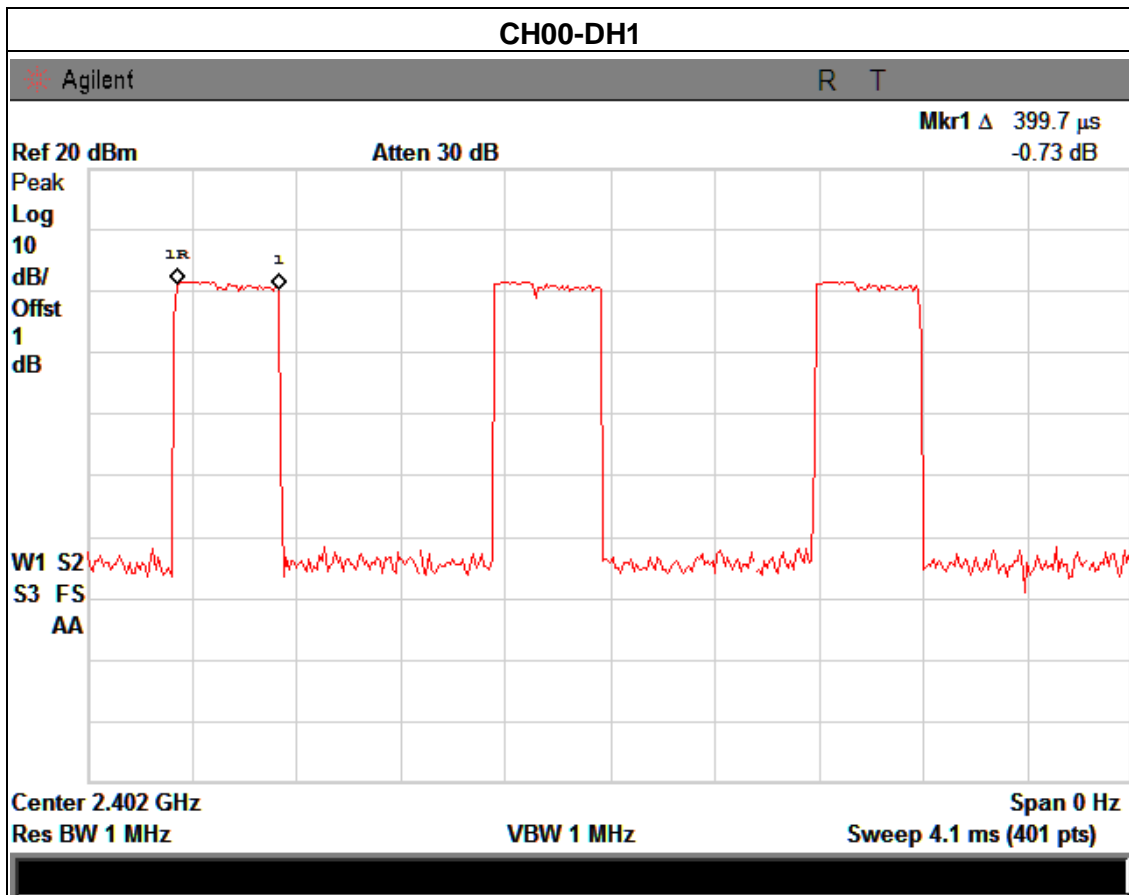

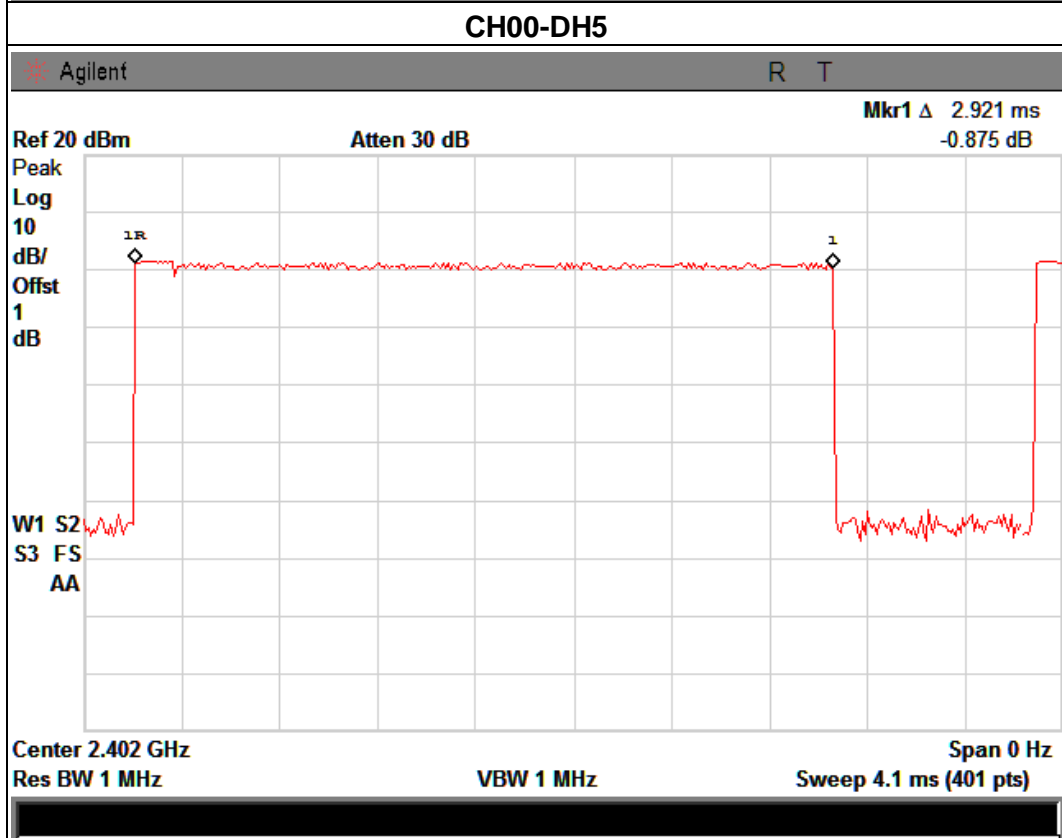
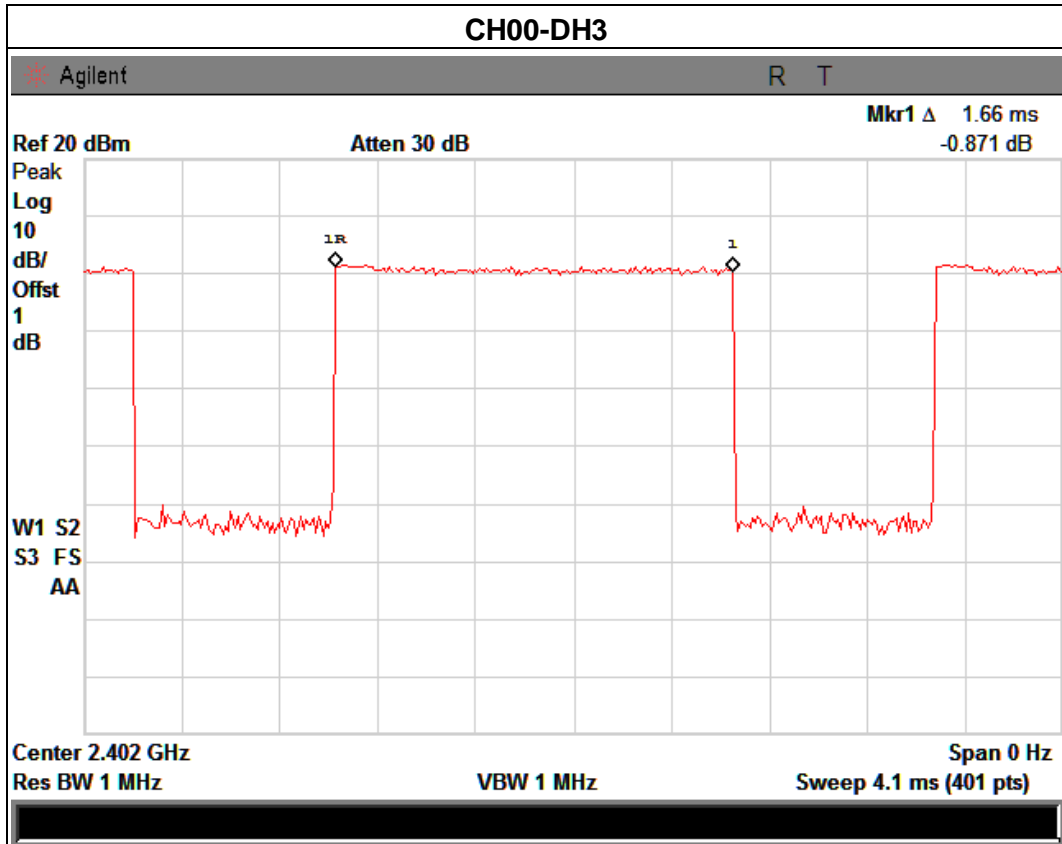

EUT :	Bluetooth Speaker	Model Name :	WD-S01
Temperature :	25 °C	Relative Humidity :	60%
Pressure :	1012 hPa	Test Voltage :	DC 5V from PC AC 120V/60Hz
Test Mode :	CH39 -DH1/DH3/DH5 (3Mbps Mode) 8-DPSK		

Data Packet	Frequency	Pulse Duration (ms)	Dwell Time (s)	Limits (s)
3DH1	2441 MHz	0.41	0.13	0.4
3DH3	2441 MHz	1.66	0.27	0.4
3DH5	2441 MHz	2.92	0.31	0.4

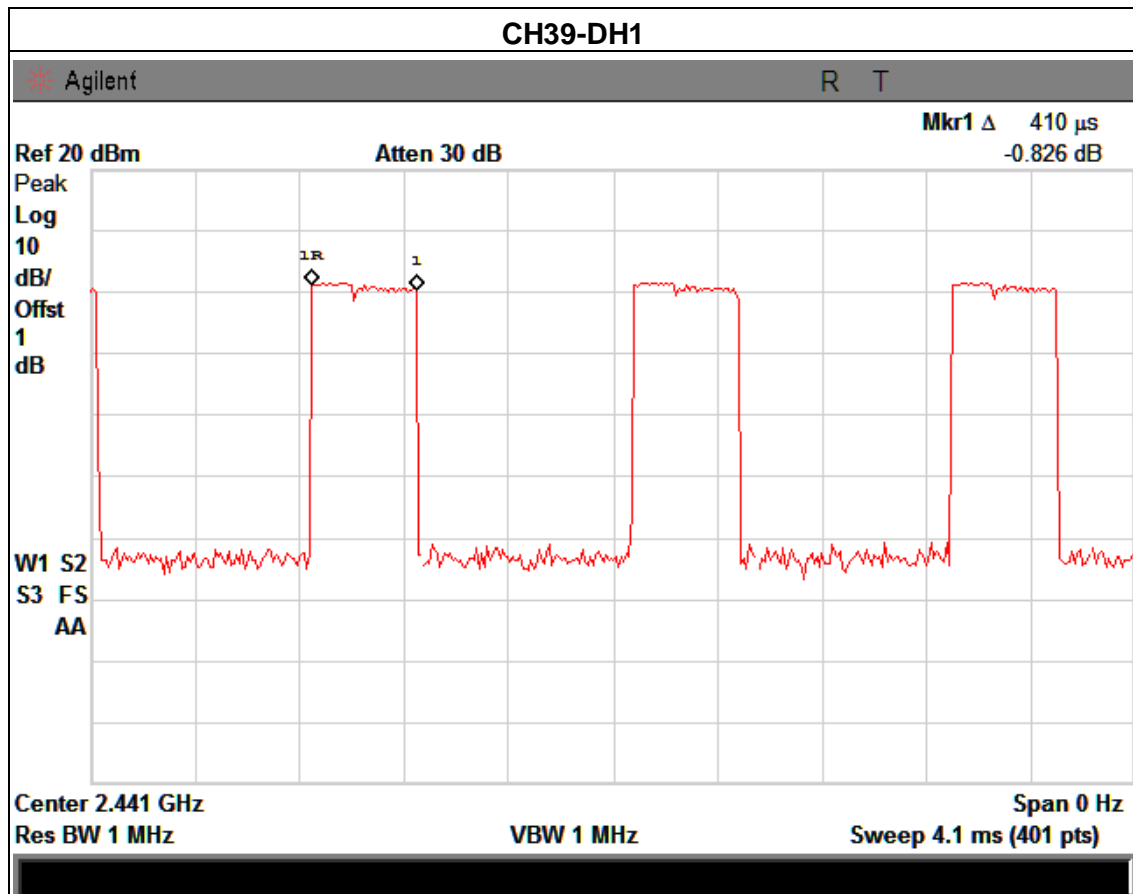

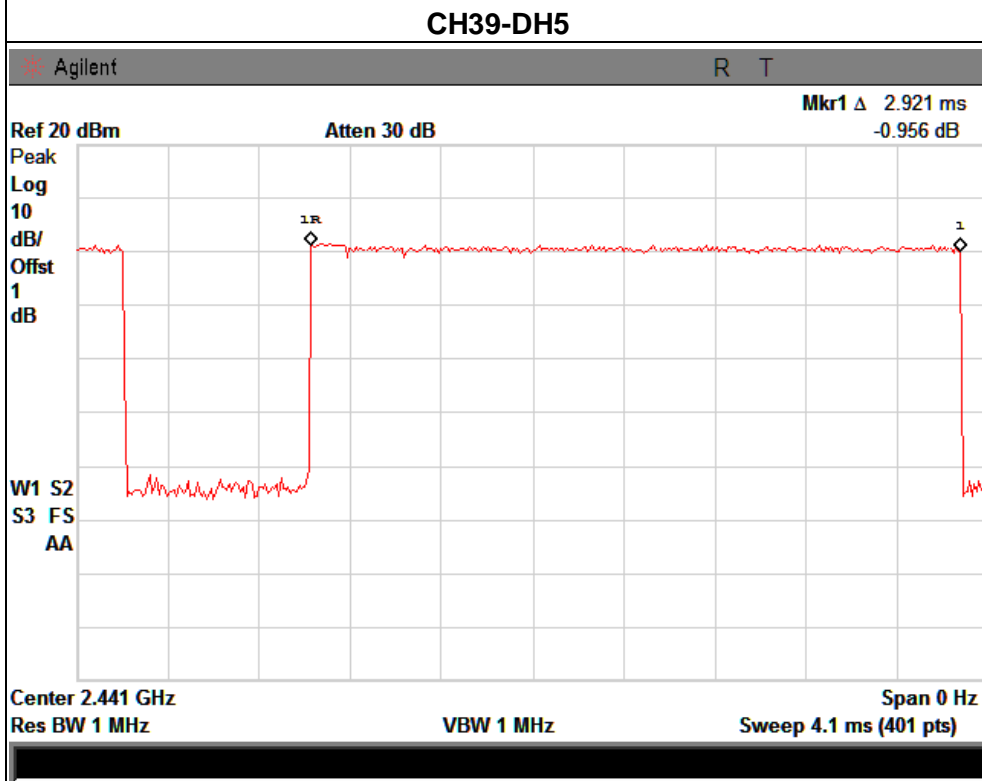
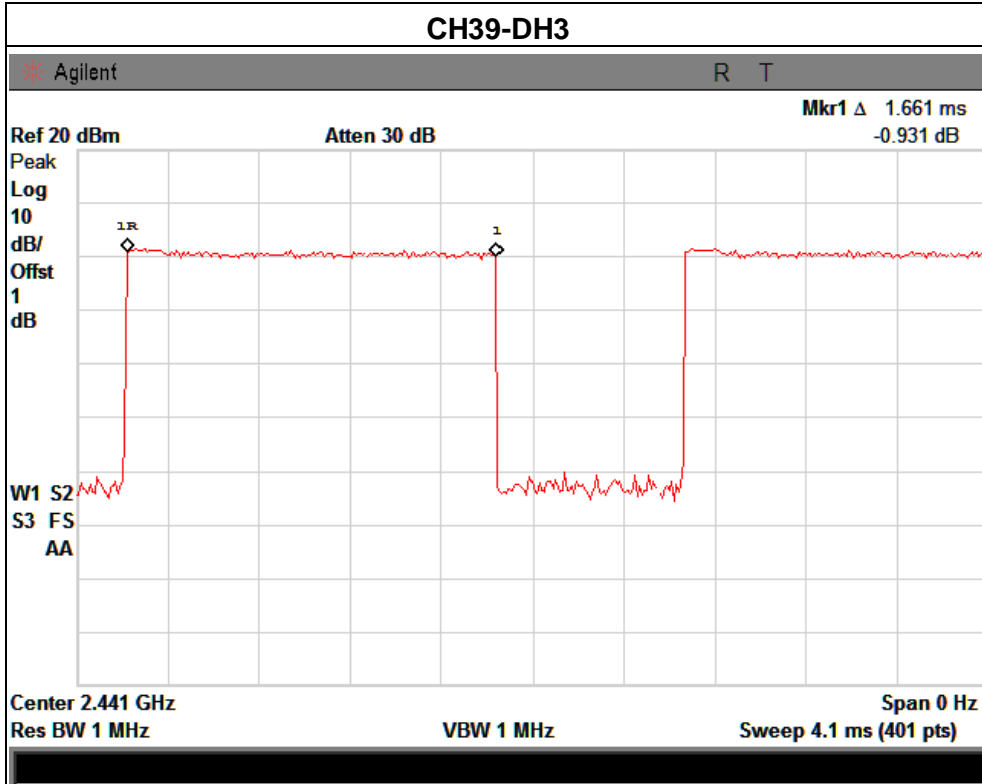

EUT :	Bluetooth Speaker	Model Name :	WD-S01
Temperature :	25 °C	Relative Humidity :	60%
Pressure :	1012 hPa	Test Voltage :	DC 5V from PC AC 120V/60Hz
Test Mode :	CH78 -DH1/DH3/DH5 (3Mbps Mode) 8-DPSK		

Data Packet	Frequenc y	Pulse Duration (ms)	Dwell Time (s)	Limits (s)
3DH1	2480 MHz	0.41	0.13	0.4
3DH3	2480 MHz	1.66	0.27	0.4
3DH5	2480 MHz	2.92	0.31	0.4

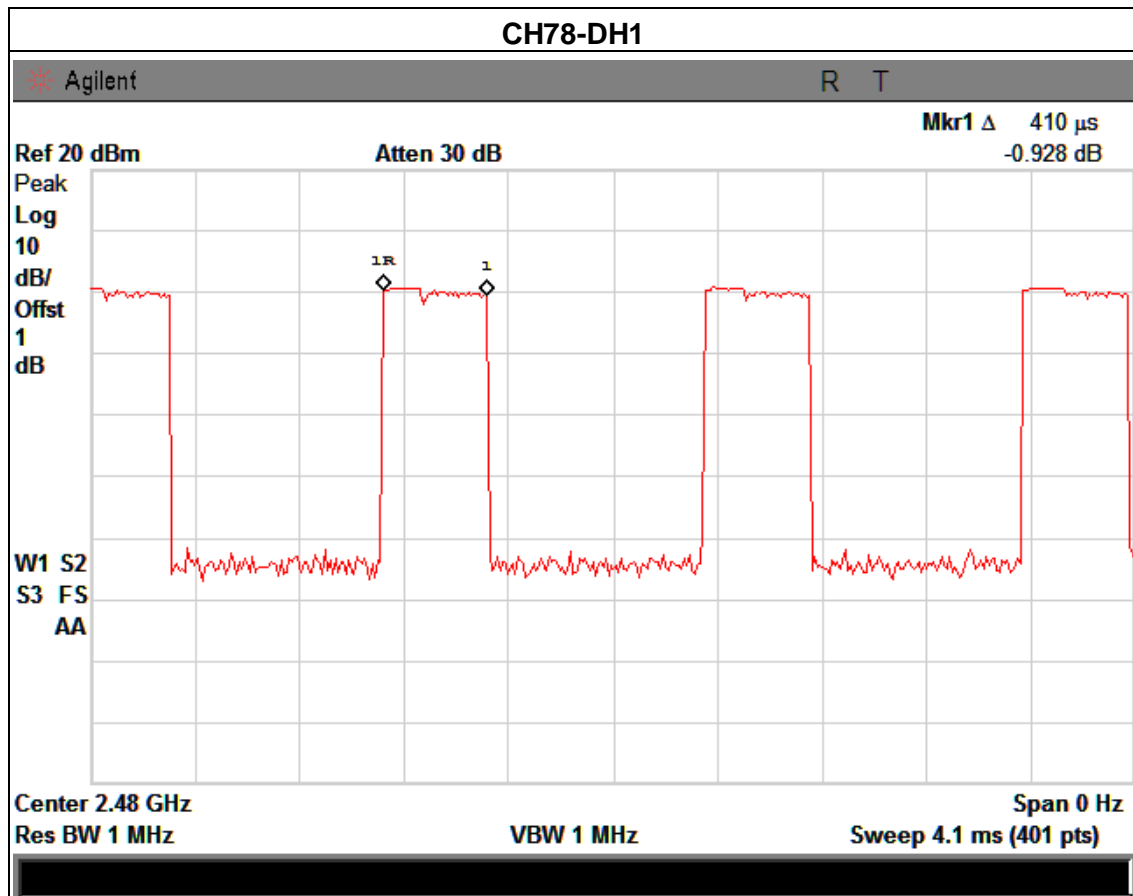

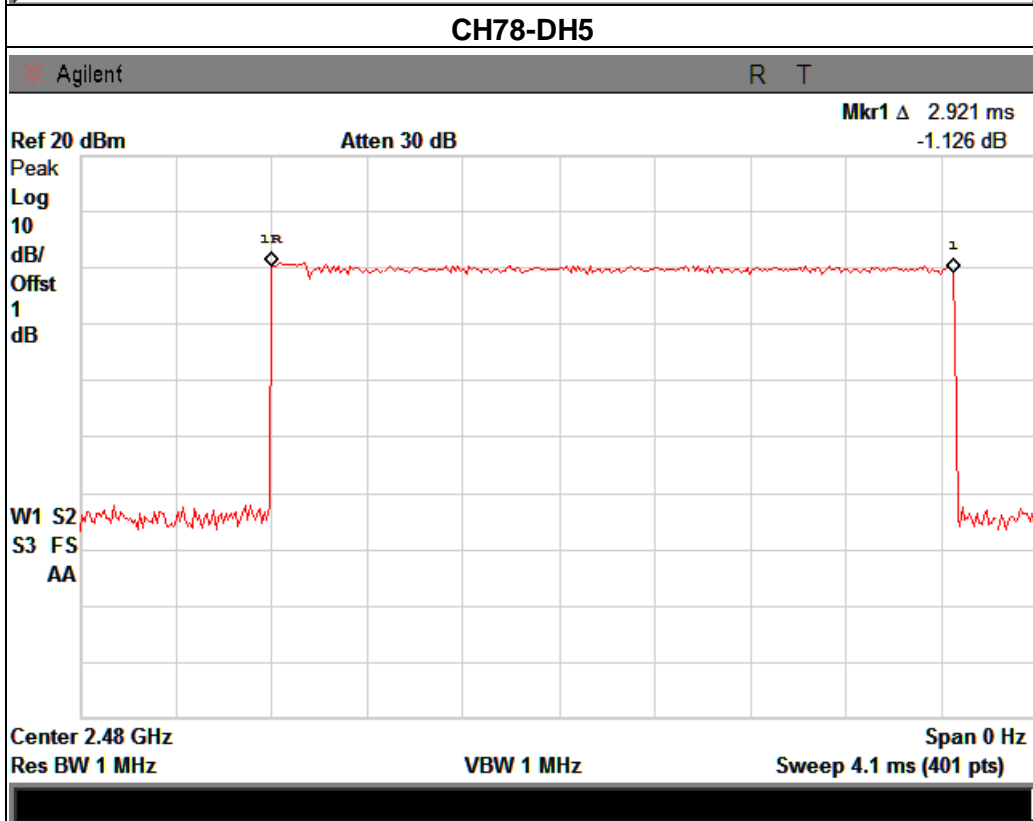
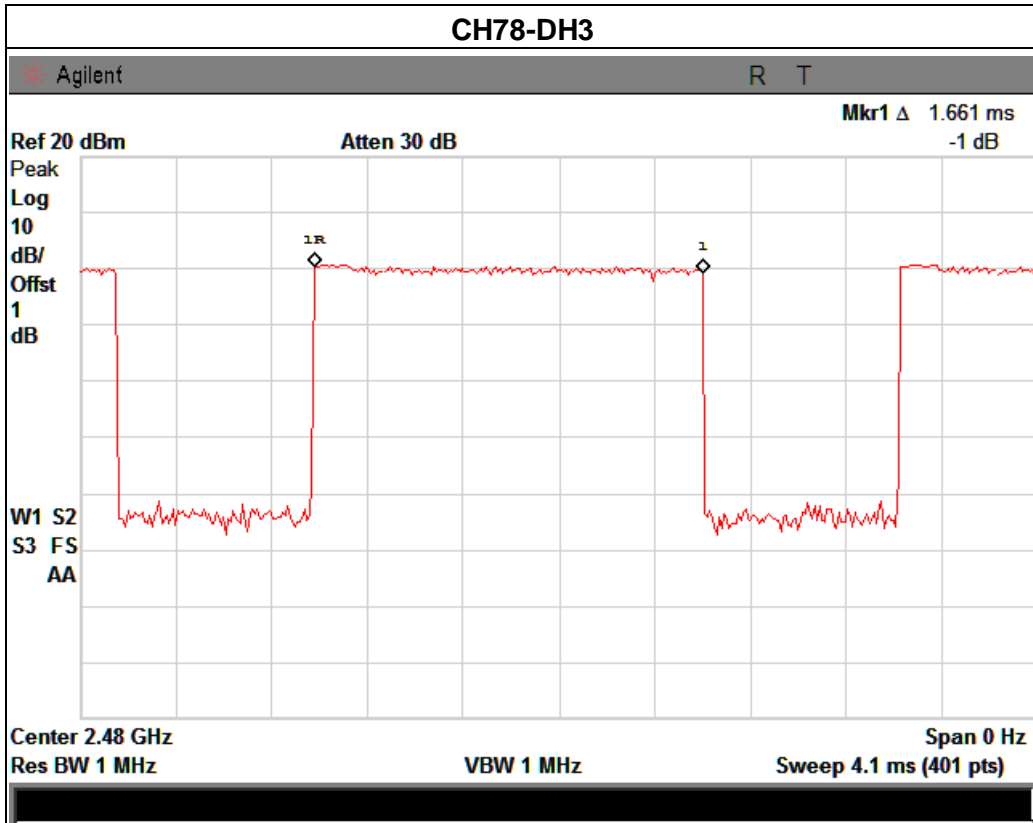

## 6. HOPPING CHANNEL SEPARATION MEASUREMENT

### 6.1 APPLIED PROCEDURES / LIMIT

Frequency hopping systems operating in the 2400-2483.5 MHz band may have hopping channel carrier frequencies that are separated by 25 kHz or two-thirds of the 20 dB bandwidth of the hopping channel, whichever is greater.

Spectrum Parameter	Setting
Attenuation	Auto
Span Frequency	> Measurement Bandwidth or Channel Separation
RB	30 kHz (20dB Bandwidth) / 100 kHz (Channel Separation)
VB	100 kHz (20dB Bandwidth) / 100 kHz (Channel Separation)
Detector	Peak
Trace	Max Hold
Sweep Time	Auto

#### 6.1.1 TEST PROCEDURE

- The transmitter output (antenna port) was connected to the spectrum analyser in peak hold mode.
- The resolution bandwidth of 30 kHz and the video bandwidth of 100 kHz were utilised for 20 dB bandwidth measurement.
- The resolution bandwidth of 100 kHz and the video bandwidth of 100 kHz were utilised for channel separation measurement.

#### 6.1.2 DEVIATION FROM STANDARD

No deviation.

#### 6.1.3 TEST SETUP

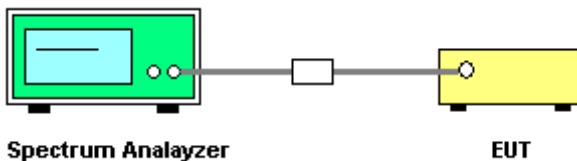

#### 6.1.4 EUT OPERATION CONDITIONS

The EUT was programmed to be in continuously transmitting mode.

**6.1.5 TEST RESULTS**

EUT :	Bluetooth Speaker	Model Name :	WD-S01
Temperature :	25 °C	Relative Humidity :	60%
Pressure :	1012 hPa	Test Voltage :	DC 5V from PC AC 120V/60Hz
Test Mode :	CH00 / CH39 /CH78 (1Mbps Mode)		

Frequency	Ch. Separation (MHz)	Limit (MHz)	Result
GFSK CH00	1.020	0.8639	<b>Complies</b>
GFSK CH39	1.010	0.8588	<b>Complies</b>
GFSK CH78	1.020	0.9294	<b>Complies</b>

Frequency	Ch. Separation (MHz)	Limit (MHz)	Result
8-DPSK CH00	1.030	0.816	<b>Complies</b>
8-DPSK CH39	1.020	0.815	<b>Complies</b>
8-DPSK CH78	1.030	0.813	<b>Complies</b>



For GFSK:

**Ch. Separation Limits: > 20dB bandwidth**

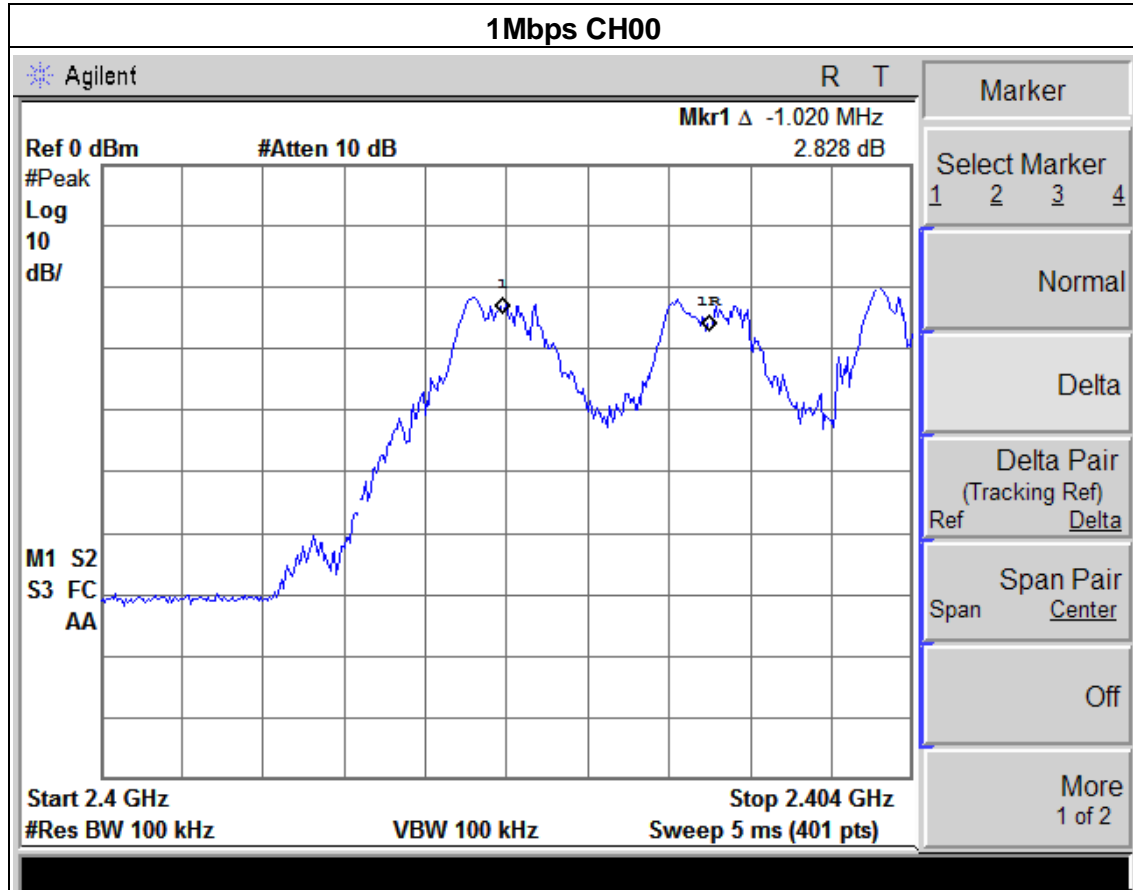

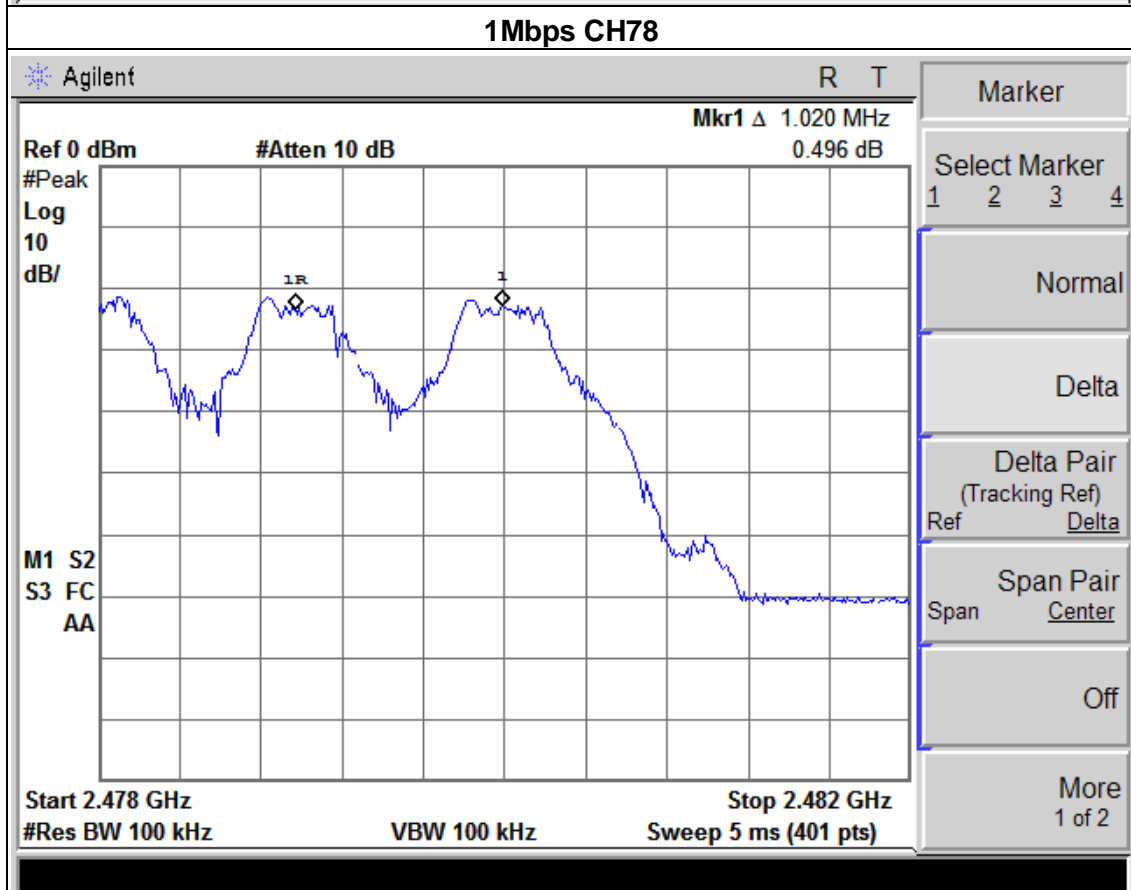
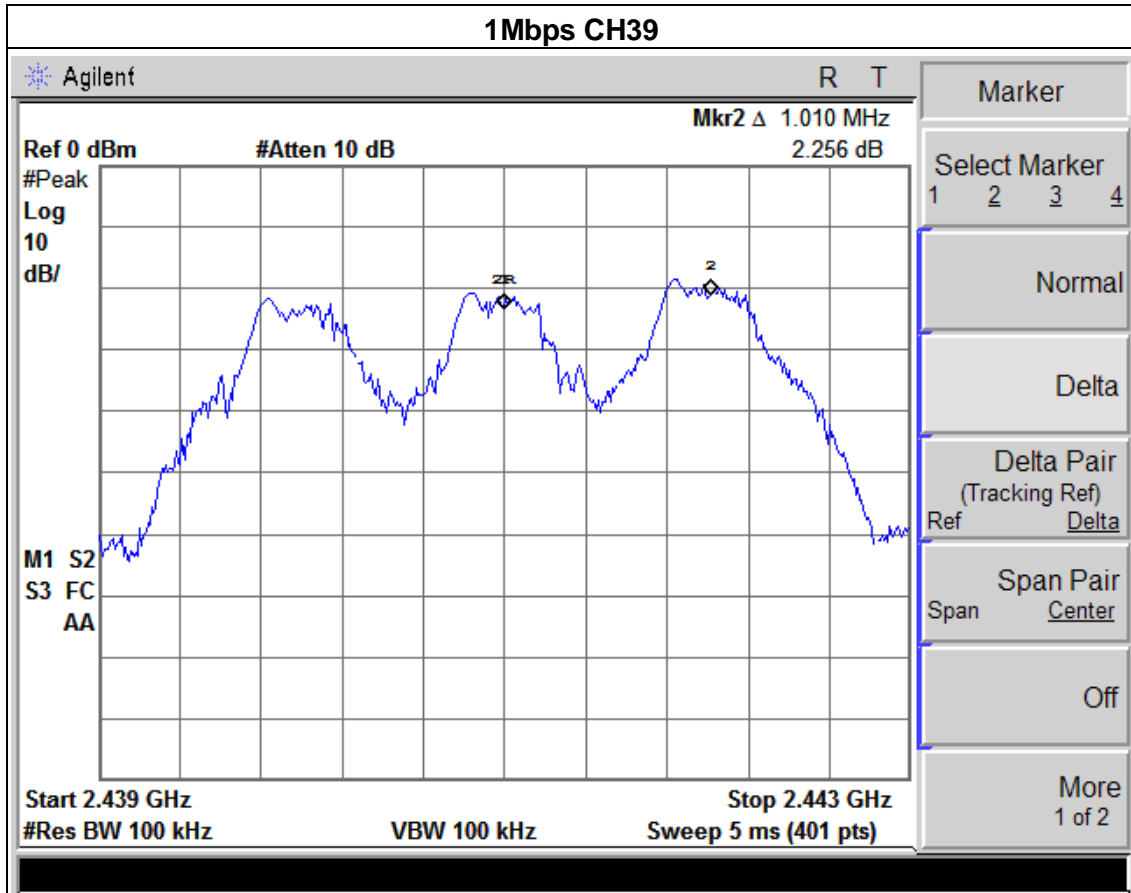

For 8-DPSK:

**Ch. Separation Limits: > 2/3 of 20dB bandwidth**

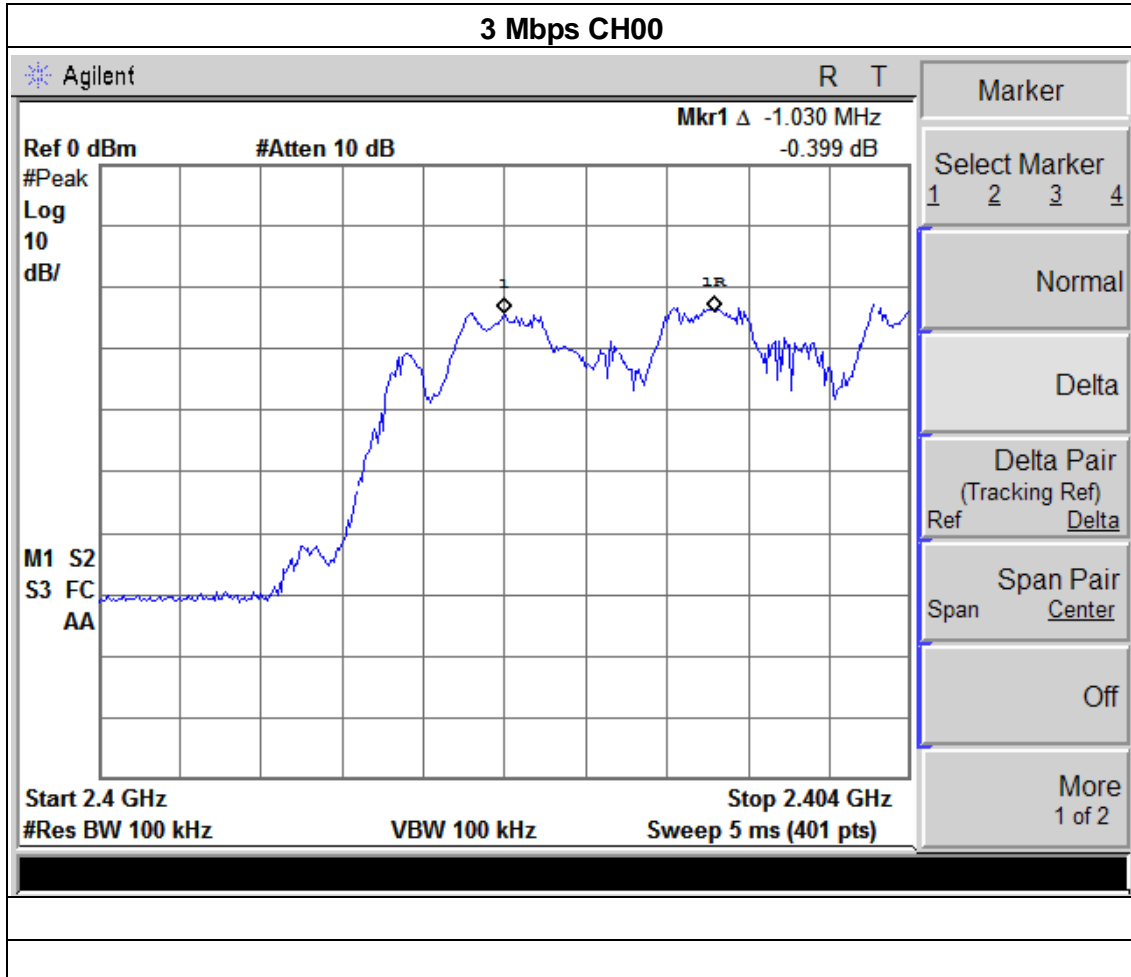

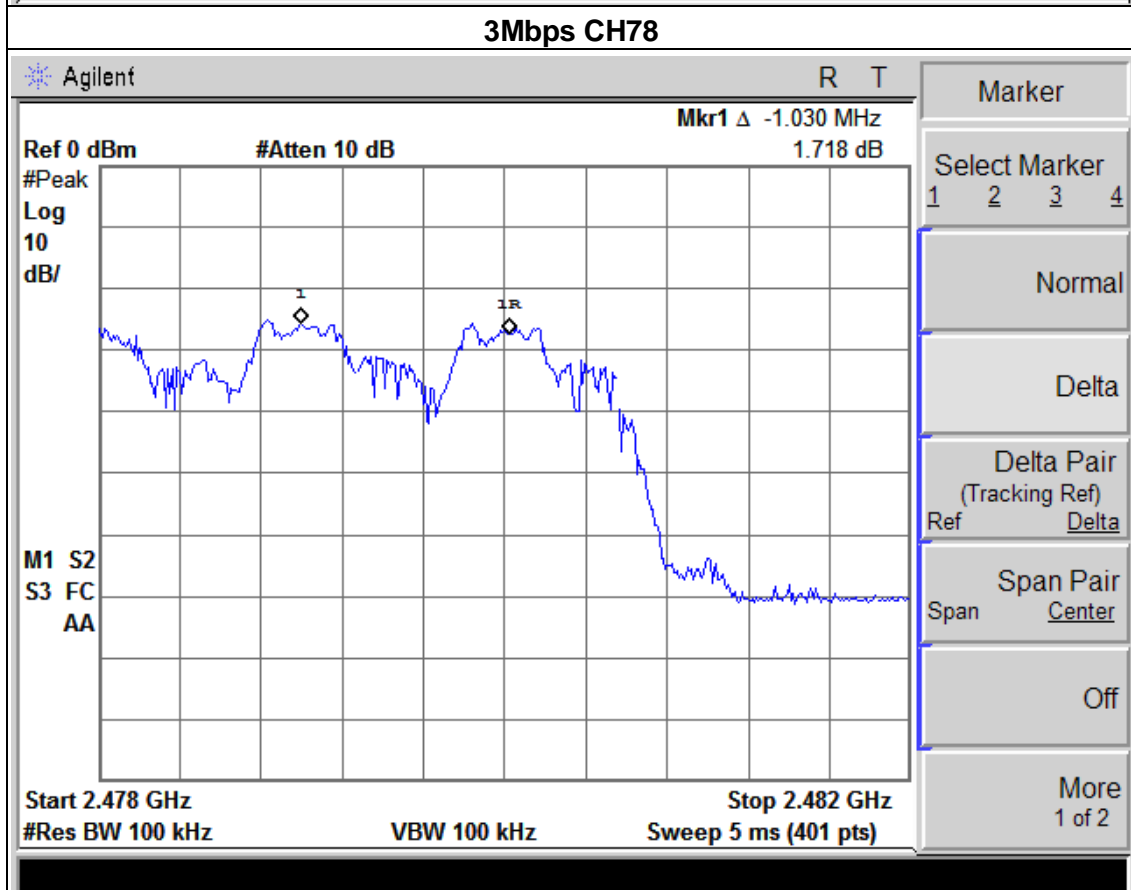
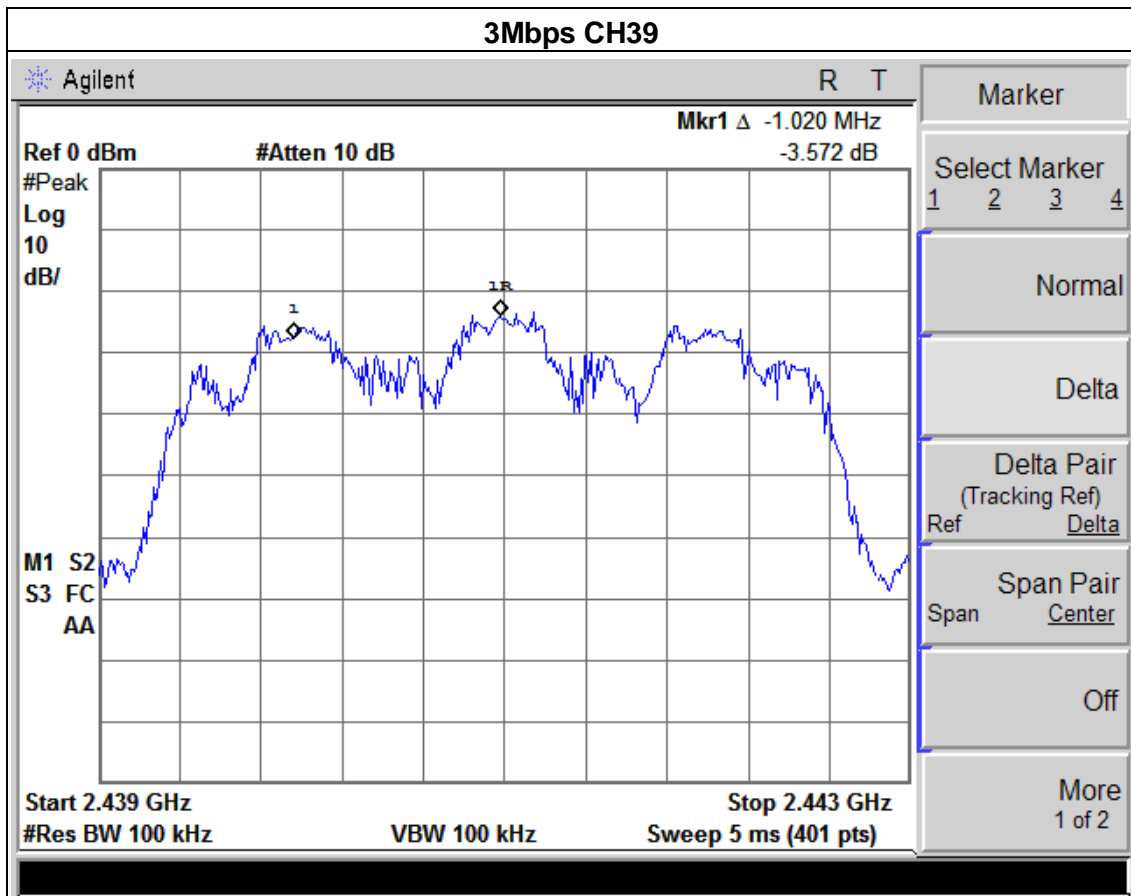

## 7. BANDWIDTH TEST

### 7.1 APPLIED PROCEDURES / LIMIT

FCC Part15 (15.247) , Subpart C				
Section	Test Item	Limit	Frequency Range (MHz)	Result
15.247 (a)(1)	Bandwidth	(20dB bandwidth)	2400-2483.5	PASS

Spectrum Parameter	Setting
Attenuation	Auto
Span Frequency	> Measurement Bandwidth or Channel Separation
RB	30 kHz (20dB Bandwidth) / 30 kHz (Channel Separation)
VB	100 kHz (20dB Bandwidth) / 30 kHz (Channel Separation)
Detector	Peak
Trace	Max Hold
Sweep Time	Auto

#### 7.1.1 TEST PROCEDURE

- a. The EUT was directly connected to the spectrum analyzer and antenna output port as show in the block diagram below,
- b. Spectrum Setting : RBW= 30KHz, VBW=100KHz, Sweep time = Auto.

#### 7.1.2 DEVIATION FROM STANDARD

No deviation.

#### 7.1.3 TEST SETUP

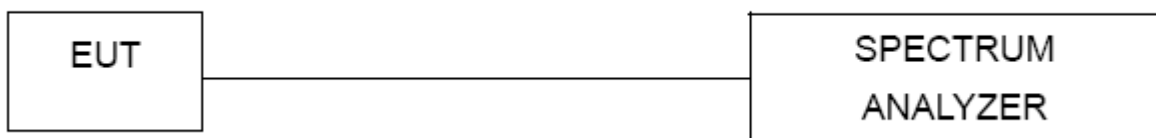

#### 7.1.4 EUT OPERATION CONDITIONS

The EUT tested system was configured as the statements of 2.4 Unless otherwise a special operating condition is specified in the follows during the testing.

### 7.1.5 TEST RESULTS

EUT :	Bluetooth Speaker	Model Name :	WD-S01
Temperature :	25 °C	Relative Humidity :	60%
Pressure :	1012 hPa	Test Voltage :	DC 5V from PC AC 120V/60Hz
Test Mode :	CH00 / CH39 /C78 for GFSK		

Frequency	20dB Bandwidth (kHz)	Result
2402 MHz	863.89	<b>PASS</b>
2441 MHz	858.76	<b>PASS</b>
2480 MHz	929.43	<b>PASS</b>

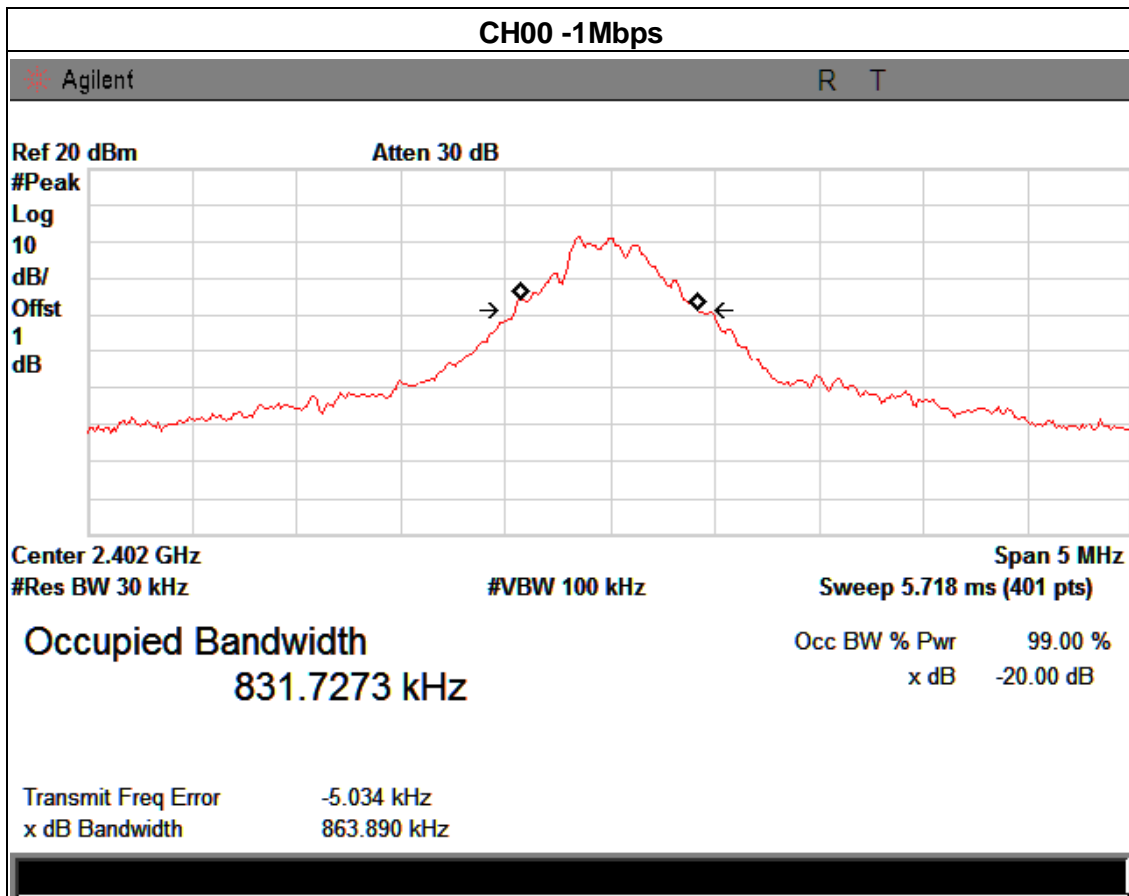

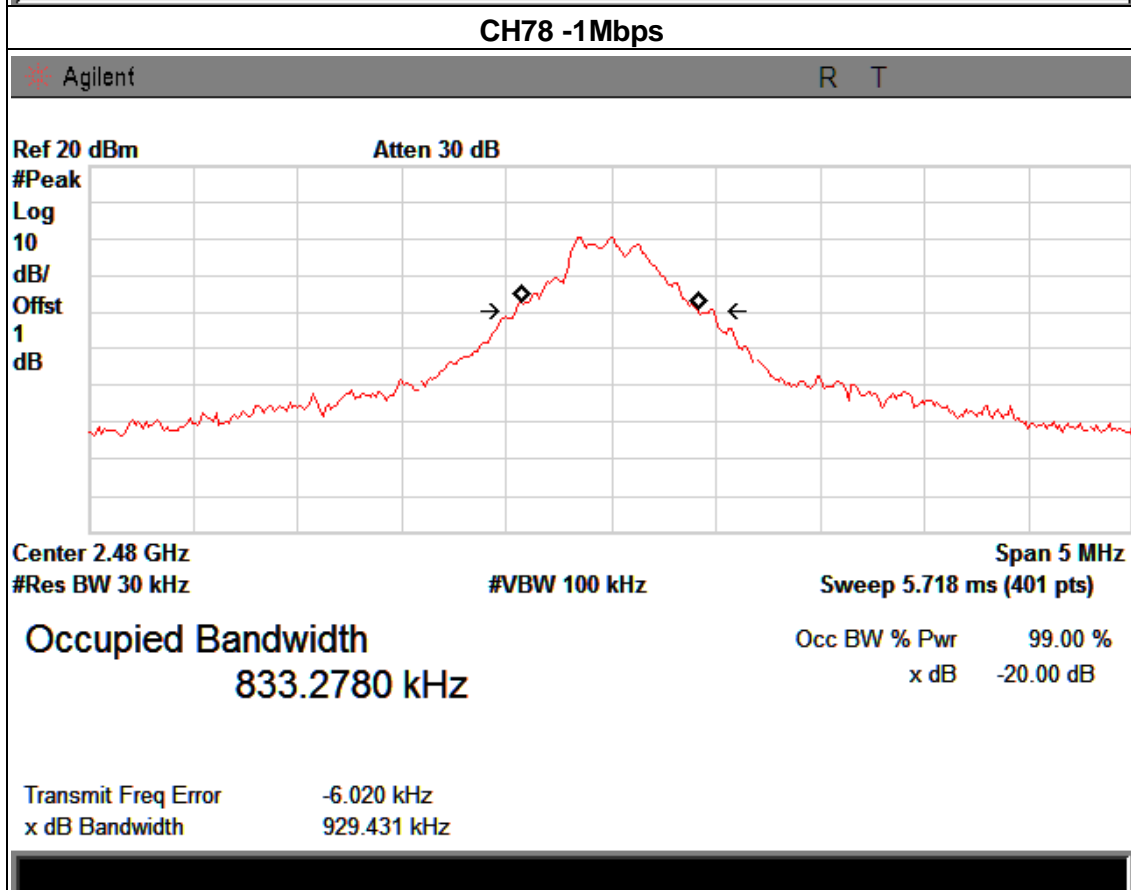
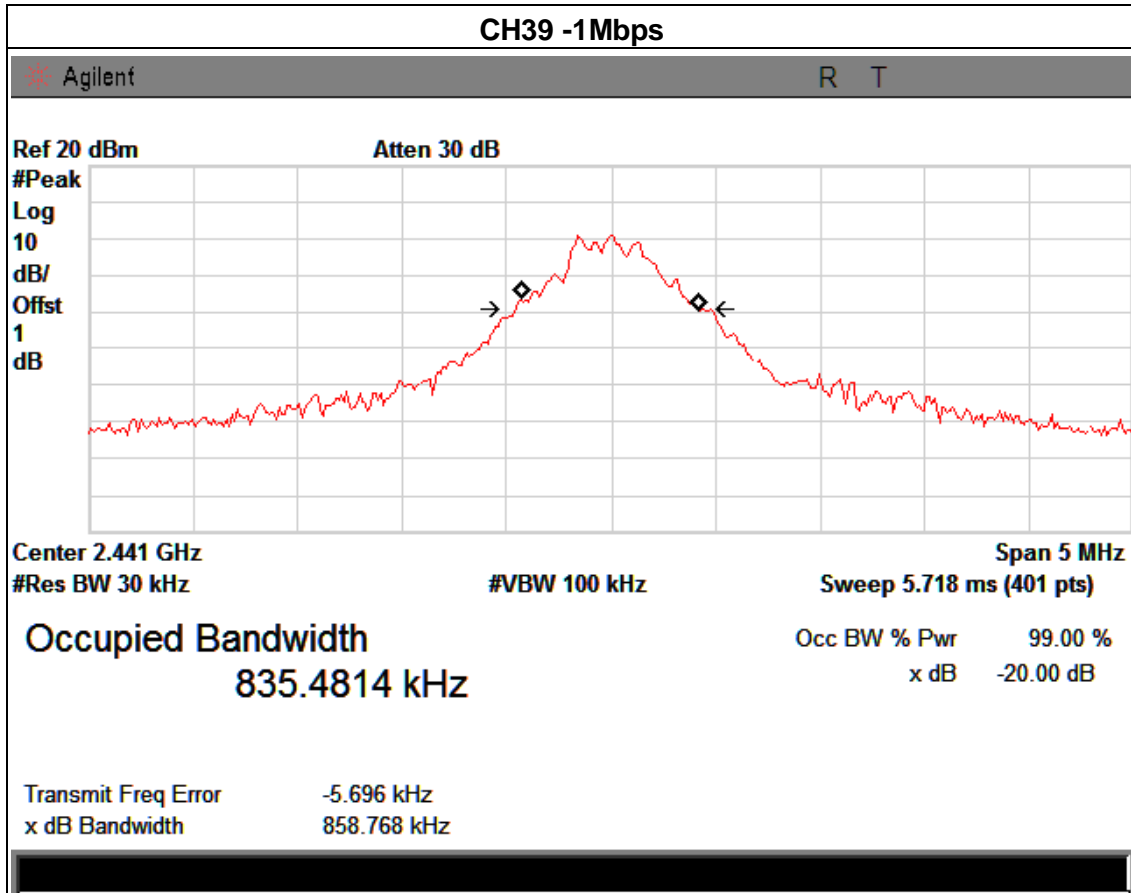

EUT :	Bluetooth Speaker	Model Name :	WD-S01
Temperature :	25 °C	Relative Humidity :	60%
Pressure :	1012 hPa	Test Voltage :	DC 5V from PC AC 120V/60Hz
Test Mode :	CH00 / CH39 /C78 for 8-DPSK		

Frequency	20dB Bandwidth (kHz)	Result
2402 MHz	1.224	<b>PASS</b>
2441 MHz	1.222	<b>PASS</b>
2480 MHz	1.219	<b>PASS</b>

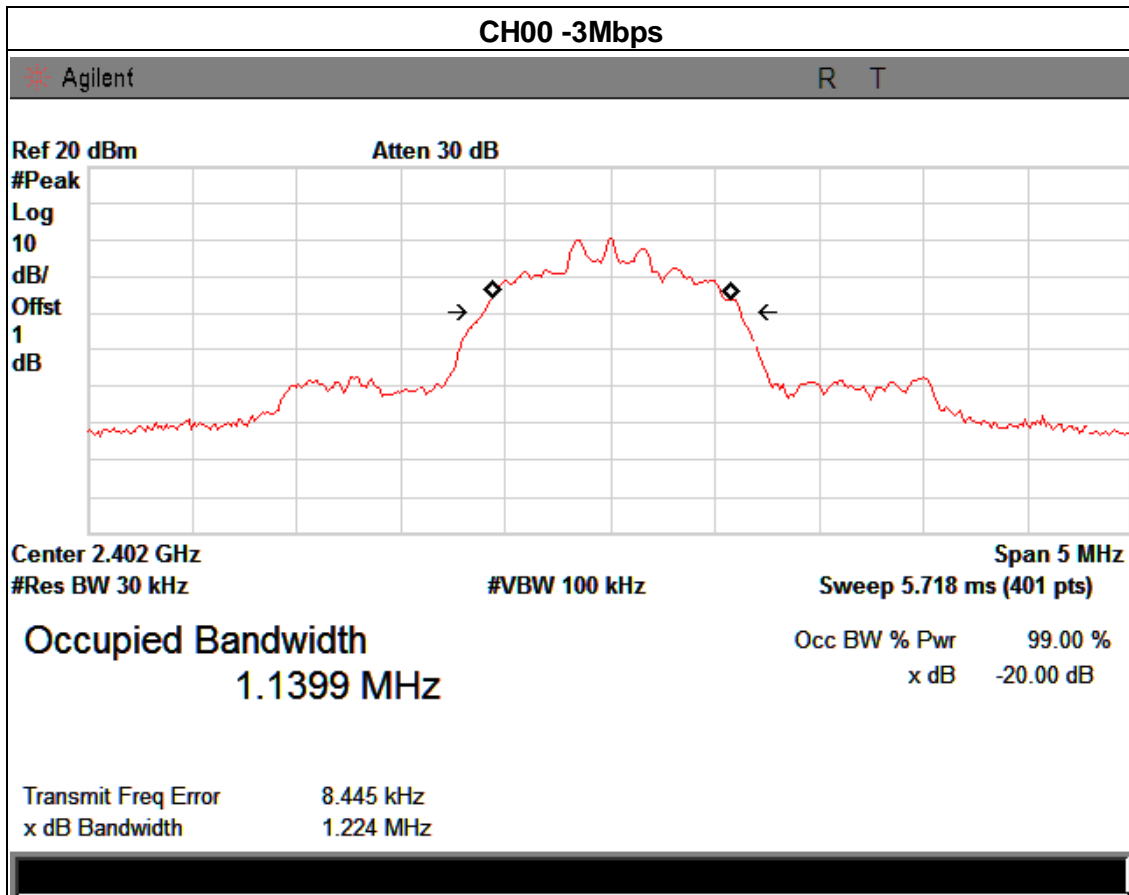



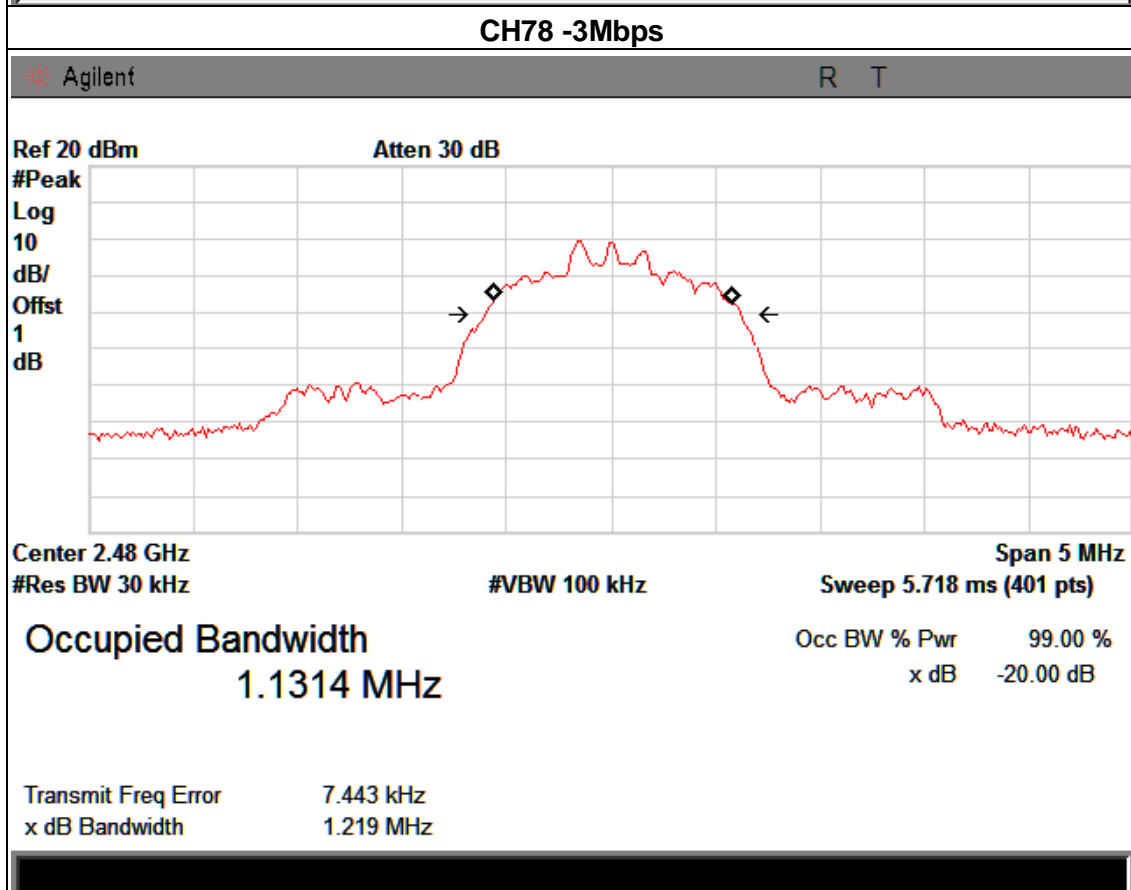
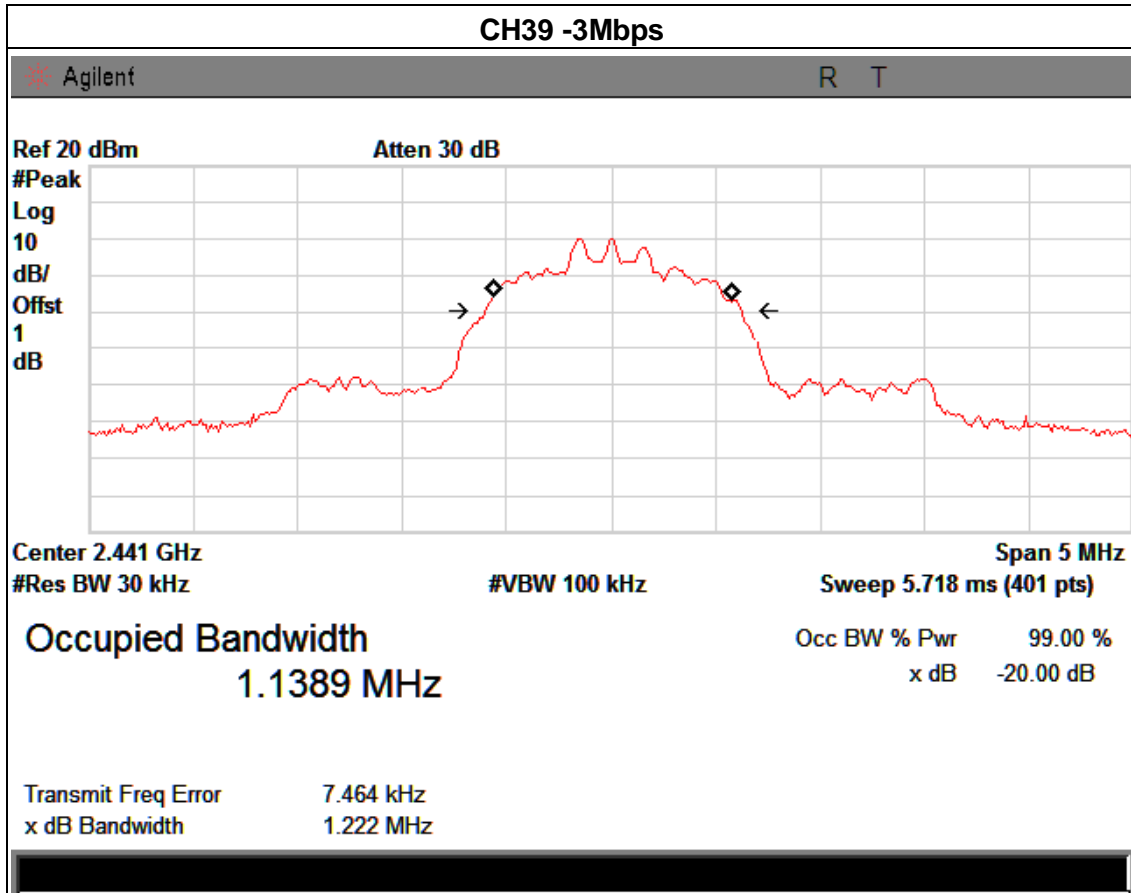

**8. PEAK OUTPUT POWER TEST**

**8.1 APPLIED PROCEDURES / LIMIT**

FCC Part15 (15.247) , Subpart C				
Section	Test Item	Limit	Frequency Range (MHz)	Result
15.247 (b)(i)	Peak Output Power	1 w or 30dBm for GFSK 0.125W or 21dBm for EDR	2400-2483.5	PASS

**8.1.1 TEST PROCEDURE**

- a. The EUT was directly connected to the Power meter

**8.1.2 DEVIATION FROM STANDARD**

No deviation.

**8.1.3 TEST SETUP**



**8.1.4 EUT OPERATION CONDITIONS**

The EUT tested system was configured as the statements of 2.4 Unless otherwise a special operating condition is specified in the follows during the testing.

**8.1.5 TEST RESULTS**

EUT :	Bluetooth Speaker	Model Name :	WD-S01
Temperature :	25 °C	Relative Humidity :	60%
Pressure :	1012 hPa	Test Voltage :	DC 5V from PC AC 120V/60Hz
Test Mode :	CH00/ CH39 /CH78 (1Mbps Mode) for GFSK		

Test Channel	Frequency (MHz)	Peak Output Power (dBm)	LIMIT (dBm)	Result
CH00	2402	2.65	30	PASS
CH39	2441	2.43	30	PASS
CH78	2480	2.39	30	PASS

EUT :	Bluetooth Speaker	Model Name :	WD-S01
Temperature :	25 °C	Relative Humidity :	60%
Pressure :	1012 hPa	Test Voltage :	DC 5V from PC AC 120V/60Hz
Test Mode :	CH00/ CH39 /CH78 (3 Mbps Mode) for 8-DPSK		

Test Channel	Frequency (MHz)	Peak Output Power (dBm)	LIMIT (dBm)	Result
CH00	2402	2.32	21	PASS
CH39	2441	2.26	21	PASS
CH78	2480	2.19	21	PASS

## **9. ANTENNA REQUIREMENT**

### **9.1 STANDARD REQUIREMENT**

15.203 requirement: For intentional device, according to 15.203: an intentional radiator shall be designed to ensure that no antenna other than that furnished by the responsible party shall be used with the device.

### **9.2 EUT ANTENNA**

The EUT antenna is PCB Antenna. It complies with the standard requirement.

**10. EUT TEST PHOTO**

**Radiated Measurement Photos**



**Conduction Measurement Photos**

