

TEST REPORT

Product : Mini bluetooth speaker
Trade mark : N/A
Model/Type reference : BS100, BS200
Serial Number : N/A
Report Number : EED32L00364701
FCC ID : 2AAPS-BS100BS200
Date of Issue: : Dec. 25, 2019
Test Standards : 47 CFR Part 15 Subpart C
Test result : PASS

Prepared for:

Shenzhen UEMade Technology CO.,Ltd
3F,3rd Building, Long Fa Industry Park,
1-1 Da Wan Road, Da Kang Zone,
Yuan Shan Street, Long Gang District,
Shen Zhen, Guang Dong Province, China

Prepared by:

Centre Testing International Group Co., Ltd.
Hongwei Industrial Zone, Bao'an 70 District,
Shenzhen, Guangdong, China
TEL: +86-755-3368 3668
FAX: +86-755-3368 3385

Tested By:

mark.chen.

Compiled by:

Sunlight Sun

Mark Chen

Sunlight Sun

Reviewed by:

Ware Xin

Approved by:

Kevin Yang

Ware Xin

Kevin Yang

Date:

Dec. 25, 2019

Check No.: 2447622129



2 Version

Version No.	Date	Description
00	Dec. 25, 2019	Original

3 Test Summary

Test Item	Test Requirement	Test method	Result
Antenna Requirement	47 CFR Part 15, Subpart C Section 15.203/15.247 (c)	ANSI C63.10-2013	PASS
AC Power Line Conducted Emission	47 CFR Part 15, Subpart C Section 15.207	ANSI C63.10-2013	PASS
Conducted Peak Output Power	47 CFR Part 15, Subpart C Section 15.247 (b)(1)	ANSI C63.10-2013	PASS
20dB Occupied Bandwidth	47 CFR Part 15, Subpart C Section 15.247 (a)(1)	ANSI C63.10-2013	PASS
Carrier Frequencies Separation	47 CFR Part 15, Subpart C Section 15.247 (a)(1)	ANSI C63.10-2013	PASS
Hopping Channel Number	47 CFR Part 15, Subpart C Section 15.247 (b)	ANSI C63.10-2013	PASS
Dwell Time	47 CFR Part 15, Subpart C Section 15.247 (a)(1)	ANSI C63.10-2013	PASS
Pseudorandom Frequency Hopping Sequence	47 CFR Part 15, Subpart C Section 15.247(b)(4)&TCB Exclusion List (7 July 2002)	ANSI C63.10-2013	PASS
RF Conducted Spurious Emissions	47 CFR Part 15, Subpart C Section 15.247(d)	ANSI C63.10-2013	PASS
Radiated Spurious emissions	47 CFR Part 15, Subpart C Section 15.205/15.209	ANSI C63.10-2013	PASS
Restricted bands around fundamental frequency (Radiated Emission)	47 CFR Part 15Subpart C Section 15.205/15.209	ANSI C63.10-2013	PASS

Remark:

Test according to ANSI C63.4-2014 & ANSI C63.10-2013.

The tested samples and the sample information are provided by the client.

Model No.:BS100, BS200

Only the model BS100 was tested, Their electrical circuit design, layout, components used and internal wiring are identical, Only the appearance and color are difference.

4 Content

1 COVER PAGE	1
2 VERSION	2
3 TEST SUMMARY	3
4 CONTENT	4
5 TEST REQUIREMENT	5
5.1 Test setup.....	5
5.1.1 For Conducted test setup.....	5
5.1.2 For Radiated Emissions test setup.....	6
5.1.3 For Conducted Emissions test setup.....	6
5.2 Test Environment.....	7
5.3 Test Condition.....	7
6 GENERAL INFORMATION	8
6.1 Client Information.....	8
6.2 General Description of EUT.....	8
6.3 Product Specification subjective to this standard.....	9
6.4 Description of Support Units.....	10
6.5 Test Location.....	10
6.6 Abnormalities from Standard Conditions.....	10
6.7 Other Information Requested by the Customer.....	10
6.8 Measurement Uncertainty(95% confidence levels, k=2).....	10
7 EQUIPMENT LIST	11
8 RADIO TECHNICAL REQUIREMENTS SPECIFICATION	14
EUT DUTY CYCLE	15
Appendix A): 20dB Occupied Bandwidth.....	16
Appendix B): Carrier Frequency Separation.....	25
Appendix C): Dwell Time.....	30
Appendix D): Hopping Channel Number.....	35
Appendix E): Conducted Peak Output Power.....	38
Appendix F): Band-edge for RF Conducted Emissions.....	43
Appendix G): RF Conducted Spurious Emissions.....	49
Appendix H) Pseudorandom Frequency Hopping Sequence.....	60
Appendix I) Antenna Requirement.....	61
Appendix J) AC Power Line Conducted Emission.....	62
Appendix K) Restricted bands around fundamental frequency (Radiated).....	65
Appendix L) Radiated Spurious Emissions.....	82
PHOTOGRAPHS OF TEST SETUP	87
PHOTOGRAPHS OF EUT CONSTRUCTIONAL DETAILS	90

5 Test Requirement

5.1 Test setup

5.1.1 For Conducted test setup

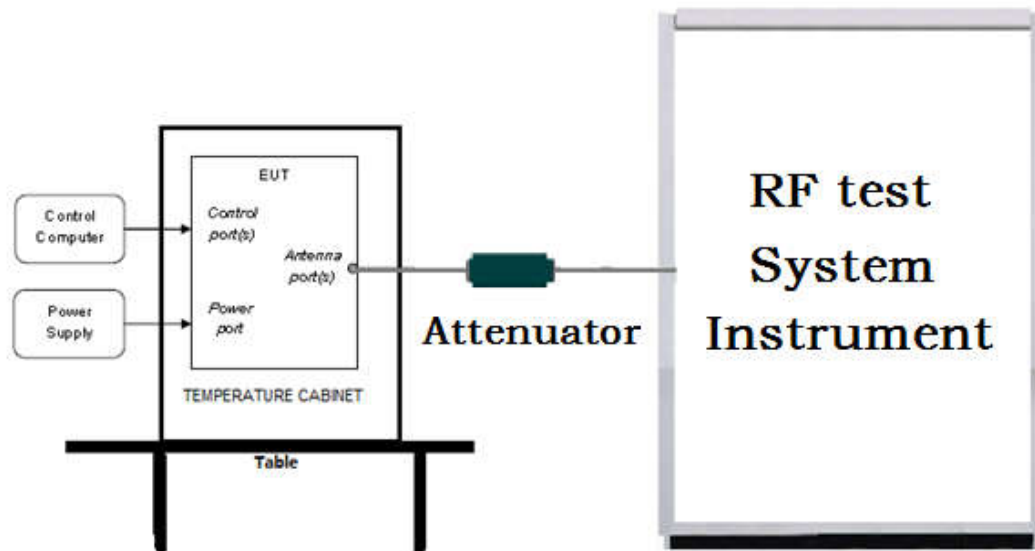

5.1.2 For Radiated Emissions test setup

Radiated Emissions setup:

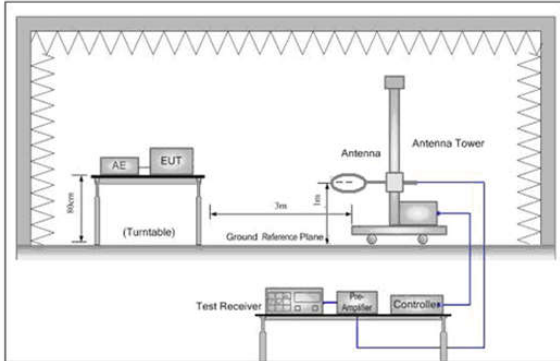

Figure 1. Below 30MHz

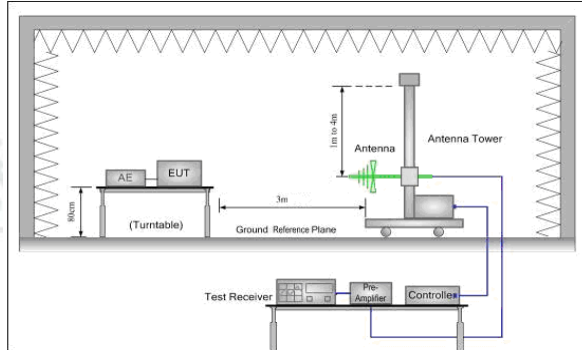

Figure 2. 30MHz to 1GHz

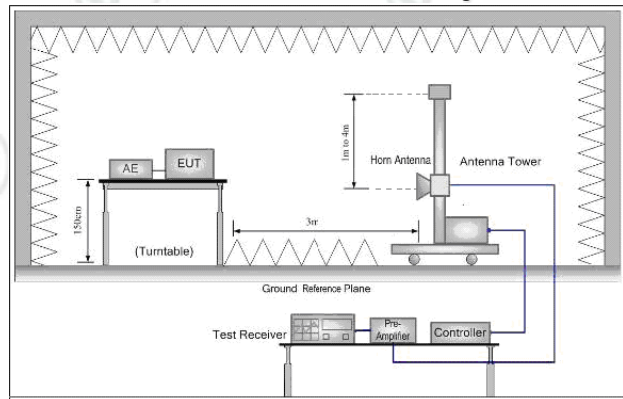
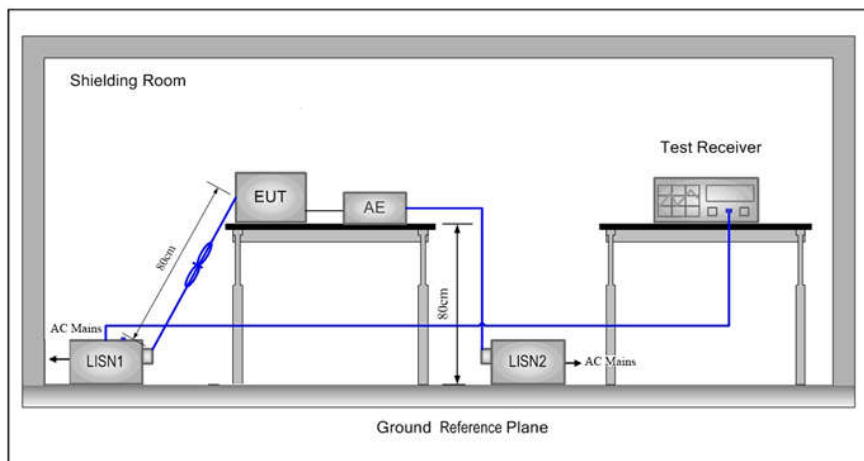

Figure 3. Above 1GHz

5.1.3 For Conducted Emissions test setup

Conducted Emissions setup



5.2 Test Environment

Operating Environment:	
Temperature:	24.0 °C
Humidity:	55 % RH
Atmospheric Pressure:	1010mbar

5.3 Test Condition

Test Mode	Tx/Rx	RF Channel		
		Low(L)	Middle(M)	High(H)
GFSK/π/4DQPSK/ 8DPSK(DH1,DH3,DH5)	2402MHz ~2480 MHz	Channel 1	Channel 40	Channel79
		2402MHz	2441MHz	2480MHz

6 General Information

6.1 Client Information

Applicant:	Shenzhen UEMade Technology CO., Ltd
Address of Applicant:	3F,3rd Building, Long Fa Industry Park, 1-1 Da Wan Road, Da Kang Zone, Yuan Shan Street, Long Gang District, Shen Zhen, Guang Dong Province, China
Manufacturer:	Shenzhen UEMade Technology CO., Ltd
Address of Manufacturer:	3F,3rd Building, Long Fa Industry Park, 1-1 Da Wan Road, Da Kang Zone, Yuan Shan Street, Long Gang District, Shen Zhen, Guang Dong Province, China
Factory:	Shenzhen UEMade Technology CO., Ltd
Address of Factory:	3F,3rd Building, Long Fa Industry Park, 1-1 Da Wan Road, Da Kang Zone, Yuan Shan Street, Long Gang District, Shen Zhen, Guang Dong Province, China

6.2 General Description of EUT

Product Name:	Mini bluetooth speaker
Model No.(EUT):	BS100, BS200
Test Model No.:	BS100
Trade mark:	N/A
EUT Supports Radios application	BT 5.0 Single mode, 2402MHz to 2480MHz
Power Supply:	Battery Li-ion Battery: DC 5V
Sample Received Date:	Dec. 02, 2019
Sample tested Date:	Dec. 02, 2019 to Dec. 19, 2019

6.3 Product Specification subjective to this standard

Operation Frequency:	2402MHz~2480MHz						
Bluetooth Version:	5.0						
Modulation Type:	GFSK, $\pi/4$ DQPSK, 8DPSK						
Number of Channel:	79						
Hopping Channel Type:	Adaptive Frequency Hopping systems						
Test Power Grade:	DH5: 7; 2DH5: 6; 3DH5: 6						
Test Software of EUT:	BT_Tool V1.0.5						
Antenna Type:	PCB Antenna						
Antenna Gain:	0dbi						
Test Voltage:	DC 5V						
Operation Frequency each of channel							
Channel	Frequency	Channel	Frequency	Channel	Frequency	Channel	Frequency
1	2402MHz	21	2422MHz	41	2442MHz	61	2462MHz
2	2403MHz	22	2423MHz	42	2443MHz	62	2463MHz
3	2404MHz	23	2424MHz	43	2444MHz	63	2464MHz
4	2405MHz	24	2425MHz	44	2445MHz	64	2465MHz
5	2406MHz	25	2426MHz	45	2446MHz	65	2466MHz
6	2407MHz	26	2427MHz	46	2447MHz	66	2467MHz
7	2408MHz	27	2428MHz	47	2448MHz	67	2468MHz
8	2409MHz	28	2429MHz	48	2449MHz	68	2469MHz
9	2410MHz	29	2430MHz	49	2450MHz	69	2470MHz
10	2411MHz	30	2431MHz	50	2451MHz	70	2471MHz
11	2412MHz	31	2432MHz	51	2452MHz	71	2472MHz
12	2413MHz	32	2433MHz	52	2453MHz	72	2473MHz
13	2414MHz	33	2434MHz	53	2454MHz	73	2474MHz
14	2415MHz	34	2435MHz	54	2455MHz	74	2475MHz
15	2416MHz	35	2436MHz	55	2456MHz	75	2476MHz
16	2417MHz	36	2437MHz	56	2457MHz	76	2477MHz
17	2418MHz	37	2438MHz	57	2458MHz	77	2478MHz
18	2419MHz	38	2439MHz	58	2459MHz	78	2479MHz
19	2420MHz	39	2440MHz	59	2460MHz	79	2480MHz
20	2421MHz	40	2441MHz	60	2461MHz		

6.4 Description of Support Units

Associated equipment name		Manufacture	model	S/N serial number	Supplied by	Certification
D	Notebook	DELL	DELL 3490	D245DX2	DELL	CE&FCC

6.5 Test Location

All tests were performed at:

Centre Testing International Group Co., Ltd.

Building C, Hongwei Industrial Park Block 70, Bao'an District, Shenzhen, China

Telephone: +86 (0) 755 3368 3668 Fax: +86 (0) 755 3368 3385

No tests were sub-contracted.

FCC Designation No.: CN1164

None.

6.6 Abnormalities from Standard Conditions

None.

6.7 Other Information Requested by the Customer

None.

6.8 Measurement Uncertainty(95% confidence levels, k=2)

No.	Item	Measurement Uncertainty
1	Radio Frequency	7.9×10^{-8}
2	RF power, conducted	0.46dB (30MHz-1GHz)
		0.55dB (1GHz-18GHz)
3	Radiated Spurious emission test	4.3dB (30MHz-1GHz)
		4.5dB (1GHz-12.75GHz)
4	Conduction emission	3.5dB (9kHz to 150kHz)
		3.1dB (150kHz to 30MHz)
5	Temperature test	0.64°C
6	Humidity test	3.8%
7	DC power voltages	0.026%

7 Equipment List

RF test system					
Equipment	Manufacturer	Mode No.	Serial Number	Cal. Date (mm-dd-yyyy)	Cal. Due date (mm-dd-yyyy)
Spectrum Analyzer	Keysight	N9010A	MY54510339	03-01-2019	02-29-2020
Signal Generator	Keysight	N5182B	MY53051549	03-01-2019	02-29-2020
Temperature/ Humidity Indicator	biaozhi	HM10	1804186	07-26-2019	07-25-2020
High-pass filter	Sinoscite	FL3CX03WG18N M12-0398-002	---	01-09-2019	01-08-2020
High-pass filter	MICRO- TRONICS	SPA-F-63029-4	---	01-09-2019	01-08-2020
DC Power	Keysight	E3642A	MY56376072	03-01-2019	02-29-2020
PC-1	Lenovo	R4960d	---	03-01-2019	02-29-2020
BT&WI-FI Automatic control	R&S	OSP120	101374	03-01-2019	02-29-2020
RF control unit	JS Tonscend	JS0806-2	158060006	03-01-2019	02-29-2020
BT&WI-FI Automatic test software	JS Tonscend	JS1120-3	---	03-01-2019	02-29-2020

Conducted disturbance Test					
Equipment	Manufacturer	Model No.	Serial Number	Cal. date (mm-dd-yyyy)	Cal. Due date (mm-dd-yyyy)
Receiver	R&S	ESCI	100435	05-20-2019	05-19-2020
Temperature/ Humidity Indicator	Defu	TH128	/	06-14-2019	06-13-2020
LISN	R&S	ENV216	100098	05-08-2019	05-07-2020
Barometer	changchun	DYM3	1188	06-20-2019	06-19-2020

3M Semi/full-anechoic Chamber					
Equipment	Manufacturer	Model No.	Serial Number	Cal. date (mm-dd-yyyy)	Cal. Due date (mm-dd-yyyy)
3M Chamber & Accessory Equipment	TDK	SAC-3	---	05-24-2019	05-23-2022
TRILOG Broadband Antenna	Schwarzbeck	VULB9163	9163-618	07-26-2019	07-25-2020
Loop Antenna	Schwarzbeck	FMZB 1519B	1519B- 076	04-25-2018	04-24-2021
Receiver	R&S	ESCI7	100938- 003	10-21-2019	10-20-2020
Multi device Controller	maturu	NCD/070/107 11112	---	01-09-2019	01-08-2020
Temperature/ Humidity Indicator	Shanghai qixiang	HM10	1804298	07-26-2019	07-25-2020
Cable line	Fulai(7M)	SF106	5219/6A	01-09-2019	01-08-2020
Cable line	Fulai(6M)	SF106	5220/6A	01-09-2019	01-08-2020
Cable line	Fulai(3M)	SF106	5216/6A	01-09-2019	01-08-2020
Cable line	Fulai(3M)	SF106	5217/6A	01-09-2019	01-08-2020

3M full-anechoic Chamber					
Equipment	Manufacturer	Model No.	Serial Number	Cal. date (mm-dd-yyyy)	Cal. Due date (mm-dd-yyyy)
RSE Automatic test software	JS Tonscend	JS36-RSE	10166	06-19-2019	06-18-2020
Receiver	Keysight	N9038A	MY57290136	03-27-2019	03-26-2020
Spectrum Analyzer	Keysight	N9020B	MY57111112	03-27-2019	03-26-2020
Spectrum Analyzer	Keysight	N9030B	MY57140871	03-27-2019	03-26-2020
TRILOG Broadband Antenna	Schwarzbeck	VULB 9163	9163-1148	04-25-2018	04-24-2021
Horn Antenna	Schwarzbeck	BBHA 9170	9170-832	04-25-2018	04-24-2021
Horn Antenna	ETS-LINDGREN	3117	00057407	07-10-2018	07-09-2021
Preamplifier	EMCI	EMC184055SE	980596	05-22-2019	5-21-2020
Preamplifier	EMCI	EMC001330	980563	05-08-2019	05-07-2020
Preamplifier	JS Tonscend	980380	EMC051845 SE	01-16-2019	01-15-2020
Temperature/ Humidity Indicator	biaozhi	GM1360	EE1186631	04-30-2019	04-29-2020
Fully Anechoic Chamber	TDK	FAC-3	---	01-17-2018	01-16-2021
Filter bank	JS Tonscend	JS0806-F	188060094	04-10-2018	04-09-2021
Cable line	Times	SFT205-NMSM-2.50M	394812-0001	01-09-2019	01-08-2020
Cable line	Times	SFT205-NMSM-2.50M	394812-0002	01-09-2019	01-08-2020
Cable line	Times	SFT205-NMSM-2.50M	394812-0003	01-09-2019	01-08-2020
Cable line	Times	SFT205-NMSM-2.50M	393495-0001	01-09-2019	01-08-2020
Cable line	Times	EMC104-NMNM-1000	SN160710	01-09-2019	01-08-2020
Cable line	Times	SFT205-NMSM-3.00M	394813-0001	01-09-2019	01-08-2020
Cable line	Times	SFT205-NMNM-1.50M	381964-0001	01-09-2019	01-08-2020
Cable line	Times	SFT205-NMSM-7.00M	394815-0001	01-09-2019	01-08-2020
Cable line	Times	HF160-KMKM-3.00M	393493-0001	01-09-2019	01-08-2020

8 Radio Technical Requirements Specification

Reference documents for testing:

No.	Identity	Document Title
1	FCC Part15C	Subpart C-Intentional Radiators
2	ANSI C63.10-2013	American National Standard for Testing Unlicensed Wireless Devices

Test Results List:

Test requirement	Test method	Test item	Verdict	Note
Part15C Section 15.247 (a)(1)	ANSI 63.10	20dB Occupied Bandwidth	PASS	Appendix A)
Part15C Section 15.247 (a)(1)	ANSI 63.10	Carrier Frequencies Separation	PASS	Appendix B)
Part15C Section 15.247 (a)(1)	ANSI 63.10	Dwell Time	PASS	Appendix C)
Part15C Section 15.247 (b)	ANSI 63.10	Hopping Channel Number	PASS	Appendix D)
Part15C Section 15.247 (b)(1)	ANSI 63.10	Conducted Peak Output Power	PASS	Appendix E)
Part15C Section 15.247(d)	ANSI 63.10	Band-edge for RF Conducted Emissions	PASS	Appendix F)
Part15C Section 15.247(d)	ANSI 63.10	RF Conducted Spurious Emissions	PASS	Appendix G)
Part15C Section 15.247 (a)(1)	ANSI 63.10	Pseudorandom Frequency Hopping Sequence	PASS	Appendix H)
Part15C Section 15.203/15.247 (c)	ANSI 63.10	Antenna Requirement	PASS	Appendix I)
Part15C Section 15.207	ANSI 63.10	AC Power Line Conducted Emission	PASS	Appendix j)
Part15C Section 15.205/15.209	ANSI 63.10	Restricted bands around fundamental frequency (Radiated) Emission)	PASS	Appendix k)
Part15C Section 15.205/15.209	ANSI 63.10	Radiated Spurious Emissions	PASS	Appendix L)

EUT DUTY CYCLE

Duty Cycle			
Configuration	TX ON(ms)	TX ALL(ms)	Duty Cycle(%)
BDR-1Mbps	2.888	3.75	77.01%
EDR-3Mbps	2.896	3.7504	77.2%

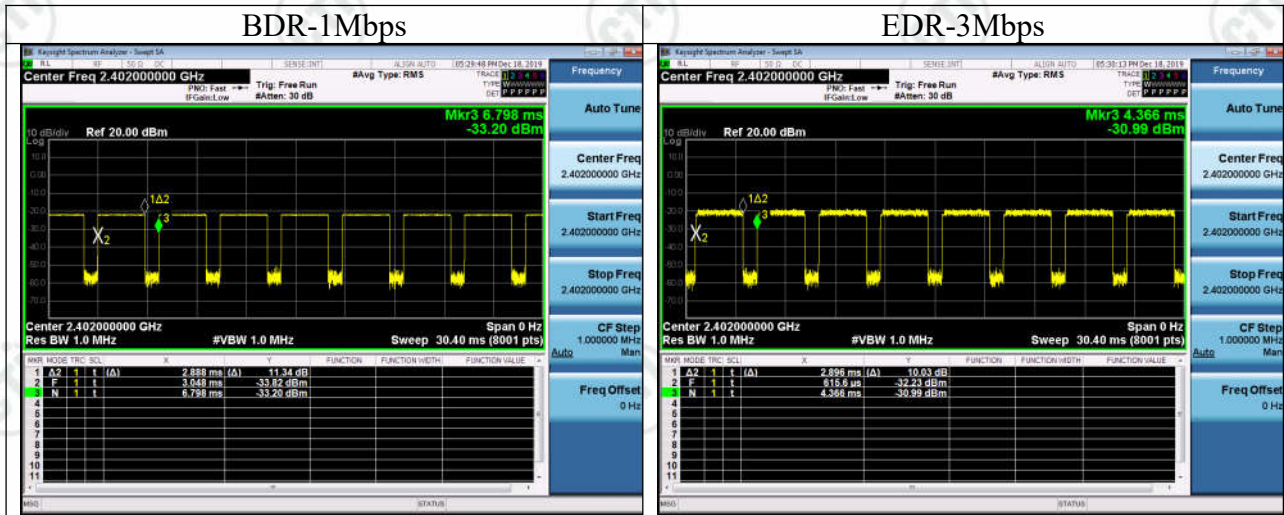

Appendix A): 20dB Occupied Bandwidth

Test Limit

According to §15.247(a) (1),

20 dB Bandwidth : For reporting purposes only.

Occupied Bandwidth(99%) : For reporting purposes only.

Test Procedure

Test method Refer as Section 8.1 and ANSI C63.10: 2013 clause 7.8.7,

1. The EUT RF output connected to the spectrum analyzer by RF cable.
2. Setting maximum power transmit of EUT
3. SA set RBW =100kHz, VBW = 300kHz and Detector = Peak, to measurement 20dB Bandwidth.
4. SA set RBW = 1% ~ 5% OBW, VBW = three times the RBW and Detector = Peak, to measurement 99% Bandwidth.
5. Measure and record the result of 20 dB Bandwidth and 99% Bandwidth. in the test report.

Test Setup

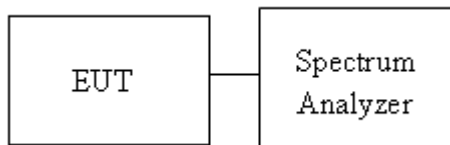

Test Result

Mode	Channel.	99% OBW [MHz]	Verdict
GFSK	LCH	0.75988	PASS
GFSK	MCH	0.75984	PASS
GFSK	HCH	0.77280	PASS
π /4DQPSK	LCH	1.2016	PASS
π /4DQPSK	MCH	1.1974	PASS
π /4DQPSK	HCH	1.1937	PASS
8DPSK	LCH	1.1952	PASS
8DPSK	MCH	1.1985	PASS
8DPSK	HCH	1.1921	PASS

Test Graph

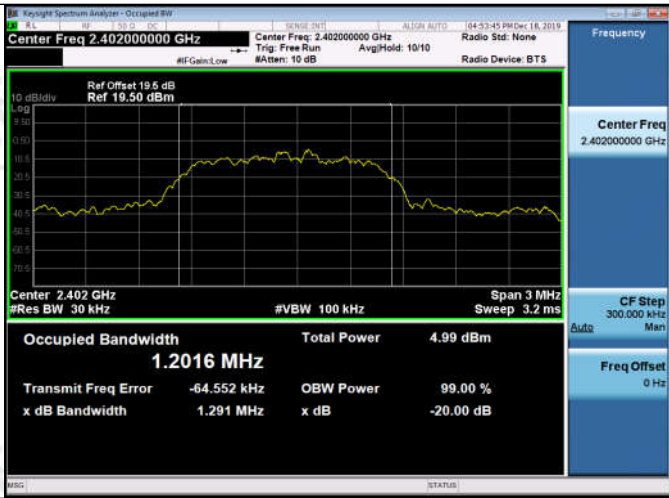
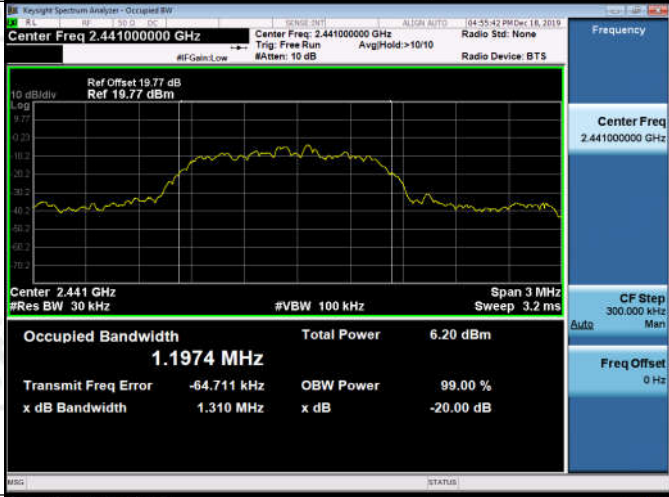
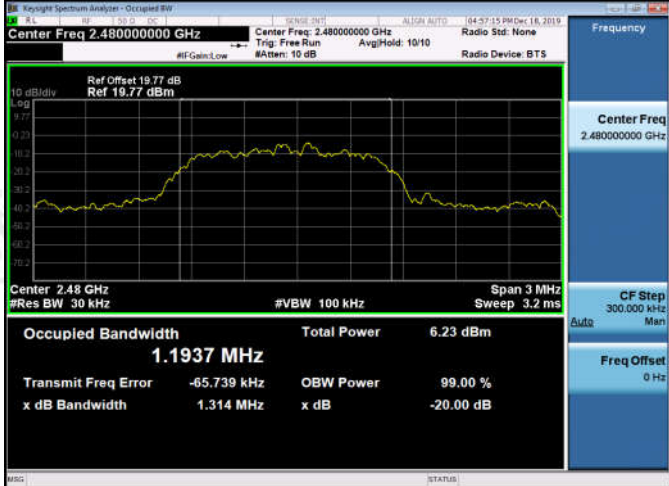

<p>$\pi/4$DQPSK/LCH</p>	 <p>KeySight Spectrum Analyzer - Occupied BW</p> <p>Center Freq: 2.402000000 GHz</p> <p>Ref Offset 19.5 dB Ref 19.50 dBm</p> <p>Center 2.402 GHz #Res BW 30 kHz</p> <p>Occupied Bandwidth 1.2016 MHz</p> <p>Total Power 4.99 dBm</p> <p>Transmit Freq Error -64.552 kHz</p> <p>x dB Bandwidth 1.291 MHz</p> <p>OBW Power 99.00 %</p> <p>x dB -20.00 dB</p>	<p>Frequency</p> <p>Center Freq 2.402000000 GHz</p> <p>CF Step 300.000 kHz</p> <p>Freq Offset 0 Hz</p>
<p>$\pi/4$DQPSK/MCH</p>	 <p>KeySight Spectrum Analyzer - Occupied BW</p> <p>Center Freq: 2.441000000 GHz</p> <p>Ref Offset 19.77 dB Ref 19.77 dBm</p> <p>Center 2.441 GHz #Res BW 30 kHz</p> <p>Occupied Bandwidth 1.1974 MHz</p> <p>Total Power 6.20 dBm</p> <p>Transmit Freq Error -64.711 kHz</p> <p>x dB Bandwidth 1.310 MHz</p> <p>OBW Power 99.00 %</p> <p>x dB -20.00 dB</p>	<p>Frequency</p> <p>Center Freq 2.441000000 GHz</p> <p>CF Step 300.000 kHz</p> <p>Freq Offset 0 Hz</p>
<p>$\pi/4$DQPSK/HCH</p>	 <p>KeySight Spectrum Analyzer - Occupied BW</p> <p>Center Freq: 2.480000000 GHz</p> <p>Ref Offset 19.77 dB Ref 19.77 dBm</p> <p>Center 2.48 GHz #Res BW 30 kHz</p> <p>Occupied Bandwidth 1.1937 MHz</p> <p>Total Power 6.23 dBm</p> <p>Transmit Freq Error -65.739 kHz</p> <p>x dB Bandwidth 1.314 MHz</p> <p>OBW Power 99.00 %</p> <p>x dB -20.00 dB</p>	<p>Frequency</p> <p>Center Freq 2.480000000 GHz</p> <p>CF Step 300.000 kHz</p> <p>Freq Offset 0 Hz</p>

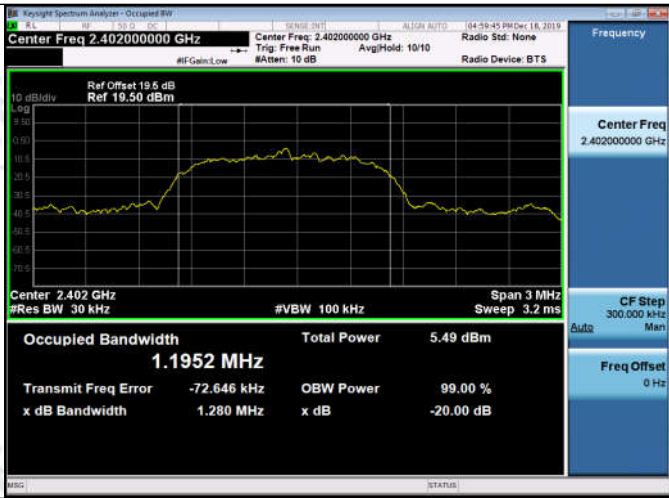
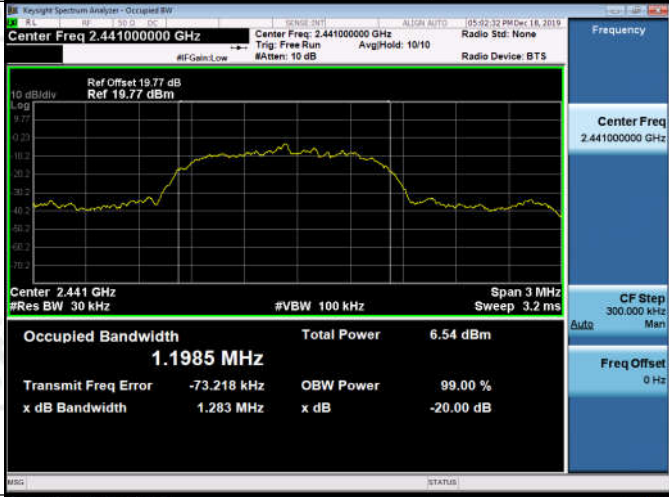
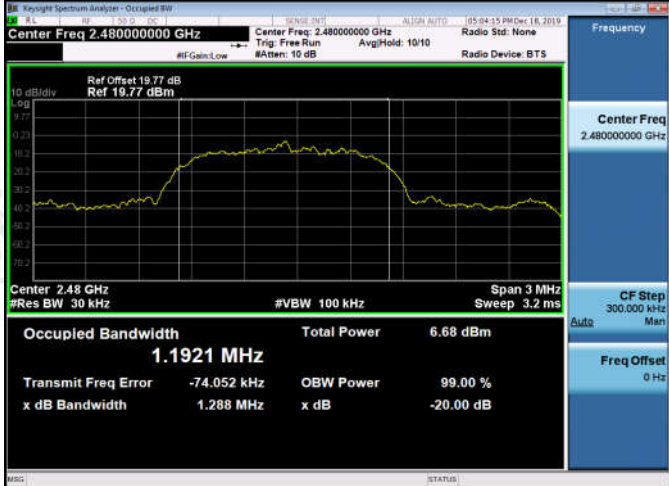
8DPSK/LCH	 <p>KeySight Spectrum Analyzer - Occupied BW</p> <p>Center Freq: 2.402000000 GHz, Center Freq: 2.402000000 GHz, Radio Std: None</p> <p>Ref Offset 19.5 dB, Ref 19.50 dBm</p> <p>Center 2.402 GHz, #Res BW 30 kHz, #VBW 100 kHz, Span 3 MHz, Sweep 3.2 ms</p> <p>Occupied Bandwidth: 1.1952 MHz, Total Power: 5.49 dBm</p> <p>Transmit Freq Error: -72.646 kHz, OBW Power: 99.00 %</p> <p>x dB Bandwidth: 1.280 MHz, x dB: -20.00 dB</p>	
8DPSK/MCH	 <p>KeySight Spectrum Analyzer - Occupied BW</p> <p>Center Freq: 2.441000000 GHz, Center Freq: 2.441000000 GHz, Radio Std: None</p> <p>Ref Offset 19.77 dB, Ref 19.77 dBm</p> <p>Center 2.441 GHz, #Res BW 30 kHz, #VBW 100 kHz, Span 3 MHz, Sweep 3.2 ms</p> <p>Occupied Bandwidth: 1.1985 MHz, Total Power: 6.54 dBm</p> <p>Transmit Freq Error: -73.218 kHz, OBW Power: 99.00 %</p> <p>x dB Bandwidth: 1.283 MHz, x dB: -20.00 dB</p>	
8DPSK/HCH	 <p>KeySight Spectrum Analyzer - Occupied BW</p> <p>Center Freq: 2.480000000 GHz, Center Freq: 2.480000000 GHz, Radio Std: None</p> <p>Ref Offset 19.77 dB, Ref 19.77 dBm</p> <p>Center 2.48 GHz, #Res BW 30 kHz, #VBW 100 kHz, Span 3 MHz, Sweep 3.2 ms</p> <p>Occupied Bandwidth: 1.1921 MHz, Total Power: 6.68 dBm</p> <p>Transmit Freq Error: -74.052 kHz, OBW Power: 99.00 %</p> <p>x dB Bandwidth: 1.288 MHz, x dB: -20.00 dB</p>	

Test Result

Mode	Channel.	20dB Bandwidth [MHz]	Verdict
GFSK	LCH	1.084	PASS
GFSK	MCH	1.082	PASS
GFSK	HCH	1.089	PASS
$\pi/4$ DQPSK	LCH	1.408	PASS
$\pi/4$ DQPSK	MCH	1.403	PASS
$\pi/4$ DQPSK	HCH	1.405	PASS
8DPSK	LCH	1.386	PASS
8DPSK	MCH	1.383	PASS
8DPSK	HCH	1.380	PASS

Test Graph

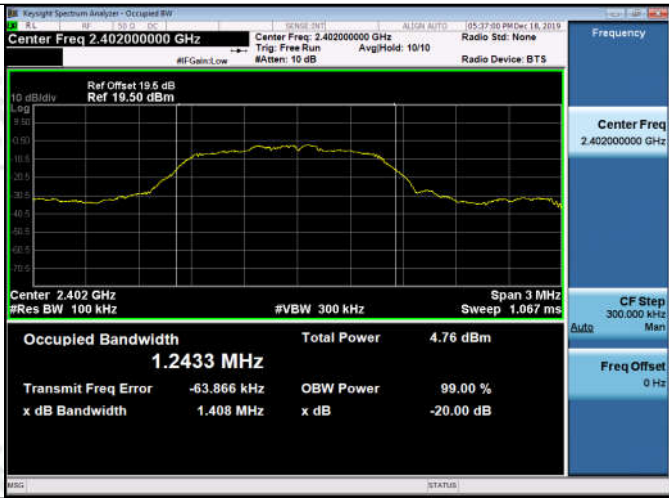
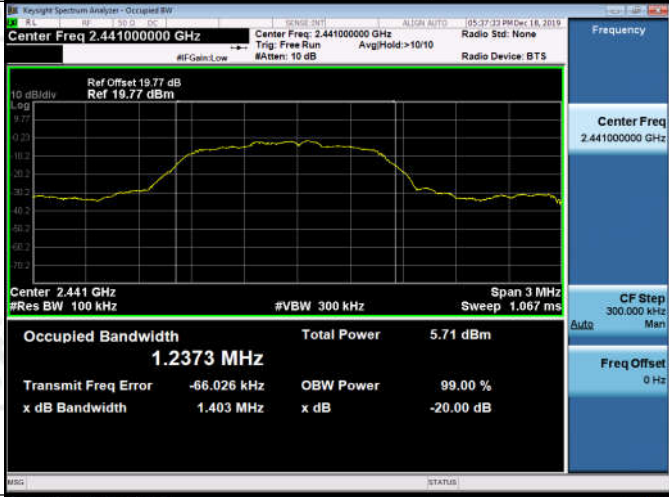

<p>$\pi/4$DQPSK/LCH</p>		
<p>$\pi/4$DQPSK/MCH</p>		
<p>$\pi/4$DQPSK/HCH</p>		

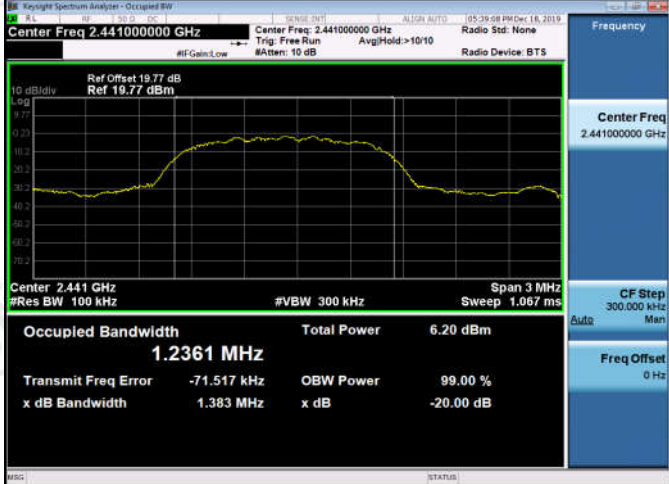
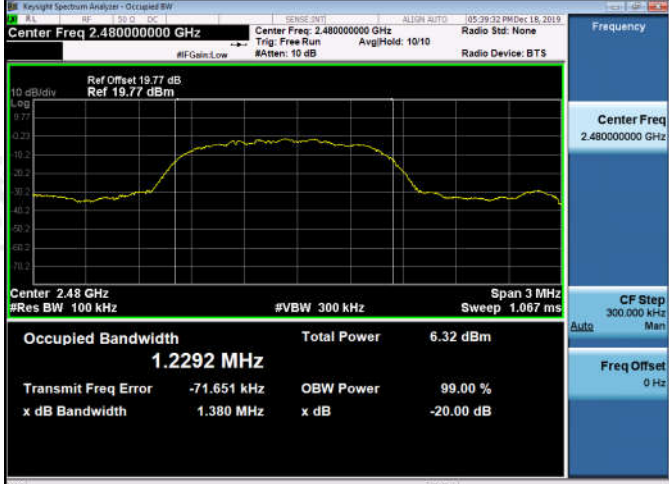
<p>8DPSK/LCH</p>	
<p>8DPSK/MCH</p>	
<p>8DPSK/HCH</p>	

Appendix B): Carrier Frequency Separation

Test Limit

According to §15.247(a)(1),

Alternatively, frequency hopping systems operating in the 2400-2483.5 MHz band may have hopping channel carrier frequencies that are separated by 25 kHz or two-thirds of the 20 dB bandwidth of the hopping channel, whichever is greater, provided the systems operate with an output power no greater than 125 mW.

Limit	> two-thirds of the 20 dB bandwidth
-------	-------------------------------------

Test Procedure

1. Place the EUT on the table and set it in transmitting mode.
2. EUT RF output port connected to the SA by RF cable.
3. Set the spectrum analyzer as RBW = 30kHz, VBW = 100kHz, Sweep = auto.
Max hold, mark 3 peaks of hopping channel and record the 3 peaks frequency

Test Setup

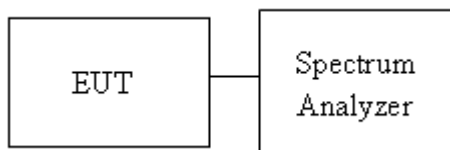

Result Table

Mode	Channel.	Carrier Frequency Separation [MHz]	Verdict
GFSK	LCH	1.100	PASS
GFSK	MCH	0.988	PASS
GFSK	HCH	1.110	PASS
$\pi/4$ DQPSK	LCH	1.006	PASS
$\pi/4$ DQPSK	MCH	1.098	PASS
$\pi/4$ DQPSK	HCH	1.122	PASS
8DPSK	LCH	1.164	PASS
8DPSK	MCH	1.160	PASS
8DPSK	HCH	1.148	PASS

Test Graph

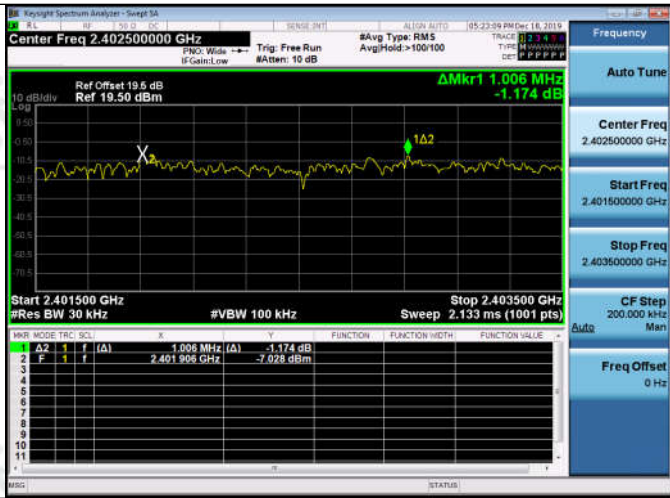
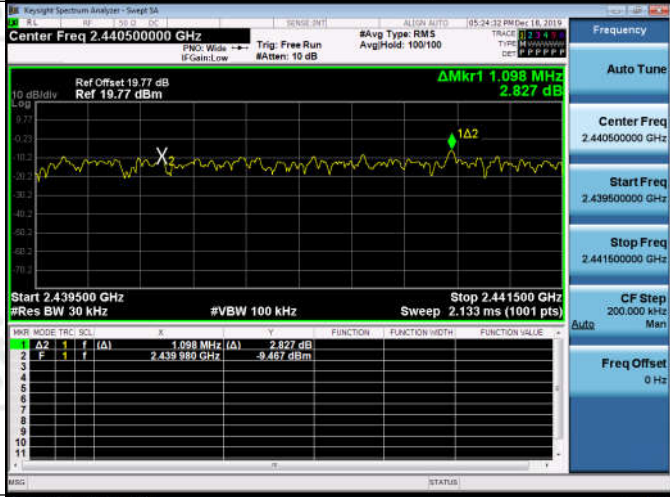
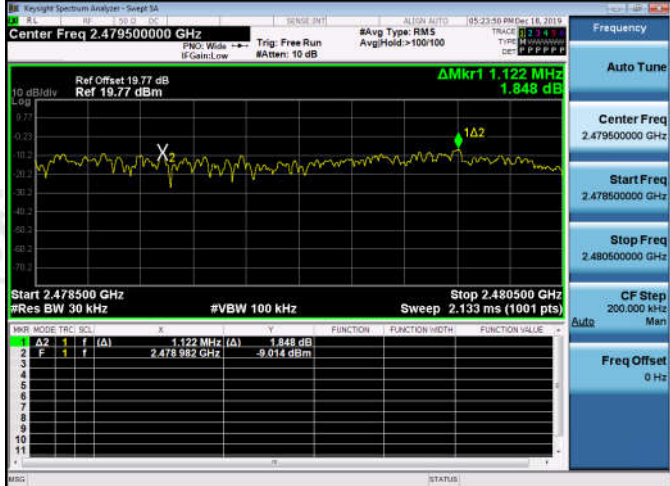

<p>$\pi/4$DQPSK/LCH</p>	
<p>$\pi/4$DQPSK/MCH</p>	
<p>$\pi/4$DQPSK/HCH</p>	

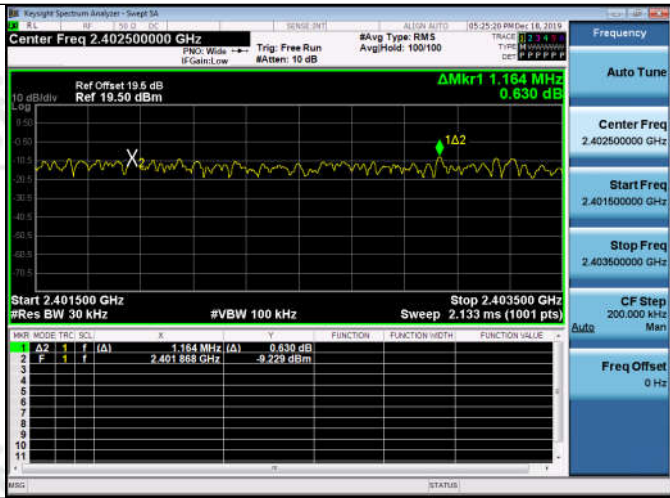
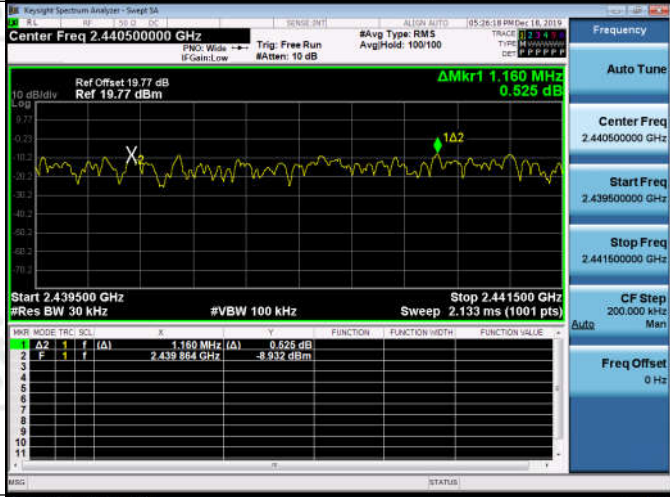
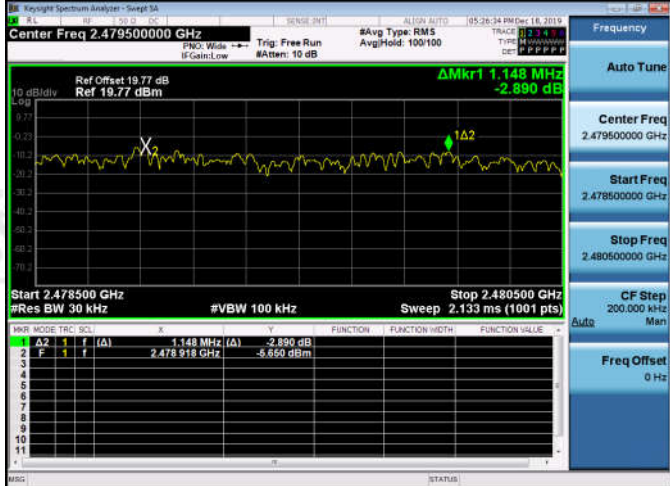
<p>8DPSK/LCH</p>	
<p>8DPSK/MCH</p>	
<p>8DPSK/HCH</p>	

Appendix C): Dwell Time

Test Limit

According to §15.247(a)(1)(iii),

The average time of occupancy on any channel shall not be greater than 0.4 seconds within a period of 0.4 seconds multiplied by the number of hopping channels employed.

Test Procedure

1. EUT RF output port connected to the SA by RF cable.
2. Set center frequency of spectrum analyzer = operating frequency.
3. *Set the spectrum analyzer as RBW=1MHz, VBW=3MHz, Sweep = auto*

Test Setup

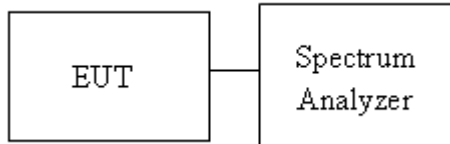

Result Table

Mode	Packet	Channel	Burst Width [ms/hop/ch]	Total Hops[hop*ch]	Dwell Time[s]	Duty Cycle [%]	Verdict
GFSK	DH1	LCH	0.390134	320	0.125	0.31	PASS
GFSK	DH1	MCH	0.390133	320	0.125	0.31	PASS
GFSK	DH1	HCH	0.390137	320	0.125	0.31	PASS
GFSK	DH3	LCH	1.6454	160	0.263	0.66	PASS
GFSK	DH3	MCH	1.6454	160	0.263	0.66	PASS
GFSK	DH3	HCH	1.6454	160	0.263	0.66	PASS
GFSK	DH5	LCH	2.8796	106.7	0.307	0.77	PASS
GFSK	DH5	MCH	2.8796	106.7	0.307	0.77	PASS
GFSK	DH5	HCH	2.8796	106.7	0.307	0.77	PASS

Test Graph

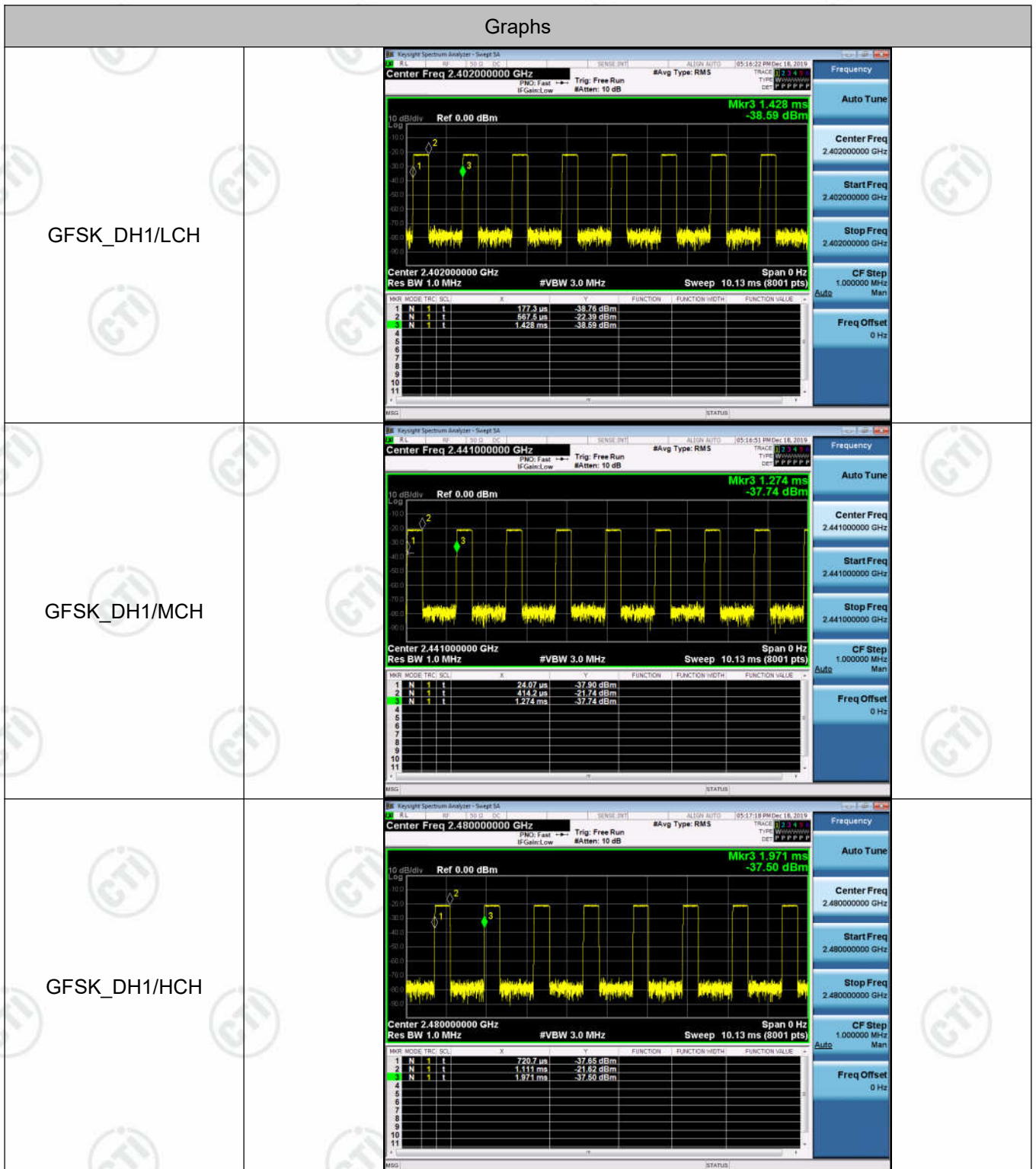

<p>GFSK_DH3/LCH</p>	
<p>GFSK_DH3/MCH</p>	
<p>GFSK_DH3/HCH</p>	

<p>GFSK_DH5/LCH</p>	 <p>Center Freq 2.402000000 GHz</p> <p>Center 2.402000000 GHz #VBW 3.0 MHz Sweep 73.60 ms (8001 pts)</p> <table border="1"> <thead> <tr> <th>Mkr</th> <th>MODE</th> <th>TRC</th> <th>SCN</th> <th>X</th> <th>Y</th> <th>FUNCTION</th> <th>FUNCTION WIDTH</th> <th>FUNCTION VALUE</th> </tr> </thead> <tbody> <tr> <td>1</td> <td>N</td> <td>1</td> <td>1</td> <td>2.438 ms</td> <td>-15.83 dBm</td> <td></td> <td></td> <td></td> </tr> <tr> <td>2</td> <td>N</td> <td>1</td> <td>1</td> <td>5.318 ms</td> <td>-16.45 dBm</td> <td></td> <td></td> <td></td> </tr> <tr> <td>3</td> <td>N</td> <td>1</td> <td>1</td> <td>8.182 ms</td> <td>-17.51 dBm</td> <td></td> <td></td> <td></td> </tr> </tbody> </table>	Mkr	MODE	TRC	SCN	X	Y	FUNCTION	FUNCTION WIDTH	FUNCTION VALUE	1	N	1	1	2.438 ms	-15.83 dBm				2	N	1	1	5.318 ms	-16.45 dBm				3	N	1	1	8.182 ms	-17.51 dBm			
Mkr	MODE	TRC	SCN	X	Y	FUNCTION	FUNCTION WIDTH	FUNCTION VALUE																													
1	N	1	1	2.438 ms	-15.83 dBm																																
2	N	1	1	5.318 ms	-16.45 dBm																																
3	N	1	1	8.182 ms	-17.51 dBm																																
<p>GFSK_DH5/MCH</p>	 <p>Center Freq 2.441000000 GHz</p> <p>Center 2.441000000 GHz #VBW 3.0 MHz Sweep 73.60 ms (8001 pts)</p> <table border="1"> <thead> <tr> <th>Mkr</th> <th>MODE</th> <th>TRC</th> <th>SCN</th> <th>X</th> <th>Y</th> <th>FUNCTION</th> <th>FUNCTION WIDTH</th> <th>FUNCTION VALUE</th> </tr> </thead> <tbody> <tr> <td>1</td> <td>N</td> <td>1</td> <td>1</td> <td>2.374 ms</td> <td>-16.80 dBm</td> <td></td> <td></td> <td></td> </tr> <tr> <td>2</td> <td>N</td> <td>1</td> <td>1</td> <td>5.253 ms</td> <td>-16.35 dBm</td> <td></td> <td></td> <td></td> </tr> <tr> <td>3</td> <td>N</td> <td>1</td> <td>1</td> <td>8.127 ms</td> <td>-15.77 dBm</td> <td></td> <td></td> <td></td> </tr> </tbody> </table>	Mkr	MODE	TRC	SCN	X	Y	FUNCTION	FUNCTION WIDTH	FUNCTION VALUE	1	N	1	1	2.374 ms	-16.80 dBm				2	N	1	1	5.253 ms	-16.35 dBm				3	N	1	1	8.127 ms	-15.77 dBm			
Mkr	MODE	TRC	SCN	X	Y	FUNCTION	FUNCTION WIDTH	FUNCTION VALUE																													
1	N	1	1	2.374 ms	-16.80 dBm																																
2	N	1	1	5.253 ms	-16.35 dBm																																
3	N	1	1	8.127 ms	-15.77 dBm																																
<p>GFSK_DH5/HCH</p>	 <p>Center Freq 2.480000000 GHz</p> <p>Center 2.480000000 GHz #VBW 3.0 MHz Sweep 73.60 ms (8001 pts)</p> <table border="1"> <thead> <tr> <th>Mkr</th> <th>MODE</th> <th>TRC</th> <th>SCN</th> <th>X</th> <th>Y</th> <th>FUNCTION</th> <th>FUNCTION WIDTH</th> <th>FUNCTION VALUE</th> </tr> </thead> <tbody> <tr> <td>1</td> <td>N</td> <td>1</td> <td>1</td> <td>358.8 μs</td> <td>-21.37 dBm</td> <td></td> <td></td> <td></td> </tr> <tr> <td>2</td> <td>N</td> <td>1</td> <td>1</td> <td>3.233 ms</td> <td>-16.78 dBm</td> <td></td> <td></td> <td></td> </tr> <tr> <td>3</td> <td>N</td> <td>1</td> <td>1</td> <td>4.112 ms</td> <td>-16.54 dBm</td> <td></td> <td></td> <td></td> </tr> </tbody> </table>	Mkr	MODE	TRC	SCN	X	Y	FUNCTION	FUNCTION WIDTH	FUNCTION VALUE	1	N	1	1	358.8 μs	-21.37 dBm				2	N	1	1	3.233 ms	-16.78 dBm				3	N	1	1	4.112 ms	-16.54 dBm			
Mkr	MODE	TRC	SCN	X	Y	FUNCTION	FUNCTION WIDTH	FUNCTION VALUE																													
1	N	1	1	358.8 μs	-21.37 dBm																																
2	N	1	1	3.233 ms	-16.78 dBm																																
3	N	1	1	4.112 ms	-16.54 dBm																																

Appendix D): Hopping Channel Number

Test Limit

According to §15.247(a)(1)(iii)

Frequency hopping systems in the 2400-2483.5 MHz band shall use at least 15 channels.

Test Procedure

Test method Refer as ANSI C63.10: 2013 clause 7.8.3

1. Place the EUT on the table and set it in transmitting mode.
2. EUT RF output port connected to the SA by RF cable.
3. Set spectrum analyzer Start Freq. = 2400 MHz, Stop Freq. = 2483.5 MHz, RBW = 100KHz, VBW = 300KHz.
4. Max hold, view and count how many channel in the band.

Test Setup

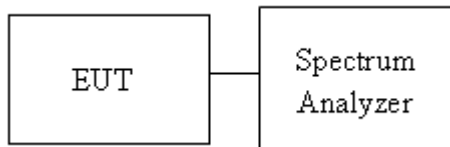

Result Table

Mode	Channel.	Number of Hopping Channel	Verdict
GFSK	Hop	79	PASS
π/4DQPSK	Hop	79	PASS
8DPSK	Hop	79	PASS

Test Graph

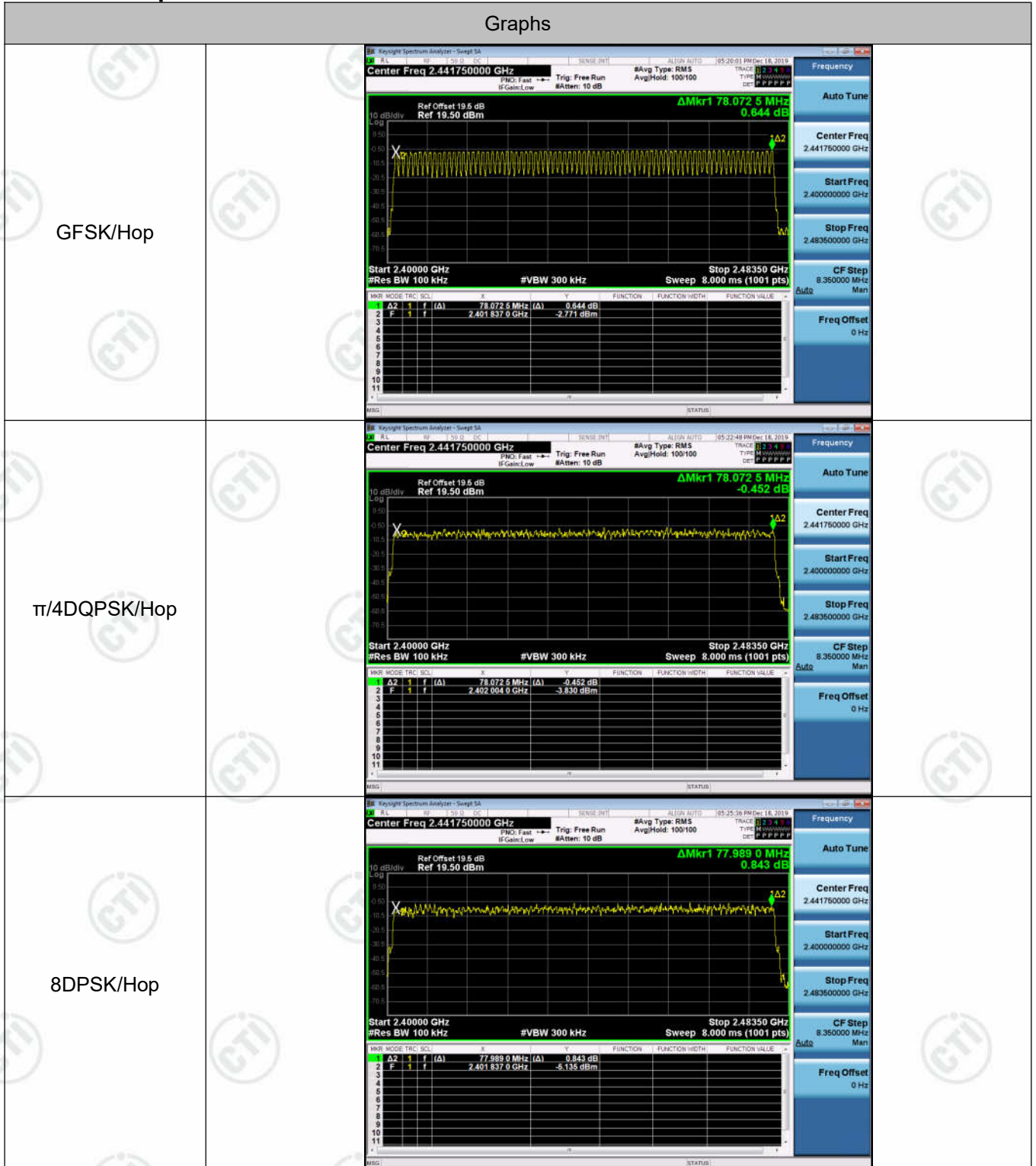

Appendix E): Conducted Peak Output Power Test Limit

According to §15.247(b)(1).

Peak output power :

FCC

Alternatively, frequency hopping systems operating in the 2400-2483.5 MHz band may have hopping channel carrier frequencies that are separated by 25 kHz or two-thirds of the 20 dB bandwidth of the hopping channel, whichever is greater, provided the systems operate with an output power no greater than 125 mW.

Limit	<input checked="" type="checkbox"/> Antenna not exceed 6 dBi : 21dBm <input type="checkbox"/> Antenna with DG greater than 6 dBi : 21dBm [Limit = 30 – (DG – 6)]
-------	-------------------------------------------------------------------------------------------------------------------------------------------------------------------------

Average output power : For reporting purposes only.

Test Procedure

1. The EUT RF output connected to the power meter by RF cable.
2. Setting maximum power transmit of EUT.
3. The path loss was compensated to the results for each measurement.
4. Measure and record the result of Peak output power and Average output power. in the test report.

Test Setup

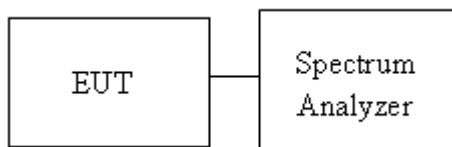



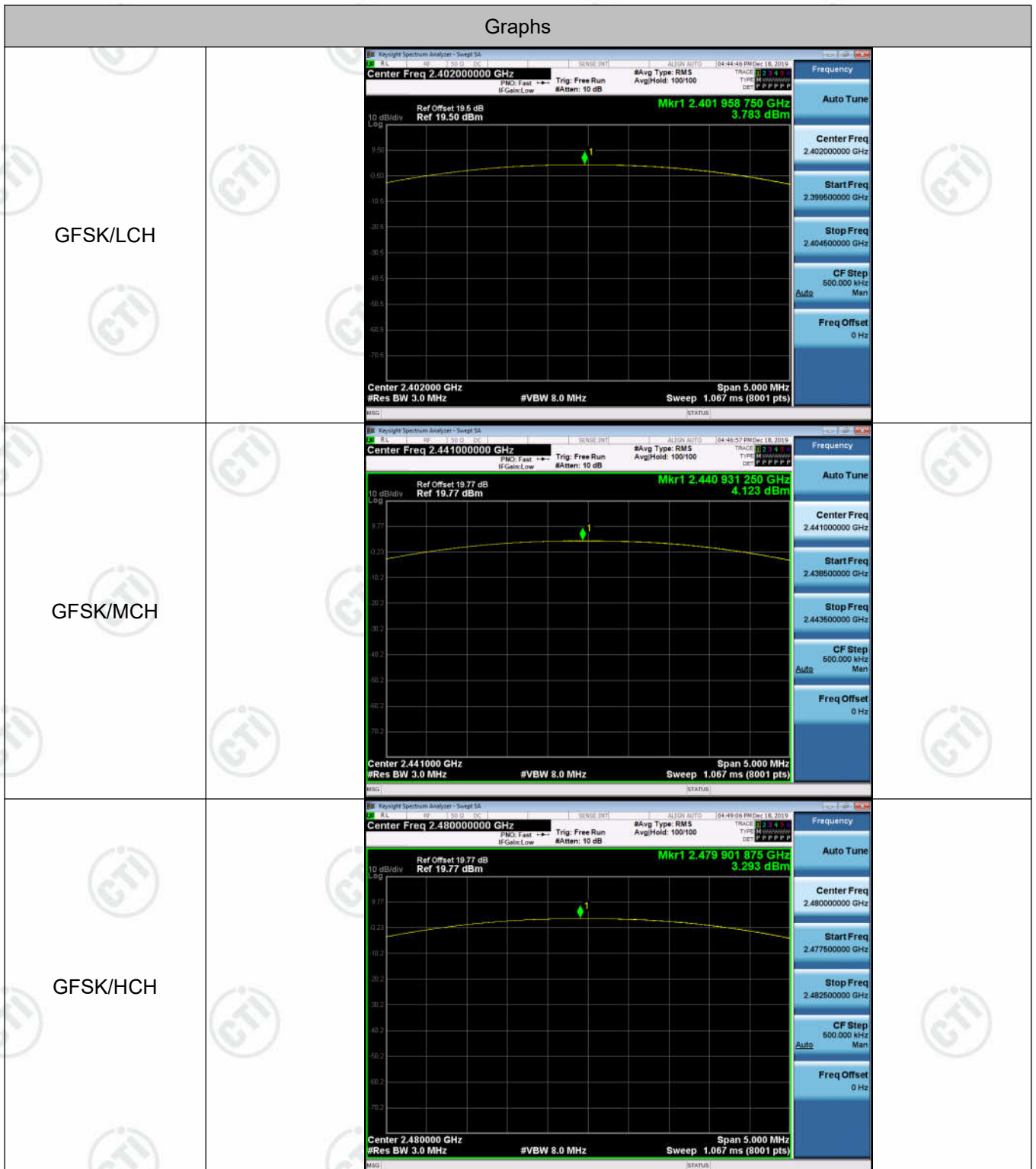

Result Table

Mode	Channel.	Maximum Peak Output Power [dBm]	Verdict
GFSK	LCH	3.783	PASS
GFSK	MCH	4.123	PASS
GFSK	HCH	3.293	PASS
$\pi/4$ DQPSK	LCH	0.792	PASS
$\pi/4$ DQPSK	MCH	1.865	PASS
$\pi/4$ DQPSK	HCH	1.862	PASS
8DPSK	LCH	1.511	PASS
8DPSK	MCH	2.511	PASS
8DPSK	HCH	2.607	PASS

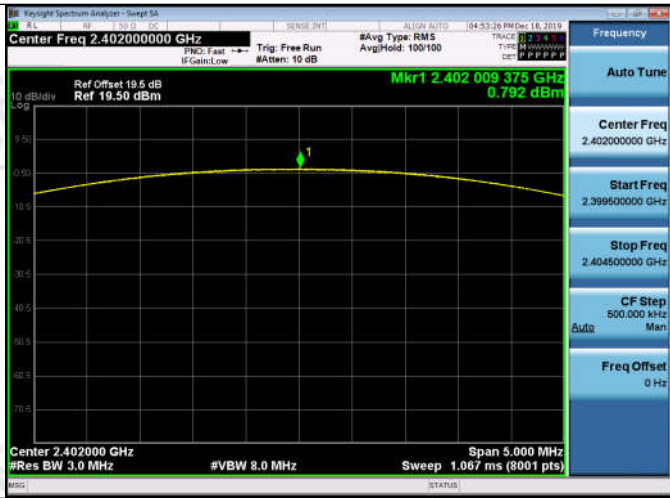
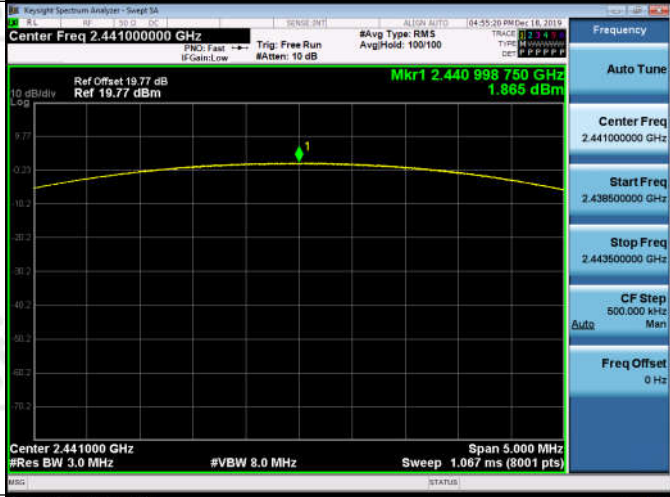
Test Graph

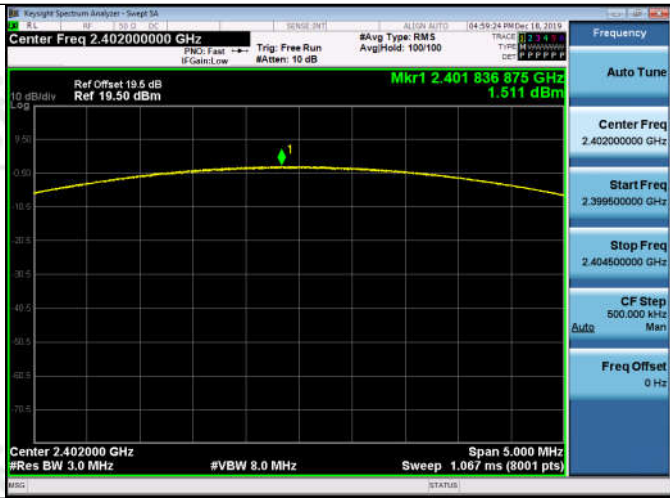
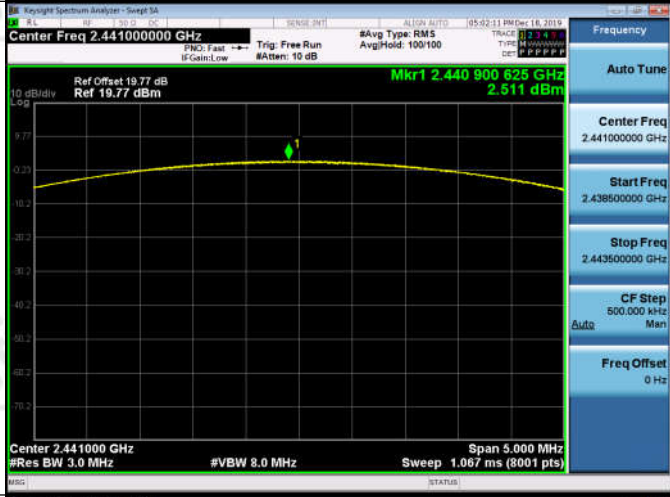

<p>$\pi/4$DQPSK/LCH</p>	
<p>$\pi/4$DQPSK/MCH</p>	
<p>$\pi/4$DQPSK/HCH</p>	

8DPSK/LCH		
8DPSK/MCH		
8DPSK/HCH		

Appendix F): Band-edge for RF Conducted Emissions

Test Limit

According to §15.247(d),

Limit	-20 dBc
-------	---------

Test Procedure

1. EUT RF output port connected to the SA by RF cable, and the path loss was compensated to result.
2. SA setting, RBW=100kHz, VBW=300kHz, Detector=Peak, Trace mode = max hold, SWT = Auto.
3. The Band Edge at 2.4GHz and 2.4835GHz are investigated with normal hopping mode.

Test Setup

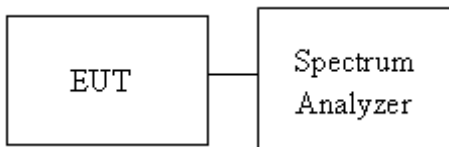

Result Table

Mode	Channel	Carrier Frequency [MHz]	Carrier Power [dBm]	Frequency Hopping	Max Spurious Level [dBm]	Limit [dBm]	Verdict
GFSK	LCH	2402	3.610	Off	-60.116	-16.39	PASS
			-2.425	On	-55.666	-22.43	PASS
GFSK	HCH	2480	3.145	Off	-56.555	-16.86	PASS
			-1.447	On	-54.202	-21.45	PASS
$\pi/4$ DQPSK	LCH	2402	-2.797	Off	-60.709	-22.8	PASS
			-2.931	On	-57.676	-22.93	PASS
$\pi/4$ DQPSK	HCH	2480	-1.771	Off	-59.244	-21.77	PASS
			-1.917	On	-55.810	-21.92	PASS
8DPSK	LCH	2402	-2.895	Off	-58.411	-22.9	PASS
			-3.087	On	-56.866	-23.09	PASS
8DPSK	HCH	2480	-1.513	Off	-54.816	-21.51	PASS
			-2.001	On	-56.603	-22	PASS

Test Graph

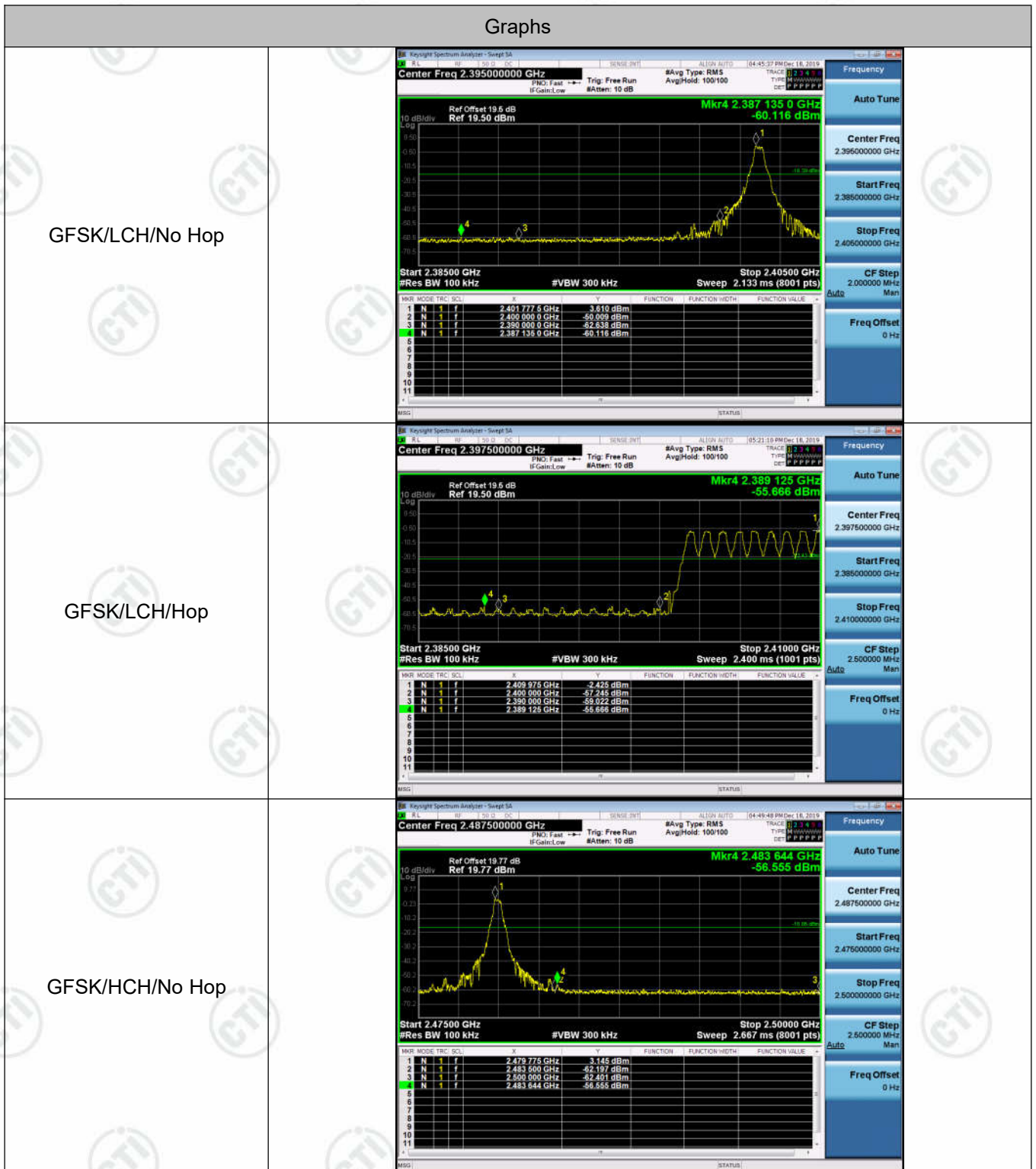

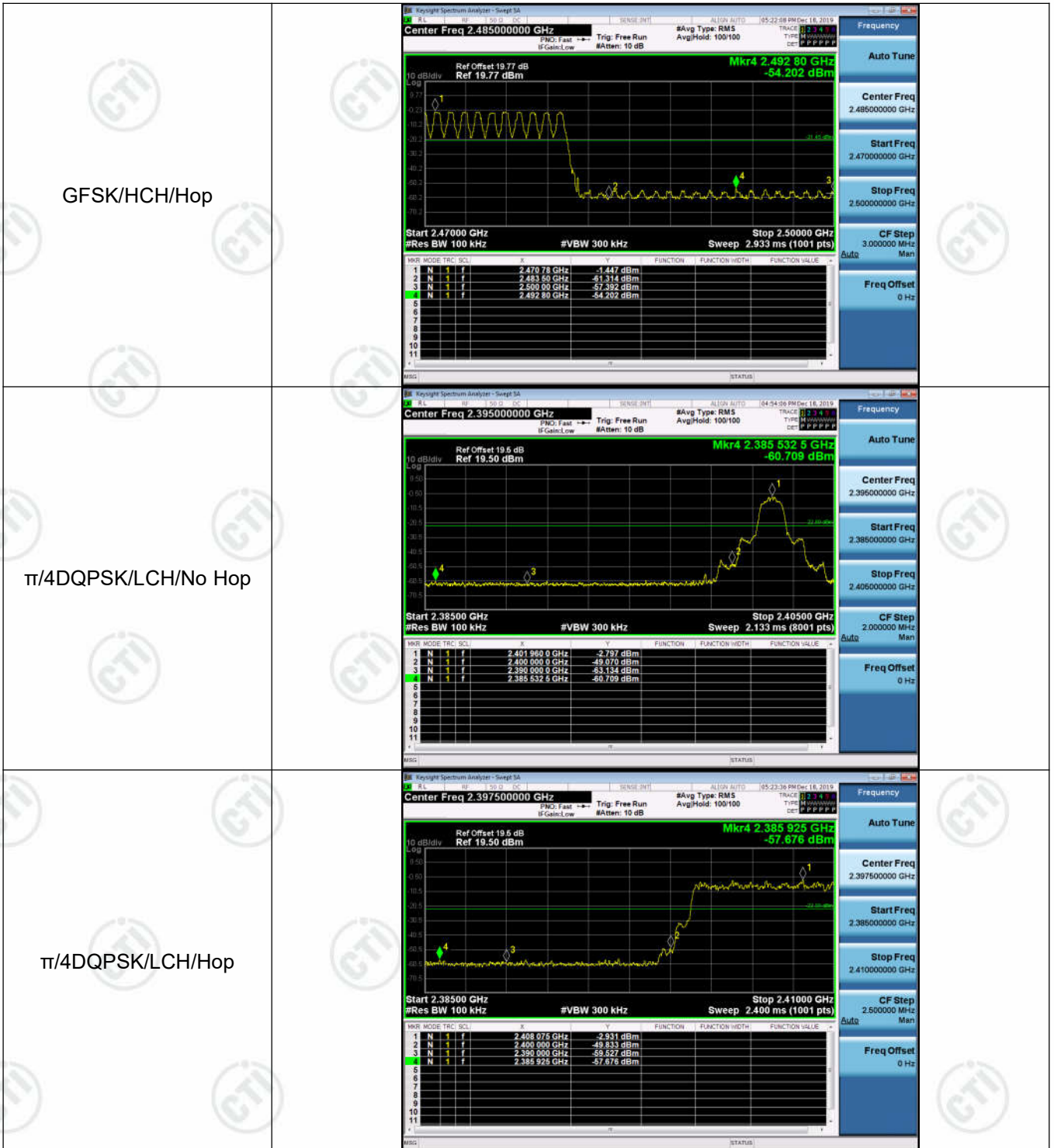

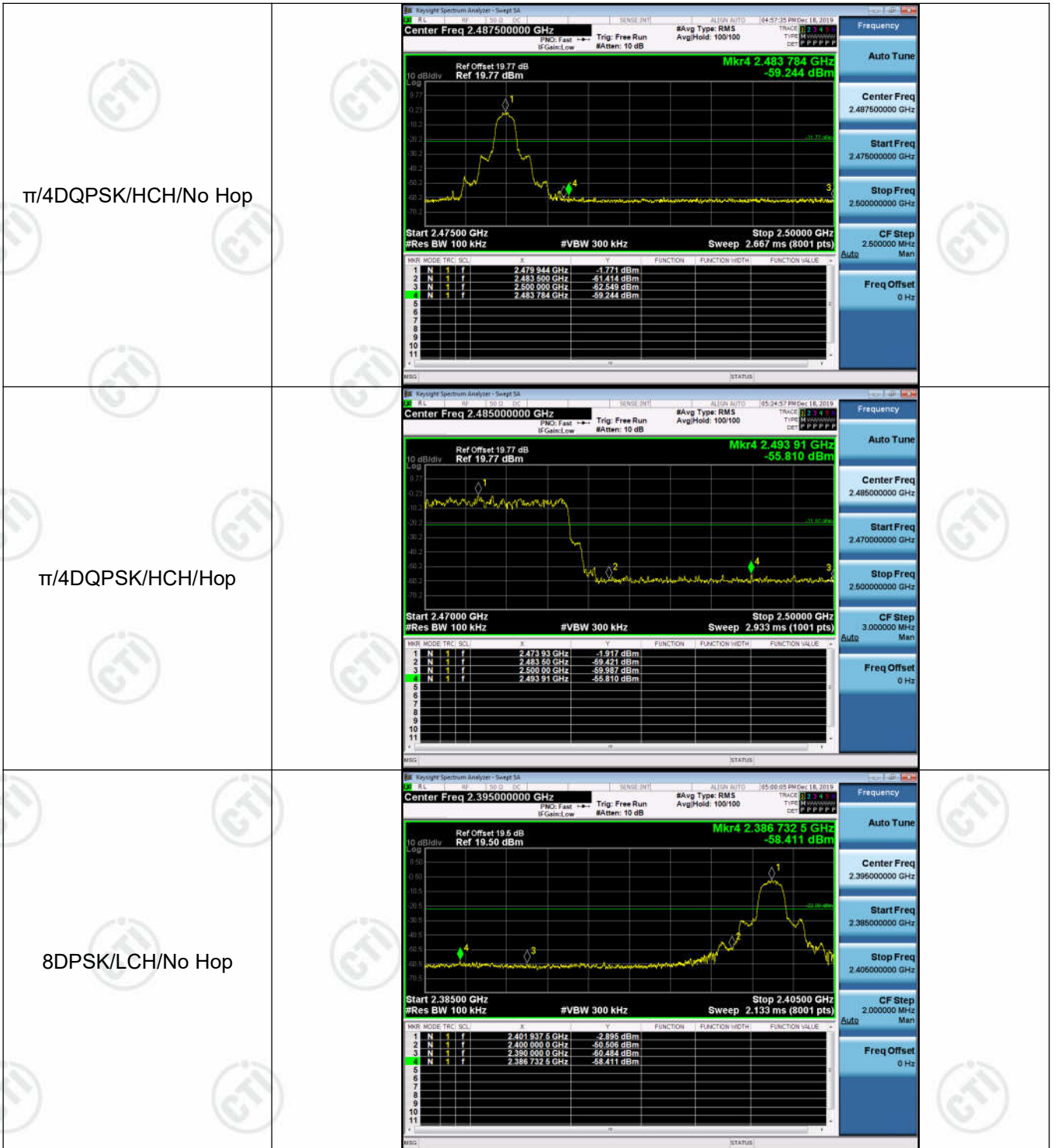

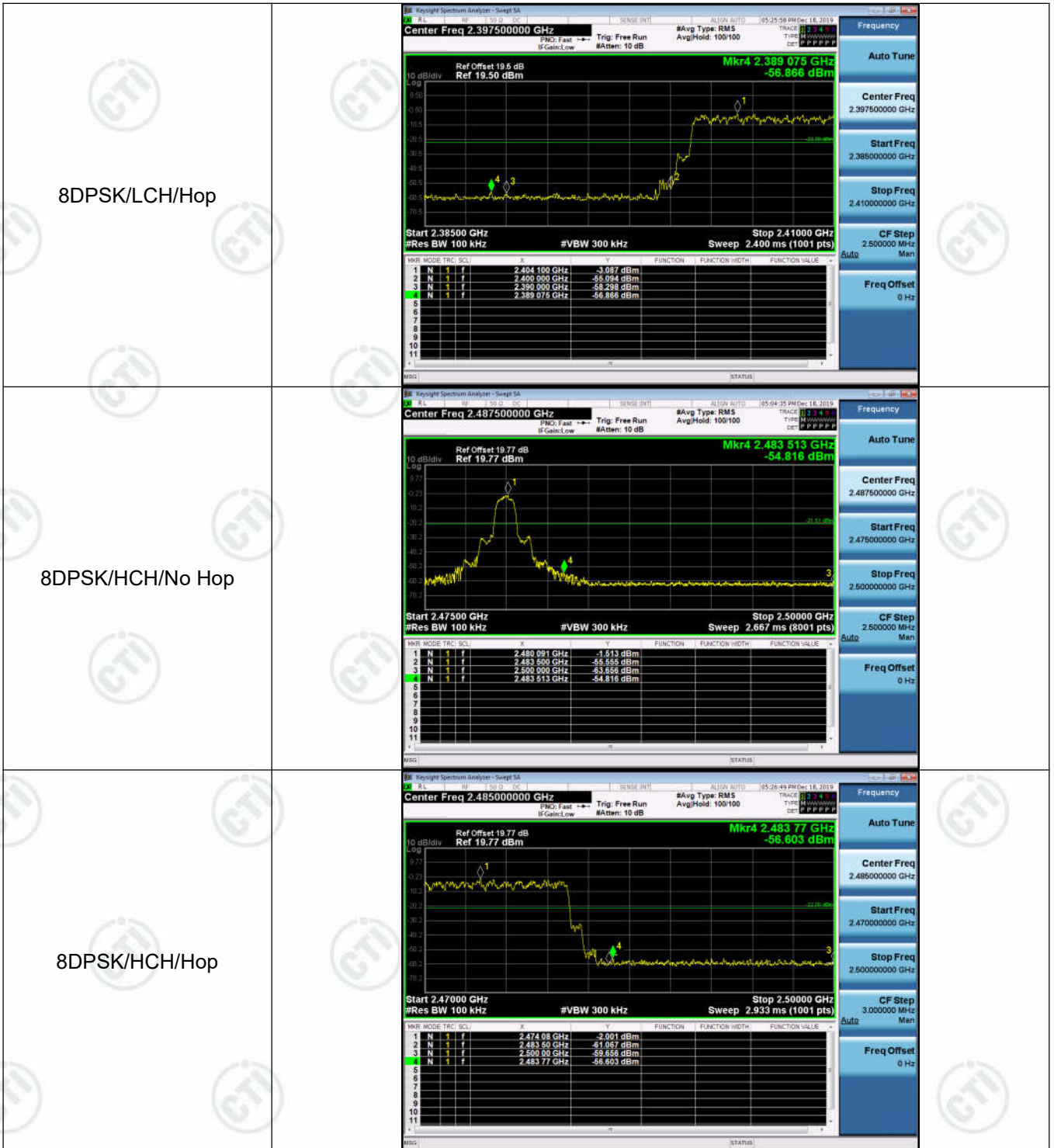

Appendix G): RF Conducted Spurious Emissions

Test Limit

According to §15.247(d),

Limit	-20 dBc
-------	---------

Test Procedure

1. EUT RF output port connected to the SA by RF cable, and the path loss was compensated to result.
2. SA setting, RBW=100kHz, VBW=300kHz, Detector=Peak, Trace mode = max hold, SWT = Auto.

Test Setup

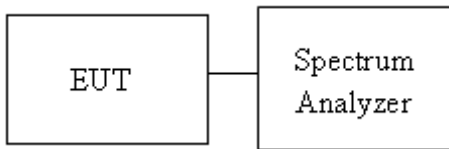

Result Table

Mode	Channel	Pref [dBm]	Puw[dBm]	Verdict
GFSK	LCH	3.566	<Limit	PASS
GFSK	MCH	3.852	<Limit	PASS
GFSK	HCH	3.101	<Limit	PASS
$\pi/4$ DQPSK	LCH	-2.925	<Limit	PASS
$\pi/4$ DQPSK	MCH	-1.822	<Limit	PASS
$\pi/4$ DQPSK	HCH	-1.864	<Limit	PASS
8DPSK	LCH	-2.878	<Limit	PASS
8DPSK	MCH	-1.796	<Limit	PASS
8DPSK	HCH	-1.641	<Limit	PASS

Test Graph

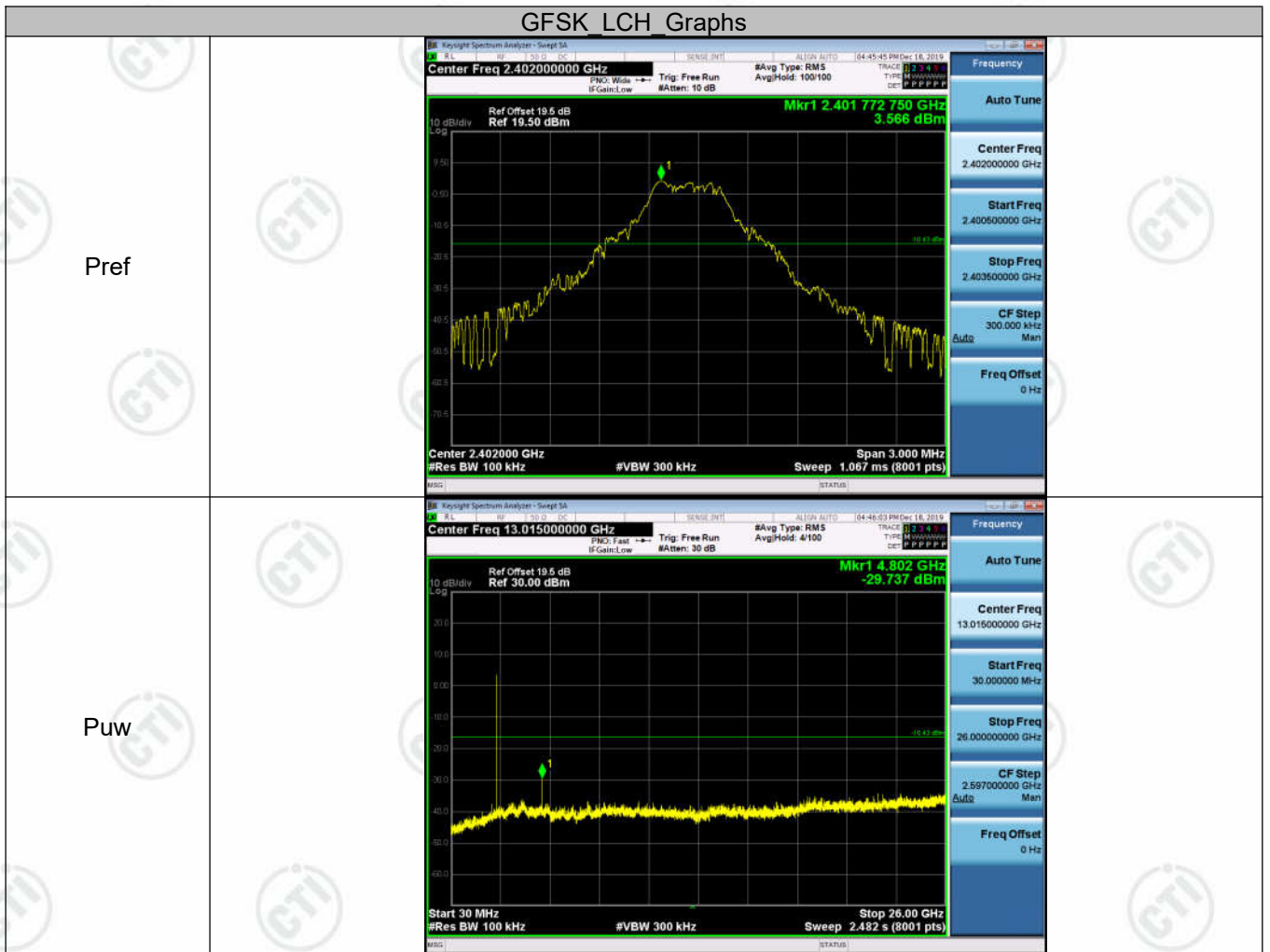

GFSK_MCH_Graphs

