

RF TEST REPORT



Report No.: 16070511-FCC-R

Supersede Report No.:N/A

Applicant	Shenzhen Kingsun Enterprises Co., Ltd.	
Product Name	Waterproof Bluetooth Speaker	
Model No.	DC-0615	
Serial No.	NV-04750	
Test Standard	FCC Part 15.247: 2015, ANSI C63.10: 2013	
Test Date	May 14 to May 27, 2016	
Issue Date	May 27, 2016	
Test Result	<input checked="" type="checkbox"/> Pass <input type="checkbox"/> Fail	
Equipment complied with the specification	<input checked="" type="checkbox"/>	
Equipment did not comply with the specification	<input type="checkbox"/>	
<i>Winnie Zhang</i>	<i>David Huang</i>	
Winnie Zhang Test Engineer	David Huang Checked By	
This test report may be reproduced in full only Test result presented in this test report is applicable to the tested sample only		

Issued by:

SIEMIC (SHENZHEN-CHINA) LABORATORIES

Zone A, Floor 1, Building 2 Wan Ye Long Technology Park

South Side of Zhoushi Road, Bao' an District, Shenzhen, Guangdong China 518108

Phone: +86 0755 2601 4629801 Email: China@siemic.com.cn

Laboratories Introduction

SIEMIC, headquartered in the heart of Silicon Valley, with superior facilities in US and Asia, is one of the leading independent testing and certification facilities providing customers with one-stop shop services for Compliance Testing and Global Certifications.



In addition to testing and certification, SIEMIC provides initial design reviews and compliance management throughout a project. Our extensive experience with China, Asia Pacific, North America, European, and International compliance requirements, assures the fastest, most cost effective way to attain regulatory compliance for the global markets.

Accreditations for Conformity Assessment

Country/Region	Scope
USA	EMC, RF/Wireless, SAR, Telecom
Canada	EMC, RF/Wireless, SAR, Telecom
Taiwan	EMC, RF, Telecom, SAR, Safety
Hong Kong	RF/Wireless, SAR, Telecom
Australia	EMC, RF, Telecom, SAR, Safety
Korea	EMI, EMS, RF, SAR, Telecom, Safety
Japan	EMI, RF/Wireless, SAR, Telecom
Singapore	EMC, RF, SAR, Telecom
Europe	EMC, RF, SAR, Telecom, Safety

Test Report	16070511-FCC-R
Page	3 of 58

This page has been left blank intentionally.

CONTENTS

1. REPORT REVISION HISTORY	5
2. CUSTOMER INFORMATION	5
3. TEST SITE INFORMATION.....	5
4. EQUIPMENT UNDER TEST (EUT) INFORMATION.....	6
5. TEST SUMMARY	7
6. MEASUREMENTS, EXAMINATION AND DERIVED RESULTS	8
6.1 ANTENNA REQUIREMENT.....	8
6.2 CHANNEL SEPARATION	9
6.3 20DB BANDWIDTH	13
6.4 PEAK OUTPUT POWER.....	17
6.5 NUMBER OF HOPPING CHANNEL.....	21
6.6 TIME OF OCCUPANCY (DWEEL TIME)	23
6.7 BAND EDGE & RESTRICTED BAND	27
6.8 AC POWER LINE CONDUCTED EMISSIONS.....	35
6.9 RADIATED EMISSIONS & RESTRICTED BAND	41
ANNEX A. TEST INSTRUMENT.....	47
ANNEX B. EUT AND TEST SETUP PHOTOGRAPHS.....	48
ANNEX C. TEST SETUP AND SUPPORTING EQUIPMENT.....	53
ANNEX D. USER MANUAL / BLOCK DIAGRAM / SCHEMATICS / PARTLIST	57
ANNEX E. DECLARATION OF SIMILARITY.....	58

1. Report Revision History

Report No.	Report Version	Description	Issue Date
16070511-FCC-R	NONE	Original	May 10, 2016

2. Customer information

Applicant Name	Shenzhen Kingsun Enterprises Co., Ltd.
Applicant Add	25 / F,CEC information Building Xinwen Rd.,Shenzhen,Guangdong,China
Manufacturer	Shenzhen Kingsun Enterprises Co., Ltd.
Manufacturer Add	25 / F,CEC information Building Xinwen Rd.,Shenzhen,Guangdong,China

3. Test site information

Lab performing tests	SIEMIC (Shenzhen-China) LABORATORIES
Lab Address	Zone A, Floor 1, Building 2 Wan Ye Long Technology Park South Side of Zhoushi Road, Bao' an District, Shenzhen, Guangdong China 518108
FCC Test Site No.	718246
IC Test Site No.	4842E-1
Test Software	Radiated Emission Program-To Shenzhen v2.0

4. Equipment under Test (EUT) Information

Description of EUT:	Waterproof Bluetooth Speaker
Main Model:	DC-0615
Serial Model:	NV-04750
Date EUT received:	May 13, 2016
Test Date(s):	May 14 to May 27, 2016
Equipment Category :	DSS
Antenna Gain:	1.9dBi
Type of Modulation:	GFSK, π /4DQPSK,8DPSK
RF Operating Frequency (ies):	2402-2480 MHz
Max. Output Power:	4.472dBm
Number of Channels:	79CH
Port:	USB Port, TF card Port
Input Power:	Battery : Model : 052535 Battery Capacity:3.7V , 450mAh USB 5V
Trade Name :	N/A
FCC ID:	2AAPKDC-0615

5. Test Summary

The product was tested in accordance with the following specifications.

All testing has been performed according to below product classification:

FCC Rules	Description of Test	Result
§15.203	Antenna Requirement	Compliance
§15.247(a)(1)	Channel Separation	Compliance
§15.247(a)(1)	20 dB Bandwidth	Compliance
§15.247(b)(1)	Peak Output Power	Compliance
§15.247(a)(1)(iii)	Number of Hopping Channel	Compliance
§15.247(a)(1)(iii)	Time of Occupancy (Dwell Time)	Compliance
§15.247(d)	Band Edge & Restricted Band	Compliance
§15.207(a)	AC Line Conducted Emissions	Compliance
§15.205, §15.209, §15.247(d)	Radiated Emissions & Restricted Band	Compliance

Measurement Uncertainty

Emissions		
Test Item	Description	Uncertainty
Band Edge and Radiated Spurious Emissions	Confidence level of approximately 95% (in the case where distributions are normal), with a coverage factor of 2 (for EUTs < 0.5m X 0.5m X 0.5m)	+5.6dB/-4.5dB
-	-	-

6. Measurements, Examination And Derived Results

6.1 Antenna Requirement

Applicable Standard

According to § 15.203, an intentional radiator shall be designed to ensure that no antenna other than that furnished by the responsible party shall be used with the device. The use of a permanently attached antenna or of an antenna that uses a unique coupling to the intentional radiator shall be considered sufficient to comply with the provisions of this section. The manufacturer may design the unit so that a broken antenna can be replaced by the user, but the user of a standard antenna jack or electrical connector is prohibited. The structure and application of the EUT were analyzed to determine compliance with section §15.203 of the rules. §15.203 state that the subject device must meet the following criteria:

- a. Antenna must be permanently attached to the unit.
- b. Antenna must use a unique type of connector to attach to the EUT.

Unit must be professionally installed, and installer shall be responsible for verifying that the correct antenna is employed with the unit.

And according to FCC 47 CFR section 15.247 (b), if the transmitting antennas of directional gain greater than 6dBi are used, the power shall be reduced by the amount in dB that the directional gain of the antenna exceeds 6 dBi.

Antenna Connector Construction

The EUT has 1 antenna:

A permanently attached PCB antenna for Bluetooth, the gain is 1.9dBi for Bluetooth.

The antenna meets up with the ANTENNA REQUIREMENT.

Result: Compliance.

6.2 Channel Separation

Temperature	22°C
Relative Humidity	59%
Atmospheric Pressure	1017mbar
Test date :	May 17, 2016
Tested By :	Winnie Zhang

Requirement(s):

Spec	Item	Requirement	Applicable
§ 15.247(a)(1)	a)	Channel Separation < 20dB BW and 20dB BW < 25KHz ; Channel Separation Limit=25KHz Chanel Separation < 20dB BW and 20dB BW > 25kHz ; Channel Separation Limit=2/3 20dB BW	<input checked="" type="checkbox"/>
Test Setup			
Test Procedure	<p>The test follows FCC Public Notice DA 00-705 Measurement Guidelines. Use the following spectrum analyzer settings:</p> <ul style="list-style-type: none"> - The EUT must have its hopping function enabled - Span = wide enough to capture the peaks of two adjacent channels - Resolution (or IF) Bandwidth (RBW) ≥ 1% of the span - Video (or Average) Bandwidth (VBW) ≥ RBW - Sweep = auto - Detector function = peak - Trace = max hold - Allow the trace to stabilize. Use the marker-delta function to determine the separation between the peaks of the adjacent channels. The limit is specified in one of the subparagraphs of this Section. Submit this plot. 		

Remark	
Result	<input checked="" type="checkbox"/> Pass <input type="checkbox"/> Fail

Test Data Yes N/A

Test Plot Yes (See below) N/A

Channel Separation measurement result

Type/ Modulation	CH	CH Freq (MHz)	CH Separation (MHz)	Limit (MHz)	Result
CH Separation GFSK	Low Channel	2402	1.005	0.688	Pass
	Adjacency Channel	2403			
	Mid Channel	2440	1.005	0.687	Pass
	Adjacency Channel	2441			
	High Channel	2480	1.005	0.685	Pass
	Adjacency Channel	2479			
CH Separation $\pi/4$ DQPSK	Low Channel	2402	1.005	0.757	Pass
	Adjacency Channel	2403			
	Mid Channel	2440	1.005	0.772	Pass
	Adjacency Channel	2441			
	High Channel	2480	1.005	0.776	Pass
	Adjacency Channel	2479			
CH Separation 8DPSK	Low Channel	2402	1.005	0.684	Pass
	Adjacency Channel	2403			
	Mid Channel	2440	1.005	0.679	Pass
	Adjacency Channel	2441			
	High Channel	2480	1.005	0.687	Pass
	Adjacency Channel	2479			

Test Plots

Channel Separation measurement result

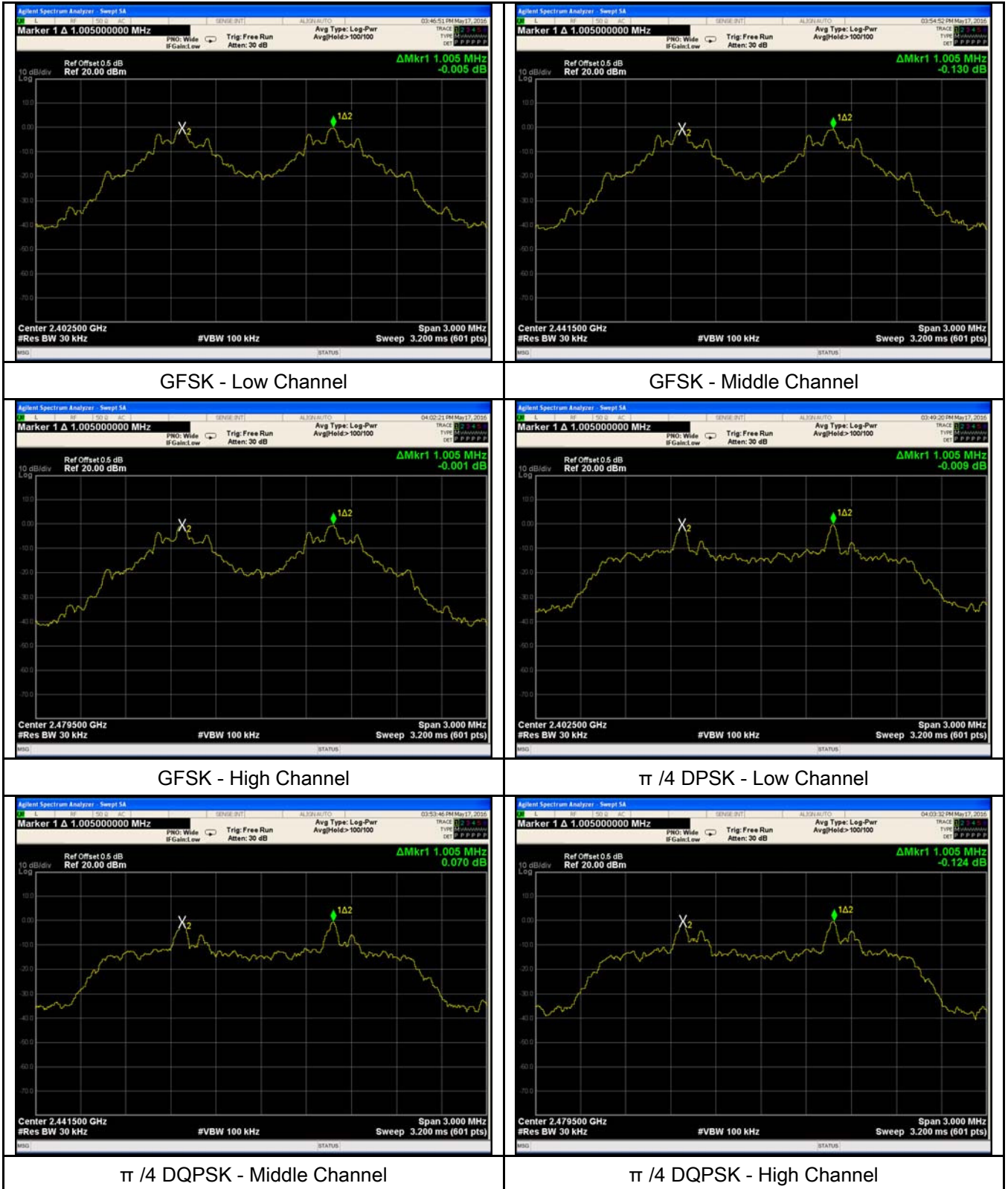



8DPSK - Low Channel



8DPSK - Middle Channel



8DPSK - High Channel



6.3 20dB Bandwidth

Temperature	22°C
Relative Humidity	59%
Atmospheric Pressure	1017mbar
Test date :	May 17, 2016
Tested By :	Winnie Zhang

Requirement(s):

Spec	Item	Requirement	Applicable
§15.247(a) (1)	a)	Frequency hopping systems shall have hopping channel carrier frequencies separated by a minimum of 25 kHz or the 20 dB bandwidth of the hopping channel, whichever is greater.	<input checked="" type="checkbox"/>

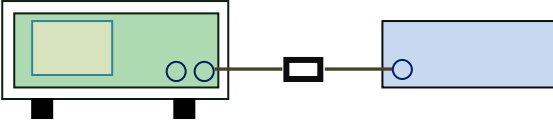
Test Setup	
------------	--

Test Procedure	<p>The test follows FCC Public Notice DA 00-705 Measurement Guidelines.</p> <p><u>Use the following spectrum analyzer settings:</u></p> <ul style="list-style-type: none"> - Span = approximately 2 to 3 times the 20 dB bandwidth, centered on a hopping channel - RBW \geq 1% of the 20 dB bandwidth - VBW \geq RBW - Sweep = auto - Detector function = peak - Trace = max hold. - The EUT should be transmitting at its maximum data rate. Allow the trace to stabilize. Use the marker-to-peak function to set the marker to the peak of the emission. Use the marker-delta function to measure 20 dB down one side of the emission. Reset the marker-delta function, and move the marker to the other side of the emission, until it is (as close as possible to) even with the reference
----------------	--

	marker level. The marker-delta reading at this point is the 20 dB bandwidth of the emission. If this value varies with different modes of operation (e.g., data rate, modulation format, etc.), repeat this test for each variation. The limit is specified in one of the subparagraphs of this Section. Submit this plot(s).
Remark	
Result	<input checked="" type="checkbox"/> Pass <input type="checkbox"/> Fail

Test Data Yes N/A

Test Plot Yes (See below) N/A

Measurement result

Modulation	CH	CH Freq (MHz)	20dB Bandwidth (MHz)	99% Occupied Bandwidth (MHz)
GFSK	Low	2402	1.032	0.9758
	Mid	2441	1.030	0.9635
	High	2480	1.027	0.9551
π /4 DQPSK	Low	2402	1.135	1.1933
	Mid	2441	1.158	1.1795
	High	2480	1.164	1.1423
8DPSK	Low	2402	1.026	1.1532
	Mid	2441	1.018	1.1346
	High	2480	1.031	1.1132

Test Plots

20dB Bandwidth measurement result

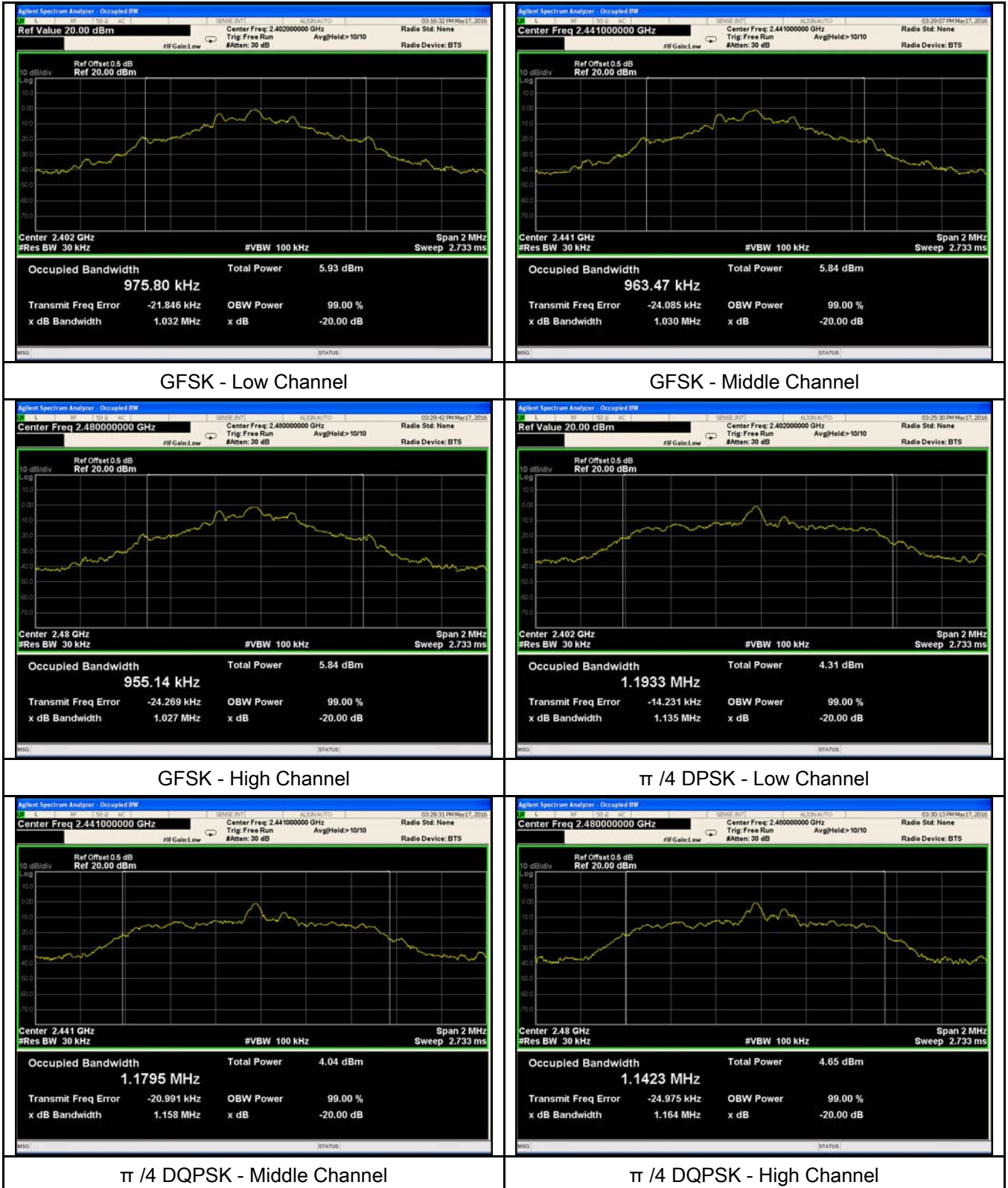



8DPSK - Low Channel



8DPSK - Middle Channel



8DPSK - High Channel

6.4 Peak Output Power

Temperature	22°C
Relative Humidity	59%
Atmospheric Pressure	1017mbar
Test date :	May 17, 2016
Tested By :	Winnie Zhang

Requirement(s):

Spec	Item	Requirement	Applicable
§15.247(b) (3)	a)	FHSS in 2400-2483.5MHz with ≥ 75 channels: ≤ 1 Watt	<input checked="" type="checkbox"/>
	b)	FHSS in 5725-5850MHz: ≤ 1 Watt	<input type="checkbox"/>
	c)	For all other FHSS in the 2400-2483.5MHz band: ≤ 0.125 Watt.	<input checked="" type="checkbox"/>
	d)	FHSS in 902-928MHz with ≥ 50 channels: ≤ 1 Watt	<input type="checkbox"/>
	e)	FHSS in 902-928MHz with ≥ 25 & < 50 channels: ≤ 0.25 Watt	<input type="checkbox"/>
	f)	DTS in 902-928MHz, 2400-2483.5MHz: ≤ 1 Watt	<input type="checkbox"/>

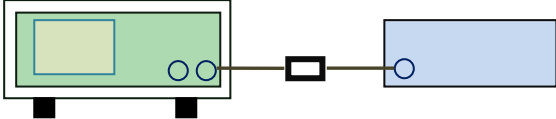
Test Setup	
------------	--

Test Procedure	<p>The test follows FCC Public Notice DA 00-705 Measurement Guidelines.</p> <p>Use the following spectrum analyzer settings:</p> <ul style="list-style-type: none"> - Span = approximately 5 times the 20 dB bandwidth, centered on a hopping channel - RBW > the 20 dB bandwidth of the emission being measured - VBW \geq RBW - Sweep = auto - Detector function = peak - Trace = max hold - Allow the trace to stabilize.
----------------	---

	<ul style="list-style-type: none"> - Use the marker-to-peak function to set the marker to the peak of the emission. The indicated level is the peak output power (see the note above regarding external attenuation and cable loss). The limit is specified in one of the subparagraphs of this Section. Submit this plot. A peak responding power meter may be used instead of a spectrum analyzer.
Remark	
Result	<input checked="" type="checkbox"/> Pass <input type="checkbox"/> Fail

Test Data Yes N/A
 Test Plot Yes (See below) N/A

Peak Output Power measurement result

Type	Modulation	CH	Freq (MHz)	Conducted Power (dBm)	Limit (mW)	Result
Output power	GFSK	Low	2402	3.636	125	Pass
		Mid	2441	3.536	125	Pass
		High	2480	4.465	125	Pass
	π /4 DQPSK	Low	2402	3.665	125	Pass
		Mid	2441	3.577	125	Pass
		High	2480	4.512	125	Pass
	8DPSK	Low	2402	3.662	125	Pass
		Mid	2441	3.552	125	Pass
		High	2480	4.472	125	Pass

Test Plots

Output Power measurement result



GFSK Output power - Low CH 2402

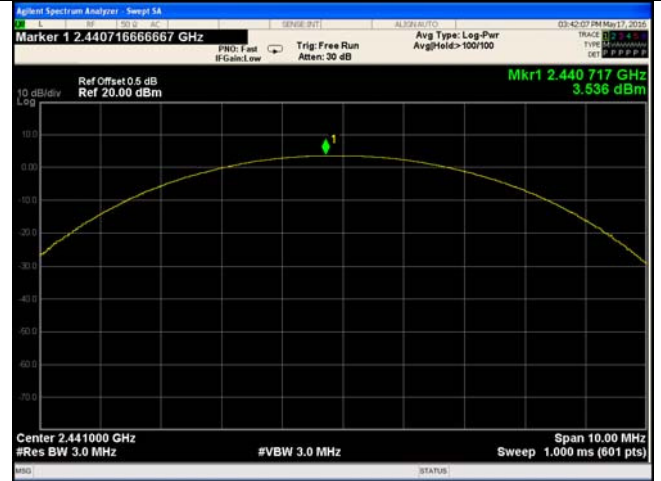

GFSK Output power - Mid CH 2441



GFSK Output power - High CH 2480

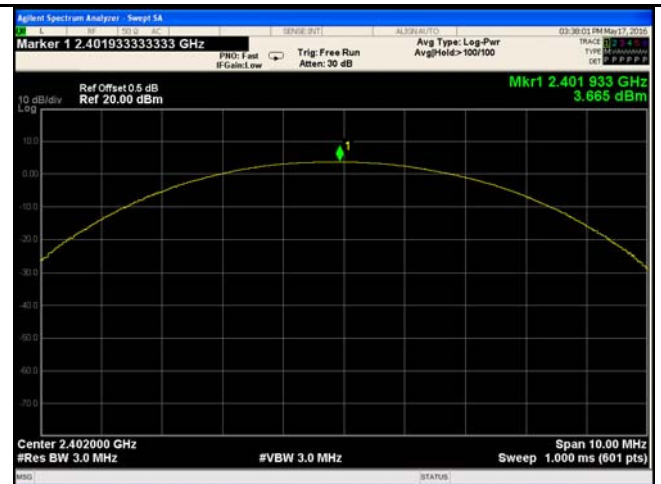

$\pi/4$ DQPSK Output power - Low CH 2402

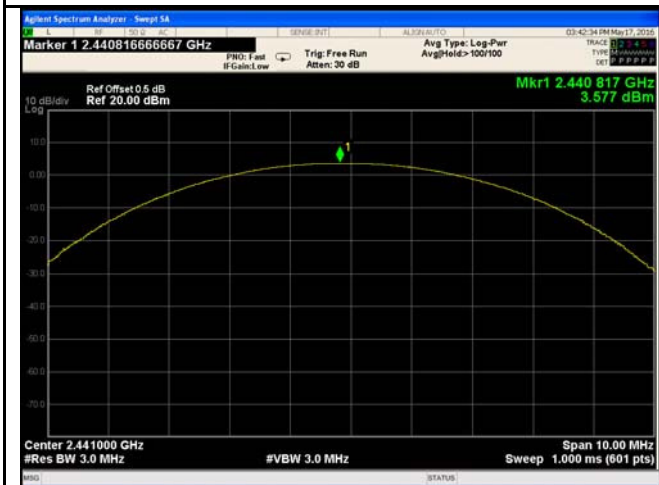

$\pi/4$ DQPSK Output power - Mid CH 2441

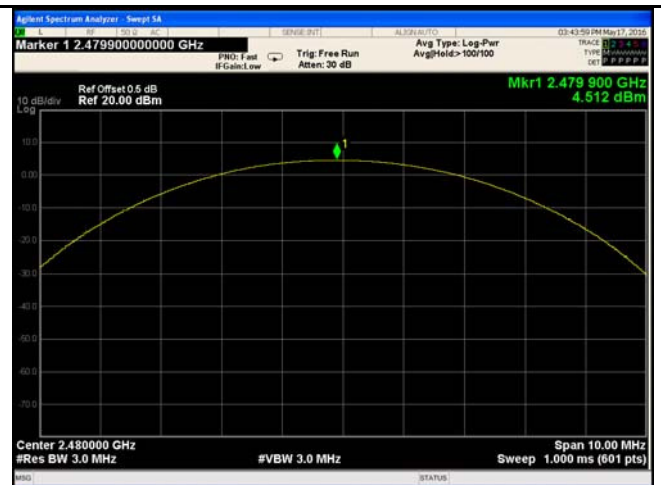

$\pi/4$ DQPSK Output power - High CH 2480

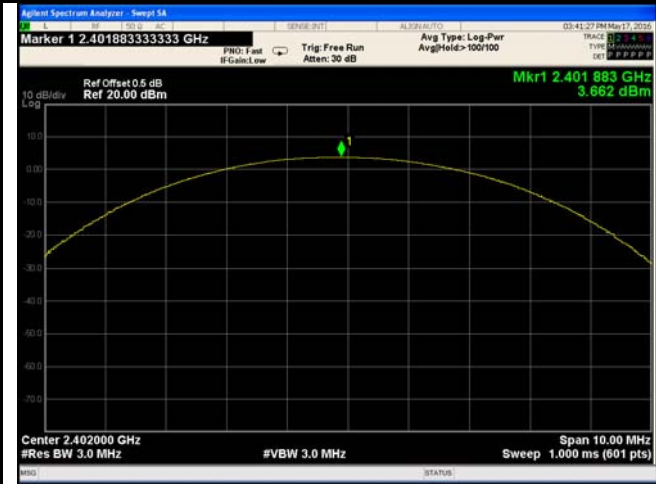

8DPSK Output power - Low CH 2402



8DPSK Output power - Mid CH 2441



8DPSK Output power - High CH 2480

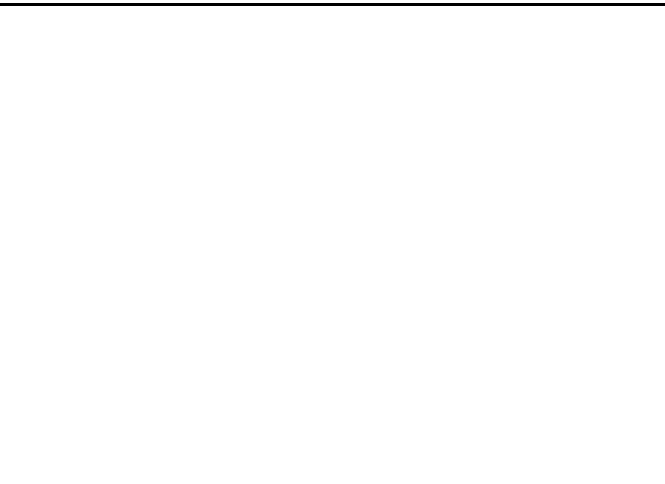

6.5 Number of Hopping Channel

Temperature	22°C
Relative Humidity	59%
Atmospheric Pressure	1017mbar
Test date :	May 17, 2016
Tested By :	Winnie Zhang

Requirement(s):

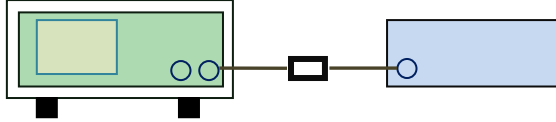
Spec	Item	Requirement	Applicable
§15.247(a) (1)(iii)	a)	FHSS in 2400-2483.5MHz ≥ 15 channels	<input checked="" type="checkbox"/>
Test Setup			
Test Procedure	<p>The test follows FCC Public Notice DA 00-705 Measurement Guidelines. <u>Use the following spectrum analyzer settings:</u> The EUT must have its hopping function enabled.</p> <ul style="list-style-type: none"> - Span = the frequency band of operation - RBW ≥ 1% of the span - VBW ≥ RBW - Sweep = auto - Detector function = peak - Trace = max hold - Allow trace to fully stabilize. - It may prove necessary to break the span up to sections, in order to clearly show all of the hopping frequencies. The limit is specified in one of the subparagraphs of this Section. Submit this plot(s). 		
Remark			
Result	<input checked="" type="checkbox"/> Pass <input type="checkbox"/> Fail		

Test Data Yes N/A
 Test Plot Yes (See below) N/A

6.6 Time of Occupancy (Dwell Time)

Temperature	22°C
Relative Humidity	59%
Atmospheric Pressure	1017mbar
Test date :	May 17, 2016
Tested By :	Winnie Zhang

Requirement(s):

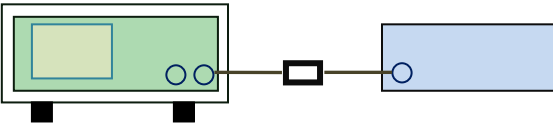
Spec	Item	Requirement	Applicable
§15.247(a) (1)(iii)	a)	Dwell Time < 0.4s	<input checked="" type="checkbox"/>
Test Setup			
Test Procedure	<p>The test follows FCC Public Notice DA 00-705 Measurement Guidelines. <u>Use the following spectrum analyzer</u></p> <ul style="list-style-type: none"> - Span = zero span, centered on a hopping channel - RBW = 1 MHz - VBW ≥ RBW - Sweep = as necessary to capture the entire dwell time per hopping channel - Detector function = peak - Trace = max hold - use the marker-delta function to determine the dwell time 		
Remark			
Result	<input checked="" type="checkbox"/> Pass <input type="checkbox"/> Fail		

Test Data Yes N/A
 Test Plot Yes (See below) N/A

Dwell Time measurement result

Type	Modulation	CH	Pulse Width (ms)	Dwell Time (ms)	Limit (ms)	Result
Dwell Time	GFSK	Low	3.000	320.000	400	Pass
		Mid	3.000	320.000	400	Pass
		High	3.000	320.000	400	Pass
	π /4 DQPSK	Low	3.000	320.000	400	Pass
		Mid	3.000	320.000	400	Pass
		High	3.000	320.000	400	Pass
	8DPSK	Low	2.983	318.187	400	Pass
		Mid	2.983	318.187	400	Pass
		High	3.000	320.000	400	Pass
Note: Dwell time=Pulse Time (ms) × (1600 ÷ 6 ÷ 79) ×31.6						

Test Plots

Dwell Time measurement result



GFSK - Low CH 2402

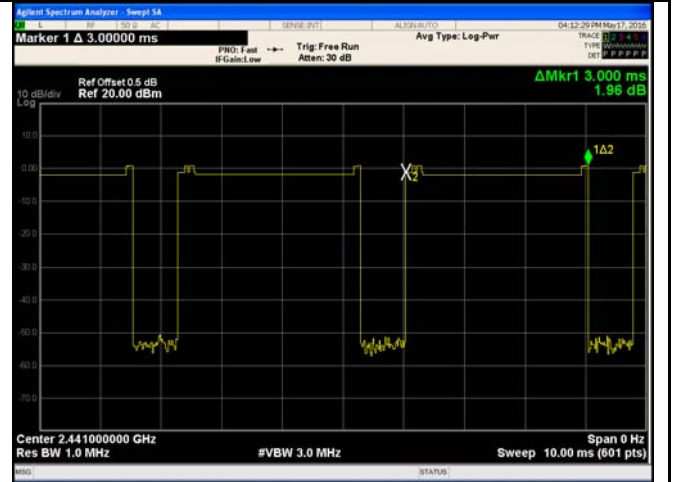

GFSK - Mid CH 2441



GFDK - High CH 2480

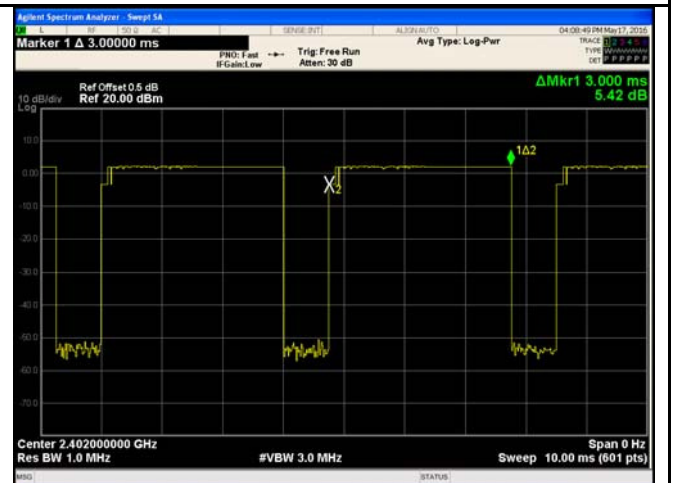

$\pi/4$ DQPSK - Low CH 2402

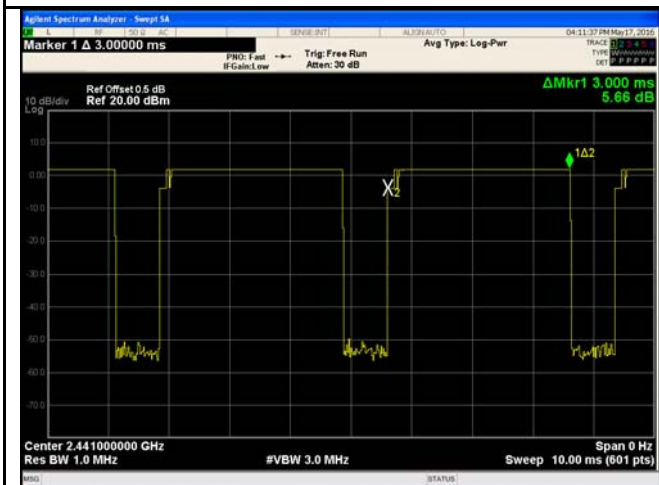

$\pi/4$ DQPSK - Mid CH 2441

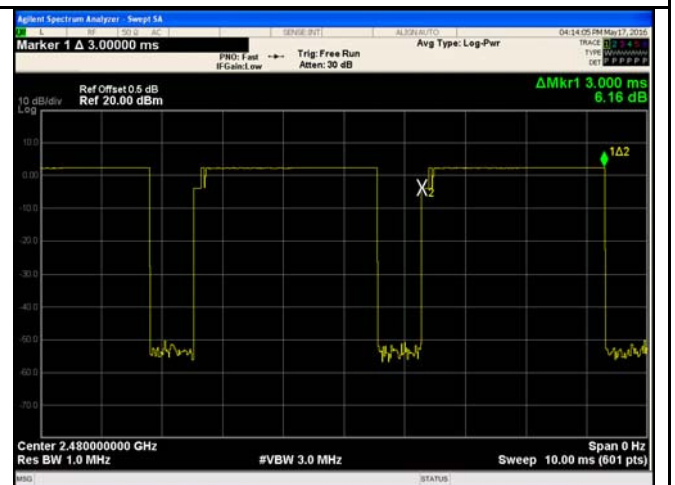

$\pi/4$ DQPSK - High CH 2480



8DPSK - Low CH 2402



8DPSK - Mid CH 2441

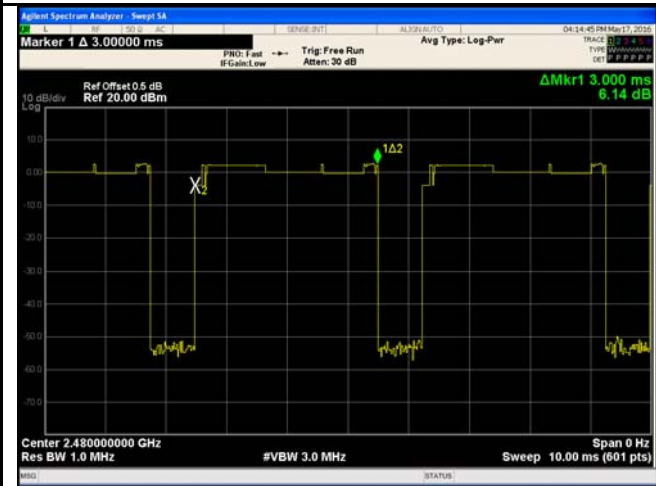

8DPSK - High CH 2480

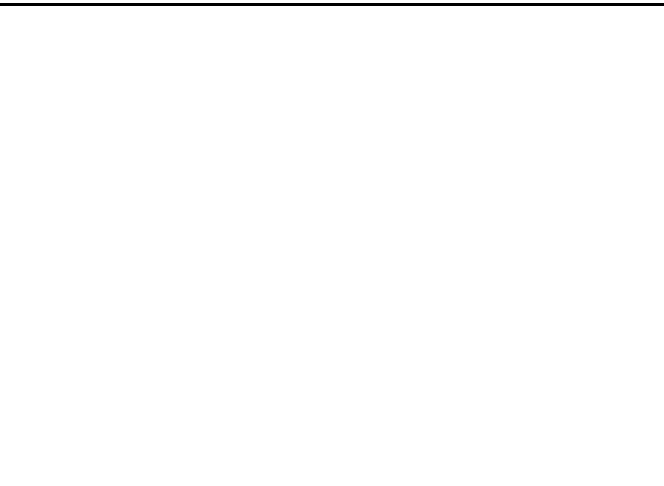

6.7 Band Edge & Restricted Band

Temperature	23°C
Relative Humidity	51%
Atmospheric Pressure	1018mbar
Test date :	May 18, 2016
Tested By :	Winnie Zhang

Requirement(s):

Spec	Item	Requirement	Applicable
§15.247(a) (1)(iii)	a)	In any 100 kHz bandwidth outside the frequency band in which the spread spectrum or digitally modulated intentional radiator is operating, the radio frequency power that is produced by the intentional radiator shall be at least 20 dB below that in the 100 kHz bandwidth within the band that contains the highest level of the desired power, based on either an RF conducted or a radiated measurement, provided the transmitter demonstrates compliance with the peak conducted power limits.	<input checked="" type="checkbox"/>

Test Setup	
------------	--

Test Procedure	<p>The test follows FCC Public Notice DA 00-705 Measurement Guidelines. Radiated Method Only</p> <ul style="list-style-type: none"> - 1. Check the calibration of the measuring instrument using either an internal calibrator or a known signal from an external generator. - 2. Position the EUT without connection to measurement instrument. Put it on the Rotated table and turn on the EUT and make it operate in transmitting mode. Then set it to Low Channel and High Channel within its operating range,
----------------	--

Test Report	16070511-FCC-R
Page	28 of 58

	<p>and make sure the instrument is operated in its linear range.</p> <ul style="list-style-type: none"> - 3. First, set both RBW and VBW of spectrum analyzer to 100 kHz with a convenient frequency span including 100kHz bandwidth from band edge, check the emission of EUT, if pass then set Spectrum Analyzer as below: <ul style="list-style-type: none"> a. The resolution bandwidth and video bandwidth of test receiver/spectrum analyzer is 120 kHz for Quasiy Peak detection at frequency below 1GHz. b. The resolution bandwidth of test receiver/spectrum analyzer is 1MHz and video bandwidth is 3MHz with Peak detection for Peak measurement at frequency above 1GHz. c. The resolution bandwidth of test receiver/spectrum analyzer is 1MHz and the video bandwidth is 10Hz with Peak detection for Average Measurement as below at frequency above 1GHz. - 4. Measure the highest amplitude appearing on spectral display and set it as a reference level. Plot the graph with marking the highest point and edge frequency. - 5. Repeat above procedures until all measured frequencies were complete.
Remark	
Result	<input checked="" type="checkbox"/> Pass <input type="checkbox"/> Fail

Test Data Yes N/A
 Test Plot Yes (See below) N/A

Test Plots

GFSK Mode:

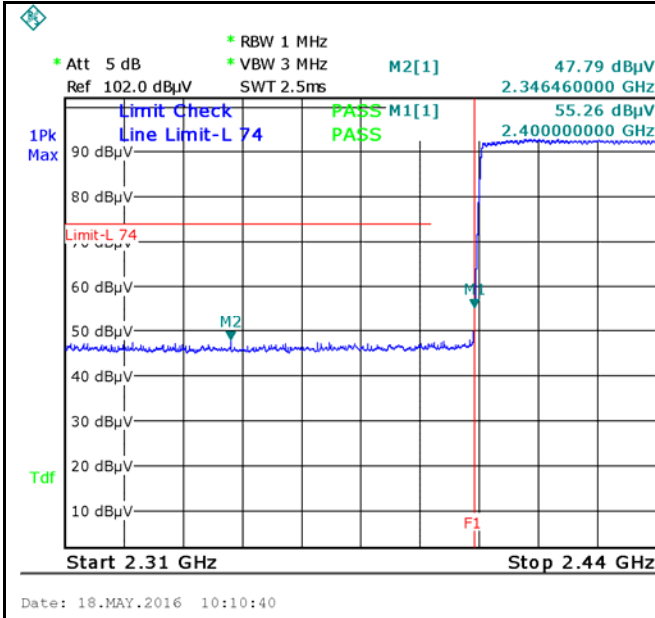

GFSK-Hopping Left Side-PK
 Note: F1 is frequency 2400MHz

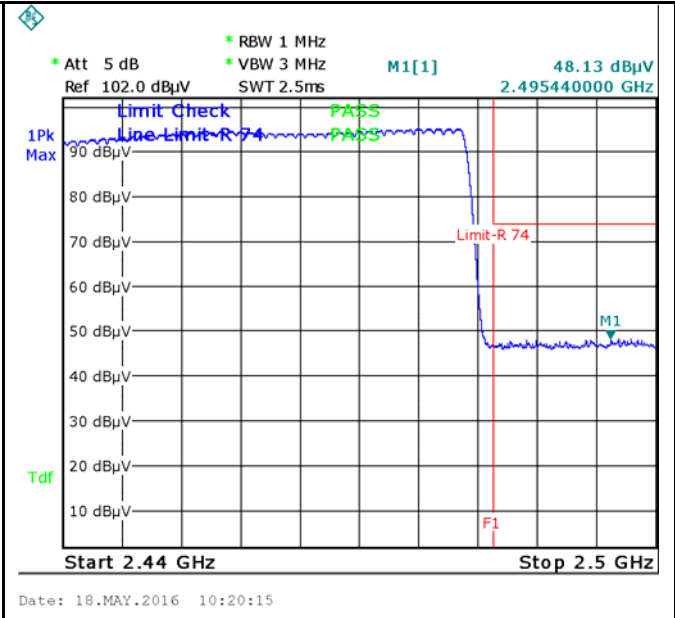

GFSK-Hopping Right Side-PK
 Note: F1 is frequency 2483.5MHz

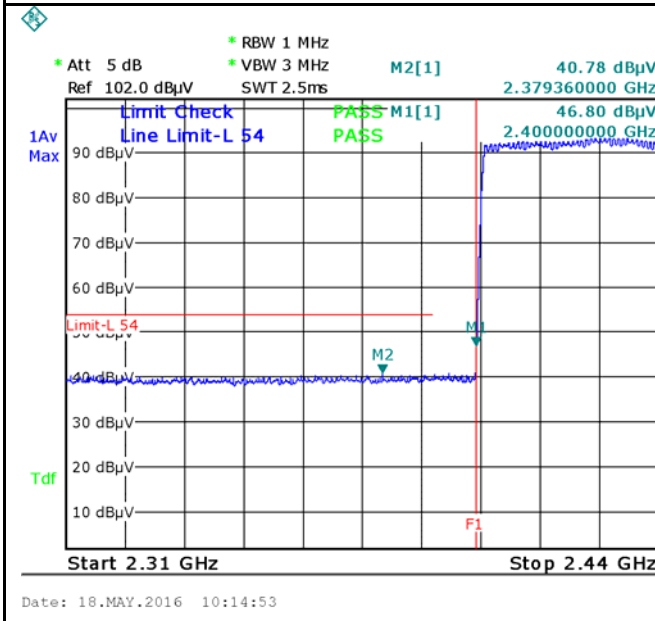

GFSK-Hopping Left Side-AV

Note: (no need if PK value less than the AV limit)

GFSK-Hopping Right Side-AV

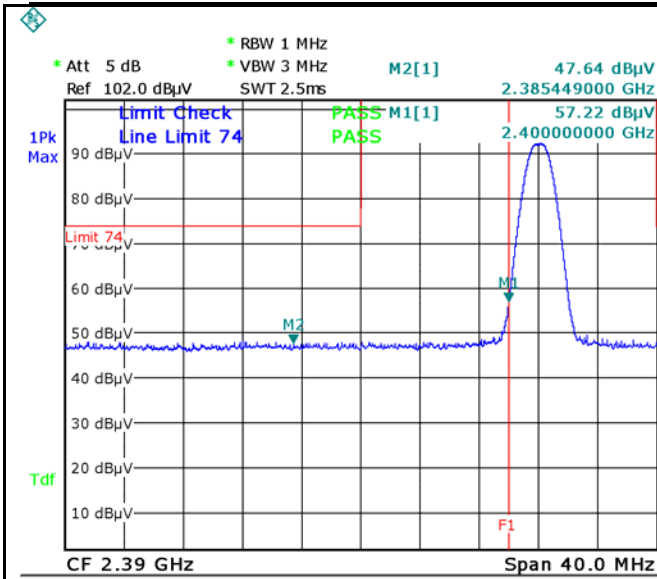

Date: 18.MAY.2016 09:41:39

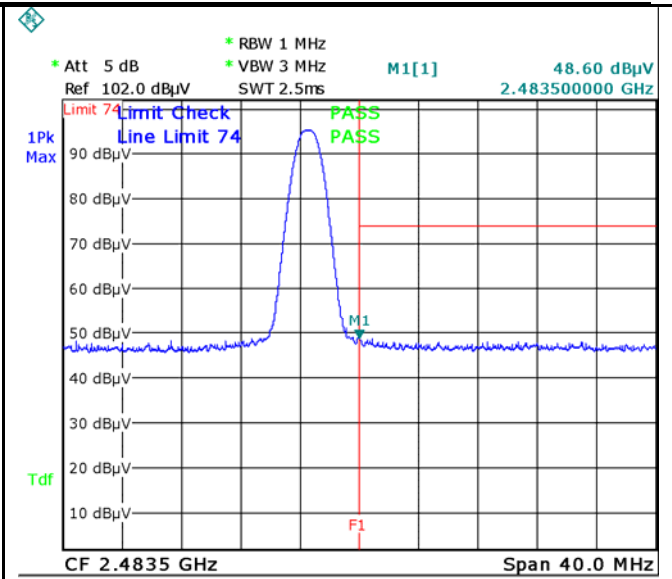

Date: 18.MAY.2016 09:51:01

GFSK-Left Side-PK

Note: F1 is frequency 2400MHz

GFSK-Right Side-PK

Note: F1 is frequency 2483.5MHz

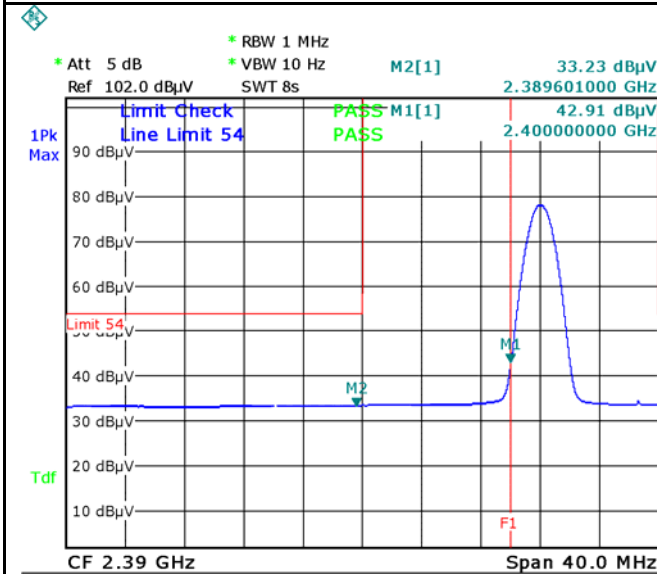

Date: 18.MAY.2016 09:48:44

Note: (no need if PK value less than the AV limit)

GFSK-Left Side-AV

GFSK-Right Side-AV

$\pi/4$ DQPSK Mode:

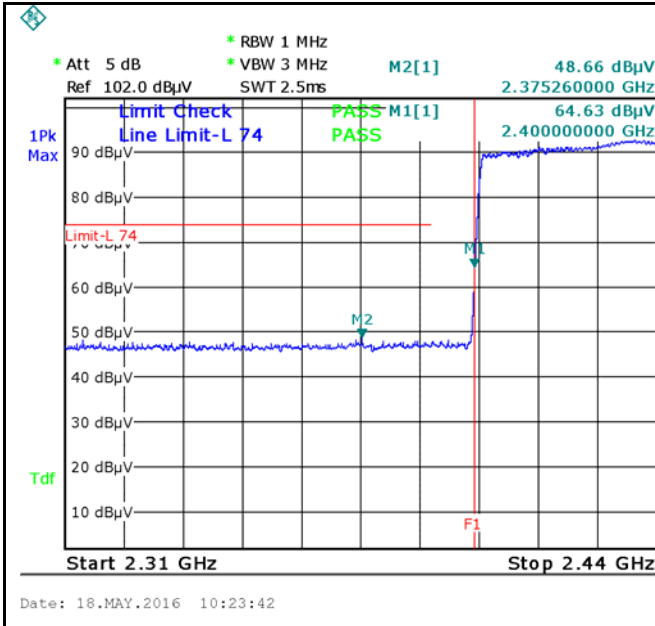

$\pi/4$ DQPSK-Hopping Left Side-PK
 Note: F1 is frequency 2400MHz

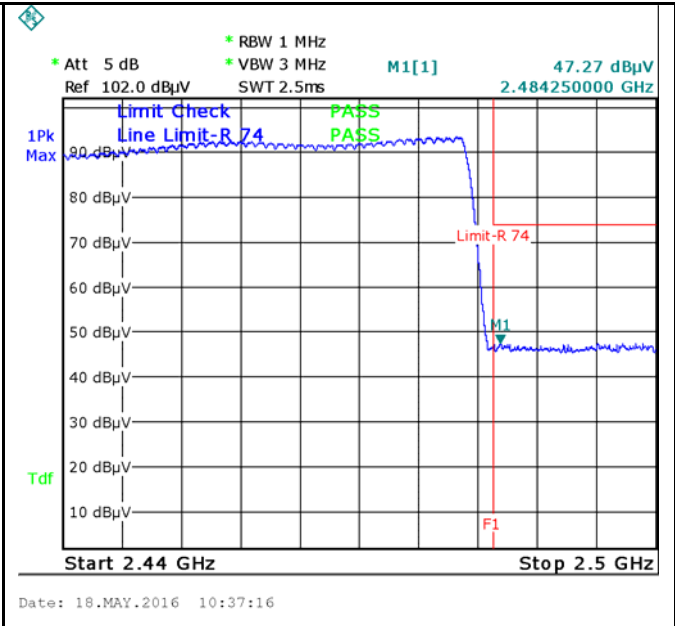

$\pi/4$ DQPSK-Hopping Right Side-PK
 Note: F1 is frequency 2483.5MHz

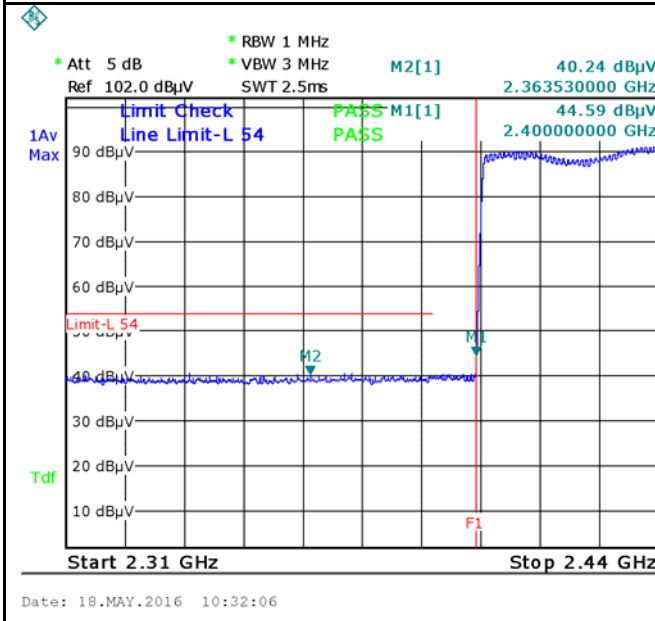

$\pi/4$ DQPSK-Hopping Left-AV

Note: (no need if PK value less than the AV limit)

$\pi/4$ DQPSK-Hopping Right-AV

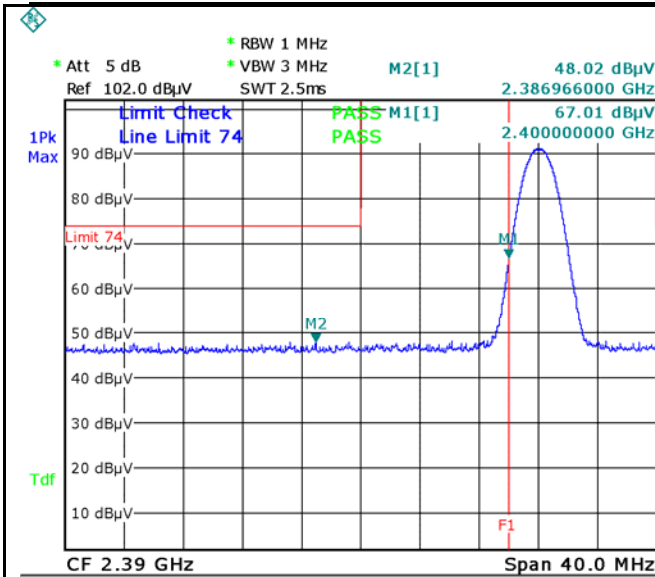

Date: 18.MAY.2016 09:54:22

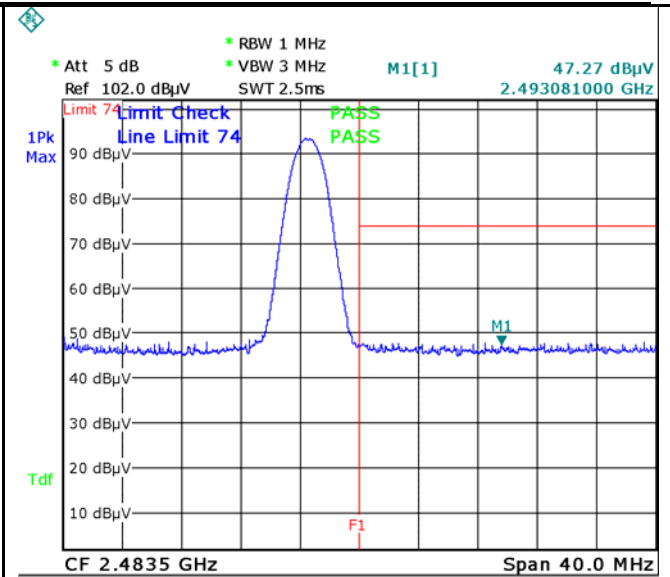

Date: 18.MAY.2016 09:57:38

$\pi/4$ DQPSK-Left Side-PK
Note: F1 is frequency 2400MHz

$\pi/4$ DQPSK-Right Side-PK
Note: F1 is frequency 2483.5MHz

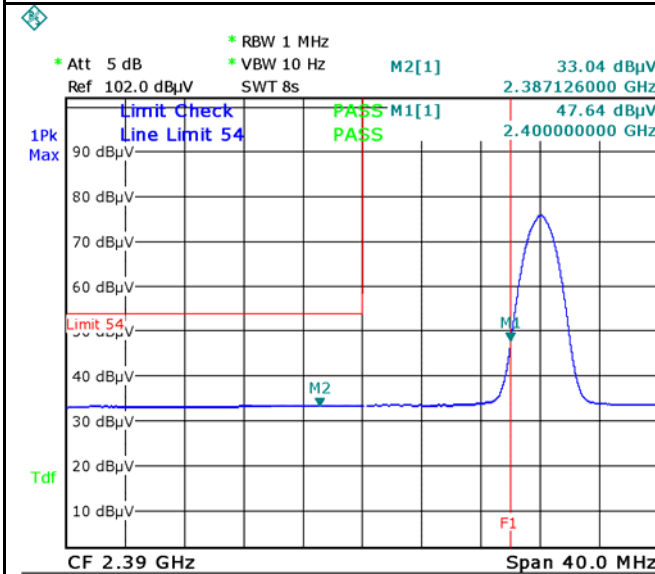

Date: 18.MAY.2016 09:55:31

Note: (no need if PK value less than the AV limit)

$\pi/4$ DQPSK-Left Side-AV

$\pi/4$ DQPSK-Right Side-AV

8DPSK Mode:

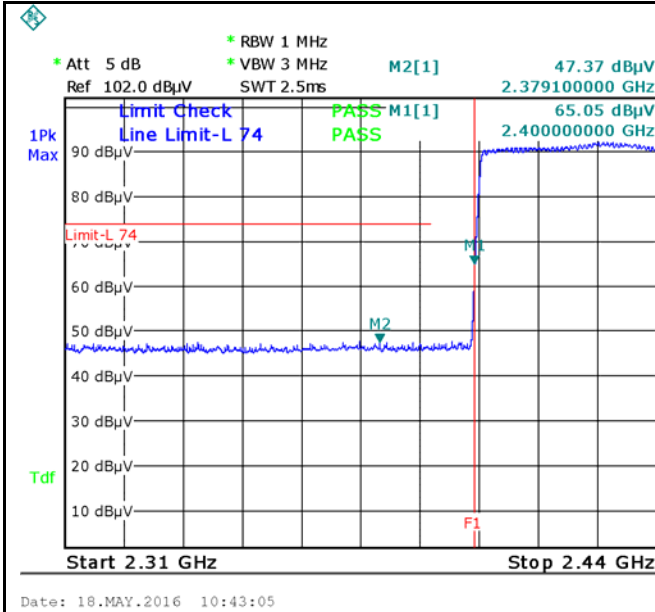

8DPSK-Hopping Left Side-PK
 Note: F1 is frequency 2400MHz

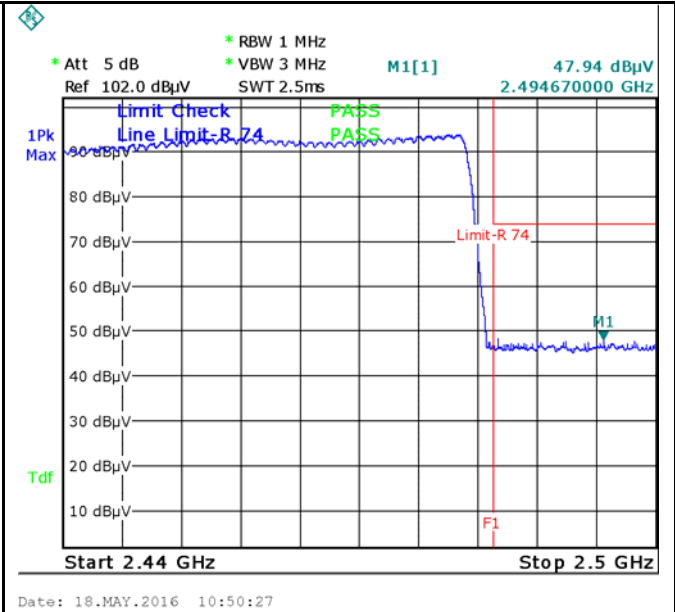

8DPSK--Hopping Right Side-PK
 Note: F1 is frequency 2483.5MHz

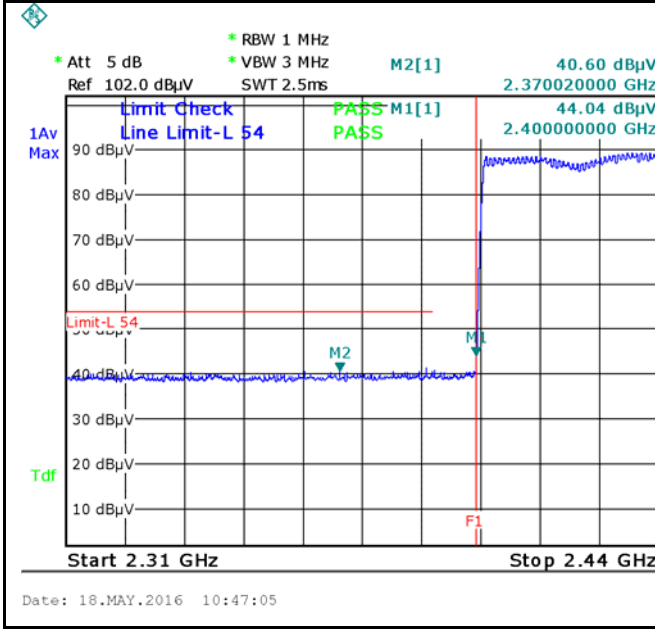

8DPSK--Hopping Left-AV

Note: (no need if PK value less than the AV limit)

8DPSK--Hopping Right-AV

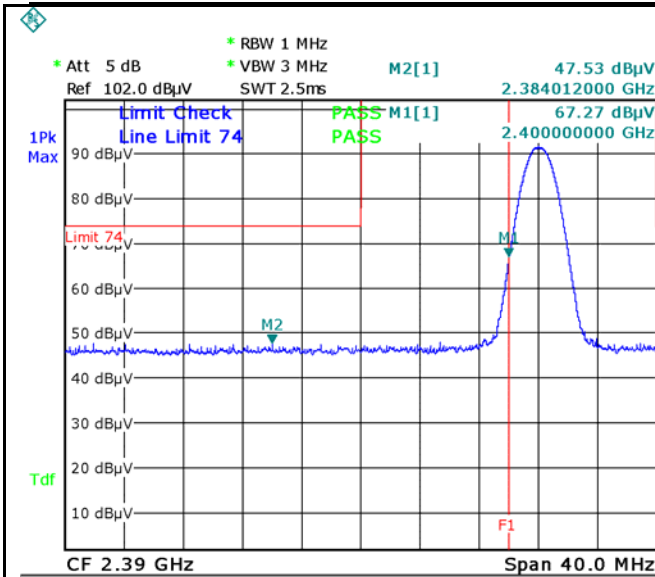

Date: 18.MAY.2016 10:00:33

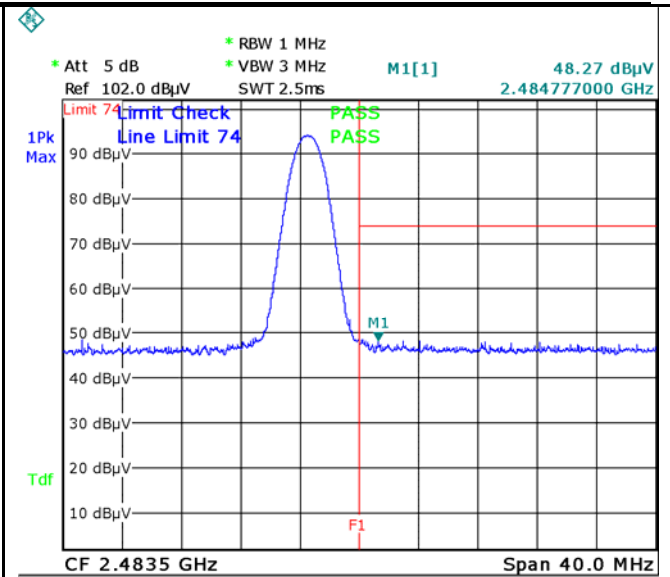

Date: 18.MAY.2016 10:06:45

8DPSK--Left Side-PK
Note: F1 is frequency 2400MHz

8DPSK--Right Side-PK
Note: F1 is frequency 2483.5MHz

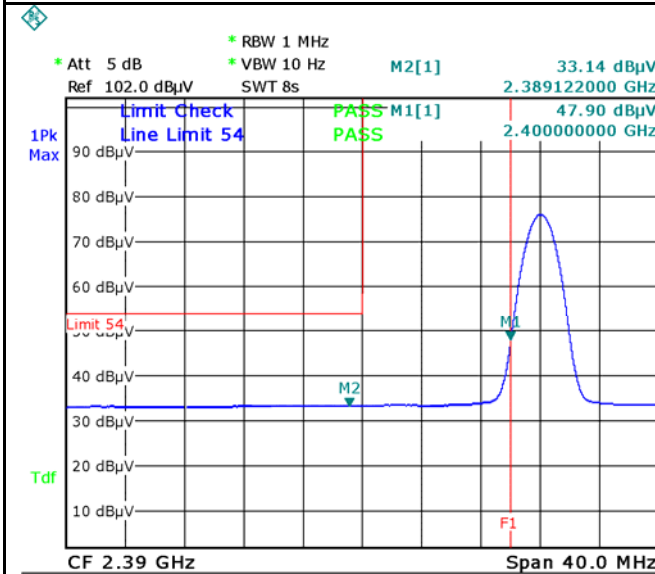

Date: 18.MAY.2016 10:02:58

Note: (no need if PK value less than the AV limit)

8DPSK--Left Side-AV

8DPSK--Right Side-AV

6.8 AC Power Line Conducted Emissions

Temperature	24°C
Relative Humidity	52%
Atmospheric Pressure	1019mbar
Test date :	May 19, 2016
Tested By :	Winnie Zhang

Requirement(s):

Spec	Item	Requirement	Applicable														
47CFR§15.207, RSS210 (A8.1)	a)	For Low-power radio-frequency devices that is designed to be connected to the public utility (AC) power line, the radio frequency voltage that is conducted back onto the AC power line on any frequency or frequencies, within the band 150 kHz to 30 MHz, shall not exceed the limits in the following table, as measured using a 50 [μ]H/50 ohms line impedance stabilization network (LISN). The lower limit applies at the boundary between the frequencies ranges.	<input checked="" type="checkbox"/>														
		<table border="1"> <thead> <tr> <th rowspan="2">Frequency ranges (MHz)</th> <th colspan="2">Limit (dBμV)</th> </tr> <tr> <th>QP</th> <th>Average</th> </tr> </thead> <tbody> <tr> <td>0.15 ~ 0.5</td> <td>66 – 56</td> <td>56 – 46</td> </tr> <tr> <td>0.5 ~ 5</td> <td>56</td> <td>46</td> </tr> <tr> <td>5 ~ 30</td> <td>60</td> <td>50</td> </tr> </tbody> </table>		Frequency ranges (MHz)	Limit (dBμV)		QP	Average	0.15 ~ 0.5	66 – 56	56 – 46	0.5 ~ 5	56	46	5 ~ 30	60	50
		Frequency ranges (MHz)			Limit (dBμV)												
				QP	Average												
0.15 ~ 0.5	66 – 56	56 – 46															
0.5 ~ 5	56	46															
5 ~ 30	60	50															

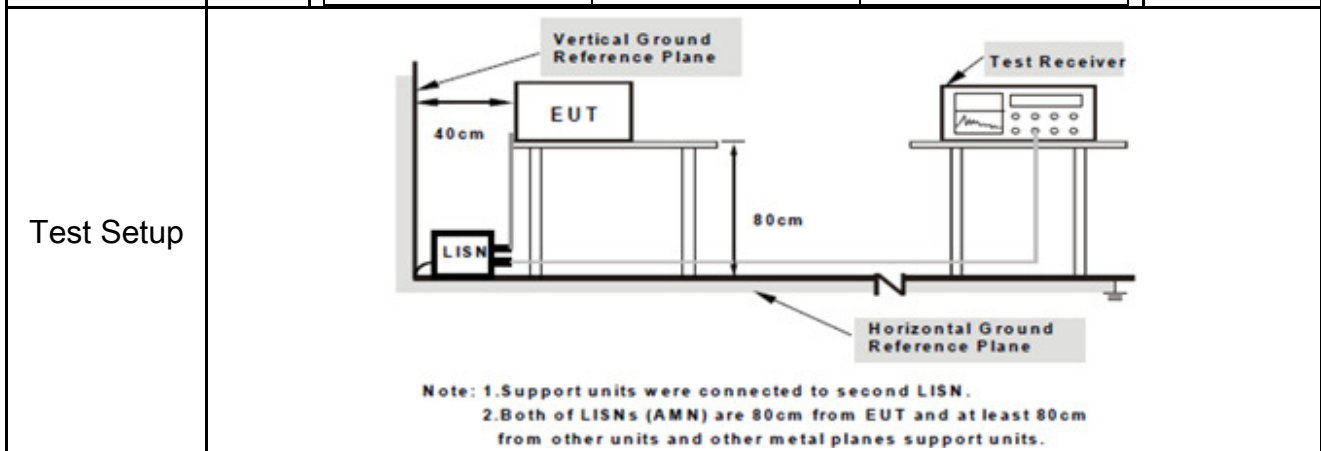

Procedure	<ol style="list-style-type: none"> The EUT and supporting equipment were set up in accordance with the requirements of the standard on top of a 1.5m x 1m x 0.8m high, non-metallic table. The power supply for the EUT was fed through a 50W/50mH EUT LISN, connected to filtered mains. The RF OUT of the EUT LISN was connected to the EMI test receiver via a low-loss
-----------	---

Test Report	16070511-FCC-R
Page	36 of 58

	<p>coaxial cable.</p> <ol style="list-style-type: none"> 4. All other supporting equipment were powered separately from another main supply. 5. The EUT was switched on and allowed to warm up to its normal operating condition. 6. A scan was made on the NEUTRAL line (for AC mains) or Earth line (for DC power) over the required frequency range using an EMI test receiver. 7. High peaks, relative to the limit line, The EMI test receiver was then tuned to the selected frequencies and the necessary measurements made with a receiver bandwidth setting of 10 kHz. 8. Step 7 was then repeated for the LIVE line (for AC mains) or DC line (for DC power).
Remark	
Result	<input checked="" type="checkbox"/> Pass <input type="checkbox"/> Fail

Test Data Yes N/A

Test Plot Yes (See below) N/A

Test Mode :	Bluetooth Mode
-------------	----------------

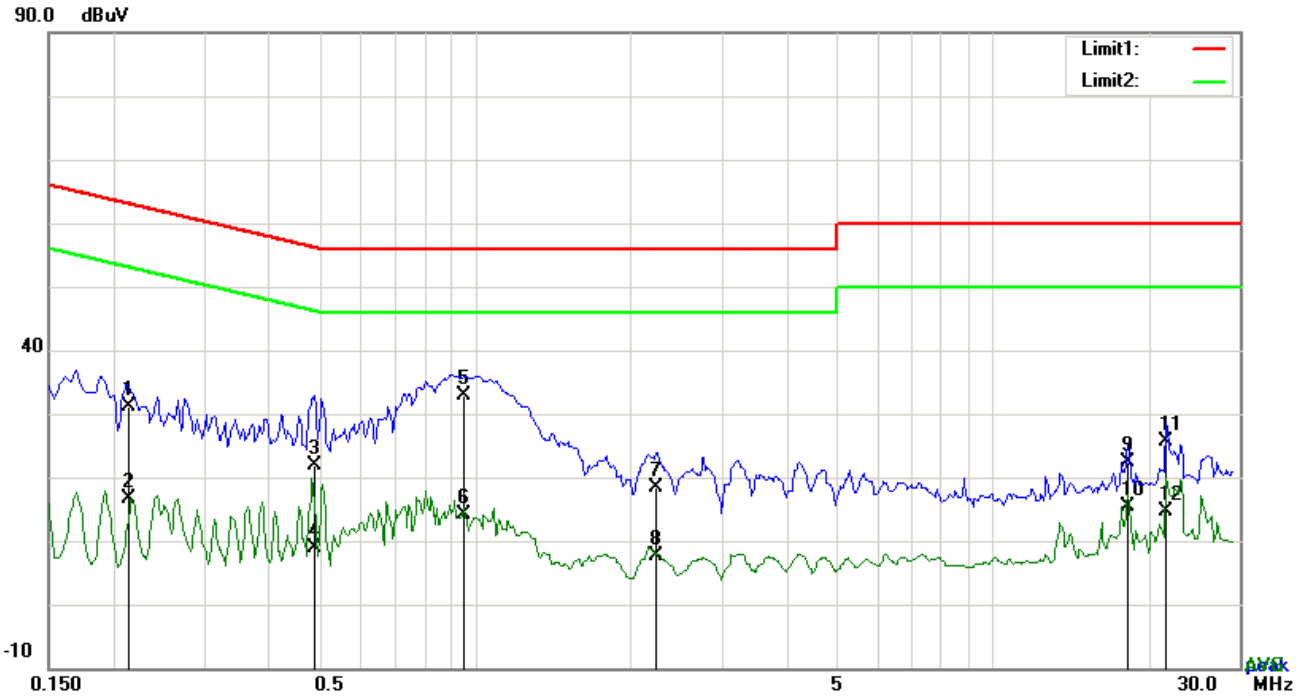

Test Data

Phase Line Plot at 120Vac, 60Hz

No.	P/L	Frequency	Reading	Detector	Corrected	Result	Limit	Margin
		(MHz)	(dBuV)		(dB)	(dBuV)	(dBuV)	(dB)
1	L1	0.2139	21.13	QP	10.03	31.16	63.05	-31.89
2	L1	0.2139	6.64	AVG	10.03	16.67	53.05	-36.38
3	L1	0.4893	11.92	QP	10.03	21.95	56.18	-34.23
4	L1	0.4893	-1.11	AVG	10.03	8.92	46.18	-37.26
5	L1	0.9495	22.94	QP	10.03	32.97	56.00	-23.03
6	L1	0.9495	4.13	AVG	10.03	14.16	46.00	-31.84
7	L1	2.2482	8.38	QP	10.05	18.43	56.00	-37.57
8	L1	2.2482	-2.42	AVG	10.05	7.63	46.00	-38.37
9	L1	18.2451	12.20	QP	10.27	22.47	60.00	-37.53
10	L1	18.2451	5.23	AVG	10.27	15.50	50.00	-34.50
11	L1	21.6654	15.35	QP	10.33	25.68	60.00	-34.32
12	L1	21.6654	4.39	AVG	10.33	14.72	50.00	-35.28

Test Mode : Bluetooth Mode

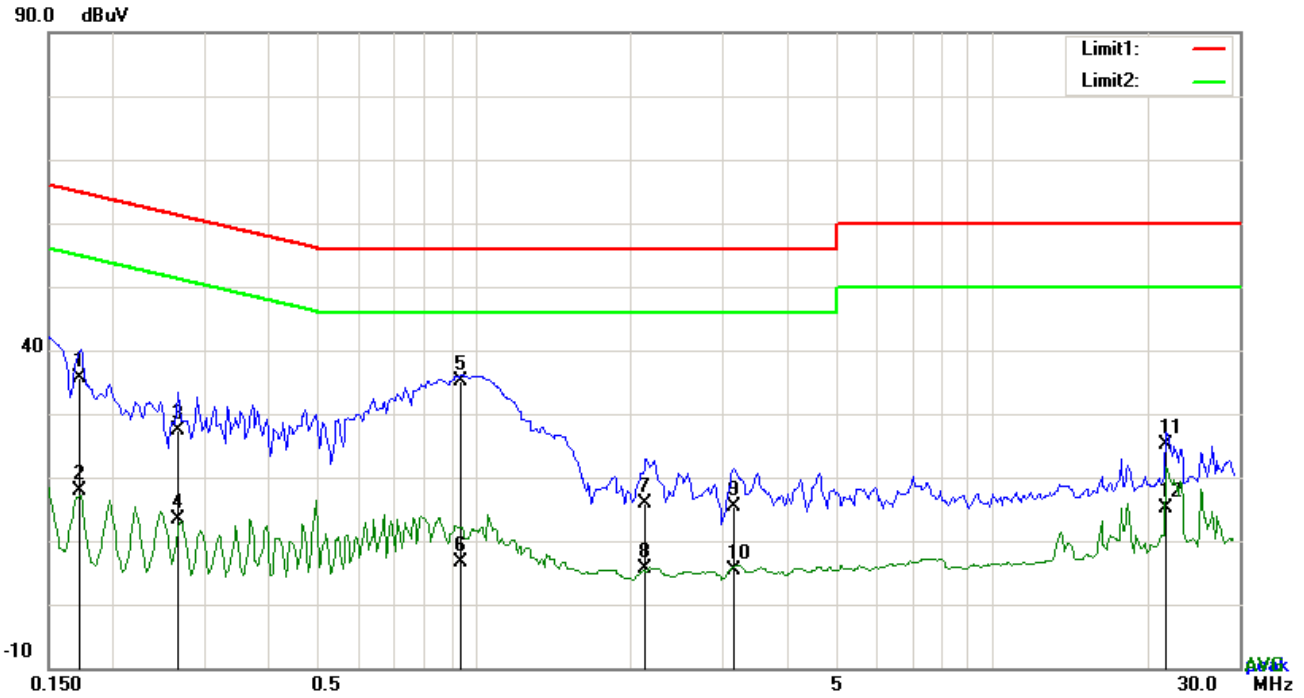

Test Data

Phase Neutral Plot at 120Vac, 60Hz

No.	P/L	Frequency	Reading	Detector	Corrected	Result	Limit	Margin
		(MHz)	(dBuV)		(dB}	(dBuV)	(dBuV)	(dB)
1	N	0.1722	25.56	QP	10.02	35.58	64.85	-29.27
2	N	0.1722	7.97	AVG	10.02	17.99	54.85	-36.86
3	N	0.2670	17.44	QP	10.02	27.46	61.21	-33.75
4	N	0.2670	3.38	AVG	10.02	13.40	51.21	-37.81
5	N	0.9417	25.19	QP	10.03	35.22	56.00	-20.78
6	N	0.9417	-3.45	AVG	10.03	6.58	46.00	-39.42
7	N	2.1429	5.87	QP	10.04	15.91	56.00	-40.09
8	N	2.1429	-4.42	AVG	10.04	5.62	46.00	-40.38
9	N	3.1716	5.26	QP	10.05	15.31	56.00	-40.69
10	N	3.1716	-4.64	AVG	10.05	5.41	46.00	-40.59
11	N	21.6654	14.94	QP	10.29	25.23	60.00	-34.77
12	N	21.6654	4.72	AVG	10.29	15.01	50.00	-34.99

Test Mode :	Bluetooth Mode
--------------------	-----------------------

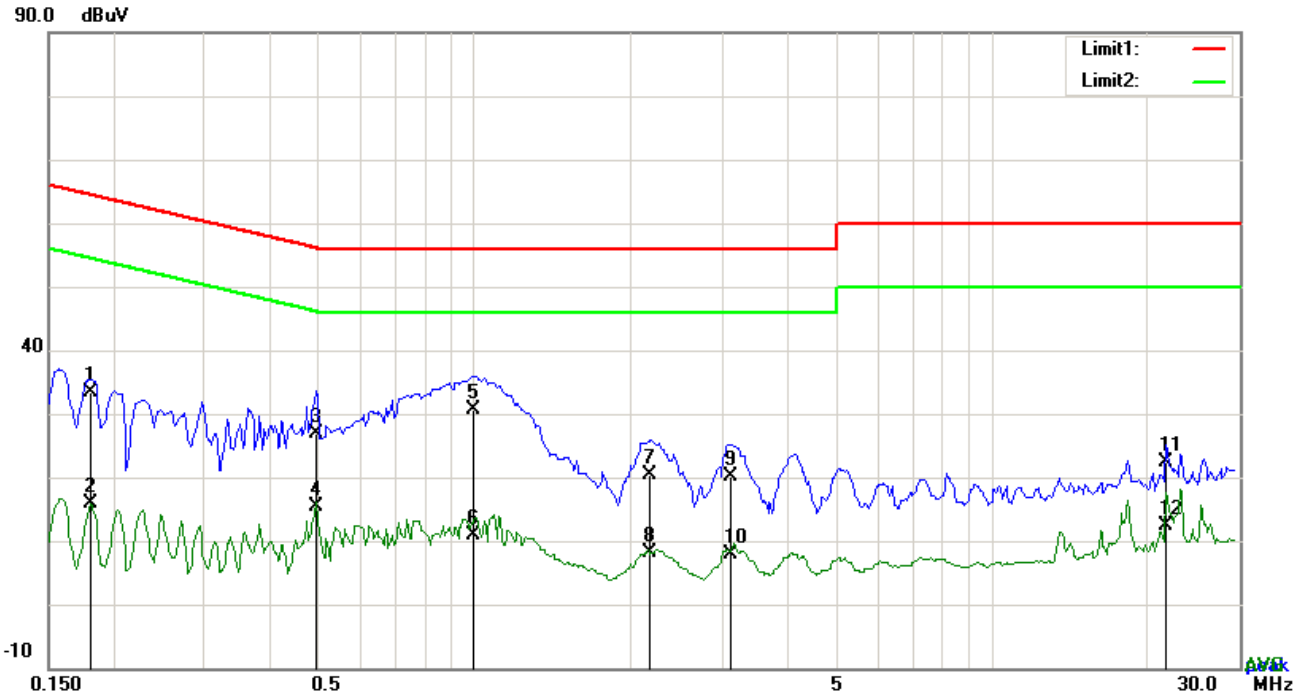

Test Data

Phase Line Plot at 240Vac, 60Hz

No.	P/L	Frequency	Reading	Detector	Corrected	Result	Limit	Margin
		(MHz)	(dBuV)		(dB)	(dBuV)	(dBuV)	(dB)
1	L1	0.1812	23.40	QP	10.03	33.43	64.43	-31.00
2	L1	0.1812	5.75	AVG	10.03	15.78	54.43	-38.65
3	L1	0.4932	16.75	QP	10.03	26.78	56.11	-29.33
4	L1	0.4932	5.28	AVG	10.03	15.31	46.11	-30.80
5	L1	0.9944	20.71	QP	10.03	30.74	56.00	-25.26
6	L1	0.9944	0.96	AVG	10.03	10.99	46.00	-35.01
7	L1	2.1858	10.34	QP	10.04	20.38	56.00	-35.62
8	L1	2.1858	-1.86	AVG	10.04	8.18	46.00	-37.82
9	L1	3.1170	10.00	QP	10.06	20.06	56.00	-35.94
10	L1	3.1170	-2.23	AVG	10.06	7.83	46.00	-38.17
11	L1	21.6654	12.13	QP	10.33	22.46	60.00	-37.54
12	L1	21.6654	2.07	AVG	10.33	12.40	50.00	-37.60

Test Mode :	Bluetooth Mode
--------------------	-----------------------

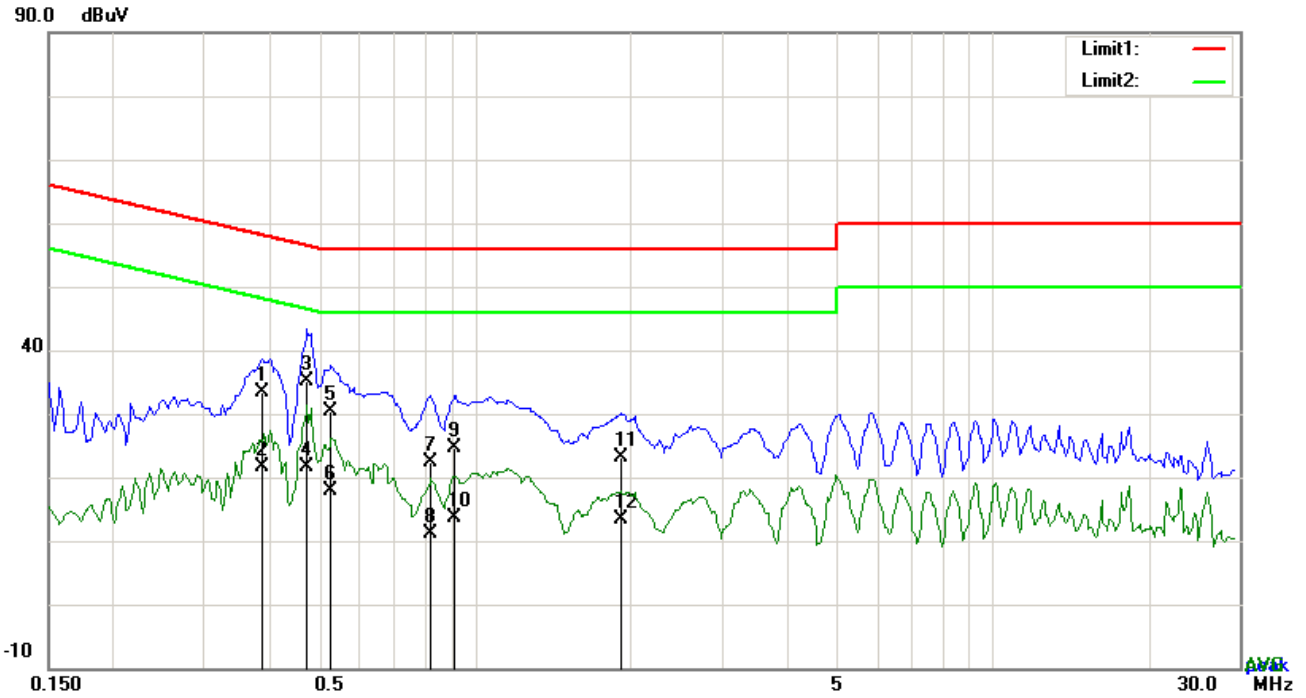

Test Data

Phase Neutral Plot at 240Vac, 60Hz

No.	P/L	Frequency	Reading	Detector	Corrected	Result	Limit	Margin
		(MHz)	(dBuV)		(dB}	(dBuV)	(dBuV)	(dB)
1	N	0.1773	23.67	QP	10.02	33.69	64.61	-30.92
2	N	0.1773	6.02	AVG	10.02	16.04	54.61	-38.57
3	N	0.2982	11.28	QP	10.02	21.30	60.29	-38.99
4	N	0.2982	-4.18	AVG	10.02	5.84	50.29	-44.45
5	N	0.4893	20.65	QP	10.02	30.67	56.18	-25.51
6	N	0.4893	7.01	AVG	10.02	17.03	46.18	-29.15
7	N	1.0002	21.22	QP	10.03	31.25	56.00	-24.75
8	N	1.0002	1.31	AVG	10.03	11.34	46.00	-34.66
9	N	2.1039	8.57	QP	10.04	18.61	56.00	-37.39
10	N	2.1039	-1.45	AVG	10.04	8.59	46.00	-37.41
11	N	21.6654	13.80	QP	10.29	24.09	60.00	-35.91
12	N	21.6654	3.62	AVG	10.29	13.91	50.00	-36.09

6.9 Radiated Emissions & Restricted Band

Temperature	24°C
Relative Humidity	52%
Atmospheric Pressure	1019mbar
Test date :	May 19, 2016
Tested By :	Winnie Zhang

Requirement(s):

Spec	Item	Requirement	Applicable										
47CFR§15.205, §15.209, §15.247(d)	a)	<p>Except higher limit as specified elsewhere in other section, the emissions from the low-power radio-frequency devices shall not exceed the field strength levels specified in the following table and the level of any unwanted emissions shall not exceed the level of the fundamental emission. The tighter limit applies at the band edges</p> <table border="1"> <thead> <tr> <th>Frequency range (MHz)</th> <th>Field Strength ($\mu\text{V/m}$)</th> </tr> </thead> <tbody> <tr> <td>30 – 88</td> <td>100</td> </tr> <tr> <td>88 – 216</td> <td>150</td> </tr> <tr> <td>216 960</td> <td>200</td> </tr> <tr> <td>Above 960</td> <td>500</td> </tr> </tbody> </table>	Frequency range (MHz)	Field Strength ($\mu\text{V/m}$)	30 – 88	100	88 – 216	150	216 960	200	Above 960	500	<input checked="" type="checkbox"/>
Frequency range (MHz)	Field Strength ($\mu\text{V/m}$)												
30 – 88	100												
88 – 216	150												
216 960	200												
Above 960	500												

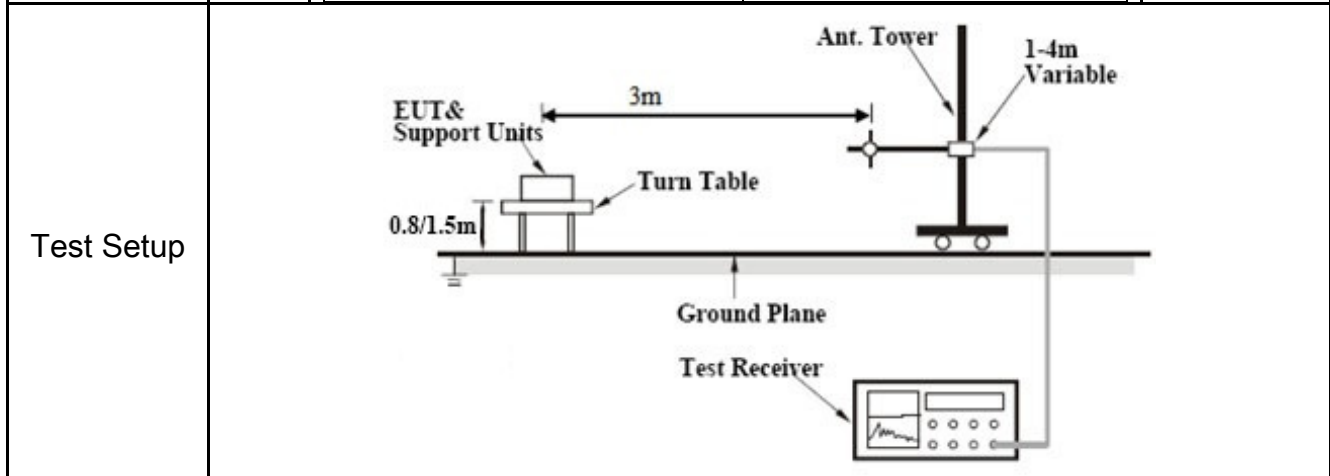

Procedure	<ol style="list-style-type: none"> The EUT was switched on and allowed to warm up to its normal operating condition. The test was carried out at the selected frequency points obtained from the EUT characterization. Maximization of the emissions, was carried out by rotating the EUT, changing the antenna polarization, and adjusting the antenna height in the following manner:
-----------	---

Test Report	16070511-FCC-R
Page	42 of 58

	<p>a. Vertical or horizontal polarization (whichever gave the higher emission level over a full rotation of the EUT) was chosen.</p> <p>b. The EUT was then rotated to the direction that gave the maximum emission.</p> <p>c. Finally, the antenna height was adjusted to the height that gave the maximum emission.</p> <p>3. The resolution bandwidth and video bandwidth of test receiver/spectrum analyzer is 120 kHz for Quasiy Peak detection at frequency below 1GHz.</p> <p>4. The resolution bandwidth of test receiver/spectrum analyzer is 1MHz and video bandwidth is 3MHz with Peak detection for Peak measurement at frequency above 1GHz. The resolution bandwidth of test receiver/spectrum analyzer is 1MHz and the video bandwidth is 10Hz with Peak detection for Average Measurement as below at frequency above 1GHz.</p> <p>5. Steps 2 and 3 were repeated for the next frequency point, until all selected frequency points were measured.</p>
Remark	
Result	<input checked="" type="checkbox"/> Pass <input type="checkbox"/> Fail

Test Data Yes N/A

Test Plot Yes (See below) N/A

Test Mode: Bluetooth Mode

Below 1GHz

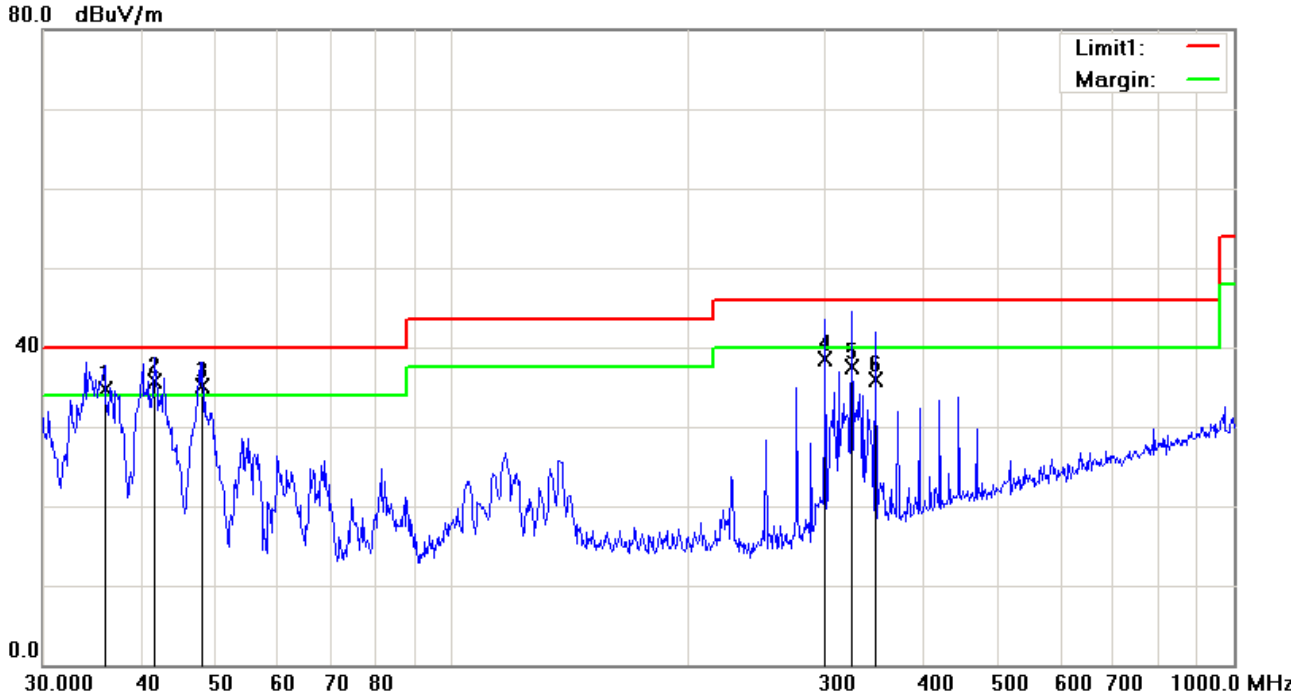

Test Data

Horizontal Polarity Plot @3m

No.	P/L	Frequency (MHz)	Reading (dBuV/m)	Detector	Corrected (dB/m)	Result (dBuV/m)	Limit (dBuV/m)	Margin (dB)	Height (cm)	Degree (°)
1	H	36.0007	39.35	QP	-4.67	34.68	40.00	-5.32	100	176
2	H	41.7130	44.43	QP	-8.73	35.70	40.00	-4.30	100	158
3	H	47.9940	47.32	QP	-12.28	35.04	40.00	-4.96	100	188
4	H	300.3673	45.37	QP	-6.89	38.48	46.00	-7.52	100	86
5	H	324.4561	43.64	QP	-6.20	37.44	46.00	-8.56	100	101
6	H	348.0274	41.37	QP	-5.52	35.85	46.00	-10.15	100	128

Below 1GHz

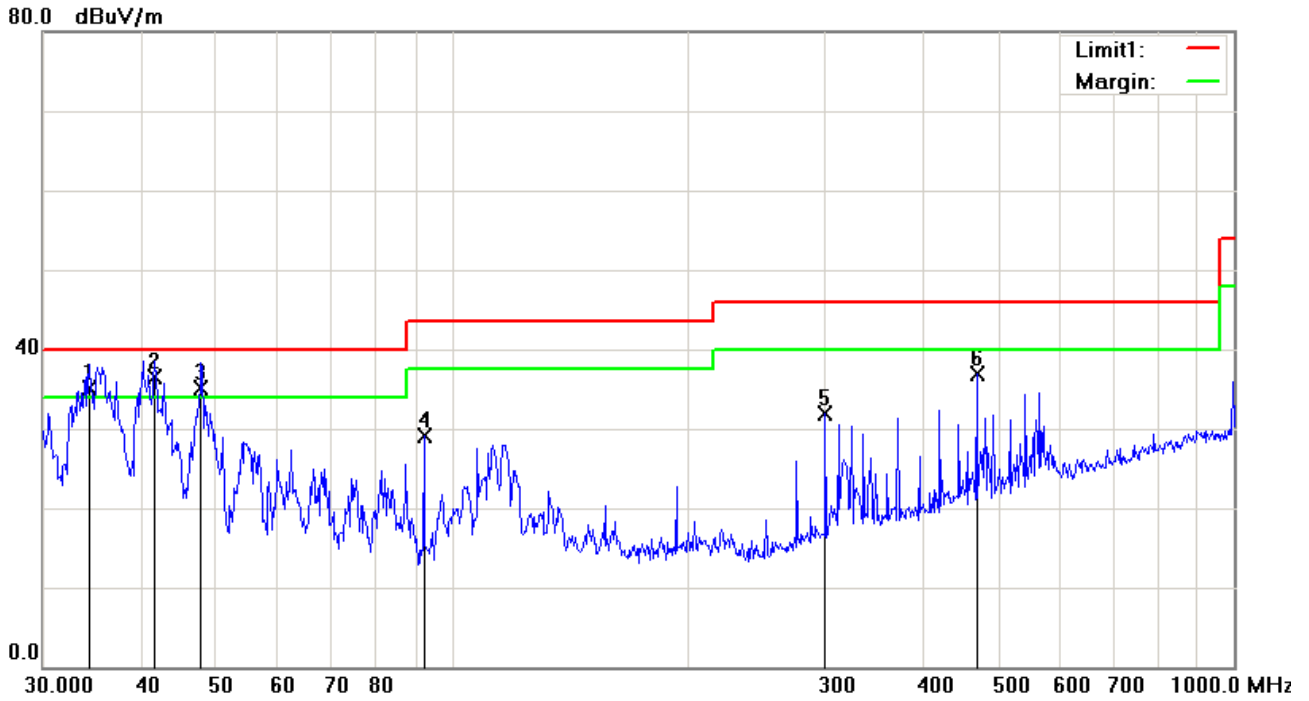

Test Data

Vertical Polarity Plot @3m

No.	P/L	Frequency (MHz)	Reading (dBuV/m)	Detector	Corrected (dB/m)	Result (dBuV/m)	Limit (dBuV/m)	Margin (dB)	Height (cm)	Degree (°)
1	V	34.3964	38.70	QP	-3.50	35.20	40.00	-4.80	100	284
2	V	41.7130	45.29	QP	-8.73	36.56	40.00	-3.44	100	93
3	V	47.8260	47.40	QP	-12.20	35.20	40.00	-4.80	100	29
4	V	92.1388	41.89	peak	-12.84	29.05	43.50	-14.45	100	160
5	V	300.3673	38.78	peak	-6.89	31.89	46.00	-14.11	100	0
6	V	468.8762	39.54	peak	-2.55	36.99	46.00	-9.01	100	299

Test Mode:	Transmitting Mode
-------------------	--------------------------

Low Channel (2402 MHz)(π /4 DQPSK Worst Case)

Frequency (MHz)	S.A. Reading (dB μ V)	Detector (PK/AV)	Polarity (H/V)	Ant. Factor (dB/m)	Cable Loss (dB)	Pre-Amp. Gain (dB)	Cord. Amp. (dB μ V/m)	Limit (dB μ V/m)	Margin (dB)
4804	38.66	AV	V	33.67	6.86	32.66	46.53	54	-7.47
4804	38.51	AV	H	33.67	6.86	32.66	46.38	54	-7.62
4804	47.95	PK	V	33.67	6.86	32.66	55.82	74	-18.18
4804	47.38	PK	H	33.67	6.86	32.66	55.25	74	-18.75
17793	24.53	AV	V	45.03	11.21	32.38	48.39	54	-5.61
17793	24.29	AV	H	45.03	11.21	32.38	48.15	54	-5.85
17793	40.91	PK	V	45.03	11.21	32.38	64.77	74	-9.23
17793	40.65	PK	H	45.03	11.21	32.38	64.51	74	-9.49

Middle Channel (2441 MHz) (π /4 DQPSK Worst Case)

Frequency (MHz)	S.A. Reading (dB μ V)	Detector (PK/AV)	Polarity (H/V)	Ant. Factor (dB/m)	Cable Loss (dB)	Pre-Amp. Gain (dB)	Cord. Amp. (dB μ V/m)	Limit (dB μ V/m)	Margin (dB)
4882	38.75	AV	V	33.71	6.95	32.74	46.67	54	-7.33
4882	38.63	AV	H	33.71	6.95	32.74	46.55	54	-7.45
4882	48.01	PK	V	33.71	6.95	32.74	55.93	74	-18.07
4882	47.67	PK	H	33.71	6.95	32.74	55.59	74	-18.41
17807	24.16	AV	V	45.15	11.18	32.41	48.08	54	-5.92
17807	24.02	AV	H	45.15	11.18	32.41	47.94	54	-6.06
17807	41.25	PK	V	45.15	11.18	32.41	65.17	74	-8.83
17807	40.79	PK	H	45.15	11.18	32.41	64.71	74	-9.29

High Channel (2480 MHz) (8DPSK Worst Case)

Frequency (MHz)	S.A. Reading (dB μ V)	Detector (PK/AV)	Polarity (H/V)	Ant. Factor (dB/m)	Cable Loss (dB)	Pre-Amp. Gain (dB)	Cord. Amp. (dB μ V/m)	Limit (dB μ V/m)	Margin (dB)
4960	38.59	AV	V	33.9	6.76	32.74	46.51	54	-7.49
4960	38.46	AV	H	33.9	6.76	32.74	46.38	54	-7.62
4960	48.12	PK	V	33.9	6.76	32.74	56.04	74	-17.96
4960	47.95	PK	H	33.9	6.76	32.74	55.87	74	-18.13
17795	24.72	AV	V	45.22	11.35	32.38	48.91	54	-5.09
17795	24.48	AV	H	45.22	11.35	32.38	48.67	54	-5.33
17795	41.35	PK	V	45.22	11.35	32.38	65.54	74	-8.46
17795	41.09	PK	H	45.22	11.35	32.38	65.28	74	-8.72

Note:

- 1, The testing has been conformed to $10 \times 2480 \text{MHz} = 24,800 \text{MHz}$
- 2, All other emissions more than 30 dB below the limit

Annex A. TEST INSTRUMENT

Instrument	Model	Serial #	Cal Date	Cal Due	In use
AC Line Conducted					
EMI test receiver	ESCS30	8471241027	09/17/2015	09/16/2016	<input checked="" type="checkbox"/>
Line Impedance	LI-125A	191106	09/25/2015	09/24/2016	<input checked="" type="checkbox"/>
Line Impedance	LI-125A	191107	09/25/2015	09/24/2016	<input checked="" type="checkbox"/>
LISN	ISN T800	34373	09/25/2015	09/24/2016	<input checked="" type="checkbox"/>
Double Ridge Horn Antenna (1 ~18GHz)	AH-118	71283	09/24/2015	09/23/2016	<input checked="" type="checkbox"/>
Transient Limiter	LIT-153	531118	09/01/2015	08/31/2016	<input checked="" type="checkbox"/>
RF conducted test					
Agilent ESA-E SERIES	E4407B	MY45108319	09/17/2015	09/16/2016	<input checked="" type="checkbox"/>
Power Splitter	1#	1#	09/01/2015	08/31/2016	<input checked="" type="checkbox"/>
DC Power Supply	E3640A	MY40004013	09/17/2015	09/16/2016	<input checked="" type="checkbox"/>
Radiated Emissions					
EMI test receiver	ESL6	100262	09/17/2015	09/16/2016	<input checked="" type="checkbox"/>
Positioning Controller	UC3000	MF780208282	11/19/2015	11/18/2016	<input checked="" type="checkbox"/>
OPT 010 AMPLIFIER (0.1-1300MHz)	8447E	2727A02430	09/01/2015	08/31/2016	<input checked="" type="checkbox"/>
Microwave Preamplifier (1 ~ 26.5GHz)	8449B	3008A02402	03/24/2016	03/23/2017	<input checked="" type="checkbox"/>
Bilog Antenna (30MHz~6GHz)	JB6	A110712	09/21/2015	09/20/2016	<input checked="" type="checkbox"/>
Double Ridge Horn Antenna (1 ~18GHz)	AH-118	71283	09/24/2015	09/23/2016	<input checked="" type="checkbox"/>
Universal Radio Communication Tester	CMU200	121393	09/25/2015	09/24/2016	<input checked="" type="checkbox"/>

Annex B. EUT And Test Setup Photographs

Annex B.i. Photograph: EUT External Photo



Whole Package View



EUT - Front View

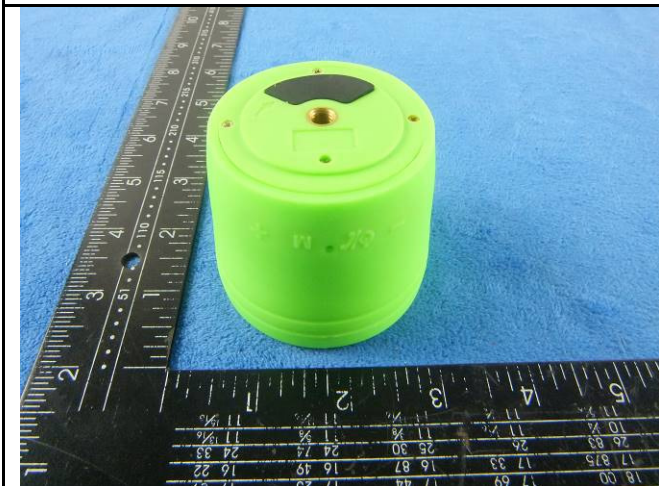

EUT - Rear View



EUT - Top View

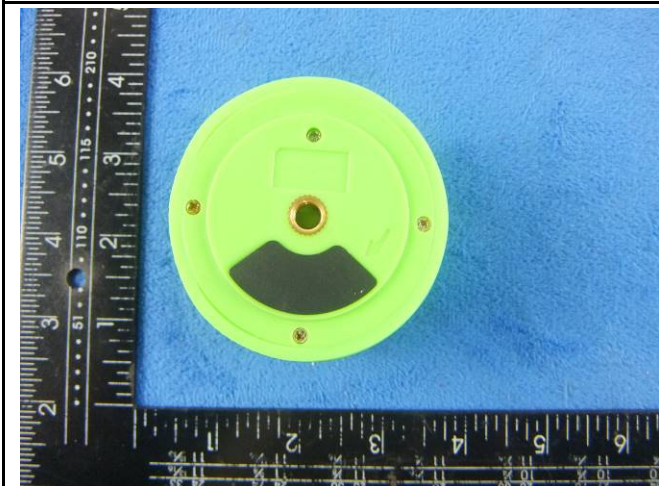

EUT - Bottom View



EUT - Left View

Test Report	16070511-FCC-R
Page	49 of 58

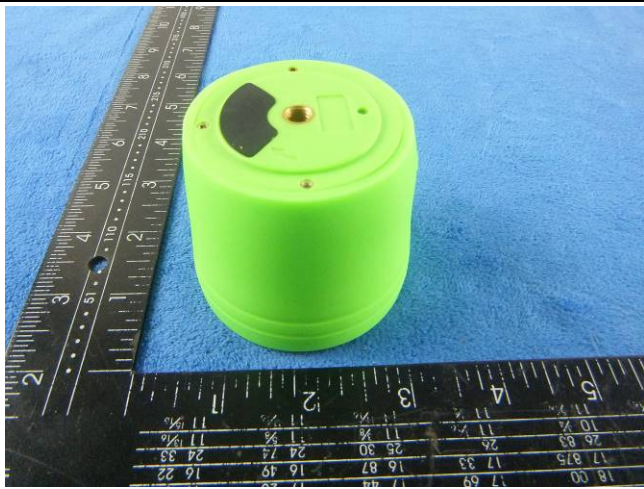

EUT - Right View

Annex B.ii. Photograph: EUT Internal Photo

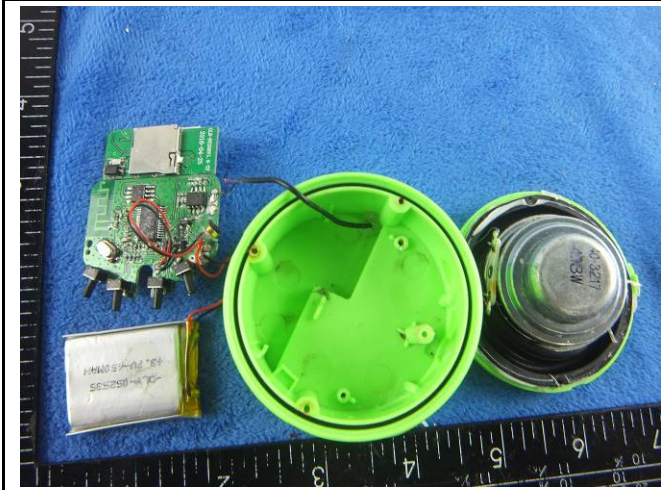

Cover Off - Top View

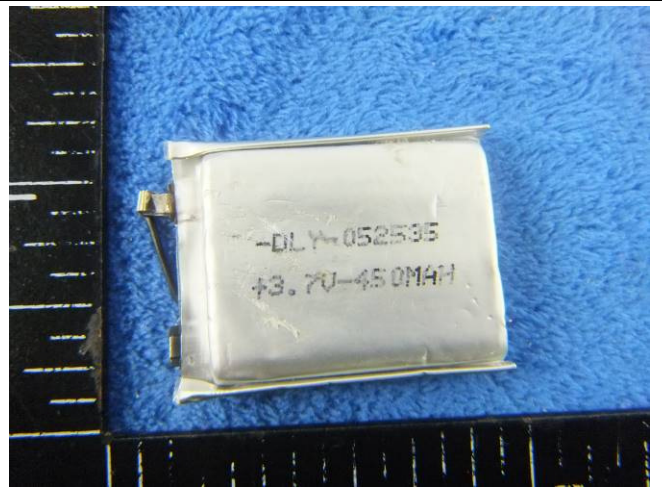

Battery - Front View

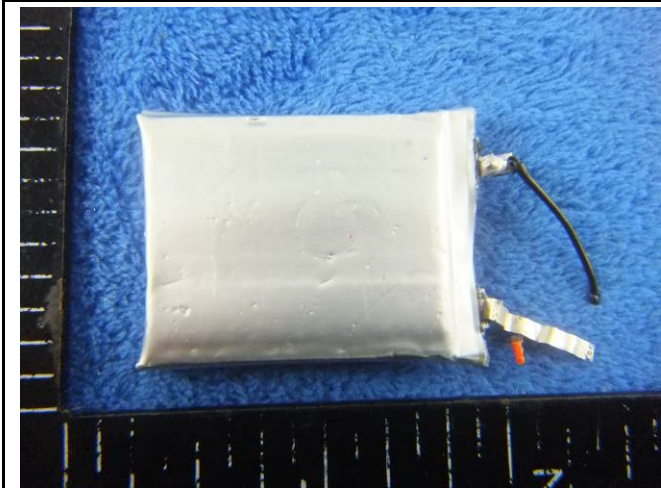

Battery - Rear View

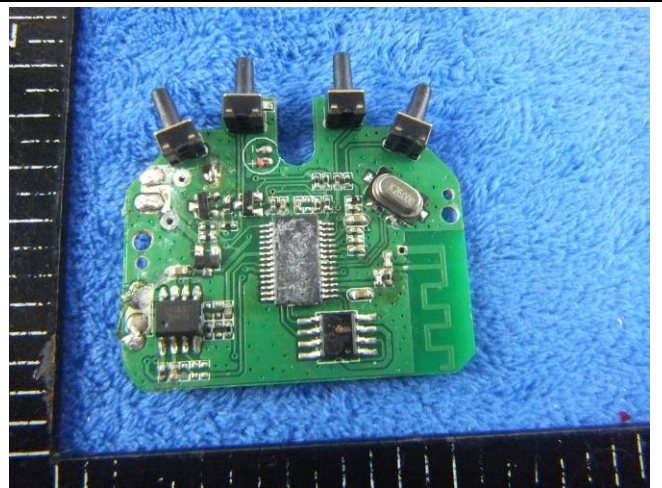

MainBoard - Front View

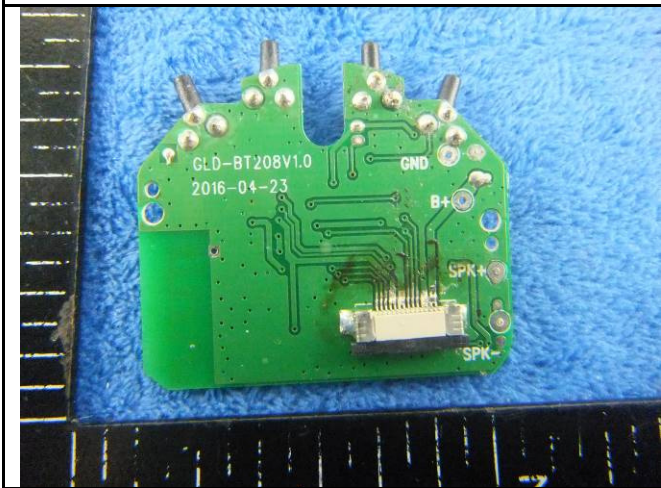

MainBoard- Rear View

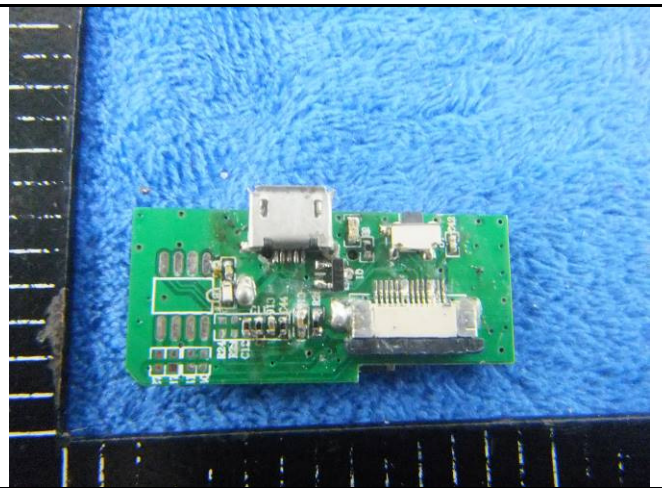

Small Board - Front View

Test Report	16070511-FCC-R
Page	51 of 58

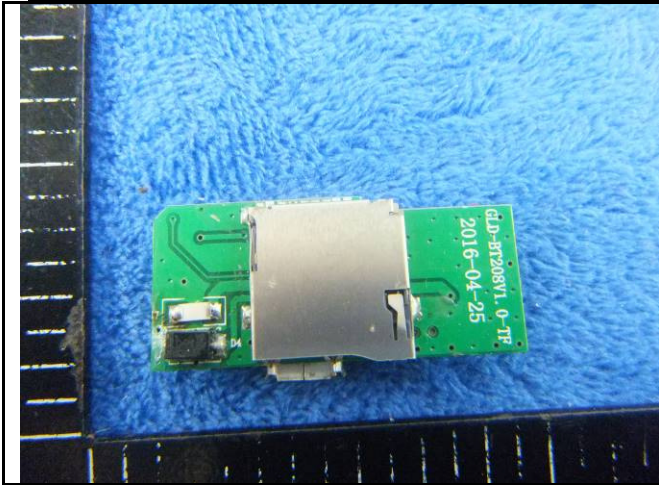

Small MainBoard – Rear View

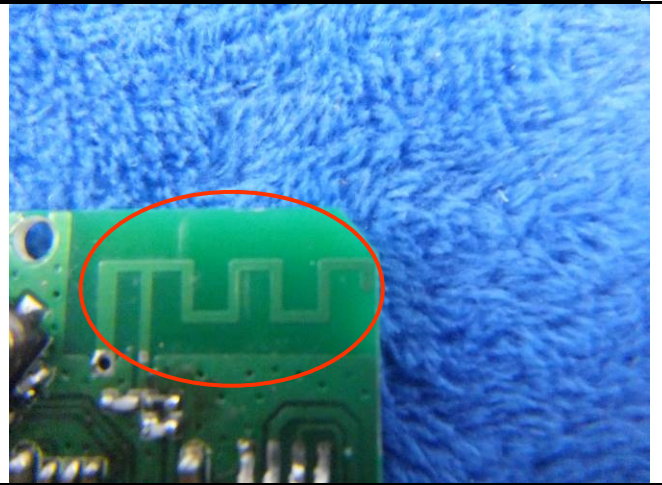

BT – Antenna View

Annex B.iii. Photograph: Test Setup Photo



Conducted Emissions Test Setup – Front View



Conducted Emissions Test Setup – Side View

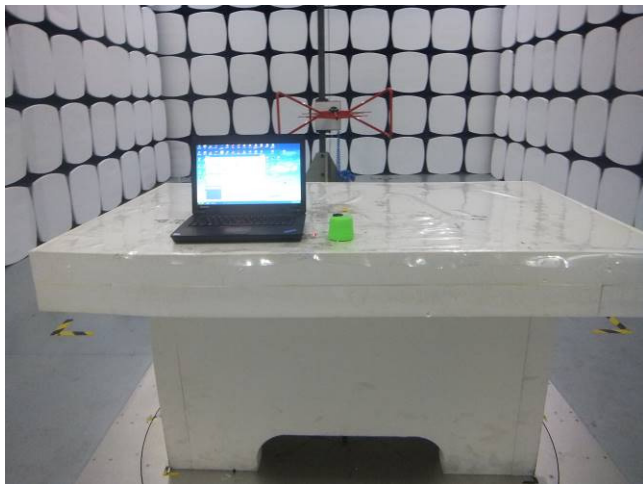

Radiated Spurious Emissions Test Setup Below 1GHz

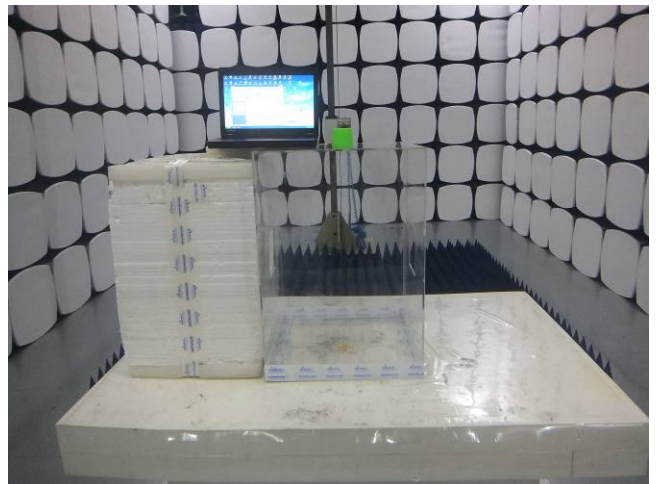

Radiated Spurious Emissions Test Above 1GHz

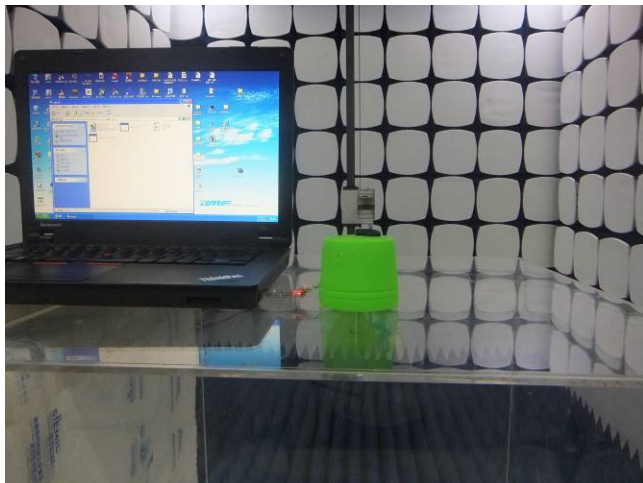

Radiated Spurious Emissions Test Above 1GHz

Annex C. TEST SETUP AND SUPPORTING EQUIPMENT

Annex C.ii. TEST SET UP BLOCK

Block Configuration Diagram for AC Line Conducted Emissions

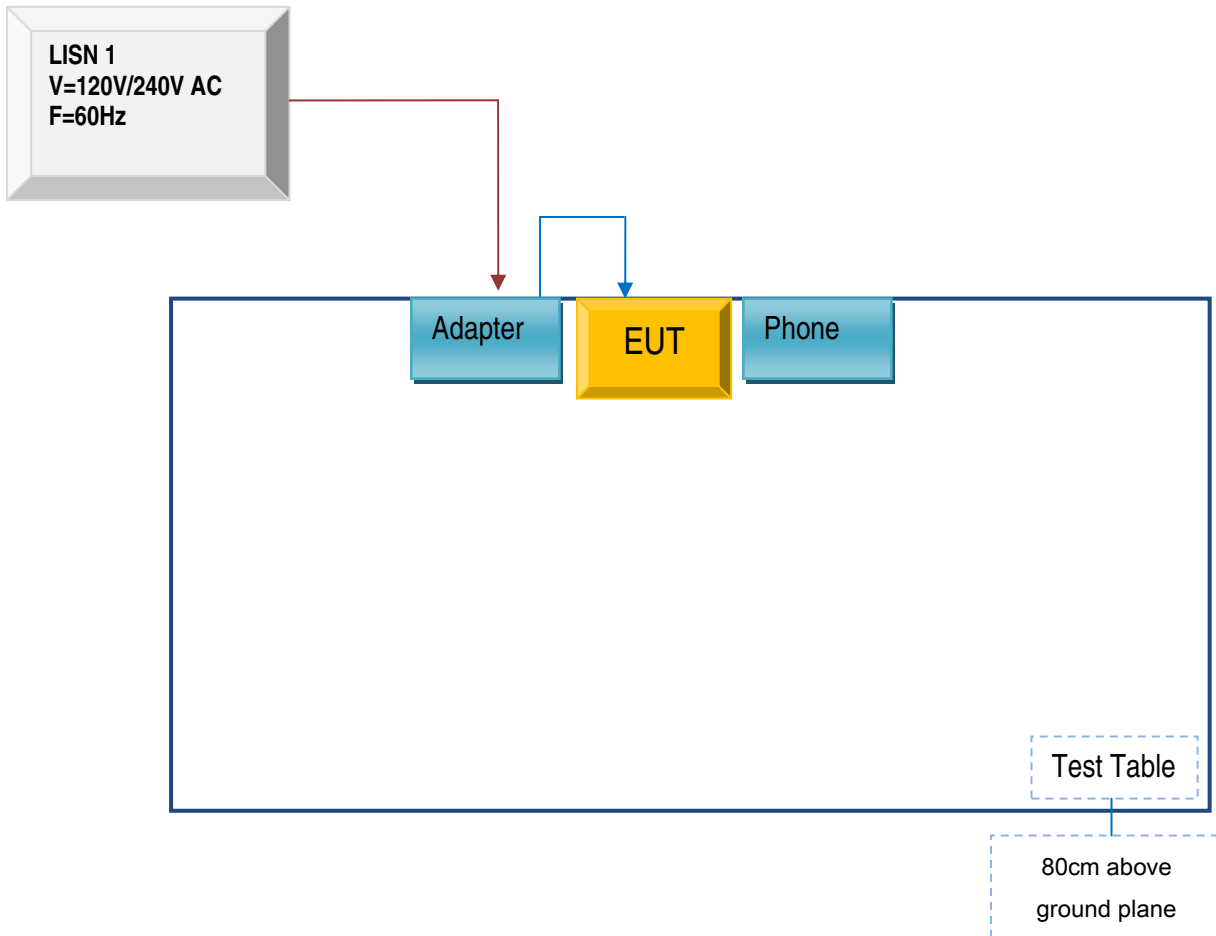

Block Configuration Diagram for Radiated Emission (Below 1GHz) .

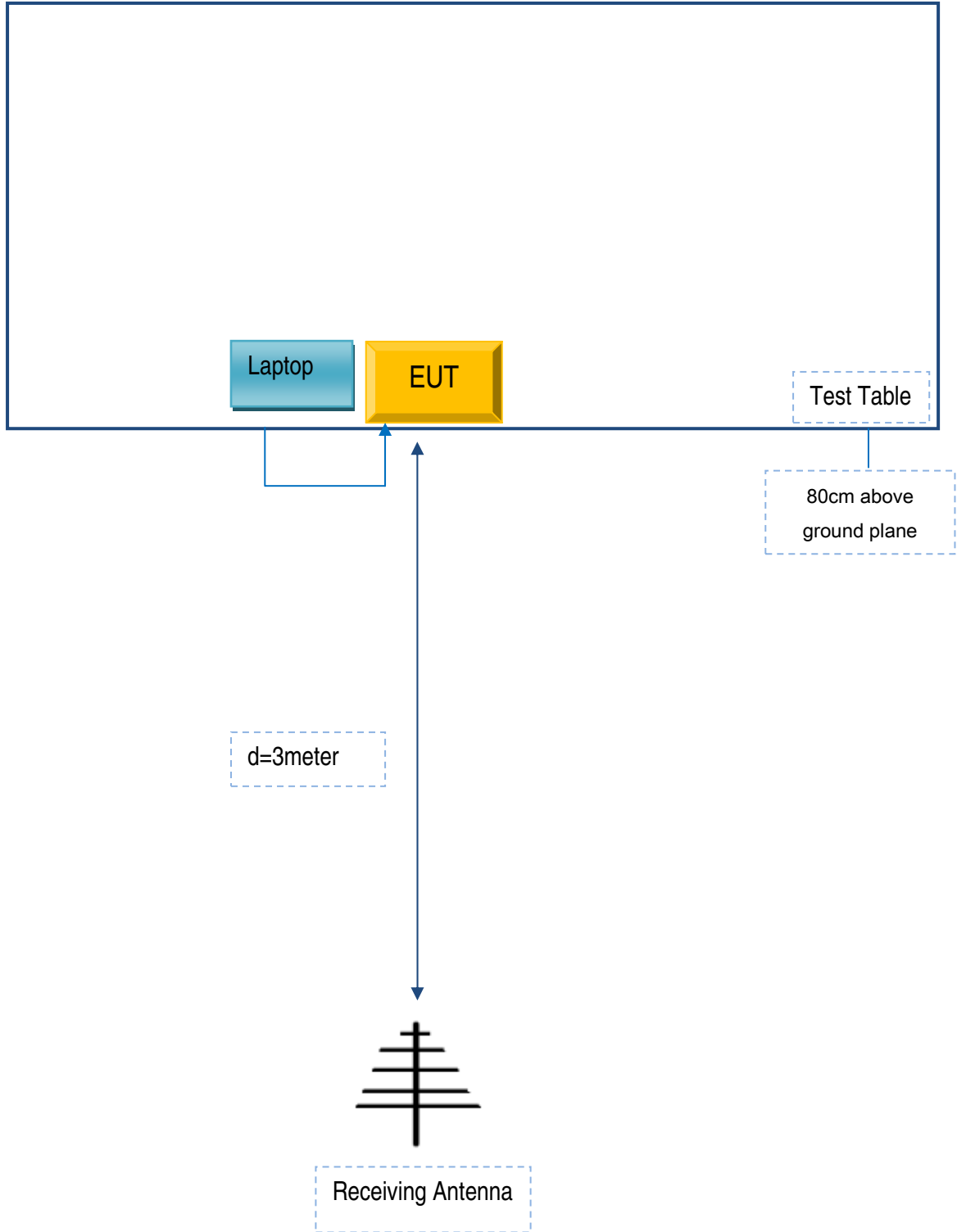

Block Configuration Diagram for Radiated Emission (Above 1GHz) .

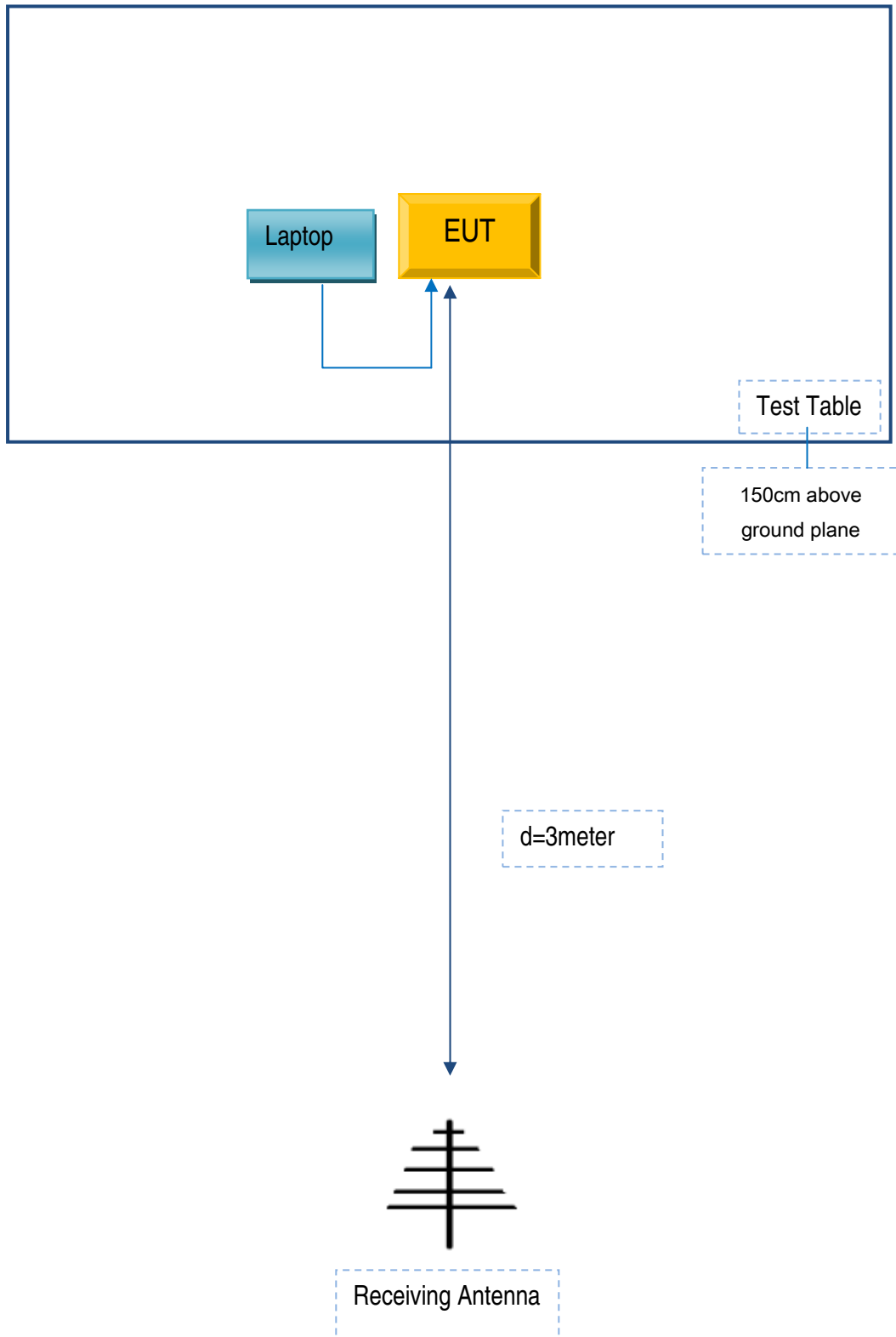

Annex C. ii. SUPPORTING EQUIPMENT DESCRIPTION

The following is a description of supporting equipment and details of cables used with the EUT.

Supporting Equipment:

Manufacturer	Equipment Description	Model	Serial No
Lenovo	Lenovo Laptop	E40	N3-F5022
Lenovo	Adapter	DX-13250	C10503

Supporting Cable:

Cable type	Shield Type	Ferrite Core	Length	Serial No
USB Cable	Un-shielding	No	0.5m	Hk10023

Test Report	16070511-FCC-R
Page	57 of 58

Annex D. User Manual / Block Diagram / Schematics / Partlist

N/A

Test Report	16070511-FCC-R
Page	58 of 58

Annex E. DECLARATION OF SIMILARITY

Shenzhen Kingsun Enterprises Co., Ltd.

To: 775 Montague Expressway Milpitas, CA 95035,USA

Declaration Letter

For our business issue and marketing requirement, we would like to list 2 models on the FCC ID reports, as following:

Main Model No	Serial Model No	Difference
DC-0615	NV-04750	Model No

Thank you!

Sincerely,

Client's signature:



Client's name / title: Sydney/Manager

Contact information / address : 25 / F,CEC information Building Xinwen Rd., Shenzhen ,Guangdong,
China