

**TEST REPORT**

<b>Applicant:</b>	Guoguang Electric Co., Ltd.
<b>Address of Applicant:</b>	No.8 Jinghu Road, Xinhua Street, Huadu Reg, Guangzhou, China
<b>Manufacturer:</b>	MEIZU Technology Co., Ltd.
<b>Address of Manufacturer:</b>	MEIZU Tech Bldg., Technology & Innovation Coast Zhuhai, 519085, Guangdong, China
<b>Product name:</b>	Meizu wireless speaker
<b>Model:</b>	Gravity A8
<b>Rating(s):</b>	Rated Input: 15Vdc, 3.0A (For main); 100V-240V ~ , 50/60Hz, 1.5A (For AC Adapter); Rated Output: 15Vdc, 3.0A (For AC Adapter)
<b>Trademark:</b>	/
<b>Standards:</b>	FCC Part 15.247 :2016
<b>FCC ID:</b>	2AAP8GRAVITYA8
<b>Data of Receipt:</b>	2016-11-21
<b>Date of Test:</b>	2016-11-21~2017-01-13
<b>Date of Issue:</b>	2017-01-16
<b>Test Result</b>	<b>Pass*</b>

\* In the configuration tested, the test item complied with the standards specified above.

**Authorized for issue by:****Test by:****Reviewed by:**

Jan.16, 2017 Eleven Liang

Jan.16, 2017

Pauler Li

Project Engineer

Project Manager

Date

Name/Position

Signature

Date

Name/Position

Signature

**Possible test case verdicts:**

test case does not apply to the test object ...: N/A  
test object does meet the requirement .....: P (Pass)  
test object does not meet the requirement ...: F (Fail)

**Testing Laboratory information:**

Testing Laboratory Name .....: I-Test Laboratory  
Address.....: 1-2 floor, South Block, Building A2 , No 3 Keyan Lu,  
Science City, Guangzhou, Guangdong Province, P.R. China  
Testing location : Same as above  
Tel : 0086-20-32209330  
Fax : 0086-20-62824387  
E-mail : itl@i-testlab.com

**General remarks:**

**The test results presented in this report relate only to the object tested.**

**The results contained in this report reflect the results for this particular model and serial number. It is the responsibility of the manufacturer to ensure that all production models meet the intent of the requirements detailed within this report.**

**This report would be invalid test report without all the signatures of testing technician and approver.**

**This report shall not be reproduced, except in full, without the written approval of the Issuing testing laboratory.**

**General product information:**

/

## 1 Test Summary

Test	Test Requirement	Test method	Result
Antenna Requirement	FCC PART 15 C section 15.247 (c) and Section 15.203	FCC PART 15 C section 15.247 (c) and Section 15.203	PASS
Occupied Bandwidth (-20dB)	FCC PART 15 C section 15.247 (a)(1);	ANSI C63.10:2013 Clause 6.9	PASS
Carrier Frequencies Separated	FCC PART 15 C section 15.247(a)(1);	ANSI C63.10:2013	PASS
Hopping Channel Number	FCC PART 15 C section 15.247(a)(1)(iii)	ANSI C63.10:2013	PASS
Dwell Time	FCC PART 15 C section 15.247(a)(1)(iii);	ANSI C63.10:2013	PASS
Maximum Peak Output Power	FCC PART 15 C section 15.247(b)(1);	ANSI C63.10:2013 Clause 6.10	PASS
Conducted Spurious Emission (30 MHz to 25 GHz)	FCC PART 15 C section 15.247(d);	ANSI C63.10:2013 Clause 6.7	PASS
Radiated Spurious Emission (9 kHz to 25 GHz)	FCC PART 15 C section 15.247(d);	ANSI C63.10:2013 Clause 6.4,6.5 and 6.6	PASS
Band Edges Measurement	FCC PART 15 C section 15.247 (d) &15.205	ANSI C63.10:2013 Clause 6.9	PASS
Conducted Emissions at Mains Terminals	FCC PART 15 C section 15.207;	ANSI C63.10:2013 Clause 6.2	PASS

### Remark:

N/A: not applicable. Refer to the relative section for the details.  
 EUT: In this whole report EUT means Equipment Under Test.  
 Tx: In this whole report Tx (or tx) means Transmitter.  
 Rx: In this whole report Rx (or rx) means Receiver.  
 RF: In this whole report RF means Radio Frequency.  
 ANSI C63.10:2013 the detail version is ANSI C63.10:2013 in the whole report.

## 2 Contents

	Page
<b>TEST REPORT</b> .....	<b>1#</b>
<b>1# TEST SUMMARY</b> .....	<b>3#</b>
<b>2# CONTENTS</b> .....	<b>4#</b>
<b>3# GENERAL INFORMATION</b> .....	<b>5#</b>
<b>3.1# CLIENT INFORMATION</b> .....	<b>5#</b>
<b>3.2# GENERAL DESCRIPTION OF E.U.T.</b> .....	<b>5#</b>
<b>3.3# DETAILS OF E.U.T.</b> .....	<b>5#</b>
<b>3.4# DESCRIPTION OF SUPPORT UNITS</b> .....	<b>5#</b>
<b>3.5# TEST LOCATION</b> .....	<b>6#</b>
<b>3.6# DEVIATION FROM STANDARDS</b> .....	<b>6#</b>
<b>3.7# ABNORMALITIES FROM STANDARD CONDITIONS</b> .....	<b>6#</b>
<b>3.8# OTHER INFORMATION REQUESTED BY THE CUSTOMER</b> .....	<b>6#</b>
<b>3.9# TEST FACILITY</b> .....	<b>6#</b>
<b>3.10# MEASUREMENT UNCERTAINTY</b> .....	<b>6#</b>
<b>4# INSTRUMENTS USED DURING TEST</b> .....	<b>7#</b>
<b>5# TEST RESULTS</b> .....	<b>8#</b>
<b>5.1# E.U.T. TEST CONDITIONS</b> .....	<b>8#</b>
<b>5.2# ANTENNA REQUIREMENT</b> .....	<b>10#</b>
<b>5.3# OCCUPIED BANDWIDTH</b> .....	<b>11#</b>
<b>5.4# CARRIER FREQUENCIES SEPARATED</b> .....	<b>18#</b>
<b>5.5# HOPPING CHANNEL NUMBER</b> .....	<b>26#</b>
<b>5.6# DWELL TIME</b> .....	<b>29#</b>
<b>5.7# MAXIMUM PEAK OUTPUT POWER</b> .....	<b>48#</b>
<b>5.8# CONDUCTED SPURIOUS EMISSIONS</b> .....	<b>55#</b>
<b>5.9# RADIATED SPURIOUS EMISSIONS</b> .....	<b>61#</b>
5.9.1# <i>Harmonic and other spurious emissions</i> .....	<b>64#</b>
<b>5.10# RADIATED EMISSIONS WHICH FALL IN THE RESTRICTED BANDS</b> .....	<b>73#</b>
<b>5.11# BAND EDGES REQUIREMENT</b> .....	<b>76#</b>
<b>5.12# CONDUCTED EMISSIONS AT MAINS TERMINALS 150 KHZ TO 30 MHZ</b> .....	<b>83#</b>
5.12.1# <i>Measurement Data</i> .....	<b>85#</b>

### 3 General Information

#### 3.1 Client Information

Applicant: MEIZU Technology Co., Ltd.  
Address of Applicant: MEIZU Tech Bldg., Technology & Innovation Coast Zhuhai, 519085, Guangdong, China

#### 3.2 General Description of E.U.T.

Name: Meizu wireless speaker  
Model No.: Gravity A8  
Trade Mark: /  
Operating Frequency: 2402 MHz to 2480 MHz for Bluetooth.  
Channels: 79 channels with 1MHz step for Bluetooth  
Bluetooth Version: 4.0  
Bluetooth Version: This report is for classic mode.  
Modulation Technique: Frequency Hopping Spread Spectrum (FHSS)  
Type of Modulation: GFSK, ( $\pi/4$ ) DQPSK, 8DPSK for Bluetooth  
Dwell time: Per channel is less than 0.4s.  
Antenna Type: FPC antenna  
Antenna gain: 2.91 dBi  
Function: wireless speaker  
Hardware version: V03  
Software version: V0.42

#### 3.3 Details of E.U.T.

EUT Power Supply: Rated Input: 15Vdc, 3.0A (For main);  
100V-240V ~ , 50/60Hz, 1.5A (For AC Adapter);  
Rated Output: 15Vdc, 3.0A (For AC Adapter)  
Test mode: The program used to control the EUT for staying in continuous transmitting and receiving mode is programmed. Channel lowest (2402MHz), middle (2441MHz) and highest (2480MHz) are chosen for Bluetooth full testing.  
Normal mode: the Bluetooth has been tested on the Modulation of GFSK;  
EDR mode: the Bluetooth has been tested on the Modulation of ( $\pi/4$ )DQPSK and 8DPSK, compliance test and record the worst case on ( $\pi/4$ )DQPSK and 8DPSK  
Power cord: 1.5m AC power cord

#### 3.4 Description of Support Units

The EUT has been tested as an independent unit for fixed frequency by testing lab.

## Details of Support Equipment(s)

Description	Manufacturer	Model No.	Connection	Working state
Portable computer	Lenovo	E431	USB line	Normal working

### 3.5 Test Location

All tests were performed at:

I-Test Laboratory

1-2 floor, South Block, Building A2 , No 3 Keyan Lu, Science City, Guangzhou, Guangdong Province, P.R. China

0086-20-32209330

itl@i-testlab.com

No tests were sub-contracted.

### 3.6 Deviation from Standards

Biconical and log periodic antennas were used instead of dipole antennas.

### 3.7 Abnormalities from Standard Conditions

None.

### 3.8 Other Information Requested by the Customer

None.

### 3.9 Test Facility

The test facility is recognized, certified, or accredited by the following organizations:

- CNAS( Lab code:L4957)
- FCC ( Registration No.:935596)
- IC (Registration NO.:8368A)

### 3.10 Measurement Uncertainty

The below measurement uncertainties given below are based on a 95% confidence level (base on a coverage factor (k=2).)

Parameter	Uncertainty
Radio frequency	$\pm 1.06 \times 10^{-7}$
total RF power, conducted	1.37 dB
RF power density , conducted	2.89 dB
All emissions, radiated	$\pm 3.35$ dB
Temperature	$\pm 0.23$ °C
Humidity	$\pm 0.3$ %
DC and low frequency voltages	$\pm 0.3$ %

#### 4 Instruments Used during Test

No.	Test Equipment	Manufacturer	Model	Serial No.	Last Cal.	Cal. Due
ITL-114	Spectrum Analyzer	Agilent	N9010A	MY51250936	2016/01/25	2017/01/25
ITL-154	EMI test receiver 9kHz to 26.5GHz	R&S	ESR26	101257	2016/01/25	2017/01/25
ITL-116	Pre Amplifier	HP	8447F	3113A05905	2016/01/25	2017/01/25
ITL-117	Wideband Amplifier Super Ultra	Mini-circuits	ZVA-183- S+	469101134	2016/01/25	2017/01/25
ITL-105	Biconilog Antenna	ETS•Lindgren	3142D	00108096	2015/01/24	2018/01/24
ITL-110	Horn Antenna	A-INFOMW	JTXLB- 10180-N	J2031090612 133	2015/01/24	2018/01/24
ITL-102	EMI Test receiver	R&S	ESCI	100910	2016/06/17	2017/06/17
ITL-103	Two-line v- network	R&S	ENV216	100120	2016/06/17	2017/06/17
ITL-115	50Ω Coaxial Cable	Mini-circuits	CBL	C001	2016/06/17	2017/06/17
ITL-100	Semi-Anechoic chamber	ETS•Lindgren	FACT3 2.0	CT09015	2014/06/17	2017/06/17
ITL-145	Loop Antenna	ZHINAN	ZN30900 A	002489	2016/01/25	2017/01/25
ITL-146	Horn Antenna	Schwarzbeck	BBHA 9170	B09806543	2016/06/17	2017/06/17
ITL-101	Shielded Room	ETS•Lindgren	8*4*3	CT09010	2015/03/09	2018/03/09

## 5 Test Results

### 5.1 E.U.T. test conditions

**Test Voltage:** Input: AC 120V, 60 Hz

**Temperature:** 20.0 -25.0 °C

**Humidity:** 38-50 % RH

**Atmospheric Pressure:** 1000 -1010 mbar

**Test frequencies and frequency range:** According to the 15.31(m) Measurements on intentional radiators or receivers, other than TV broadcast receivers, shall be performed and, if required, reported for each band in which the device can be operated with the device operating at the number of frequencies in each band specified in the following table:

According to the 15.33 (a) For an intentional radiator, the spectrum shall be investigated from the lowest radio frequency signal generated in the device, without going below 9 kHz, up to at least the frequency shown in the following table:

**Number of fundamental frequencies to be tested in EUT transmit band**

Frequency range in which	Number of frequencies	Location in frequency range of operation
1 MHz or less	1	Middle
1 MHz to 10 MHz	2	1 near top and 1 near bottom
More than 10 MHz	3	1 near top, 1 near middle and 1 near bottom

**Frequency range of radiated emission measurements**

Lowest frequency generated	Upper frequency range of measurement
9 kHz to below 10 GHz	10th harmonic of highest fundamental frequency or to 40 GHz,
At or above 10 GHz to below	5th harmonic of highest fundamental frequency or to 100 GHz,
At or above 30 GHz	5th harmonic of highest fundamental frequency or to 200 GHz,



## EUT channels and frequencies list for Bluetooth:

Channel	Frequency (MHz)	Channel	Frequency (MHz)	Channel	Frequency (MHz)
0	2402	11	2413	22	2424
1	2403	12	2414	23	2425
2	2404	13	2415	24	2426
3	2405	14	2416	25	2427
4	2406	15	2417	26	2428
5	2407	16	2418	27	2429
6	2408	17	2419	28	2430
7	2409	18	2420	29	2431
8	2410	19	2421	30	2432
9	2411	20	2422	31	2433
10	2412	21	2423	32	2434
33	2435	49	2451	65	2467
34	2436	50	2452	66	2468
35	2437	51	2453	67	2469
36	2438	52	2454	68	2470
37	2439	53	2455	69	2471
38	2440	54	2456	70	2472
39	2441	55	2457	71	2473
40	2442	56	2458	72	2474
41	2443	57	2459	73	2475
42	2444	58	2460	74	2476
43	2445	59	2461	75	2477
44	2446	60	2462	76	2478
45	2447	61	2463	77	2479
46	2448	62	2464	78	2480
47	2449	63	2465		
48	2450	64	2466		

Test frequencies are the lowest channel: 0 channel (2402 MHz), middle channel: 39 channel (2441 MHz) and highest channel: 78 channel (2480 MHz)

## 5.2 Antenna requirement

### Standard requirement

15.203 requirement:

For intentional device. According to 15.203, an intentional radiator shall be designed to ensure that no antenna other than that furnished by the responsible party shall be used with the device.

15.247(c) (1)(i) requirement:

(i) Systems operating in the 2400-2483.5 MHz bands that are used exclusively for fixed. Point-to-point operations may employ transmitting antennas with directional gain greater than 6 dBi provided the maximum conducted output power of the intentional radiator is reduced by 1 dB for every 3 dB that the directional gain of the antenna exceeds 6 dBi.

### EUT Antenna

The antenna is a FPC antenna and no consideration of replacement. The best case gain of the antenna is 2.91dBi.

**Test result: The unit does meet the FCC requirements.**

### 5.3 Occupied Bandwidth

**Test Requirement:** FCC Part 15 C section 15.247

(a)(1) Frequency hopping systems shall have hopping channel carrier frequencies separated by a minimum of 25 kHz or the 20 dB bandwidth of the hopping channel, whichever is greater. Alternatively, frequency hopping systems operating in the 2400-2483.5 MHz band may have hopping channel carrier frequencies that are separated by 25 kHz or two-thirds of the 20 dB bandwidth of the hopping channel, whichever is greater, provided the systems operate with an output power no greater than 125 mW.

**Test Method:** ANSI C63.10:2013 Clause 6.9

**Test Status:** Pre-test the EUT in continuous transmitting mode at the lowest, middle and highest channel with different data package. Compliance test in normal mode (DH5), EDR mode (2DH5) and EDR mode (3DH5) as the worst case was found.

**Test Configuration:**

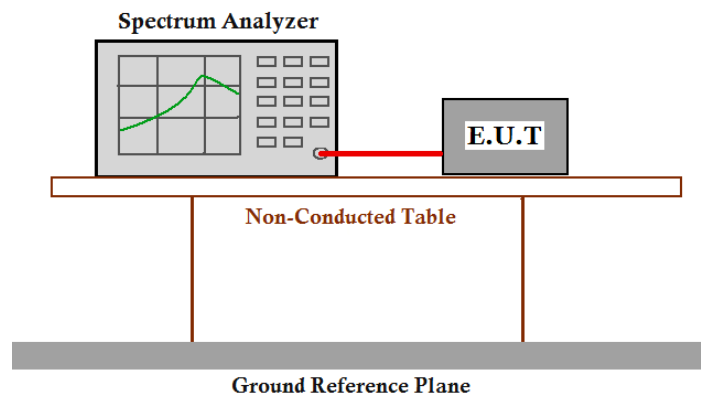

**Test Procedure:**

1. Remove the antenna from the EUT and then connect a low RF cable from the antenna port to the spectrum;
2. Set the spectrum analyzer: Span = approximately 2 to 3 times the 20dB bandwidth, centring on a hopping channel;
3. Set the spectrum analyzer: RBW  $\geq$  1% of the 20dB bandwidth VBW  $\geq$  RBW. Sweep = auto; Detector Function = Peak. Trace = Max Hold.
4. Mark the peak frequency and -20dB points bandwidth.

## Test result (-20dB bandwidth), For Bluetooth

## Normal mode:

Test Channel	Bandwidth(MHz)	2/3 bandwidth(MHz)
Lowest	1.132	0.755
Middle	1.128	0.752
Highest	1.130	0.753

## EDR mode (2DH5):

Test Channel	Bandwidth(MHz)	2/3 bandwidth(MHz)
Lowest	1.406	0.937
Middle	1.396	0.931
Highest	1.412	0.941

## EDR mode (3DH5):

Test Channel	Bandwidth(MHz)	2/3 bandwidth(MHz)
Lowest	1.364	0.909
Middle	1.371	0.914
Highest	1.366	0.911

For Bluetooth

Result plot as follows:

DH5:

Lowest Channel:



Middle Channel:



Highest Channel:



2DH5:

Lowest channel:



Middle channel:



Highest channel:



3DH5:

Lowest channel:



Middle channel:





Highest channel:



## 5.4 Carrier Frequencies Separated

**Test Requirement:** FCC Part 15 C section 15.247

(a),(1) Frequency hopping systems shall have hopping channel carrier frequencies separated by a minimum of 25 kHz or the 20 dB bandwidth of the hopping channel, whichever is greater. Alternatively, frequency hopping systems operating in the 2400-2483.5 MHz band may have hopping channel carrier frequencies that are separated by 25 kHz or two-thirds of the 20 dB bandwidth of the hopping channel, whichever is greater, provided the systems operate with an output power no greater than 125 mW.

**Test Method:** ANSI C63.10:2013

**Test Status:** Pre-test the EUT in continuous transmitting mode at the lowest, middle and highest channel with different data package. Compliance test in normal mode (DH5), EDR mode (2DH5) and EDR mode (3DH5) as the worst case was found.

**Test Configuration:**

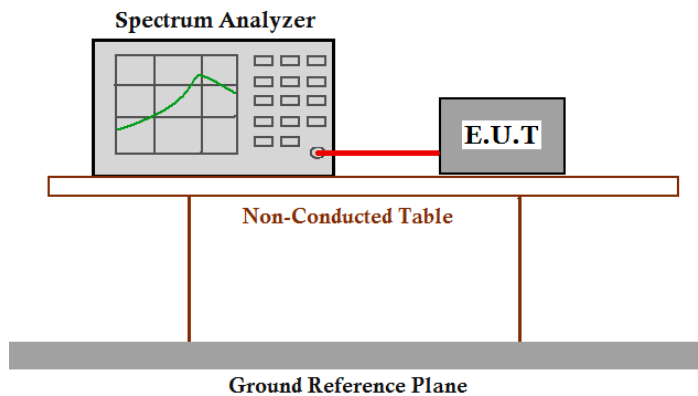

**Test Procedure:**

1. Remove the antenna from the EUT and then connect a low attenuation RF cable from the antenna port to the spectrum.
2. Set the spectrum analyzer: RBW  $\geq$  1% of the span, VBW  $\geq$  RBW, Sweep = auto; Detector Function = Peak. Trace = Max, hold.
3. Allow the trace to stabilize. Use the marker-delta function to determine the separation between the peaks of the adjacent channels. The limit is specified in one of the subparagraphs of this Section. Submit this plot.

**Test result:****For Bluetooth****DH5**

<b>Test Channel</b>	<b>Carrier Frequencies Separated</b>	<b>Pass/Fail</b>
Lower Channels (channel 0 and channel 1)	1.00MHz	Pass
Middle Channels (channel 39 and channel 40)	1.01MHz	Pass
Upper Channels (channel 77 and channel 78)	1.00MHz	Pass
Remark:  The limit is maximum two-thirds of the 20 dB bandwidth: 0.755 MHz		

**2DH5**

<b>Test Channel</b>	<b>Carrier Frequencies Separated</b>	<b>Pass/Fail</b>
Lower Channels (channel 0 and channel 1)	1.01MHz	Pass
Middle Channels (channel 39 and channel 40)	1.01MHz	Pass
Upper Channels (channel 77 and channel 78)	1.01MHz	Pass
Remark:  The limit is maximum two-thirds of the 20 dB bandwidth: 0.941 MHz		

## 3DH5

Test Channel	Carrier Frequencies Separated	Pass/Fail
Lower Channels (channel 0 and channel 1)	1.00MHz	Pass
Middle Channels (channel 39 and channel 40)	1.01MHz	Pass
Upper Channels (channel 77 and channel 78)	1.00MHz	Pass
<p>Remark:</p> <p>The limit is maximum two-thirds of the 20 dB bandwidth: 0.914 MHz</p>		

For Bluetooth  
Carrier Frequencies Separated plot:  
DH5

1. Lowest Channels:



2. Middle Channels:

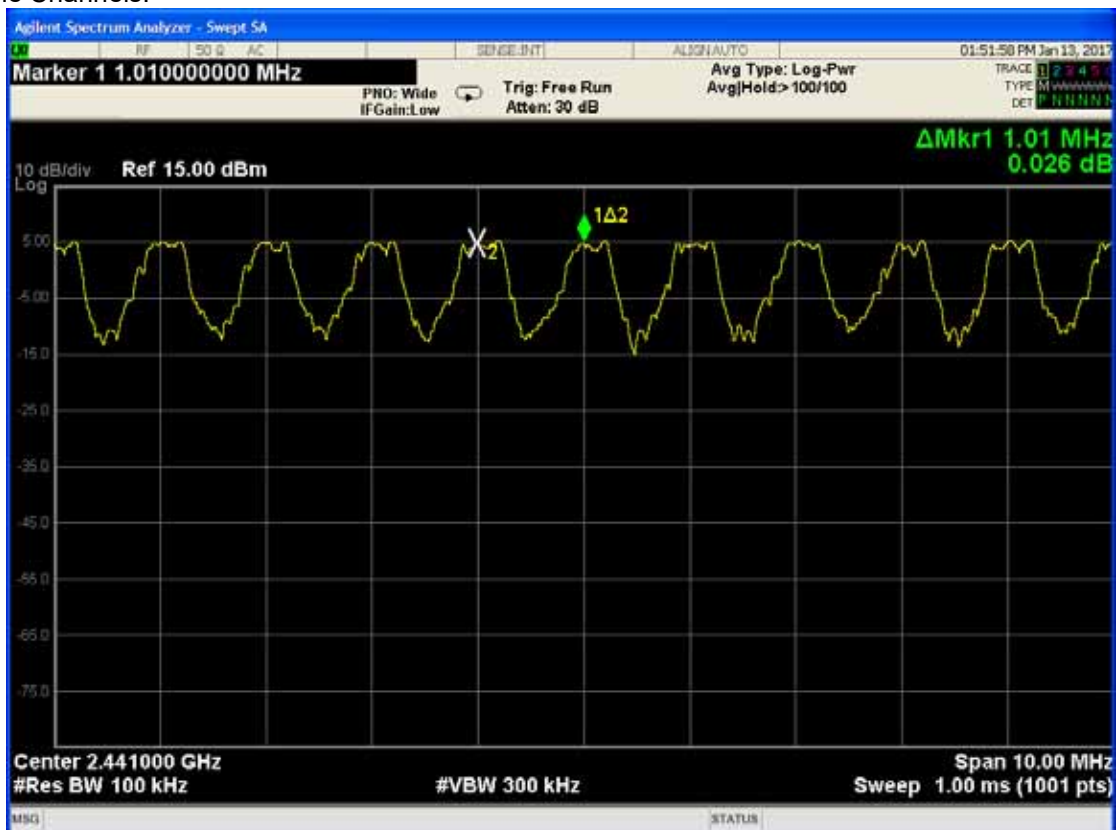

3. Highest Channels



2DH5

1. Lowest Channels:



2. Middle Channels:



3. Highest Channels



3DH5

1. Lowest Channels:



2. Middle Channels:





3. Highest Channels



## 5.5 Hopping Channel Number

**Test Requirement:** FCC Part15 C section 15.247  
(a)(1)(iii) Frequency hopping systems in the 2400-2483.5 MHz band shall use at least 15 channels.

**Test Method:** ANSI C63.10:2013

**Test Status:** Pre-test the EUT in hopping mode with different data packet. Compliance test in hopping with normal mode (DH5), EDR mode (2DH5) and EDR mode (3DH5) as the worst case was found.

### Test Configuration:

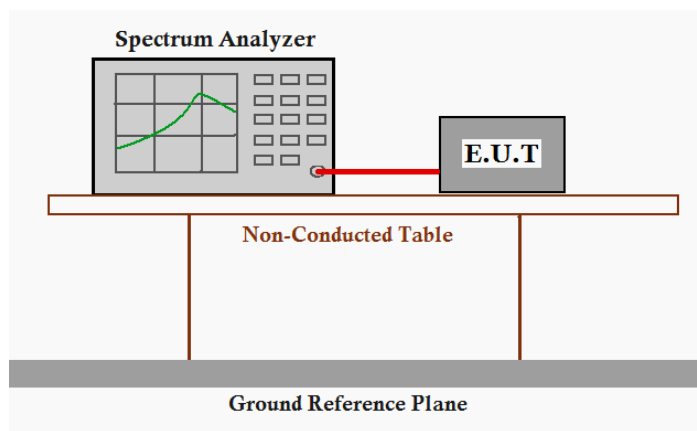

### Test Procedure:

1. Remove the antenna from the EUT and then connect a low attenuation RF cable from the antenna port to the spectrum.
2. Set the spectrum analyzer: RBW = 100 kHz. VBW = 300 kHz. Sweep = auto; Detector Function = Peak. Trace = Max hold.
3. Allow the trace to stabilize. It may prove necessary to break the span up to sections. in order to clearly show all of the hopping frequencies. The limit is specified in one of the subparagraphs of this Section.
4. Set the spectrum analyzer: start frequency = 2400 MHz. stop frequency = 2483.5 MHz. Submit the test result graph.

For Bluetooth

Test result: Total channels are 79 channels.

DH5:



2DH5:

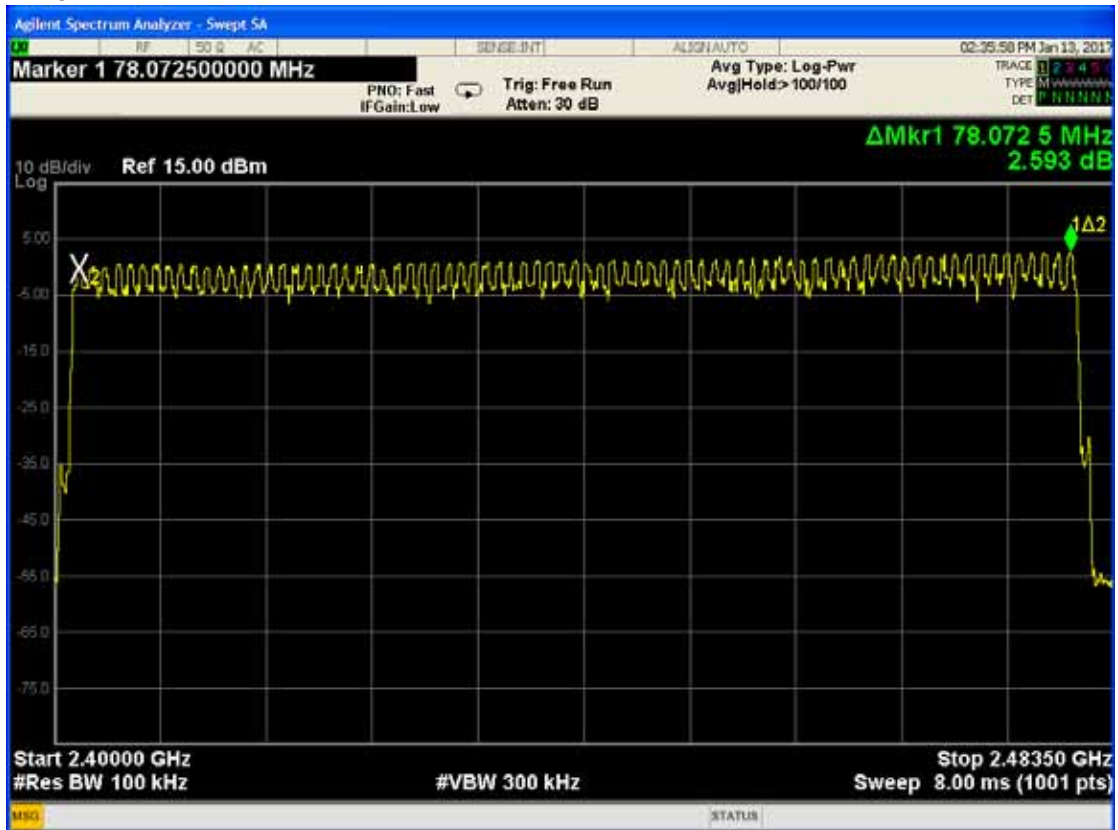

3DH5:



Test result: The unit does meet the FCC requirements.

## 5.6 Dwell Time

**Test Requirement:** FCC Part 15 C section 15.247

(a)(1)(iii) Frequency hopping systems in the 2400-2483.5 MHz band shall use at least 15 channels. The average time of occupancy on any channel shall not be greater than 0.4 seconds within a period of 0.4 seconds multiplied by the number of hopping channels employed. Frequency hopping systems may avoid or suppress transmissions on a particular hopping frequency provided that a minimum of 15 channels are used.

**Test Method:** ANSI C63.10:2013

**Test Status:** Pre-test the EUT in continuous transmitting mode at the lowest, middle and highest channel with different data packet. Compliance test in hopping with Normal mode (DH1, DH3 and DH5) and EDR mode (2DH1, 2DH3 and 2DH5; 3DH1, 3DH3 and 3DH5) as the worst case was found.

**Test Configuration:**

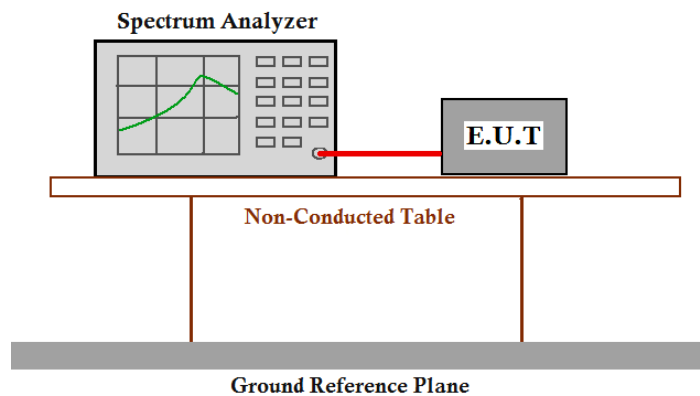

**Test Procedure:**

1. Remove the antenna from the EUT and then connect a low attenuation RF cable from the antenna port to the spectrum.
2. Set spectrum analyzer span = 0. centered on a hopping channel;
3. Set RBW = 1 MHz and VBW = 3 MHz. Sweep = as necessary to capture the entire dwell time per hopping channel. Detector Function = Peak. Trace = View;
4. Use the marker-delta function to determine the dwell time. If this value varies with different modes of operation (e.g.. data rate. modulation format. etc.). Repeat this test for each variation. The limit is specified in one of the subparagraphs of this Section. Submit this plot(s). An oscilloscope may be used instead of a spectrum analyzer.

**Test Result:****For Bluetooth**

The test period:  $T = 0.4 \text{ Second/Channel} \times 79 \text{ Channel} = 31.6 \text{ s}$

**1. Channel 0: 2.402GHz**

DH1 time slot =  $0.196 \text{ (ms)} \times (1600/(2 \times 79)) \times 31.6 = 62.7\text{ms}$

DH3 time slot =  $0.256 \text{ (ms)} \times (1600/(4 \times 79)) \times 31.6 = 41.0\text{ms}$

DH5 time slot =  $0.296 \text{ (ms)} \times (1600/(6 \times 79)) \times 31.6 = 31.6\text{ms}$

**2. Channel 39: 2.441GHz**

DH1 time slot =  $0.200 \text{ (ms)} \times (1600/(2 \times 79)) \times 31.6 = 64.0\text{ms}$

DH3 time slot =  $0.264 \text{ (ms)} \times (1600/(4 \times 79)) \times 31.6 = 42.2\text{ms}$

DH5 time slot =  $0.296 \text{ (ms)} \times (1600/(6 \times 79)) \times 31.6 = 31.6\text{ms}$

**3. Channel 78: 2.480GHz**

DH1 time slot =  $0.200\text{(ms)} \times (1600/(2 \times 79)) \times 31.6 = 64.0\text{ms}$

DH3 time slot =  $0.260 \text{ (ms)} \times (1600/(4 \times 79)) \times 31.6 = 41.6\text{ms}$

DH5 time slot =  $0.296 \text{ (ms)} \times (1600/(6 \times 79)) \times 31.6 = 31.6\text{ms}$

**4. Channel 0: 2.402GHz**

2DH1 time slot =  $0.192 \text{ (ms)} \times (1600/(2 \times 79)) \times 31.6 = 61.4\text{ms}$

2DH3 time slot =  $0.216 \text{ (ms)} \times (1600/(4 \times 79)) \times 31.6 = 34.6\text{ms}$

2DH5 time slot =  $0.224 \text{ (ms)} \times (1600/(6 \times 79)) \times 31.6 = 23.9\text{ms}$

**5. Channel 39: 2.441GHz**

2DH1 time slot =  $0.192 \text{ (ms)} \times (1600/(2 \times 79)) \times 31.6 = 61.4\text{ms}$

2DH3 time slot =  $0.216 \text{ (ms)} \times (1600/(4 \times 79)) \times 31.6 = 34.6\text{ms}$

2DH5 time slot =  $0.232 \text{ (ms)} \times (1600/(6 \times 79)) \times 31.6 = 24.7\text{ms}$

**6. Channel 78: 2.480GHz**

2DH1 time slot =  $0.192 \text{ (ms)} \times (1600/(2 \times 79)) \times 31.6 = 61.4\text{ms}$

2DH3 time slot =  $0.208 \text{ (ms)} \times (1600/(4 \times 79)) \times 31.6 = 33.3\text{ms}$

2DH5 time slot =  $0.232 \text{ (ms)} \times (1600/(6 \times 79)) \times 31.6 = 24.7\text{ms}$

**7. Channel 0:** 2.402GHz

$$3DH1 \text{ time slot} = 0.192 \text{ (ms)} * (1600/(2*79)) * 31.6 = 61.4\text{ms}$$

$$3DH3 \text{ time slot} = 0.200 \text{ (ms)} * (1600/(4*79)) * 31.6 = 32.0\text{ms}$$

$$3DH5 \text{ time slot} = 0.208 \text{ (ms)} * (1600/(6*79)) * 31.6 = 22.2\text{ms}$$

**8. Channel 39:** 2.441GHz

$$3DH1 \text{ time slot} = 0.188 \text{ (ms)} * (1600/(2*79)) * 31.6 = 60.2\text{ms}$$

$$3DH3 \text{ time slot} = 0.200 \text{ (ms)} * (1600/(4*79)) * 31.6 = 32.0\text{ms}$$

$$3DH5 \text{ time slot} = 0.208 \text{ (ms)} * (1600/(6*79)) * 31.6 = 22.2\text{ms}$$

**9. Channel 78:** 2.480GHz

$$3DH1 \text{ time slot} = 0.184 \text{ (ms)} * (1600/(2*79)) * 31.6 = 58.9\text{ms}$$

$$3DH3 \text{ time slot} = 0.200 \text{ (ms)} * (1600/(4*79)) * 31.6 = 32.0\text{ms}$$

$$3DH5 \text{ time slot} = 0.204 \text{ (ms)} * (1600/(6*79)) * 31.6 = 21.8\text{ms}$$

The results are not greater than 0.4 seconds

**The unit does meet the FCC requirements.**

For Bluetooth

Please refer the graph as below:

1. Lowest channel (2.402 GHz):

(1) DH1

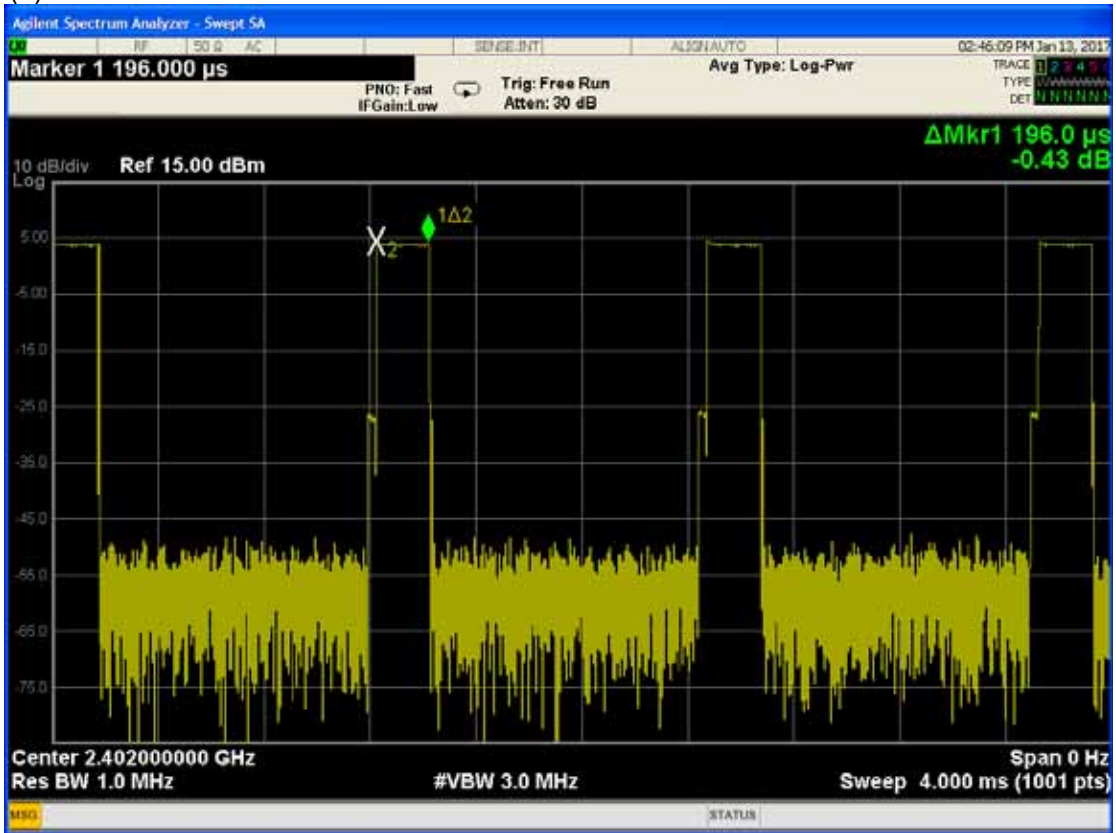

(2) DH3

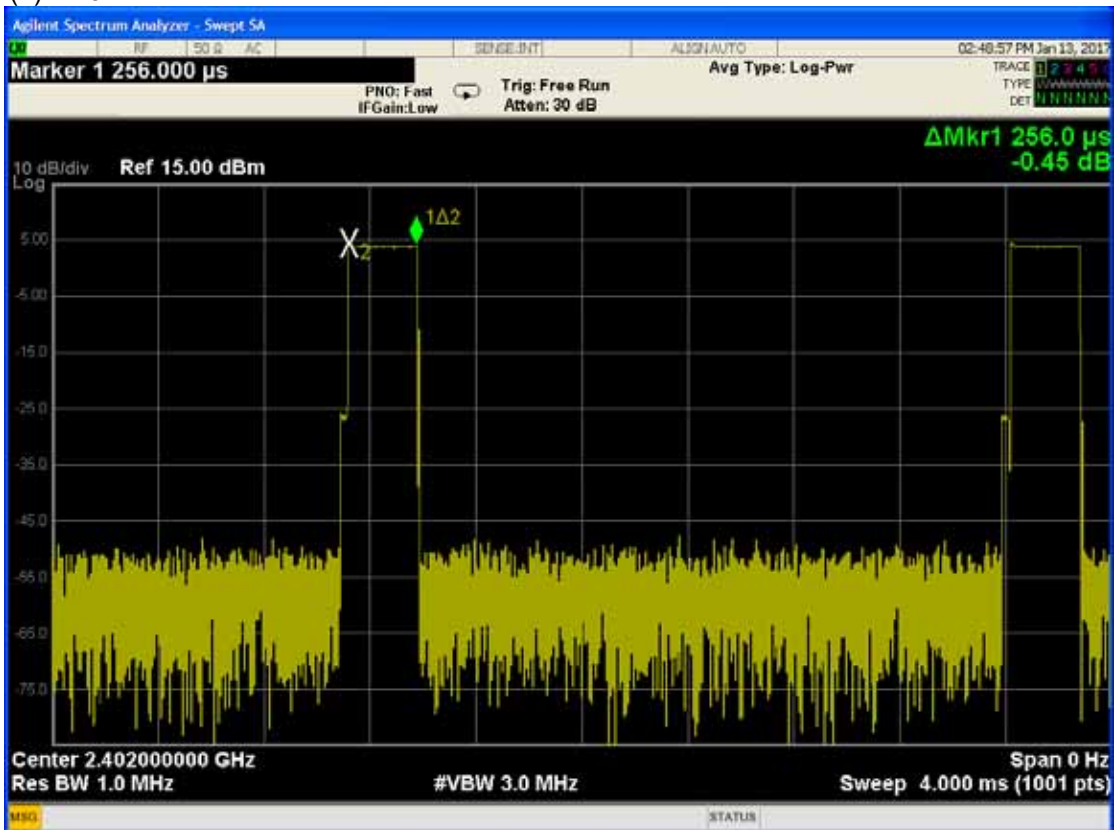



(3) DH5

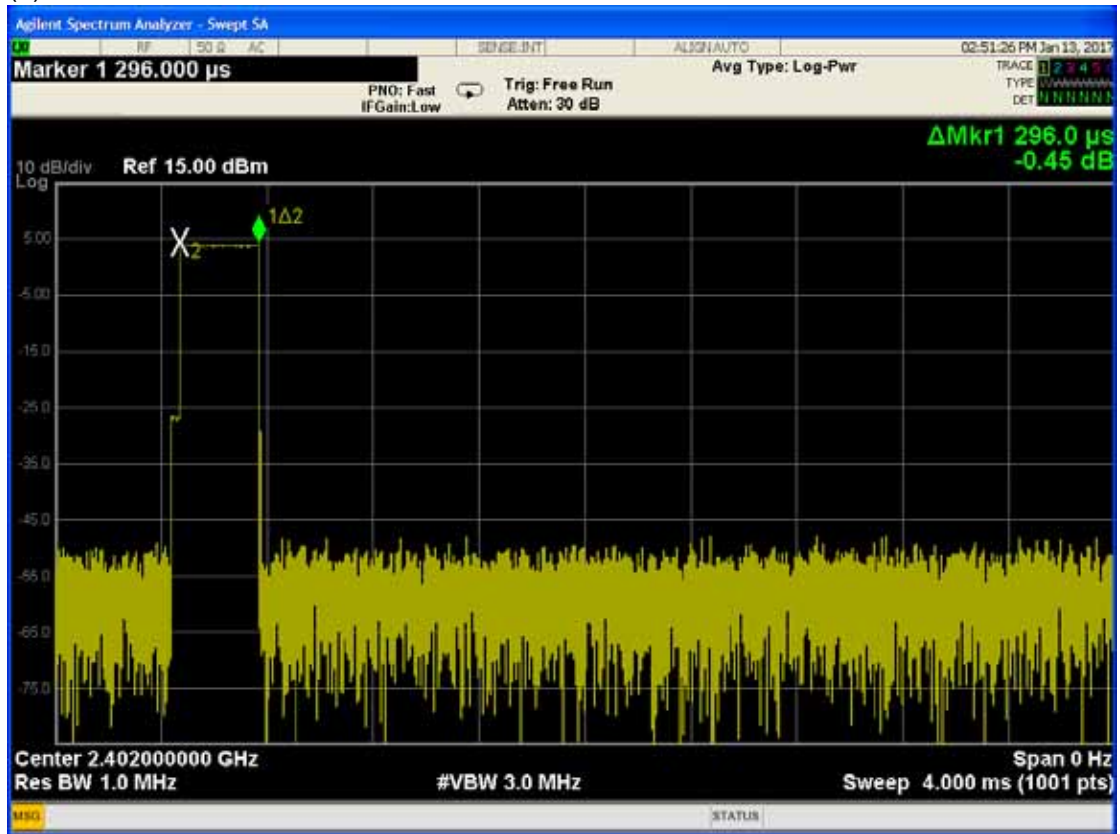

2. Middle channel (2.441 GHz):

(1) DH1

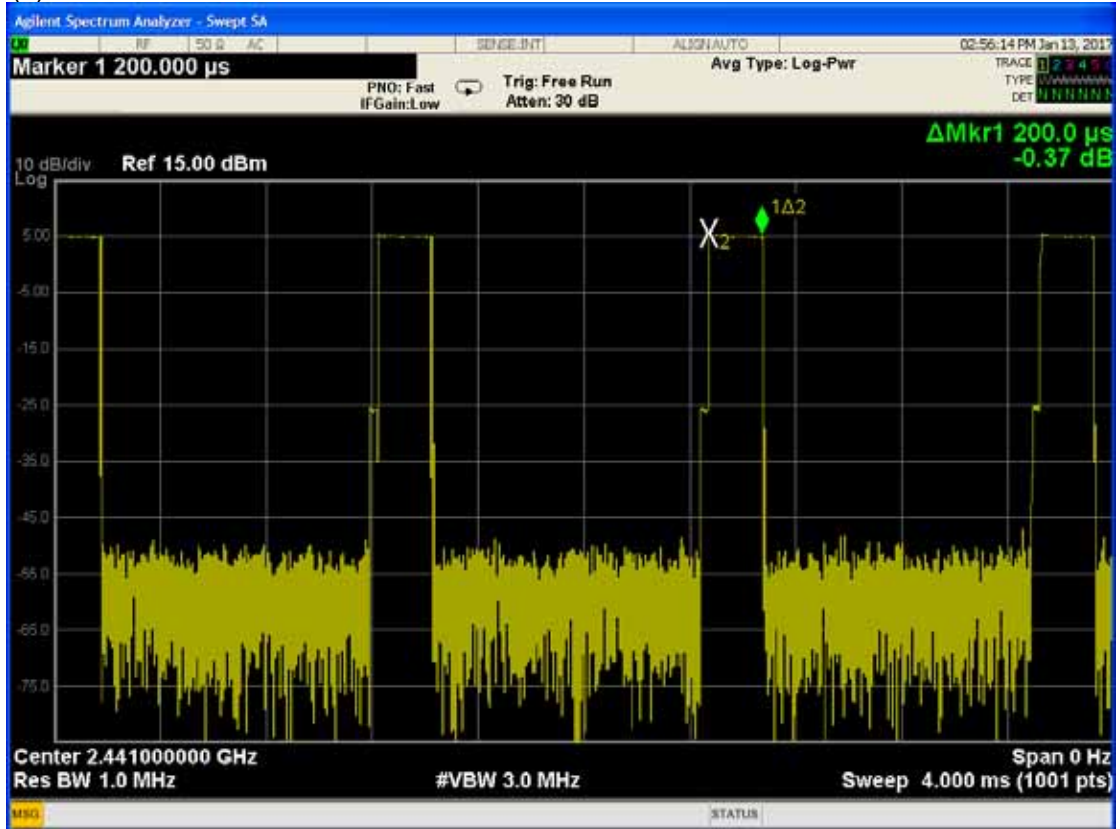

(2) DH3

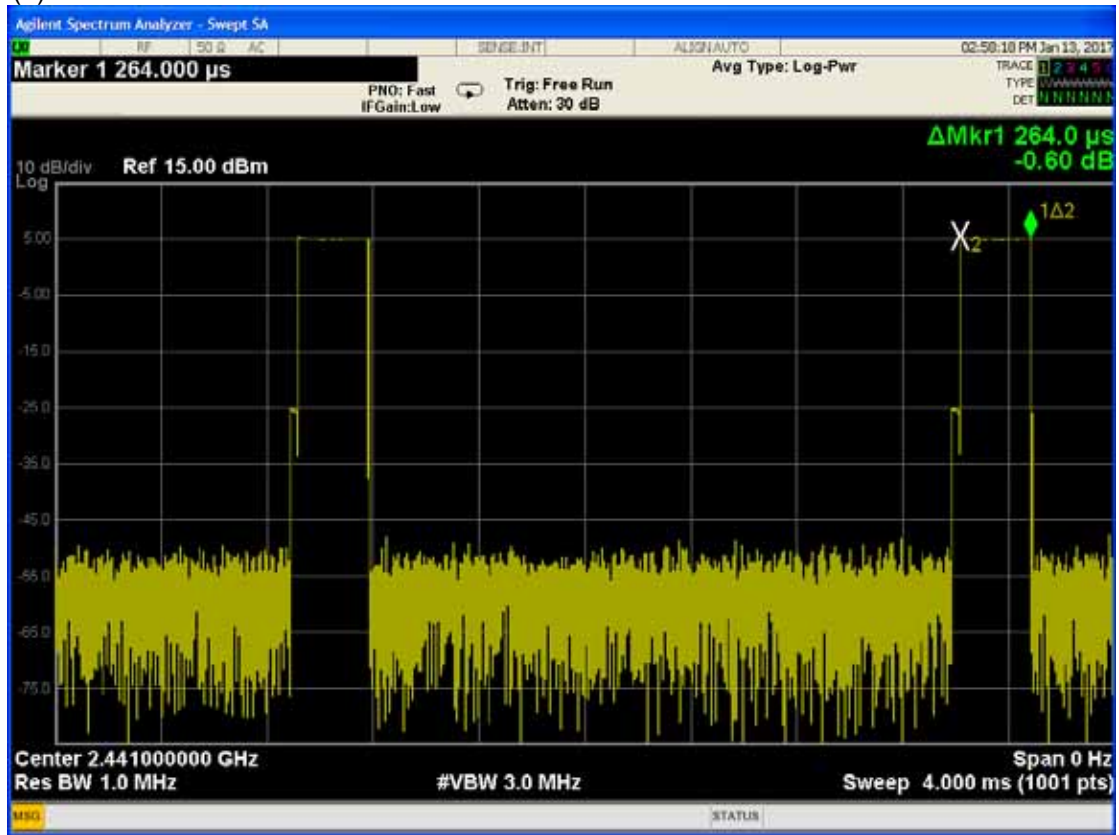

(3) DH5

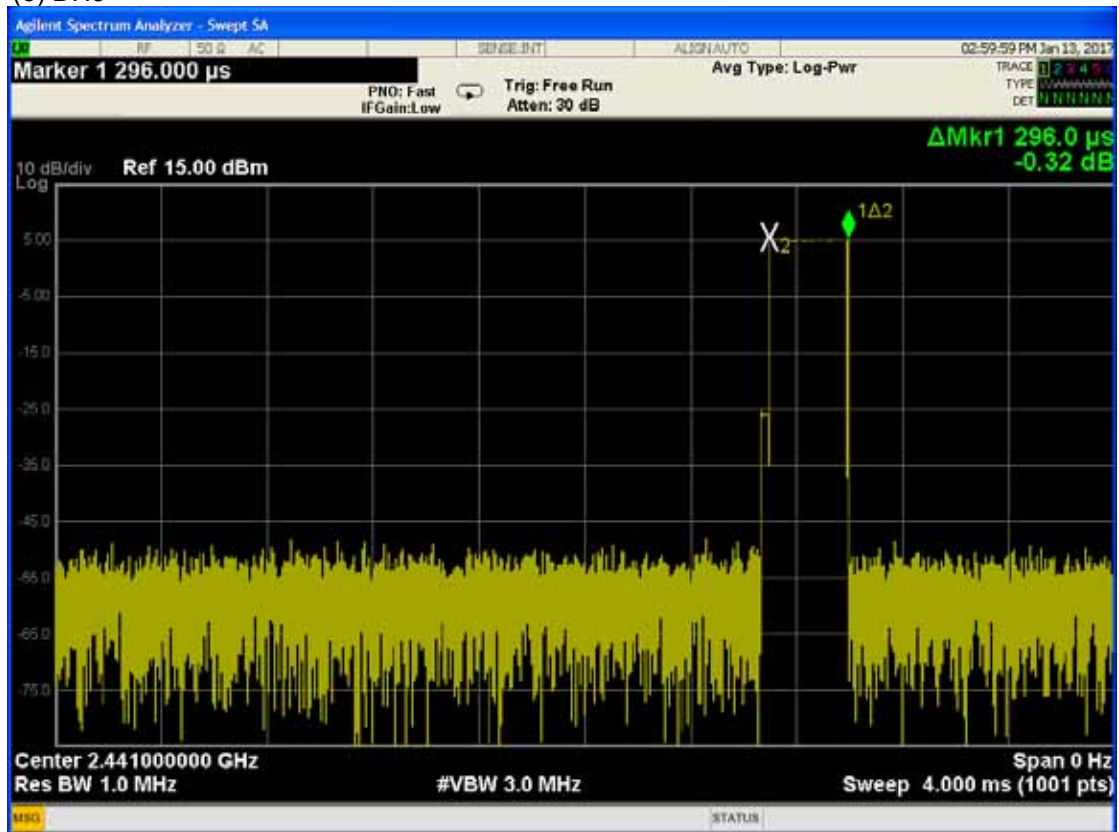

3. Highest channel (2.480 GHz):

(1) DH1

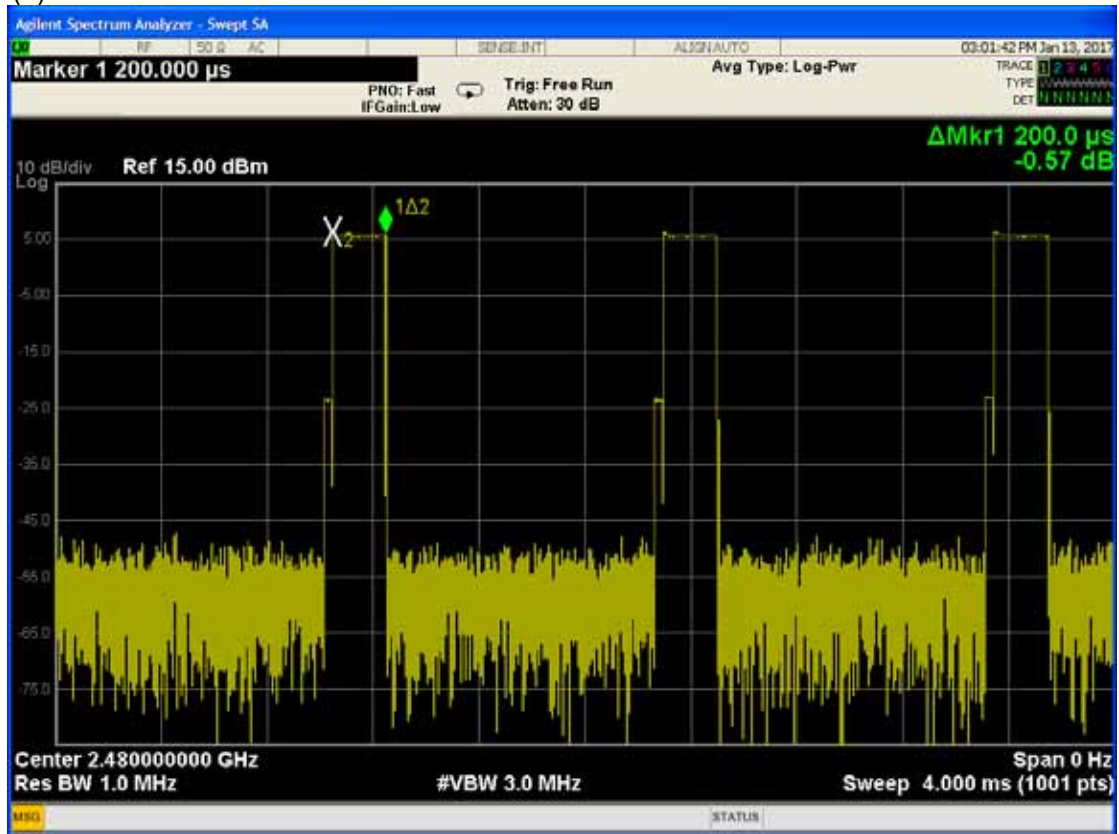

(2) DH3

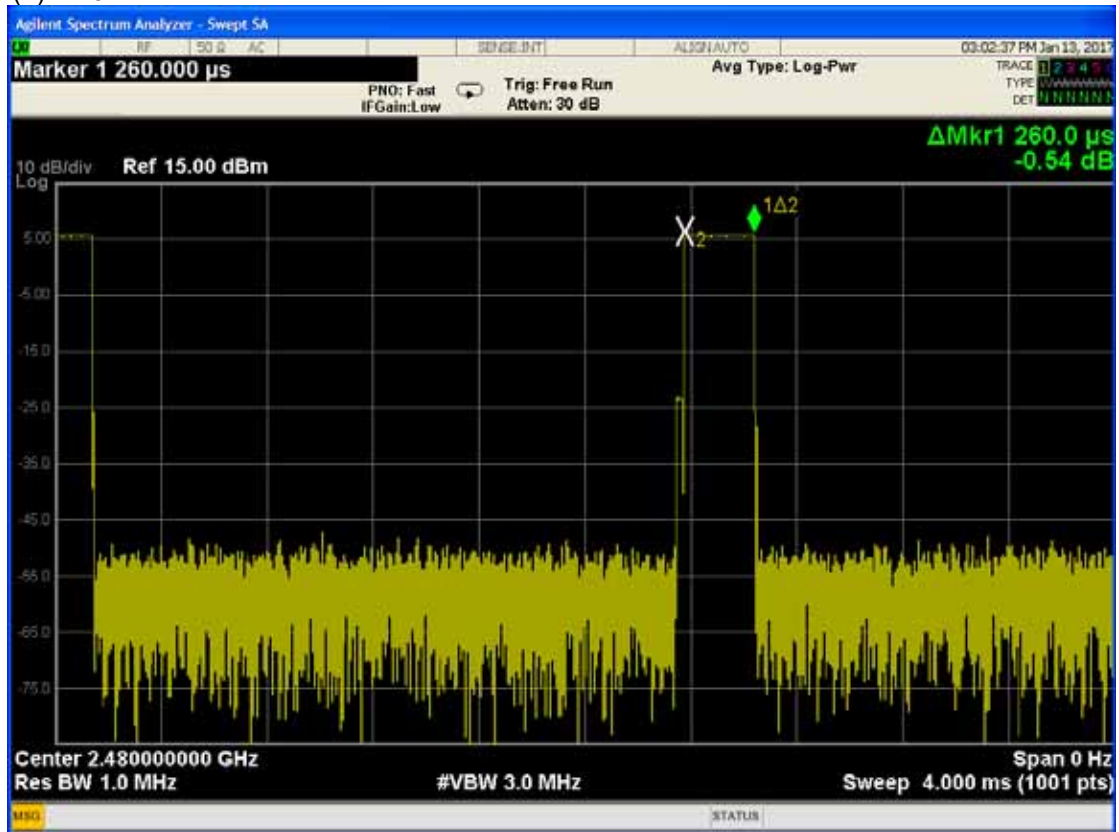

(3) DH5

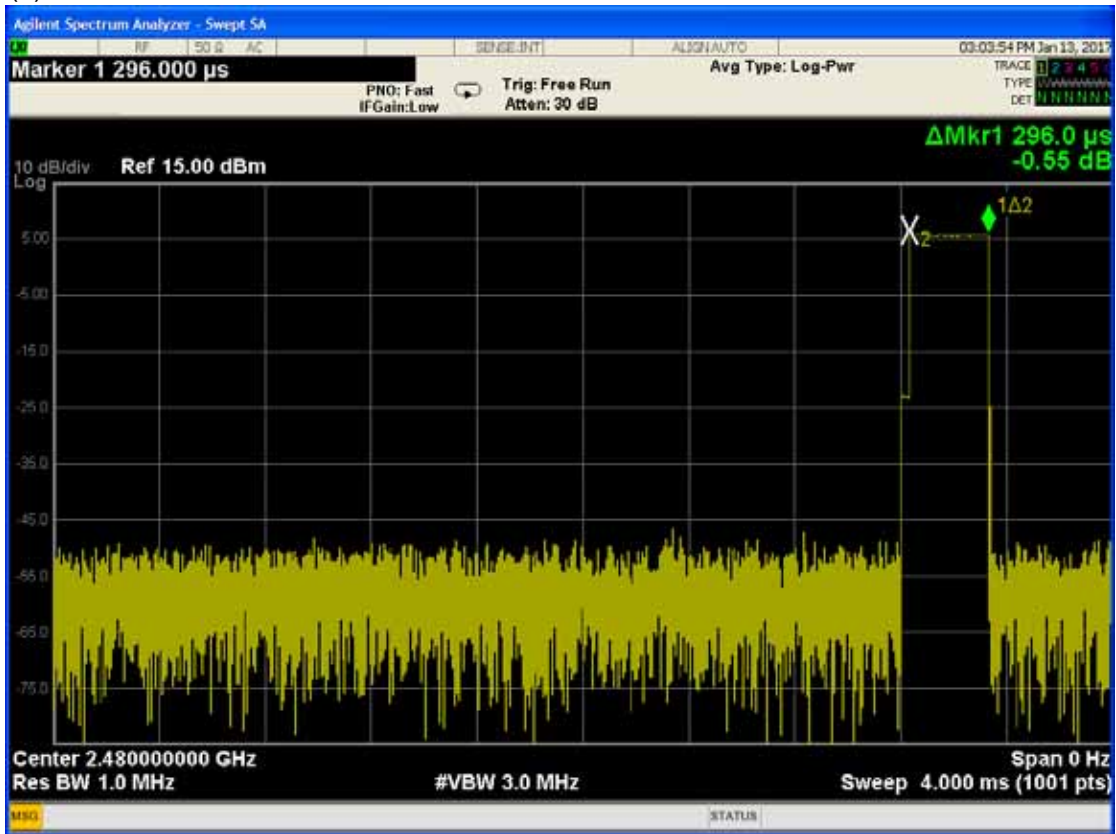

4. Lowest channel (2.402 GHz):

(1) 2DH1



(2) 2DH3

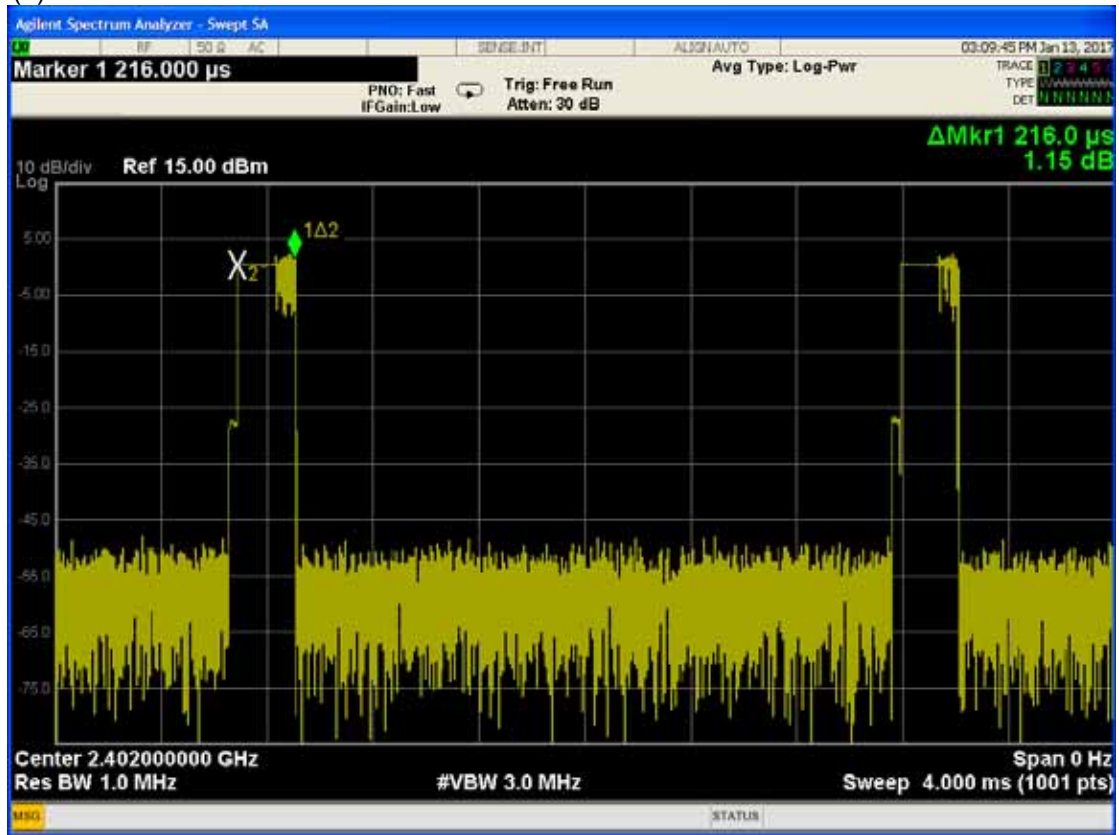

(3) 2DH5

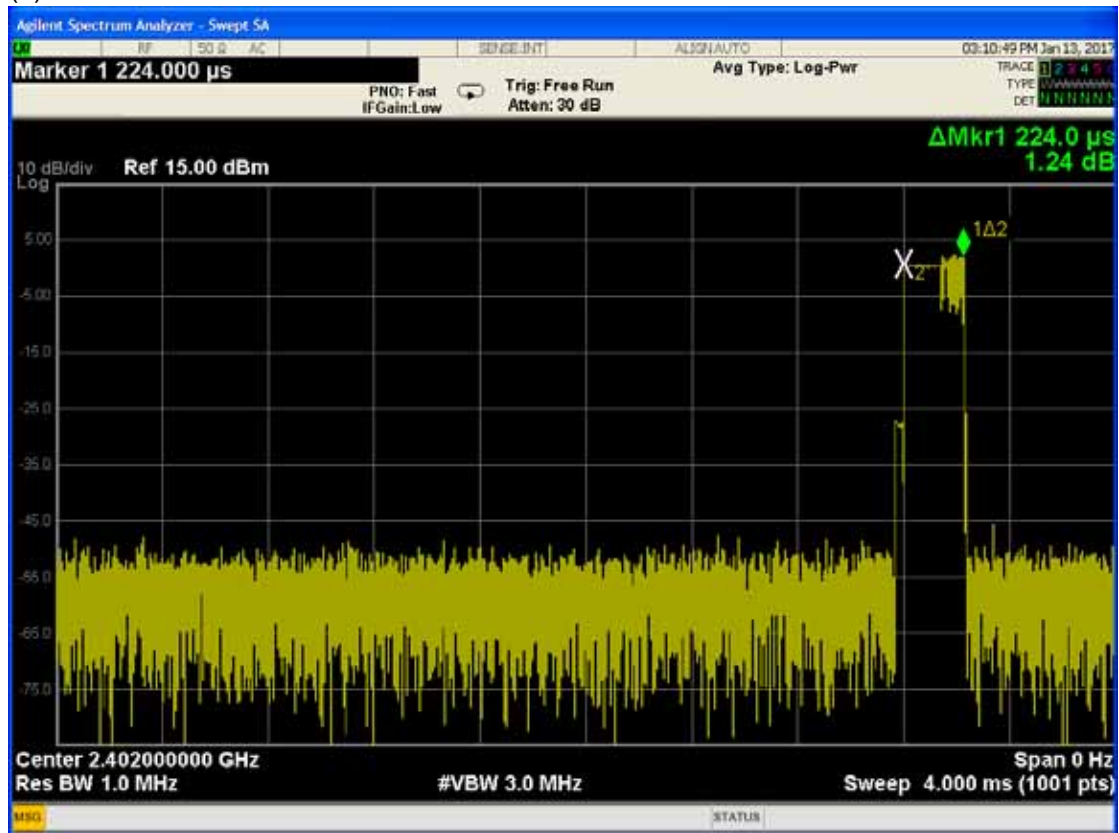

5. Middle channel (2.441 GHz):

(1) 2DH1

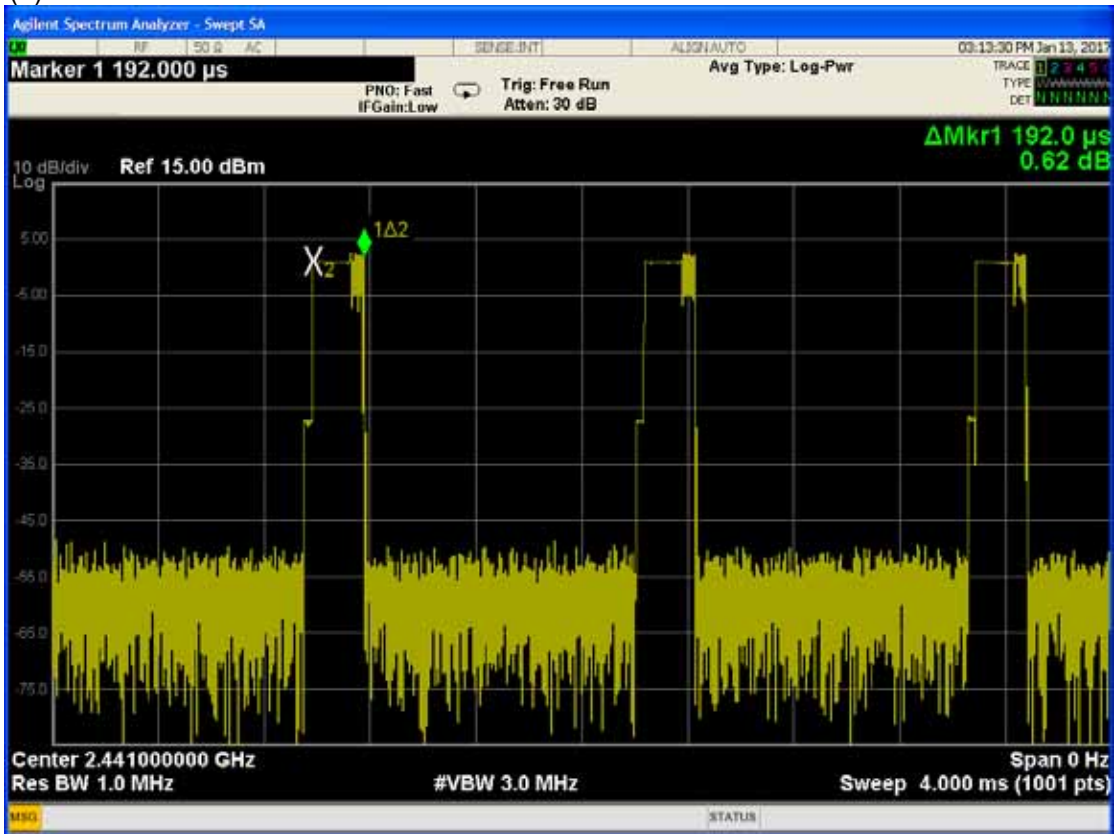

(2) 2DH3



(3) 2DH5

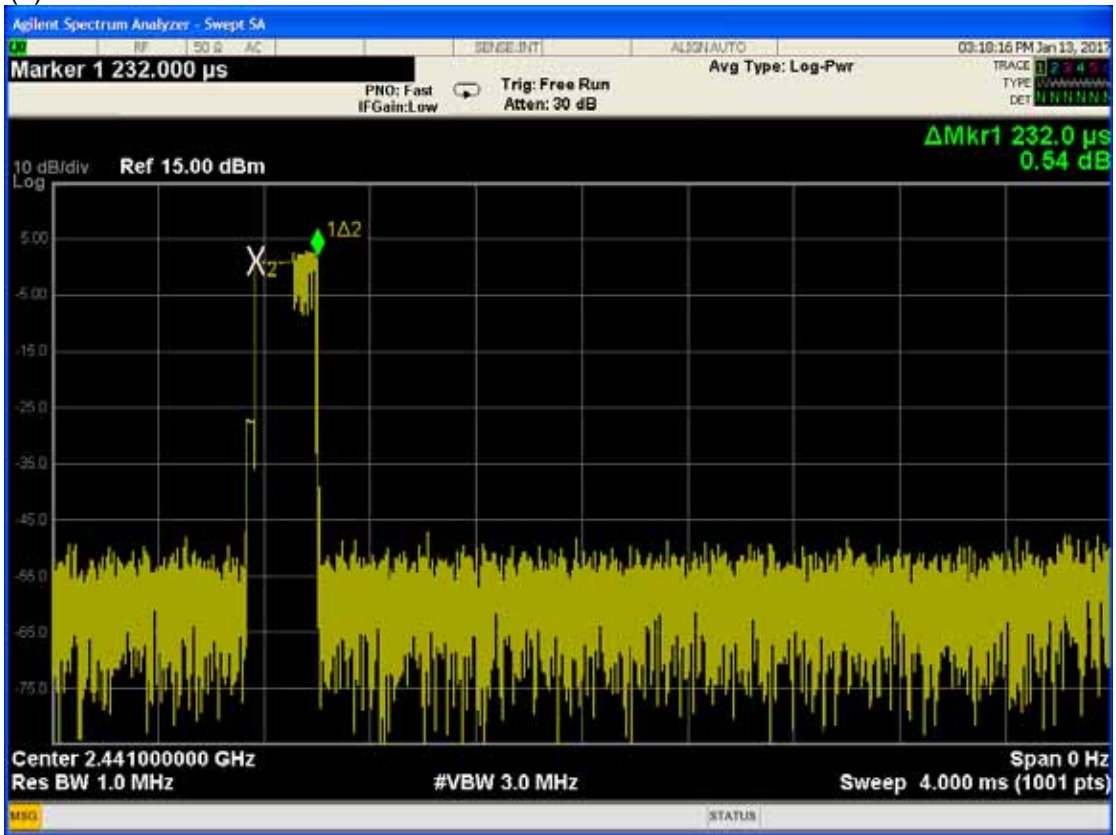

6. Highest channel (2.480 GHz):

(1) 2DH1

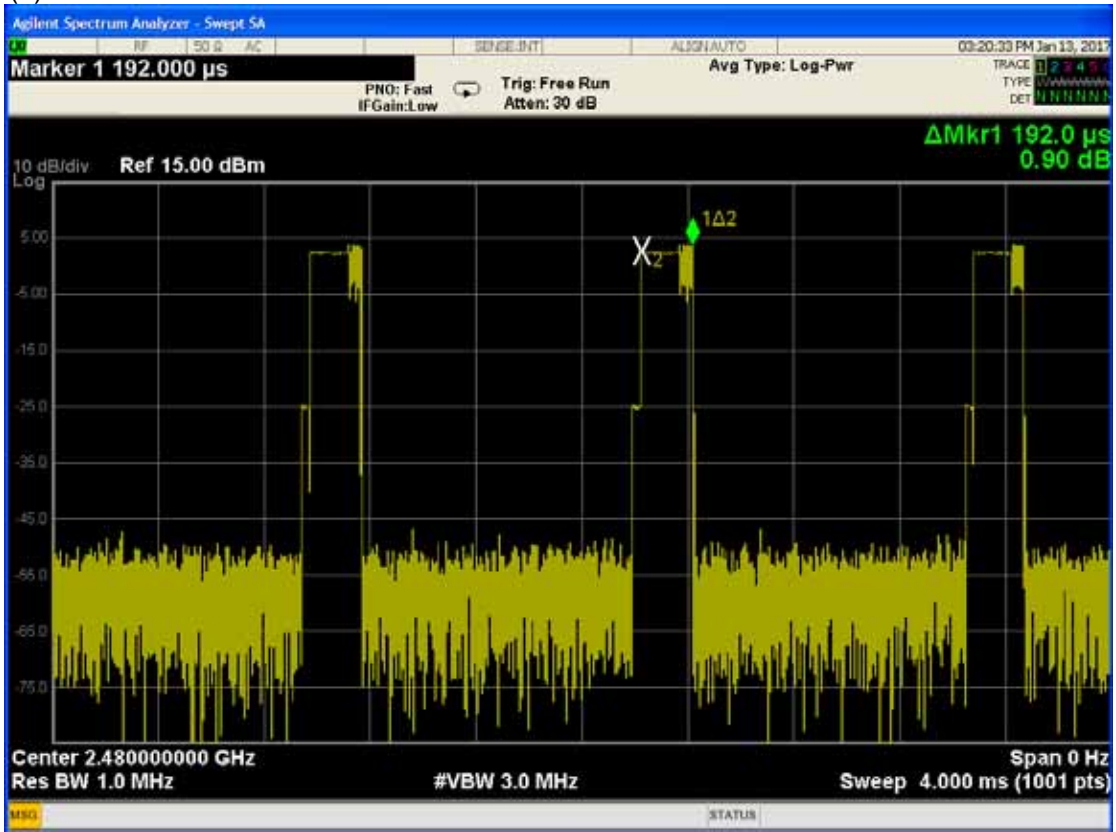

(2) 2DH3

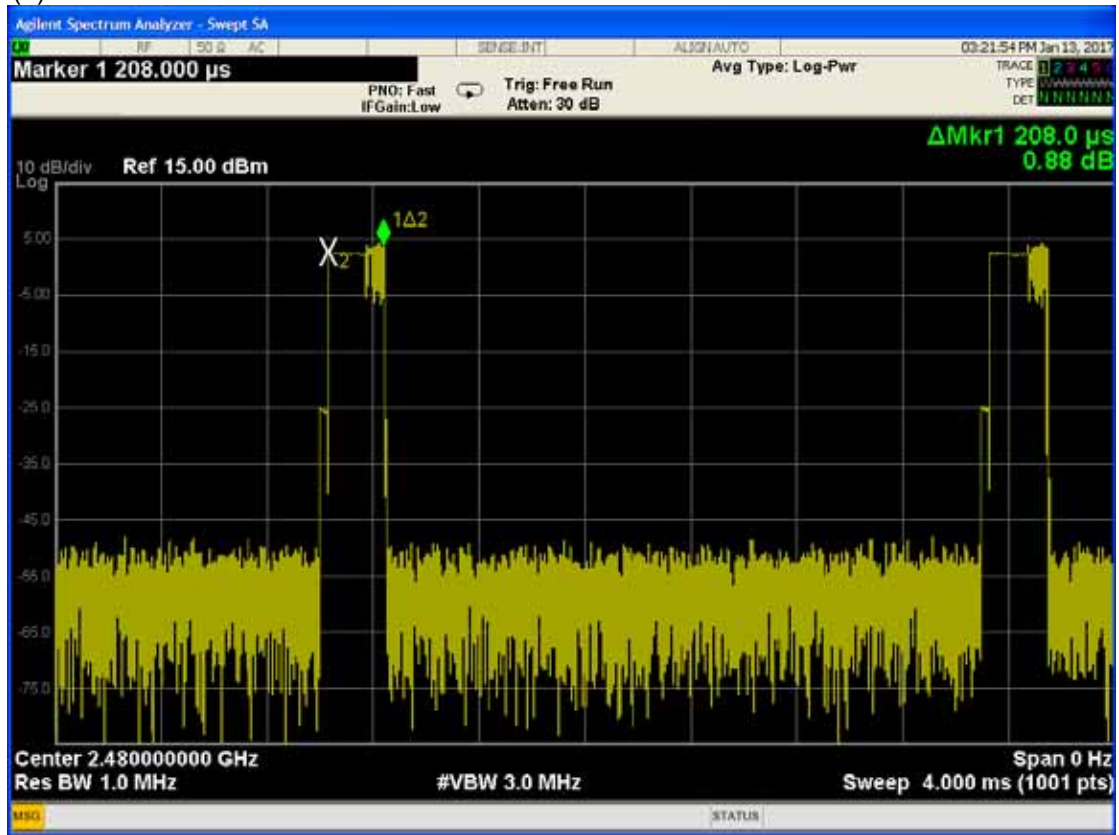

(3) 2DH5

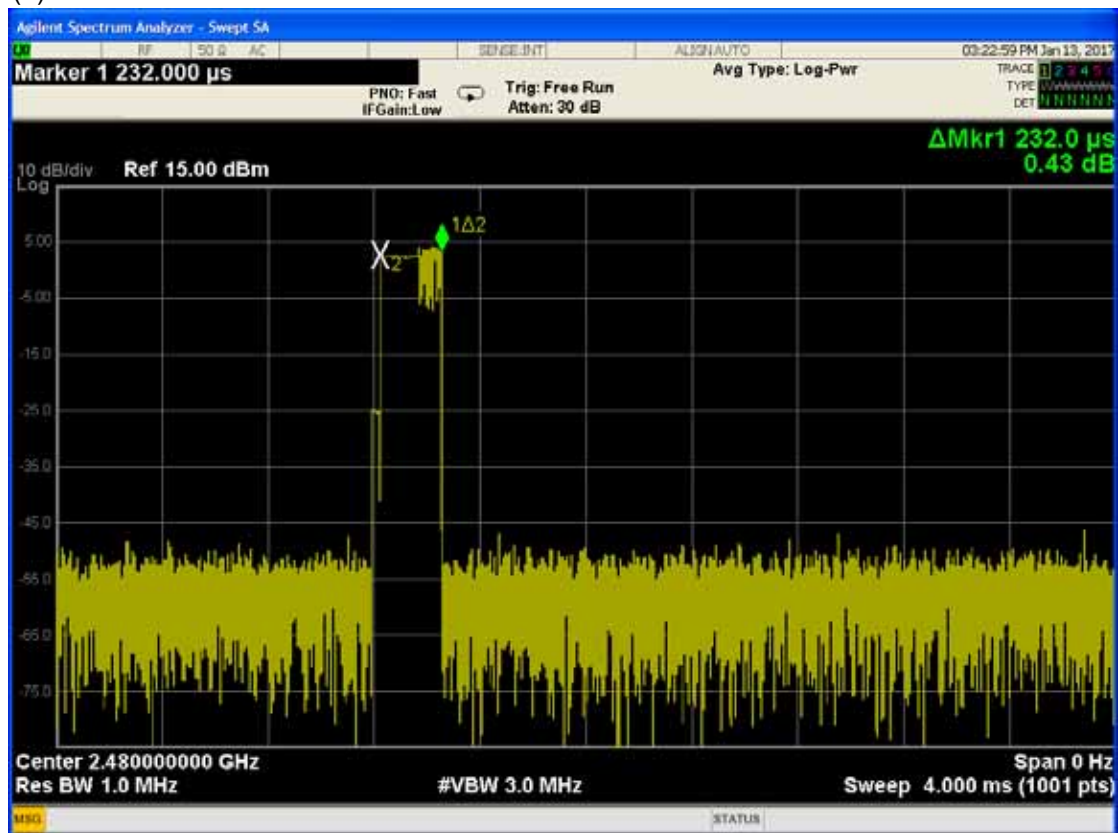



7. Lowest channel (2.402 GHz):

(1). 3DH1

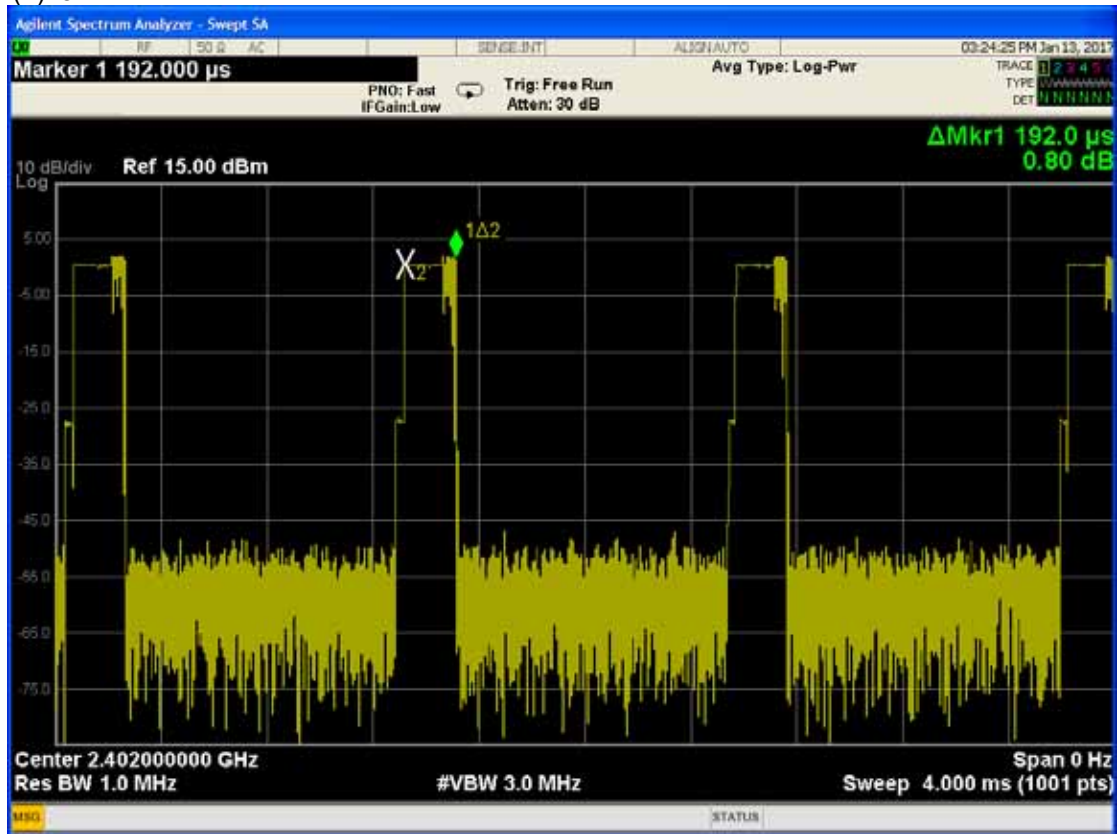

(2) 3DH3

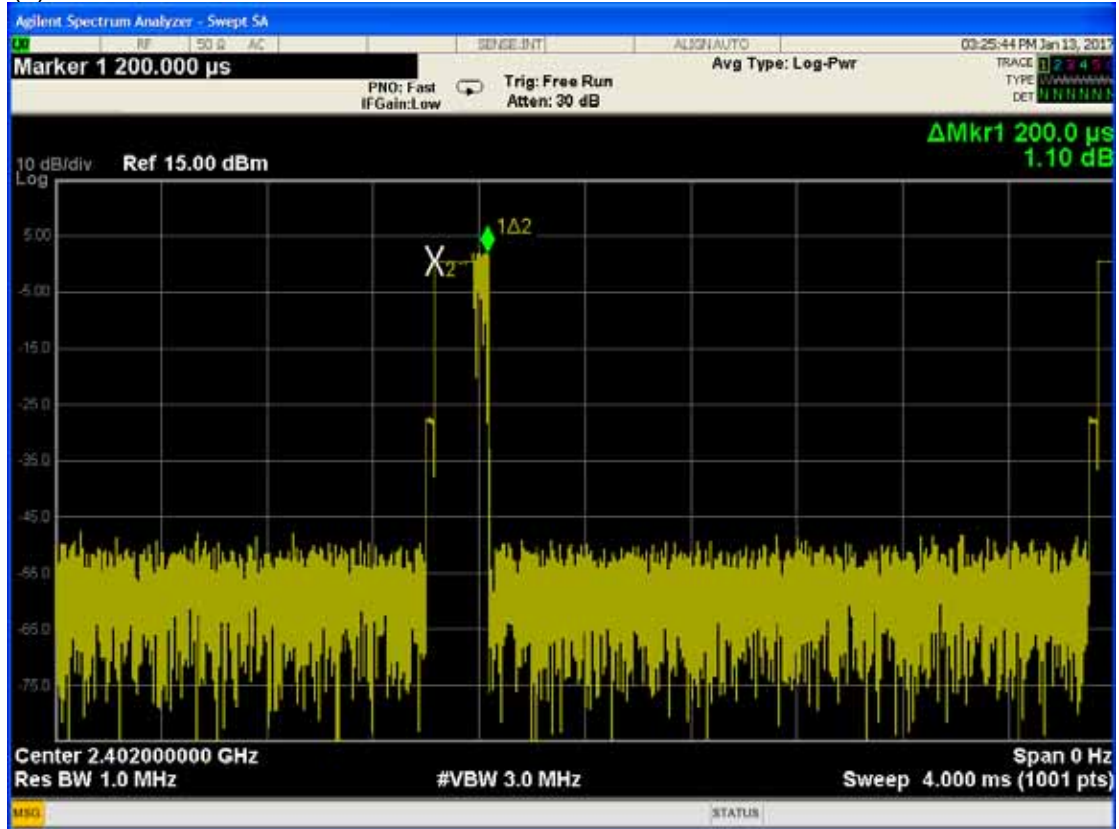

(3) 3DH5

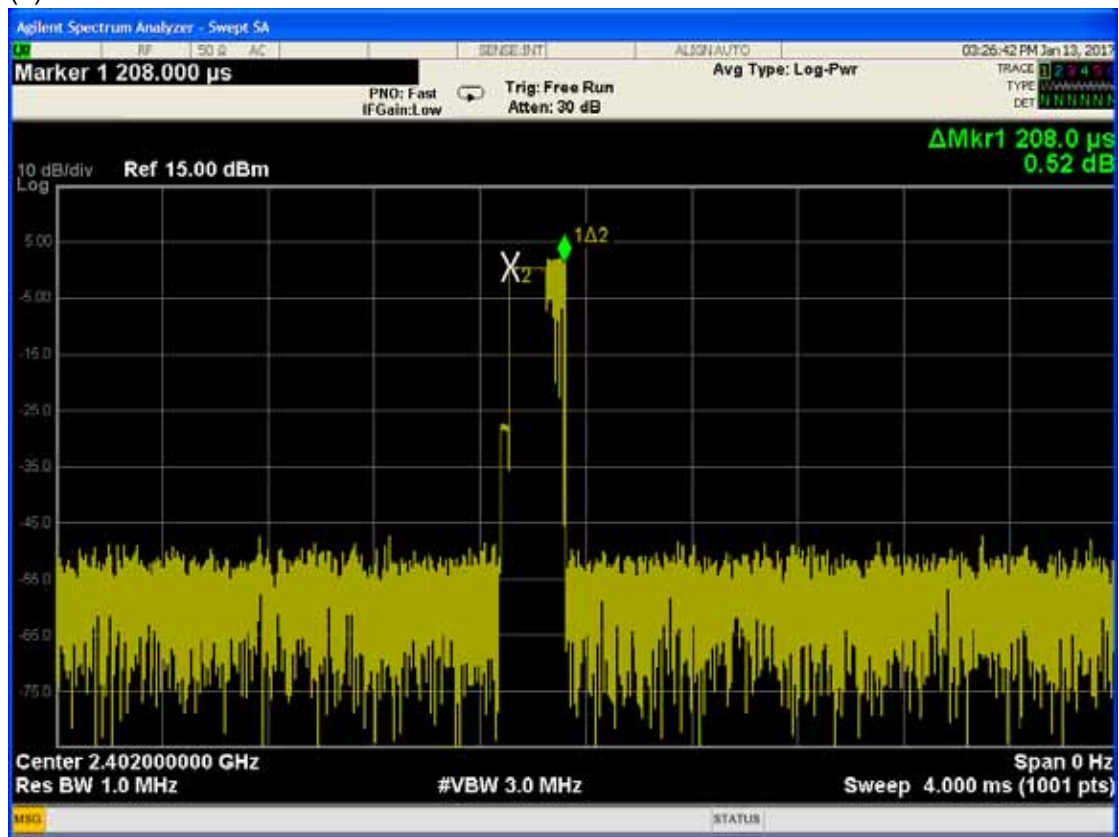

8. Middle channel (2.441 GHz):

(1). 3DH1

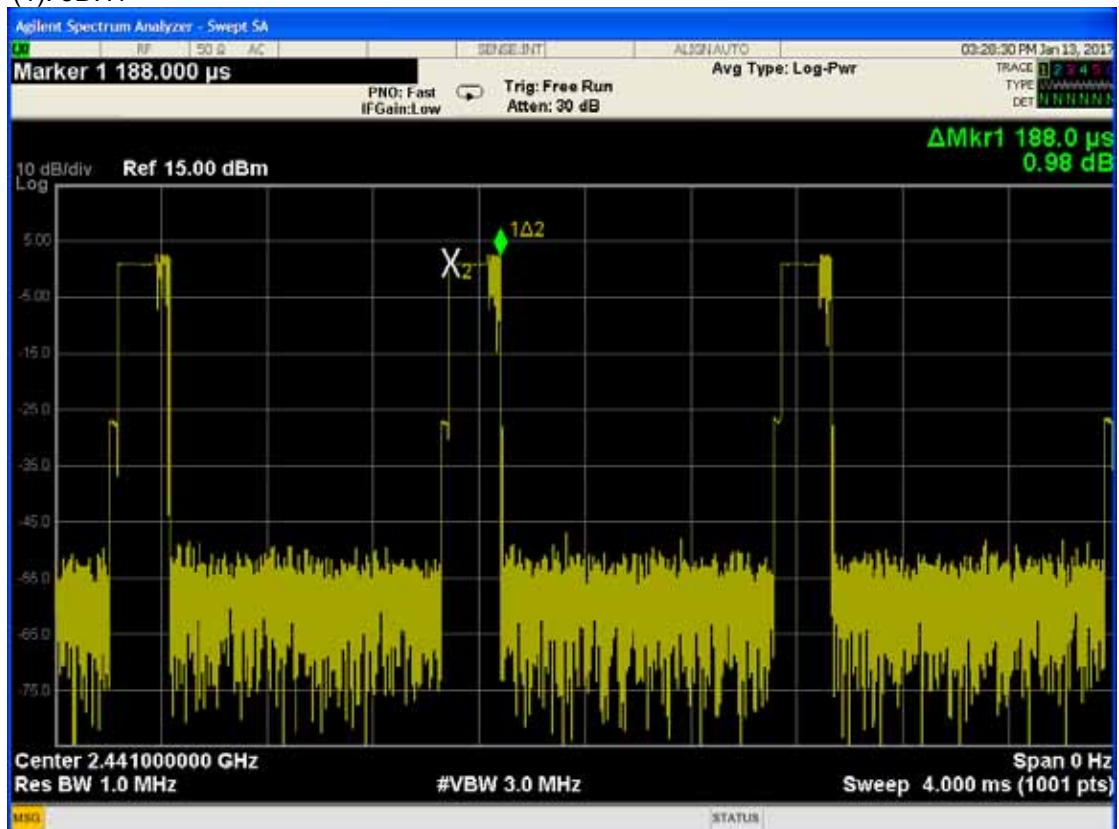

(2) 3DH3

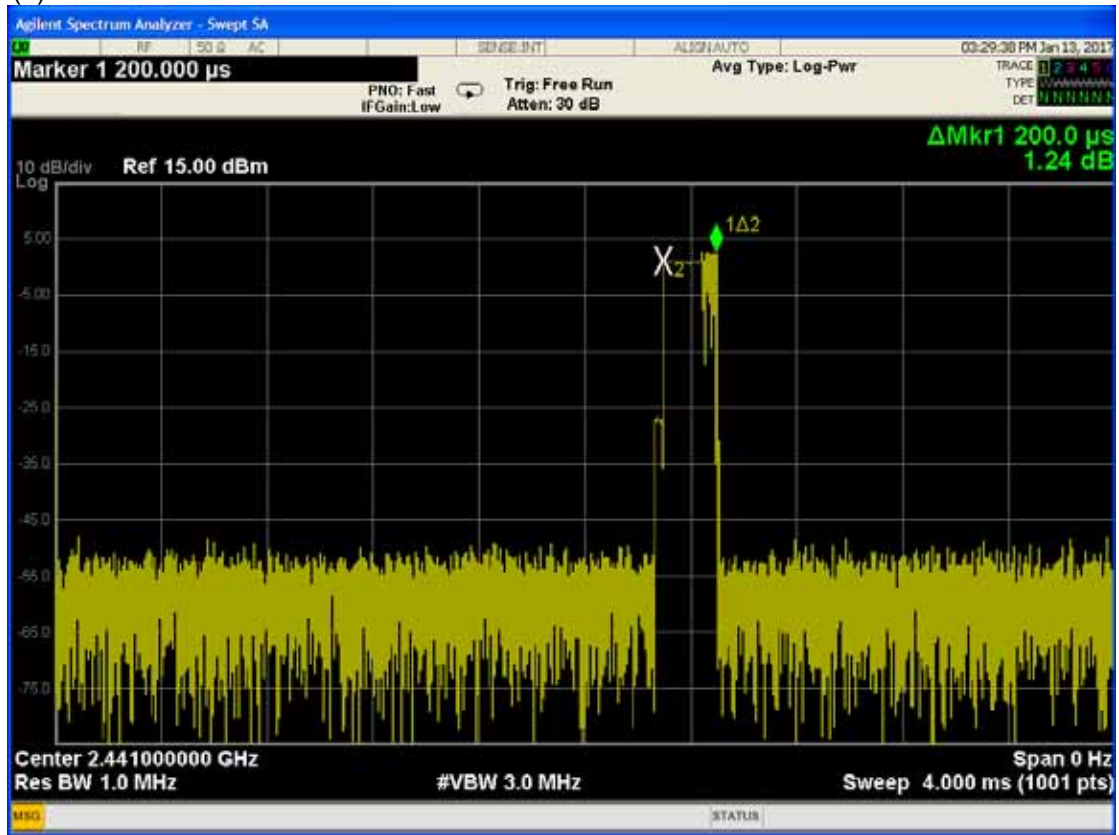

(3) 3DH5

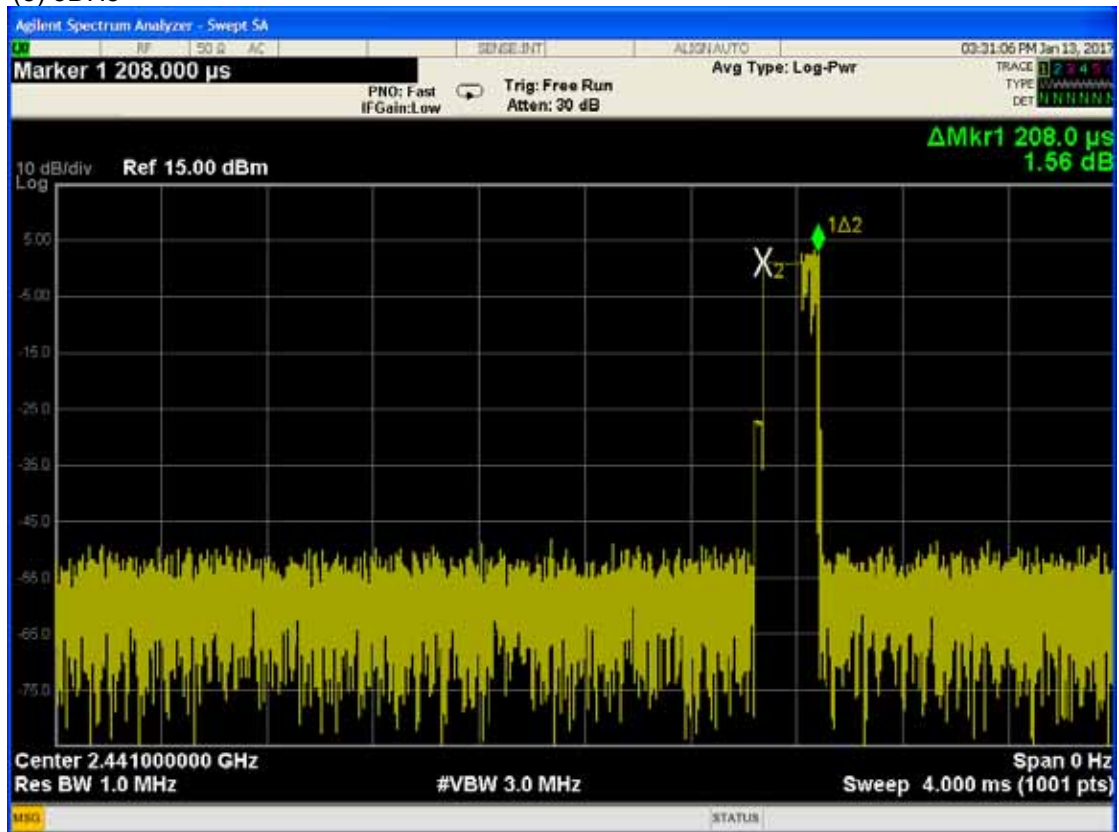

9. Highest channel (2.480 GHz):

(1). 3DH1

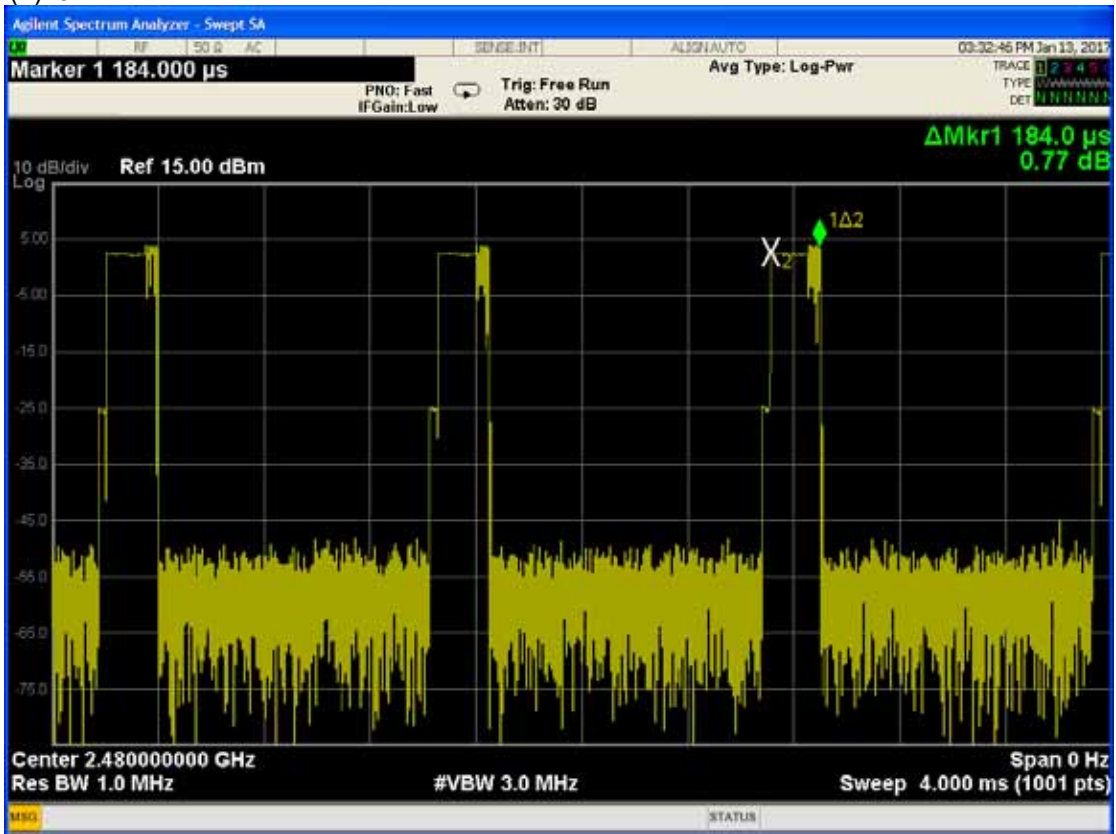

(2) 3DH3

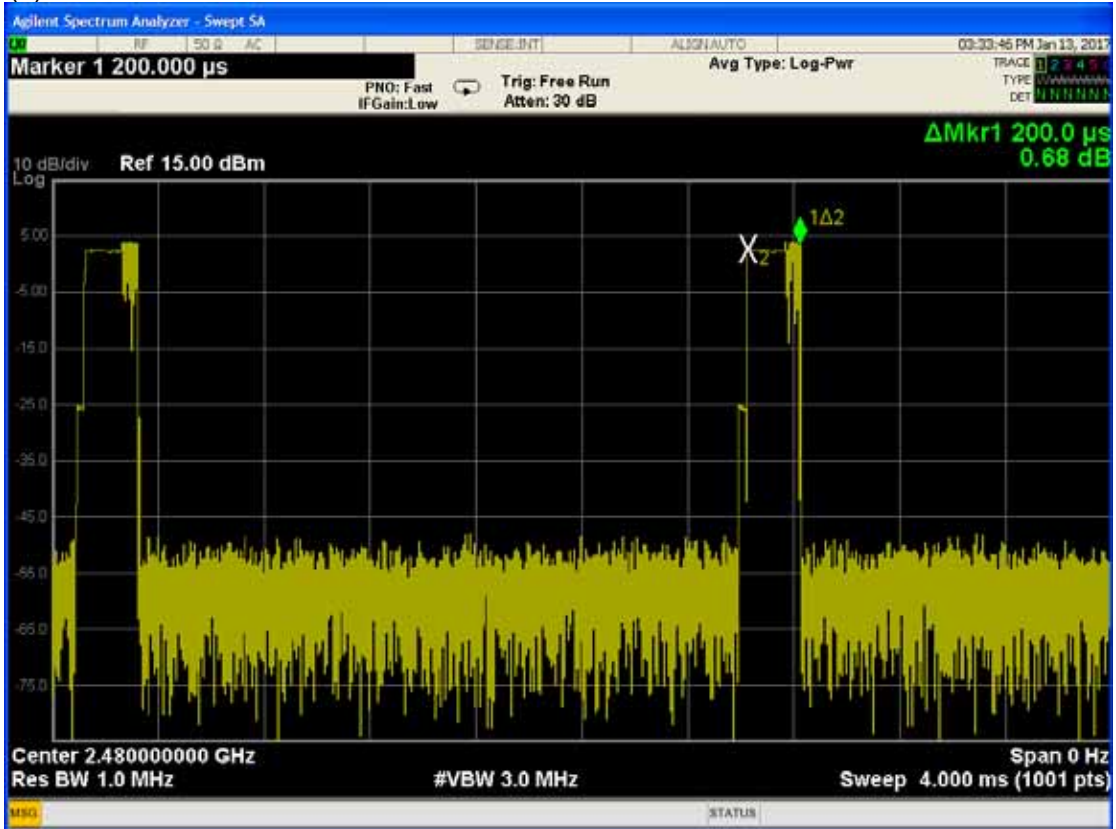



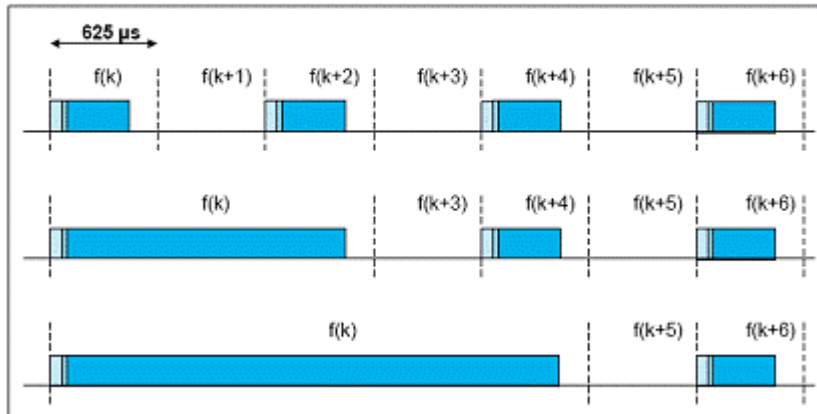

Figure 2.14: Single- and multi-slot packets.

Therefore, in a certain period for different packet types, the quantities of hops (not hopping rate 1600) are different, accurately, the quantity of hops for DH1 is double of DH3's and triple of DH5's. "for DH1 packet, 1 hop in 1 slot; for DH3 packet, 1/2 hop in 1 slot; for DH5 packet, 1/3 hop in 1 slot.", explained as below:

From the illustrated hopping scheme:

For DH1, in two slots, there are two hops, i.e.  $f(k)$  in Slot(k),  $f(k+1)$  in Slot(k+1), means DH1 1 hop in 1 slot;

For DH3, in four slots, there are two hops, i.e.  $f(k)$  in Slot(k) & Slot(k+1) & Slot(k+2),  $f(k+3)$  in Slot(k+3), means DH3 2 hops in four slots  $\rightarrow$  1/2 hop in 1 slot;

For DH5, in six slots, there are two hops, i.e.  $f(k)$  in Slot(k) & Slot(k+1) & Slot(k+2) & Slot(k+3) & Slot(k+4),  $f(k+5)$  in Slot(k+5), means DH3 2 hops in six slots  $\rightarrow$  1/3 hop in 1 slot.

The Hopping rate in the formula should not be fixed value, for DH1, it is  $1600/2$ ; for DH3, it is  $1600/4$ ; for DH5, it is  $1600/6$ .

To calculate Dwell time of data transmission of Bluetooth system, the worst case is for Bluetooth PICONET that contains two devices only (although Bluetooth PICONET can support up to eight devices), and for Bluetooth data transmission, after device A sending a packet to device B, device A must get response packet from device B to continue data transmission;

For DH1 packet: assume device A is EUT, the worst case is after device A sending a DH1 packet to device B, device A gets a DH1 response packet from device B, that means device A needs 1 time slot for transmitting and 1 time slot for receiving, therefore, the actual hopping rate of device A is half of 1600, i.e. 800 hops per second for EUT;

For DH3 packet: assume device A is EUT, the worst case is after device A sending a DH3 packet to device B, device A gets a DH1 response packet from device B, that means device A needs 3 time slots for transmitting and 1 time slot for receiving, therefore, the actual hopping rate of device A is quarter of 1600, i.e. 400 hops per second for EUT;

For DH5 packet: assume device A is EUT, the worst case is after device A sending a DH5 packet to device B, device A gets a DH1 response packet from device B, that means device A needs 5 time slots for transmitting and 1 time slot for receiving, therefore, the actual hopping rate of device A is sixth of 1600, i.e.  $1600/6=266.7$  hops per second for EUT;

## 5.7 Maximum Peak Output Power

**Test Requirement:** FCC Part 15 C section 15.247

(b)(1) For frequency hopping systems operating in the 2400-2483.5 MHz band employing at least 75 non-overlapping hopping channels, and all frequency hopping systems in the 5725-5850 MHz band: 1 watt. For all other frequency hopping systems in the 2400-2483.5 MHz band:

0.125 watts.

Refer to the result "Hopping channel number" of this document. The 1 watt (30.0 dBm) limit applies.

**Test Method:** ANSI C63.10:2013 Clause 6.10

**Test Limit:**

**Test mode:** Pre-test the EUT in continuous transmitting mode at the lowest, middle and highest channel with different data packet. Compliance test in continuous transmitting mode with normal (DH5), EDR mode (2DH5) and EDR mode (3DH5) as the worst case was found.

**Test Configuration:**

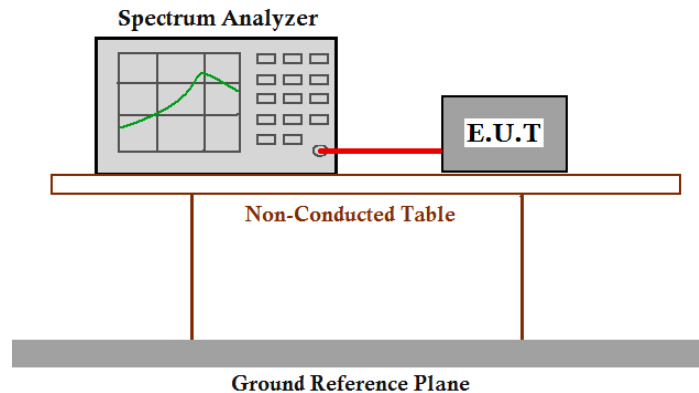

**Test Procedure:**

- 1 . Remove the antenna from the EUT and then connect a low attenuation RF cable from the antenna port to the spectrum.
- 2 . Set the spectrum analyzer: RBW = 3 MHz. VBW = 3 MHz. Sweep = auto; Detector Function = Peak.
- 3 . Keep the EUT in transmitting at lowest, medium and highest channel individually. Record the max value.



<b>Test Result: (For Bluetooth)</b>				
<b>Normal mode:</b>				
<b>Test Channel</b>	<b>Fundamental Frequency (MHz)</b>	<b>Output Power (dBm)</b>	<b>Limit (dBm)</b>	<b>Result</b>
Lowest	2402	4.895	30.0	Pass
Middle	2441	5.927	30.0	Pass
Highest	2480	6.877	30.0	Pass
<b>EDR mode(2DH5):</b>				
<b>Test Channel</b>	<b>Fundamental Frequency (MHz)</b>	<b>Output Power (dBm)</b>	<b>Limit (dBm)</b>	<b>Result</b>
Lowest	2402	3.247	21.0	Pass
Middle	2441	3.899	21.0	Pass
Highest	2480	5.138	21.0	Pass
<b>EDR mode(3DH5):</b>				
<b>Test Channel</b>	<b>Fundamental Frequency</b>	<b>Output Power (dBm)</b>	<b>Limit (dBm)</b>	<b>Result</b>
Lowest	2402	3.614	21.0	Pass
Middle	2441	4.238	21.0	Pass
Highest	2480	5.348	21.0	Pass
<b>Remark: cable lose=0.5dB</b>				
<b>Test result: The unit does meet the FCC requirements.</b>				
<b>Test result plot as follows:</b>				

For Bluetooth

Normal mode:

Lowest Channel:

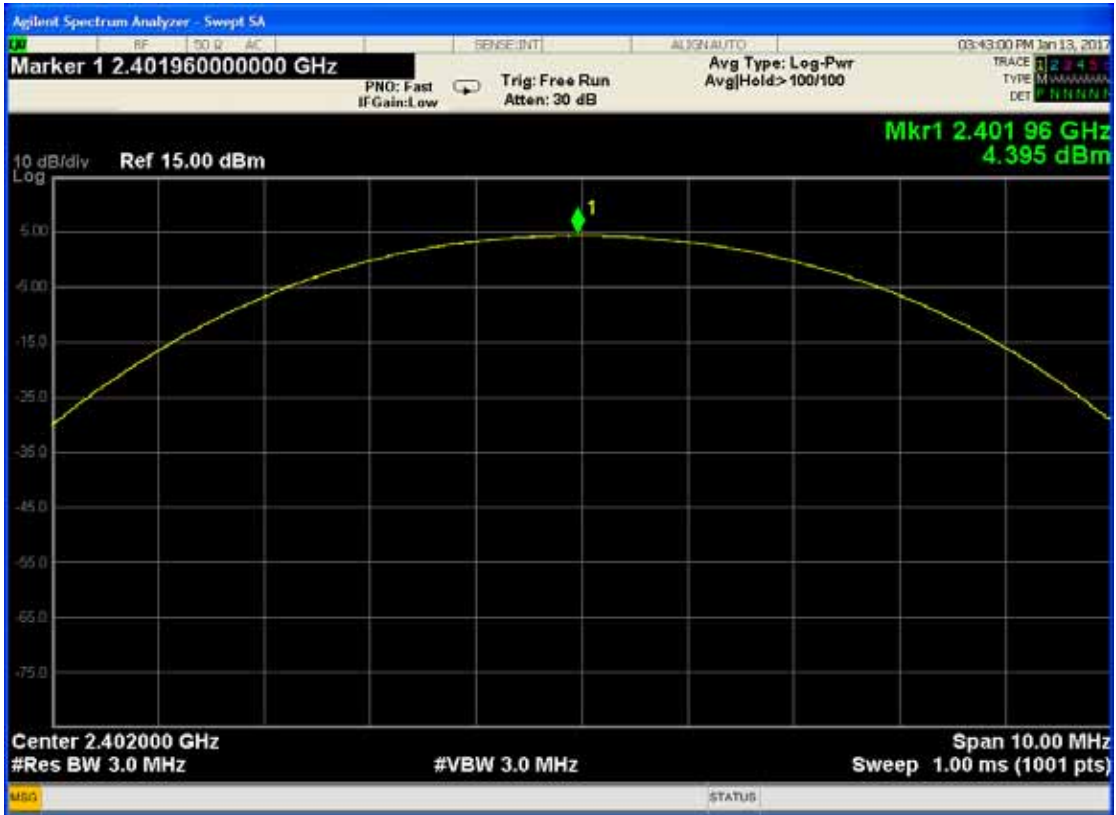

Middle Channel:

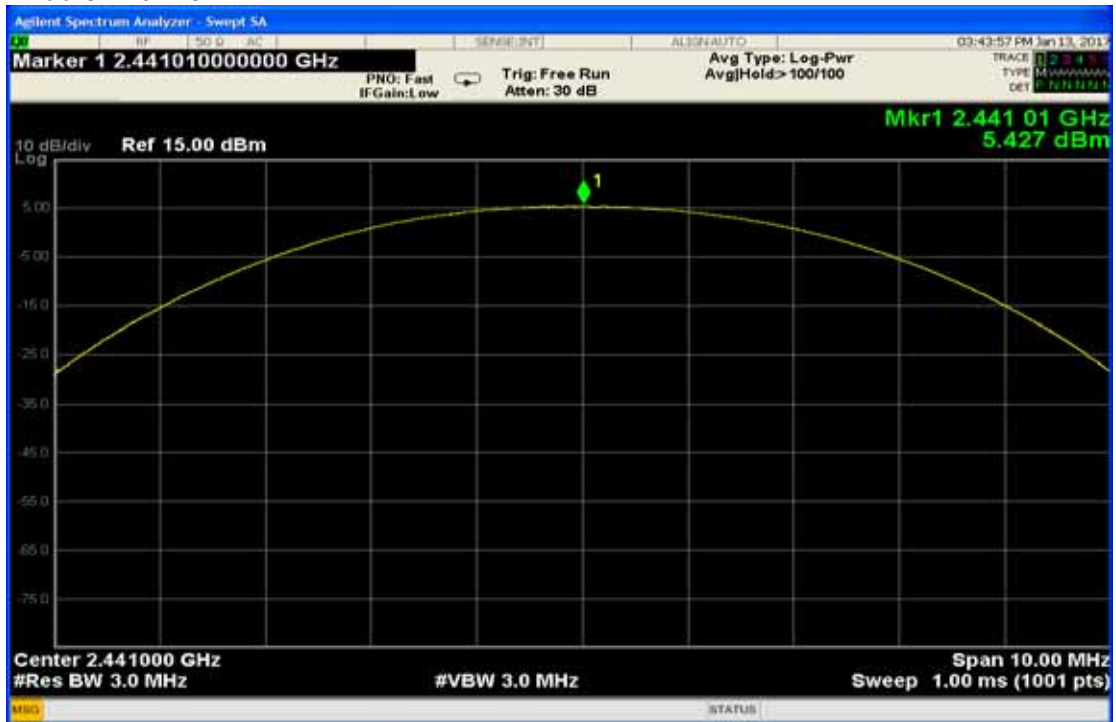

Highest Channel:



EDR mode (2DH5):  
Lowest Channel:



Middle Channel:



Highest Channel:



EDR mode (3DH5):  
Lowest Channel:



Middle Channel:



Highest Channel:



## 5.8 Conducted Spurious Emissions

**Test Requirement:** FCC Part15 C section 15.247

(d) In any 100 kHz bandwidth outside the frequency band in which the spread spectrum or digitally modulated intentional radiator is operating. The radio frequency power that is produced by the intentional radiator shall be at least 20 dB below that in the 100 kHz bandwidth within the band that contains the highest level of the desired power. Based on either an RF conducted or a radiated measurement. Provided the transmitter demonstrates compliance with the peak conducted power limits.

**Test Method:** ANSI C63.10:2013 Clause 6.7

**Test Status:** Pre-test the EUT in continuous transmitting mode at the lowest, middle and highest channel with different data packet. Compliance test in continuous transmitting mode with normal (DH5), EDR mode (2DH5) and EDR mode (3DH5) as the worst case was found.

**Test Configuration:**

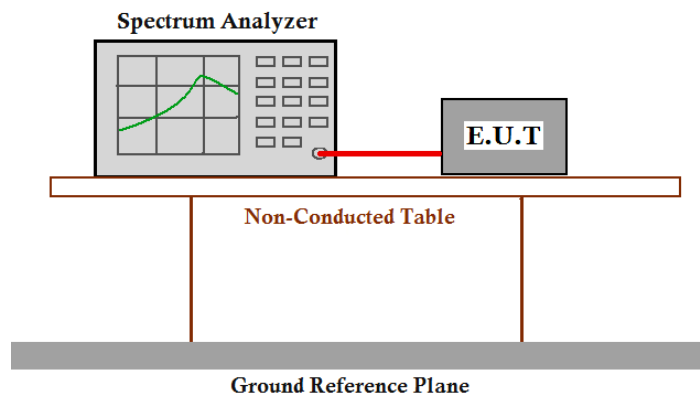

**Test Procedure:**

1. Remove the antenna from the EUT and then connect a low attenuation RF cable from the antenna port to the spectrum.
2. Set the spectrum analyzer: RBW = 100 kHz. VBW  $\geq$  RBW. Sweep = auto; Detector Function = Peak (Max. hold).













**5.9 Radiated Spurious Emissions**

**Test Requirement:** FCC Part15 C section 15.247  
 (d) In any 100 kHz bandwidth outside the frequency band in which the spread spectrum or digitally modulated intentional radiator is operating. The radio frequency power that is produced by the intentional radiator shall be at least 20 dB below that in the 100 kHz bandwidth within the band that Contains the highest level of the desired power, based on either an RF conducted or a radiated measurement, and provided the transmitter demonstrates compliance with the peak conducted power limits.

**Test Method:** ANSI C63.10:2013 Clause 6.4, 6.5 and 6.6

**Test Status:** Pre-test the EUT in continuous transmitting mode at the lowest, middle and highest channel with different data packet. Compliance test in continuous transmitting mode with normal mode (DH5) as the worst case was found.

**Detector:** For PK value:  
 RBW = 1 MHz for  $f \geq 1$  GHz, 100 kHz for  $f < 1$  GHz, 9kHz for  $<30$ MHz  
 VBW  $\geq$  RBW  
 Sweep = auto  
 Detector function = peak  
 Trace = max hold  
 For AV value:  
 RBW = 1 MHz for  $f \geq 1$  GHz, 100 kHz for  $f < 1$  GHz, 9kHz for  $<30$ MHz  
 VBW =10 Hz  
 Sweep = auto  
 Detector function = peak  
 Trace = max hold

15.209 Limit:

Frequency (MHz)	Field Strength (microvolts/meter)	Measurement Distance (meters)
0.009 - 0.490	2400/F(kHz)	300
0.490 - 1.705	24000/F(kHz)	30
1.705 - 30.0	30	30
30 - 88	100	3
88 - 216	150	3
216 - 960	200	3
Above 960	500	3

**Test Configuration:**

- 1) 9kHz to 30MHz emissions:

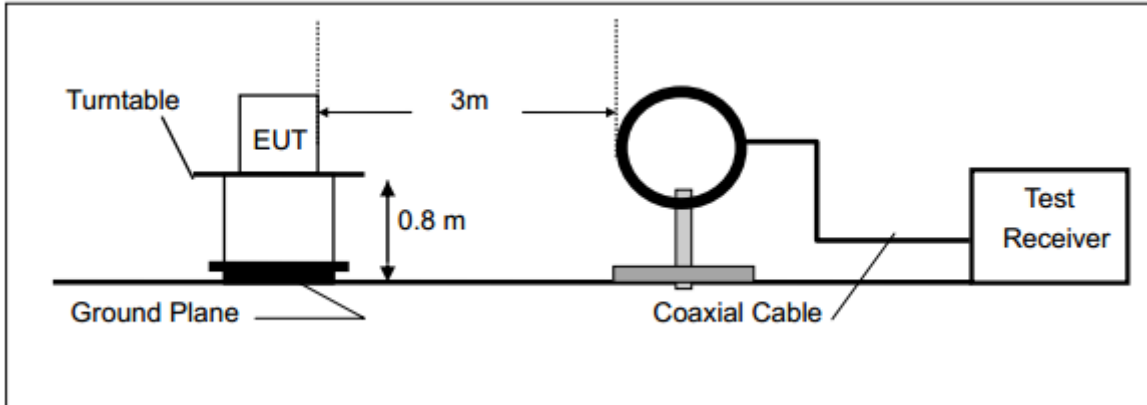

- 2) 30 MHz to 1 GHz emissions:

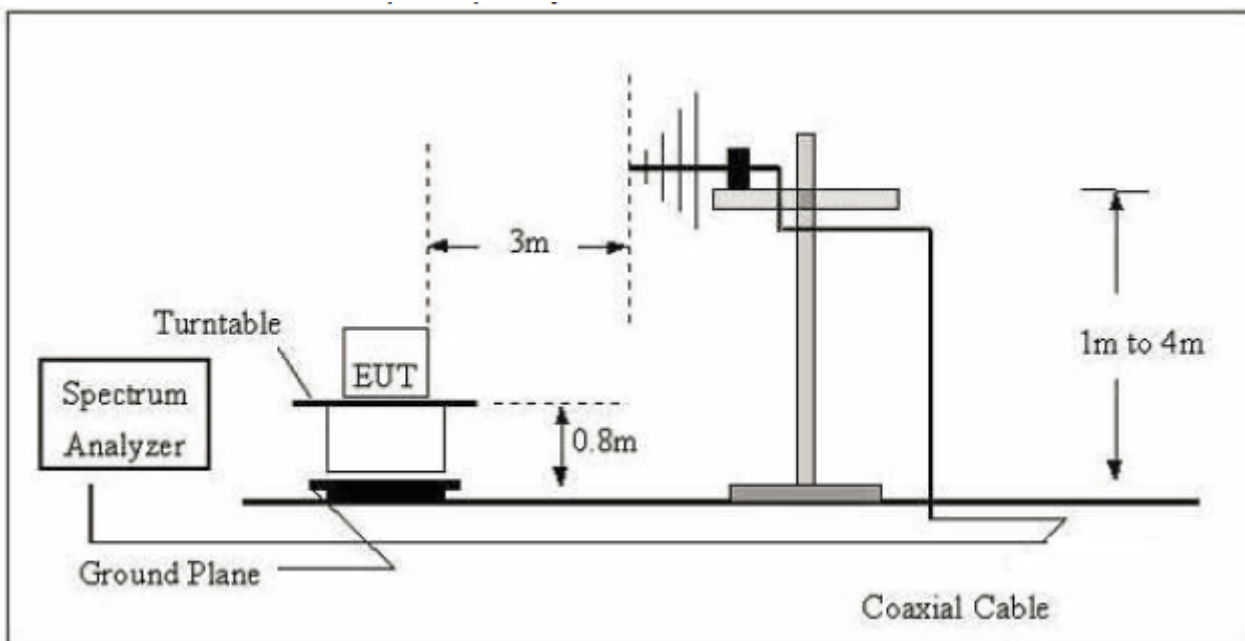

## 3) 1 GHz to 40 GHz emissions:

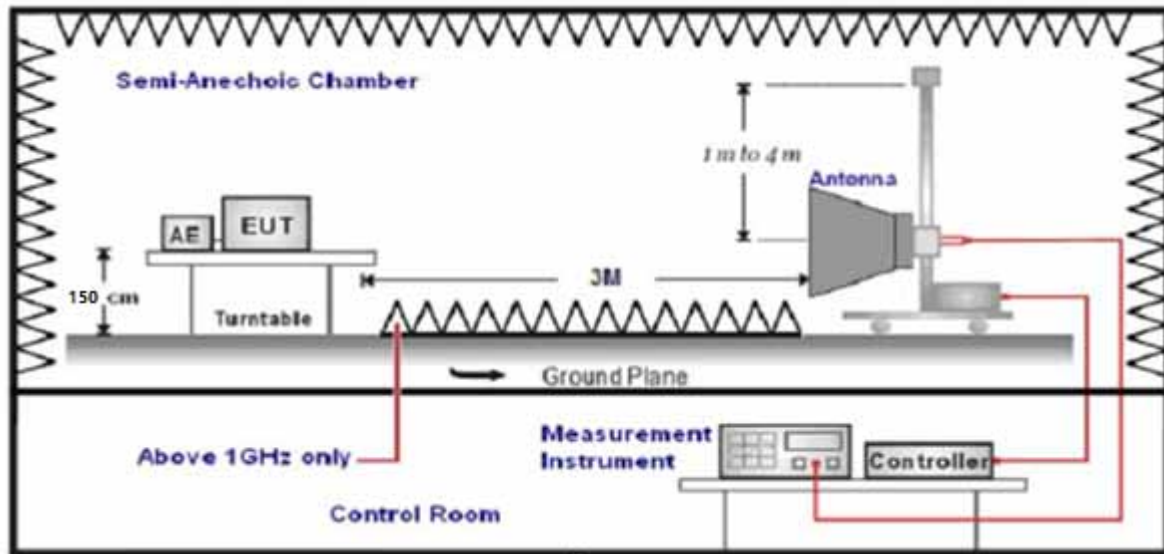

**Test Procedure:** The receiver was scanned from 9kHz to 25GHz. When an emission was found, the table was rotated to produce the maximum signal strength. An initial pre-scan was performed for in peak detection mode using the receiver. The EUT was measured for both the Horizontal and Vertical polarities and performed a pre-test three orthogonal planes. For intentional radiators, measurements of the variation of the input power or the radiated signal level of the fundamental frequency component of the emission, as appropriate, shall be performed with the supply voltage varied between 85% and 115% of the nominal rated supply voltage. After pre-test, it was found that the worse radiation emission was get at the X position. So the data shown was the X position only. The worst case emissions were reported.

Now set the VBW to 10 Hz, while maintaining all of the other instrument settings. This peak level, once corrected, must comply with the limit specified in Section 15.209. If the dwell time per channel of the hopping signal is less than 100 ms, then the reading obtained with the 10 Hz VBW may be further adjusted by a "duty cycle correction factor", derived from  $20\log(\text{dwell time}/100 \text{ ms})$ , in an effort to demonstrate compliance with the 15.209 limit. Submit this data.

**For the radiated emission test above 1GHz:**

Place the measurement antenna away from each area of the EUT determined to be a source of emissions at the specified measurement distance, while keeping the measurement antenna aimed at the source of emissions at each frequency of significant emissions, with polarization oriented for maximum response. The measurement antenna may have to be higher or lower than the EUT, depending on the radiation pattern of the emission and staying aimed at the emission source for receiving the maximum signal. The final measurement antenna elevation shall be that which maximizes the emissions. The measurement antenna elevation for maximum emissions shall be restricted to a range of heights of from 1 m to 4 m above the ground or reference ground plane.

5.9.1 Harmonic and other spurious emissions

Test at low Channel in transmitting status

9kHz~30MHz Test result

The Low frequency, which started from 9kHz to 30MHz, was pre-scanned and the result which was 20dB lower than the limit line per 15.31(o) was not report

30 MHz~1 GHz Spurious Emissions .Quasi-Peak Measurement

Horizontal:

Peak scan

Level (dBμV/m)

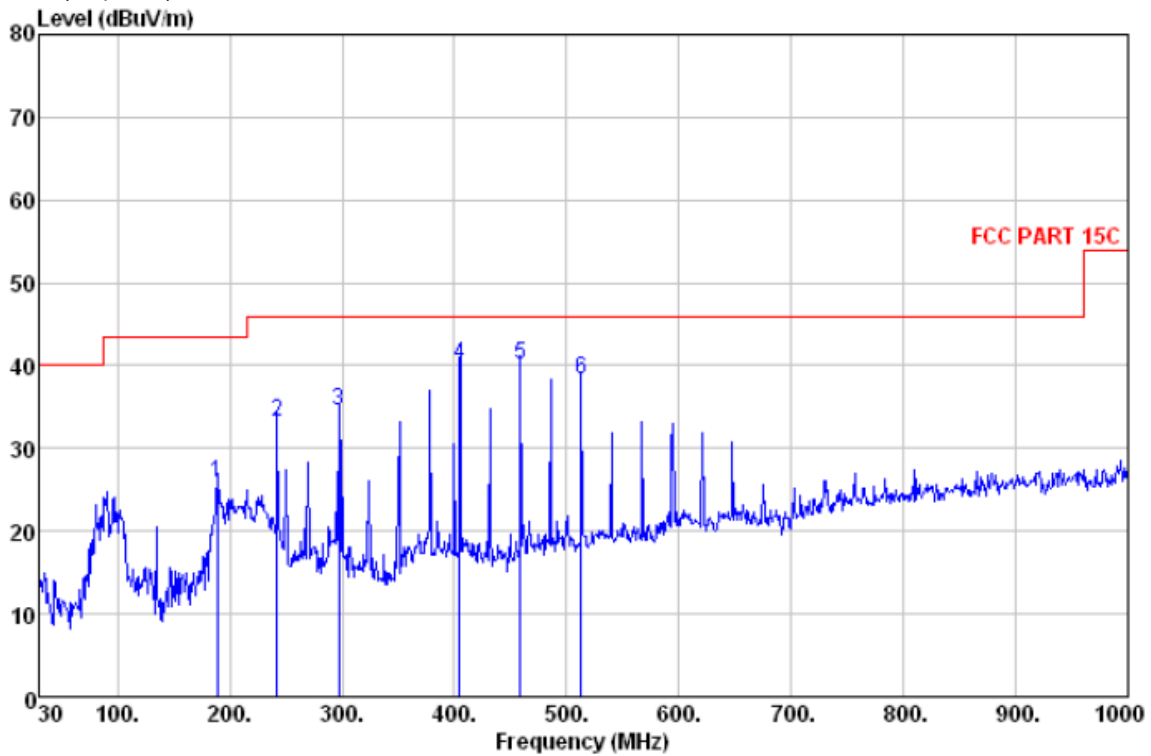

Quasi-peak measurement

No.	Freq MHz	Read Level dBuV	Antenna Factor dB	Cable Loss dB	Preamp Factor dB	Level dBuV/m	Limit Line dBuV/m	Over Limit dB	Pol/Phase	Remark
1	189.080	43.12	8.73	1.66	27.62	25.89	43.50	-17.61	HORIZONTAL	QP
2	242.430	47.73	10.84	1.90	27.22	33.25	46.00	-12.75	HORIZONTAL	QP
3	296.750	46.43	13.53	2.11	27.57	34.50	46.00	-11.50	HORIZONTAL	QP
4	404.420	49.89	15.84	2.47	28.18	40.02	46.00	-5.98	HORIZONTAL	QP
5	458.740	49.13	16.95	2.65	28.53	40.20	46.00	-5.80	HORIZONTAL	QP
6	513.060	45.81	18.38	2.81	28.69	38.31	46.00	-7.69	HORIZONTAL	QP

Level=Read Level + Antenna Factor + Cable Loss - Preamp Factor



**Test at low Channel in transmitting status**

30 MHz~1 GHz Spurious Emissions .Quasi-Peak Measurement

**Vertical:**

Peak scan

Level (dBμV/m)

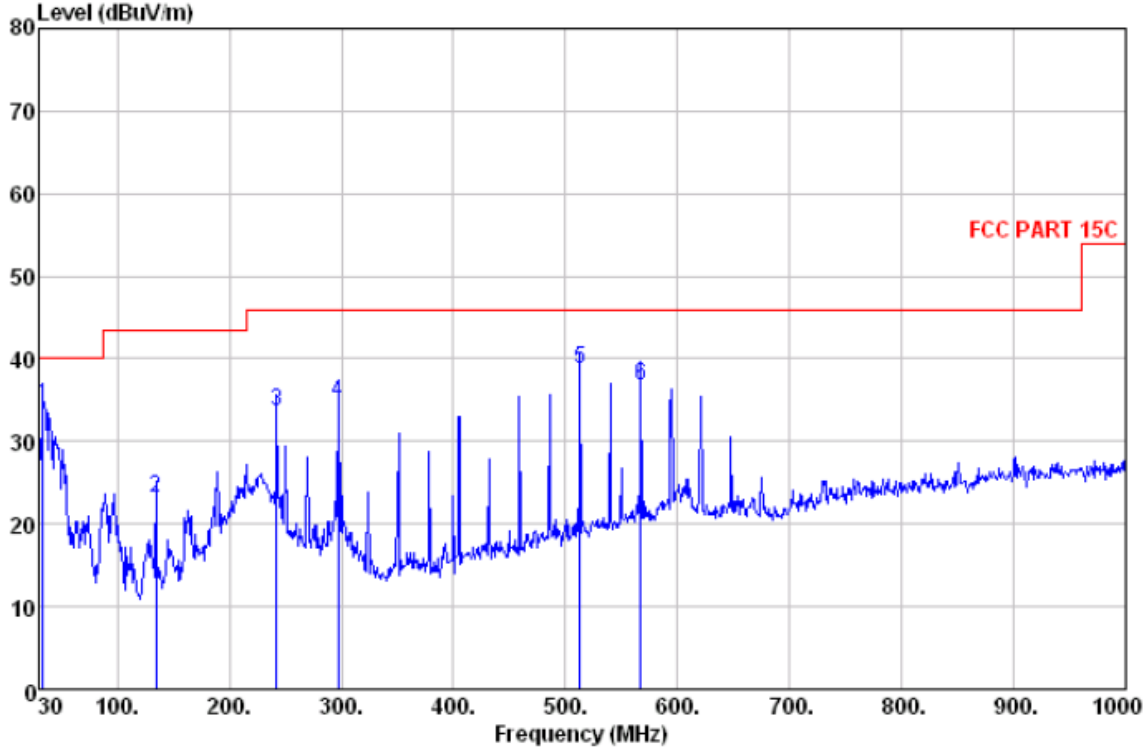

Quasi-peak measurement

No.	Freq MHz	Read Level dBμV	Antenna Factor dB	Cable Loss dB	Preamp Factor dB	Level dBμV/m	Limit Line dBμV/m	Over Limit dB	Pol/Phase	Remark
1	33.880	46.35	15.88	0.66	28.58	34.31	40.00	-5.69	VERTICAL	QP
2	134.760	42.66	7.40	1.38	28.30	23.14	43.50	-20.36	VERTICAL	QP
3	242.430	48.17	10.84	1.90	27.22	33.69	46.00	-12.31	VERTICAL	QP
4	296.750	46.76	13.53	2.11	27.57	34.83	46.00	-11.17	VERTICAL	QP
5	513.060	46.23	18.38	2.81	28.69	38.73	46.00	-7.27	VERTICAL	QP
6	567.380	42.99	19.47	2.97	28.76	36.67	46.00	-9.33	VERTICAL	QP

**Level=Read Level + Antenna Factor + Cable Loss - Preamp Factor**

## 1~25 GHz Harmonics &amp; Spurious Emissions. Peak &amp; Average Measurement

**Peak Measurement:**

Frequency (MHz)	Antenna factors (dB/m)	Cable loss (dB)	Preamp factor (dB)	Reading Level (dB $\mu$ V)	Emission Level (dB $\mu$ V/m)	Limit (dB $\mu$ V/m)	Antenna polarization
4804.000	34.32	9.59	27.62	34.52	50.81	74.00	V
7206.000	34.88	12.15	27.33	35.01	54.71	74.00	V
9608.000	37.72	14.41	27.14	35.88	60.87	74.00	V
4804.000	34.32	9.59	27.62	35.65	51.94	74.00	H
7206.000	34.88	12.15	27.33	35.71	55.41	74.00	H
9608.000	37.72	14.41	27.14	36.12	61.11	74.00	H

**Average Measurement:**

Frequency (MHz)	Antenna factors (dB/m)	Cable loss (dB)	Preamp factor (dB)	Reading Level (dB $\mu$ V)	Emission Level (dB $\mu$ V/m)	Limit (dB $\mu$ V/m)	Antenna polarization
4804.000	34.32	9.59	27.62	23.54	39.83	54.00	V
7206.000	34.88	12.15	27.33	25.12	44.82	54.00	V
9608.000	37.72	14.41	27.14	24.66	49.65	54.00	V
4804.000	34.32	9.59	27.62	23.98	40.27	54.00	H
7206.000	34.88	12.15	27.33	24.01	43.71	54.00	H
9608.000	37.72	14.41	27.14	24.04	49.03	54.00	H

**Test at Middle Channel in transmitting status**

9kHz~30MHz Test result

The Low frequency, which started from 9kHz to 30MHz, was pre-scanned and the result which was 20dB lower than the limit line per 15.31(o) was not report

30 MHz~1 GHz Spurious Emissions .Quasi-Peak Measurement

Horizontal:

Peak scan

Level (dBμV/m)

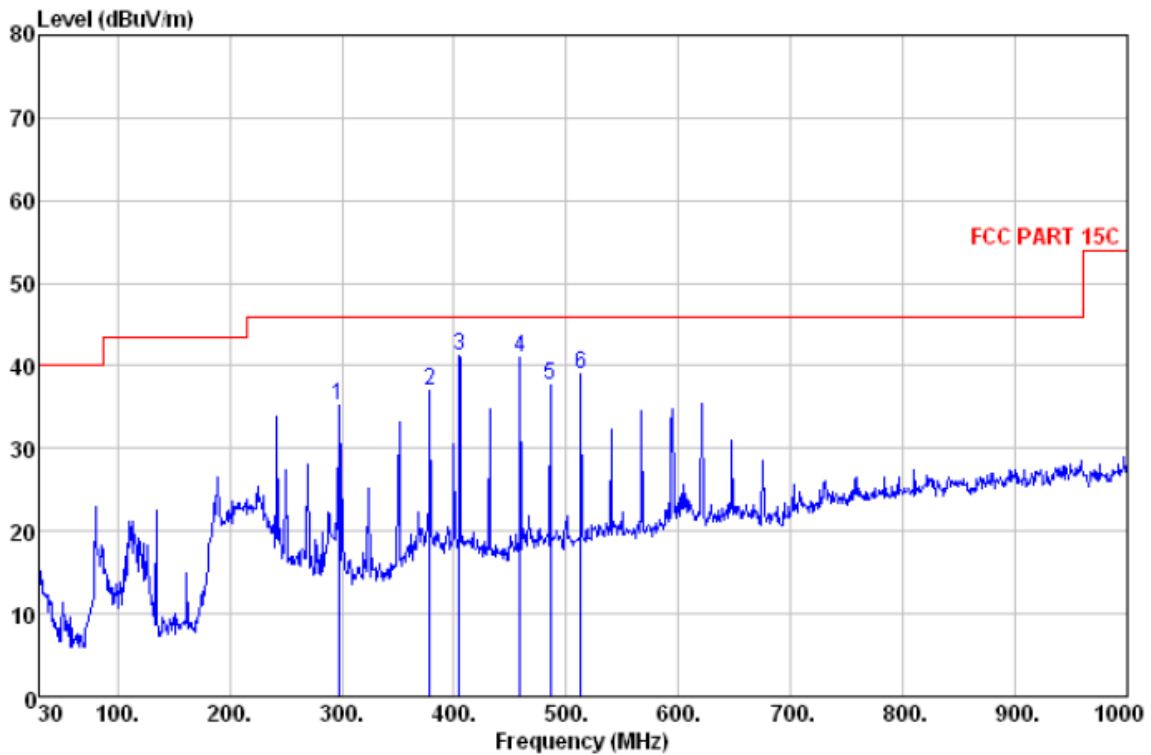

Quasi-peak measurement

No.	Freq MHz	Read Level dBμV	Antenna Factor dB	Cable Loss dB	Preamp Factor dB	Level dBμV/m	Limit Line dBμV/m	Over Limit dB	Pol/Phase	Remark
1	296.750	47.18	13.53	2.11	27.57	35.25	46.00	-10.75	HORIZONTAL	QP
2	378.230	47.88	15.08	2.37	28.37	36.96	46.00	-9.04	HORIZONTAL	QP
3	404.420	51.00	15.84	2.47	28.18	41.13	46.00	-4.87	HORIZONTAL	QP
4	458.740	50.03	16.95	2.65	28.53	41.10	46.00	-4.90	HORIZONTAL	QP
5	485.900	45.46	18.06	2.74	28.58	37.68	46.00	-8.32	HORIZONTAL	QP
6	513.060	46.42	18.38	2.81	28.69	38.92	46.00	-7.08	HORIZONTAL	QP

**Level=Read Level + Antenna Factor + Cable Loss - Preamp Factor**

**Test at Middle Channel in transmitting status**

30 MHz~1 GHz Spurious Emissions .Quasi-Peak Measurement

Vertical:

Peak scan

Level (dBμV/m)

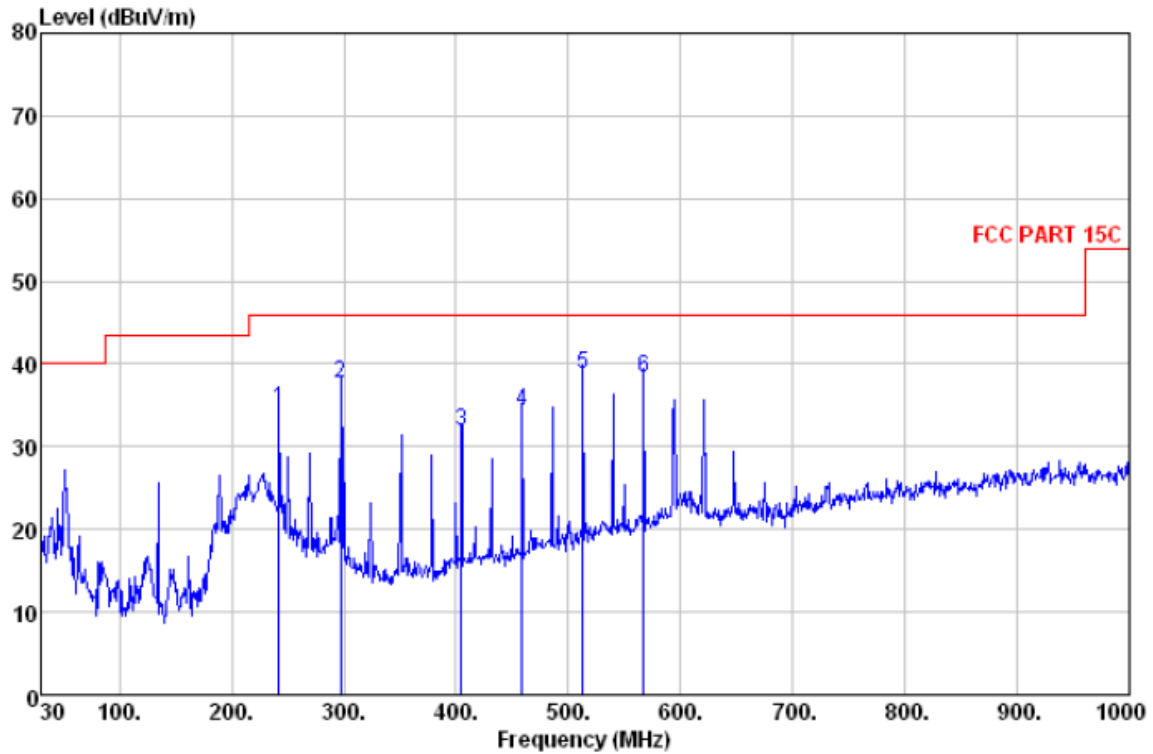

Quasi-peak measurement

No.	Freq MHz	Read Level dBμV	Antenna Factor dB	Cable Loss dB	Preamp Factor dB	Level dBμV/m	Limit Line dBμV/m	Over Limit dB	Pol/Phase	Remark
1	242.430	49.08	10.84	1.90	27.22	34.60	46.00	-11.40	VERTICAL	QP
2	296.750	49.50	13.53	2.11	27.57	37.57	46.00	-8.43	VERTICAL	QP
3	404.420	41.69	15.84	2.47	28.18	31.82	46.00	-14.18	VERTICAL	QP
4	458.740	43.20	16.95	2.65	28.53	34.27	46.00	-11.73	VERTICAL	QP
5	513.060	46.37	18.38	2.81	28.69	38.87	46.00	-7.13	VERTICAL	QP
6	567.380	44.72	19.47	2.97	28.76	38.40	46.00	-7.60	VERTICAL	QP

**Level=Read Level + Antenna Factor + Cable Loss - Preamp Factor**

## 1~25 GHz Harmonics &amp; Spurious Emissions. Peak &amp; Average Measurement

**Peak Measurement:**

Frequency (MHz)	Antenna factors (dB/m)	Cable loss (dB)	Preamp factor (dB)	Reading Level (dB $\mu$ V)	Emission Level (dB $\mu$ V/m)	Limit (dB $\mu$ V/m)	Antenna polarization
4882.000	34.33	9.59	27.60	35.76	52.08	74.00	V
7323.000	34.92	12.17	27.31	24.23	44.01	74.00	V
9764.000	37.91	14.49	27.13	33.52	58.79	74.00	V
4882.000	34.33	9.59	27.60	35.33	51.65	74.00	H
7323.000	34.92	12.17	27.31	36.31	56.09	74.00	H
9764.000	37.91	14.49	27.13	35.52	60.79	74.00	H

**Average Measurement:**

Frequency (MHz)	Antenna factors (dB/m)	Cable loss (dB)	Preamp factor (dB)	Reading Level (dB $\mu$ V)	Emission Level (dB $\mu$ V/m)	Limit (dB $\mu$ V/m)	Antenna polarization
4882.000	34.33	9.59	27.60	22.23	38.55	54.00	V
7323.000	34.92	12.17	27.31	23.47	43.25	54.00	V
9764.000	37.91	14.49	27.13	23.37	48.64	54.00	V
4882.000	34.33	9.59	27.60	22.19	38.51	54.00	H
7323.000	34.92	12.17	27.31	24.02	43.80	54.00	H
9764.000	37.91	14.49	27.13	22.75	48.02	54.00	H

**Test at high Channel in transmitting status**

9kHz~30MHz Test result

The Low frequency, which started from 9kHz to 30MHz, was pre-scanned and the result which was 20dB lower than the limit line per 15.31(o) was not report

30 MHz~1 GHz Spurious Emissions .Quasi-Peak Measurement

Horizontal:

Peak scan

Level (dBμV/m)

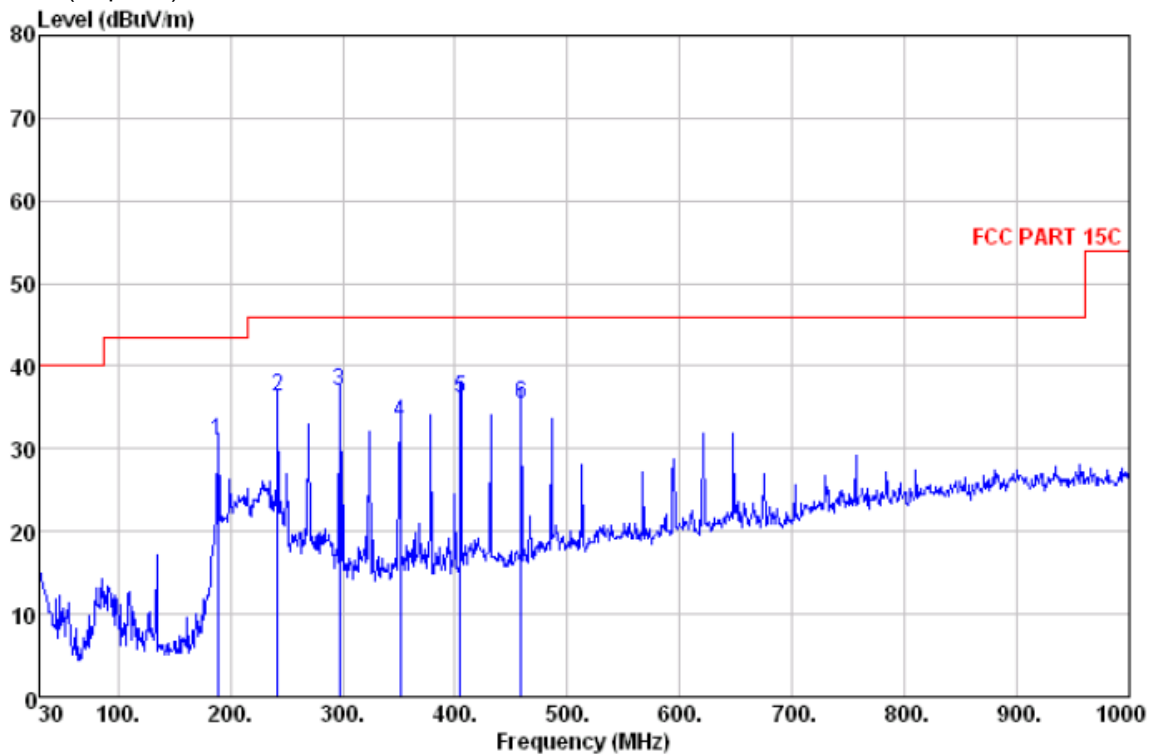

Quasi-peak measurement

No.	Freq MHz	Read Level dBuV	Antenna Factor dB	Cable Loss dB	Preamp Factor dB	Level dBuV/m	Limit Line dBuV/m	Over Limit dB	Pol/Phase	Remark
1	189.080	48.10	8.73	1.66	27.62	30.87	43.50	-12.63	HORIZONTAL	QP
2	242.430	50.70	10.84	1.90	27.22	36.22	46.00	-9.78	HORIZONTAL	QP
3	296.750	48.83	13.53	2.11	27.57	36.90	46.00	-9.10	HORIZONTAL	QP
4	351.070	44.54	13.75	2.28	27.35	33.22	46.00	-12.78	HORIZONTAL	QP
5	404.420	45.97	15.84	2.47	28.18	36.10	46.00	-9.90	HORIZONTAL	QP
6	458.740	44.26	16.95	2.65	28.53	35.33	46.00	-10.67	HORIZONTAL	QP

**Level=Read Level + Antenna Factor + Cable Loss - Preamp Factor**

**Test at High Channel in transmitting status**

30 MHz~1 GHz Spurious Emissions .Quasi-Peak Measurement

**Vertical:**

Peak scan

Level (dBμV/m)

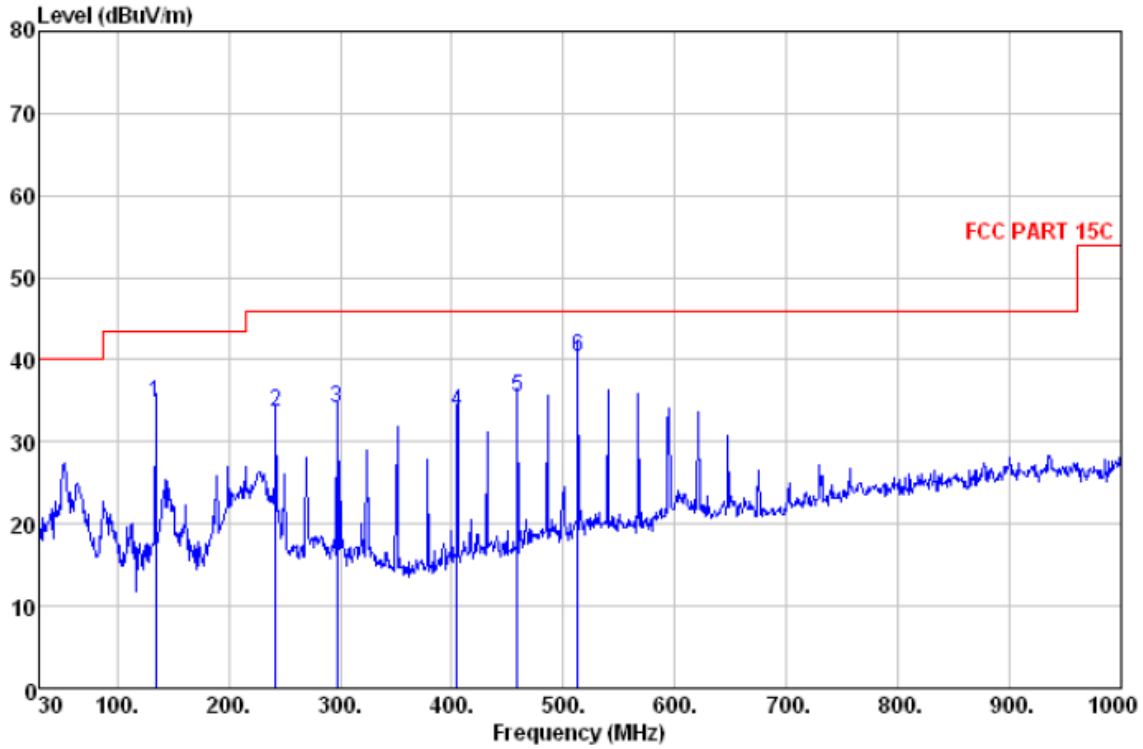

Quasi-peak measurement

No.	Freq MHz	Read Level dBuV	Antenna Factor dB	Cable Loss dB	Preamp Factor dB	Level dBuV/m	Limit Line dBuV/m	Over Limit dB	Pol/Phase	Remark
1	134.760	54.37	7.40	1.38	28.30	34.85	43.50	-8.65	VERTICAL	QP
2	242.430	48.10	10.84	1.90	27.22	33.62	46.00	-12.38	VERTICAL	QP
3	296.750	45.99	13.53	2.11	27.57	34.06	46.00	-11.94	VERTICAL	QP
4	404.420	43.48	15.84	2.47	28.18	33.61	46.00	-12.39	VERTICAL	QP
5	458.740	44.40	16.95	2.65	28.53	35.47	46.00	-10.53	VERTICAL	QP
6	513.060	47.83	18.38	2.81	28.69	40.33	46.00	-5.67	VERTICAL	QP

**Level=Read Level + Antenna Factor + Cable Loss - Preamp Factor**

## 1~25 GHz Harmonics &amp; Spurious Emissions. Peak &amp; Average Measurement

**Peak Measurement:**

Frequency (MHz)	Antenna factors (dB/m)	Cable loss (dB)	Preamp factor (dB)	Reading Level (dB $\mu$ V)	Emission Level (dB $\mu$ V/m)	Limit (dB $\mu$ V/m)	Antenna polarization
4960.000	34.36	9.60	27.61	34.64	50.99	74.00	V
7440.000	34.98	12.19	27.30	35.22	55.09	74.00	V
9920.000	37.96	14.52	27.11	34.16	59.53	74.00	V
4960.000	34.36	9.60	27.61	35.45	51.80	74.00	H
7440.000	34.98	12.19	27.30	35.41	55.28	74.00	H
9920.000	37.96	14.52	27.11	34.15	59.52	74.00	H

**Average Measurement:**

Frequency (MHz)	Antenna factors (dB/m)	Cable loss (dB)	Preamp factor (dB)	Reading Level (dB $\mu$ V)	Emission Level (dB $\mu$ V/m)	Limit (dB $\mu$ V/m)	Antenna polarization
4960.000	34.36	9.60	27.61	22.22	38.57	54.00	V
7440.000	34.98	12.19	27.30	23.15	43.02	54.00	V
9920.000	37.96	14.52	27.11	22.90	48.27	54.00	V
4960.000	34.36	9.60	27.61	23.67	40.02	54.00	H
7440.000	34.98	12.19	27.30	22.86	42.73	54.00	H
9920.000	37.96	14.52	27.11	23.54	48.91	54.00	H

## Remark:

- 1). The field strength is calculated by adding the Antenna Factor. Cable Factor & Pre-amplifier. The basic equation with a sample calculation is as follows:

Final Test Level = Receiver Reading + Antenna Factor + Cable Loss – Pre-amplifier Factor.

- 2). As shown in Section, for frequencies above 1000 MHz. the above field strength limits are based on average limits. However, the peak field strength of any emission shall not exceed the maximum permitted average limits specified above by more than 20 dB under any condition of modulation.
- 3). The test only perform the EUT in transmitting status since the test frequencies were over 1GHz only required transmitting status.

**Test result: The unit does meet the FCC requirements.**



## 5.10 Radiated Emissions which fall in the restricted bands

**Test Requirement:** FCC Part15 C Section 15.247

(d) In addition, radiated emissions which fall in the restricted bands. as defined in Section 15.205(a), must also comply with the radiated emission limits specified in Section 15.209(a) (see Section 15.205(c)).

**Test Method:** ANSI C63.10:2013 Clause 6.4, 6.5 and 6.6

**Test Status:** Pre-test the EUT in continuous transmitting mode at the lowest (2402 MHz), middle (2441 MHz) and highest (2480 MHz) channel with different data packet. Compliance test in continuous transmitting mode with normal mode (DH5) as the worst case was found.

**Measurement Distance:** 3m (Semi-Anechoic Chamber)

**Limit:** Section 15.209(a)

Frequency (MHz)	Field Strength (microvolts/meter)	Measurement Distance (meters)
0.009 - 0.490	2400/F(kHz)	300
0.490 - 1.705	24000/F(kHz)	30
1.705 - 30.0	30	30
30 - 88	100	3
88 - 216	150	3
216 - 960	200	3
Above 960	500	3

**Detector:** For PK value:

RBW = 1 MHz for  $f \geq 1$  GHz, 100 kHz for  $f < 1$  GHz

VBW  $\geq$  RBW

Sweep = auto

Detector function = peak

Trace = max hold

For AV value:

RBW = 1 MHz for  $f \geq 1$  GHz, 100 kHz for  $f < 1$  GHz

VBW = 10 Hz

Sweep = auto

Detector function = peak

Trace = max hold

## Test Result:

## For Bluetooth

## 1. Low Channel (2402MHz)

Antenna polarization: Vertical

Frequency (MHz)	Antenna factors (dB/m)	Cable loss(dB)	Preamp factor(dB)	Peak Reading Level (dB $\mu$ V)	Average Reading Level (dB $\mu$ V)	Peak Emission Level (dB $\mu$ V/m)	Average Emission Level (dB $\mu$ V/m)
2310.000	26.65	6.45	27.78	34.24	22.33	39.56	27.65
2390.000	26.56	6.46	27.79	35.22	23.47	40.45	28.70
2500.000	25.70	6.62	27.80	34.76	23.63	39.28	28.15
2483.500	25.79	6.61	27.80	34.48	22.33	39.08	26.93

Antenna polarization: Horizontal

Frequency (MHz)	Antenna factors (dB/m)	Cable loss(dB)	Preamp factor(dB)	Peak Reading Level (dB $\mu$ V)	Average Reading Level (dB $\mu$ V)	Peak Emission Level (dB $\mu$ V/m)	Average Emission Level (dB $\mu$ V/m)
2310.000	26.65	6.45	27.78	33.55	23.65	38.87	28.97
2390.000	26.56	6.46	27.79	34.27	22.33	39.50	27.56
2500.000	25.70	6.62	27.80	34.17	24.73	38.69	29.25
2483.500	25.79	6.61	27.80	35.44	24.11	40.04	28.71

## 2. Middle Channel (2441MHz)

Antenna polarization: Vertical

Frequency (MHz)	Antenna factors (dB/m)	Cable loss(dB)	Preamp factor(dB)	Peak Reading Level (dB $\mu$ V)	Average Reading Level (dB $\mu$ V)	Peak Emission Level (dB $\mu$ V/m)	Average Emission Level (dB $\mu$ V/m)
2310.000	26.65	6.45	27.78	33.23	23.43	38.55	28.75
2390.000	26.56	6.46	27.79	34.42	22.44	39.65	27.67
2500.000	25.70	6.62	27.80	34.55	23.65	39.07	28.17
2483.500	25.79	6.61	27.80	35.12	23.22	39.72	27.82

Antenna polarization: Horizontal

Frequency (MHz)	Antenna factors (dB/m)	Cable loss(dB)	Preamp factor(dB)	Peak Reading Level (dB $\mu$ V)	Average Reading Level (dB $\mu$ V)	Peak Emission Level (dB $\mu$ V/m)	Average Emission Level (dB $\mu$ V/m)
2310.000	26.65	6.45	27.78	33.23	22.98	38.55	28.30
2390.000	26.56	6.46	27.79	34.98	23.41	40.21	28.64
2500.000	25.70	6.62	27.80	35.08	24.09	39.60	28.61
2483.500	25.79	6.61	27.80	35.01	23.89	39.61	28.49

**3. High Channel (2480MHz)**

Antenna polarization: Vertical

Frequency (MHz)	Antenna factors (dB/m)	Cable loss(dB)	Preamp factor(dB)	Peak Reading Level (dB $\mu$ V)	Average Reading Level (dB $\mu$ V)	Peak Emission Level (dB $\mu$ V/m)	Average Emission Level (dB $\mu$ V/m)
2310.000	26.65	6.45	27.78	34.11	23.34	39.43	28.66
2390.000	26.56	6.46	27.79	33.45	22.21	38.68	27.44
2500.000	25.70	6.62	27.80	34.51	23.55	39.03	28.07
2483.500	25.79	6.61	27.80	35.22	24.91	39.82	29.51

Antenna polarization: Horizontal

Frequency (MHz)	Antenna factors (dB/m)	Cable loss(dB)	Preamp factor(dB)	Peak Reading Level (dB $\mu$ V)	Average Reading Level (dB $\mu$ V)	Peak Emission Level (dB $\mu$ V/m)	Average Emission Level (dB $\mu$ V/m)
2310.000	26.65	6.45	27.78	34.21	23.23	39.53	28.55
2390.000	26.56	6.46	27.79	34.32	24.66	39.55	29.89
2500.000	25.70	6.62	27.80	35.61	25.15	40.13	29.67
2483.500	25.79	6.61	27.80	35.26	24.24	39.86	28.84

Remark: No any other emission which falls in restricted bands can be detected and be reported.

**Test result: The unit does meet the FCC requirements.**

## 5.11 Band Edges Requirement

**Test Requirement:** FCC Part15 C section 15.247

(d) In any 100 kHz bandwidth outside the frequency band in which the spread spectrum or digitally modulated intentional radiator is operating, the radio frequency power that is produced by the intentional radiator shall be at least 20 dB below that in the 100 kHz bandwidth within the band that contains the highest level of the desired power, based on either an RF conducted or a radiated measurement, provided the transmitter demonstrates compliance with the peak conducted power limits. If the transmitter complies with the conducted power limits based on the use of RMS averaging over a time interval, as permitted under paragraph (b)(3) of this section, the attenuation required under this paragraph shall be 30 dB instead of 20 dB. Attenuation below the general limits specified in Section 15.209(a) is not required. In addition, radiated emissions which fall in the restricted bands, as defined in Section 15.205(a), must also comply with the radiated emission limits specified in Section 15.209(a) (see Section 15.205(c)).

**Frequency Band:** 2400 MHz to 2483.5 MHz

**Test Method:** ANSI C63.10:2013 Clause 6.9

**Test Status:** Pre-test the EUT in continuous transmitting mode at the lowest (2402 MHz), and highest (2480 MHz) channel and hopping mode with different data packet. Compliance test in continuous transmitting mode with normal (DH5) EDR mode (2DH5) and EDR mode (3DH5) as the worst case was found.

**Test Configuration:**

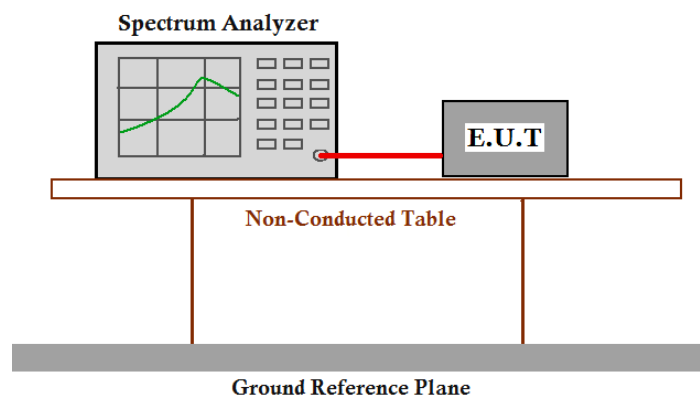

**Test Procedure:**

Set RBW of spectrum analyzer to 100 kHz and VBW of spectrum analyzer to 300 kHz with suitable frequency span including 10MHz bandwidth from band edge.

The band edges was measured and recorded Result:

The Lower Edges attenuated more than 20dB.

The Upper Edges attenuated more than 20dB.

The graph as below. Represents the emissions take for this device.

For Bluetooth

DH5:

Low channel:



High channel:



2DH5:  
Low channel:



High channel:



3DH5:  
Low channel:



High channel:



DH5:

Low channel:

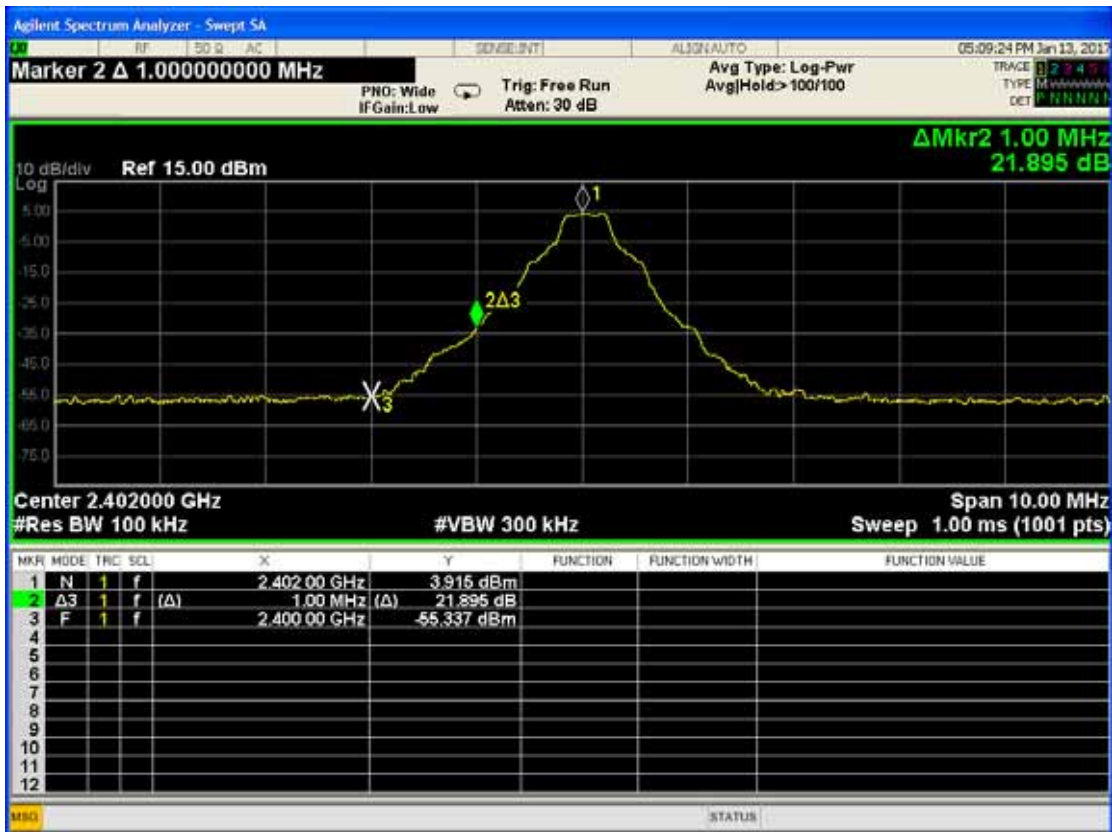

High channel:





2DH5:

Low channel:



High channel:

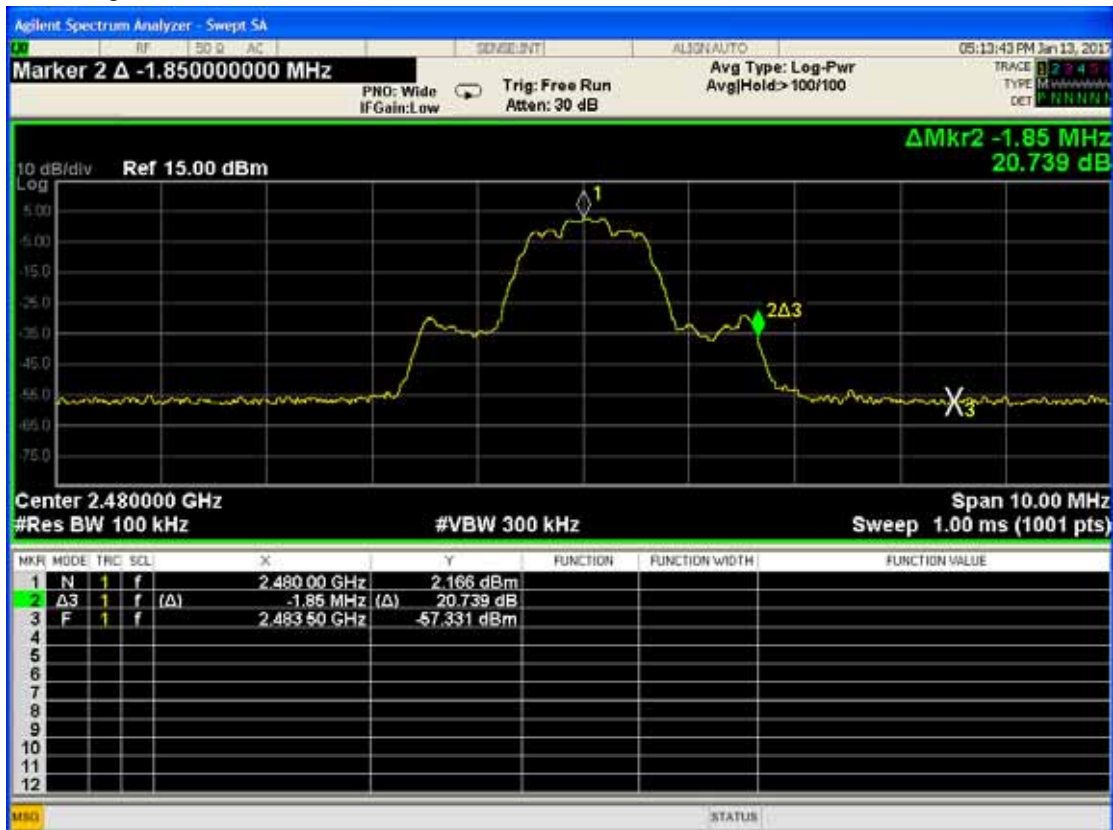

3DH5:

Low channel:



High channel:

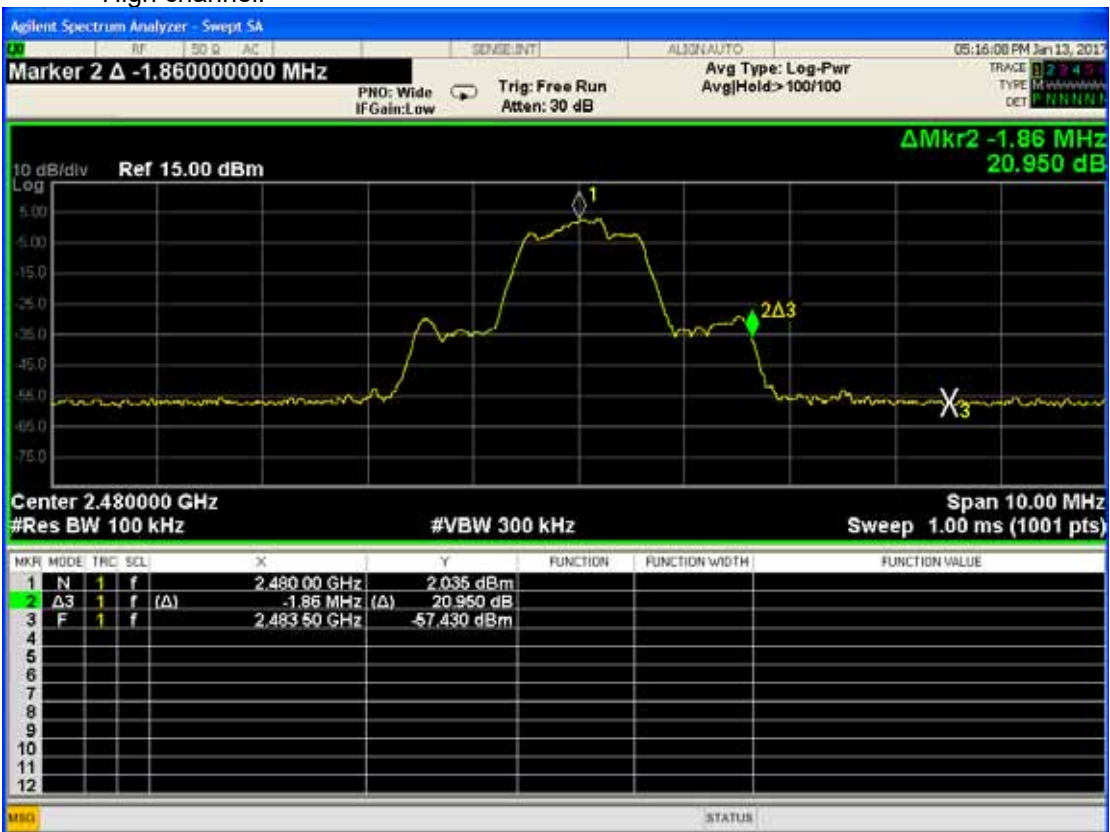

**Test result: The unit does meet the FCC requirements.**

## 5.12 Conducted Emissions at Mains Terminals 150 kHz to 30 MHz

**Test Requirement:** FCC Part 15 C section 15.207

**Test Method:** ANSI C63.10:2013 Clause 6.2

**Test Voltage:** 120V AC, 60Hz

**Frequency Range:** 150 kHz to 30 MHz

**Detector:** Peak for pre-scan (9 kHz Resolution Bandwidth)

### Test Limit

#### Limits for conducted disturbance at the mains ports of class B

Frequency Range	Class B Limit dB( $\mu$ V)	
	Quasi-peak	Average
0.15 to 0.50	66 to 56	56 to 46
0.50 to 5	56	46
5 to 30	60	50

NOTE 1 The limit decreases linearly with the logarithm of the frequency in the range 0,15 MHz to 0,50 MHz.

### EUT Operation:

Test in normal operating mode. For intentional radiators, measurements of the variation of the input power or the radiated signal level of the fundamental frequency component of the emission, as appropriate, shall be performed with the supply voltage varied between 85% and 115% of the nominal rated supply voltage.

Pre-Scan has been conducted to determine the worst-case mode from all possible combinations between available modulations, data rates and antenna ports (if EUT with antenna diversity architecture).

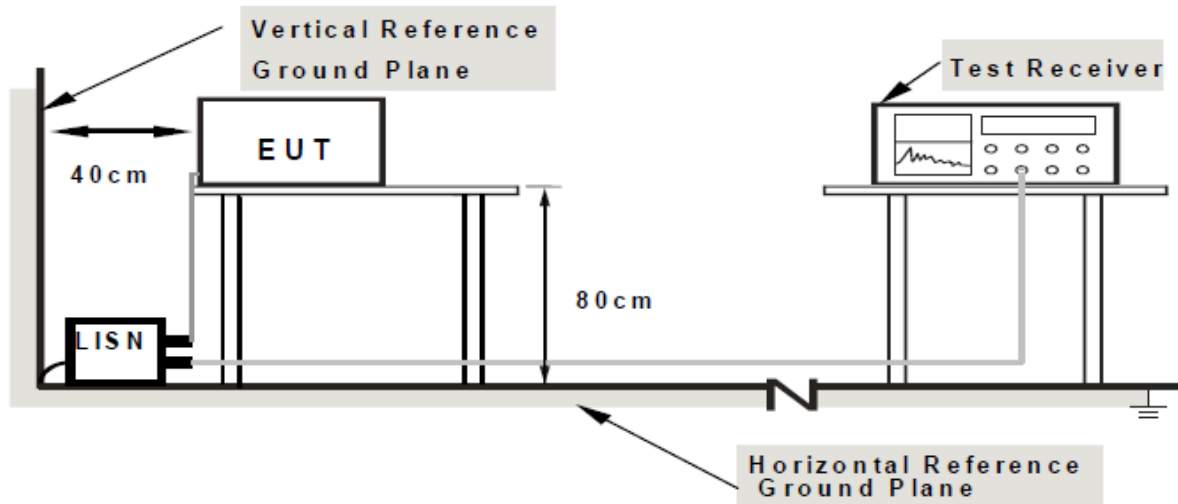
**Test Configuration:**

**Note: 1.**Support units were connected to second LISN .

**2.**Both of LISNs (AMN) are 80 cm from EUT and at least 80 from other units and other metal planes

**Test procedure:**

1. The mains terminal disturbance voltage test was conducted in a shielded room.
2. The tabletop EUT was placed upon a non-metallic table 0.8m above the ground reference plane. And for floor-standing arrangement, the EUT was placed on the horizontal ground reference plane, but separated from metallic contact with the ground reference plane by 0.1m of insulation.

### 5.12.1 Measurement Data

An initial pre-scan was performed on the live and neutral lines with peak detector. Quasi-Peak and Average measurement were performed at the frequencies with maximized peak emission were detected. For EUT the communicating was worst case mode.

The following Quasi-Peak and Average measurements were performed on the EUT Live line

Peak Scan:

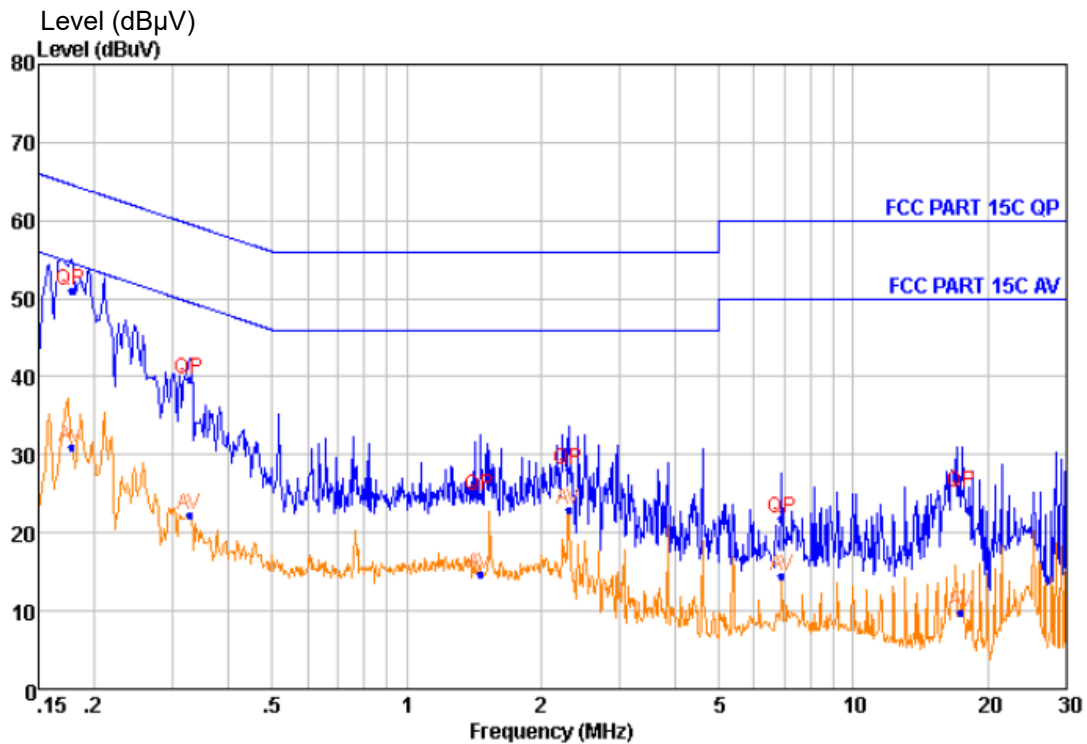

Quasi-peak and Average measurement

NO.	Freq MHz	Level dBuV	Remark	LISN Factor dB	Cable Loss dB	Limit Line dBuV	Margin dB
1	0.177	51.00	QP	9.47	0.21	64.61	-13.61
2	0.178	30.96	Average	9.47	0.21	54.59	-23.63
3	0.326	39.74	QP	9.43	0.24	59.55	-19.81
4	0.326	22.36	Average	9.43	0.24	49.55	-27.19
5	1.461	24.75	QP	9.30	0.33	56.00	-31.25
6	1.461	14.73	Average	9.30	0.33	46.00	-31.27
7	2.303	28.06	QP	9.32	0.35	56.00	-27.94
8	2.303	22.95	Average	9.32	0.35	46.00	-23.05
9	6.899	21.87	QP	9.30	0.42	60.00	-38.13
10	6.899	14.44	Average	9.30	0.42	50.00	-35.56
11	17.435	25.07	QP	9.57	0.47	60.00	-34.93
12	17.435	9.84	Average	9.57	0.47	50.00	-40.16

**Neutral Line**

Peak Scan:

Level (dBμV)

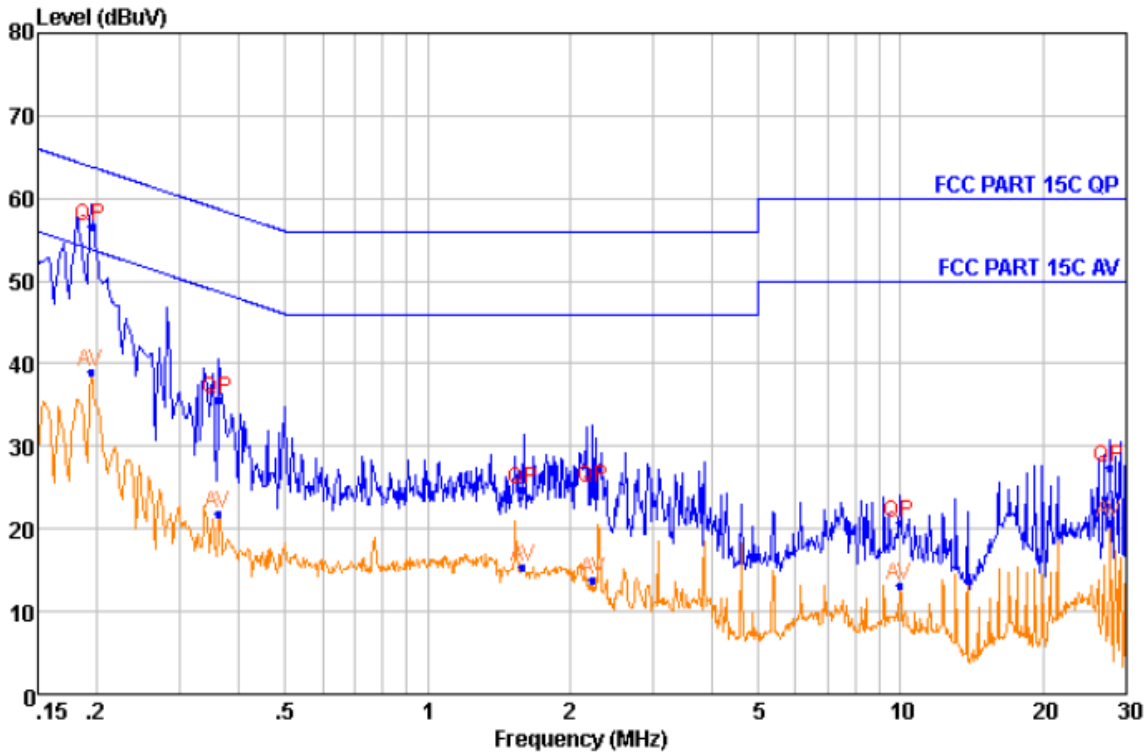

Quasi-peak and Average measurement

NO.	Freq MHz	Level dBμV	Remark	LISN Factor dB	Cable Loss dB	Limit Line dBμV	Margin dB
1	0.194	56.64	QP	9.37	0.21	63.86	-7.22
2	0.194	38.90	Average	9.37	0.21	53.84	-14.94
3	0.361	35.71	QP	9.36	0.25	58.71	-23.00
4	0.361	21.83	Average	9.36	0.25	48.71	-26.88
5	1.591	24.73	QP	9.38	0.33	56.00	-31.27
6	1.591	15.40	Average	9.38	0.33	46.00	-30.60
7	2.232	25.00	QP	9.39	0.35	56.00	-31.00
8	2.232	13.86	Average	9.39	0.35	46.00	-32.14
9	9.946	20.81	QP	9.54	0.44	60.00	-39.19
10	9.946	13.18	Average	9.54	0.44	50.00	-36.82
11	27.644	27.50	QP	9.88	0.50	60.00	-32.50
12	27.644	20.82	Average	9.88	0.50	50.00	-29.18

--End of Report--