

ESB205 INSTRUCTION MANUAL

2.1 Sound Bar System (wired)

 **element**

CONTENTS

INFORMATION ON SAFETY	2-3
PREPARATORY WORK	4
UNPACKING	
INSTALLATION	5
INSTALLATION STEPS	
PREPARATIONS FOR START	6-8
FUNCTION	
TOP PANEL FUNCTION	6
BACK PANEL FUNCTION	7
REMOTE CONTROL FUNCTION	7
SUBWOOFER FUNCTION	8
CONNECTION	9-10
SPECIFICATIONS	11
TROUBLESHOOTING	12
ONE-YEAR LIMITED WARRANTY	13

1. Read these instructions.
2. Keep these instructions.
3. Heed all warnings.
4. Follow all instructions.
5. Do not use this apparatus near water.
6. Clean only with dry cloth.
7. Do not block any ventilation openings, install in accordance with the manufacturer's instructions.
8. Do not install near any heat sources such as radiators, heat registers, stoves, or other apparatus (including amplifiers) that produce heat.
9. Do not defeat the safety purpose of the polarized. A polarized plug has two blades with one wider than the other.
10. Protect the power cord from being walked on or pinched particularly at plugs, convenience receptacles, and the point where they exit from the apparatus.
11. Only use attachments/accessories specified by the manufacturer.
12. Use only with the cart, stand, tripod, bracket, or table specified by the manufacturer, or sold with the apparatus. When a cart is used, use caution when moving the cart/apparatus combination to avoid injury from tip-over.



13. Unplug this apparatus during lightning storms or when unused for long periods of time.
14. Refer all servicing to qualified service personal. Servicing is required when the apparatus has been damaged in any way, such as power-supply cord or plug is damaged, liquid has been spilled or objects have fallen into the apparatus, the apparatus has been exposed to rain or moisture, does not operate normally, or has been dropped.

SAVE THESE INSTRUCTIONS.

To reduce the risk of fire or electric shock, do not expose this apparatus to rain or moisture.

When the mains plug or an appliance coupler is used as the disconnect device, the disconnect device shall remain readily operable.

These servicing instructions are for use by qualified service person only. To reduce the risk of electric shock do not perform any servicing other than that contained in the operating instructions unless you are qualified to do so.



**RISK OF ELECTRIC SHOCK,
DO NOT OPEN**



**WARNING : SHOCK HAZARD-DO NOT OPEN
A V I S : RISQUE DE CHOC ÉLECTRIQUE
-NE PAS OUVRIR**

**CAUTION:DISCONNECT SUPPLY CORD
BEFORE REPLACING FUSE,REPLACE
WITH SAME TYPE FUSE**

**ATTENTION:DÉBRANCHER AVANT DE
REPLACER LE FUSIBLE,UTILISER UN
FUSIBLE DE RECHANGE DE MÊME TYPE**



This symbol is to alert the user to the presence of uninsulated dangerous voltages inside the product's enclosure that may constitute a risk of electric shock.



This symbol is to alert the user to important operating and maintenance (service) instructions in this manual and literature accompanying the product.

**WARNING DO NOT INGEST
BATTERY, CHEMICAL BURN
HAZARD.**

This product contains a coin/button battery. If the coin/button cell battery is swallowed. It can cause internal injuries in just 2 hours and can lead to death.

Keep new and used batteries away from children, if the battery compartment does not close securely. Stop using the product and keep it away from children.

If you think batteries might have been swallowed or placed inside any part of the body. Seek immediate medical attention.

INFORMATION ON SAFETY

SERVICE

To reduce the risk of electric, do not remove screws. The unit does not contain any user serviceable parts. Please leave all maintenance work to qualified personnel. Do not open any fixed covers as this may expose dangerous voltages.

MAINTENANCE

Ensure to unplug the unit from the power supply before cleaning. Do not use any type of abrasive pad or abrasive cleaning solutions as these may damage the unit's surface. Do not use liquids to clean the unit.

FOR PRODUCTS THAT TRANSMIT RF ENERGY : FCC AND IC STATEMENT FOR USERS (USA AND CANADA ONLY)

This device complies with Part 15 of the FCC Rules. Operation is subject to the following two conditions:
(1) This device may not cause harmful interference, and (2) this device must accept any interference received, including interference that may cause undesired operation.

FEDERAL COMMUNICATION COMMISSION INTERFERENCE STATEMENT

This equipment has been tested and found to comply with the limits for a Class B digital device, pursuant to Part 15 of the FCC Rules. These limits are designed to provide reasonable protection against harmful interference in a residential installation. This equipment generates, uses and can radiate radio frequency energy and, if not installed and used in accordance with the instructions, may cause harmful interference to radio communications. However, there is no guarantee that interference will not occur in a particular installation. If this equipment does cause harmful interference to radio or television reception, which can be determined by turning the equipment off and on, the user is encouraged to try to correct the interference by one or more of the following measures:

- Reorient or relocate the receiving antenna.
- Increase the separation between the equipment and receiver.
- Connect the equipment into an outlet on a circuit different from that to which the receiver is connected.
- Consult the dealer or an experienced radio/TV technician for help.

Changes or modifications not expressly approved by the party responsible for compliance could void the user's authority to operate the equipment.



BONGIOVI DPS TECHNOLOGY

Bongiovi DPS is a patented algorithm that re-masters audio in real time. Below are a few examples of how Bongiovi DPS can work for you:

- Maximize the sound of speaker systems
- Provide cleaner, deeper bass response
- Automatic sound mixing/mastering
- Increase clarity in high noise environments
- Restores lost sound from compressed audio formats

Unpacking

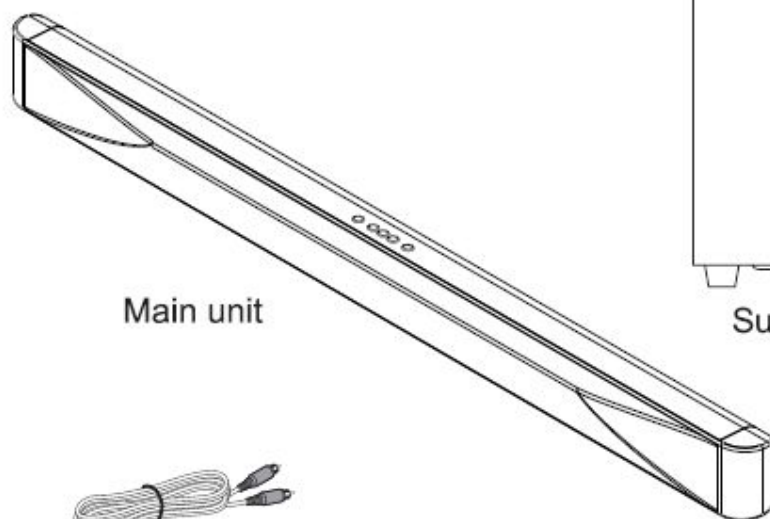

Main unit

Subwoofer

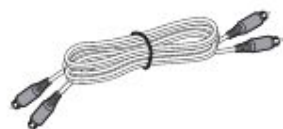

RCA Cable X1

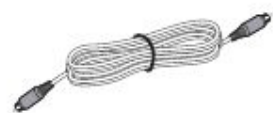

Subwoofer RCA Cable X1



Mains Cable X2

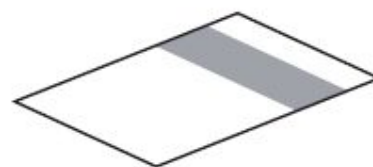

Instruction Manual X1



Cover X2



Screw X2

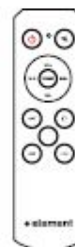

Remote Control X1

INSTALLATION STEPS

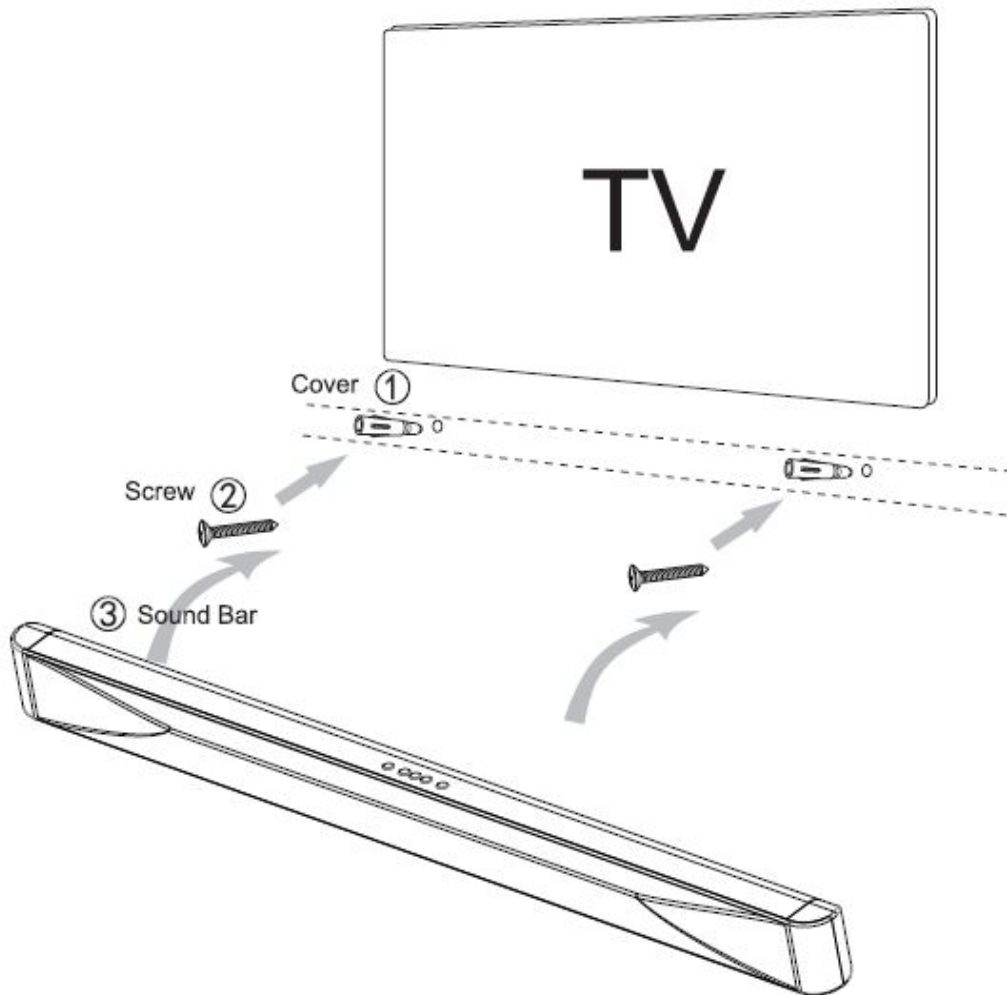

WALL MOUNTING

The Sound Bar can either be kept on the stand or mounted on the wall. If you choose to mount the Sound Bar on the wall, follow the instructions below for removing the stand.

1. Connect Audio Cables to the Sound Bar.
2. Connect the power cord to the power cord connector on the back of the Sound Bar.
3. Drill 2 holes on the wall, the hole size is the same as the cover.
4. Push the cover into the hole and lock screws.
5. Mount the Sound Bar on it.

TOP PANEL FUNCTION

TOP PANEL

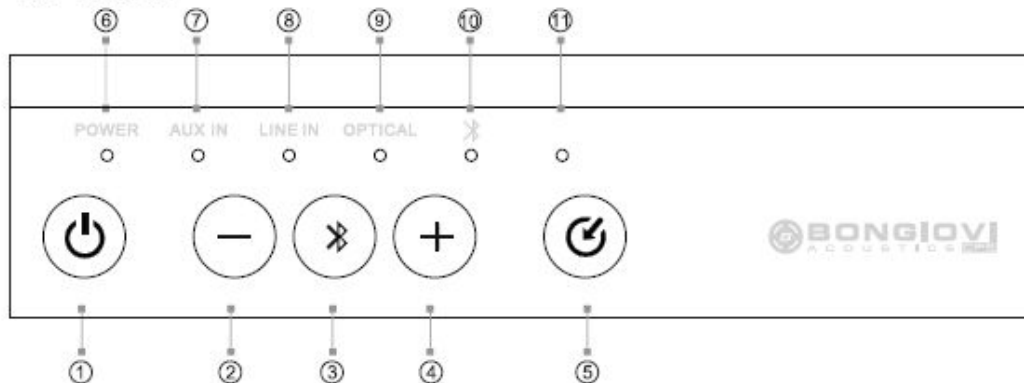

TOP PANEL BUTTONS

- ① **POWER BUTTON**
Press to turn Sound Bar on or off. The indicator light is orange in the standby mode, and it will turn off when the system is on.
Note: If the channel has no input signal or any operation in 15 minutes, the device will automatically go into the Standby mode.
- ② **- VOL- BUTTON**
- ③ **BLUETOOTH**
Bluetooth button. If the device is not in bluetooth mode, press this button to force the device into bluetooth mode; if connected, it will disconnect immediately and enter into the pairing mode when you press the button.
- ④ **+ VOL+ BUTTON**
- ⑤ **SOURCE BUTTON**
Select the input source. The active source Indicator LED will illuminate or flash (flash only applies to bluetooth non-activate status).

INDICATOR

- ⑥ **POWER:** The power indicator is always on in the standby mode, and it will turn off when the system is on.
- ⑦ **AUX IN:** AUX IN indicator, in aux input this light will illuminate.
- ⑧ **LINE IN:** LINE IN indicator, in line in input this light will illuminate.
- ⑨ **OPTICAL:** OPTICAL indicator, in optical input this light will illuminate.
- ⑩ **BLUETOOTH:** BLUETOOTH indicator, in bluetooth input this light is on if the device is connected; if it is unconnected, the light will flash.

VOLUME INDICATORS: 7 to 11 indicators light as you adjust the Sound Bar volume levels. The volume has 32 level settings, when it's maximum, these five indicators will light on together for a while; when it's minimum, the AUX IN indicator will illuminate for a while. These indicators will illuminate according to the volume levels.

PREPARATIONS FOR START

BACK PANEL FUNCTION

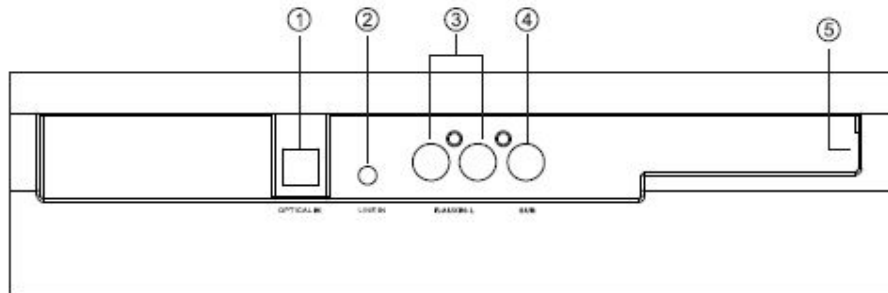

- ① OPTICAL IN: Optical connector for connection from a device such as a home theater system, amplifier, receiver, set top box, or DVD player.
- ② LINE IN: Connect the LINE IN audio from cell phone or other device.
- ③ AUX IN: Connect the analog audio from a device such as a TV, set top box, DVD player, or gaming system.
- ④ SUBWOOFER OUT: Connect the sound bar and subwoofer with RCA cable(including).
- ⑤ POWER CONNECTOR: Plug the power wire here.

REMOTE CONTROL FUNCTION

- ①  **POWER BUTTON:** Press to turn Sound Bar on or off.
NOTE: If the channel has no input signal or any operation in 15 minutes, the device will automatically go into the Standby mode.
- ② **MUTE:** Press to turn the sound on and off.
- ③ Press the "+" button to increase the volume.
- ④ Press the "-" button to decrease the volume.
- ⑤ Press the "SUB+" button to increase the subwoofer volume.
- ⑥ Press the "SUB-" button to decrease the subwoofer volume.
- ⑦ Preset the factory settings, the volume is 50%.
- ⑧ **OPTICAL BUTTON:** If the device is not in optical mode, press this button to switch to OPTICAL IN mode.
- ⑨ **BLUETOOTH BUTTON:** If the device is not in Bluetooth mode, press this button to switch to Bluetooth mode.
- ⑩ **AUX IN BUTTON:** If the device is not in AUX IN mode, press this button to switch to AUX IN mode.
- ⑪ **LINE IN BUTTON:** If the device is not in LINE IN mode, press this button to switch to LINE IN mode.

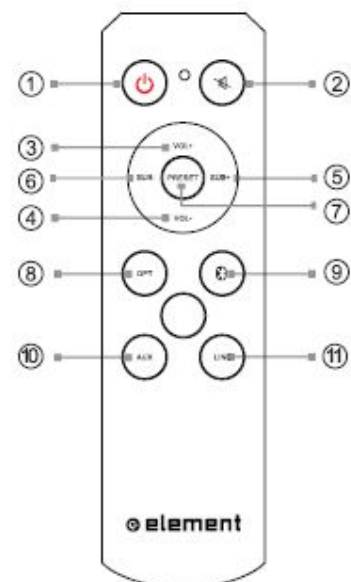

SUBWOOFER CONNECTION

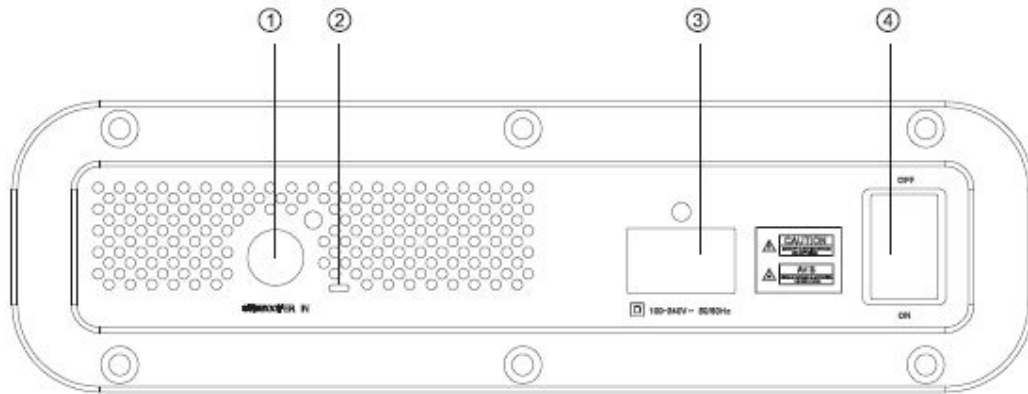

- ① **SUBWOOFER IN:**
Connect the sound bar and subwoofer with RCA cable(including).
- ② **INDICATOR**
- ③ **POWER CONNECTOR:**
Plug the connector from the AC/DC Power Adapter here.
- ④ **POWER SWITCH ON/OFF**

Note : The indicator is on when the power switch is on. The indicator keeps on lighting when there is audio input signal, and it will flash without input signal.

Choose one cable **GOOD** or **BETTER**

Use an optical cable to connect TV

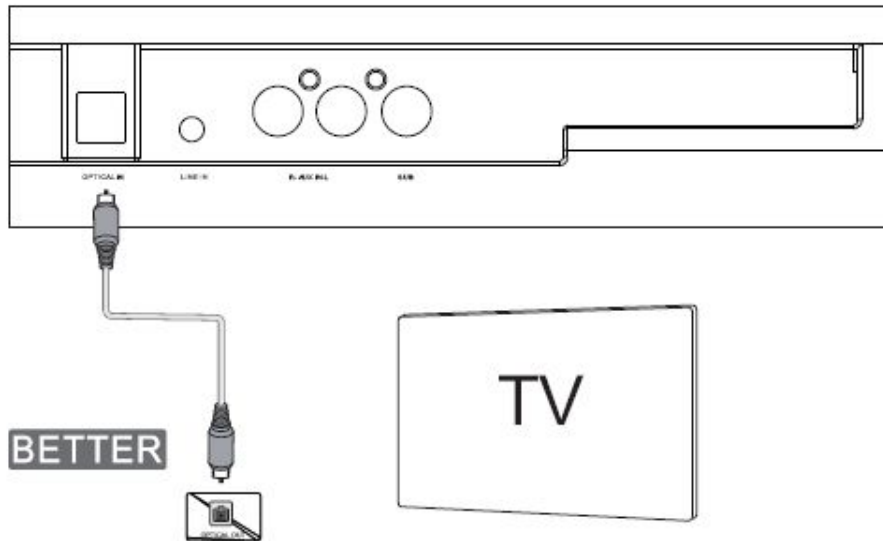

Use a RCA cable to connect other device

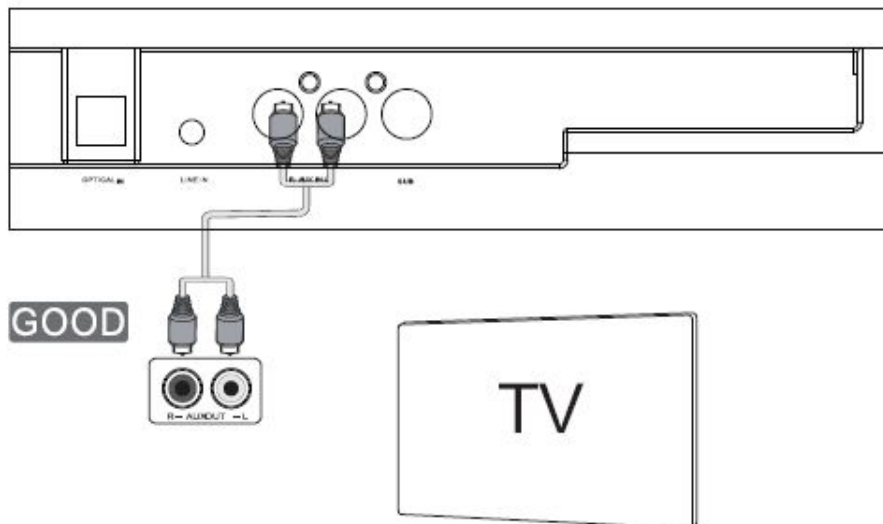

CONNECTION

Use a 3.5mm audio cable to connect other device

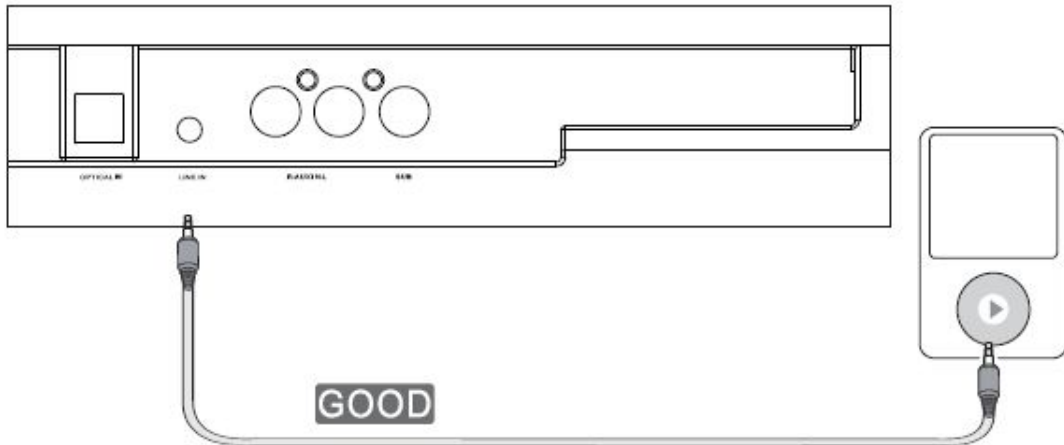

Use a subwoofer RCA cable to connect the sound bar and subwoofer

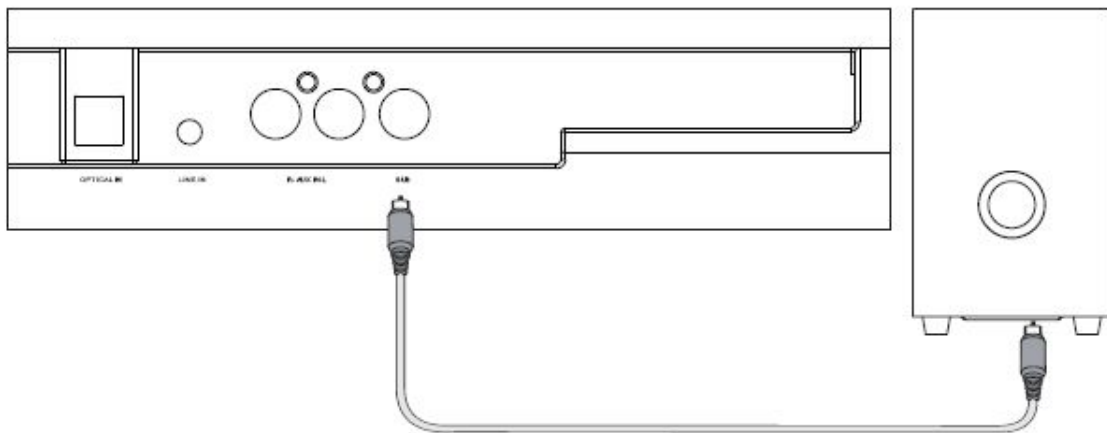

SPECIFICATIONS

ELECTRONIC

- Nominal output power:
 - Left channel ----- 15W
 - Right channel ----- 15W
 - Subwoofer ----- 30W
- Input sensibility ----- 300mV±50mV
- Nominal load impedance
 - Left channel ----- 8Ω
 - Right channel ----- 8Ω
 - Subwoofer ----- 4Ω
- Overload source moving force ----- ≥2V
- Harmonic distortion (rate condition) 1KHz ----- ≤1%
- Frequency response ----- 50Hz~20KHz
- S/N (A weighted)
 - Sound bar ----- FL, FR ≥70dB
 - Subwoofer ----- ≥65dB
- Separation (normal working condition, 1KHz) ----- ≥40dB

SPEAKER

- Frequency response ----- 50Hz~20KHz (-10dB)
- Speakers
 - Full-range speakers ----- 2.75"X 2
 - Tweeter ----- 1"X 2
 - Woofers ----- 5"X 1

DIGITAL AUDIO

- Sampling rate ----- 44.1KHz, 48KHz
- Digital input levels
 - Optical ----- -10.5±1dBFS

POWER SOURCE

- Power supply ----- AC100-240V
- Frequency ----- 50-60Hz
- Normal working power ----- ≤40W
- Nominal working power ----- ≤90W

GENERAL

- Net weight ----- 12.24Lbs
- Dimensions(L*W*H)
 - Sound bar ----- 39.37" X 2.56" X 3.35"
 - Subwoofer ----- 8.86" X 8.35" X 12.99"

TROUBLESHOOTING

If any trouble is encountered, first refer to the chart below. If the problem still exists, please turn off the device and consult the local dealer or service station for repairing.

When the device is attacked by electric shock (e.g. lightning or static), or improper operation, this unit may not work properly. Unplug the unit from the mains socket, then plug and turn it on again after 30 seconds.

Problem	Reason	Solution
When press the POWER SWITCH, the device is not on.	Power plug is not plugged in.	Make sure the power plug is plugged in firmly.
No sound in one or more channels.	Incorrect input source.	Choose the correct input source.
This device is not working properly.	May infect by strong external noise(Such as lightning, excessive static, etc.) or improper operation.	Switch the device off, unplug the unit from the mains socket, then plug and turn it on again after 30 seconds.
Sound disappeared suddenly.	Because of short circuit, circuit protects itself automatically.	Switch the device off, eliminate the trouble of short-circuit faults then switch on again.
Some speakers are silent.	Input audio cables are connected incorrectly.	Connect the cables correctly.
	Audio cable is damaged.	Change a new audio cable.
The remote control does not function.	The power of battery is too low.	Replace the battery in the remote control with a new one.
	There is a big obstacle between the remote control and the device.	Remove any obstacles.
	Inappropriate distance or angle.	The remote control sensor at the front device is sensitive to the remote control's commands up to a maximum of 5 meters and within a maximum of a 30° arc.
	Sunlight or lighting (inverted fluorescent lamps, etc.) shines on the remote sensor directly.	Change the position of the main device.
The sound is on and off from time to time in Bluetooth mode.	There are obstacles or the distance is too far.	Change the location of Bluetooth signal source or remove obstacles.

ELEMENT AUDIO/VIDEO LIMITED WARRANTY TO ORIGINAL CONSUMER

This Product as supplied and distributed in new condition, is warranted by **ELEMENT ELECTRONICS CORP.**(ELEMENT or the Warrantor) to the original consumer purchaser against defects in material and workmanship ("Warranty") as follows:

- 1. PARTS AND LABOR :** For a period of one year from date of original consumer purchase, if this Product or any functional part is determined by ELEMENT, or an ELEMENT authorized service provider, to be defective, at ELEMENT's sole option and discretion, ELEMENT will (i) repair, at no charge to the original consumer, with new or rebuilt replacement functional parts in exchange for defective functional parts, or (ii) replace the Product, with new or refurbished product of similar or better specification, or (iii) provide a refund of original product purchase price. Replacement Product or parts are warranted for either the remainder of the original warranty period or one year from the date of replacement, whichever is longer. After the applicable Warranty periods, the consumer must pay for all parts and labor costs.
- 2. SHIPPING COSTS:** Notwithstanding the foregoing, the original consumer is responsible for any shipping charges incurred to ship the Product or part(s) to ELEMENT or to an ELEMENT authorized customer service provider, for diagnosis, repair, replacement or refund. However, ELEMENT will pay for return shipping to the customer. Products shipped back to ELEMENT or an ELEMENT authorized service provider must be in its original packaging or in packaging with an equal degree of protection.

To obtain Warranty Service and Troubleshooting information, please call the Toll Free Customer Service Line at:

1-888-338-5666

Please have your model and serial number available along with your date of purchase.

You can also visit us online at:

www.ELEMENTELECTRONICS.com

To receive Warranty service, the original consumer purchaser must contact ELEMENT for pre-authorization prior to sending any Product to ELEMENT or an ELEMENT authorized customer service provider, or for obtaining any repair, replacement or refund service. Proof of purchase in the form of a bill of sale or receipted invoice evidencing that the Product is within the applicable Warranty period(s), MUST be presented to ELEMENT in order to obtain the requested service.

Exclusions and Limitations:

This Warranty covers manufacturing defects in materials and workmanship encountered in the normal, non-commercial use of the Product, and does not cover (a) damage or failure caused by or attributable to abuse, misuse, failure to follow instructions, improper installation or maintenance, alteration, accident, or excess voltage or current; (b) improper or incorrectly performed repairs by non-authorized service facilities; (c) onsite consumer instruction or adjustments; (d) transportation, shipping, delivery, insurance, installation or set-up costs; (e) costs of product removal, transportation or reinstallation costs; (f) ordinary wear and tear, cosmetic damage or damage due to acts of nature or accident; (g) commercial use of the Product; (h) modification of, or to any part of the Product. In addition, this Warranty does not cover images "burnt" into the screen. This Warranty applies to the original consumer only and does not cover products sold AS IS or WITH ALL FAULTS, or consumables (e.g., fuses, batteries, bulbs etc.), and the Warranty is invalid if the factory-applied serial number has been altered or removed from the Product. This Warranty is valid only in the United States, and only applies to products purchased and serviced in the United States. All replaced parts and products, and products on which a refund is made, become the property of ELEMENT.

NO WARRANTIES, WHETHER EXPRESS OR IMPLIED, INCLUDING, BUT NOT LIMITED TO, ANY IMPLIED WARRANTIES OF MERCHANTABILITY OR FITNESS FOR A PARTICULAR PURPOSE, OTHER THAN THOSE EXPRESSLY DESCRIBED ABOVE SHALL APPLY. THE WARRANTOR FURTHER DISCLAIMS ALL WARRANTIES AFTER THE EXPRESS WARRANTY PERIOD STATED ABOVE. NO OTHER EXPRESS WARRANTY OR GUARANTY GIVEN BY ANY PERSON, FIRM OR ENTITY WITH RESPECT TO THE PRODUCT SHALL BE BINDING ON THE WARRANTOR. REPAIR, REPLACEMENT, OR REFUND OF THE ORIGINAL PURCHASE PRICE, AT THE WARRANTOR'S SOLE DISCRETION, ARE THE EXCLUSIVE REMEDIES OF THE CONSUMER. THE WARRANTOR SHALL NOT BE LIABLE FOR ANY INCIDENTAL OR CONSEQUENTIAL DAMAGES CAUSED BY THE USE, MISUSE OR INABILITY TO USE THE PRODUCT. NOTWITHSTANDING THE FOREGOING, CONSUMER'S RECOVERY SHALL NOT EXCEED THE PURCHASE PRICE OF THE PRODUCT. THIS WARRANTY SHALL NOT EXTEND TO ANYONE OTHER THAN THE ORIGINAL CONSUMER WHO PURCHASED THE PRODUCT AND IS NOT TRANSFERABLE. ELEMENT RETAINS THE RIGHT TO CHANGE THIS WARRANTY AT ANY TIME WITHOUT NOTICE.

Some states do not allow the exclusion or limitation of incidental or consequential damages, or allow limitations on warranties, so the above limitations or exclusions may not apply to you. This Warranty gives you specific rights, and you may have other rights, which vary from state to state.

Please send all correspondence to:

ELEMENT ELECTRONICS CORP.

c/o ELEMENT Customer Service

customerservice@elementelectronics.com

PLEASE CONTACT CUSTOMER SERVICE TO OBTAIN SHIPPING ADDRESS FOR SERVICE.

© element
ESB205