

Hisense

2.1CH Soundbar with wireless subwoofer & Dolby Atmos
Model: AX2107G



 **Dolby Atmos**

 **HDMI**[™]
HIGH-DEFINITION MULTIMEDIA INTERFACE

 **Bluetooth**[®]

4K HDR

USER MANUAL



Before using the sound bar, please read this manual thoroughly and retain it for future reference.

Contents

Important Safety Instructions	3	Basic Operation	13
Safety	3	Standby/ON	13
Warning	4	Select Modes	13
FCC Information	5	Adjust the Bass/Treble Level	13
What's in the Box	7	Turn the Surround Sound ON/OFF	14
Identifying the Parts	8	Adjust the Volume	14
Main Unit	8	Adjust the Brightness	14
Wireless Subwoofer	8	Select a Preset Sound Effect	14
Remote Control	9	Set the Audio Delay	14
Preparations	10	OPTICAL / COAXIAL / HDMI ARC	
Prepare the Remote Control	9	Operation	14
Replace the Remote Control Battery	9	Bluetooth Operation	14
Placement and Mounting	10	Pair Bluetooth-enabled Devices	14
Wall Mounting (if using option-B)	10	Listen to Music from Bluetooth Device	15
Connections	11	USB Operation	15
Dolby Atmos®	11	Troubleshooting	16
Use the HDMI Socket	11	Specifications	17
Use the OPTICAL Socket	12		
Use the COAXIAL Socket	12		
Connect Power	12		
Pair up with the subwoofer	13		

Important Safety Instructions



The lightning flash with arrowhead symbol, within an equilateral triangle, is intended to alert the user to the presence of uninsulated "dangerous voltage" within the product's enclosure that may be of sufficient magnitude as to constitute a risk of electric shock to persons.



The exclamation point within an equilateral triangle is intended to alert the user to the presence of important operating and maintenance (servicing) instructions in the literature accompanying the appliance.

Safety

- 1 **Read these instructions** – All the safety and operating instructions should be read before this product is operated.
- 2 **Keep these instructions** – The safety and operating instructions should be retained for future reference.
- 3 **Heed all warnings** – All warnings on the appliance and in the operating instructions should be adhered to.
- 4 **Follow all instructions** – All operating and usage instructions should be followed.
- 5 **Do not use this apparatus near water** – The appliance should not be used near water or moisture – for example, in a wet basement or near a swimming pool and the like.
- 6 **Clean only with a dry cloth.**
- 7 **Do not block any ventilation openings.** Install in accordance with the manufacturer's instructions.
- 8 Do not install near any heat sources such as radiators, heaters, stoves, or other apparatus (including amplifiers) that produce heat.
- 9 Do not defeat the safety purpose of the polarized or grounding plug. A polarized plug has two blades with one wider than the other. A grounding plug has two blades and a third grounding prong. The wide blade or the third prong is provided for your safety. If the provided plug does not fit into your outlet, consult an electrician for replacement of the obsolete outlet.
- 10 Protect the power cord from being walked on or pinched particularly at plugs, convenience receptacles, and the point where they exit from the apparatus.
- 11 Only use attachments/accessories specified by the manufacturer.
- 12  Use only with the cart, stand, tripod, bracket or table specified by the manufacturer, or sold with the apparatus. When a cart or rack is used, use caution when moving the cart/apparatus combination to avoid injury from tip-over.
- 13 Unplug the apparatus during lightning storms or when unused for long periods of time.
- 14 Refer all servicing to qualified personnel. Servicing is required when the apparatus has been damaged in any way, such as power supply cord or plug is damaged, liquid has been spilled or objects have fallen into the apparatus, the unit has been exposed to rain or moisture, does not operate normally, or has been dropped.
- 15 This equipment is a Class II or double insulated electrical appliance. It has been designed in such a way that it does not require a safety connection to electrical earth.
- 16 The apparatus shall not be exposed to dripping or splashing. No objects filled with liquids, such as vases, shall be placed on the apparatus.
- 17 Minimum distance around the apparatus for sufficient ventilation is 5cm.
- 18 The ventilation should not be impeded by covering the ventilation openings with items, such as newspapers, table-cloths, curtains, etc...
- 19 No naked flame sources, such as lighted candles, should be placed on the apparatus.
- 20 Batteries should be recycled or disposed of as per state and local guidelines.
- 21 The use of apparatus in moderate or tropical climates.

Caution:

- Use of controls or adjustments or performance of procedures other than those described herein, may result in hazardous radiation exposure or other unsafe operation.
- To reduce the risk of fire or electric shock, do not expose this apparatus to rain or moisture. The apparatus must not be exposed to dripping or splashing and objects filled with liquids, such as vases, must not be placed on apparatus.
- The mains plug/appliance coupler is used as the disconnect device, the disconnect device must remain readily operable.
- Danger of explosion if battery is incorrectly replaced. Replace only with the same or equivalent type.

Warning

- The battery (batteries or battery pack) shall not be exposed to excessive heat such as sunshine, fire or the like.
- Before operating this system, check the voltage of this system to see if it is identical to the voltage of your local power supply.
- Do not place this unit close to strong magnetic fields.
- Do not place this unit on the amplifier or receiver.
- Do not place this unit close to damp areas as the moisture will affect the life of the laser head.
- If any solid object or liquid falls into the system, unplug the system and have it checked by qualified personnel before operating it any further.
- Do not attempt to clean the unit with chemical solvents as this may damage the finish. Use a clean, dry or slightly damp cloth.
- When removing the power plug from the wall outlet, always pull directly on the plug, never yank on the cord.
- Changes or modifications to this unit not expressly approved by the party responsible for compliance will void the user's authority to operate the equipment.
- The rating label is pasted on the bottom or back of the equipment.

 **Battery usage CAUTION**

To prevent battery leakage which may result in bodily injury, property damage, or damage to the apparatus:

- Install all batteries correctly, + and - as marked on the apparatus.
- Do not mix old and new batteries.
- Do not mix alkaline, standard (Carbon-Zinc) or rechargeable (Ni-Cd, Ni- MH, etc.) batteries.
- Remove batteries when the unit is not used for a long time.



Correct Disposal of this product. This marking indicates that this product should not be disposed with other household wastes throughout the EU.

To prevent possible harm to the environment or human health from uncontrolled waste disposal, recycle it responsibly to promote the sustainable reuse of material resources. To return your used device, please use the return and collection systems or contact the retailer where the product was purchased. They can take this product for environmental safe recycling.



We hereby declares that this product is in compliance with the essential requirements and other relevant provisions of Directive 2014/53/EU.



The Bluetooth word mark and logos are registered trademarks owned by Bluetooth SIG, Inc.



The terms HDMI and HDMI High-Definition Multimedia Interface, and the HDMI Logo are trademarks or registered trademarks of HDMI Licensing Administrator, Inc.



Manufactured under license from Dolby Laboratories. Dolby, Dolby Atmos, Dolby Audio, and the double-D symbol are trademarks of Dolby Laboratories.



Caution: FCC Radiation Exposure Statement

This equipment complies with FCC radiation exposure limits set forth for an uncontrolled environment. This equipment should be installed and operated with a minimum distance of 20cm between the radiator and any part of your body, This transmitter must not be co-located or operating in conjunction with any other antenna or transmitter.

NOTE:

- This equipment has been tested and found to comply with the limits for a Class B digital device, pursuant to Part 15 of the FCC Rules. These limits are designed to provide reasonable protection against harmful interference in a residential installation. This equipment generates, uses and can radiate radio frequency energy and, if not installed and used in accordance with the instructions, may cause harmful interference to radio communications.
- However, there is no guarantee that interference will not occur in a particular installation. If this equipment does cause harmful interference to radio or television reception, which can be determined by turning the equipment off and on, the user is encouraged to try to correct the interference by one or more of the following measures:
 - Reorient or relocate the receiving antenna.
 - Increase the separation between the equipment and receiver.
 - Connect the equipment into an outlet on a circuit different from that to which the receiver is connected.
 - Consult the dealer or an experienced radio / TV technician for help.
- This device complies with Part 15 of the FCC Rules. Operation is subject to the following two conditions:
 - (1) this device may not cause harmful interference, and
 - (2) this device must accept any interference received, including interference that may cause undesired operation.

Supported input audio formats

The audio formats supported by this system are as follows.

Format	Function			
	HDMI	TV ARC	TV OPT	TV COA
LPCM 2ch	✓	✓	✓	✓
LPCM 5.1ch	X	X	X	X
LPCM 7.1ch	X	X	X	X
Dolby Digital	✓	✓	✓	✓
Dolby TrueHD	✓	✓	X	X
Dolby Digital Plus	✓	✓	X	X
Dolby Atmos - Dolby TrueHD	✓	✓	X	X
Dolby Atmos - Dolby Digital Plus	✓	✓	X	X

✓: Supported formats.

X: Unsupported format.

Note: The HDMI IN jack does not support copy-protected audio formats such as Super Audio CD or DVD-Audio.

Supported HDMI video formats

The video formats supported by this system are as follows.

Resolution	Frame rate	3D	Color space	Color depth	[HDMI Signal Format] setting
4K 4096 x 2160p ³⁾ 3840 x 2160p	50/59.94/60 Hz	-	RGB 4:4:4 YCbCr 4:4:4	8 bits	[enhanced format] ¹⁾
		-	YCbCr 4:2:2	8/10/12 bits	
		-	YCbCr 4:2:0	10/12 bits	
4K 4096 x 2106p ³⁾ 3840 x 2106p	23.98/24/25/ 29.97/30 Hz	-	RGB 4:4:4 YCbCr 4:4:4	10/12 bits	[standard format] ²⁾
		-	YCbCr 4:2:0	8 bits	
		-	YCbCr 4:2:2	8/10/12 bits	
1920 x 1080p	25/29.97/30/50/ 59.94/60 Hz	-	RGB 4:4:4 YCbCr 4:4:4 YCbCr 4:2:2	8/10/12 bits	[standard format] ²⁾
		⊙			
1920 x 1080i	50/59.94/60 Hz	○			
1280 x 720p	50/59.94/60 Hz	⊙			
	23.98/24/29.97/30 Hz	-			
720 x 480p	59.94/60 Hz	-			
720 x 576p	50 Hz	-			
640 x 480p	59.94/60 Hz	-	RGB 4:4:4		

○: Compatible with side-by-side (half width)³⁾ format 3D signals

⊙: Compatible with frame packing and 3D signals in³⁾ format

1) Please use a high-quality high-speed HDMI Ethernet cable that supports 18Gbps.

2) Please use a high quality high speed HDMI Ethernet cable.

What's in the Box



Main Unit

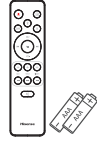

Remote Control /
AAA Batteries x 2

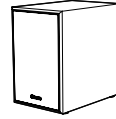

Wireless Subwoofer

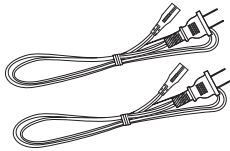

AC Power Cord
x 2



HDMI Cable



Quick Start Guide

- Design and specifications are subject to change without notice.

Identifying the Parts

Main Unit

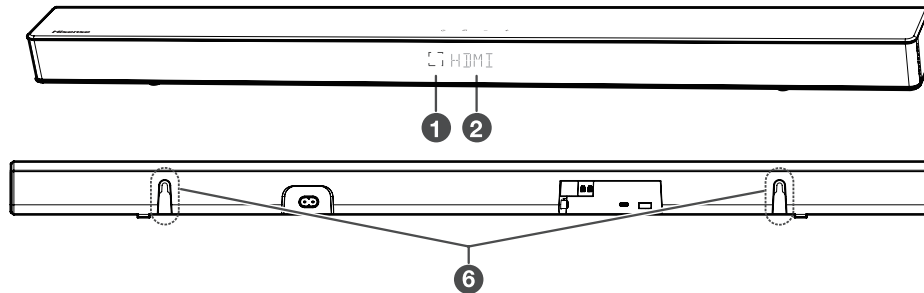

1 Remote Control Sensor
Receive signal from the remote control.

2 Display Window
Show the current status.

3 (ON/OFF) button
Switch the unit between ON and Standby mode.

4 (SOURCE) button
Select the play function.

5 VOL+/VOL- buttons
Increase/decrease the volume level.

6 Wall Mount
Install the wall mounting screws into the wall mount of the unit.

7 COAXIAL Socket

8 OPTICAL Socket

9 HDMI OUT (ARC) Socket
Connect to a TV via HDMI cable.

10 HDMI IN Sockets

11 TYPE-C Sockets (Only for data transmission)

12 USB Socket
Insert the USB device to play music.

13 AC IN Socket
Connect to the power supply.

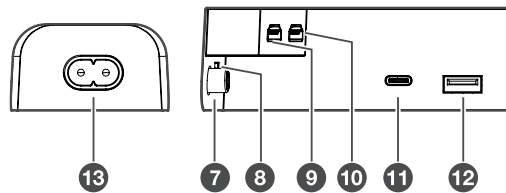
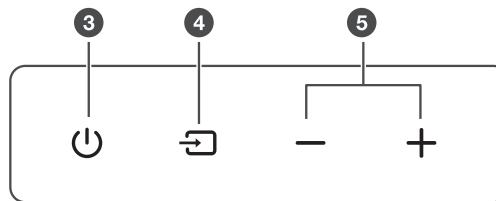

Wireless Subwoofer

1 PAIR Indicator
Light stops blinking once the Subwoofer is paired with the Soundbar.

2 PAIR button
Press activate the pairing function between the main unit and the subwoofer.

3 AC IN Socket
Connect to power.

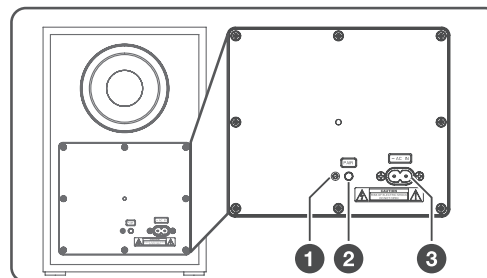

Remote Control

- | | | |
|----|--------------------|---|
| 1 | | Switch the unit between ON and STANDBY mode. |
| 2 | | Select the play mode. |
| 3 | SURR | Adjust the surround ON/OFF. |
| 4 | | Select the Bluetooth mode. |
| 5 | EQ | Select MUSIC/MOVIE/NEWS/SPORT/NIGHT/ GAME sound effect. |
| 6 | | Skip to previous/next track in BT/USB mode. |
| 7 | VOL+ / VOL- | Increase/decrease the volume level. |
| 8 | | Play/pause/resume playback in BT/USB mode. |
| 9 | BASS+/- | Increase/decrease the bass level. |
| 10 | TREBLE+/- | Increase/decrease the treble level. |
| 11 | DIMMER+/- | Adjust display brightness. |
| 12 | | Mute or resume the volume. |

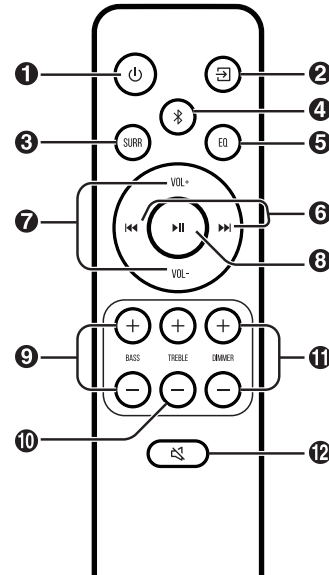

Preparations

Prepare the Remote Control

The provided Remote Control allows the unit to be operated from a distance.

- Even if the Remote Control is operated within the effective range 19.7 feet (6m), remote control operation may be impossible if there are any obstacles between the unit and the remote control.
- If the Remote Control is operated near other products which generate infrared rays, or if other remote control devices using infra-red rays are used near the unit, it may operate incorrectly. Conversely, the other products may operate incorrectly.

Replace the Remote Control Battery

- 1 Press and slide the back cover to open the battery compartment of the remote control.
- 2 Insert two **AAA** size batteries (included). Make sure the (+) and (-) ends of the batteries match the (+) and (-) ends indicated in the battery compartment.
- 3 Close the battery compartment cover.

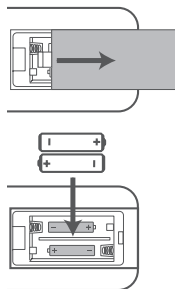

Precautions Concerning Batteries

- Be sure to insert the batteries with correct positive “ \oplus ” and negative “ \ominus ” polarities.
- Use batteries of the same type. Never use different types of batteries together.
- Either rechargeable or non-rechargeable batteries can be used. Refer to the precautions on their labels.
- Be aware of your fingernails when removing the battery cover and the battery.
- Do not drop the remote control.
- Do not allow anything to impact the remote control.
- Do not spill water or any liquid on the remote control.
- Do not place the remote control on a wet object.
- Do not place the remote control under direct sunlight or near sources of excessive heat.
- Remove the battery from the remote control when not in use for a long period of time, as corrosion or battery leakage may occur and result in physical injury, and/or property damage, and/or fire.
- Do not use any batteries other than those specified.
- Do not mix new batteries with old ones.
- Never recharge a battery unless it is confirmed to be a rechargeable type.

Placement and Mounting

Placement

- A If your TV is placed on a table, you can place the unit on the table directly in front of the TV stand, centered with the TV screen.
- B If your TV is attached to a wall, you can mount the unit on the wall directly below the TV screen.

Wall Mounting (if using option-B)

Note:

- Installation must be carried out by qualified personnel only. Incorrect assembly can result in severe personal injury and property damage (if you intend to install this product yourself, you must check for installations such as electrical wiring and plumbing that may be buried inside the wall). It is the installer's responsibility to verify that the wall will safely support the total load of the unit and wall brackets.
 - Additional tools (not included) are required for the installation.
 - Do not overtighten screws.
 - Keep this instruction manual for future reference.
 - Use an electronic stud finder to check the wall type before drilling and mounting.
1. Drill 2 parallel holes (\varnothing 5.5-6 mm each according to wall type) in the wall. The distance between the holes should be 640 mm.
 2. Firmly fix 1 dowel into each hole in the wall if necessary. Tighten the wall mount brackets on the wall with screws and screwdriver. Make sure that they are securely installed.
 3. Lift the unit onto the wall mount screws into place.

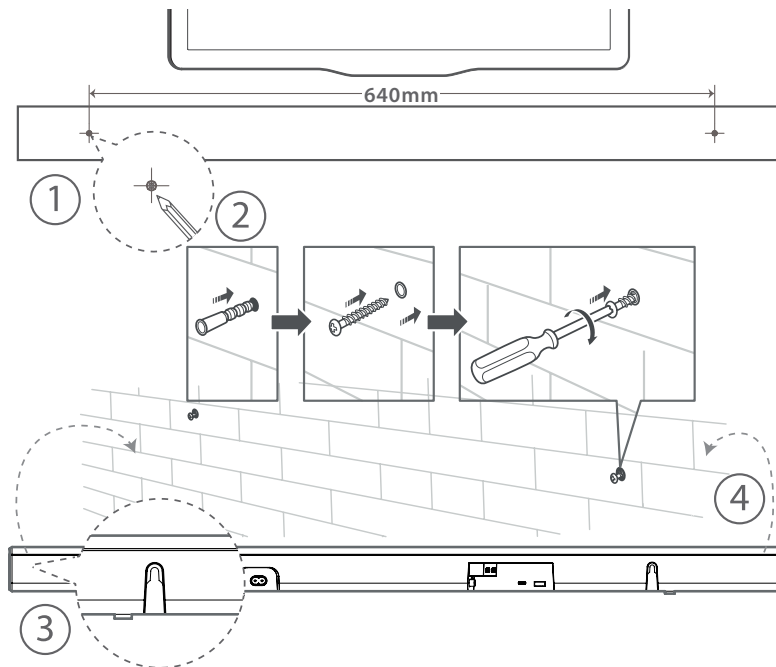
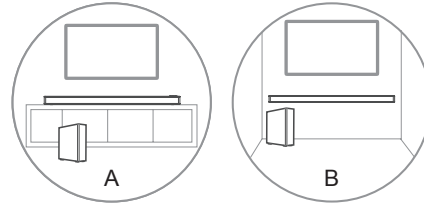

Connections

Dolby Atmos®

Dolby Atmos gives you amazing experience you have never before by overhead sound, and all the richness, clarity, and power of Dolby sound.

For using Dolby Atmos®

Dolby Atmos® is available only in HDMI mode. For the details of the connection, please refer to “**HDMI Connection**”.

1. To use Dolby Atmos® in HDMI mode, Your TV hadto support Dolby Atmos® or HDMI audio passthrough.
2. Make sure that “No Encoding” is selected for bitstream in the audio output of the connected external device (e.g. Blu-ray DVD player, TV etc.).
3. While entering Dolby Atmos / Dolby Digital / PCM format, the soundbar will show DOLBY ATMOS / DOLBY AUDIO / PCM AUDIO.
4. While the soundbar is using Dolby Atmos audio, you can only adjust the bass level of the subwoofer. All other EQ effects will not be available.

Use the HDMI Socket

Some 4K HDR TVs require the HDMI input or picture settings to be set for HDR content reception. For further setup details on HDR display, please refer to the instruction manual of your TV.

Using HDMI to connect the soundbar, AV equipment and TV:

Method 1: ARC (Audio Return Channel)

The ARC (Audio Return Channel) function allows you to send audio from your ARC- compliant TV to your soundbar through a single HDMI connection. To enjoy the ARC function, please ensure your TV is both HDMI-CEC and ARC compliant and set up accordingly. When correctly set up, you can use your TV remote control to adjust the volume output (VOL +/- and MUTE) of the soundbar.

- Connect the HDMI cable (not included) from unit's **HDMI OUT (ARC)** socket to the HDMI (ARC) socket on your ARC compliant TV. Then press the remote control to select **HDMI ARC**.

Tips:

- Your TV must support the HDMI-CEC and ARC function. HDMI-CEC and ARC must be set to On.
- The setting method of HDMI-CEC and ARC may differ depending on the TV. For details about ARC function, please refer to the owner's manual.

Method 2: Standard HDMI

- If your TV is not HDMI ARC-compliant, connect your soundbar to the TV through a standard HDMI connection.

1. Use an HDMI cable (not included) to connect the soundbar's **HDMI OUT (ARC)** socket to the TV's HDMI IN socket.
2. Use an HDMI cable (not included) to connect the soundbar's **HDMI IN** socket to your external devices (e.g. games consoles, DVD players and blu ray).

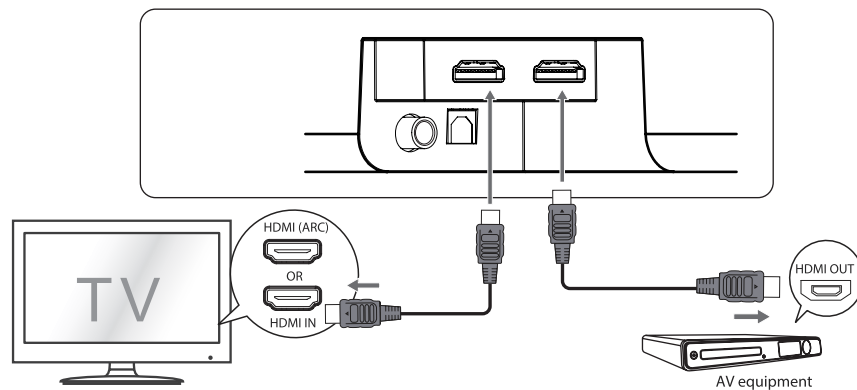

Use the OPTICAL Socket

- Remove the protective cap of the **OPTICAL** socket, then connect an OPTICAL cable (not included) to the TV's OPTICAL OUT socket and the **OPTICAL** socket on the unit.

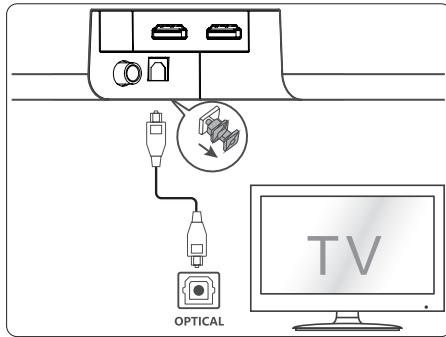

Use the COAXIAL Socket

- You also can use the COAXIAL cable (not included) to connect the TV's COAXIAL OUT socket and COAXIAL socket on the unit.

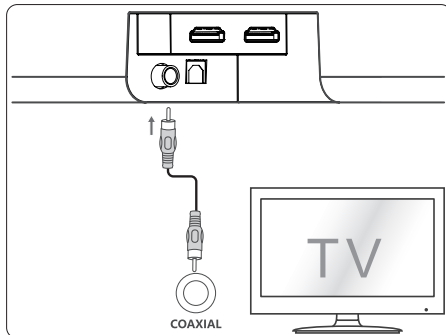

Tip: The unit may not be able to decode all digital audio formats from the input source. In this case, the unit will mute. This is NOT a defect. Ensure that the audio setting of the input source (e.g. TV, game console, DVD player, etc.) is set to **PCM** or **Dolby Digital** (Refer to the user manual of the input source device for its audio setting details) with HDMI / OPTICAL / COAXIAL input.

Connect Power

Risk of product damage!

- Ensure that the power supply voltage corresponds to the voltage printed on the back or the underside of the unit.
- Before connecting the AC power cord, ensure you have completed all other connections.

Subwoofer

- Connect the mains cable to the **AC IN** Socket of the subwoofer and then into a mains socket.

Soundbar

- Connect the mains cable to the **AC IN** Socket of main unit and then into a mains socket.

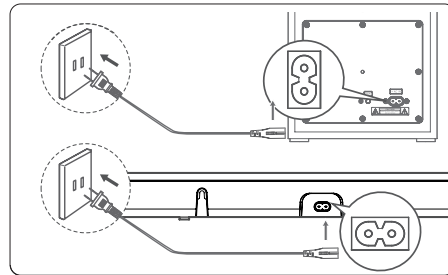

Pair up With The Subwoofer

Automatic pairing

Plug the soundbar and the subwoofer into the mains sockets and then press on the unit or remote control to switch the unit to ON mode. The subwoofer and soundbar will automatically pair.

- When the subwoofer is pairing with the main unit, the Pair Indicator will flash fast.
- When the subwoofer is paired with the main unit, the Pair Indicator will light up.

NOTE:

- Do not press the **Pair** button on the subwoofer, except for manual pairing.
- If the automatic pairing fails, pair the subwoofer with the main unit manually.

Manual pairing

If no audio from the wireless subwoofer can be heard, manually pair up the subwoofer.

- 1 Power up Sound bar by remote control or touch pad.
- 2 Power up subwoofer and press **Pair** key for 3 seconds until the LED turn to fast flashing from slow flashing. Please disconnect the AC power and connect again after 5 minutes to reset the subwoofer.
- 3 Press Sound bar **SOURCE** key for 5 seconds until the screen shows "**SUB PAIRING**". It is connected when the LED of subwoofer turns to normal.



NOTE:

- The subwoofer should be within 6 m of the soundbar in an open area (the closer the better).
- Remove any objects between the subwoofer and the soundbar.
- If the wireless connection fails again, check if there is a conflict or strong interference (e. g. interference from an electronic device) around the location. Remove these conflicts or strong interferences and repeat the above procedures.
- If the main unit is not connected with the subwoofer and it is in ON mode, the unit's POWER indicator will flash.

Basic Operation

Standby/ON

When you first connect the main unit to the mains socket, the main unit will be in Standby mode.

- Press the  button on the unit or on the remote control to switch the unit ON.
- Press the  button again to switch the unit back to STANDBY mode.
- Disconnect the mains plug from the mains socket if you want to switch the unit OFF completely.

- **Auto Wake**

If a TV or an external device is connected, the unit will switch on automatically when the TV or the external device is switched on.

- **Auto Standby**

The unit automatically turns to Standby mode after about 15 minutes if the TV or the external unit is disconnected, switched off.

- To switch the unit off completely, remove the mains plug from the mains socket.
- Please turn the unit off completely to save energy when not in use.

Select Modes

Press the  (SOURCE) button repeatedly on the unit or the **SOURCE** button on the remote control to select the **OPTICAL, COAXIAL, ARC, HDMI IN, BT_IN** (Bluetooth) and **USB** mode. The selected mode will show on the display.



Adjust the Bass/Treble Level

- Press **TREBLE** then press **VOL+/-** button to increase or decrease the treble. (treble+5 / treble-5)
- Press **BASS** then press **VOL+/-** button to increase or decrease the bass. (bass+5 / bass-5)
- After about 5 seconds, the unit will exit from bass/treble setting. The display will show the current selected mode. You may now press the VOL+ / - buttons to adjust volume.

Turn the Surround Sound ON/OFF

- Press the **SURR** button on the remote control to turn on the surround sound. Press this button again to turn off the surround sound.

Adjust the Volume

- Press the **VOL+** / **VOL-** buttons on the unit or on the remote control to adjust the volume.
- If you wish to turn the sound off, press the  (MUTE) button on the remote control. Press the  (MUTE) button again or press the **VOL+** / **VOL-** buttons to resume normal listening.

Adjust the Brightness

- Press the **DIMMER +/-** button on the remote control to select brightness level.

Select a Preset Sound Effect

- While playing, press the **EQ** button on the remote control to select desired preset equalizers:
MUSIC, MOVIE, NEWS, SPORT, NIGHT, GAME.

OPTICAL / COAXIAL /HDMI ARC Operation

- 1 Ensure that the unit is connected to the TV or audio device.
- 2 Press the  button repeatedly on the unit or the **SOURCE** button on the remote control to select the **OPTICAL, COAXIAL, ARC, HDMI IN** mode.
- 3 Operate your audio device directly for playback features.
- 4 Press the **VOL +/-** button to adjust the volume to your desired level.

Tip:

- The unit may not be able to decode all digital audio formats from the input source. In this case, the unit will mute. This is NOT a defect. Ensure that the audio setting of the input source (e.g. TV, game console, DVD player, etc.) is set to **PCM** or **Dolby Digital** (Refer to the user manual of the input source device for its audio setting details) with HDMI IN / HDMI ARC / OPTICAL / COAXIAL input.
- When selecting a different audio format, the unit will display the following as follows:



Audio (abbreviation)	Display
LPCM 2ch	PCM AUDIO
LPCM 5.1ch	PCM AUDIO
LPCM 7.1ch	PCM AUDIO
Dolby Digital	DOLBY SURROUND / DOLBY AUDIO
Dolby TrueHD	
Dolby Digital Plus	
Dolby Atmos - Dolby TrueHD	DOLBY SURROUND / DOLBY ATMOS
Dolby Atmos - Dolby Digital Plus	DOLBY SURROUND / DOLBY ATMOS

Bluetooth Operation

Pair Bluetooth-enabled Devices

The first time you connect your bluetooth device to this player, you need to pair your device to this player.

Note:

- The operational range between this player and a Bluetooth device is approximately 26 feet (8m) (without any object between the Bluetooth device and the unit).
 - Before you connect a Bluetooth device to this unit, ensure you know the device's capabilities.
 - Compatibility with all Bluetooth devices is not guaranteed.
 - Any obstacle between this unit and a Bluetooth device can reduce the operational range.
 - If the signal strength is weak, your Bluetooth receiver may disconnect, but it will re-enter pairing mode automatically.
- 1 During ON mode, press the  button repeatedly on the unit or the  (BT) button on the remote control to select Bluetooth mode. "NO BT" will show on the display if the unit is not paired to any Bluetooth device.
 - 2 Activate your Bluetooth device and select the search mode. "Hisense AX2107G" will appear on your Bluetooth device list.
 - If you cannot find the unit, press and hold the  (BT) button on the remote control to be searchable. The display will show "BT PAIRING" and you will hear "Paired" from the unit.
 - 3 Select "Hisense AX2107G" in the pairing list. After successful pairing, you will hear "Paired" and the display panel shows "BT_IN".
 - 4 Play music from the connected Bluetooth device.

To disconnect the Bluetooth function, you can :



- Switch to another function on the unit.
- Disable the function from your Bluetooth device. The Bluetooth device will be disconnected.

Tips:





- Enter "0000" for the password if necessary.
- If no other Bluetooth device pairs with this player within two minutes, the player will recover its previous connection.
- The player will also be disconnected when your device is moved beyond the operational range.

- If you want to reconnect your device to this player, place it within the operational range.
- If the device is moved beyond the operational range, when it is brought back, please check if the device is still connected to the player.
- If the connection is lost, follow the instructions above to pair your device to the player again.

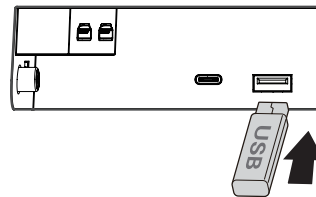
Listen to Music from Bluetooth Device

- If the connected Bluetooth device supports Advanced Audio Distribution Profile (A2DP), you can listen to the music stored on the device through the player.
1. Pair your device with the player.
 2. Play music via your device (if it supports A2DP).
 3. Use supplied remote control to control play (if it supports AVRCP).
 - To pause/resume play, press the  button on the remote control.
 - To skip to a track, press the  /  buttons on the remote control.

USB Operation

- 1 Insert the USB device.
- 2 Press the  button repeatedly on the unit or press the **SOURCE** button on the remote control to select **USB** mode.
- 3 During playback:
 - To pause or resume play, press the  button on the remote control.
 - To skip to the previous/next file, press the  /  buttons on the remote control.

Tips:

- The unit can support USB devices with up to 32 GB of memory.
- This unit can play MP3/WAV/WMA.
- Support a USB port: FAT32, exFAT.

Troubleshooting

To keep the warranty valid, never try to repair the system yourself. If you encounter problems when using this unit, check the following points before requesting service.

No power

- Ensure that the AC cord of the apparatus is properly connected .
- Ensure that there is power at the AC outlet.
- Press standby button to turn the unit on.

Remote control does not work

- Before you press any playback control button, first select the correct source.
- Reduce the distance between the remote control and the unit.
- Insert the battery with its polarities (+/-) aligned as indicated.
- Replace the battery.
- Aim the remote control directly at the sensor on the front of the unit.

No sound

- Make sure that the unit is not muted. Press MUTE or VOL+/VOL- button to resume normal listening.
- Press \cup button on the unit or on the remote control to switch the soundbar to standby mode. Then press the \cup button again to switch the soundbar on.
- Unplug both the soundbar and the subwoofer from the mains socket, then plug them again. Switch on the soundbar.
- Ensure the audio setting of the input source (e.g. TV, game console, DVD player, etc.) is set to PCM or Dolby Digital mode while using digital (e.g. HDMI, OPTICAL, COAXIAL) connection.
- The subwoofer is out of range, please move the subwoofer closer to the soundbar. Make sure the subwoofer is within 5 m of the soundbar (the closer the better).
- The soundbar may have lost connection with the subwoofer. Re-pair the units by following the steps on the section "Pairing the Wireless Subwoofer with the Soundbar".
- The unit may not be able to decode all digital audio formats from the input source. In this case, the unit will mute. This is NOT a defect. device is not muted.

I can't find the Bluetooth name of this unit on my Bluetooth device for Bluetooth pairing

- Ensure the Bluetooth function is activated on your Bluetooth device.
- Ensure you have paired the unit with your Bluetooth device.

This is a 15 mins power off function, one of the ERPII standard requirement for saving power

- When the unit's external input signal level is too low, the unit will be turned off automatically in 15 minutes. Please increase the volume level of your external device.

The subwoofer is idle or the indicator of subwoofer do not light up.

- The subwoofer is idle when it is not connected to sound bar over 1 minute. The indicator is off when the subwoofer is idle. Please disconnect the AC power and connect again after 5 minutes to reset the subwoofer

Specifications

Model Name	AX2107G
-------------------	---------

Soundbar	
Power Supply	AC100-240V~ 50/60Hz
Power Consumption	60 W
Standby Power	< 0.5 W
USB port for playback	5V --- 0.5A
USB Compatibility	Hi-Speed USB (2.0) / FAT32
USB Playback support / file formats	32G (max) , MP3/WAV/WMA
Dimension (WxHxD)	960 x 58 x 85 mm (37.8 x 2.3 x 3.3 inch)
Net weight	4.85 lbs (2.2 kg)
Audio input sensitivity	-12dBFS
Frequency Response	120Hz - 20KHz
Wireless Specification	
Bluetooth Version	V 5.0
Frequency bands	2402 MHz ~ 2480 MHz
2.4G wireless frequency bands	2404 MHz ~ 2476 MHz
Subwoofer	
Power Supply	AC100-240V~ 50/60Hz
Power Consumption	80 W
Standby Power	< 0.5 W
Dimension (WxHxD)	200 x 304 x 295 mm (7.9 x 12.0 x 11.6 inch)
Net weight	8.82 lbs (4.0 kg)
Frequency Response	40Hz - 120Hz
Amplifier (Outputpower)	
Soundbar	60W, 30W x 2 (@10%THD)
Subwoofer	80W (@10%THD)
Total	140W
Remote Control	
Distance/Angle	19.7 feet (6m) / 30°
Battery type	AAA (1.5V X 2)

Hisense

AX2107G