

amazon
basics

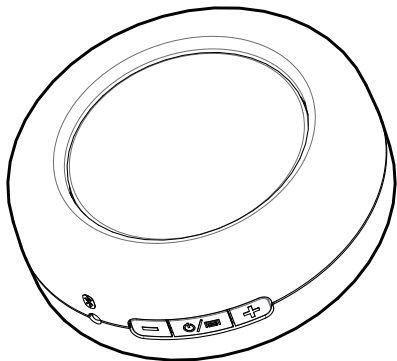



Instruction Manual • English

AmazonBasics Micro Ultra-Portable Bluetooth® Speaker

Contents

- Mono Portable Bluetooth Speaker
- Carrying pouch
- USB charging cable
- This instruction manual

Bluetooth 4.0 supported

Product overview

Top/Front

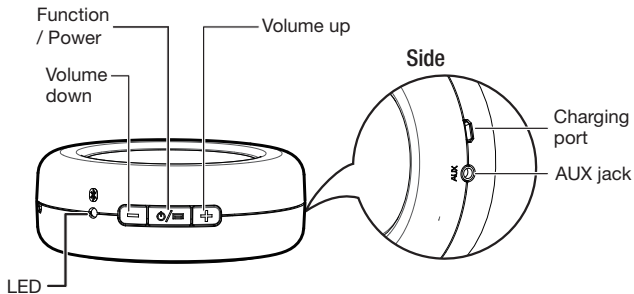





Setup

Your speaker is partially charged when it arrives so you can use it right away. For the best reception, keep your speaker within 30 feet of the device it's paired to.



Pairing your speaker with a device

1. Turn ON your speaker. A tone sounds, the LED blinks and your speaker enters last device searching mode.
 2. Press and hold the function  button for 1 to 3 seconds to put your speaker in pairing mode. A tone sounds and the LED blinks quickly.
 3. Turn ON your Bluetooth device (like a phone or tablet).
 4. On your device, locate your Bluetooth settings and turn on Bluetooth.
 5. In Bluetooth Settings, scan for devices if necessary, then select **Amazon_BT4** from your device's list. The LED stops blinking and lights blue. Your device and speaker are paired and your speaker is ready to use.
- 
- 

Note: Your speaker stays in pairing mode for 3 minutes or until you pair a device. If you do not pair a device within 3 minutes, your speaker exits pairing mode and the LED flashes slowly. To start pairing mode again, press the function  button once.

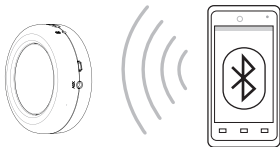

Pairing another device or reconnecting to a paired device

1. Disconnect from the previous device by pressing and holding the function  button for 1 to 3 seconds. A tone sounds, the LED blinks quickly, and your speaker enters pairing mode.
2. Repeat the pairing steps for your next device.

Note: You can pair multiple devices but you can only have one device actively paired at a time.



Play music

- Start playing music on your paired device. Music plays through your speaker.
- On your speaker, press + or – to increase or decrease the volume.

Note: A tone sounds when the maximum volume setting is reached.

Connect with an audio cable

1. Connect a 3.5 mm audio cable (not included) from your speaker's AUX jack to your audio device (like an MP3 player).
2. You should disconnect from Bluetooth while using Aux jack to play music.

Press and hold the function  button 1~3 seconds to disconnect Bluetooth.

Note: When connected to AUX, use the controls on the device instead of your speaker.

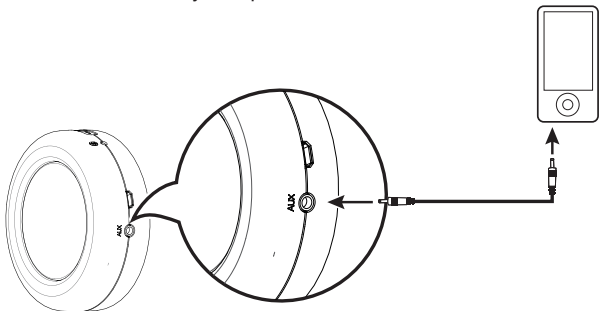

Charge your speaker

When your speaker is turned on and the battery is low, your speaker's LED flashes red. If not charged, your speaker turns off.

To charge your speaker, connect the USB charging cable to the port on your speaker and an available USB port on your computer.

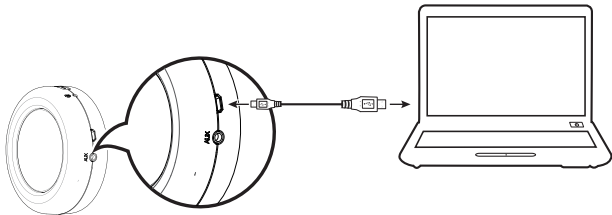

- If your speaker is ON, the LED flashes red & blue when charging. When fully charged and connected to a Bluetooth device, the LED lights blue.
- If your speaker is OFF, the LED lights red while charging and turns off when fully charged.





Troubleshooting

My speaker won't pair.

- Move your speaker and Bluetooth device closer together.
- If you do not pair a device within 3 minutes, your speaker exits pairing mode and the LED flashes slowly. Press the function  button once to put your speaker into pairing mode. A tone sounds and the LED blinks quickly.
- Press and hold the function  button to make sure that your speaker is not connected to any other Bluetooth device.



The sound is too quiet or loud.



- Adjust the volume on your device. It should be at about 50%.
- Adjust your speaker volume.

I hear static through my speaker.



- Move your speaker closer to your paired device. The maximum distance is 30 feet.
- Turn down the volume.

My speaker buttons aren't controlling my device.

- Some functions may be restricted depending on the device paired to your speaker.
- If the device is connected to the AUX jack, you must use the controls on the device.
- Make sure the device is within 30 feet of your speaker.
- Make sure your device supports Bluetooth 4.0.

Safety and Compliance

WARNING: To reduce the risk of fire or electric shock: Do not expose this appliance to rain or moisture.

| | | |
|---|---|---|
|  | CAUTION RISK OF ELECTRIC SHOCK DO NOT OPEN |  |
| CAUTION: TO REDUCE THE RISK OF ELECTRIC SHOCK, DO NOT REMOVE COVER OR BACK NO USER-SERVICEABLE PARTS INSIDE REFER SERVICING TO QUALIFIED SERVICE PERSONNEL | | |

A warning that batteries (battery pack or batteries installed) shall not be exposed to excessive heat such as sunshine, fire or the light.

FCC Information

This equipment has been tested and found to comply with the limits for a Class B digital device, pursuant to Part 15 of the FCC Rules. These limits are designed to provide reasonable protection against harmful interference in a residential installation. This equipment generates, uses and can radiate radio frequency energy and, if not installed and used in accordance with the instructions, may cause harmful interference to radio communications. However, there is no guarantee that interference will not occur in a particular installation. If this equipment does cause harmful interference to radio or television reception, which can be determined by turning the equipment off and on, the user is encouraged to try to correct the interference by one or more of the following measures:

- Reorient or relocate the receiving antenna.
- Increase the separation between the equipment and receiver.
- Connect the equipment into an outlet on a circuit different from that to which the receiver is connected
- Consult the dealer or an experienced radio/TV technician for help.

Changes or modifications not expressly approved by the party responsible for compliance may cause interference and void the user's authority to operate the equipment.

This device complies with Part 15 of the FCC Rules. Operation is subject to the following two conditions: (1) This device may not cause harmful interference, and (2) this device must accept any interference received, including interference that may cause undesired operation."

PRODUCT DISPOSAL INFORMATION

Dispose of this product in accordance with Local and National Disposal Regulations.



WEEE

Regulatory Information: Disposal of Waste Electrical and Electronic Equipment (WEEE)

The Waste Electrical and Electronic Equipment (WEEE) Directive aims to minimize the impact of electrical and electronic goods on the environment, by increasing re-use and recycling and by reducing the amount of WEEE going to landfill. The symbol on this product or its packaging signifies that this product must be disposed separately from ordinary household wastes at its end of life. Be aware that this is your responsibility to dispose of electronic equipment at recycling centers in order to help conserve natural resources.

Each country should have its collection centers for electrical and electronic equipment recycling. For information about your recycling drop off area, please contact your related electrical and electronic equipment waste management authority, your local city office, or your household waste disposal service.





amazon
basics

VO 00-0000

