

## FCC 47 CFR PART 15 SUBPART C

Product Type : Bluetooth Mono Speaker  
Applicant : Guoguang Electric Co.,Ltd  
Address : No. 8 Jinghu Road, Xinhua Town, Huadu Region, Guangzhou,  
510800 P. R. China  
Model Number : BTV4  
Trade Name : NA  
Test Specification : FCC 47 CFR PART 15 SUBPART C: Oct., 2012  
ANSI C63.10:2009  
KDB558074 D01  
Receive Date : 18 July, 2014  
Test Period : 22 July, 2014~25 July, 2014  
Issue Date : 09 August, 2014

Issue by

A Test Lab Techno Corp.  
No. 140-1, Changan Street, Bade City,  
Taoyuan County 334, Taiwan R.O.C.  
Tel : +886-3-2710188 / Fax : +886-3-2710190



Taiwan Accreditation Foundation accreditation number: 1330

**Note:** This report shall not be reproduced except in full, without the written approval of A Test Lab Techno Corp. This document may be altered or revised by A Test Lab Techno Corp. personnel only, and shall be noted in the revision section of the document. The client should not use it to claim product endorsement by TAF, or any government agencies. The test results in the report only apply to the tested sample.



**Revision History**

Rev.	Issue Date	Revisions	Revised By
Draft	09 August, 2014		



## Verification of Compliance

Issued Date: 09 August, 2014

Product Type : Bluetooth Mono Speaker  
Applicant : Guoguang Electric Co.,Ltd  
Address : No. 8 Jinghu Road, Xinhua Town, Huadu Region, Guangzhou, 510800 P. R. China  
Model Number : BTV4  
Trade Name : NA  
FCC ID : 2AAP800007  
EUT Rated Voltage : DC 3.7V  
Test Voltage : DC 3.7V  
Applicable Standard : FCC 47 CFR PART 15 SUBPART C: Oct., 2012  
ANSI C63.4:2009  
KDB558074 D01  
Test Result : Complied  
Performing Lab. : Shenzhen Academy of Metrology and Quality Inspection  
No.4 Tongfa Road, Xili Town, Nanshan District, Shenzhen, Guangdong, China  
Tel : 0086-755-86928965 / Fax : 0086-755-86009898-31396  
Web: www.smq.com.cn

The EUT described above is tested by Shenzhen Academy of Metrology and Quality Inspection EMC Laboratory to determine the maximum emissions from the EUT. Shenzhen Academy of Metrology and Quality Inspection EMC Laboratory is assumed full responsibility for the accuracy of the test results. The test data, data evaluation, test procedures, and equipment configurations shown in this report were made in accordance with the procedures given in ANSI C63.4 (2003) and the energy emitted by the sample EUT tested as described in this report is in compliance with FCC Rules Part 15.207, 15.209 and 15.247.

The test results of this report relate only to the tested sample identified in this report.

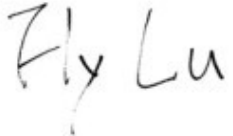
Approved By :  Reviewed By :   
(Manager) \_\_\_\_\_ (Testing Engineer) \_\_\_\_\_



## TABLE OF CONTENTS

<b>1</b>	<b>General Information.....</b>	<b>6</b>
	1.1. Summary of Test Result.....	6
	1.2. Measurement Uncertainty.....	6
<b>2</b>	<b>EUT Description.....</b>	<b>7</b>
<b>3</b>	<b>Test Methodology.....</b>	<b>8</b>
	3.1. Mode of Operation.....	8
	3.2. Configuration of Test System Details.....	9
	3.3. Test Site Environment.....	9
<b>4</b>	<b>Maximum Conducted Output Power Measurement.....</b>	<b>10</b>
	4.1. Limit.....	10
	4.2. Test Setup.....	10
	4.3. Test Instruments.....	10
	4.4. Test Procedure.....	10
	4.5. Test Result.....	11
<b>5</b>	<b>Conducted Emission Measurement.....</b>	<b>13</b>
	5.1. Limit.....	13
	5.2. Test Instruments.....	13
	5.3. Test Setup.....	13
	5.4. Test Result.....	14
<b>6</b>	<b>Radiated Interference Measurement.....</b>	<b>16</b>
	6.1. Limit.....	16
	6.2. Test Instruments.....	16
	6.3. Setup.....	17
	6.4. Test Procedure.....	18
	6.5. Test Result.....	19
<b>7</b>	<b>20dB RF Bandwidth Measurement.....</b>	<b>23</b>
	7.1. Limit.....	23
	7.2. Test Setup.....	23
	7.3. Test Instruments.....	23
	7.4. Test Procedure.....	23
	7.5. Test Result.....	24
	7.6. Test Graphs.....	错误！未定义书签。
<b>8</b>	<b>Maximum Power Density Measurement.....</b>	<b>26</b>

8.1. Limit.....	26
8.2. Test Setup.....	26
8.3. Test Instruments .....	26
8.4. Test Procedure.....	26
8.5. Test Result.....	27
8.6. Test Graphs .....	27
<b>9 Out of Band Conducted Emissions Measurement.....</b>	<b>29</b>
9.1. Limit.....	29
9.2. Test Setup.....	29
9.3. Test Instruments .....	29
9.4. Test Procedure.....	29
9.5. Test Graphs .....	30
<b>10 Band Edges Measurement.....</b>	<b>34</b>
10.1. Limit.....	34
10.2. Test Setup.....	34
10.3. Test Instruments .....	34
10.4. Test Procedure.....	35
10.5. Test Result.....	36
<b>11 Antenna Measurement .....</b>	<b>40</b>
11.1. Limit.....	40
11.2. Antenna Connector Construction.....	40

## 1 General Information

### 1.1. Summary of Test Result

Item	Result	Remark
AC Power Conducted Emission	PASS	---
Transmitter Radiated Emissions	PASS	Radiated method
Max. Output Power	PASS	Conducted method
6dB RF Bandwidth	PASS	Conducted method
Power Spectral Density	PASS	Conducted method
Out of Band Conducted Spurious Emission	PASS	Conducted method
Band Edge Measurement	PASS	Conducted method
Occupied Bandwidth Measurement	PASS	Conducted method
Antenna Requirement	PASS	-----

The test results of this report relate only to the tested sample(s) identified in this report. Manufacturer or whom it may concern should recognize the pass or fail of the test result.

### 1.2. Measurement Uncertainty

Test Item	Frequency Range	Uncertainty (dB)
Conducted Emission	9kHz ~ 30MHz	3.50
Radiated Emission	30MHz ~ 1000MHz	4.50
	1000MHz ~ 18000MHz	4.60
	18000MHz ~ 40000MHz	5.12

## 2 EUT Description

Product	Bluetooth Mono Speaker		
Trade Name	NA		
Model Number	BTV4		
Applicant	Guoguang Electric Co.,Ltd No. 8 Jinghu Road, Xinhua Town, Huadu Region, Guangzhou, 510800 P. R. China		
Manufacturer	Guoguang Electric Co.,Ltd No. 8 Jinghu Road, Xinhua Town, Huadu Region, Guangzhou, 510800 P. R. China		
FCC ID	2AAP800007		
Frequency Range	2402 ~ 2480 MHz		
Modulation Type	Bluetooth 4.0	GFSK	
Antenna Type	PCB Antenna		
Antenna Gain	0.0dBi		
RF Output Power (Conducted)	BLE GFSK	-2.822 dBm /	0.522 mW
20dB Bandwidth	BLE GFSK:0.7019MHz		

## 3 Laboratory Accreditation and Relationship to Customer

The testing report were performed by the Shenzhen Academy of Metrology and quality Inspection EMC Laboratory (Guangdong EMC compliance testing center), in their facilities located at Bldg. of Metrology & Quality Inspection, Longzhu Road, Nanshan District, Shenzhen, Guangdong, China. At the time of testing, Laboratory is accredited by the following organizations:

China National Accreditation Service for Conformity Assessment (CNAS) accredits the Laboratory for conformance to FCC standards, EMC international standards and EN standards. The Registration Number is CNAS L0579. The Laboratory is listed in the United States of American Federal Communications Commission (FCC), and the registration number are 446246 806614 994606(semi anechoic chamber).

The Laboratory is listed in Voluntary Control Council for Interference by Information Technology Equipment (VCCI), and the registration number are R-1974(open area test site), R-1966(semi anechoic chamber), C-2117(mains ports conducted interference measurement) and T-180(telecommunication ports conducted interference measurement).

The Laboratory is registered to perform emission tests with Industry Canada (IC), and the registration number is 11177A-1 11177A-2.

TUV Rhineland accredits the Laboratory for conformance to IEC and EN standards, the registration number is E2024086Z02.

## 4 Test Methodology

### 4.1. Mode of Operation

Decision of Test ATL has verified the construction and function in typical operation. All the test modes were carried out with the EUT in normal operation, which was shown in this test report and defined as:

Test Mode
Mode 1: Normal Working Mode
Mode 2: BLE Link Mode
--

By preliminary testing and verifying three axis (X, Y and Z) position of EUT transmitted status, it was found that "X axis" position was the worst, then the final test was executed the worst condition and test data were recorded in this report.

#### Description of Test Modes

Preliminary tests were performed in different modulation to find the worst case. The modulation has shown the worst-case in section 6.5. Investigation has been done on all the possible configurations for searching the worst cases.

#### EUT Exercise Software

1	Setup the EUT as shown on 3.2.
2	Turn on the power of all EUT.
3	Keep EUT in continuous transmitting under the help of PC software CSR BlueTest3.

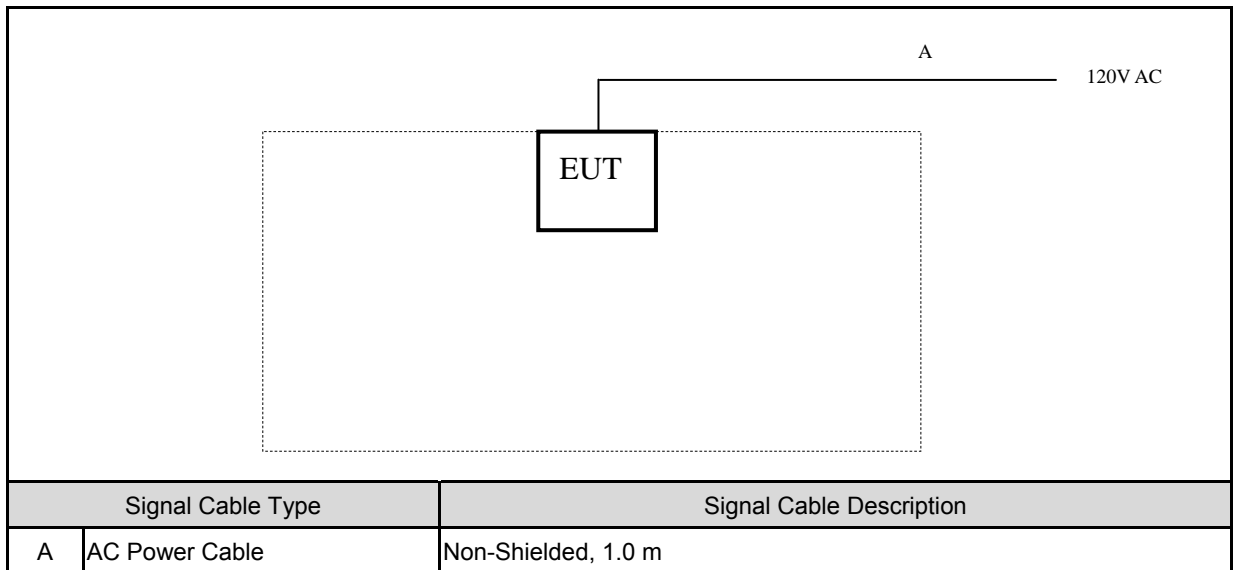

**4.2. Configuration of Test System Details**

**4.3. Test Site Environment**

Items	Required (IEC 68-1)	Actual
Temperature (°C)	15-35	26
Humidity (%RH)	25-75	60
Barometric pressure (mbar)	860-1060	950

## 5 Maximum Conducted Output Power Measurement

### 5.1. Limit

For systems using digital modulation in the 902–928 MHz, 2400–2483.5 MHz, and 5725–5850 MHz bands: 1 Watt.

### 5.2. Test Setup

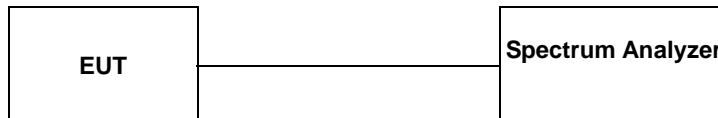

### 5.3. Test Instruments

Equipment	Manufacturer	Model Number	Serial Number	Cal. Date	Remark
Signal Analyzer	Agilent	N9020A	MY53420615	12/19/2013	(1)

Remark: (1) Calibration period 1 year.

### 5.4. Test Procedure

Testing must be done according to this procedure, KDB558074D01 - Guidance for Performing Compliance Measurements on Digital Transmission Systems (DTS) Operating Under §15.247. This is a recognized by the FCC. The tests below are run with the EUT's transmitter set at high power in TX mode. The EUT is needed to force selection of output power level and channel number. While testing, EUT was set to transmit continuously. Remove the Subjective device's antenna and connect the RF output port to power sensor. The maximum peak output power shall not exceed 1 watt.

According to KDB558074, This procedure shall be used when the measurement instrument has available a resolution bandwidth that is greater than the DTS bandwidth.

Set the RBW  $\geq$  DTS bandwidth.

Set VBW  $\geq$  3  $\times$  RBW.

Set span  $\geq$  3  $\times$  RBW

Sweep time = auto couple.

Detector = peak.

Trace mode = max hold.

Allow trace to fully stabilize.

Use peak marker function to determine the peak amplitude level.

**5.5. Test Result**

Model Number	BTV4			
Test Item	Maximum Conducted Output Power			
Test Mode	Mode 2:BLE Link mode			
Date of Test	2014/08/09			
Frequency (MHz)	Packet Type	Peak Power		Limit (mW)
		(dBm)	(mW)	
2402	/	-3.192	0.4795	< 1000
2440	/	-3.166	0.4824	
2480	/	-3.322	0.4654	

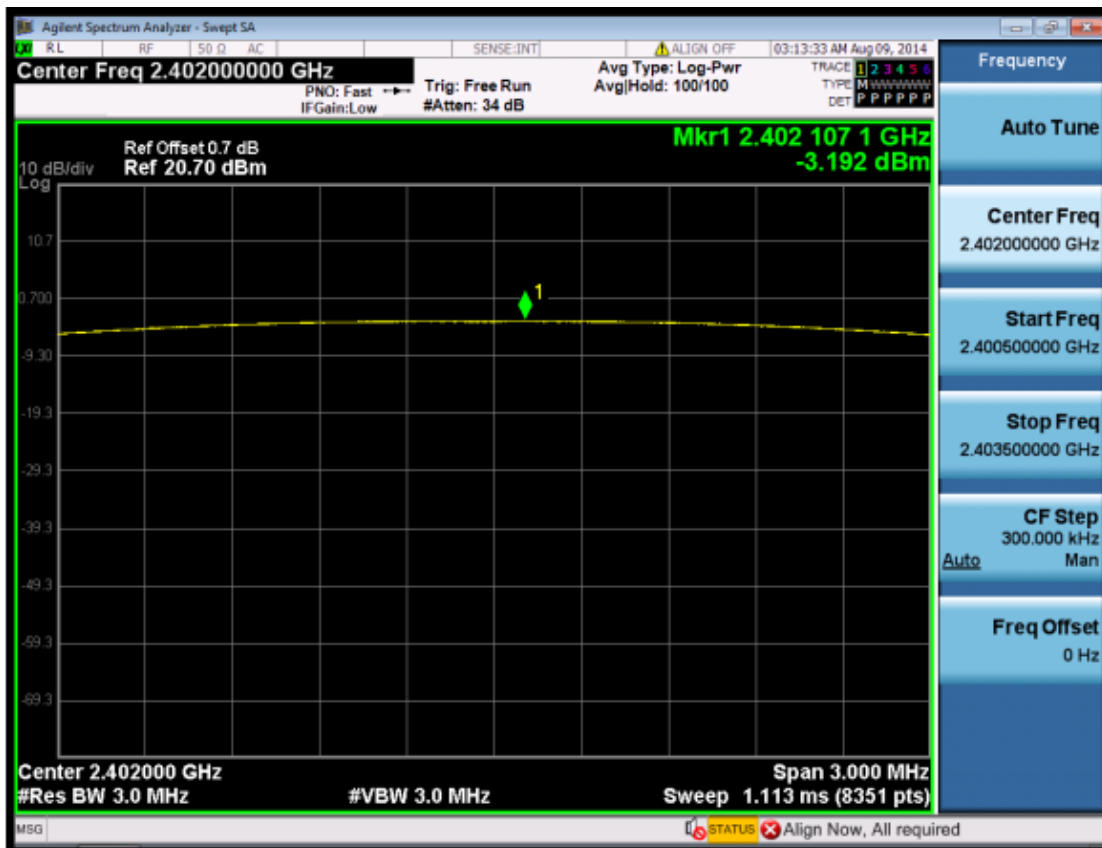
**5.6. Test Graphs**

Channel 00: 2402MHz @ GFSK



Channel 19: 2440 MHz @ GFSK

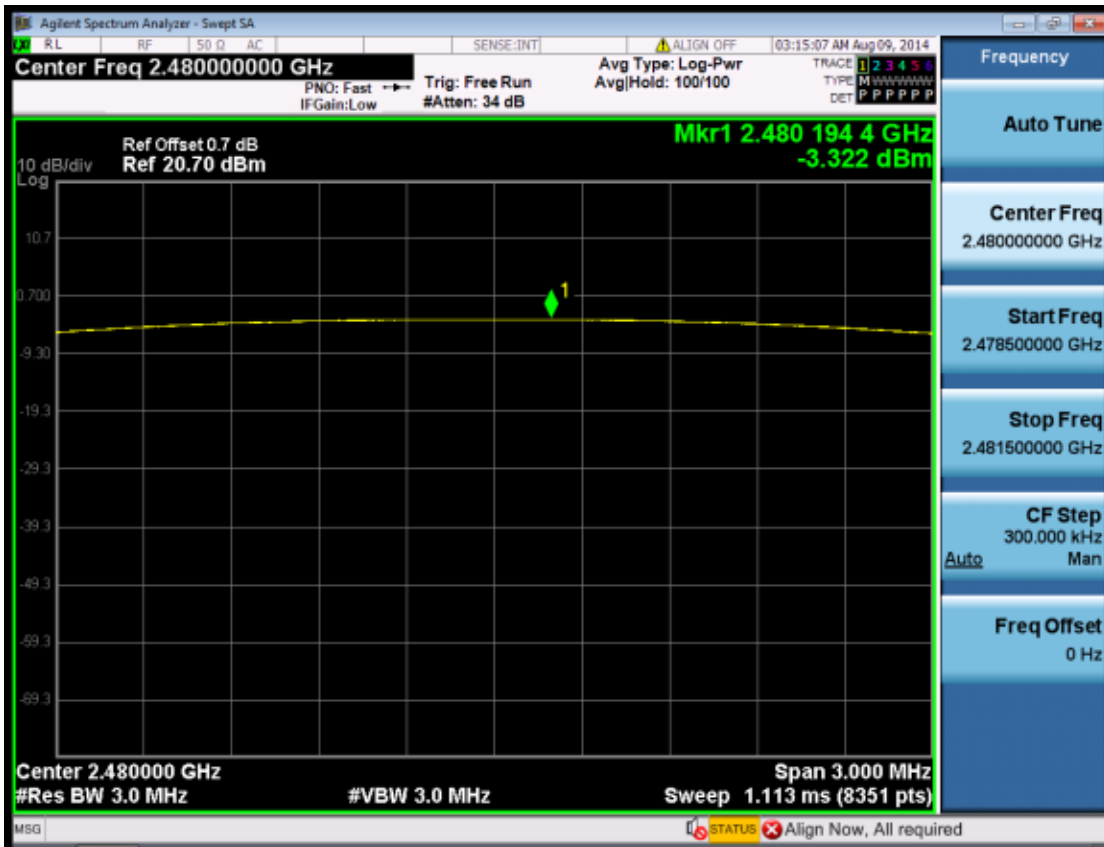

Channel 39: 2480 MHz @ GFSK

## 6 Conducted Emission Measurement

### 6.1. Limit

Frequency (MHz)	Quasi-peak	Average
0.15 - 0.5	66 to 56	56 to 46
0.50 - 5.0	56	46
5.0 - 30.0	60	50

### 6.2. Test Instruments

Describe	Manufacturer	Model Number	No.	Cal. Date	Remark
Test Receiver	R&S	ESCS	SB3319	01/20/2014	(1)
LISN	R&S	ESH2-Z5	SB3321	01/20/2014	(1)
LISN	R&S	ESH3-Z5	SB2604	01/20/2014	(1)
Test Software	R&S	ESK1	N/A	N/A	N/A

Remark: (1) Calibration period 1 year.

### 6.3. Test Setup

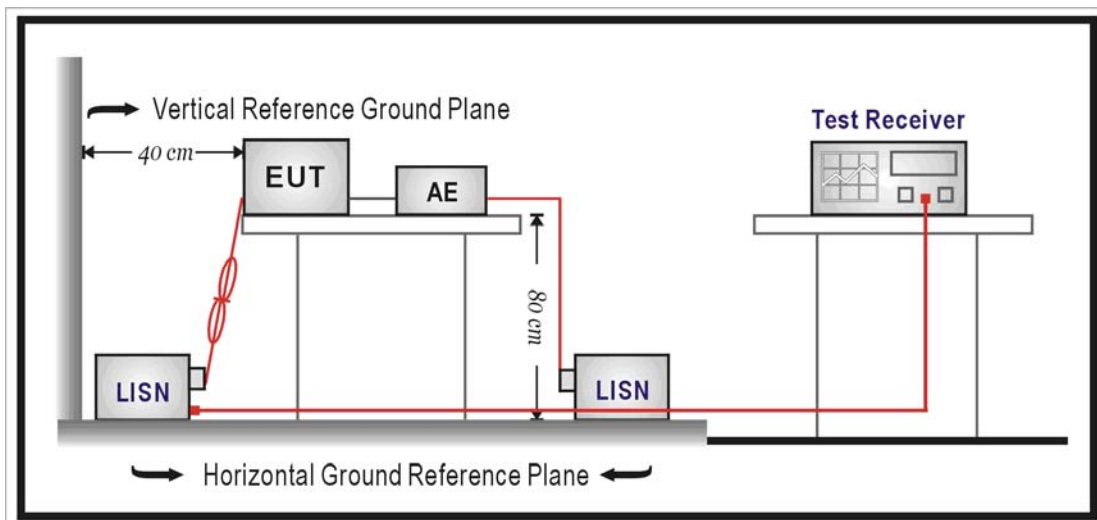

**6.4. Test Result**

Standard:	FCC 15.107	Line:	L1
Test item:	Conducted Emission	Power:	AC 120V/60Hz
Model Number:	BTV4	Temp.(°C)/Hum.(%RH):	18(°C)/50%RH
Mode:	2	Date:	2014/07/10
		Test By:	Fly Lu
Description: L line			

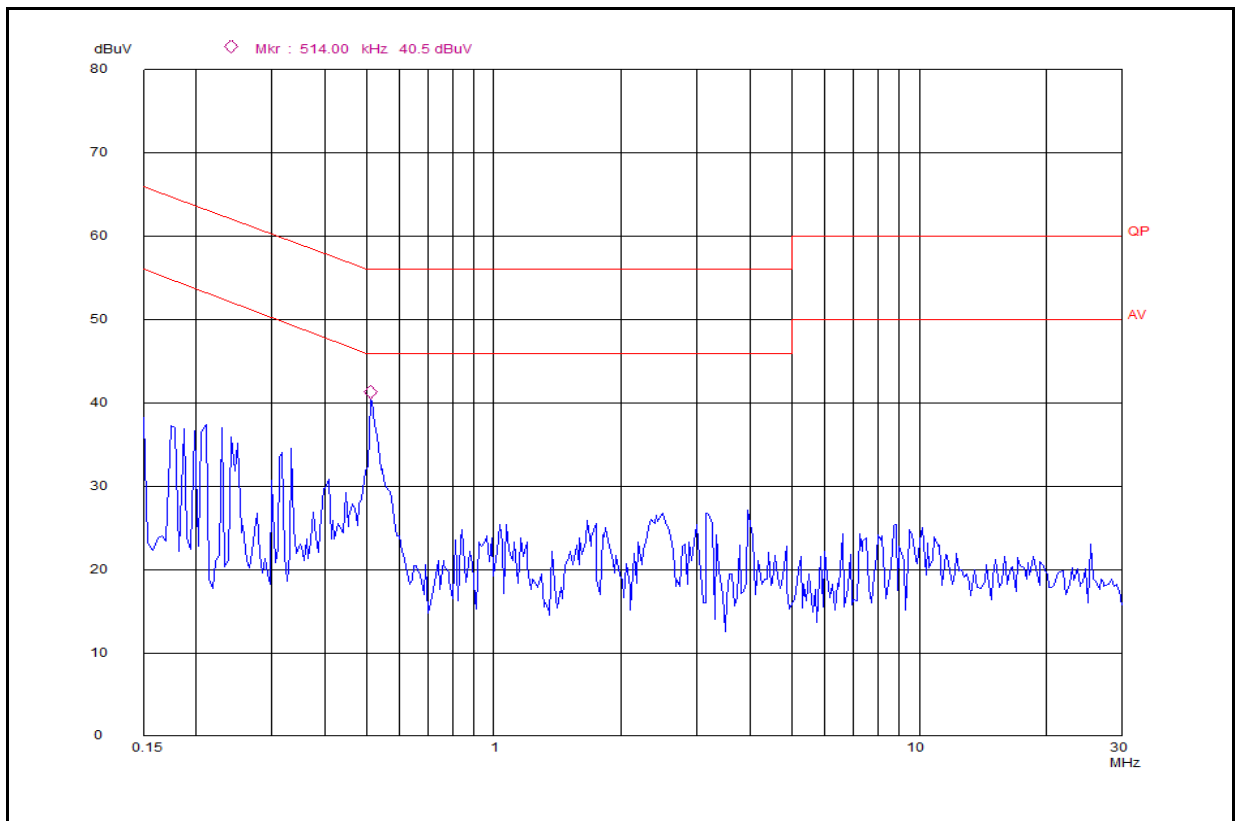

Frequency (MHz)	QP(dB $\mu$ V)		Ave.( dB $\mu$ V)	
	Level	Limit	Level	Limit
0.178	23.7	64.6	8.4	54.6
0.210	22.8	63.2	6.9	53.2
0.230	21.7	62.4	7.0	52.4
0.334	21.4	59.4	8.0	49.4
0.518	32.3	56.0	14.5	46.0
2.506	15.2	56.0	4.5	46.0

Standard:	FCC 15.207	Line:	N
Test item:	Conducted Emission	Power:	AC 120V/60Hz
Model Number:	BTV4	Temp.(°C)/Hum.(%RH):	18(°C)/50%RH
Mode:	2	Date:	2014/07/10
		Test By:	Fly Lu
Description: N line			

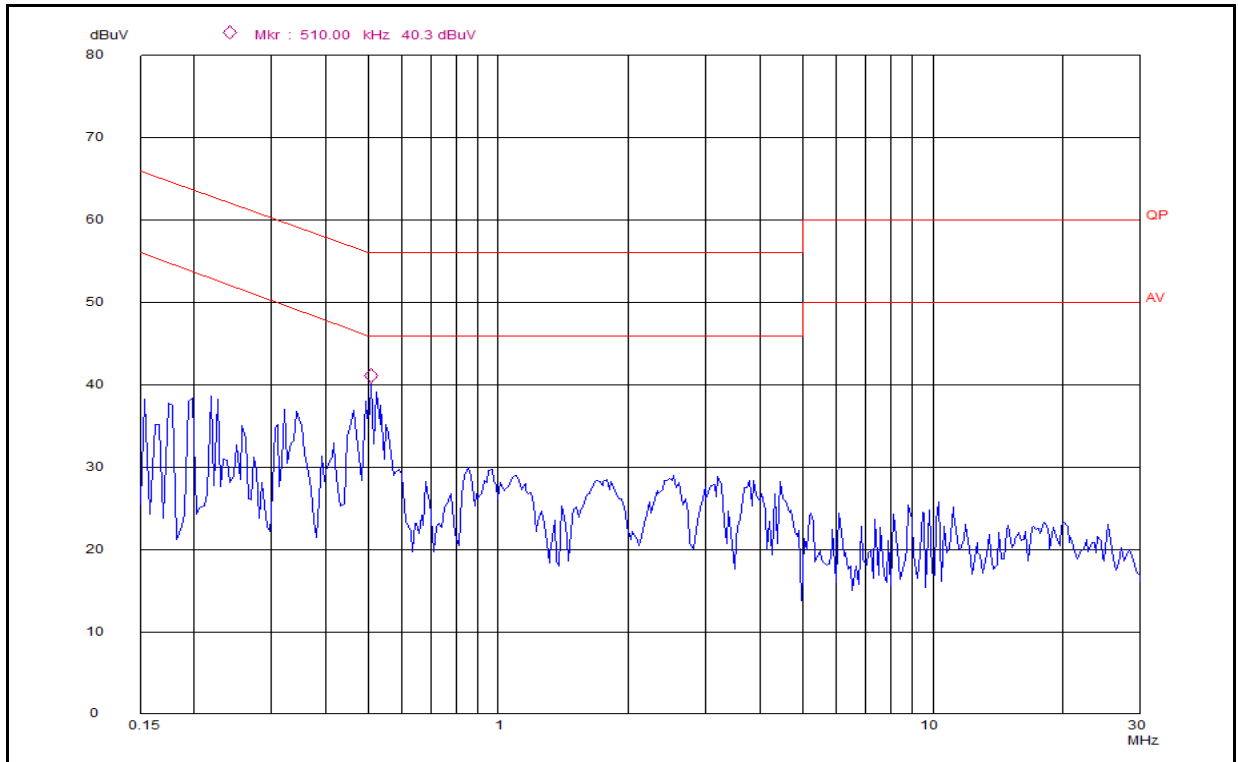

Frequency (MHz)	QP(dB $\mu$ V)		Ave.( dB $\mu$ V)	
	Level	Limit	Level	Limit
0.154	25.6	65.8	10.3	55.8
0.194	23.9	63.9	8.0	53.9
0.226	24.4	62.6	8.5	52.6
0.342	27.0	59.2	10.7	49.2
0.510	31.8	56.0	14.7	46.0
0.996	21.1	56.0	6.7	46.0

## 7 Radiated Interference Measurement

### 7.1. Limit

According to §15.209(a), except as provided elsewhere in this subpart, the emissions from an intentional radiator shall not exceed the field strength levels specified in the following table:

Frequency (MHz)	Field Strength ( $\mu\text{V/m}$ at meter)	Measurement Distance (meters)
0.009 – 0.490	2400 / F (kHz)	300
0.490 – 1.705	24000 / F (kHz)	30
1.705 – 30.0	30	30
30 - 88	100**	3
88-216	150**	3
216-960	200**	3
Above 960	500	3

\*\* Except as provided in paragraph (g), fundamental emissions from intentional radiators operating under this Section shall not be located in the frequency bands 54-72 MHz, 76-88 MHz, 174-216 MHz or 470-806 MHz. However, operation within these frequency bands is permitted under other sections of this Part, e.g., Sections 15.231 and 15.241.

### 7.2. Test Instruments

3 Meter Chamber					
Equipment	Manufacturer	Model Number	Number	Cal. Date	Remark
Loop Antenna	Schwarzbeck	FMZB1516	SB3345	01/22/2014	(1)
Horn Antenna	Amplifier Research	AT4560	SB3450/01	05/16/2014	(1)
Amplifier(18-40GHz)	R&S	---	SB3435/02	05/16/2014	(1)
Amplifier(1-18GHz)	R&S	---	SB3435/01	01/22/2014	(1)
Horn Antenna	R&S	HF907	SB8501/01	05/13/2014	(1)
Bilog Antenna	Schwarzbeck	VULB9163	SB8501/04	01/20/2014	(1)
EMI Test Receiver	R&S	ESU40	SB85001/09	05/16/2014	(1)
EMI Test Receiver	R&S	ESIB26	SB3253	01/22/2014	(1)
Test Software	R&S	ESK1	N/A	N/A	(1)
Test Software	R&S	EMC32	N/A	N/A	(1)

Remark: (1) Calibration period 1 year.



### 7.3. Setup

Below 1GHz

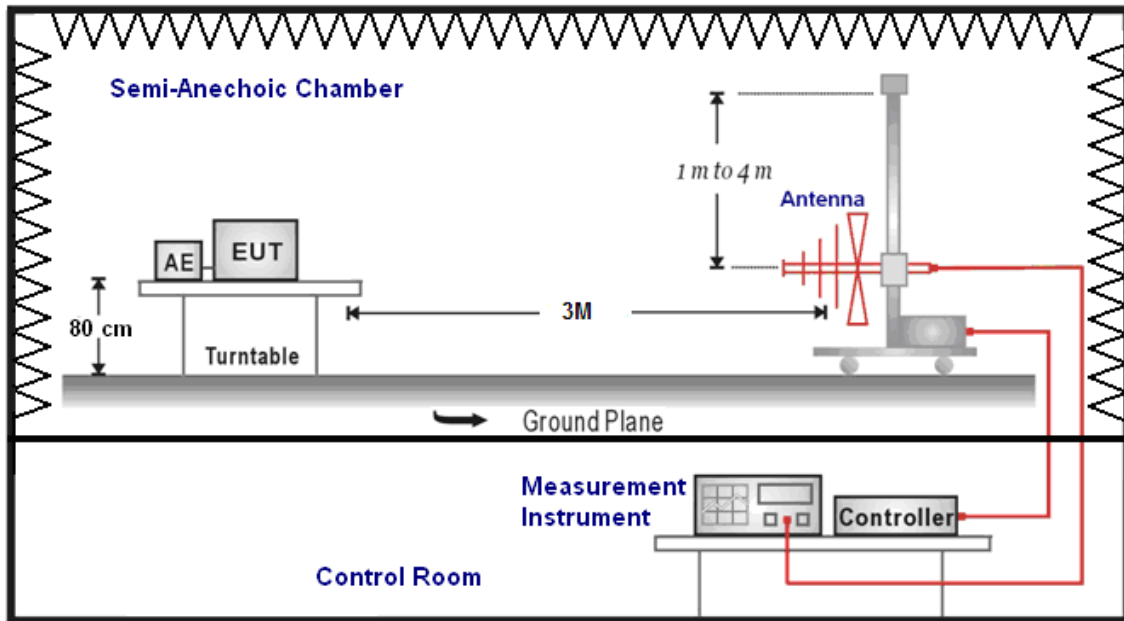

Above 1GHz

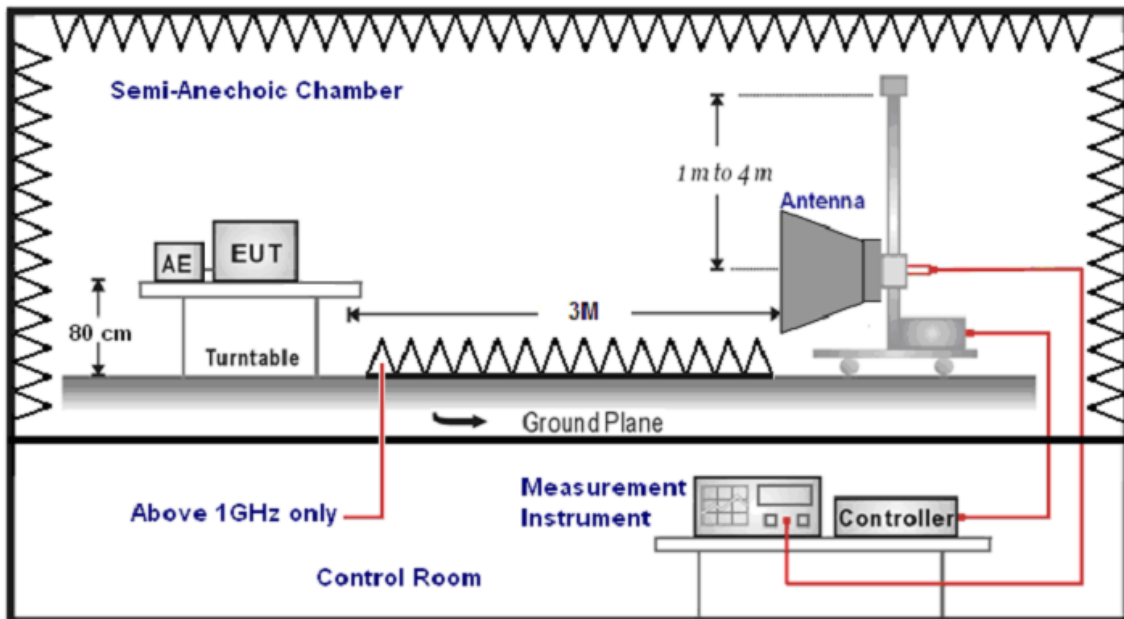

## 7.4. Test Procedure

Final radiation measurements were made on a three-meter, Semi Anechoic Chamber. The EUT system was placed on a nonconductive turntable which is 0.8 meters height, top surface 1.0 x 1.5 meter. The spectrum was examined from 250 MHz to 2.5 GHz in order to cover the whole spectrum below 10th harmonic which could generate from the EUT. During the test, EUT was set to transmit continuously & Measurements spectrum range from 9 kHz to 26.5 GHz is investigated.

For measurements below 1 GHz the resolution bandwidth is set to 100 kHz for peak detection measurements or 120 kHz for quasi-peak detection measurements. Peak detection is used unless otherwise noted as quasi-peak.

For measurements above 1 GHz the resolution bandwidth is set to 1 MHz, and then the video bandwidth is set to 1 MHz for peak measurements and 10 Hz for average measurements.

A nonconductive material surrounded the EUT to supporting the EUT for standing on three orthogonal planes. At each condition, the EUT was rotated 360 degrees, and the antenna was raised and lowered from one to four meters to find the maximum emission levels. Measurements were taken using both horizontal and vertical antenna polarization.

Biconilog Antenna (mode VULB9163) at 3 Meter and Horn antenna was used in frequencies 1 – 18 GHz at a distance of 3 meter while 18-40GHz at distance of 1 meter. All test results were extrapolated to equivalent signal at 3 meters utilizing an inverse linear distance extrapolation Factor (20dB/decade).

For testing above 1GHz, the emission level of the EUT in peak mode was 20dB lower than average limit (that means the emission level in peak mode also complies with the limit in average mode), then testing will be stopped and peak values of EUT will be reported, otherwise, the emissions will be measured in average mode again and reported.

Appropriate preamplifiers were used for improving sensitivity and precautions were taken to avoid overloading or desensitizing the spectrum analyzer. No post – detector video filters were used in the test.

The spectrum analyzer's 6 dB bandwidth was set to 1 MHz, and the analyzer was operated in the peak detection mode, for frequencies both below and up 1 GHz. The average levels were obtained by subtracting the duty cycle correction factor from the peak readings.

The following procedures were used to convert the emission levels measured in decibels referenced to 1 microvolt (dBuV) into field intensity in micro volts per meter (uV/m).

The actual field intensity in decibels referenced to 1 microvolt in to field intensity in micro volts per meter (dBuV/m).

The actual field intensity in referenced to 1 microvolt per meter (dBuV/m) is determined by algebraically adding the measured reading in dBuV, the antenna factor (dB), and cable loss (dB) and Subtracting the gain of preamplifier (dB) is auto calculate in spectrum analyzer.

$$(1) \text{ Amplitude (dBuV/m) = FI (dBuV) +AF (dBuV) +CL (dBuV)-Gain (dB)}$$

FI= Reading of the field intensity.

AF= Antenna factor.

CL= Cable loss.

P.S Amplitude is auto calculate in spectrum analyzer.

$$(2) \text{ Actual Amplitude (dBuV/m) = Amplitude (dBuV)-Dis(dB)}$$

The FCC specified emission limits were calculated according the EUT operating frequency and by following linear interpolation equations:

(a) For fundamental frequency : Transmitter Output < +30dBm

(b) For spurious frequency : Spurious emission limits = fundamental emission limit /10

Data of measurement within this frequency range without mark in the table above means the reading of emissions are attenuated more than 20dB below the permissible limits or the field strength is too small to be measured.

**7.5. Test Result**
**Below 1GHz**

Standard:	FCC Part 15C	Test Distance:	3m				
Test item:	Radiated Emission	Power:	DC 3.7V				
Model Number:	BTV4	Temp.(°C)/Hum.(%RH):	26(°C)/60%RH				
Mode:	Mode 1	Date:	2014/07/23				
Channel	2480MHz	Test By:	Fly Lu				
Frequency (MHz)	Reading (dBUV)	Correct Factor (dB/m)	Result (dB)	Limit (dBUV/m)	Margin (dB)	Remark	Ant.Polar. H / V
39.991	3.9	13.0	16.9	40.0	23.1	QP	H
90.237	6.3	13.0	19.3	43.5	24.2	QP	H
104.593	1.4	14.5	15.9	43.5	27.6	QP	H
238.938	5.1	13.0	18.1	46.0	27.9	QP	H
415.09	4.8	17.6	22.4	46.0	23.6	QP	H
764.775	7.9	22.4	30.3	46.0	15.7	QP	H
45.523	4.3	14.4	18.7	40.0	21.3	QP	V
54.056	3.9	14.1	18.0	40.0	22.0	QP	V
89.267	9.4	11.4	20.8	43.5	22.7	QP	V
173.756	4.4	10.5	14.9	43.5	28.6	QP	V
316.056	6.2	15.2	21.4	46.0	24.6	QP	V
641.197	7.0	21.6	28.6	46.0	17.4	QP	V

Standard:		FCC Part 15C		Test Distance:		3m	
Test item:		Radiated Emission		Power:		DC 3.7V	
Model Number:		BTV4		Temp.(°C)/Hum.(%RH):		26(°C)/60%RH	
Mode:		Mode 2		Date:		2014/07/23	
Channel		2440MHz		Test By:		Fly Lu	
Frequency (MHz)	Reading (dBuV)	Correct Factor (dB/m)	Result (dB)	Limit (dBuV/m)	Margin (dB)	Remark	Ant.Polar. H / V
146.40	2.81	13.07	15.88	43.5	27.62	QP	H
458.04	6.51	12.53	19.04	43.5	24.46	QP	H
192.96	6.41	11.51	17.92	43.5	25.58	QP	H
204.60	4.44	12.44	16.88	43.5	26.62	QP	H
536.34	1.64	21.08	22.72	46.0	23.28	QP	H
668.26	2.17	22.93	25.10	46.0	20.90	QP	H
37.76	8.41	16.41	24.82	40.0	15.18	QP	V
109.54	6.63	13.70	20.33	43.5	23.17	QP	V
131.85	2.71	14.24	16.95	43.5	26.55	QP	V
165.80	8.10	12.17	20.27	43.5	23.23	QP	V
173.56	6.97	11.71	18.68	43.5	24.82	QP	V
251.16	3.30	15.14	18.44	46.0	27.56	QP	V

Note: No emission found between lowest internal used/generated frequencies to 30MHz (9 kHz~30MHz).

**Above 1GHz**

Standard:	FCC Part 15C	Test Distance:	3m
Test item:	Radiated Emission	Power:	DC 3.7V
Model Number:	BTV4	Temp.(°C)/Hum.(%RH):	26(°C)/60%RH
Mode:	Mode 1	Date:	2014/07/23
		Test By:	Fly Lu

Frequency (MHz)	Reading (dBuV)	Correct Factor (dB/m)	Result (dBuV/m)	Limit (dBuV/m)	Margin (dB)	Remark	Ant.Polar. H / V
1227.799	50.5	-16.6	33.9	74	40.1	peak	H
1634.101	49.7	-14.0	35.7	74	38.3	peak	H
2521.501	51.7	-11.5	40.2	74	33.8	peak	H
4320.1	48.8	-5.7	43.1	74	30.9	peak	H
7488.899	52.1	-2.0	50.1	74	23.9	peak	H
13974.4	51.3	4.3	55.6	74	18.4	peak	H
1273.7	51.2	-16.5	34.7	74	39.3	peak	V
1923.1	50.3	-13.5	36.8	74	37.2	peak	V
2737.399	49.5	-10.2	39.3	74	34.7	peak	V
4119.5	50.7	-6.5	44.2	74	29.8	peak	V
5617.2	50.7	-4.0	46.7	74	27.3	peak	V
8524.2	51.2	-0.8	50.4	74	23.6	peak	V

Standard:	FCC Part 15C	Test Distance:	3m
Test item:	Radiated Emission	Power:	DC 3.7V
Model Number:	BTV4	Temp.(°C)/Hum.(%RH):	26(°C)/60%RH
Mode:	Mode 2	Date:	2014/07/23
Frequency:	2402 MHz	Test By:	Fly Lu

Frequency (MHz)	Reading (dBuV)	Correct Factor (dB/m)	Result (dBuV/m)	Limit (dBuV/m)	Margin (dB)	Remark	Ant.Polar. H / V
4804	26.6	5.8	34.4	74.0	39.6	peak	H
7206	34.0	6.8	40.8	74.0	33.2	peak	H
4804	29.2	5.8	35.0	74.0	39.0	peak	V
7206	32.9	6.8	39.7	74.0	34.3	peak	V

Standard:	FCC Part 15C	Test Distance:	3m
Test item:	Radiated Emission	Power:	DC 3.7V
Model Number:	BTV4	Temp.(°C)/Hum.(%RH):	26(°C)/60%RH
Mode:	Mode 2	Date:	2014/07/23
Frequency:	2440 MHz	Test By:	Fly Lu

Frequency (MHz)	Reading (dBuV)	Correct Factor (dB/m)	Result (dBuV/m)	Limit (dBuV/m)	Margin (dB)	Remark	Ant.Polar. H / V
4882	28.5	5.9	34.4	74.0	39.6	peak	H
7323	34.1	6.8	40.9	74.0	33.1	peak	H
4882	37.6	5.9	43.5	74.0	30.5	peak	V
7323	33.5	6.8	40.3	74.0	33.7	peak	V

Standard:	FCC Part 15C	Test Distance:	3m
Test item:	Radiated Emission	Power:	DC 3.7V
Model Number:	BTV4	Temp.(°C)/Hum.(%RH):	26(°C)/60%RH
Mode:	Mode 2	Date:	2014/07/23
Frequency:	2480 MHz	Test By:	Fly Lu

Frequency (MHz)	Reading (dBuV)	Correct Factor (dB/m)	Result (dBuV/m)	Limit (dBuV/m)	Margin (dB)	Remark	Ant.Polar. H / V
4960	28.8	5.9	34.7	74.0	39.3	peak	H
7440	33.3	6.8	40.1	74.0	33.9	peak	H
4960	29.4	5.9	35.3	74.0	38.7	peak	V
7440	33.6	6.8	40.4	74.0	33.6	peak	V

## 8 20dB RF Bandwidth Measurement

### 8.1. Limit

N/A

### 8.2. Test Setup

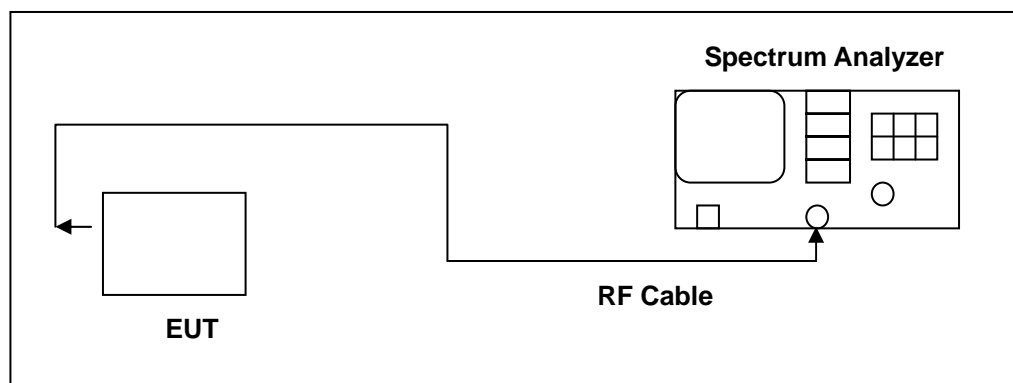

### 8.3. Test Instruments

Equipment	Manufacturer	Model Number	Serial Number	Cal. Date	Remark
Signal Analyzer	Agilent	N9020A	MY53420615	12/19/2013	(1)

Remark: (1) Calibration period 1 year.

### 8.4. Test Procedure

#### 20dB RF Bandwidth

Testing must be done according to this procedure, FCC Public Notice DA 00-705 - Filing and Measurement Guidelines for Frequency Hopping Spread Spectrum Systems. This is the only method recognized by the FCC. The RF output port of the Equipment-Under-Test is directly coupled to the input of the EMC analyzer through a specialized RF connector and a 10dB passive attenuator. A fully charged battery was used for the supply voltage. The Bluetooth frequency hopping function of the EUT was enabled. The spectrum analyzer used the following settings:

1. Span = approx. 2 to 3 times the 20dB bandwidth, centered on a hopping frequency
2. RBW  $\geq$  1% of the 20dB span
3. VBW  $\geq$  RBW
4. Sweep = auto
5. Detector function = peak
6. Trace = max hold

The trace was allowed to stabilize. The EUT was transmitting at its maximum data rate. The marker-to-peak function was used to set the marker to the peak of the emission. The marker-delta function was used to measure 20dB down one side of the emission. The marker-delta function and marker was moved to the other side of the emission until it was even with the reference marker. The marker-delta reading at this point was the 20dB bandwidth of the emission.

### 8.5. Test Result

Model Number	BTV4		
Test Item	6dB RF Bandwidth and 99 % Occupied Bandwidth		
Test Mode	Mode 2: BLE Link Mode		
Date of Test	2014/08/09		
Frequency (MHz)	6dB RF Bandwidth (MHz)	99 % Occupied Bandwidth (MHz)	Limit (MHz)
2402	0.6974	1.0276	----
2440	0.7010	1.0279	----
2480	0.7019	1.0301	----

### 8.6. Test Graphs

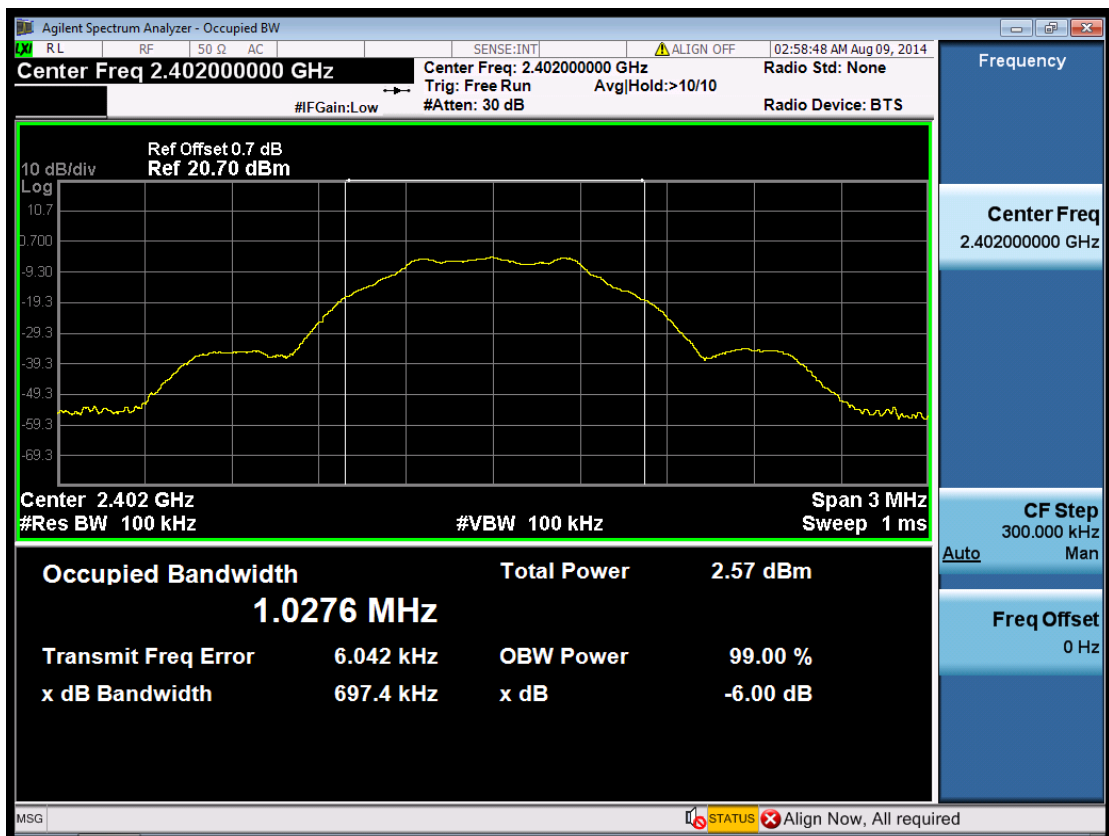

Channel 00: 2402 MHz @ GFSK





Channel 19: 2440 MHz @ GFSK



Channel 139: 2480 MHz @ GFSK

## 9 Maximum Power Density Measurement

### 9.1. Limit

For digitally modulated systems, the power spectral density conducted from the intentional radiator to the antenna shall not be greater than 8 dBm in any 3 kHz band during any time interval of continuous transmission.

### 9.2. Test Setup

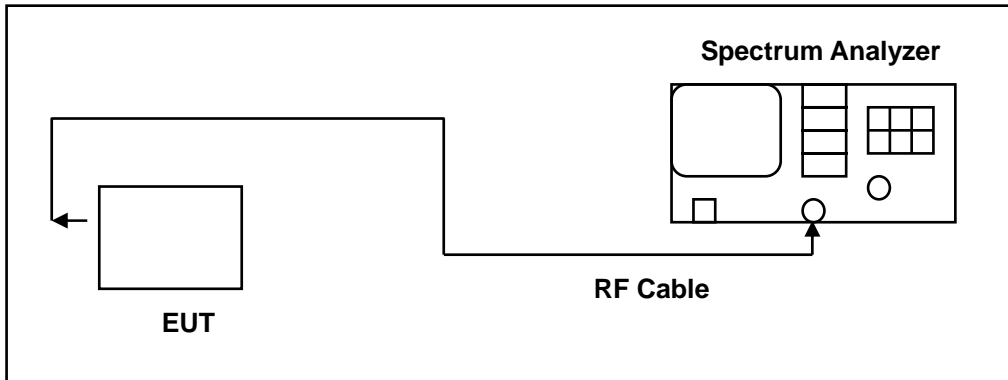

### 9.3. Test Instruments

Equipment	Manufacturer	Model Number	Serial Number	Cal. Date	Remark
Signal Analyzer	Agilent	N9020A	MY53420615	12/19/2013	(1)

Remark: (1) Calibration period 1 year.

### 9.4. Test Procedure

The EUT was setup to ANSI C63.4, 2009; tested to DTS test procedure of KDB558074D01 for compliance to FCC 47CFR 15.247 requirements.

1. Set analyzer center frequency to DTS channel center frequency.
2. Set the span to 1.5 times the DTS bandwidth.
3. Set the RBW to:  $3 \text{ kHz} \leq \text{RBW} \leq 100 \text{ kHz}$ .
4. Set the VBW  $\geq 3 \times \text{RBW}$ .
5. Detector = peak.
6. Sweep time = auto couple.
7. Trace mode = max hold.
8. Allow trace to fully stabilize.
9. Use the peak marker function to determine the maximum amplitude level within the RBW.
10. If measured value exceeds limit, reduce RBW (no less than 3 kHz) and repeat.

**9.5. Test Result**

Model Number	BTV4		
Test Item	Maximum Power Density		
Test Mode	Mode 2 BLE Link Mode		
Date of Test	08/09/2014	Test Site	TE05
Frequency (MHz)	Measurement Values		Limit (dBm)
2402	-7.622		< 8
2440	-7.620		< 8
2480	-7.765		< 8

**9.6. Test Graphs**

Channel 00: 2402 MHz @ GFSK



Channel 19: 2440 MHz @ GFSK



Channel 39: 2480 MHz @ GFSK

## 10 Out of Band Conducted Emissions Measurement

### 10.1. Limit

In any 100 kHz bandwidth outside the frequency band in which the spread spectrum or digitally modulated intentional radiator is operating, the radio frequency power that is produced by the intentional radiator shall be at least 20 dB below that in the 100 kHz bandwidth within the band that contains the highest level of the desired power

### 10.2. Test Setup

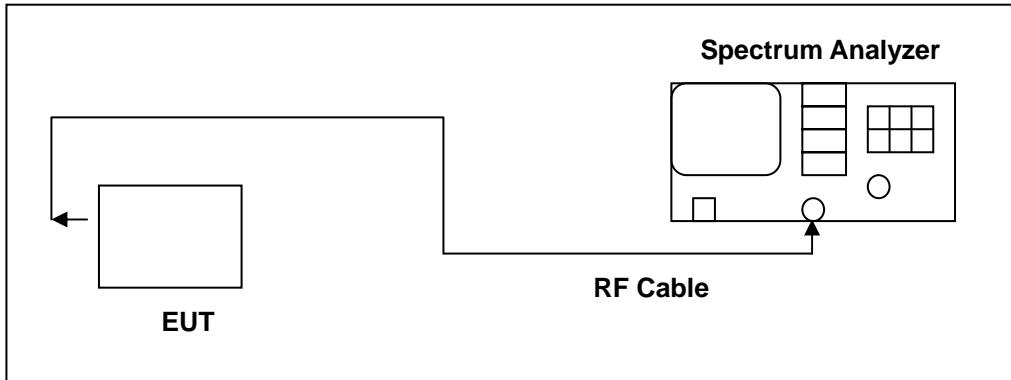

### 10.3. Test Instruments

Equipment	Manufacturer	Model Number	Serial Number	Cal. Date	Remark
Signal Analyzer	Agilent	N9020A	MY53420615	12/19/2013	(1)

Remark: (1) Calibration period 1 year.

### 10.4. Test Procedure

Testing must be done according to this procedure, FCC Public Notice DA 00-705 - Filing and Measurement Guidelines for Frequency Hopping Spread Spectrum Systems. This is the only method recognized by the FCC. In any 100 kHz bandwidth outside the EUT pass band, the RF power produced by the modulation products of the spreading sequence, the information sequence, and the carrier frequency shall be at least 20 dB below that of the maximum in-band 100 kHz emission, antenna output of the EUT was coupled directly to spectrum analyzer; if an external attenuator and/or cable was used, these losses are compensated for with the analyzer OFFSET function. All other types of emissions from the EUT shall meet the general limits for radiated frequencies outside the pass band. The test was performed at 3 channels (Channel 0, 19, 39)

## 10.5. Test Graphs

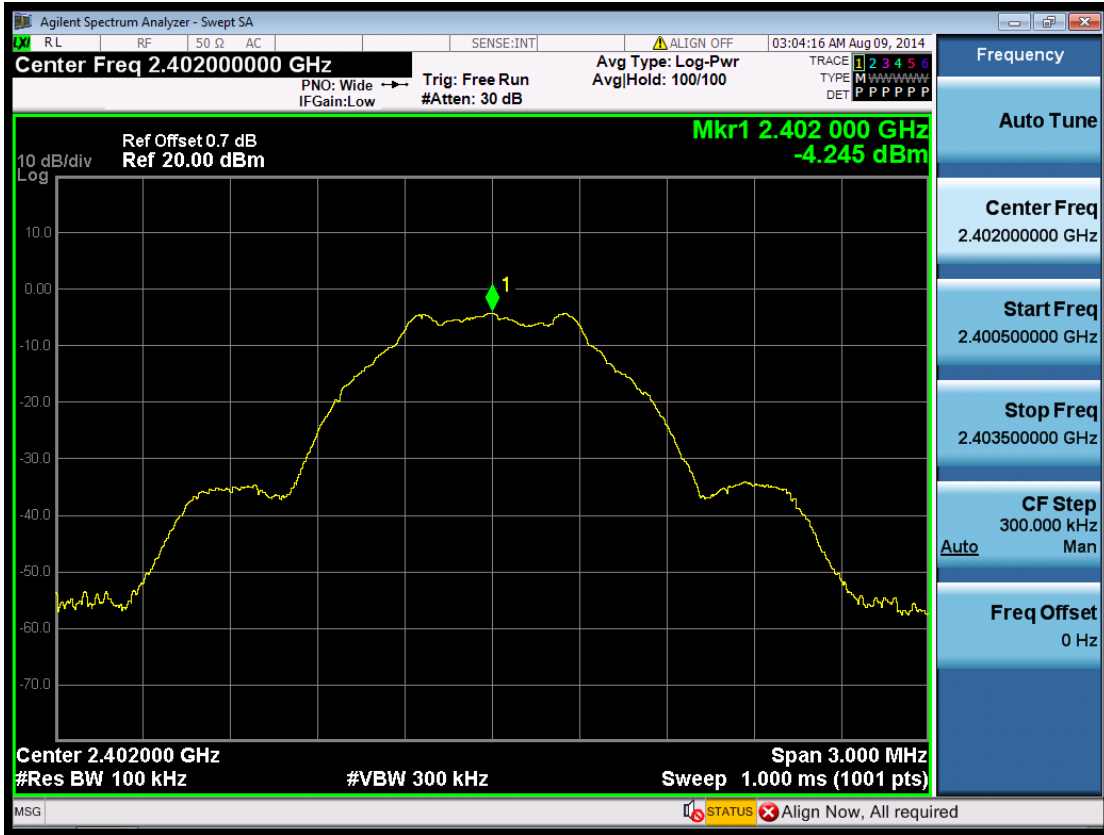

Channel 00: 2402 MHz @ GFSK

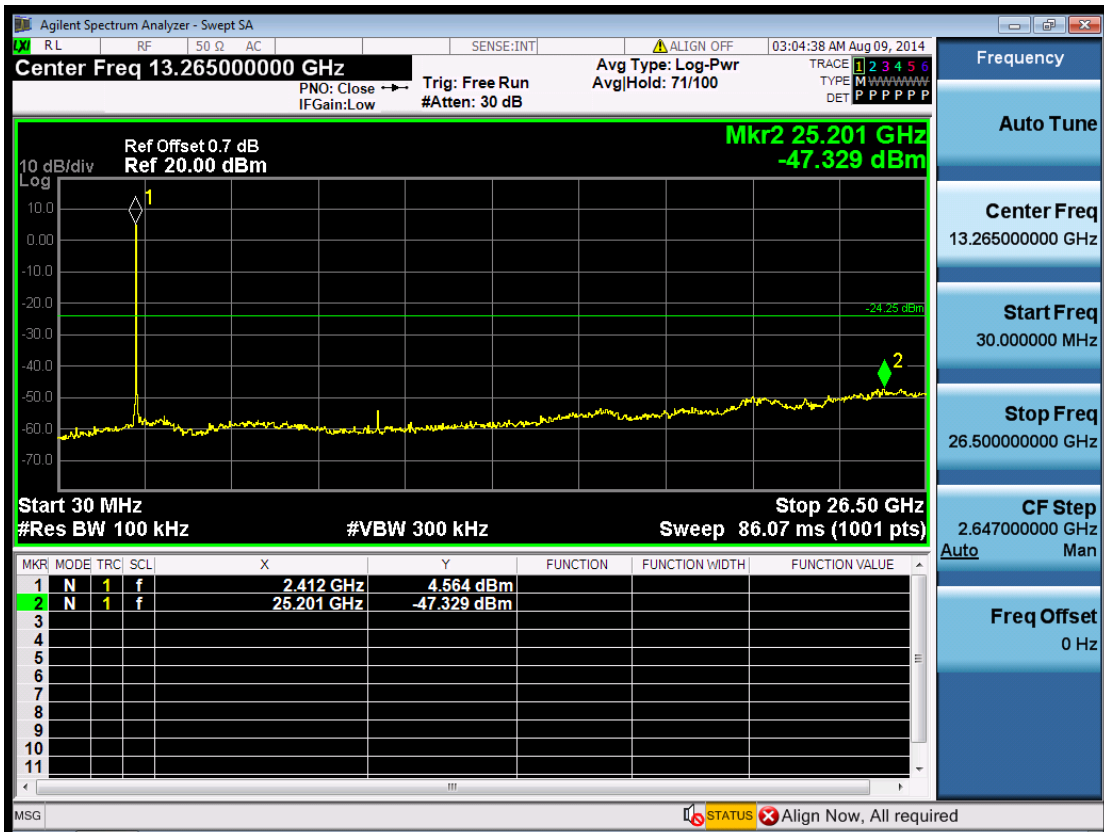

Channel 00: 2402 MHz @ GFSK

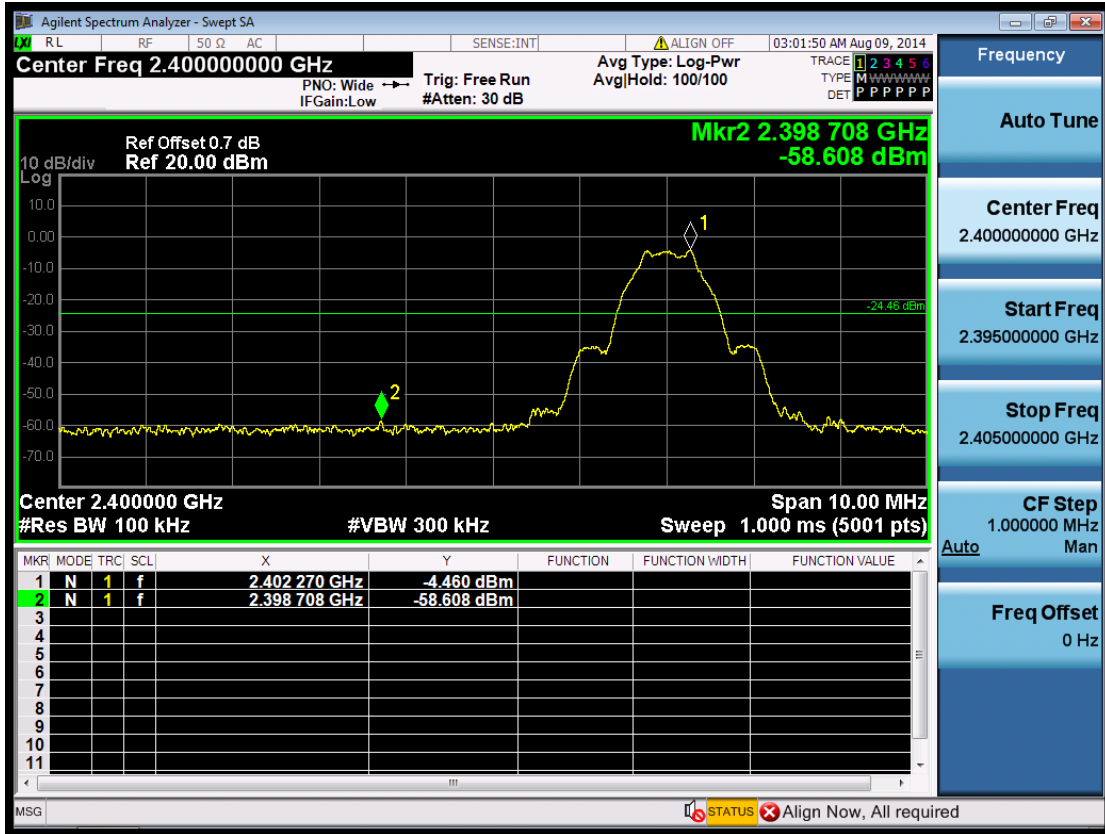

Channel 00: 2402 MHz @ GFSK

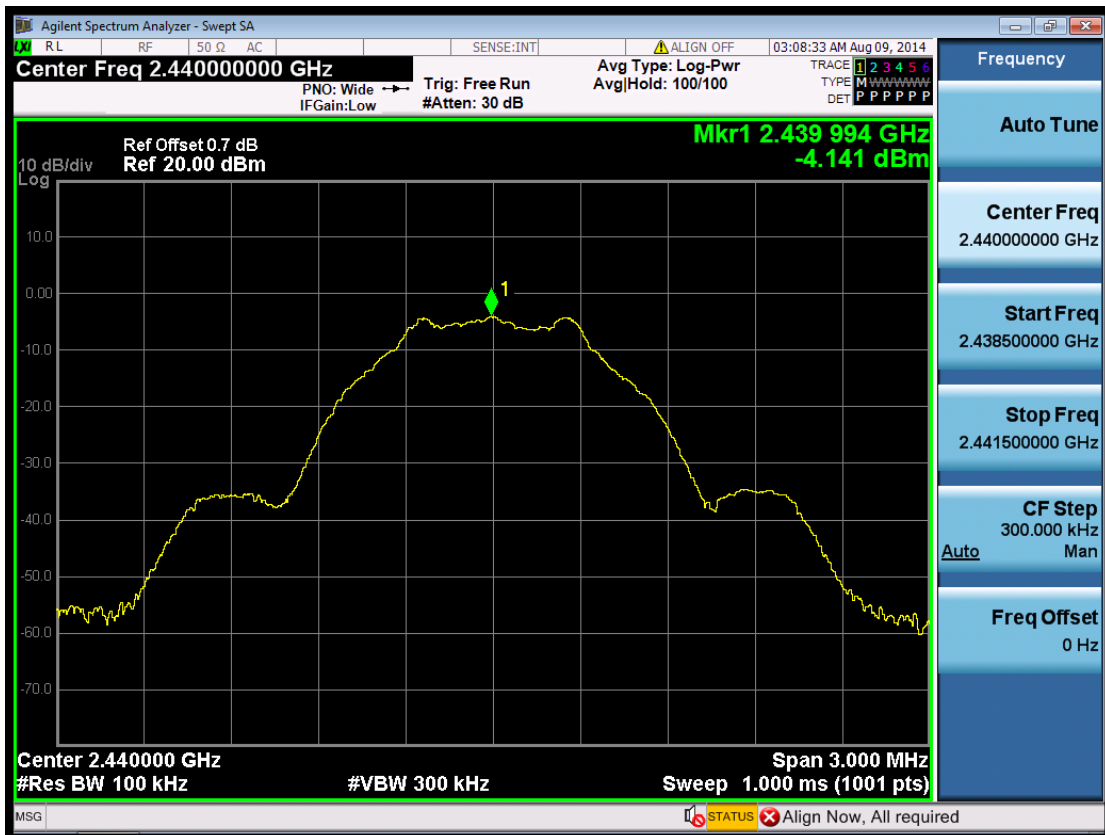

Channel 19: 2440 MHz @ GFSK



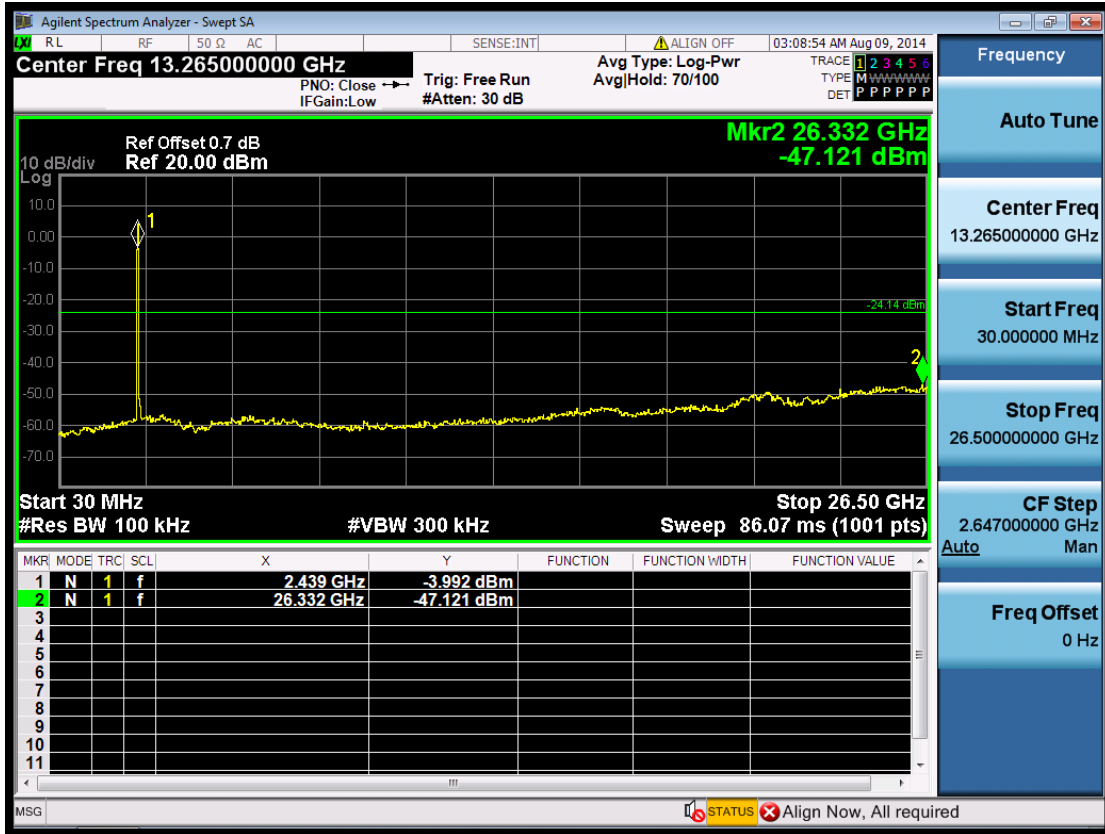

Channel 19: 2440 MHz @ GFSK

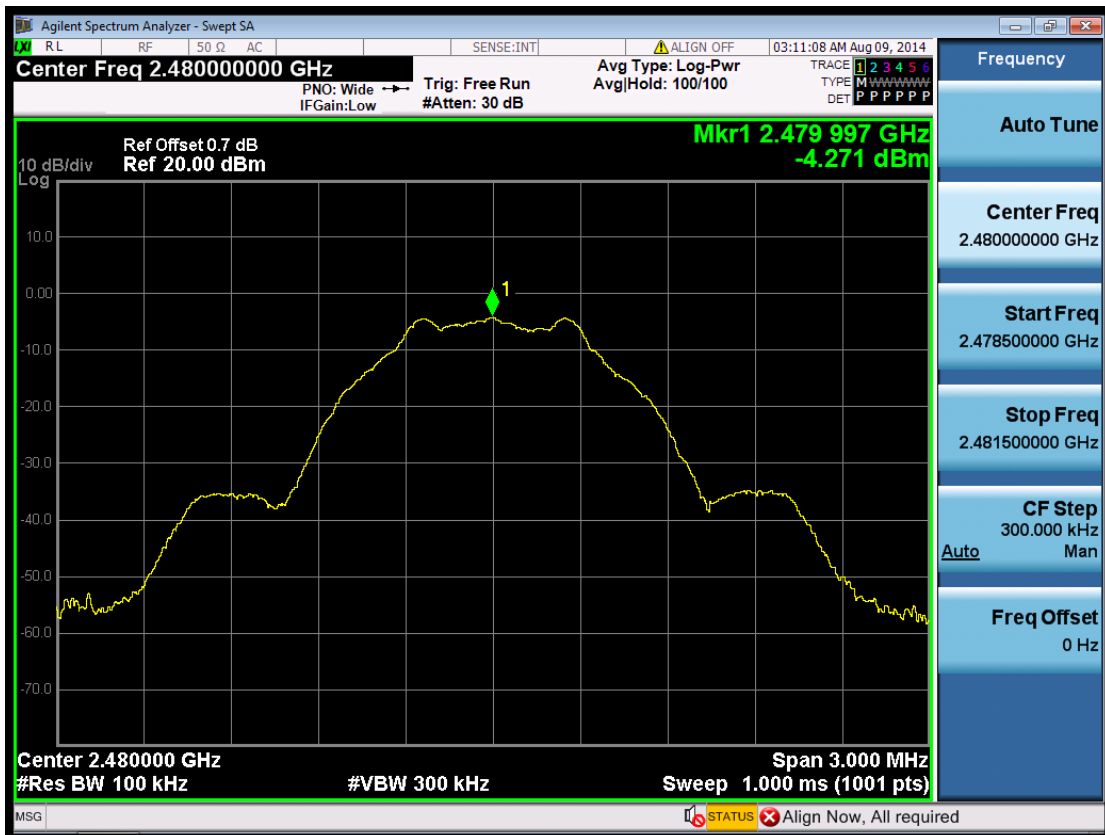

Channel 39: 2480 MHz @ GFSK



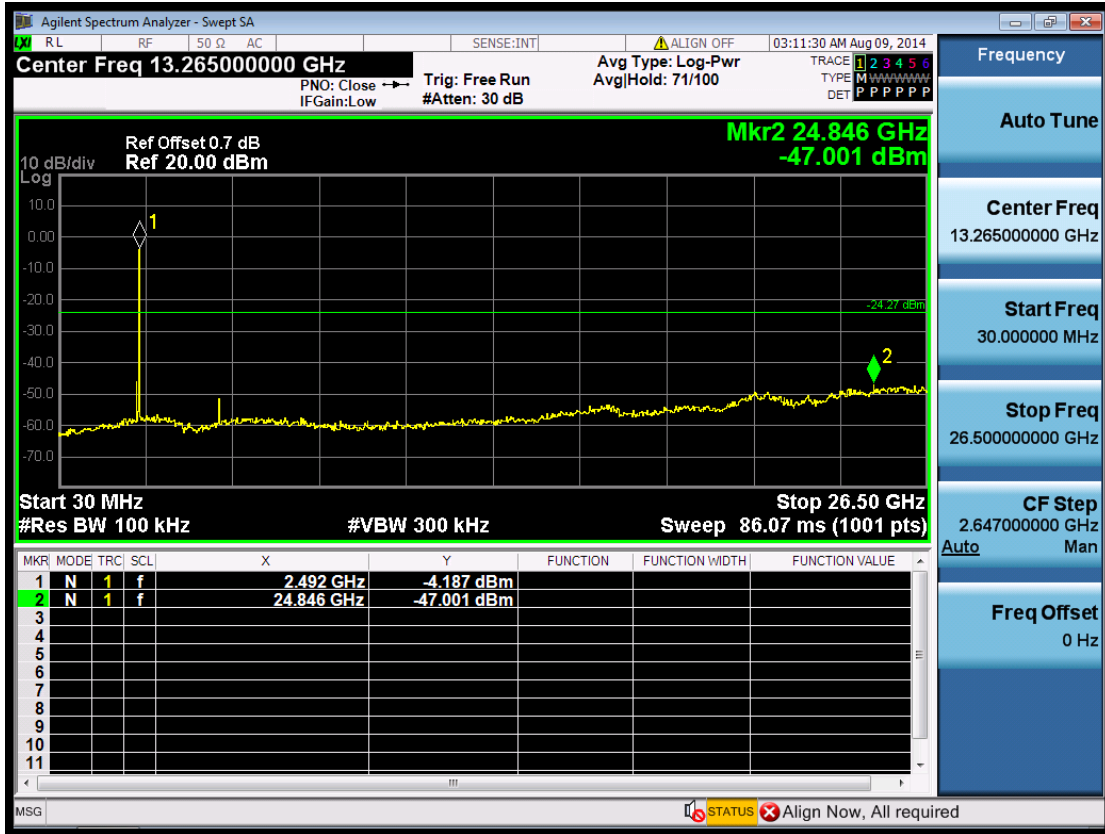

Channel 39: 2480 MHz @ GFSK

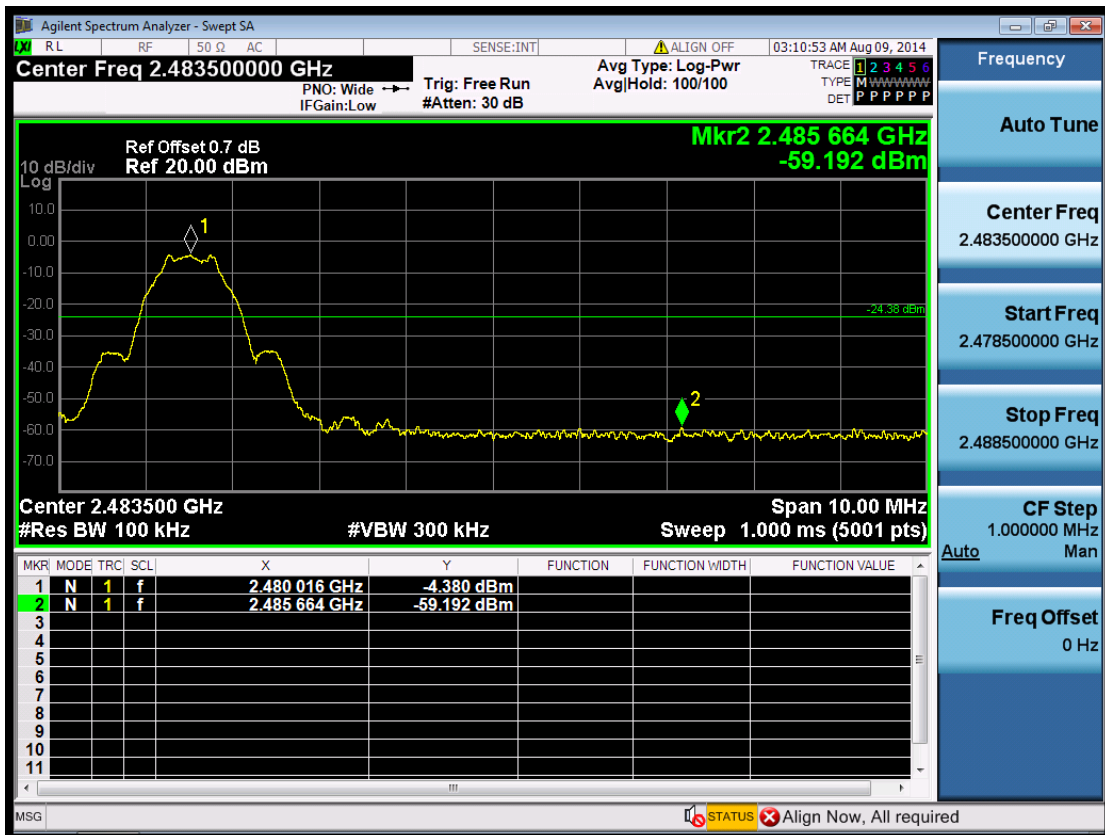

Channel 39: 2480 MHz @ GFSK

## 11 Band Edges Measurement

### 11.1. Limit

In any 100 kHz bandwidth outside the frequency band in which the spread spectrum or digitally modulated intentional radiator is operating, the radio frequency power that is produced by the intentional radiator shall be at least 20 dB below that in the 100 kHz bandwidth within the band that contains the highest level of the desired power

### 11.2. Test Setup

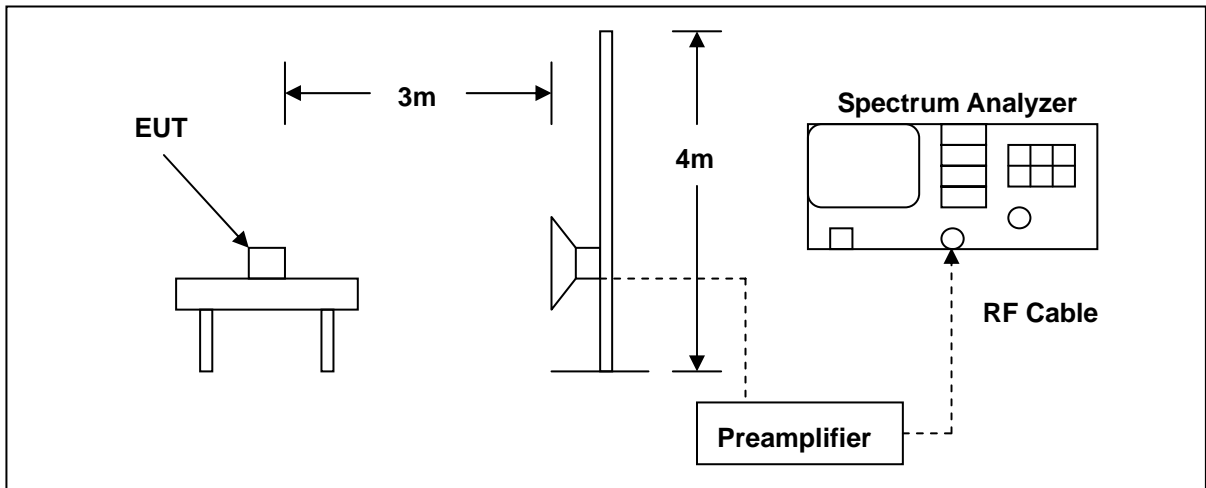

### 11.3. Test Instruments

3 Meter Chamber					
Equipment	Manufacturer	Model Number	Number	Cal. Date	Remark
Loop Antenna	Schwarzbeck	FMZB1516	SB3345	01/22/2014	(1)
Horn Antenna	Amplifier Research	AT4560	SB3450/01	05/16/2014	(1)
Amplifier(18-40GHz)	R&S	---	SB3435/02	05/16/2014	(1)
Amplifier(1-18GHz)	R&S	---	SB3435/01	01/22/2014	(1)
Horn Antenna	R&S	HF907	SB8501/01	05/13/2014	(1)
Bilog Antenna	Schwarzbeck	VULB9163	SB8501/04	01/20/2014	(1)
EMI Test Receiver	R&S	ESU40	SB85001/09	05/16/2014	(1)
EMI Test Receiver	R&S	ESIB26	SB3253	01/22/2014	(1)
Test Software	R&S	ESK1	N/A	N/A	(1)
Test Software	R&S	EMC32	N/A	N/A	(1)

Remark: (1) Calibration period 1 year.

#### **11.4. Test Procedure**

Testing must be done according to this procedure, KDB558074D01 - Guidance for Performing Compliance Measurements on Digital Transmission Systems (DTS) Operating Under §15.247. This is a method recognized by the FCC. The emissions on the harmonics frequencies, the limits, and the margin of compliance are presented. These tests were made when the transmitter was in full radiated power. The additional test was performed to show compliance with the requirement at the band-edge frequency 2483.5 MHz and up to 2500 MHz and at 2390.0 MHz. The transmitter was configured with the worst case antenna and setup to transmit at the highest channel. Then the field strength was measured at 2483.5 MHz.

The transmitter was then configured with the worst case antenna and setup to transmit at the lowest channel. Then the field strength was measured at 2390.0 MHz.

For measurements the resolution bandwidth is set to 1 MHz, and then the video bandwidth is set to 1 MHz for peak measurements and 10 Hz for average measurements.

**11.5. Test Result**

Standard:	FCC Part 15C	Test Distance:	3m
Test item:	Radiated Emission	Power:	DC 3.7V
Model Number:	BTV4	Temp.(°C)/Hum.(%RH):	26(°C)/60%RH
Mode:	Mode 2	Date:	2014/07/23
Frequency:	2402 MHz	Test By:	
Ant.Polar.:	Horizontal		

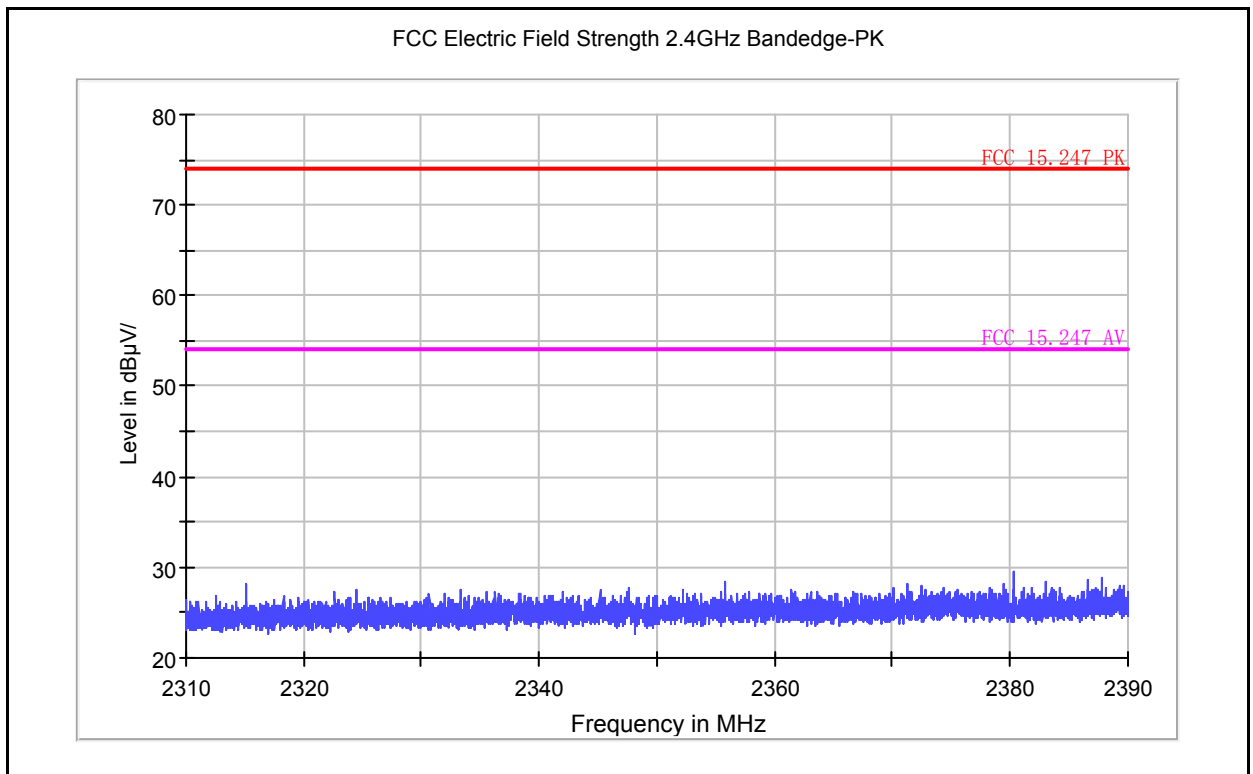

Standard:	FCC Part 15C	Test Distance:	3m
Test item:	Radiated Emission	Power:	DC 3.7V
Model Number:	BTV4	Temp.(°C)/Hum.(%RH):	26(°C)/60%RH
Mode:	Mode 2	Date:	2014/07/23
Frequency:	2402 MHz	Test By:	
Ant.Polar.:	Vertical		

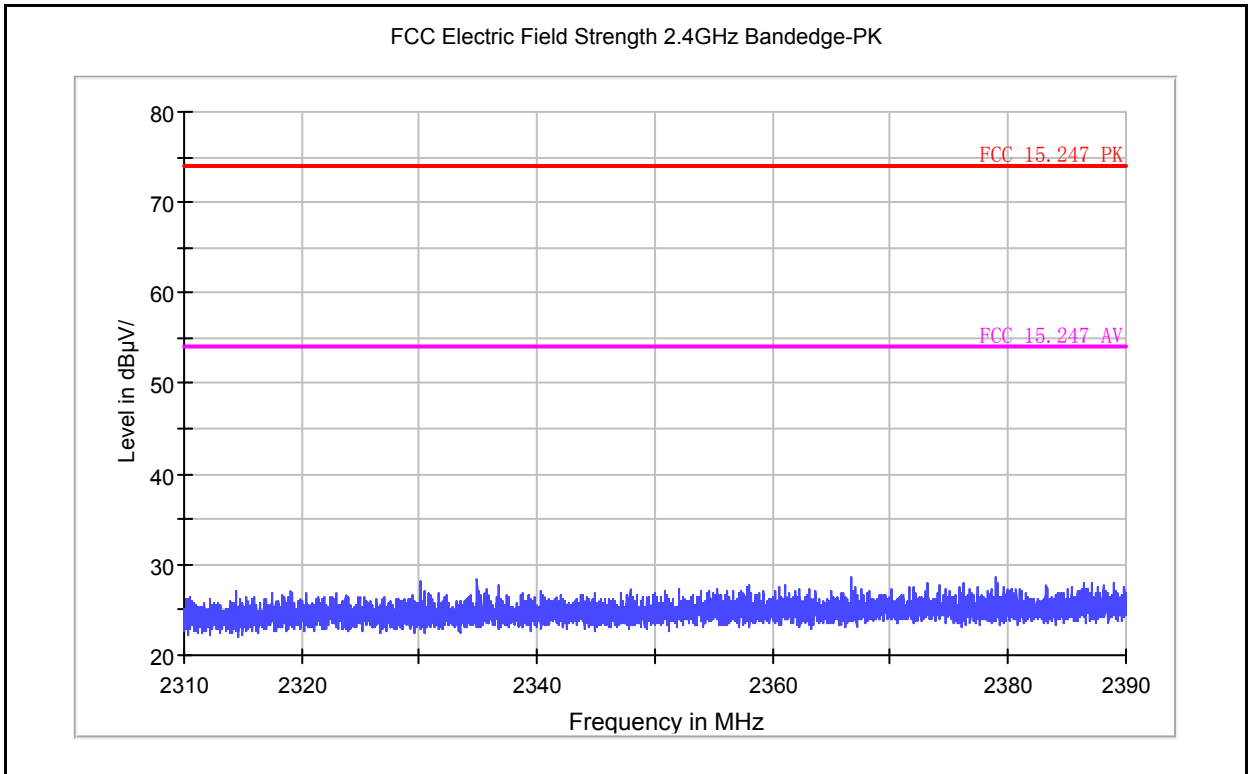

Standard:	FCC Part 15C	Test Distance:	3m
Test item:	Radiated Emission	Power:	DC 3.7V
Model Number:	BTV4	Temp.(°C)/Hum.(%RH):	26(°C)/60%RH
Mode:	Mode 2	Date:	2014/07/23
Frequency:	2480 MHz	Test By:	
Ant.Polar.:	Horizontal		

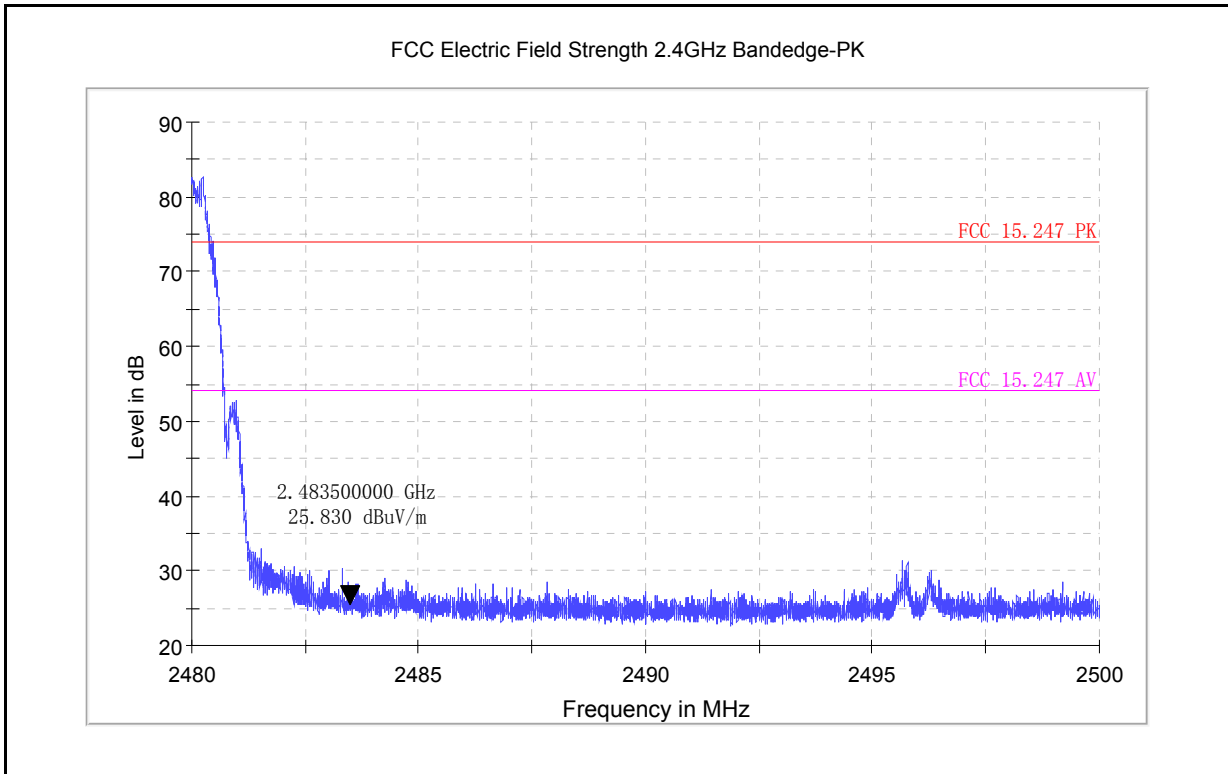

Standard:	FCC Part 15C	Test Distance:	3m
Test item:	Radiated Emission	Power:	DC 3.7V
Model Number:	BTV4	Temp.(°C)/Hum.(%RH):	26(°C)/60%RH
Mode:	Mode 2	Date:	2014/07/23
Frequency:	2480 MHz	Test By:	
Ant.Polar.:	Vertical		

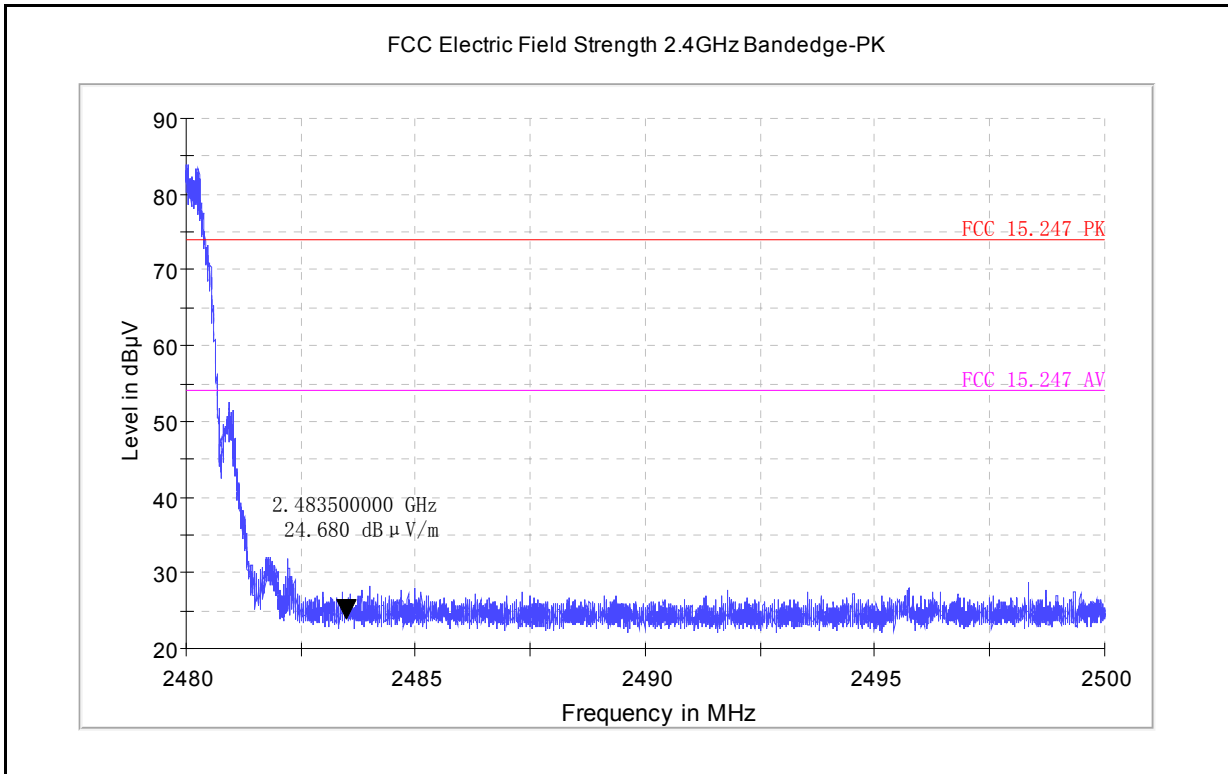

## **12 Antenna Measurement**

### **12.1. Limit**

For intentional device, according to 15.203, an intentional radiator shall be designed to ensure that no antenna other than that furnished by the responsible party shall be used with the device.

And According to 15.247 (b), if transmitting antennas of directional gain greater than 6 dBi are used, the power shall be reduced by the amount in dB that the directional gain of the antenna exceeds 6dBi.

### **12.2. Antenna Connector Construction**

The antenna used in this product is internal PCB antenna. And the maximum Gain of this antenna is 0.0 dBi.