



# FCC Radio Test Report

## FCC ID: 2AAP800001

This report concerns (check one):  Original Grant  Class II Change

**Issued Date** : Sep. 27, 2013  
**Project No.** : 1309C052  
**Equipment** : Portable Bluetooth Speaker  
**Model Name** : BTV1  
**Applicant** : Guoguang Electric Co.,Ltd  
**Address** : No.8 Jinghu Road, Xinhua Street, Huadu  
Reg, Guangzhou, China

**Tested by:** Neutron Engineering Inc. EMC Laboratory  
**Date of Receipt:** Sep. 12, 2013  
**Date of Test:** Sep. 12, 2013~Sep. 26, 2013

**Testing Engineer** : David Mao  
(David Mao)  
**Technical Manager** : Leo Hung  
(Leo Hung)  
**Authorized Signatory** : Steven Lu  
(Steven Lu)

### Neutron Engineering Inc.

No.3,Jinshagang 1st Road, ShiXia,  
Dalang Town, Dong Guan, China.

TEL: 0769-8318-3000

FAX: 0769-8319-6000



### **Declaration**

**Neutron** represents to the client that testing is done in accordance with standard procedures as applicable and that test instruments used has been calibrated with the standards traceable to National Measurement Laboratory (**NML**) of **CHINA**, or National Institute of Standards and Technology (**NIST**) of **U.S.A.**

**Neutron's** reports apply only to the specific samples tested under conditions. It is manufacture's responsibility to ensure that additional production units of this model are manufactured with the identical electrical and mechanical components. **Neutron** shall have no liability for any declarations, inferences or generalizations drawn by the client or others from **Neutron** issued reports.

**Neutron's** reports must not be used by the client to claim product endorsement by the authorities or any agency of the Government.

This report is the confidential property of the client. As a mutual protection to the clients, the public and **Neutron-self**, extracts from the test report shall not be reproduced except in full with **Neutron's** authorized written approval.

**Neutron's** laboratory quality assurance procedures are in compliance with the **ISO Guide 17025** requirements, and accredited by the conformity assessment authorities listed in this test report.

### **Limitation**

For the use of the authority's logo is limited unless the Test Standard(s)/Scope(s)/Item(s) mentioned in this test report is (are) included in the conformity assessment authorities acceptance respective.



**REPORT ISSUED HISTORY**

Issued No.	Description	Issued Date
NEI-FCCP-1-1309C052	Original Issue.	Sep. 27, 2013



<b>Table of Contents</b>	<b>Page</b>
<b>1 . CERTIFICATION</b>	<b>6</b>
<b>2 . SUMMARY OF TEST RESULTS</b>	<b>7</b>
2.1 TEST FACILITY	8
2.2 MEASUREMENT UNCERTAINTY	8
<b>3 . GENERAL INFORMATION</b>	<b>9</b>
3.1 GENERAL DESCRIPTION OF EUT	9
3.2 DESCRIPTION OF TEST MODES	11
3.3 TABLE OF PARAMETERS OF TEXT SOFTWARE SETTING	11
3.4 BLOCK DIGRAM SHOWING THE CONFIGURATION OF SYSTEM TESTED	12
3.5 DESCRIPTION OF SUPPORT UNITS	14
<b>4 . EMC EMISSION TEST</b>	<b>15</b>
4.1 CONDUCTED EMISSION MEASUREMENT	15
4.1.1 POWER LINE CONDUCTED EMISSION LIMITS	15
4.1.2 MEASUREMENT INSTRUMENTS LIST AND SETTING	15
4.1.3 TEST PROCEDURE	16
4.1.4 DEVIATION FROM TEST STANDARD	16
4.1.5 TEST SETUP	16
4.1.6 EUT OPERATING CONDITIONS	16
4.1.7 TEST RESULTS	17
4.2 RADIATED EMISSION MEASUREMENT	20
4.2.1 RADIATED EMISSION LIMITS	20
4.2.2 MEASUREMENT INSTRUMENTS LIST ANS SETTING	21
4.2.3 TEST PROCEDURE	21
4.2.4 DEVIATION FROM TEST STANDARD	21
4.2.5 TEST SETUP	22
4.2.6 EUT OPERATING CONDITIONS	23
4.2.7 TEST RESULTS (BELOW 30MHZ)	24
4.2.8 TEST RESULTS (BETWEEN30 – 1000 MHZ)	25
4.2.9 TEST RESULTS (ABOVE 1000 MHZ)	32
<b>5 . NUMBER OF HOPPING CHANNEL</b>	<b>56</b>
5.1 APPLIED PROCEDURES / LIMIT	56
5.1.1 MEASUREMENT INSTRUMENTS LIST AND SETTING	56
5.1.2 TEST PROCEDURE	56
5.1.3 DEVIATION FROM STANDARD	56
5.1.4 TEST SETUP	56
5.1.5 EUT OPERATION CONDITIONS	56
5.1.6 TEST RESULTS	57
<b>6 . AVERAGE TIME OF OCCUPANCY</b>	<b>59</b>



Table of Contents	Page
<b>6.1 APPLIED PROCEDURES / LIMIT</b>	<b>59</b>
6.1.1 MEASUREMENT INSTRUMENTS LIST	59
6.1.2 TEST PROCEDURE	59
6.1.3 DEVIATION FROM STANDARD	59
6.1.4 TEST SETUP	60
6.1.5 EUT OPERATION CONDITIONS	60
6.1.6 TEST RESULTS	61
<b>7 . HOPPING CHANNEL SEPARATION MEASUREMENT</b>	<b>73</b>
7.1 APPLIED PROCEDURES / LIMIT	73
7.1.1 MEASUREMENT INSTRUMENTS LIST AND SETTING	73
7.1.2 TEST PROCEDURE	73
7.1.3 DEVIATION FROM STANDARD	73
7.1.4 TEST SETUP	73
7.1.5 EUT OPERATION CONDITIONS	73
7.1.6 TEST RESULTS	74
<b>8 . BANDWIDTH TEST</b>	<b>78</b>
8.1 APPLIED PROCEDURES / LIMIT	78
8.1.1 MEASUREMENT INSTRUMENTS LIST AND SETTING	78
8.1.2 TEST PROCEDURE	78
8.1.3 DEVIATION FROM STANDARD	78
8.1.4 TEST SETUP	78
8.1.5 EUT OPERATION CONDITIONS	78
8.1.6 TEST RESULTS	79
<b>9 . PEAK OUTPUT POWER TEST</b>	<b>83</b>
9.1 APPLIED PROCEDURES / LIMIT	83
9.1.1 MEASUREMENT INSTRUMENTS LIST AND SETTING	83
9.1.2 TEST PROCEDURE	83
9.1.3 DEVIATION FROM STANDARD	83
9.1.4 TEST SETUP	83
9.1.5 EUT OPERATION CONDITIONS	83
9.1.6 TEST RESULTS	84
<b>10 . ANTENNA CONDUCTED SPURIOUS EMISSION</b>	<b>88</b>
10.1 APPLIED PROCEDURES / LIMIT	88
10.1.1 MEASUREMENT INSTRUMENTS LIST AND SETTING	88
10.1.2 TEST PROCEDURE	88
10.1.3 DEVIATION FROM STANDARD	88
10.1.4 TEST SETUP	88
10.1.5 EUT OPERATION CONDITIONS	88
10.1.6 TEST RESULTS	89
<b>11 . EUT TEST PHOTO</b>	<b>101</b>



## 1. CERTIFICATION

Equipment : Portable Bluetooth Speaker  
Brand Name : amazon  
Model Name : BTV1  
Applicant : Guoguang Electric Co.,Ltd  
Manufacturer : Amazon.com, Inc.  
Address : 410 Terry Ave N Seattle, WA 98109  
Factory : Guoguang Electric Co.,Ltd  
Address : No.8 Jinghu Road, Xinhua Street, Huadu Reg, Guangzhou, China  
Date of Test : Sep. 12, 2013~Sep. 26, 2013  
Test Item : ENGINEERING SAMPLE  
Standard(s) : FCC Part15, Subpart C(15.247) / ANSI C63.4-2009  
FCC Public Notice DA 00-705, March 30, 2000.

The above equipment has been tested and found compliance with the requirement of the relative standards by Neutron Engineering Inc. EMC Laboratory.  
The test data, data evaluation, and equipment configuration contained in our test report (Ref No. NEI-FCCP-1-1309C052) were obtained utilizing the test procedures, test instruments, test sites that has been accredited by the Authority of TAF according to the ISO-17025 quality assessment standard and technical standard(s).



**2. SUMMARY OF TEST RESULTS**

Test procedures according to the technical standard(s):

<b>Applied Standard(s): 47 CFR Part 15, Subpart C</b>			
<b>Standard(s) Section</b>	<b>Test Item</b>	<b>Judgment</b>	<b>Remark</b>
<b>47 CFR Part 15</b>			
15.207	Conducted Emission	PASS	
15.247(d)	Antenna conducted Spurious Emission	PASS	
15.247 (a)(1)	Hopping Channel Separation	PASS	
15.247 (b)(1)	Peak Output Power	PASS	
15.247(d) 15.209	Radiated Spurious Emission	PASS	
15.247 (a)(1)(iii)	Number of Hopping Frequency	PASS	
15.247 (a)(1)(iii)	Dwell Time	PASS	
15.205	Restricted Bands	PASS	
15.203	Antenna Requirement	PASS	

**NOTE:**

- (1) "N/A" denotes test is not applicable in this test report.
- (2) According to FCC Public Notice DA 00-705, March 30, 2000.



**2.1 TEST FACILITY**

The test facilities used to collect the test data in this report is **DG-C02/DG-CB03** at the location of No.3, Jinshagang 1st Road, ShiXia, Dalang Town, Dong Guan, China.523792  
 Neutron's test firm number for FCC 319330

**2.2 MEASUREMENT UNCERTAINTY**

Where relevant, the following measurement uncertainty levels have been estimated for tests performed on the EUT as specified in CISPR 16-4-2:

The reported uncertainty of measurement  $y \pm U$ , where expanded uncertainty **U** is based on a standard uncertainty multiplied by a coverage factor of **k=2**, providing a level of confidence of approximately **95 %**.

A. Conducted Measurement :

Test Site	Method	Measurement Frequency Range	U , (dB)	NOTE
DG-C02	CISPR	150 KHz ~ 30MHz	1.94	

B. Radiated Measurement :

Test Site	Method	Measurement Frequency Range	Ant. H / V	U , (dB)	NOTE
DG-CB03	CISPR	9K~30MHz	V	3.79	
		9K~30MHz	H	3.57	
		30MHz ~ 200MHz	V	3.82	
		30MHz ~ 200MHz	H	3.60	
		200MHz ~ 1,000MHz	V	3.86	
		200MHz ~ 1,000MHz	H	3.94	
		1GHz~18GHz	V	3.12	
		1GHz~18GHz	H	3.68	
		18GHz~40GHz	V	4.15	
		18GHz~40GHz	H	4.14	





### 3. GENERAL INFORMATION

#### 3.1 GENERAL DESCRIPTION OF EUT

Equipment	Portable Bluetooth Speaker	
Brand Name	amazon	
Model Name	BTV1	
Model Difference	N/A	
Product Description	Operation Frequency	2402~2480 MHz
	Modulation Technology	GFSK(1Mbps)
	Bit Rate of Transmitter	$\pi$ /4-DQPSK(2Mbps)
		8-DPSK(3Mbps)
	Number of Channel	79 CH, Please see note 2.(Page 9)
	Antenna Designation	Please see note 3.(Page 9)
	Antenna Gain(Peak)	
	Output Power	-0.44 dBm (1Mbps)
0.23 dBm (3Mbps)		
More details of EUT technical specification, please refer to the		
Power Source	#1 Supplied from USB port. #2 Supplied from lithium battery.	
Power Rating	#1 DC 5V 500mA #2 DC 3.7V 1000mAh	
Connecting I/O Port(s)	Please refer to the User's Manual	

Note:

1. For a more detailed features description, please refer to the manufacturer's specifications or the User's Manual.



2.

Channel List					
Channel	Frequency (MHz)	Channel	Frequency (MHz)	Channel	Frequency (MHz)
00	2402	27	2429	54	2456
01	2403	28	2430	55	2457
02	2404	29	2431	56	2458
03	2405	30	2432	57	2459
04	2406	31	2433	58	2460
05	2407	32	2434	59	2461
06	2408	33	2435	60	2462
07	2409	34	2436	61	2463
08	2410	35	2437	62	2464
09	2411	36	2438	63	2465
10	2412	37	2439	64	2466
11	2413	38	2440	65	2467
12	2414	39	2441	66	2468
13	2415	40	2442	67	2469
14	2416	41	2443	68	2470
15	2417	42	2444	69	2471
16	2418	43	2445	70	2472
17	2419	44	2446	71	2473
18	2420	45	2447	72	2474
19	2421	46	2448	73	2475
20	2422	47	2449	74	2476
21	2423	48	2450	75	2477
22	2424	49	2451	76	2478
23	2425	50	2452	77	2479
24	2426	51	2453	78	2480
25	2427	52	2454		
26	2428	53	2455		

3.

Table for Filed Antenna

Ant.	Brand	Model Name	Antenna Type	Connector	Gain (dBi)
1	N/A	N/A	Printed	N/A	-0.69



**3.2 DESCRIPTION OF TEST MODES**

To investigate the maximum EMI emission characteristics generates from EUT, the test system was pre-scanning tested base on the consideration of following EUT operation mode or test configuration mode which possible have effect on EMI emission level. Each of these EUT operation mode(s) or test configuration mode(s) mentioned above was evaluated respectively.

Pretest Mode	Description
Mode 1	TX Mode <b>NOTE (1)</b>
Mode 2	Bluetooth

The EUT system operated these modes were found to be the worst case during the pre-scanning test as following:

For Conducted Emission	
Final Test Mode	Description
Mode 2	Bluetooth

For Radiated Emission	
Final Test Mode	Description
Mode 1	TX Mode <b>NOTE (1)</b>

**Note:**

(1) The measurements are performed at the high, middle, low available channels.

**3.3 TABLE OF PARAMETERS OF TEXT SOFTWARE SETTING**

During testing channel & power controlling software provided by the customer was used to control the operating channel as well as the output power level. The RF output power selection is for the setting of RF output power expected by the customer and is going to be fixed on the firmware of the final end product power parameters of FHSS

Test software version	RF Control Kit v1.0		
Frequency	2402 MHz	2441 MHz	2480 MHz
Parameters-1Mbps	18	15	15
Parameters-3Mbps	19	16	16

**3.4 BLOCK DIGRAM SHOWING THE CONFIGURATION OF SYSTEM TESTED**

Conducted:

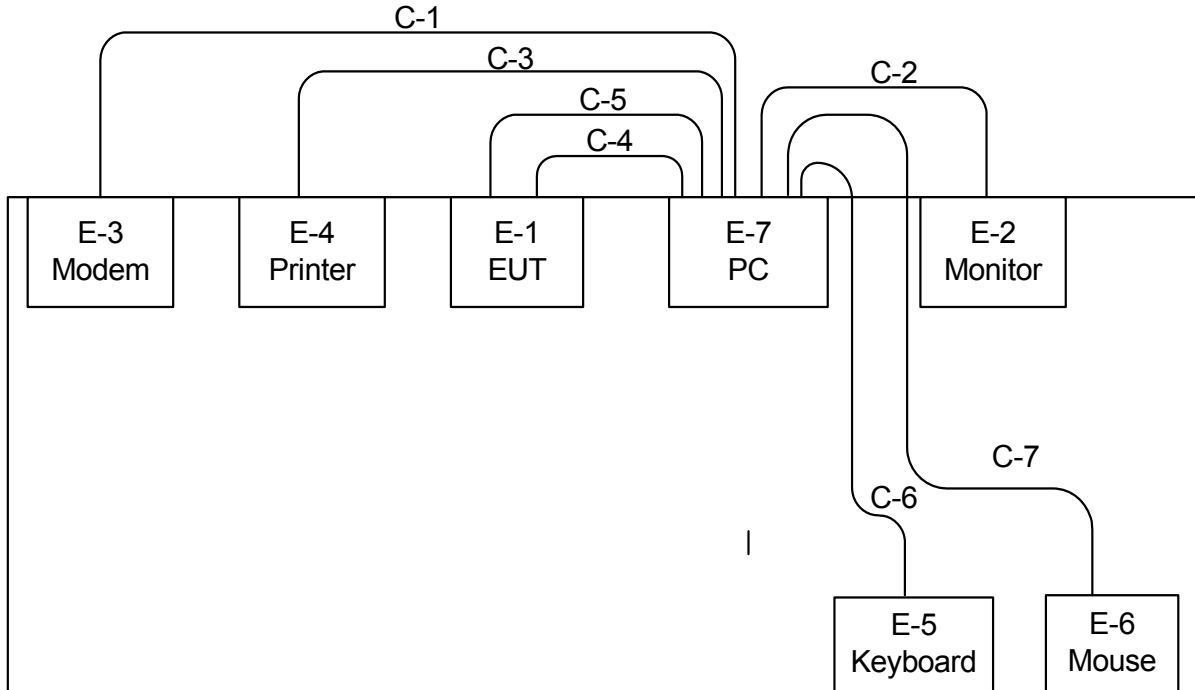

Control Room

- C-1: RS232 Cable
- C-2: D-Sub Cable
- C-3: Parallel Cable
- C-4: USB Cable
- C-5: AUX IN Cable
- C-6: USB Cable
- C-7: USB Cable

E-8  
 iPhone



**Radiated:**

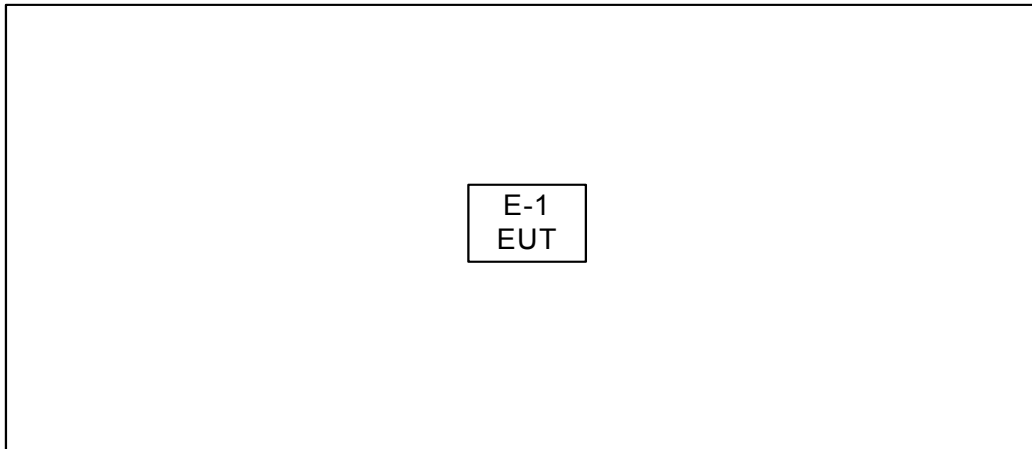

E-1  
EUT



**3.5 DESCRIPTION OF SUPPORT UNITS**

The EUT has been tested as an independent unit together with other necessary accessories or support units. The following support units or accessories were used to form a representative test configuration during the tests.

Item	Equipment	Mfr/Brand	Model/Type No.	FCC ID / IC	Series No.	Note
E-1	Portable Bluetooth Speaker	amazon	BTV1	2AAP800001	N/A	EUT
E-2	LCD monitor	Dell	E177FPc	DOC	CNOFJ179-6418 0-6AG-1WNS	
E-3	Modem	ACEEX	DM-1414V	IFAXDm1414	0603002131	
E-4	Printer	SII	DPU-414	DOC	3018507 B	
E-5	USB Keyboard	Dell	L100	DOC	CNORH6596589 085C00U7	
E-6	USB Mouse	Dell	MO56UOA	DOC	G01003HO	
E-7	PC	Dell 745	DCSM	DOC	G7K832X	
E-8	IPHONE 3	APPLE	A1241	DOC	BCGA1241	

Item	Shielded Type	Ferrite Core	Length	Note
C-1	NO	NO	1.5m	-
C-2	NO	YES	1.5m	
C-3	NO	NO	1.5m	
C-4	NO	NO	0.8m	
C-5	NO	NO	0.8m	
C-6	YES	NO	1.8m	
C-7	YES	NO	1.8m	

Note:

- (1) For detachable type I/O cable should be specified the length in m in 『Length』 column.



**4. EMC EMISSION TEST**

**4.1 CONDUCTED EMISSION MEASUREMENT**

**4.1.1 POWER LINE CONDUCTED EMISSION Limits (Frequency Range 150KHz-30MHz)**

FREQUENCY (MHz)	Class A (dBuV)		Class B (dBuV)		Standard
	Quasi-peak	Average	Quasi-peak	Average	
0.15 -0.5	79.00	66.00	66 - 56 *	56 - 46 *	CISPR
0.50 -5.0	73.00	60.00	56.00	46.00	CISPR
5.0 -30.0	73.00	60.00	60.00	50.00	CISPR

0.15 -0.5	79.00	66.00	66 - 56 *	56 - 46 *	FCC
0.50 -5.0	73.00	60.00	56.00	46.00	FCC
5.0 -30.0	73.00	60.00	60.00	50.00	FCC

Note:

- (1) The tighter limit applies at the band edges.
- (2) The limit of " \* " marked band means the limitation decreases linearly with the logarithm of the frequency in the range.

**4.1.2 MEASUREMENT INSTRUMENTS LIST AND SETTING**

Item	Kind of Equipment	Manufacturer	Type No.	Serial No.	Calibrated until
1	LISN	EMCO	3816/2	00052765	Apr. 25, 2014
2	LISN	R&S	ENV216	100087	Nov. 16, 2013
3	Test Cable	N/A	C_17	N/A	Mar. 15, 2014
4	EMI TEST RECEIVER	R&S	ESCS30	826547/022	Apr. 25, 2014
5	50Ω Terminator	SHX	TF2-3G-A	08122902	Apr. 25, 2014

Remark: "N/A" denotes no model name, serial no. or calibration specified.

All calibration period of Equipment List is One Year.

The following table is the setting of the receiver

Receiver Parameters	Setting
Attenuation	10 dB
Start Frequency	0.15 MHz
Stop Frequency	30 MHz
IF Bandwidth	9 kHz

#### 4.1.3 TEST PROCEDURE

- The EUT was placed 0.8 meters from the horizontal ground plane with EUT being connected to the power mains through a line impedance stabilization network (LISN). All other support equipments powered from additional LISN(s). The LISN provide 50 Ohm/ 50uH of coupling impedance for the measuring instrument.
- Interconnecting cables that hang closer than 40 cm to the ground plane shall be folded back and forth in the center forming a bundle 30 to 40 cm long.
- I/O cables that are not connected to a peripheral shall be bundled in the center. The end of the cable may be terminated, if required, using the correct terminating impedance. The overall length shall not exceed 1 m.
- LISN at least 80 cm from nearest part of EUT chassis.
- For the actual test configuration, please refer to the related Item –EUT Test Photos.

#### 4.1.4 DEVIATION FROM TEST STANDARD

No deviation

#### 4.1.5 TEST SETUP

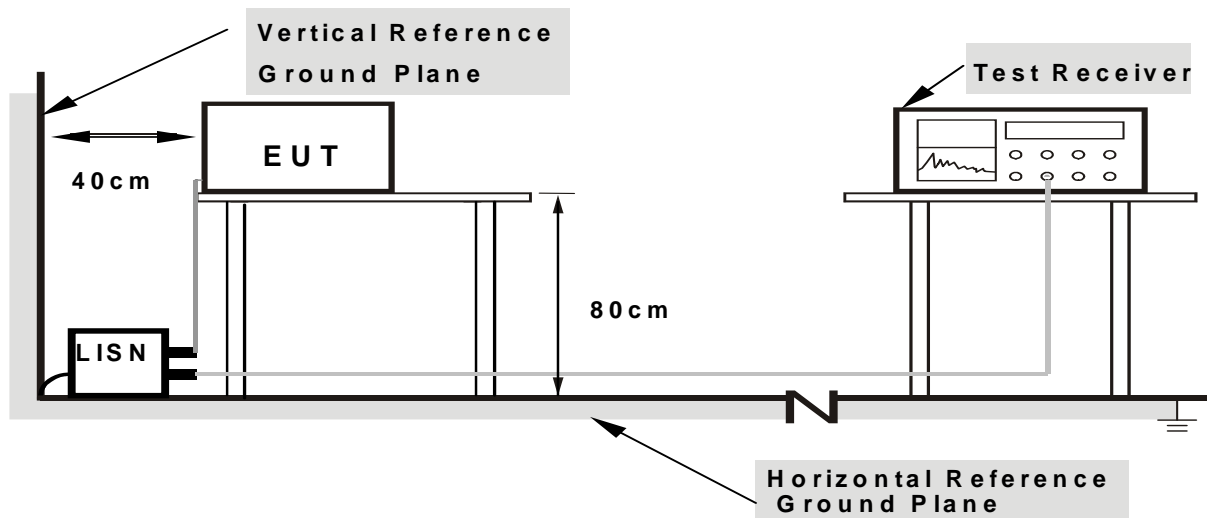

**Note: 1. Support units were connected to second LISN.**

**2. Both of LISNs (AMN) are 80 cm from EUT and at least 80 cm from other units and other metal planes**

#### 4.1.6 EUT OPERATING CONDITIONS

The EUT was configured for testing in a typical fashion (as a customer would normally use it). The EUT has been programmed to continuously transmit during test. This operating condition was tested and used to collect the included data.

The EUT is continuing transmitting/receiving data or Hopping on mode.





#### 4.1.7 TEST RESULTS

Remark:

- (1) All readings are QP Mode value unless otherwise stated AVG in column of『Note』. If the QP Mode Measured value compliance with the QP Limits and lower than AVG Limits, the EUT shall be deemed to meet both QP & AVG Limits and then only QP Mode was measured, but AVG Mode didn't perform. In this case, a “ \* ” marked in AVG Mode column of Interference Voltage Measured.
- (2) Measuring frequency range from 150KHz to 30MHz.



# Neutron Engineering Inc.

EUT:	Portable Bluetooth Speaker	Model Name :	BTV1
Temperature:	25 °C	Relative Humidity:	50 %
Test Power:	AC 120V/60Hz	Phase:	Line
Test Mode:	Bluetooth		

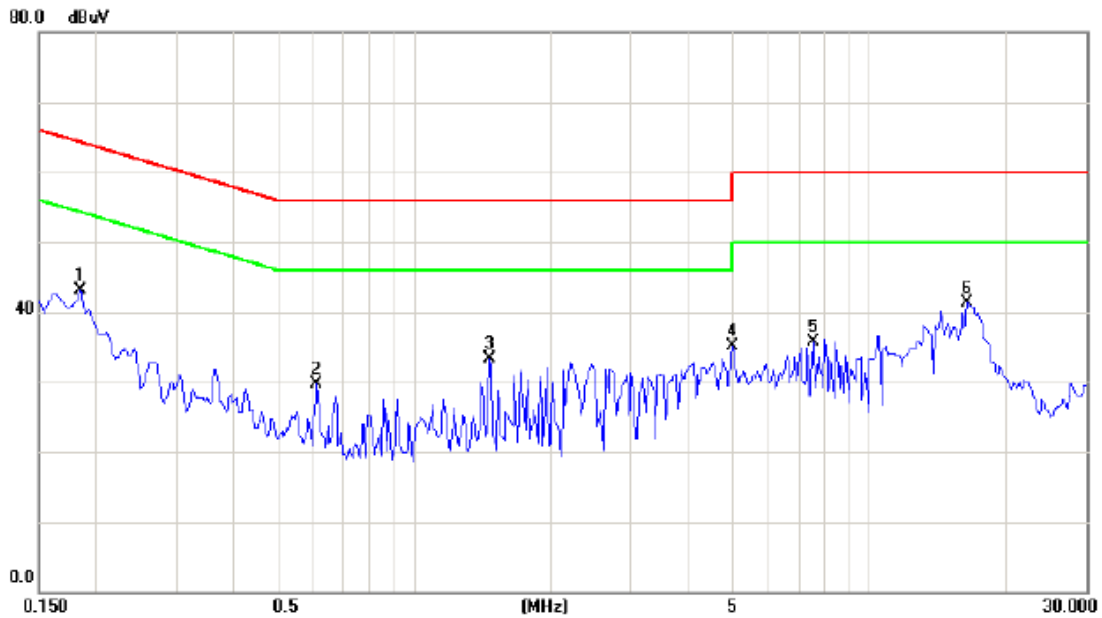

No.	Mk.	Freq. MHz	Reading Level dBuV	Correct Factor dB	Measure- ment dBuV	Limit dBuV	Over dB	Detector	Comment
1		0.1852	33.44	9.65	43.09	64.25	-21.16	peak	
2		0.6110	20.07	9.71	29.78	56.00	-26.22	peak	
3		1.4703	23.46	9.79	33.25	56.00	-22.75	peak	
4		5.0195	25.09	9.92	35.01	60.00	-24.99	peak	
5		7.5313	25.80	10.00	35.80	60.00	-24.20	peak	
6	*	16.4453	31.04	10.31	41.35	60.00	-18.65	peak	



EUT:	Portable Bluetooth Speaker	Model Name :	BTV1
Temperature:	25 °C	Relative Humidity:	50 %
Test Power:	AC 120V/60Hz	Phase:	Neutral
Test Mode:	Bluetooth		

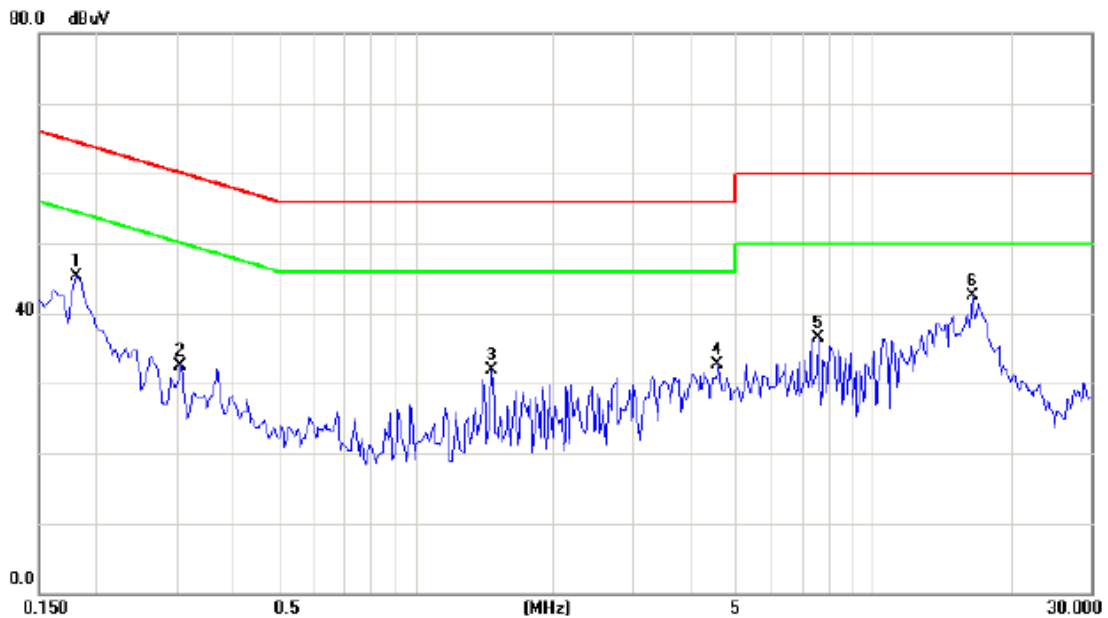

No. Mk.	Freq. MHz	Reading Level dBuV	Correct Factor dB	Measurement dBuV	Limit dBuV	Over dB	Detector	Comment
1	0.1812	35.68	9.71	45.39	64.43	-19.04	peak	
2	0.3067	22.69	9.72	32.41	60.06	-27.65	peak	
3	1.4664	22.15	9.81	31.96	56.00	-24.04	peak	
4	4.5898	22.79	9.93	32.72	56.00	-23.28	peak	
5	7.5703	26.42	10.05	36.47	60.00	-23.53	peak	
6 *	16.5313	32.06	10.50	42.56	60.00	-17.44	peak	



**4.2 RADIATED EMISSION MEASUREMENT**

**4.2.1 RADIATED EMISSION LIMITS (Frequency Range 9kHz-1000MHz)**

20dBc in any 100 kHz bandwidth outside the operating frequency band. In case the emission fall within the restricted band specified on 15.205(a), then the 15.209(a) limit in the table below has to be followed.

Frequencies (MHz)	Field Strength (micorvolts/meter)	Measurement Distance (meters)
0.009~0.490	2400/F(KHz)	300
0.490~1.705	24000/F(KHz)	30
1.705~30.0	30	30
30~88	100	3
88~216	150	3
216~960	200	3
Above 960	500	3

**LIMITS OF RADIATED EMISSION MEASUREMENT (Above 1000MHz)**

FREQUENCY (MHz)	(dBuV/m) (at 3M)	
	PEAK	AVERAGE
Above 1000	74	54

Notes:

- (1) The limit for radiated test was performed according to FCC PART 15C.
- (2) The tighter limit applies at the band edges.
- (3) Emission level (dBuV/m)=20log Emission level (uV/m).

Spectrum Parameter	Setting
Attenuation	Auto
Start Frequency	1000 MHz
Stop Frequency	10th carrier harmonic
RB / VB (emission in restricted band)	1 MHz / 1 MHz for Peak, 1 MHz / 10Hz for Average

Receiver Parameter	Setting
Attenuation	Auto
Start ~ Stop Frequency	9kHz~90kHz for PK/AVG detector
Start ~ Stop Frequency	90kHz~110kHz for QP detector
Start ~ Stop Frequency	110kHz~490kHz for PK/AVG detector
Start ~ Stop Frequency	490kHz~30MHz for QP detector
Start ~ Stop Frequency	30MHz~1000MHz for QP detector



**4.2.2 MEASUREMENT INSTRUMENTS LIST AND SETTING**

Item	Kind of Equipment	Manufacturer	Type No.	Serial No.	Calibrated until
1	Antenna	Schwarzbeck	VULB9160	9160-3232	Apr. 25, 2014
2	Amplifier	HP	8447D	2944A09673	Apr. 25, 2014
3	Test Receiver	R&S	ESCI	100382	Apr. 25, 2014
4	Test Cable	N/A	C-01_CB03	N/A	Jul. 02, 2014
5	Antenna	ETS	3115	00075789	Apr. 25, 2014
6	Amplifier	Agilent	8449B	3008A02274	Apr. 25, 2014
7	Spectrum	Agilent	E4408B	US39240143	Nov. 16, 2013
8	Test Cable	HUBER+SUHNER	C-45	N/A	Apr. 30, 2014
9	Controller	CT	SC100	N/A	N/A
10	Horn Antenna	EMCO	3115	9605-4803	Apr. 25, 2014
11	Broad-Band Horn Antenna	Schwarzbeck	BBHA 9170	9170319	Oct. 23, 2013
12	Active Loop Antenna	R&S	HFH2-Z2	830749/020	Apr. 25, 2014

Remark: "N/A" denotes no model name, serial no. or calibration specified.  
 All calibration period of Equipment List is One Year.

**4.2.3 TEST PROCEDURE**

- a. The EUT was placed on the top of a rotating table 0.8 meters above the ground at a 3 meter semi-anechoic chamber. The table was rotated 360 degrees to determine the position of the highest radiation.(below 1GHz)
- b. The EUT was placed on the top of a rotating table 0.8 meters above the ground at a 3 meter semi-anechoic chamber. The table was rotated 360 degrees to determine the position of the highest radiation.(above 1GHz)
- c. The height of the equipment or of the substitution antenna shall be 0.8 m; the height of the test antenna shall vary between 1 m to 4 m. Both horizontal and vertical polarizations of the antenna are set to make the measurement.
- d. The initial step in collecting conducted emission data is a spectrum analyzer peak detector mode pre-scanning the measurement frequency range. Significant peaks are then marked and then Quasi Peak detector mode re-measured.
- e. If the Peak Mode measured value compliance with and lower than Quasi Peak Mode Limit, the EUT shall be deemed to meet QP Limits and then no additional QP Mode measurement performed.
- f. For the actual test configuration, please refer to the related Item –EUT Test Photos.

**4.2.4 DEVIATION FROM TEST STANDARD**

No deviation

**4.2.5 TEST SETUP**

(A) Radiated Emission Test Set-Up Frequency Below 1 GHz

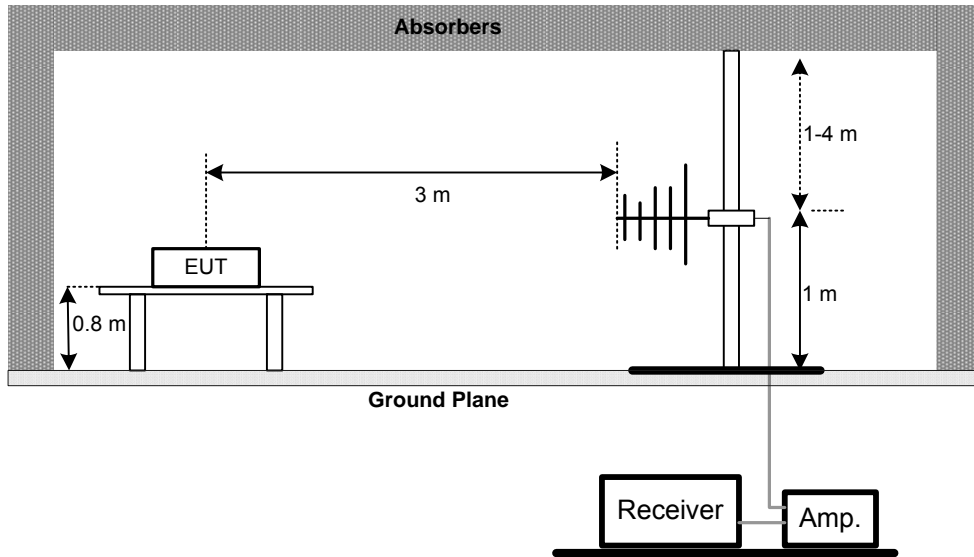

(B) Radiated Emission Test Set-Up Frequency Above 1 GHz

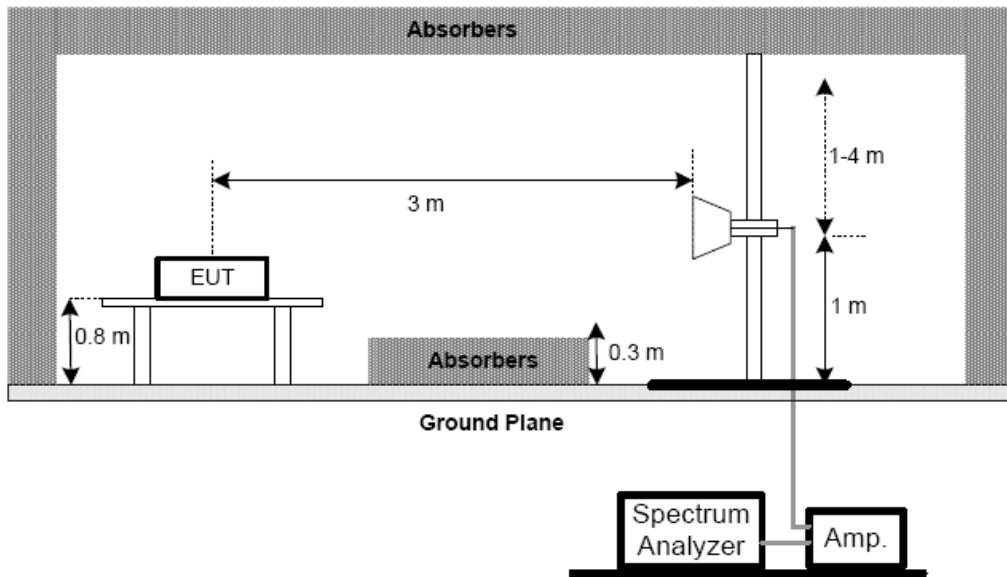

(C) For radiated emissions below 30MHz

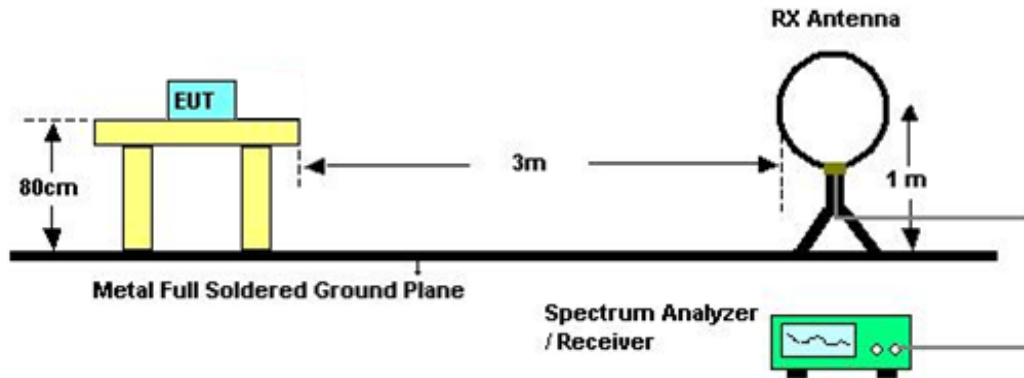

#### 4.2.6 EUT OPERATING CONDITIONS

The EUT tested system was configured as the statements of 4.1.6 Unless otherwise a special operating condition is specified in the follows during the testing.



**4.2.7 TEST RESULTS (BELOW 30MHZ)**

EUT:	Portable Bluetooth Speaker	Model Name:	BTV1
Temperature:	25 °C	Relative Humidity:	46 %
Test Voltage:	AC 120V/60Hz		
Test Mode:	TX 2402MHz –CH00-1Mbps		

Freq. (MHz)	Ant. 0°/90°	Reading(RA) (dBuV)	Corr.Factor(CF) (dB)	Measured(FS) (dBuV/m)	Limits(QP) (dBuV/m)	Margin (dB)	Note
0.0098	0°	27.15	24.30	51.45	127.78	-76.33	AVG
0.0098	0°	30.65	24.30	54.95	147.78	-92.83	PK
0.0256	0°	23.78	23.95	47.73	119.44	-71.71	AVG
0.0256	0°	26.42	23.95	50.37	139.44	-89.07	PK
0.0402	0°	20.04	23.02	43.06	115.53	-72.46	AVG
0.0402	0°	22.71	23.02	45.73	135.53	-89.79	PK
0.0623	0°	23.56	22.15	45.71	111.71	-66.00	AVG
0.0623	0°	25.82	22.15	47.97	131.71	-83.74	PK
0.3528	0°	20.34	20.15	40.49	96.65	-56.16	AVG
0.3528	0°	23.02	20.15	43.17	116.65	-73.48	PK
1.7430	0°	27.35	19.53	46.88	69.54	-22.66	QP

Freq. (MHz)	Ant. 0°/90°	Reading(RA) (dBuV)	Corr.Factor(CF) (dB)	Measured(FS) (dBuV/m)	Limits(QP) (dBuV/m)	Margin (dB)	Note
0.0096	90°	19.2500	24.30	43.55	127.96	-84.41	AVG
0.0096	90°	23.0100	24.30	47.31	147.96	-100.65	PK
0.0225	90°	18.6400	24.14	42.78	120.56	-77.78	AVG
0.0225	90°	20.1200	24.14	44.26	140.56	-96.30	PK
0.0465	90°	20.3500	22.62	42.97	114.26	-71.28	AVG
0.0465	90°	22.4900	22.62	45.11	134.26	-89.14	PK
0.0705	90°	22.2300	21.99	44.22	110.64	-66.42	AVG
0.0705	90°	25.1200	21.99	47.11	130.64	-83.53	PK
0.3680	90°	21.3700	20.12	41.49	96.29	-54.80	AVG
0.3680	90°	23.1600	20.12	43.28	116.29	-73.01	PK
1.5240	90°	23.2200	19.55	42.77	63.94	-21.18	QP

Remark:

- (1) The amplitude of spurious emissions which are attenuated by more than 20 dB below the permissible value has no need to be reported.
- (2) Distance extrapolation factor = 40 log (specific distance / test distance) (dB);.
- (3) Limit line = specific limits (dBuV) + distance extrapolation factor..





#### **4.2.8 TEST RESULTS (BETWEEN 30 – 1000 MHZ)**

Remark:

- (1) Reading in which marked as QP or Peak means measurements by using are Quasi-Peak Mode or Peak Mode with Detector BW=120KHz ; SPA setting in RBW=120KHz, VBW =120KHz, Swp. Time = 0.3 sec./MHz.
- (2) All readings are Peak unless otherwise stated QP in column of 『Note』 . Peak denotes that the Peak reading compliance with the QP Limits and then QP Mode measurement didn't perform.
- (3) Measuring frequency range from 30MHz to 1000MHz.
- (4) If the peak scan value lower limit more than 20dB, then this signal data does not show in table.



EUT:	Portable Bluetooth Speaker	Model Name:	BTV1
Temperature:	28 °C	Relative Humidity:	56 %
Test Power:	AC 120V/60Hz	Phase:	Vertical
Test Mode:	TX 2402MHz –CH00-1Mbps		

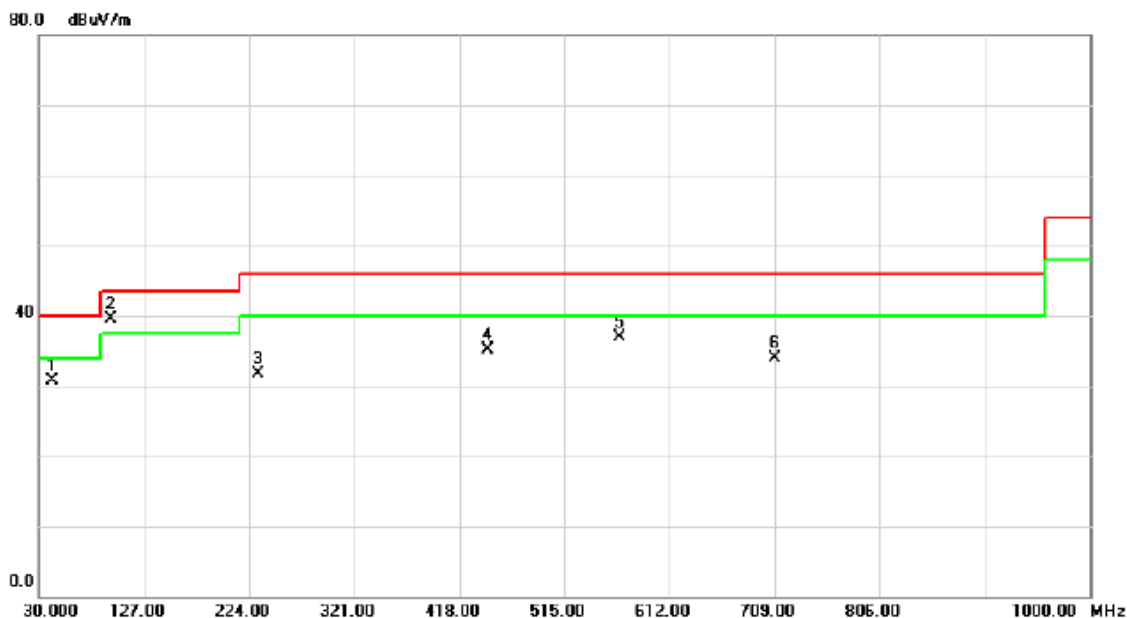

No.	Mk.	Freq. MHz	Reading Level dBuV	Correct Factor dB	Measure- ment dBuV/m	Limit dBuV/m	Over dB	Detector	Comment
1		42.6100	45.06	-14.39	30.67	40.00	-9.33	peak	
2	*	95.9600	56.56	-17.07	39.49	43.50	-4.01	peak	
3		231.7600	46.14	-14.53	31.61	46.00	-14.39	peak	
4		444.1900	44.11	-9.02	35.09	46.00	-10.91	peak	
5		565.4400	44.68	-7.79	36.89	46.00	-9.11	peak	
6		709.0000	38.76	-4.83	33.93	46.00	-12.07	peak	



EUT:	Portable Bluetooth Speaker	Model Name:	BTV1
Temperature:	28 °C	Relative Humidity:	56 %
Test Power:	AC 120V/60Hz	Phase:	Horizontal
Test Mode:	TX 2402MHz –CH00-1Mbps		

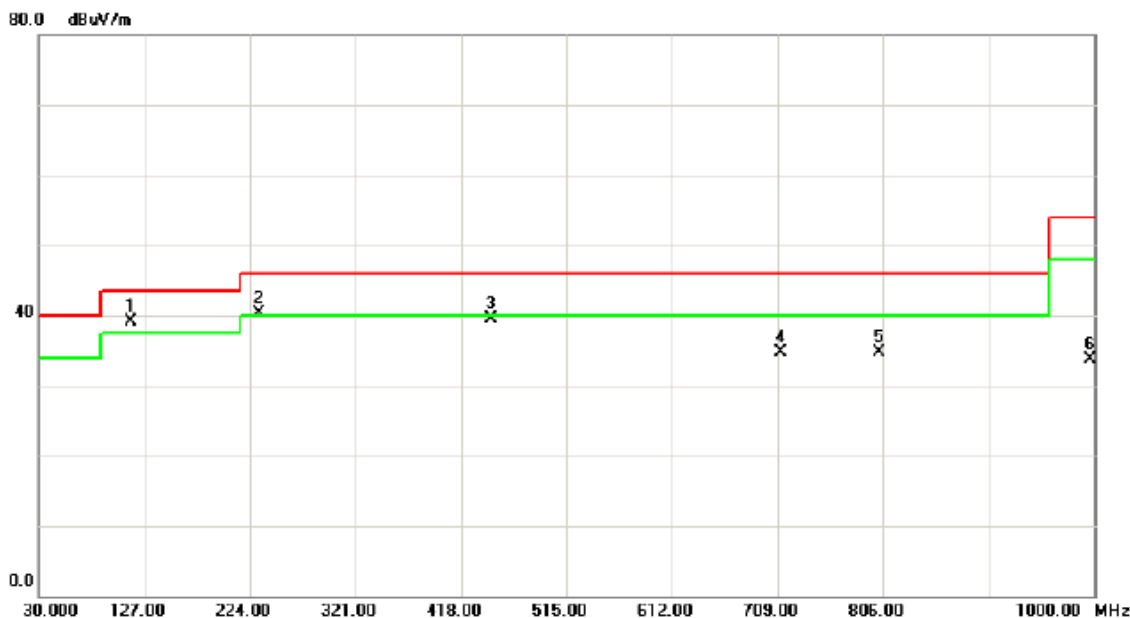

No.	Mk.	Freq. MHz	Reading Level dBuV	Correct Factor dB	Measure- ment dBuV/m	Limit dBuV/m	Over dB	Detector	Comment
1	*	114.3900	53.40	-14.37	39.03	43.50	-4.47	peak	
2	!	231.7600	54.76	-14.53	40.23	46.00	-5.77	peak	
3		445.1600	48.42	-9.01	39.41	46.00	-6.59	peak	
4		711.9100	39.46	-4.83	34.63	46.00	-11.37	peak	
5		802.1200	37.94	-3.14	34.80	46.00	-11.20	peak	
6		996.1200	33.41	0.20	33.61	54.00	-20.39	peak	



EUT:	Portable Bluetooth Speaker	Model Name:	BTV1
Temperature:	28 °C	Relative Humidity:	56 %
Test Power:	AC 120V/60Hz	Phase:	Vertical
Test Mode:	TX 2441MHz –CH39-1Mbps		

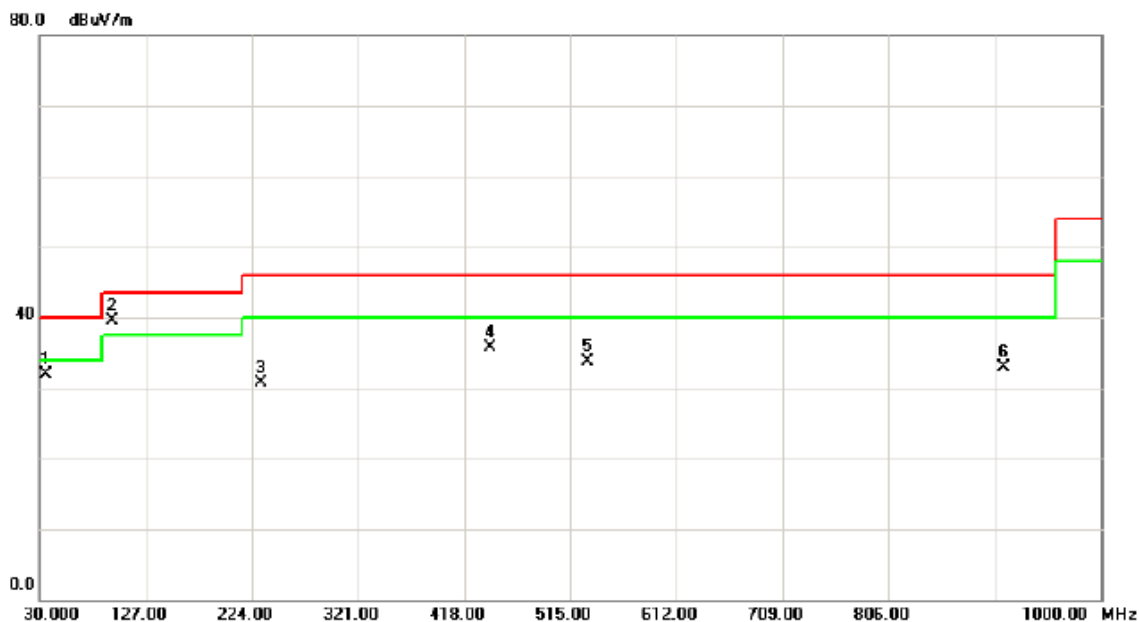

No.	Mk.	Freq. MHz	Reading Level dBuV	Correct Factor dB	Measure- ment dBuV/m	Limit dBuV/m	Over dB	Detector	Comment
1		35.8200	46.99	-15.13	31.86	40.00	-8.14	peak	
2	*	95.9600	56.66	-17.07	39.59	43.50	-3.91	peak	
3		231.7600	45.32	-14.53	30.79	46.00	-15.21	peak	
4		441.2800	44.86	-9.08	35.78	46.00	-10.22	peak	
5		530.5200	42.33	-8.69	33.64	46.00	-12.36	peak	
6		911.7300	33.93	-1.10	32.83	46.00	-13.17	peak	



# Neutron Engineering Inc.

EUT:	Portable Bluetooth Speaker	Model Name:	BTV1
Temperature:	28 °C	Relative Humidity:	56 %
Test Power:	AC 120V/60Hz	Phase:	Horizontal
Test Mode:	TX 2441MHz -CH39-1Mbps		

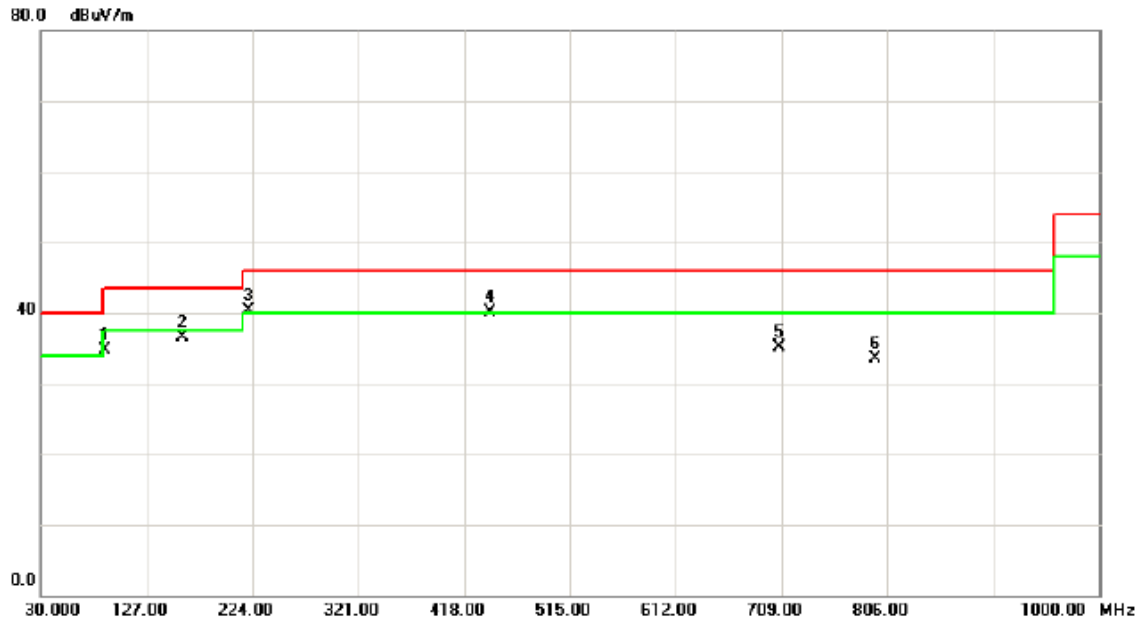

No.	Mk.	Freq. MHz	Reading Level dBuV	Correct Factor dB	Measure- ment dBuV/m	Limit dBuV/m	Over dB	Detector	Comment
1		88.2000	52.65	-18.03	34.62	43.50	-8.88	peak	
2		159.9800	50.10	-13.65	36.45	43.50	-7.05	peak	
3	*	220.1200	55.22	-15.01	40.21	46.00	-5.79	peak	
4	!	442.2500	49.15	-9.06	40.09	46.00	-5.91	peak	
5		707.0600	39.89	-4.82	35.07	46.00	-10.93	peak	
6		795.3300	36.70	-3.28	33.42	46.00	-12.58	peak	



# Neutron Engineering Inc.

EUT:	Portable Bluetooth Speaker	Model Name:	BTV1
Temperature:	28 °C	Relative Humidity:	56 %
Test Power:	AC 120V/60Hz	Phase:	Vertical
Test Mode:	TX 2480MHz –CH78-1Mbps		

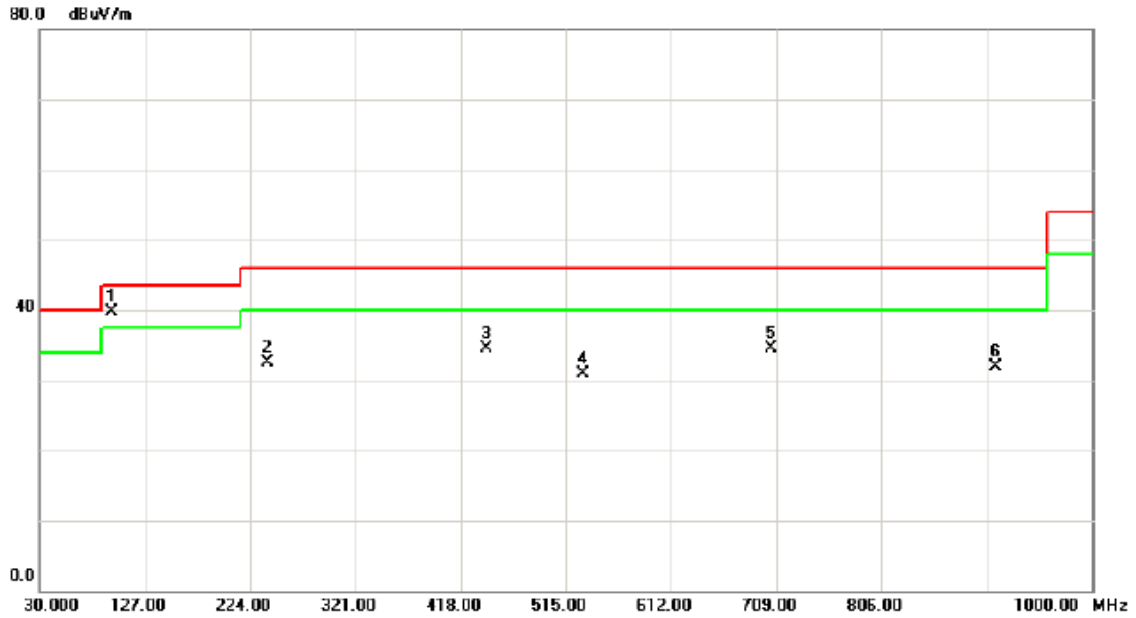

No.	Mk.	Freq. MHz	Reading Level dBuV	Correct Factor dB	Measure- ment dBuV/m	Limit dBuV/m	Over dB	Detector	Comment
1	*	95.9600	56.78	-17.07	39.71	43.50	-3.79	peak	
2		240.4900	47.34	-14.83	32.51	46.00	-13.49	peak	
3		441.2800	43.52	-9.08	34.44	46.00	-11.56	peak	
4		530.5200	39.59	-8.69	30.90	46.00	-15.10	peak	
5		704.1500	39.41	-4.81	34.60	46.00	-11.40	peak	
6		911.7300	33.08	-1.10	31.98	46.00	-14.02	peak	



# Neutron Engineering Inc.

EUT:	Portable Bluetooth Speaker	Model Name:	BTV1
Temperature:	28 °C	Relative Humidity:	56 %
Test Power:	AC 120V/60Hz	Phase:	Horizontal
Test Mode:	TX 2480MHz -CH78-1Mbps		

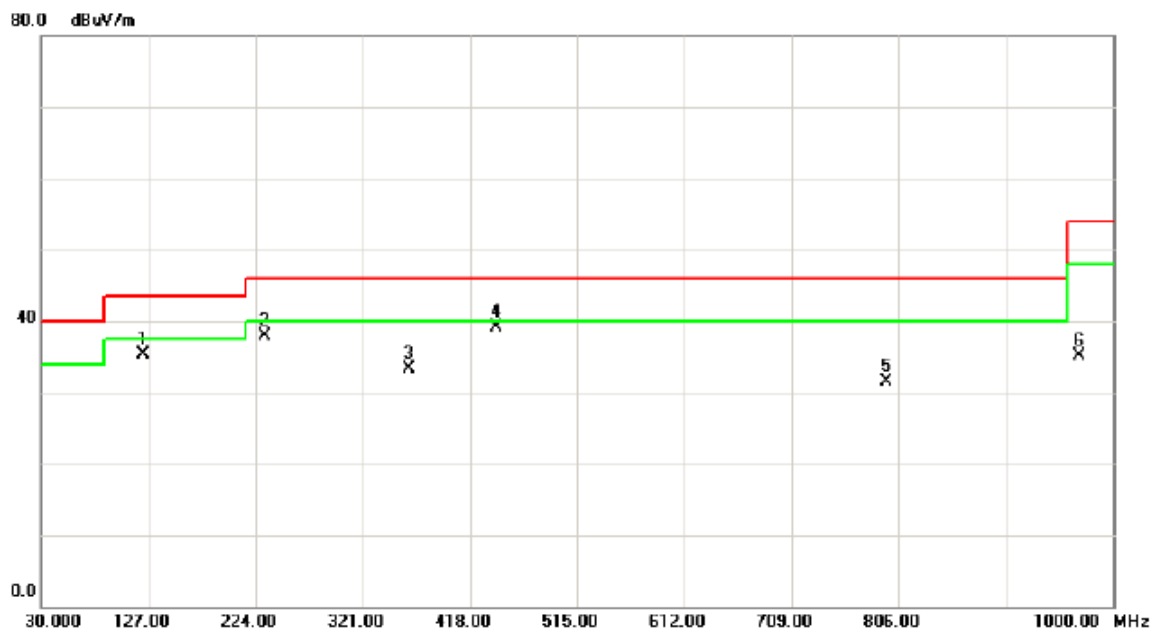

No. Mk.	Freq. MHz	Reading Level dBuV	Correct Factor dB	Measurement dBuV/m	Limit dBuV/m	Over dB	Detector	Comment
1	122.1500	49.08	-13.77	35.31	43.50	-8.19	peak	
2	231.7600	52.40	-14.53	37.87	46.00	-8.13	peak	
3	362.7100	44.45	-11.06	33.39	46.00	-12.61	peak	
4 *	441.2800	48.09	-9.08	39.01	46.00	-6.99	peak	
5	794.3600	34.90	-3.31	31.59	46.00	-14.41	peak	
6	968.9600	35.35	-0.23	35.12	54.00	-18.88	peak	



**4.2.9 TEST RESULTS (ABOVE 1000 MHZ)**

EUT:	Portable Bluetooth Speaker	Model Name :	BTV1
Temperature:	25 °C	Relative Humidity:	58 %
Pressure:	1010 hPa	Test Voltage :	AC 120V/60Hz
Test Mode :	TX 2402MHz – CH 00-1Mbps		

Freq. (MHz)	Ant.Pol. H/V	Reading		Ant./CF CF(dB)	Act.		Limit		Note
		Peak (dBuV)	AV (dBuV)		Peak (dBuV/m)	AV (dBuV/m)	Peak (dBuV/m)	AV (dBuV/m)	
2390.00	V	23.50	13.45	34.09	57.59	47.54	74.00	54.00	X/E
<b>2402.00</b>	<b>V</b>	<b>64.34</b>	<b>54.20</b>	<b>34.12</b>	<b>98.46</b>	<b>88.32</b>			<b>X/F</b>
4804.01	V	42.39	32.22	6.38	48.77	38.60	74.00	54.00	X/H

**Remark:**

- (1) All readings are Peak unless otherwise stated QP in column of 『Note』 . Peak denotes that the Peak reading compliance with the QP Limits and then QP Mode measurement didn't perform.
- (2) Measuring frequency range from 30MHz to 1000MHz or the 10th harmonic of highest fundamental frequency. "F" denotes fundamental frequency; "H" denotes spurious frequency. "E" denotes band edge frequency. (This judgment method includes the Band Edge Requirement.)
- (3) Radiated emissions measured in frequency range above 1000MHz were made with an instrument using Peak detector mode and AV detector mode of the emission .
- (4) Data of measurement within this frequency range shown " \* " in the table above means the reading of emissions are attenuated more than 20dB below the permissible limits or the field strength is too small to be measured.
- (5) A preamp and high pass filter were used for this test in order to provide sufficient measurement sensitivity.
- (6) EUT Orthogonal Axis:  
"X" - denotes Laid on Table ; "Y" - denotes Vertical Stand ; "Z" - denotes Side Stand
- (7) During the measurements above 1 GHz it is taken care of that the EUT is always within the 3 dB cone of radiation BW of the used antenna





TX CH00(Above 1000 MHz, Vertical)

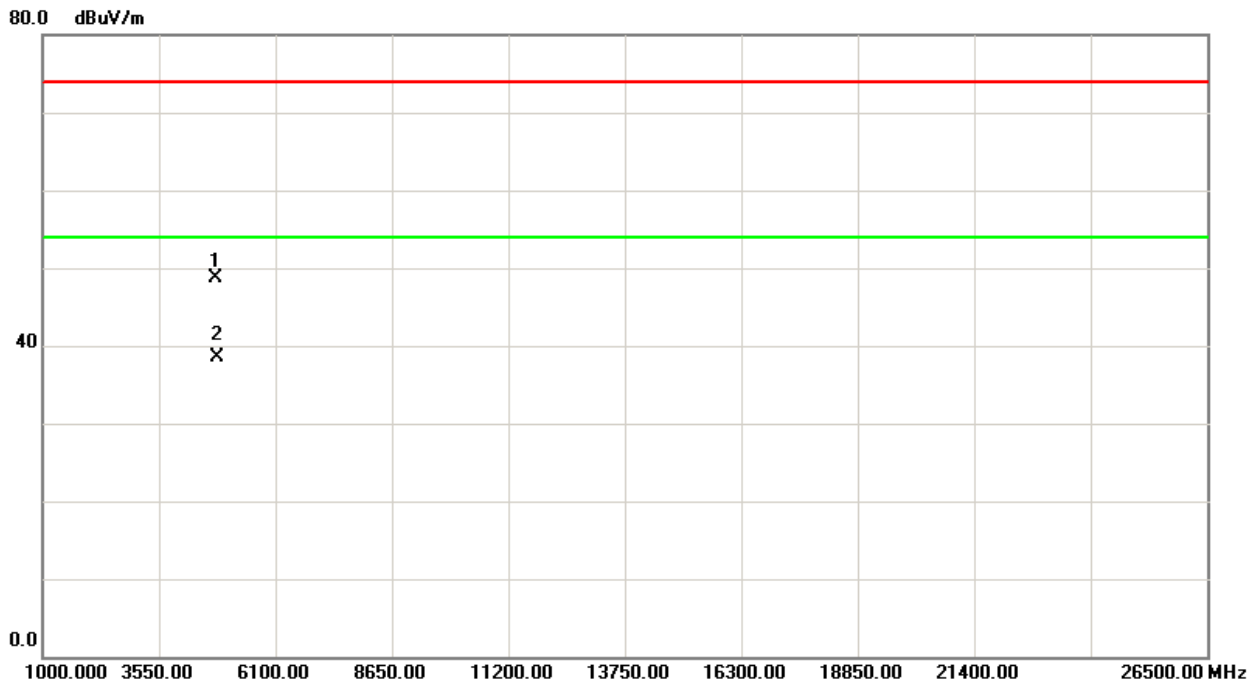
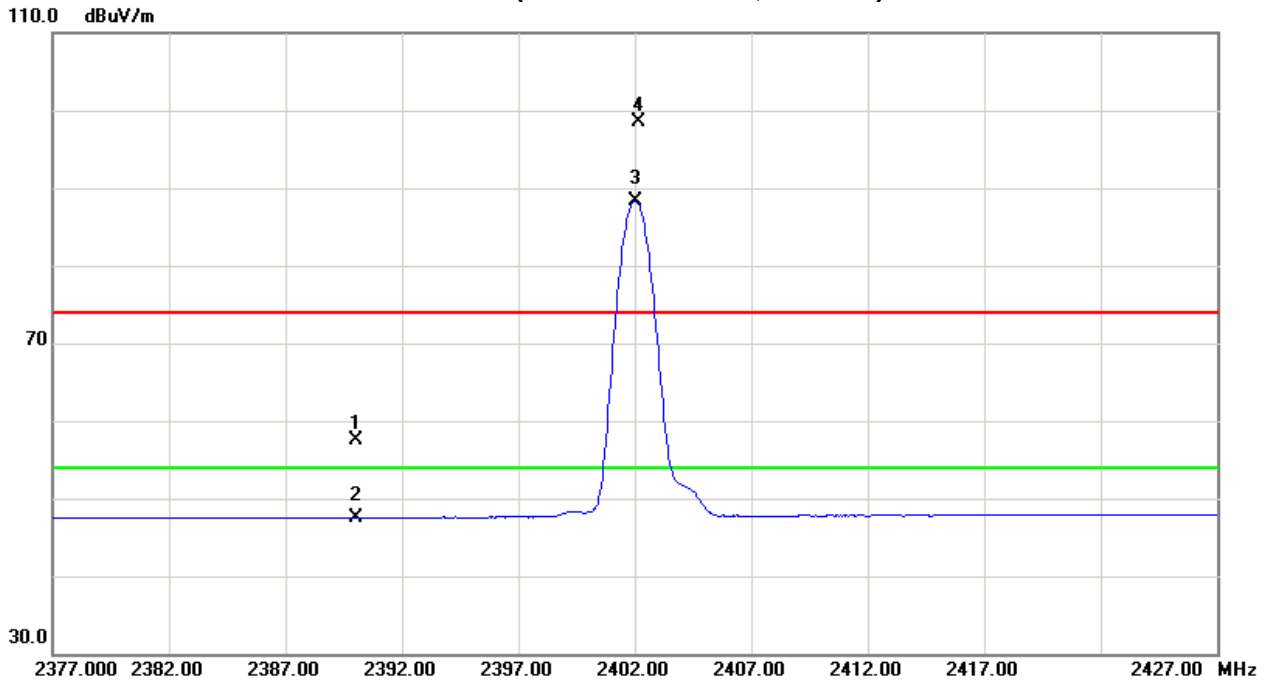



EUT:	Portable Bluetooth Speaker	Model Name :	BTV1
Temperature:	25 °C	Relative Humidity:	58 %
Pressure:	1010hPa	Test Voltage :	AC 120V/60Hz
Test Mode :	TX 2402MHz – CH 00-1Mbps		

Freq. (MHz)	Ant.Pol. H/V	Reading		Ant./CF CF(dB)	Act.		Limit		Note
		Peak (dBuV)	AV (dBuV)		Peak (dBuV/m)	AV (dBuV/m)	Peak (dBuV/m)	AV (dBuV/m)	
2390.00	H	23.12	13.41	34.09	57.21	47.50	74.00	54.00	X/E
<b>2402.00</b>	<b>H</b>	<b>59.77</b>	<b>49.63</b>	<b>34.12</b>	<b>93.89</b>	<b>83.75</b>			<b>X/F</b>
4804.02	H	42.78	32.55	6.38	49.16	38.93	74.00	54.00	X/H

**Remark:**

- (1) All readings are Peak unless otherwise stated QP in column of 『Note』 . Peak denotes that the Peak reading compliance with the QP Limits and then QP Mode measurement didn't perform.
- (2) Measuring frequency range from 30MHz to 1000MHz or the 10th harmonic of highest fundamental frequency. "F" denotes fundamental frequency; "H" denotes spurious frequency. "E" denotes band edge frequency. (This judgment method includes the Band Edge Requirement.)
- (3) Radiated emissions measured in frequency range above 1000MHz were made with an instrument using Peak detector mode and AV detector mode of the emission .
- (4) Data of measurement within this frequency range shown " \* " in the table above means the reading of emissions are attenuated more than 20dB below the permissible limits or the field strength is too small to be measured.
- (5) A preamp and high pass filter were used for this test in order to provide sufficient measurement sensitivity.
- (6) EUT Orthogonal Axis:  
"X" - denotes Laid on Table ; "Y" - denotes Vertical Stand ; "Z" - denotes Side Stand
- (7) During the measurements above 1 GHz it is taken care of that the EUT is always within the 3 dB cone of radiation BW of the used antenna



TX CH00(Above 1000 MHz, Horizontal)

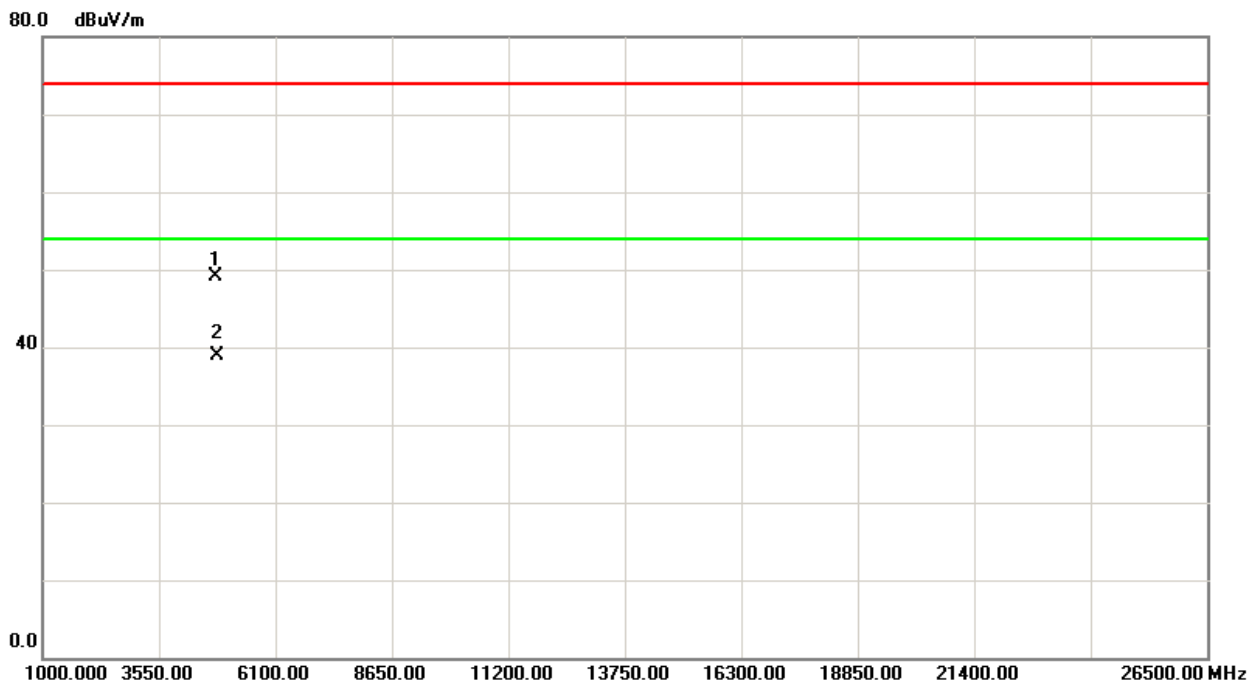
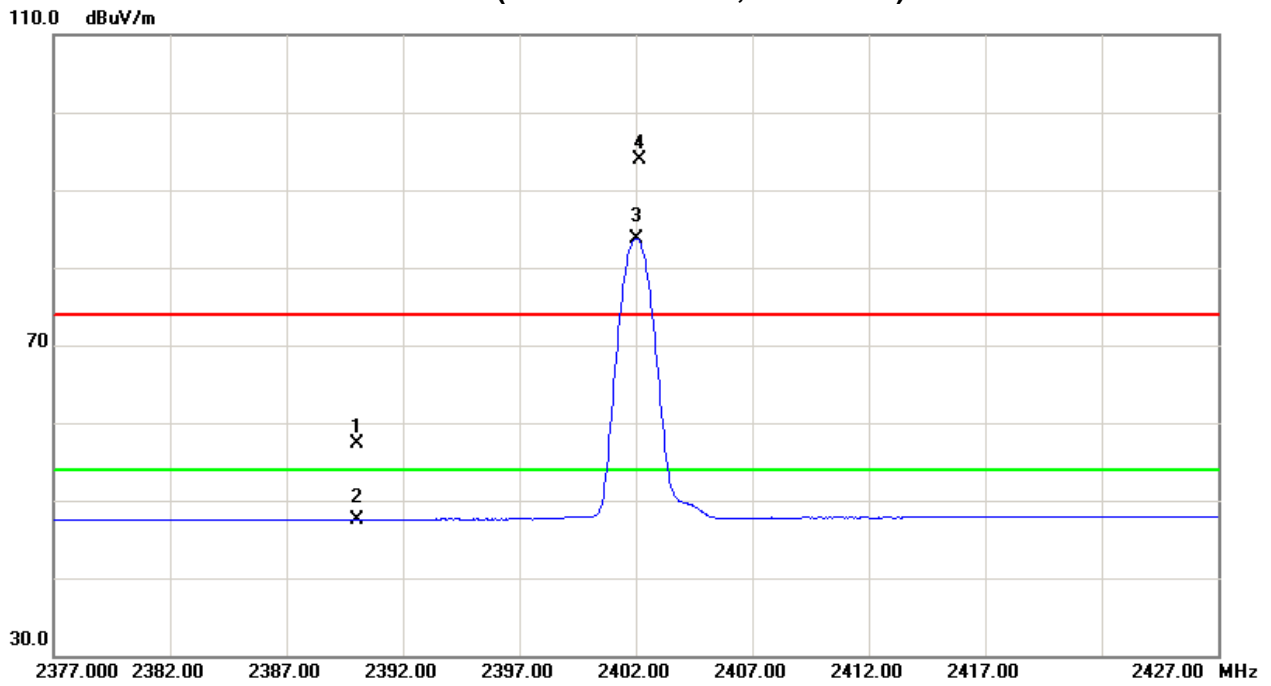



EUT:	Portable Bluetooth Speaker	Model Name :	BTV1
Temperature:	25 °C	Relative Humidity:	58 %
Pressure:	1010 hPa	Test Voltage :	AC 120V/60Hz
Test Mode :	TX 2441MHz –CH39-1Mbps		

Freq.	Ant.Pol.	Reading		Ant./CF	Act.		Limit		Note
		Peak	AV		Peak	AV	Peak	AV	
(MHz)	H/V	(dBuV)	(dBuV)	CF(dB)	(dBuV/m)	(dBuV/m)	(dBuV/m)	(dBuV/m)	
<b>2441.00</b>	<b>V</b>	<b>63.65</b>	<b>53.74</b>	<b>34.25</b>	<b>97.90</b>	<b>87.99</b>			<b>X/F</b>
4881.98	V	44.30	34.27	6.61	50.91	40.88	74.00	54.00	X/H

Remark:

- (1) All readings are Peak unless otherwise stated QP in column of 『Note』 . Peak denotes that the Peak reading compliance with the QP Limits and then QP Mode measurement didn't perform.
- (2) Measuring frequency range from 30MHz to 1000MHz or the 10th harmonic of highest fundamental frequency. "F" denotes fundamental frequency; "H" denotes spurious frequency. "E" denotes band edge frequency. (This judgment method includes the Band Edge Requirement.)
- (3) Radiated emissions measured in frequency range above 1000MHz were made with an instrument using Peak detector mode and AV detector mode of the emission .
- (4) Data of measurement within this frequency range shown " \* " in the table above means the reading of emissions are attenuated more than 20dB below the permissible limits or the field strength is too small to be measured.
- (5) A preamp and high pass filter were used for this test in order to provide sufficient measurement sensitivity.
- (6) EUT Orthogonal Axis:  
"X" - denotes Laid on Table ; "Y" - denotes Vertical Stand ; "Z" - denotes Side Stand
- (7) During the measurements above 1 GHz it is taken care of that the EUT is always within the 3 dB cone of radiation BW of the used antenna



TX CH39 (Above 1000 MHz, Vertical)

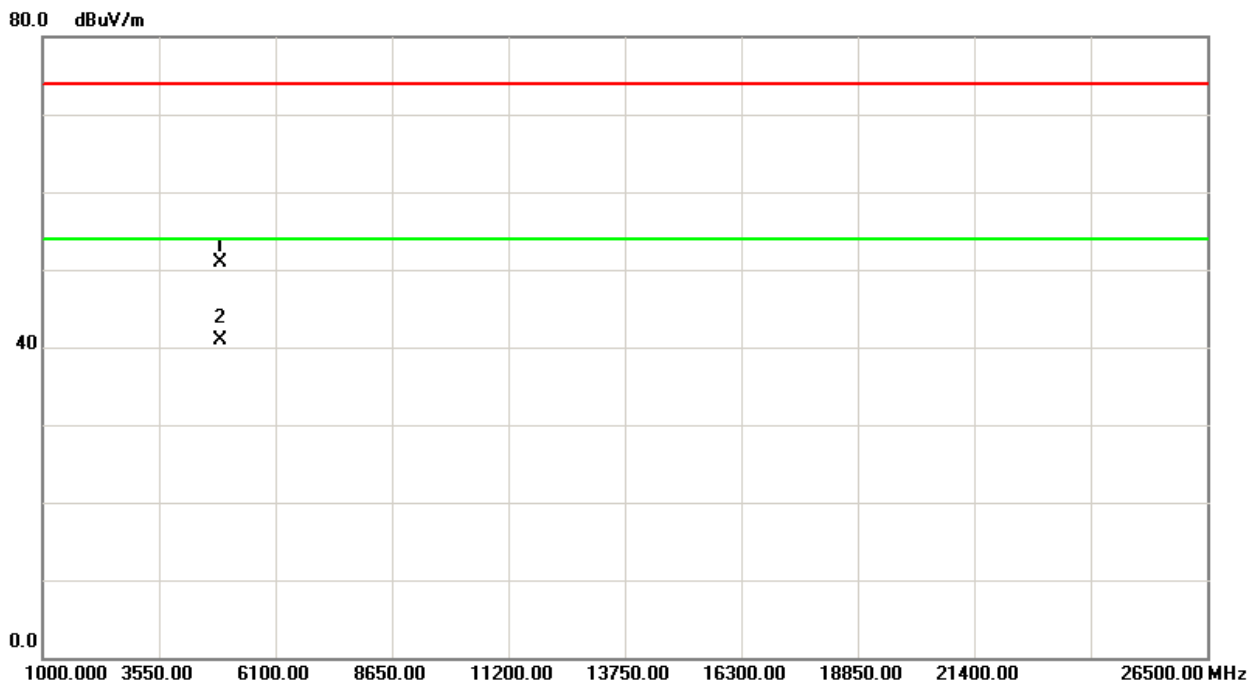
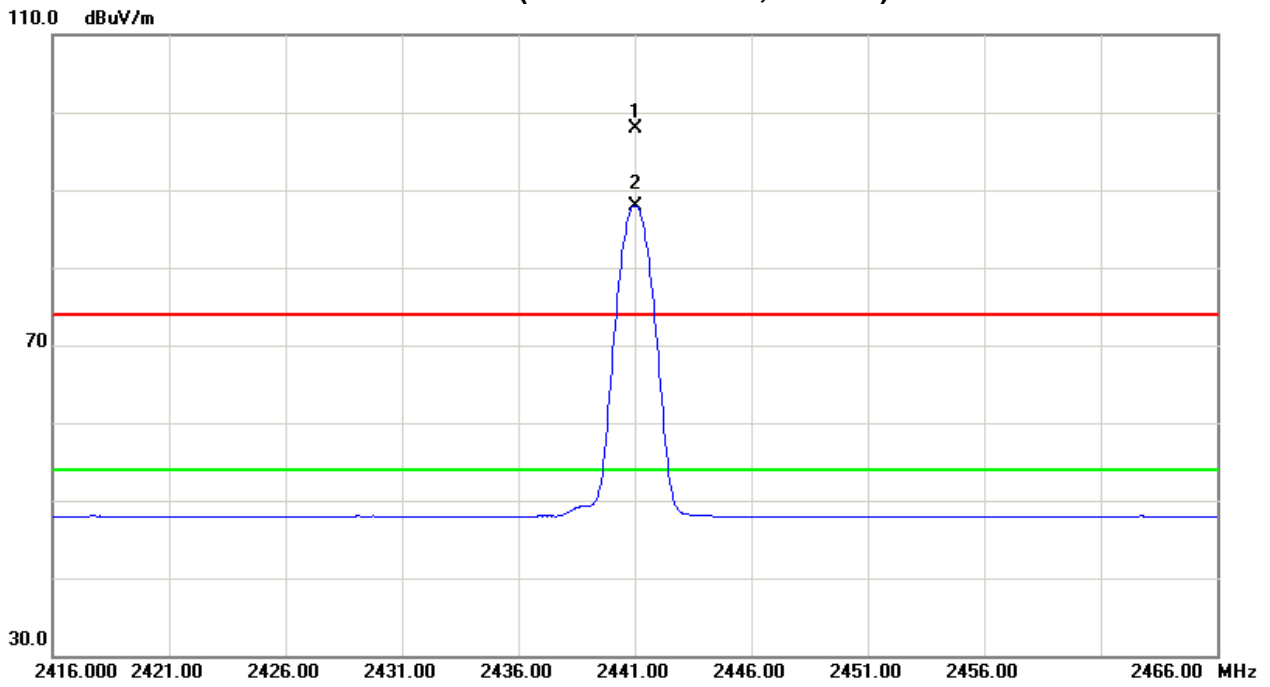



EUT:	Portable Bluetooth Speaker	Model Name :	BTV1
Temperature:	25 °C	Relative Humidity:	58 %
Pressure:	1010 hPa	Test Voltage :	AC 120V/60Hz
Test Mode :	TX 2441MHz –CH39-1Mbps		

Freq.	Ant.Pol.	Reading		Ant./CF	Act.		Limit		Note
		Peak	AV		Peak	AV	Peak	AV	
(MHz)	H/V	(dBuV)	(dBuV)	CF(dB)	(dBuV/m)	(dBuV/m)	(dBuV/m)	(dBuV/m)	
<b>2441.00</b>	<b>H</b>	<b>59.16</b>	<b>49.19</b>	<b>34.25</b>	<b>93.41</b>	<b>83.44</b>			<b>X/F</b>
4881.98	H	42.04	31.91	6.61	48.65	38.52	74.00	54.00	X/H

Remark:

- (1) All readings are Peak unless otherwise stated QP in column of 『Note』 . Peak denotes that the Peak reading compliance with the QP Limits and then QP Mode measurement didn't perform.
- (2) Measuring frequency range from 30MHz to 1000MHz or the 10th harmonic of highest fundamental frequency. "F" denotes fundamental frequency; "H" denotes spurious frequency. "E" denotes band edge frequency. (This judgment method includes the Band Edge Requirement.)
- (3) Radiated emissions measured in frequency range above 1000MHz were made with an instrument using Peak detector mode and AV detector mode of the emission .
- (4) Data of measurement within this frequency range shown " \* " in the table above means the reading of emissions are attenuated more than 20dB below the permissible limits or the field strength is too small to be measured.
- (5) A preamp and high pass filter were used for this test in order to provide sufficient measurement sensitivity.
- (6) EUT Orthogonal Axis:  
"X" - denotes Laid on Table ; "Y" - denotes Vertical Stand ; "Z" - denotes Side Stand
- (7) During the measurements above 1 GHz it is taken care of that the EUT is always within the 3 dB cone of radiation BW of the used antenna



TX CH39 (Above 1000 MHz, Horizontal)

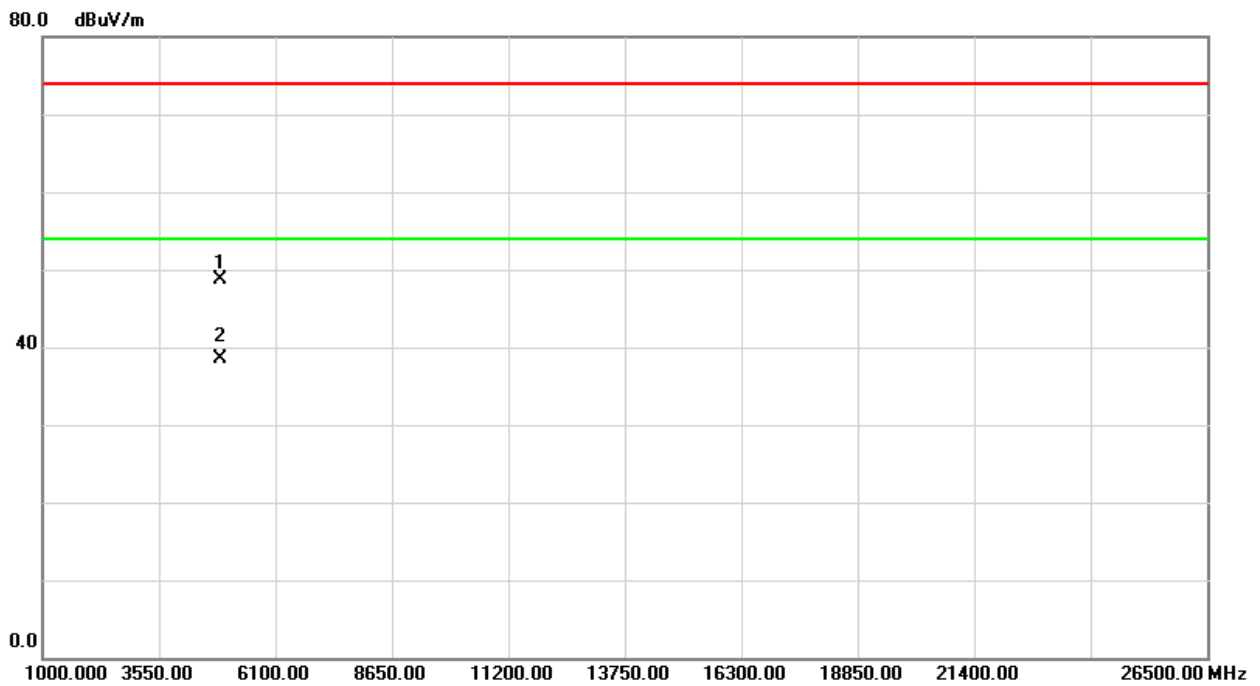
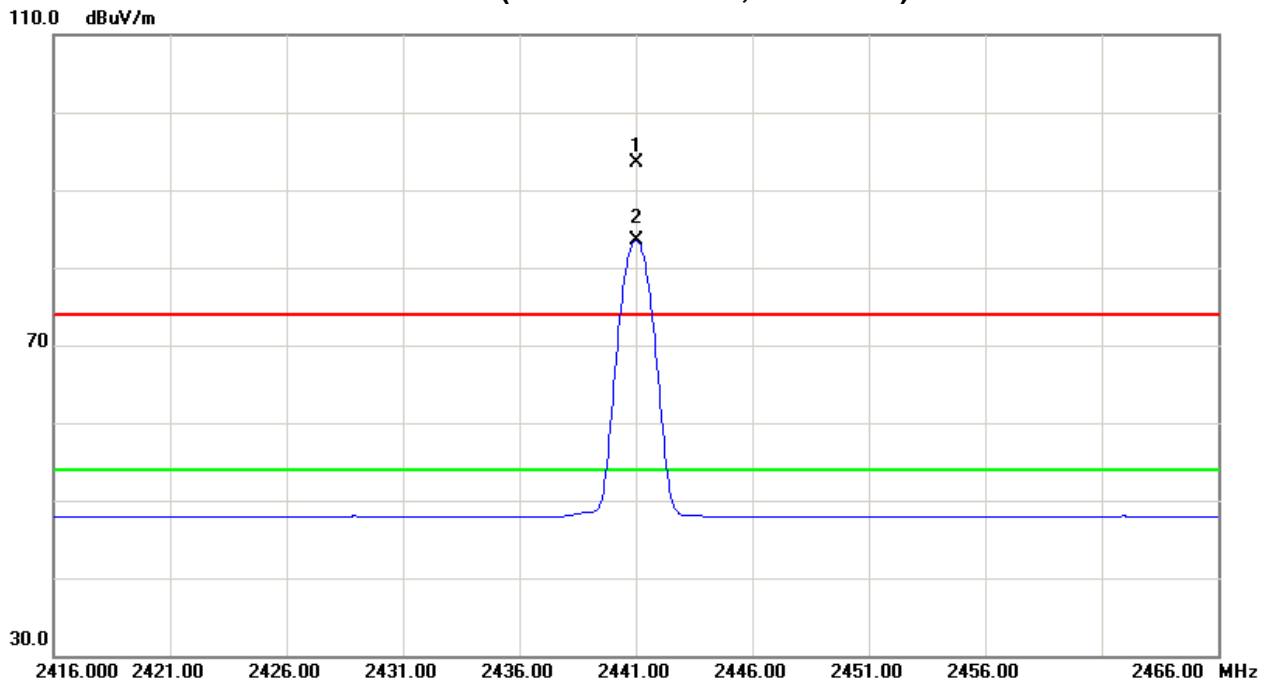



EUT:	Portable Bluetooth Speaker	Model Name :	BTV1
Temperature:	25 °C	Relative Humidity:	58 %
Pressure:	1010hPa	Test Voltage :	AC 120V/60Hz
Test Mode :	TX 2480MHz –CH78-1Mbps		

Freq.	Ant.Pol.	Reading		Ant./CF	Act.		Limit		Note
		Peak	AV		Peak	AV	Peak	AV	
(MHz)	H/V	(dBuV)	(dBuV)	CF(dB)	(dBuV/m)	(dBuV/m)	(dBuV/m)	(dBuV/m)	
<b>2480.00</b>	<b>V</b>	<b>58.96</b>	<b>49.15</b>	<b>34.36</b>	<b>93.32</b>	<b>83.51</b>			<b>X/F</b>
2483.50	V	22.37	13.50	34.37	56.74	47.87	74.00	54.00	X/E
4959.99	V	43.43	33.13	6.83	50.26	39.96	74.00	54.00	X/H

Remark:

- (1) All readings are Peak unless otherwise stated QP in column of 『Note』 . Peak denotes that the Peak reading compliance with the QP Limits and then QP Mode measurement didn't perform.
- (2) Measuring frequency range from 30MHz to 1000MHz or the 10th harmonic of highest fundamental frequency. "F" denotes fundamental frequency; "H" denotes spurious frequency. "E" denotes band edge frequency. (This judgment method includes the Band Edge Requirement.)
- (3) Radiated emissions measured in frequency range above 1000MHz were made with an instrument using Peak detector mode and AV detector mode of the emission .
- (4) Data of measurement within this frequency range shown " \* " in the table above means the reading of emissions are attenuated more than 20dB below the permissible limits or the field strength is too small to be measured.
- (5) A preamp and high pass filter were used for this test in order to provide sufficient measurement sensitivity.
- (6) EUT Orthogonal Axis:  
"X" - denotes Laid on Table ; "Y" - denotes Vertical Stand ; "Z" - denotes Side Stand
- (7) During the measurements above 1 GHz it is taken care of that the EUT is always within the 3 dB cone of radiation BW of the used antenna





TX CH78 (Above 1000 MHz, Vertical)

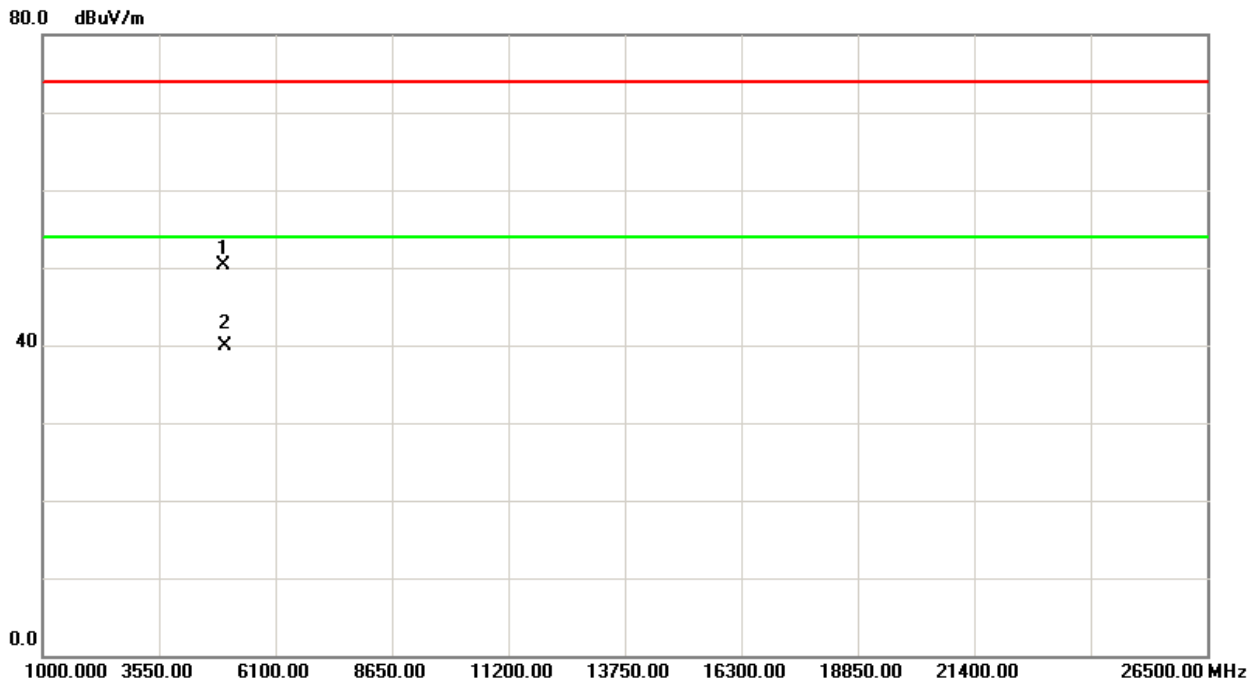
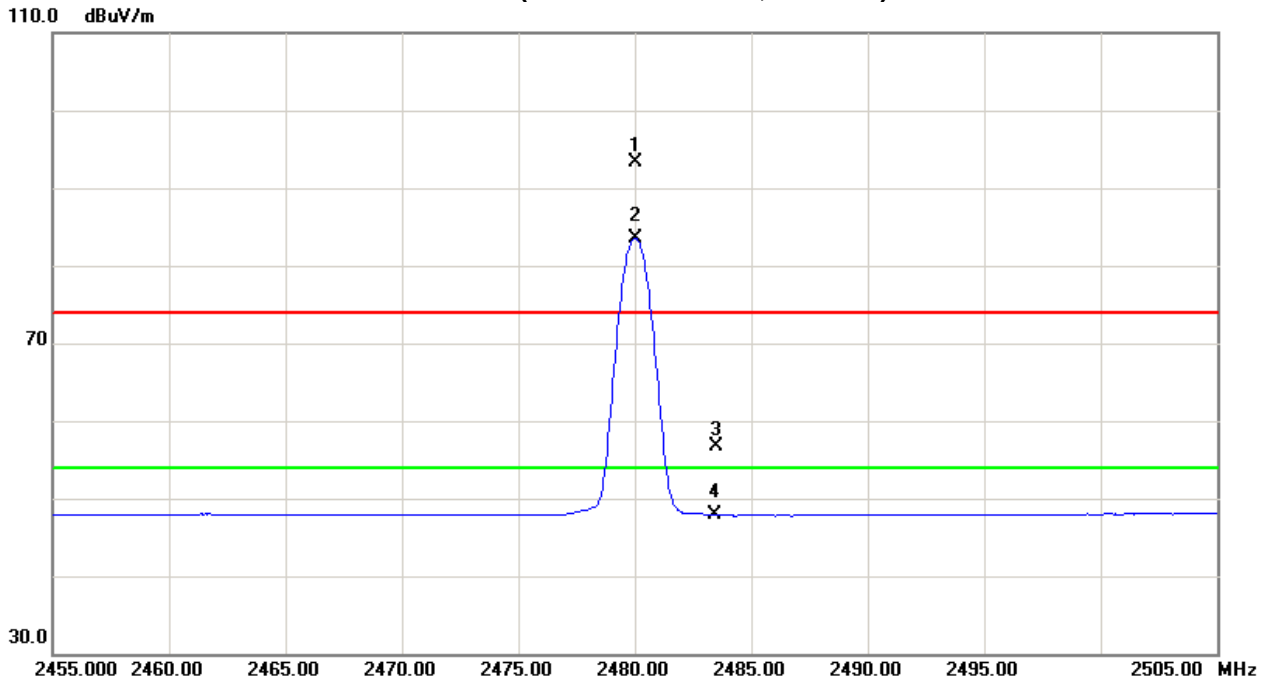



EUT:	Portable Bluetooth Speaker	Model Name :	BTV1
Temperature:	25 °C	Relative Humidity:	58 %
Pressure:	1010 hPa	Test Voltage :	AC 120V/60Hz
Test Mode :	TX 2480MHz –CH78-1Mbps		

Freq.	Ant.Pol.	Reading		Ant./CF	Act.		Limit		Note
		Peak	AV		Peak	AV	Peak	AV	
(MHz)	H/V	(dBuV)	(dBuV)	CF(dB)	(dBuV/m)	(dBuV/m)	(dBuV/m)	(dBuV/m)	
<b>2479.85</b>	<b>H</b>	<b>62.30</b>	<b>52.43</b>	<b>34.36</b>	<b>96.66</b>	<b>86.79</b>			<b>X/F</b>
2483.50	H	22.50	13.52	34.37	56.87	47.89	74.00	54.00	X/E
4960.00	H	44.03	33.20	6.83	50.86	40.03	74.00	54.00	X/H

Remark:

- (1) All readings are Peak unless otherwise stated QP in column of 『Note』 . Peak denotes that the Peak reading compliance with the QP Limits and then QP Mode measurement didn't perform.
- (2) Measuring frequency range from 30MHz to 1000MHz or the 10th harmonic of highest fundamental frequency. "F" denotes fundamental frequency; "H" denotes spurious frequency. "E" denotes band edge frequency. (This judgment method includes the Band Edge Requirement.)
- (3) Radiated emissions measured in frequency range above 1000MHz were made with an instrument using Peak detector mode and AV detector mode of the emission .
- (4) Data of measurement within this frequency range shown " \* " in the table above means the reading of emissions are attenuated more than 20dB below the permissible limits or the field strength is too small to be measured.
- (5) A preamp and high pass filter were used for this test in order to provide sufficient measurement sensitivity.
- (6) EUT Orthogonal Axis:  
"X" - denotes Laid on Table ; "Y" - denotes Vertical Stand ; "Z" - denotes Side Stand
- (7) During the measurements above 1 GHz it is taken care of that the EUT is always within the 3 dB cone of radiation BW of the used antenna



TX CH78 (Above 1000 MHz, Horizontal)

100.0 dBuV/m

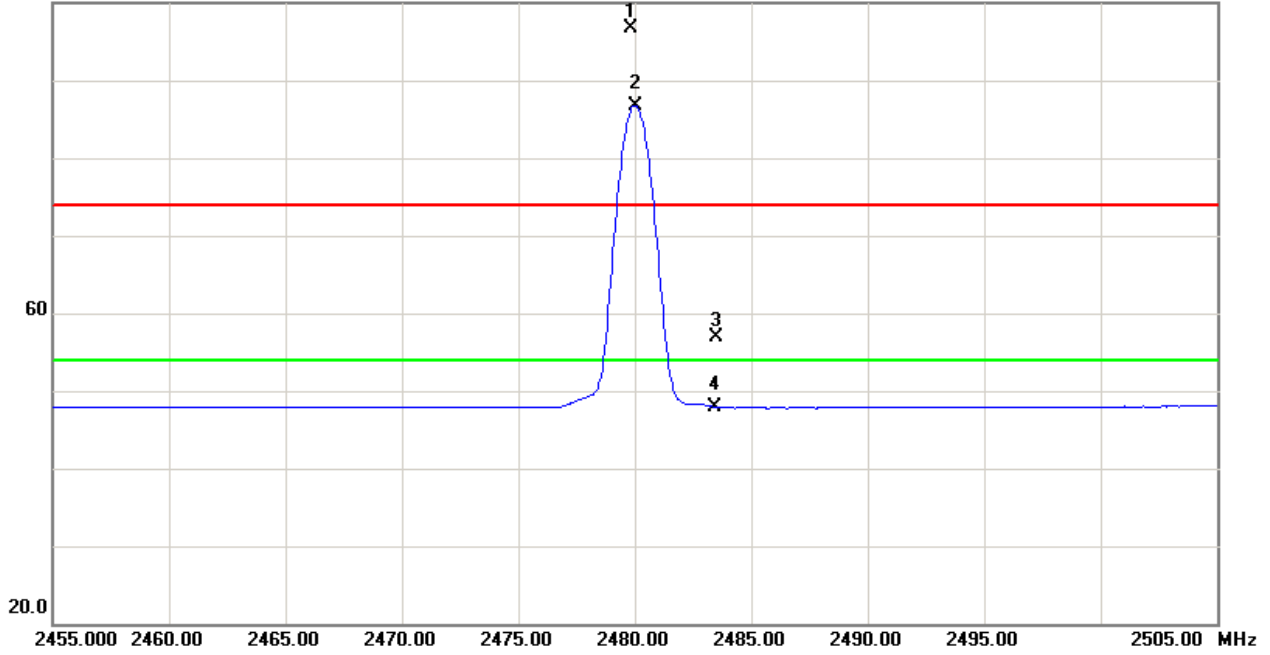

80.0 dBuV/m

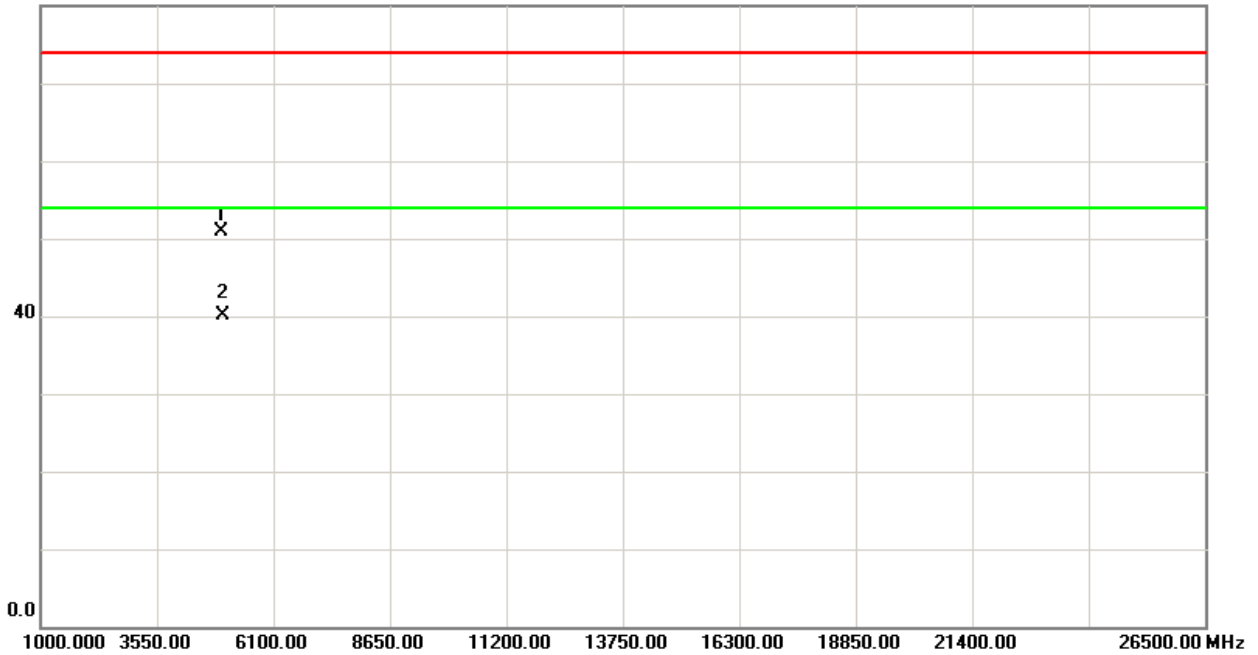



EUT:	Portable Bluetooth Speaker	Model Name :	BTV1
Temperature:	25 °C	Relative Humidity:	58 %
Pressure:	1010 hPa	Test Voltage :	AC 120V/60Hz
Test Mode :	TX 2402MHz – CH 00-3Mbps		

Freq. (MHz)	Ant.Pol. H/V	Reading		Ant./CF CF(dB)	Act.		Limit		Note
		Peak (dBuV)	AV (dBuV)		Peak (dBuV/m)	AV (dBuV/m)	Peak (dBuV/m)	AV (dBuV/m)	
2390.00	V	23.06	13.43	34.09	57.15	47.52	74.00	54.00	X/E
<b>2402.00</b>	<b>V</b>	<b>61.78</b>	<b>50.72</b>	<b>34.12</b>	<b>95.90</b>	<b>84.84</b>			<b>X/F</b>
4804.01	V	42.15	32.03	6.38	48.53	38.41	74.00	54.00	X/H

**Remark:**

- (1) All readings are Peak unless otherwise stated QP in column of 『Note』 . Peak denotes that the Peak reading compliance with the QP Limits and then QP Mode measurement didn't perform.
- (2) Measuring frequency range from 30MHz to 1000MHz or the 10th harmonic of highest fundamental frequency. "F" denotes fundamental frequency; "H" denotes spurious frequency. "E" denotes band edge frequency. (This judgment method includes the Band Edge Requirement.)
- (3) Radiated emissions measured in frequency range above 1000MHz were made with an instrument using Peak detector mode and AV detector mode of the emission .
- (4) Data of measurement within this frequency range shown " \* " in the table above means the reading of emissions are attenuated more than 20dB below the permissible limits or the field strength is too small to be measured.
- (5) A preamp and high pass filter were used for this test in order to provide sufficient measurement sensitivity.
- (6) EUT Orthogonal Axis:  
"X" - denotes Laid on Table ; "Y" - denotes Vertical Stand ; "Z" - denotes Side Stand
- (7) During the measurements above 1 GHz it is taken care of that the EUT is always within the 3 dB cone of radiation BW of the used antenna



TX CH00(Above 1000 MHz, Vertical)

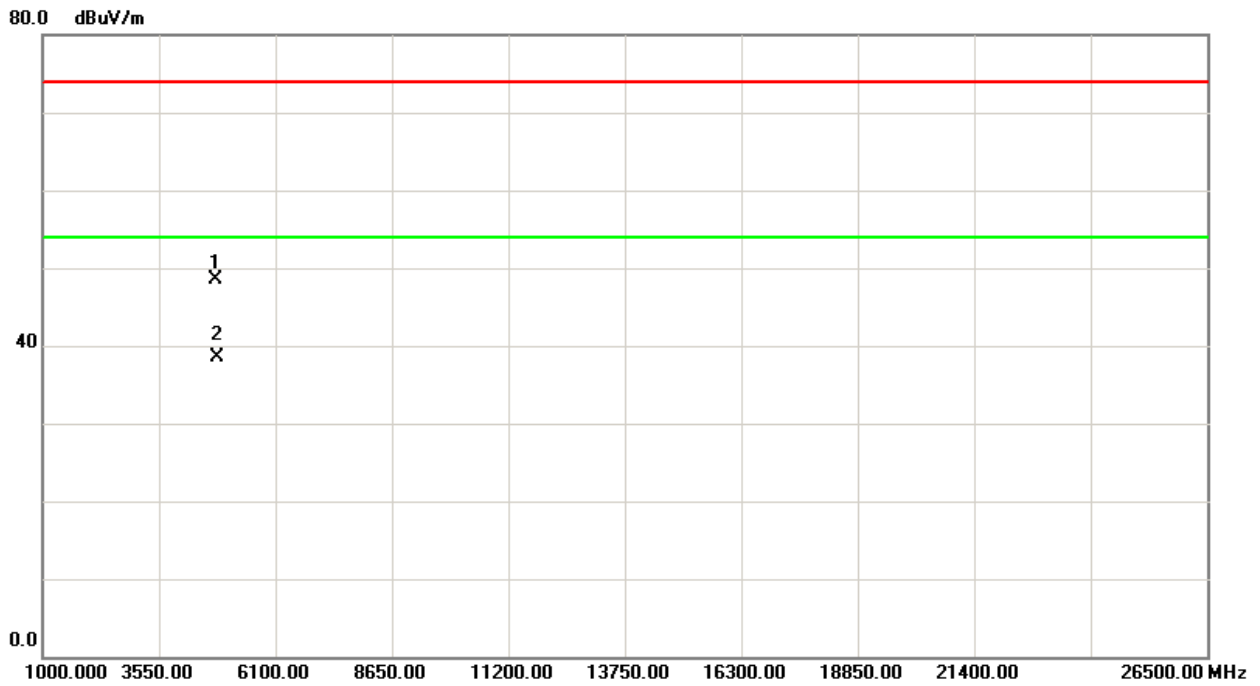
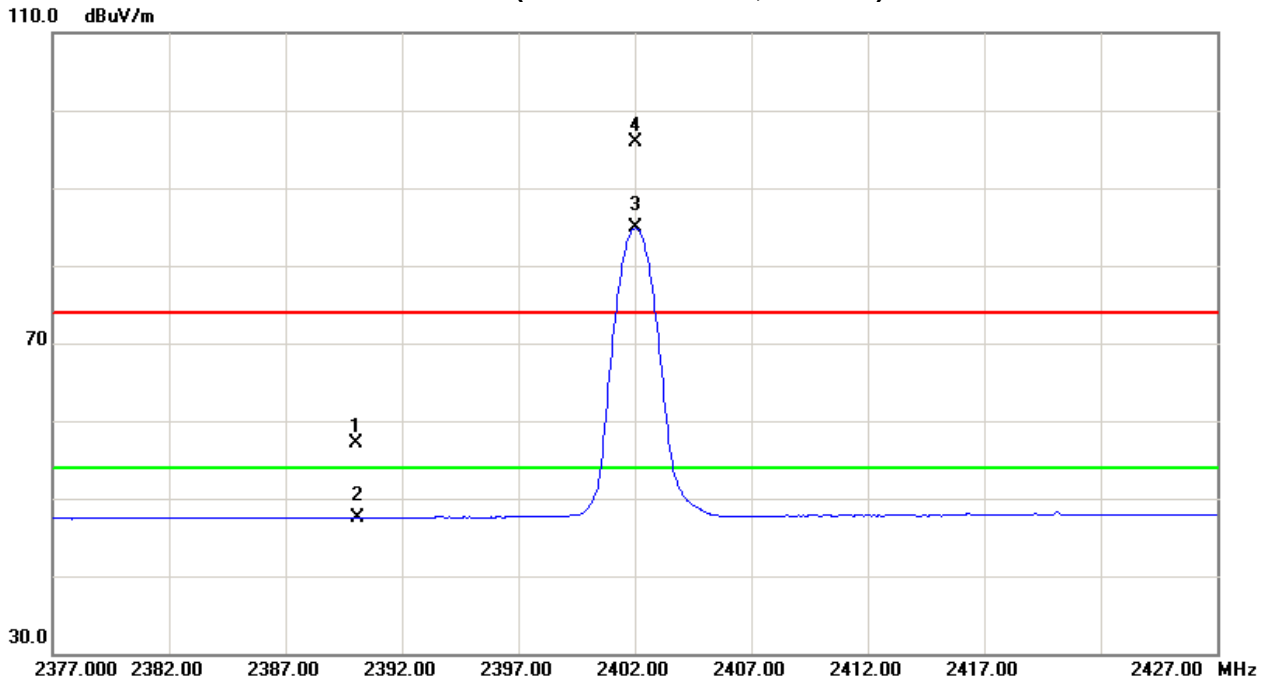



EUT:	Portable Bluetooth Speaker	Model Name :	BTV1
Temperature:	25 °C	Relative Humidity:	58 %
Pressure:	1010hPa	Test Voltage :	AC 120V/60Hz
Test Mode :	TX 2402MHz – CH 00-3Mbps		

Freq. (MHz)	Ant.Pol. H/V	Reading		Ant./CF CF(dB)	Act.		Limit		Note
		Peak (dBuV)	AV (dBuV)		Peak (dBuV/m)	AV (dBuV/m)	Peak (dBuV/m)	AV (dBuV/m)	
2390.00	H	23.12	13.42	34.09	57.21	47.51	74.00	54.00	X/E
<b>2402.00</b>	<b>H</b>	<b>57.33</b>	<b>46.19</b>	<b>34.12</b>	<b>91.45</b>	<b>80.31</b>			<b>X/F</b>
4804.01	H	42.74	32.54	6.38	49.12	38.92	74.00	54.00	X/H

Remark:

- (1) All readings are Peak unless otherwise stated QP in column of 『Note』 . Peak denotes that the Peak reading compliance with the QP Limits and then QP Mode measurement didn't perform.
- (2) Measuring frequency range from 30MHz to 1000MHz or the 10th harmonic of highest fundamental frequency. "F" denotes fundamental frequency; "H" denotes spurious frequency. "E" denotes band edge frequency. (This judgment method includes the Band Edge Requirement.)
- (3) Radiated emissions measured in frequency range above 1000MHz were made with an instrument using Peak detector mode and AV detector mode of the emission .
- (4) Data of measurement within this frequency range shown " \* " in the table above means the reading of emissions are attenuated more than 20dB below the permissible limits or the field strength is too small to be measured.
- (5) A preamp and high pass filter were used for this test in order to provide sufficient measurement sensitivity.
- (6) EUT Orthogonal Axis:  
"X" - denotes Laid on Table ; "Y" - denotes Vertical Stand ; "Z" - denotes Side Stand
- (7) During the measurements above 1 GHz it is taken care of that the EUT is always within the 3 dB cone of radiation BW of the used antenna



TX CH00(Above 1000 MHz, Horizontal)

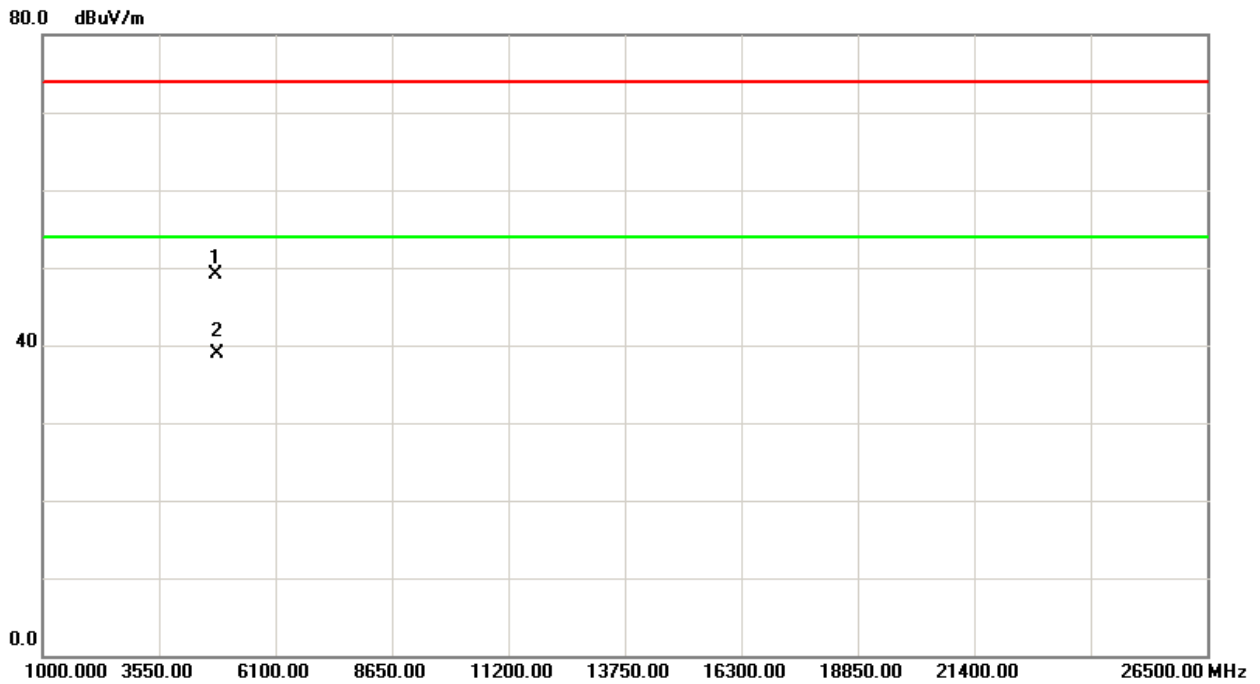
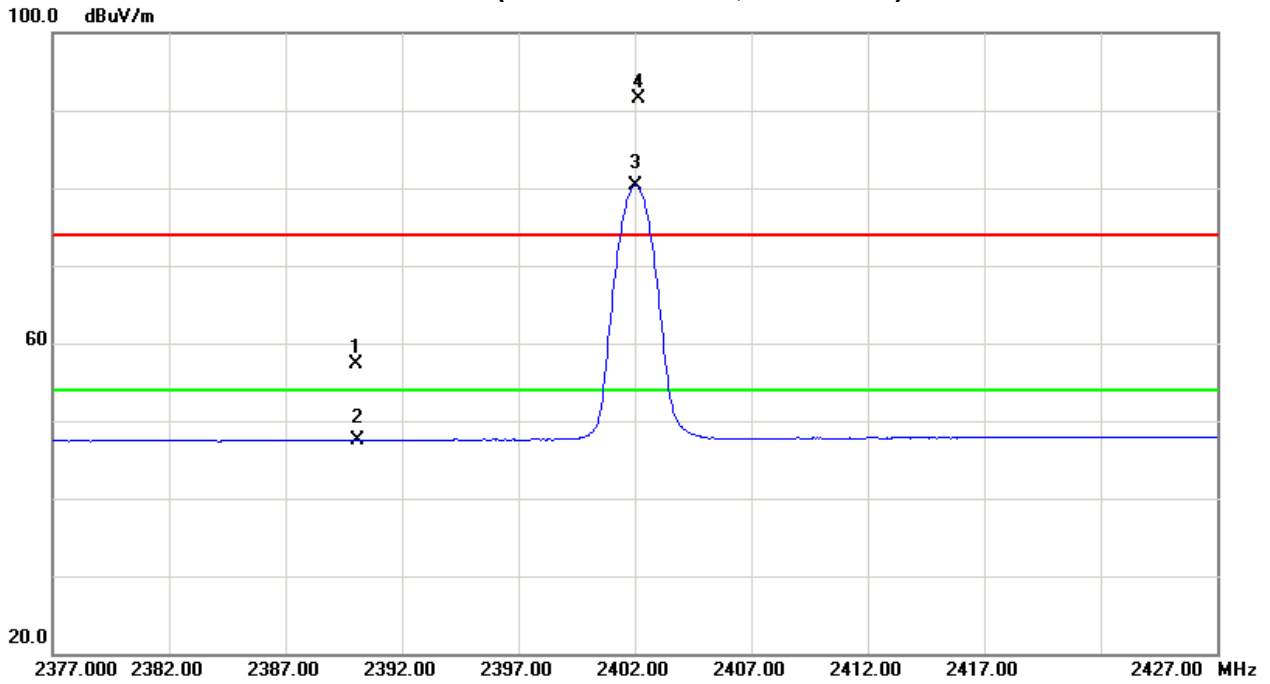



EUT:	Portable Bluetooth Speaker	Model Name :	BTV1
Temperature:	25 °C	Relative Humidity:	58 %
Pressure:	1010 hPa	Test Voltage :	AC 120V/60Hz
Test Mode :	TX 2441MHz –CH39-3Mbps		

Freq.	Ant.Pol.	Reading		Ant./CF	Act.		Limit		Note
		Peak	AV		Peak	AV	Peak	AV	
(MHz)	H/V	(dBuV)	(dBuV)	CF(dB)	(dBuV/m)	(dBuV/m)	(dBuV/m)	(dBuV/m)	
<b>2441.00</b>	<b>V</b>	<b>63.11</b>	<b>52.05</b>	<b>34.25</b>	<b>97.36</b>	<b>86.30</b>			<b>X/F</b>
4881.99	V	44.32	34.17	6.61	50.93	40.78	74.00	54.00	X/H

Remark:

- (1) All readings are Peak unless otherwise stated QP in column of 『Note』 . Peak denotes that the Peak reading compliance with the QP Limits and then QP Mode measurement didn't perform.
- (2) Measuring frequency range from 30MHz to 1000MHz or the 10th harmonic of highest fundamental frequency. "F" denotes fundamental frequency; "H" denotes spurious frequency. "E" denotes band edge frequency. (This judgment method includes the Band Edge Requirement.)
- (3) Radiated emissions measured in frequency range above 1000MHz were made with an instrument using Peak detector mode and AV detector mode of the emission .
- (4) Data of measurement within this frequency range shown " \* " in the table above means the reading of emissions are attenuated more than 20dB below the permissible limits or the field strength is too small to be measured.
- (5) A preamp and high pass filter were used for this test in order to provide sufficient measurement sensitivity.
- (6) EUT Orthogonal Axis:  
"X" - denotes Laid on Table ; "Y" - denotes Vertical Stand ; "Z" - denotes Side Stand
- (7) During the measurements above 1 GHz it is taken care of that the EUT is always within the 3 dB cone of radiation BW of the used antenna





TX CH39 (Above 1000 MHz, Vertical)

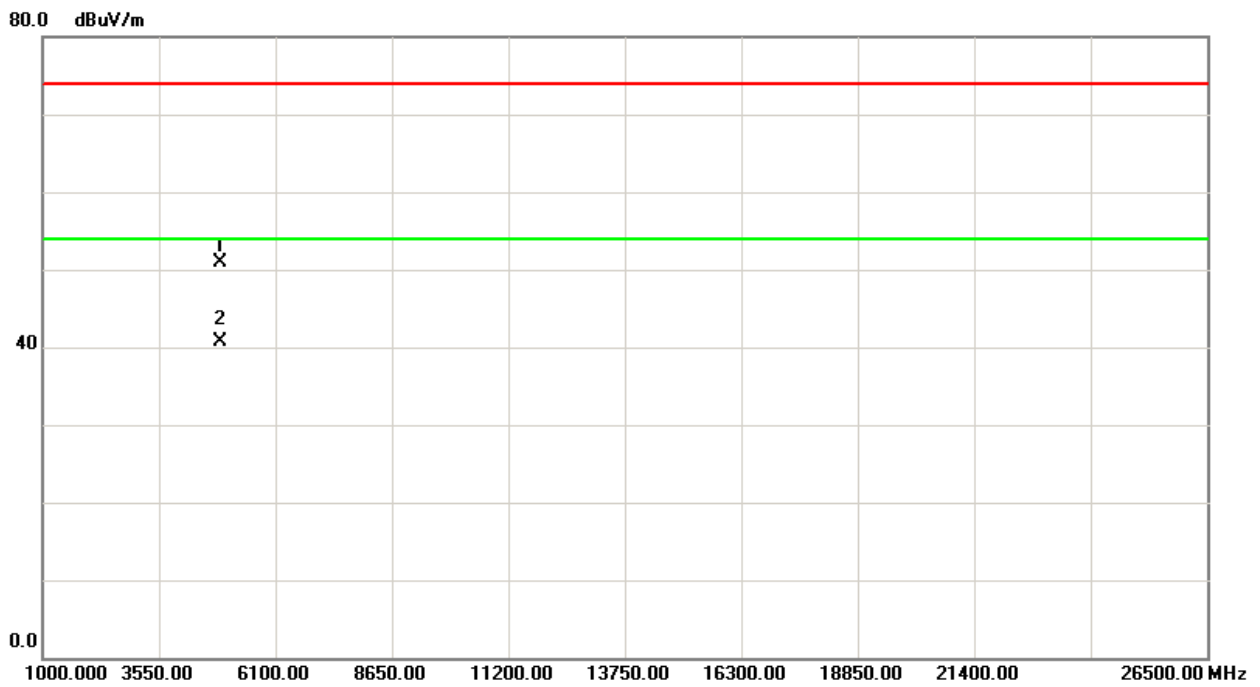
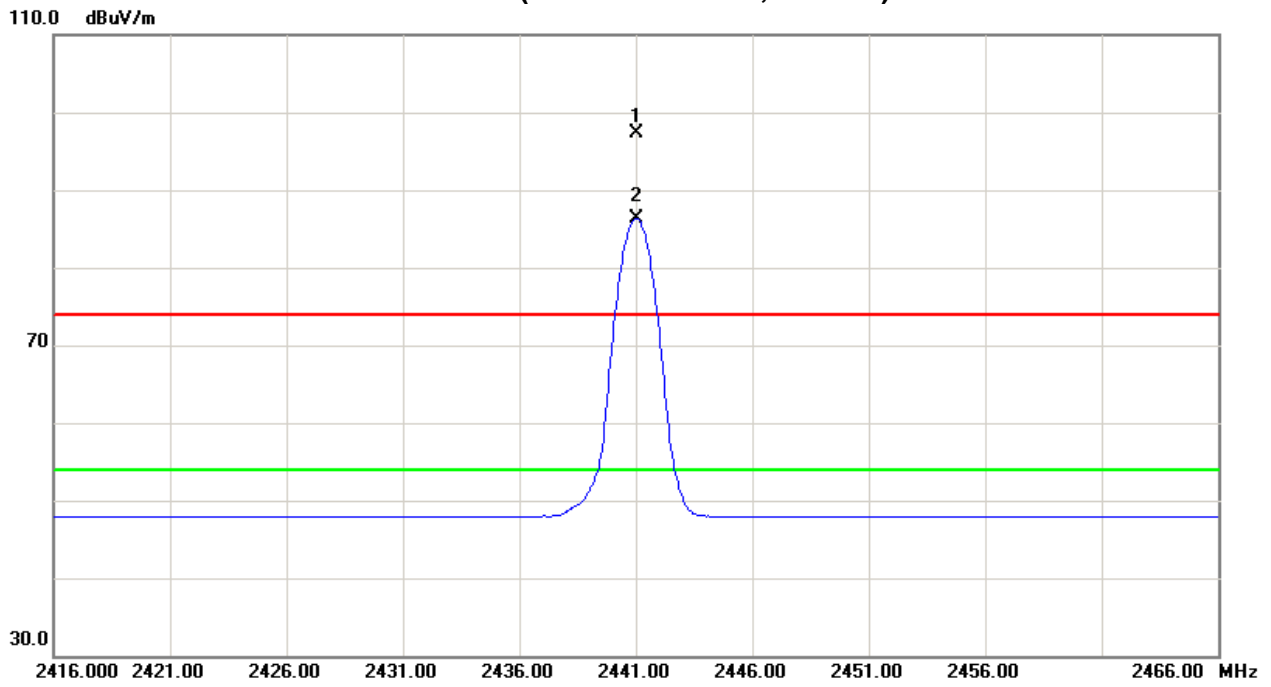



EUT:	Portable Bluetooth Speaker	Model Name :	BTV1
Temperature:	25 °C	Relative Humidity:	58 %
Pressure:	1010 hPa	Test Voltage :	AC 120V/60Hz
Test Mode :	TX 2441MHz –CH39-3Mbps		

Freq.	Ant.Pol.	Reading		Ant/CF	Act.		Limit		Note
		Peak	AV		Peak	AV	Peak	AV	
(MHz)	H/V	(dBuV)	(dBuV)	CF(dB)	(dBuV/m)	(dBuV/m)	(dBuV/m)	(dBuV/m)	
<b>2441.00</b>	<b>H</b>	<b>56.89</b>	<b>45.85</b>	<b>34.25</b>	<b>91.14</b>	<b>80.10</b>			<b>X/F</b>
4881.99	H	42.34	32.10	6.61	48.95	38.71	74.00	54.00	X/H

Remark:

- (1) All readings are Peak unless otherwise stated QP in column of 『Note』 . Peak denotes that the Peak reading compliance with the QP Limits and then QP Mode measurement didn't perform.
- (2) Measuring frequency range from 30MHz to 1000MHz or the 10th harmonic of highest fundamental frequency."F" denotes fundamental frequency; "H" denotes spurious frequency. "E" denotes band edge frequency. (This judgment method includes the Band Edge Requirement.)
- (3) Radiated emissions measured in frequency range above 1000MHz were made with an instrument using Peak detector mode and AV detector mode of the emission.
- (4) Data of measurement within this frequency range shown " \* " in the table above means the reading of emissions are attenuated more than 20dB below the permissible limits or the field strength is too small to be measured.
- (5) A preamp and high pass filter were used for this test in order to provide sufficient measurement sensitivity.
- (6) EUT Orthogonal Axis:  
"X" - denotes Laid on Table ; "Y" - denotes Vertical Stand ; "Z" - denotes Side Stand
- (7) During the measurements above 1 GHz it is taken care of that the EUT is always within the 3 dB cone of radiation BW of the used antenna



TX CH39 (Above 1000 MHz, Horizontal)

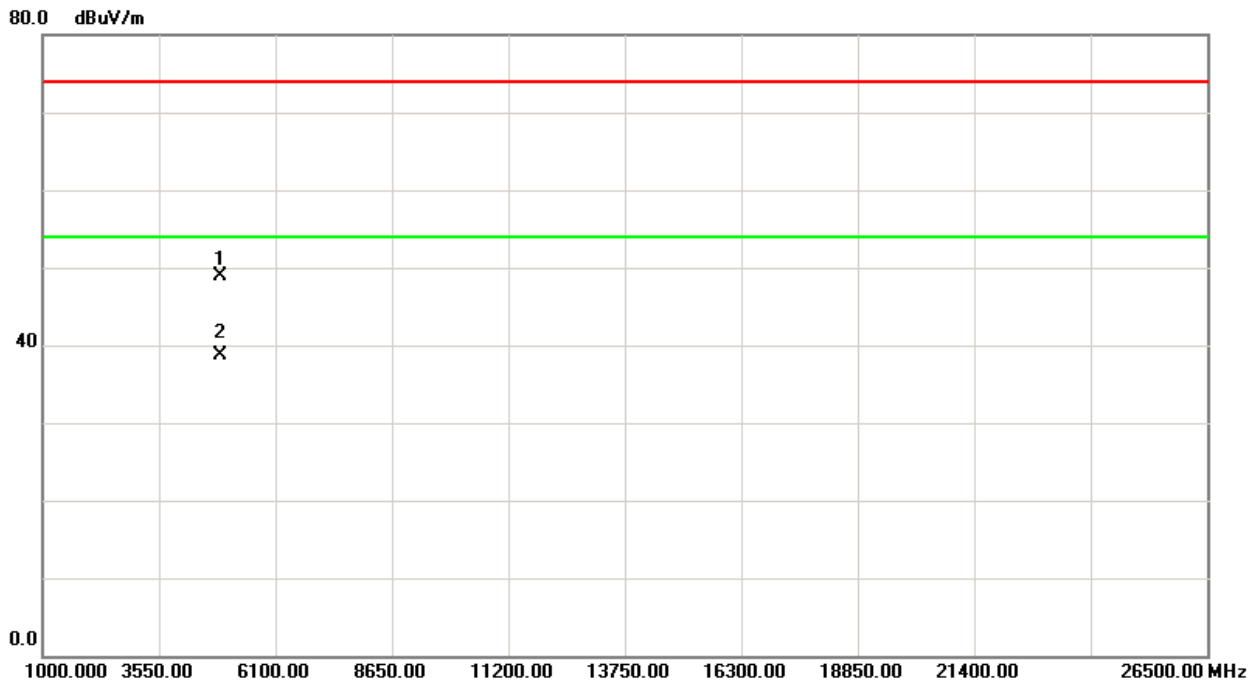
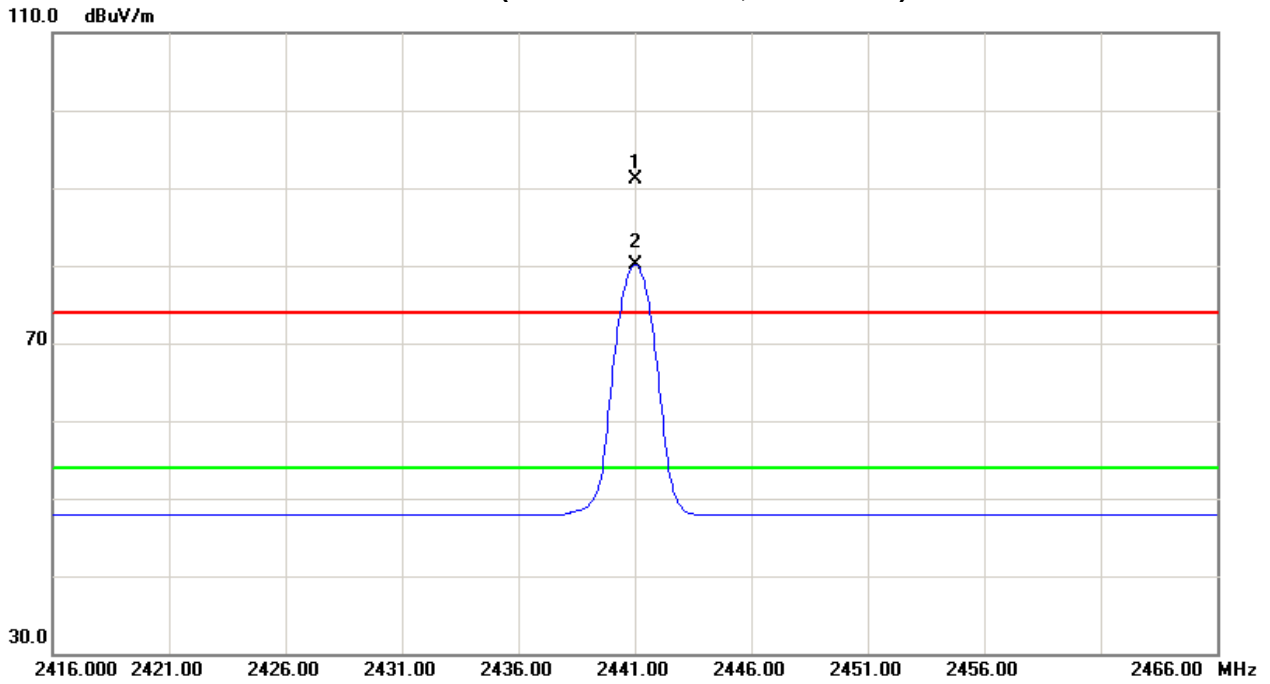



EUT:	Portable Bluetooth Speaker	Model Name :	BTV1
Temperature:	25 °C	Relative Humidity:	58 %
Pressure:	1010hPa	Test Voltage :	AC 120V/60Hz
Test Mode :	TX 2480MHz –CH78-3Mbps		

Freq.	Ant.Pol.	Reading		Ant./CF	Act.		Limit		Note
		Peak	AV		Peak	AV	Peak	AV	
(MHz)	H/V	(dBuV)	(dBuV)	CF(dB)	(dBuV/m)	(dBuV/m)	(dBuV/m)	(dBuV/m)	
<b>2480.00</b>	<b>V</b>	<b>61.51</b>	<b>50.40</b>	<b>34.36</b>	<b>95.87</b>	<b>84.76</b>			<b>X/F</b>
2483.50	V	22.52	13.50	34.37	56.89	47.87	74.00	54.00	X/E
4960.00	V	42.69	32.53	6.83	49.52	39.36	74.00	54.00	X/H

Remark:

- (1) All readings are Peak unless otherwise stated QP in column of 『Note』 . Peak denotes that the Peak reading compliance with the QP Limits and then QP Mode measurement didn't perform.
- (2) Measuring frequency range from 30MHz to 1000MHz or the 10th harmonic of highest fundamental frequency. "F" denotes fundamental frequency; "H" denotes spurious frequency. "E" denotes band edge frequency. (This judgment method includes the Band Edge Requirement.)
- (3) Radiated emissions measured in frequency range above 1000MHz were made with an instrument using Peak detector mode and AV detector mode of the emission .
- (4) Data of measurement within this frequency range shown " \* " in the table above means the reading of emissions are attenuated more than 20dB below the permissible limits or the field strength is too small to be measured.
- (5) A preamp and high pass filter were used for this test in order to provide sufficient measurement sensitivity.
- (6) EUT Orthogonal Axis:  
"X" - denotes Laid on Table ; "Y" - denotes Vertical Stand ; "Z" - denotes Side Stand
- (7) During the measurements above 1 GHz it is taken care of that the EUT is always within the 3 dB cone of radiation BW of the used antenna



TX CH78 (Above 1000 MHz, Vertical)

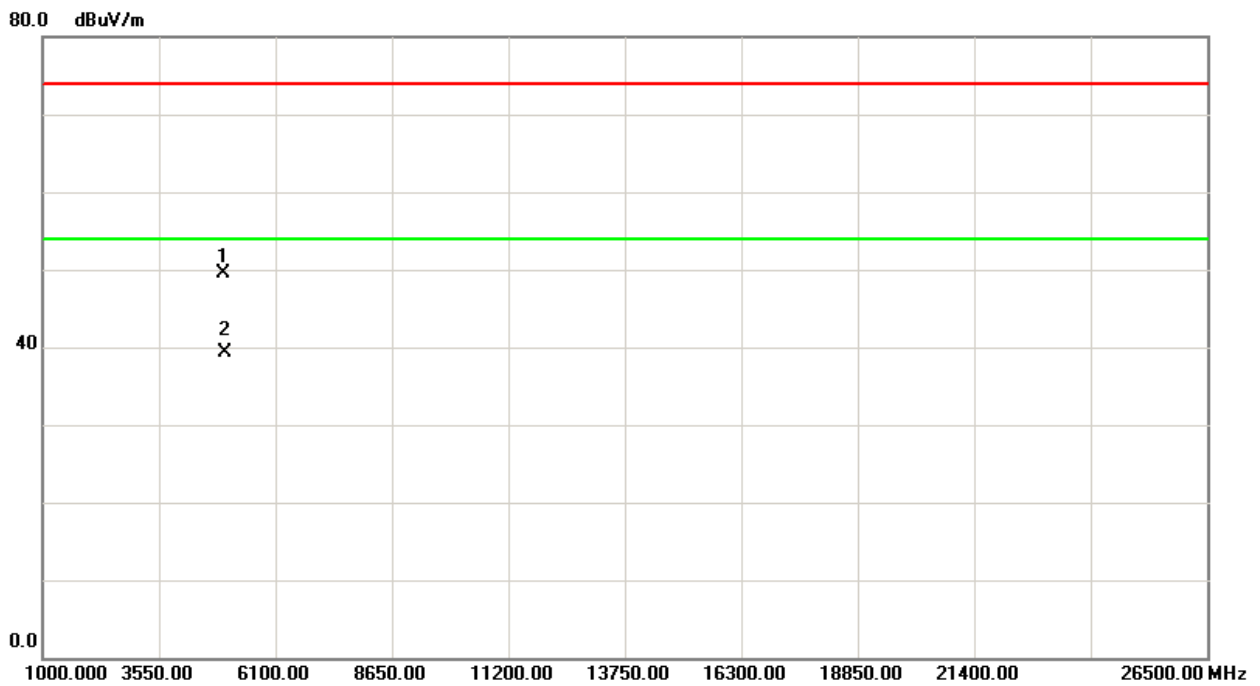
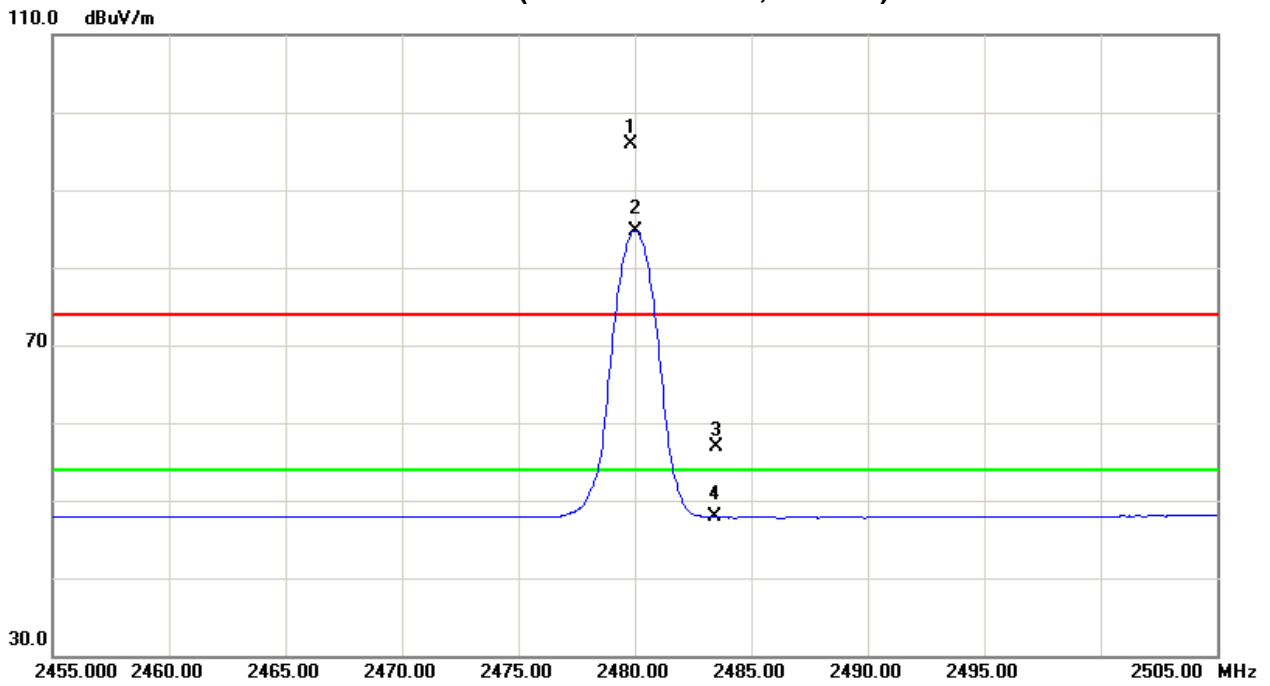



EUT:	Portable Bluetooth Speaker	Model Name :	BTV1
Temperature:	25 °C	Relative Humidity:	58 %
Pressure:	1010 hPa	Test Voltage :	AC 120V/60Hz
Test Mode :	TX 2480MHz –CH78-3Mbps		

Freq.	Ant.Pol.	Reading		Ant./CF	Act.		Limit		Note
		Peak	AV		Peak	AV	Peak	AV	
(MHz)	H/V	(dBuV)	(dBuV)	CF(dB)	(dBuV/m)	(dBuV/m)	(dBuV/m)	(dBuV/m)	
<b>2480.00</b>	<b>H</b>	<b>58.49</b>	<b>47.41</b>	<b>34.36</b>	<b>92.85</b>	<b>81.77</b>			<b>X/F</b>
2483.50	H	22.74	13.45	34.37	57.11	47.82	74.00	54.00	X/E
4960.00	H	44.25	33.44	6.83	51.08	40.27	74.00	54.00	X/H

**Remark:**

- (1) All readings are Peak unless otherwise stated QP in column of 『Note』 . Peak denotes that the Peak reading compliance with the QP Limits and then QP Mode measurement didn't perform.
- (2) Measuring frequency range from 30MHz to 1000MHz or the 10th harmonic of highest fundamental frequency.“F” denotes fundamental frequency; “H” denotes spurious frequency. “E” denotes band edge frequency. (This judgment method includes the Band Edge Requirement.)
- (3) Radiated emissions measured in frequency range above 1000MHz were made with an instrument using Peak detector mode and AV detector mode of the emission .
- (4) Data of measurement within this frequency range shown “ \* ” in the table above means the reading of emissions are attenuated more than 20dB below the permissible limits or the field strength is too small to be measured.
- (5) A preamp and high pass filter were used for this test in order to provide sufficient measurement sensitivity.
- (6) EUT Orthogonal Axis:  
“X” - denotes Laid on Table ; ”Y” - denotes Vertical Stand ; ”Z” - denotes Side Stand
- (7) During the measurements above 1 GHz it is taken care of that the EUT is always within the 3 dB cone of radiation BW of the used antenna



TX CH78 (Above 1000 MHz, Horizontal)

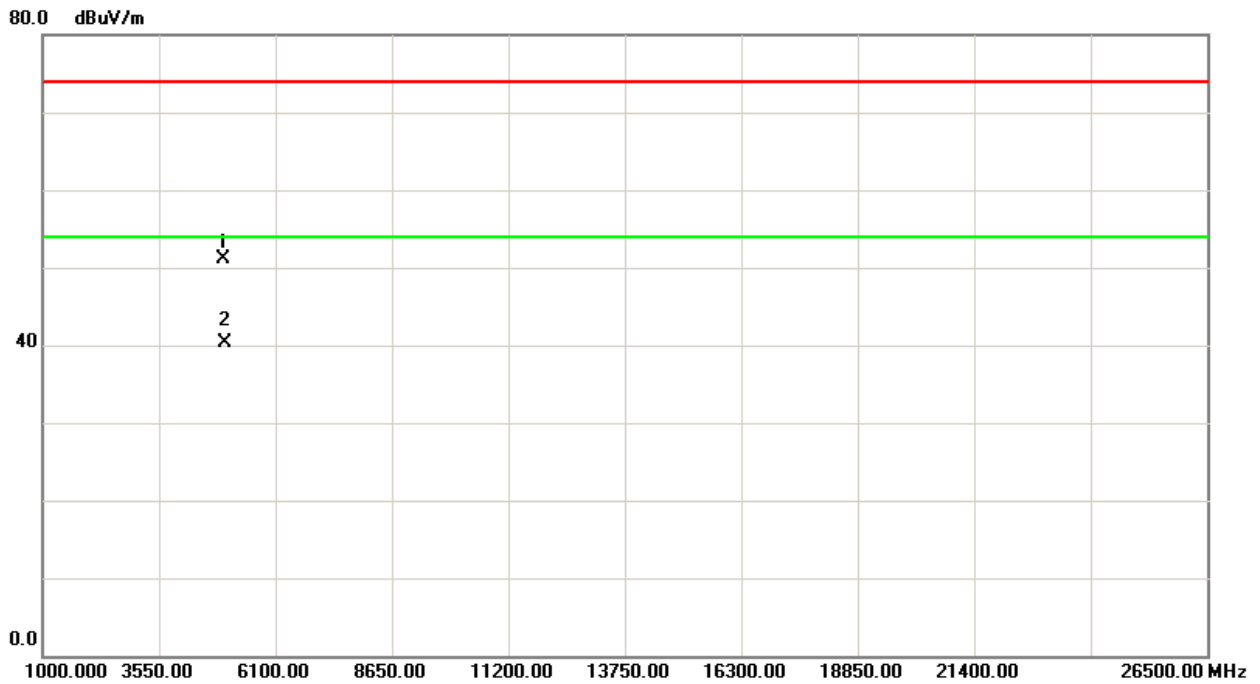
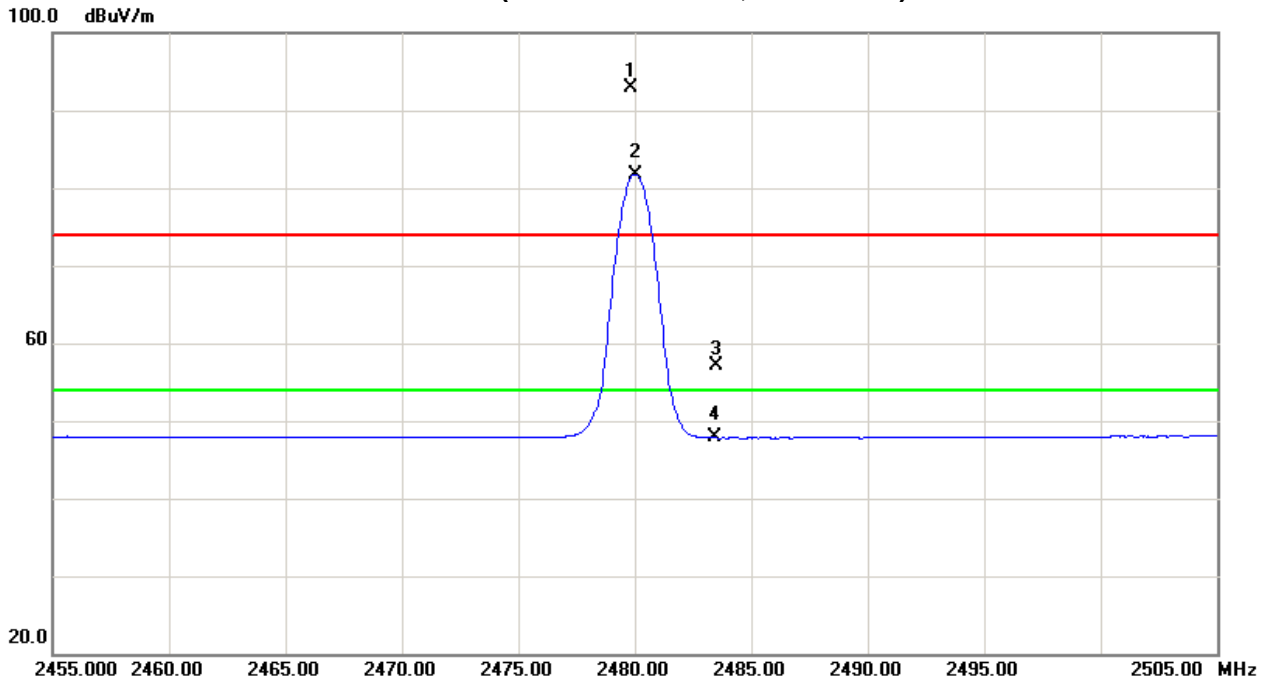



**5. NUMBER OF HOPPING CHANNEL**

**5.1 APPLIED PROCEDURES / LIMIT**

FCC Part15 (15.247) , Subpart C			
Section	Test Item	Frequency Range (MHz)	Result
15.247 (a)(1)(iii)	Number of Hopping Channel	2400-2483.5	PASS

**5.1.1 MEASUREMENT INSTRUMENTS LIST AND SETTING**

Item	Kind of Equipment	Manufacturer	Type No.	Serial No.	Calibrated until
1	Spectrum Analyzer	R&S	FSP 40	100185	Nov. 16.2013

Remark: "N/A" denotes no model name, serial no. or calibration specified.  
All calibration period of Equipment List is One Year.

Spectrum Parameters	Setting
Attenuation	Auto
Span Frequency	> Operating Frequency Range
RB	100 kHz
VB	100 kHz
Detector	Peak
Trace	Max Hold
Sweep Time	Auto

**5.1.2 TEST PROCEDURE**

- a. The EUT was directly connected to the spectrum analyzer and antenna output port as show in the block diagram below,
- b. Spectrum Setting : RBW= 100KHz, VBW=100KHz, Sweep time = Auto.

**5.1.3 DEVIATION FROM STANDARD**

No deviation.

**5.1.4 TEST SETUP**



**5.1.5 EUT OPERATION CONDITIONS**

The EUT tested system was configured as the statements of 4.1.6 Unless otherwise a special operating condition is specified in the follows during the testing.





**5.1.6 TEST RESULTS**

EUT:	Portable Bluetooth Speaker	Model Name :	BTV1
Temperature:	25 °C	Relative Humidity:	58 %
Pressure:	1009 hPa	Test Voltage :	AC 120V/60Hz
Test Mode :	Hopping Mode -1Mbps		

Number of Hopping Channel	79
---------------------------	----

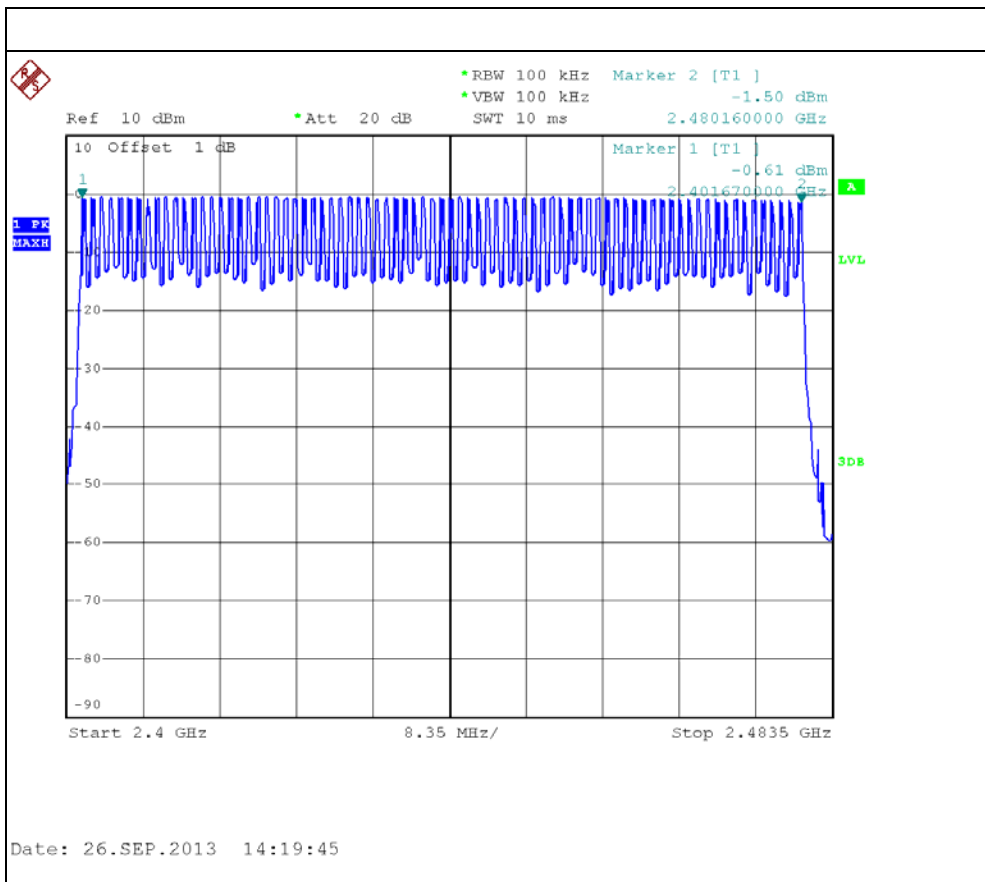



EUT:	Portable Bluetooth Speaker	Model Name :	BTV1
Temperature:	25 °C	Relative Humidity:	58 %
Pressure:	1009 hPa	Test Voltage :	AC 120V/60Hz
Test Mode :	Hopping Mode -3Mbps		

Number of Hopping Channel	79
---------------------------	----

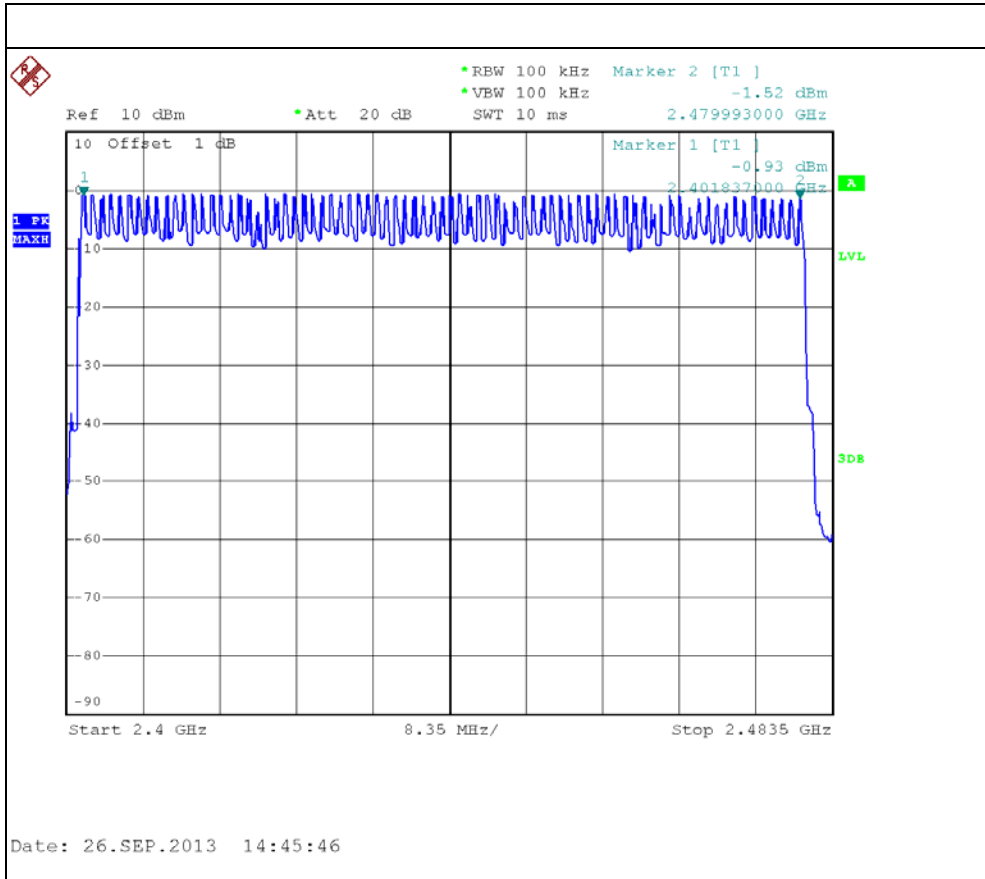



**6. AVERAGE TIME OF OCCUPANCY**

**6.1 APPLIED PROCEDURES / LIMIT**

FCC Part15 (15.247) , Subpart C				
Section	Test Item	Limit	Frequency Range (MHz)	Result
15.247 (a)(1)(iii)	Average Time of Occupancy	0.4sec	2400-2483.5	PASS

**6.1.1 MEASUREMENT INSTRUMENTS LIST**

Item	Kind of Equipment	Manufacturer	Type No.	Serial No.	Calibrated until
1	Spectrum Analyzer	R&S	FSP 40	100185	Nov. 16.2013

Remark: "N/A" denotes no model name, serial no. or calibration specified.

All calibration period of Equipment List is One Year.

**6.1.2 TEST PROCEDURE**

- a. The transmitter output (antenna port) was connected to the spectrum analyzer
- b. Set RBW of spectrum analyzer to 1MHz and VBW to 1MHz.
- c. Use a video trigger with the trigger level set to enable triggering only on full pulses.
- d. Sweep Time is more than once pulse time.
- e. Set the center frequency on any frequency would be measure and set the frequency span to zero span.
- f. Measure the maximum time duration of one single pulse.
- g. Set the EUT for DH5, DH3 and DH1 packet transmitting.
- h. Measure the maximum time duration of one single pulse.
- i. DH5 Packet permit maximum  $1600 / 79 / 6 = 3.37$  hops per second in each channel (5 time slots TX, 1 time slot RX). So, the dwell time is the time duration of the pulse times  $3.37 \times 31.6 = 106.6$  within 31.6 seconds.
- j. DH3 Packet permit maximum  $1600 / 79 / 4 = 5.06$  hops per second in each channel (3 time slots TX, 1 time slot RX). So, the dwell time is the time duration of the pulse times  $5.06 \times 31.6 = 160$  within 31.6 seconds.
- k. DH1 Packet permit maximum  $1600 / 79 / 2 = 10.12$  hops per second in each channel (1 time slot TX, 1 time slot RX). So, the dwell time is the time duration of the pulse times  $10.12 \times 31.6 = 320$  within 31.6 seconds.

**6.1.3 DEVIATION FROM STANDARD**

No deviation.



**6.1.4 TEST SETUP**

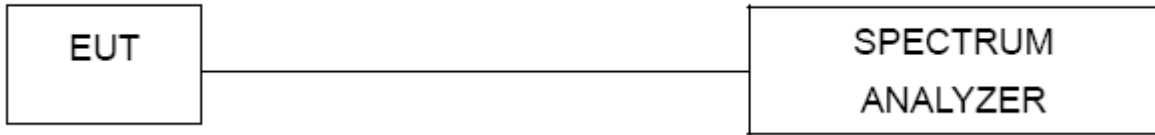

**6.1.5 EUT OPERATION CONDITIONS**

The EUT tested system was configured as the statements of 4.1.6 Unless otherwise a special operating condition is specified in the follows during the testing.



**6.1.6 TEST RESULTS**

EUT:	Portable Bluetooth Speaker	Model Name :	BTV1
Temperature:	25 °C	Relative Humidity:	58 %
Pressure:	1009 hPa	Test Voltage :	AC 120V/60Hz
Test Mode :	CH00-DH1/DH3/DH5 -1Mbps		

Data Packet	Frequency	Pulse Duration (ms)	Dwell Time (s)	Limits (s)
DH5	2402 MHz	3.0000	0.3200	0.4000
DH3	2402 MHz	1.7200	0.2752	0.4000
DH1	2402 MHz	0.4300	0.1376	0.4000

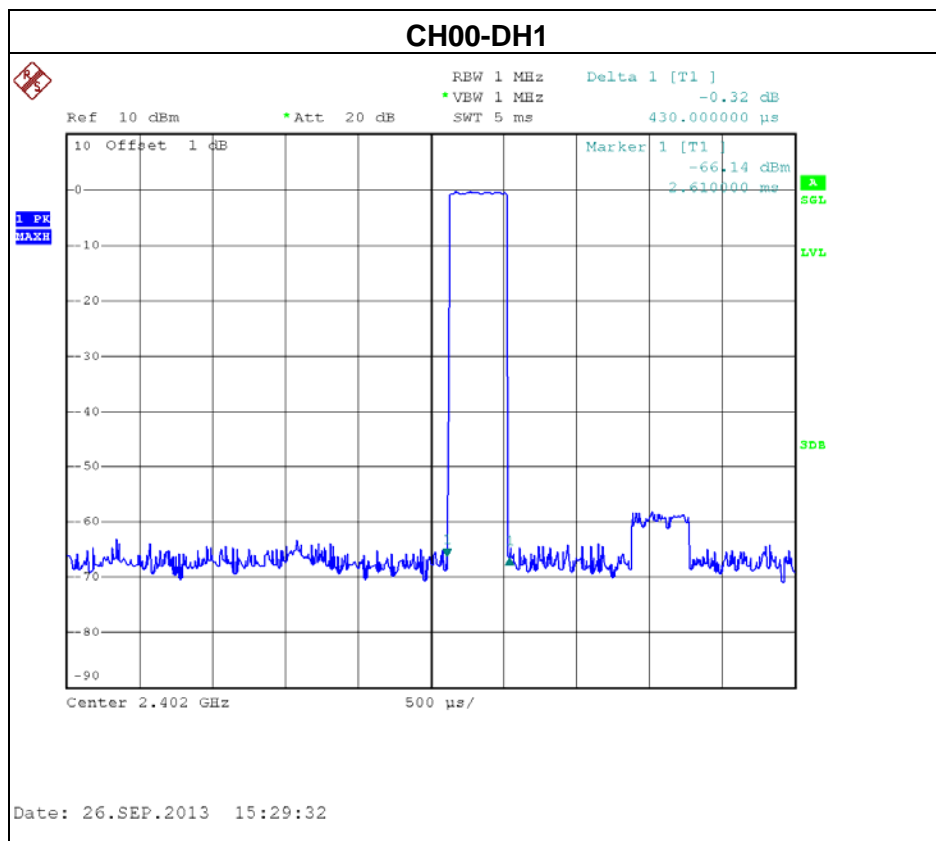

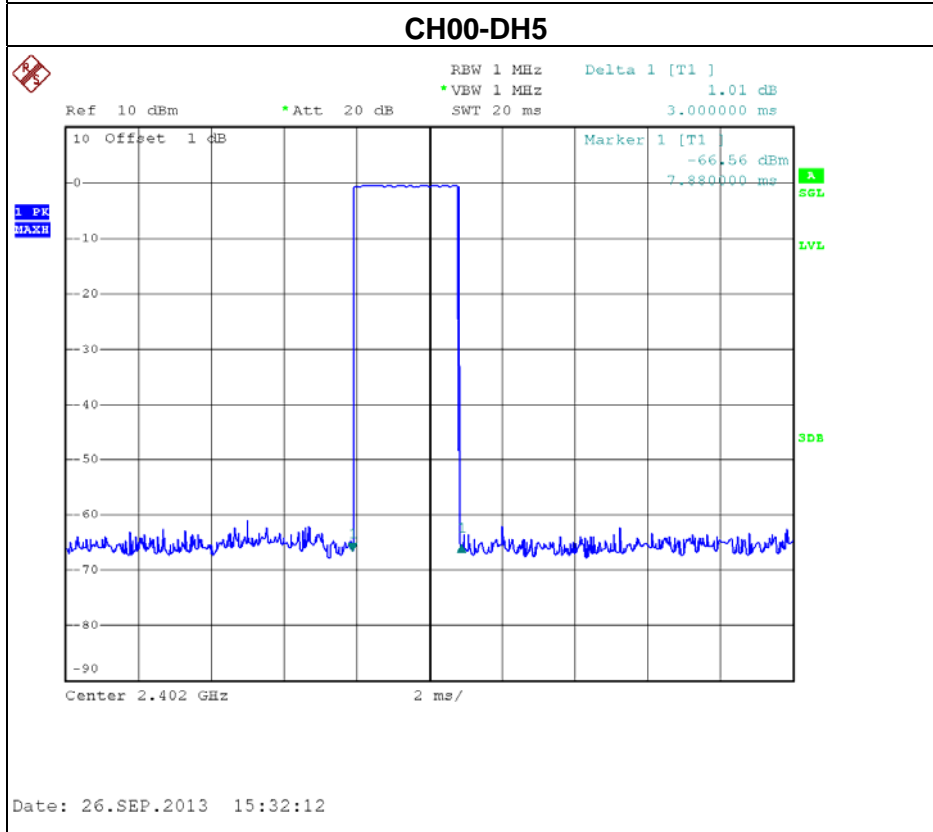
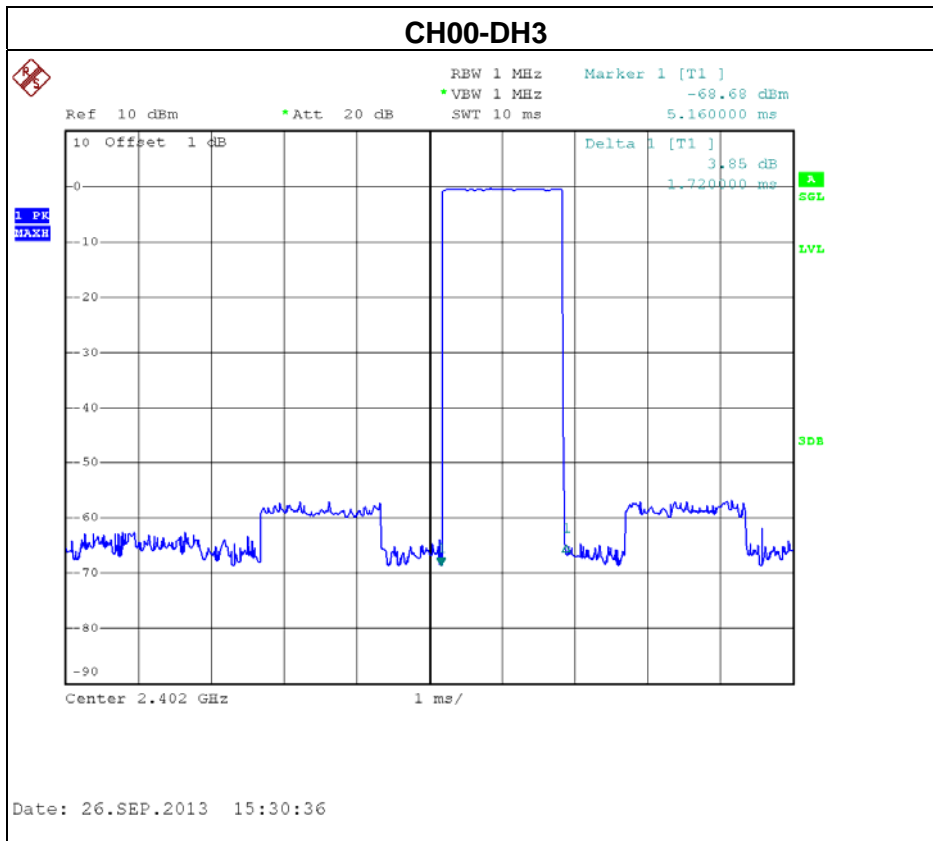



EUT:	Portable Bluetooth Speaker	Model Name :	BTV1
Temperature:	25 °C	Relative Humidity:	58 %
Pressure:	1009 hPa	Test Voltage :	AC 120V/60Hz
Test Mode :	CH39 -DH1/DH3/DH5 -1Mbps		

Data Packet	Frequency	Pulse Duration (ms)	Dwell Time (s)	Limits (s)
DH5	2441 MHz	3.0000	0.3200	0.4000
DH3	2441 MHz	1.7200	0.2752	0.4000
DH1	2441 MHz	0.4300	0.1376	0.4000

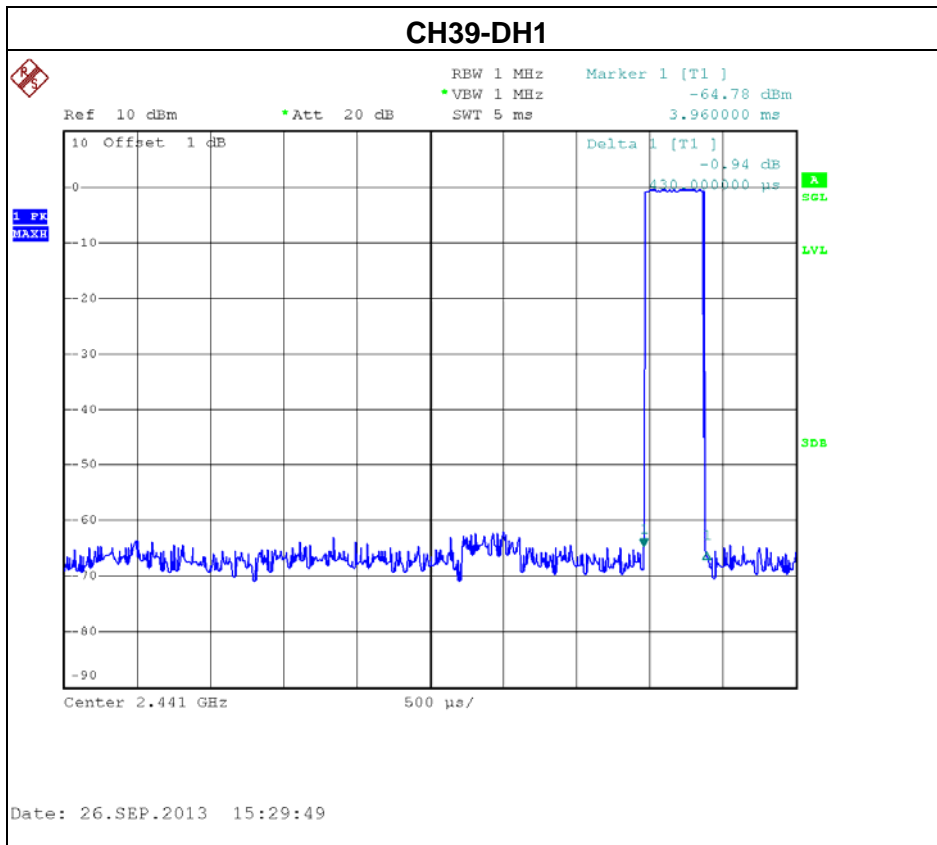

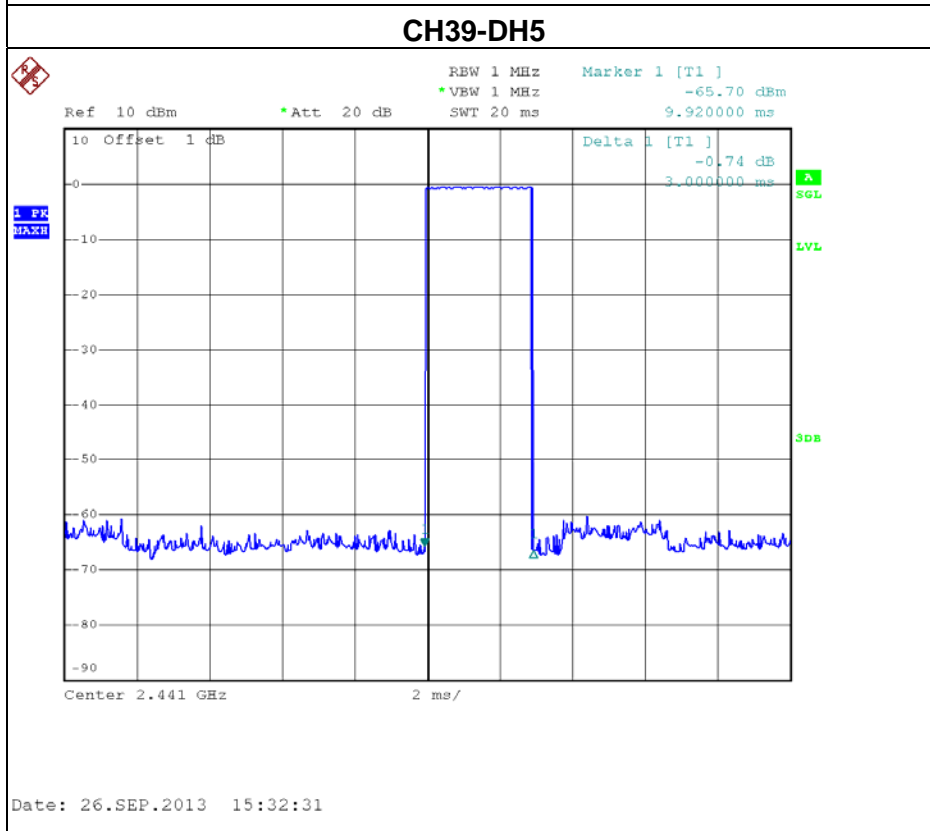
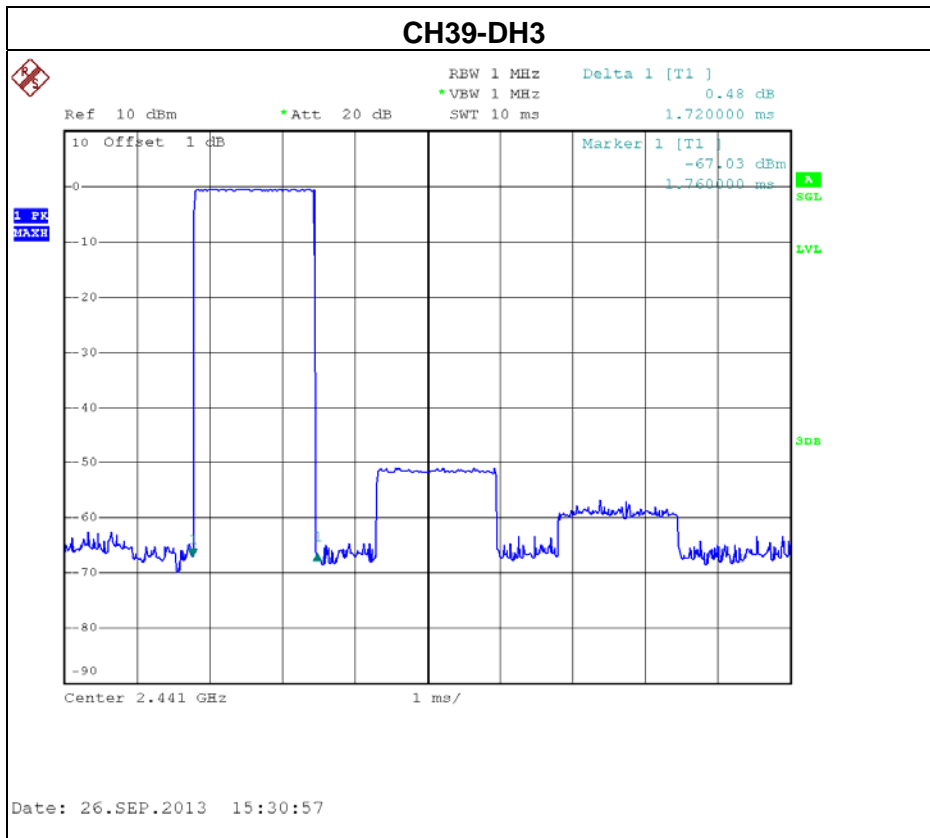





EUT:	Portable Bluetooth Speaker	Model Name :	BTV1
Temperature:	25 °C	Relative Humidity:	58 %
Pressure:	1009 hPa	Test Voltage :	AC 120V/60Hz
Test Mode :	CH78 -DH1/DH3/DH5-1Mbps		

Data Packet	Frequency	Pulse Duration (ms)	Dwell Time (s)	Limits (s)
DH5	2480 MHz	3.0000	0.3200	0.4000
DH3	2480 MHz	1.7200	0.2752	0.4000
DH1	2480 MHz	0.4300	0.1376	0.4000

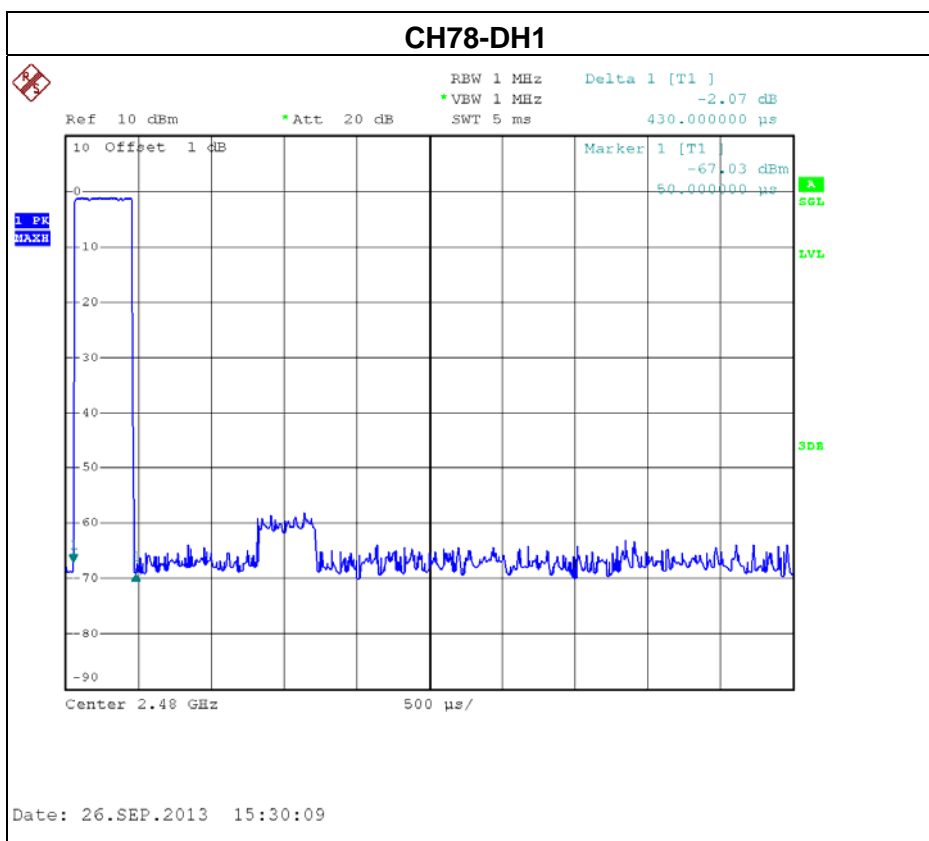

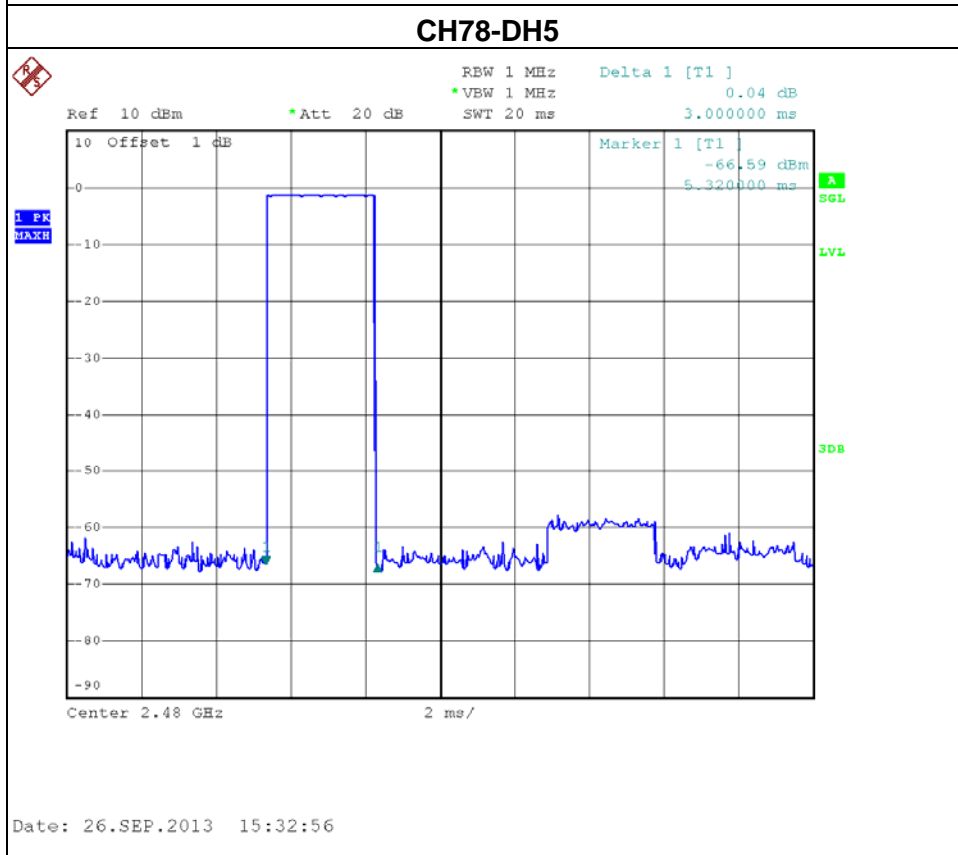
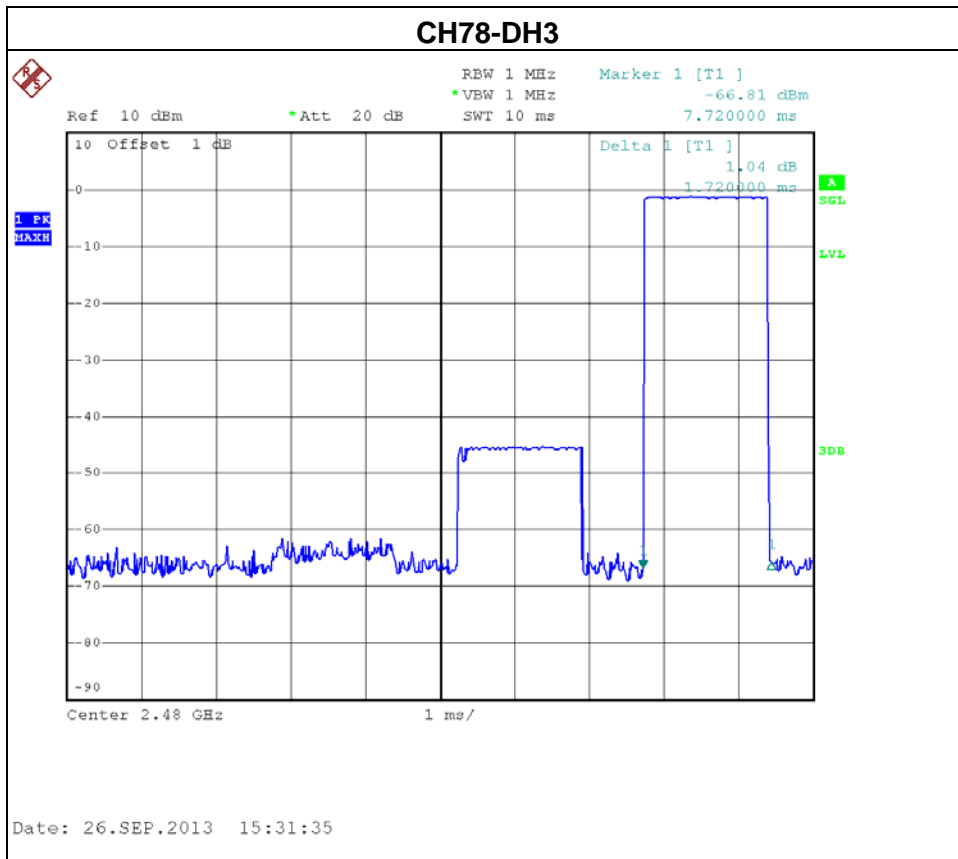



EUT:	Portable Bluetooth Speaker	Model Name :	BTV1
Temperature:	25 °C	Relative Humidity:	58 %
Pressure:	1009 hPa	Test Voltage :	AC 120V/60Hz
Test Mode :	CH00-DH1/DH3/DH5 -3Mbps		

Data Packet	Frequency	Pulse Duration (ms)	Dwell Time (s)	Limits (s)
DH5	2402 MHz	3.0000	0.3200	0.4000
DH3	2402 MHz	1.7200	0.2752	0.4000
DH1	2402 MHz	0.4400	0.1408	0.4000

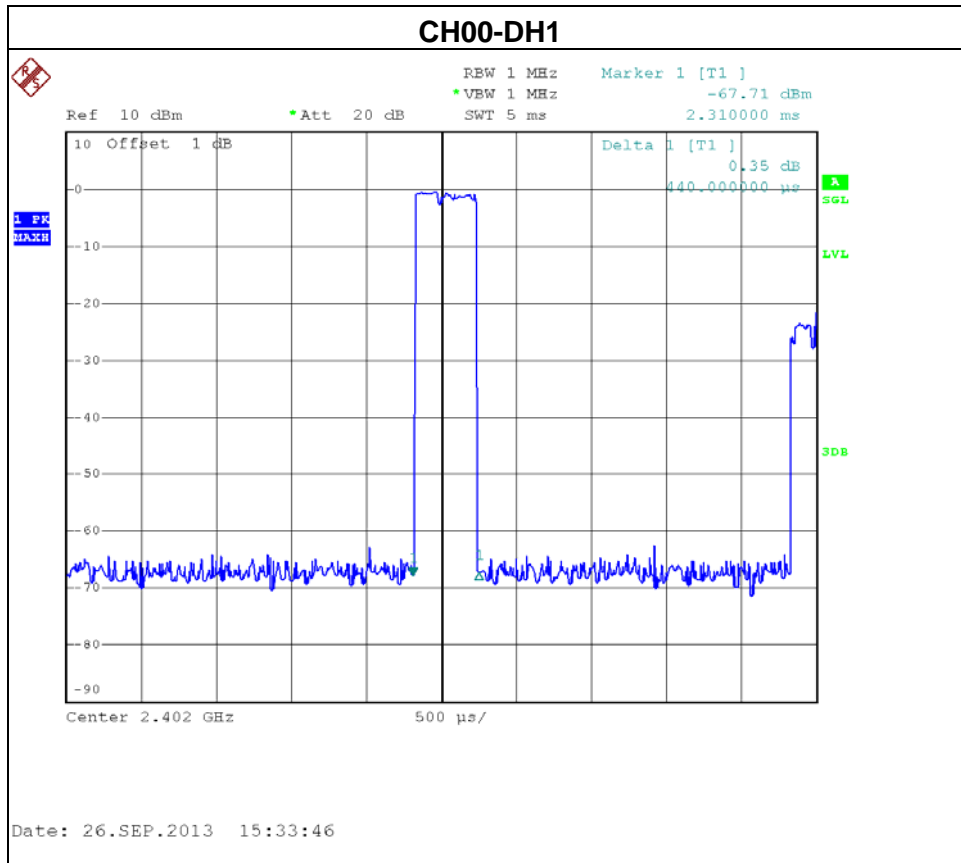

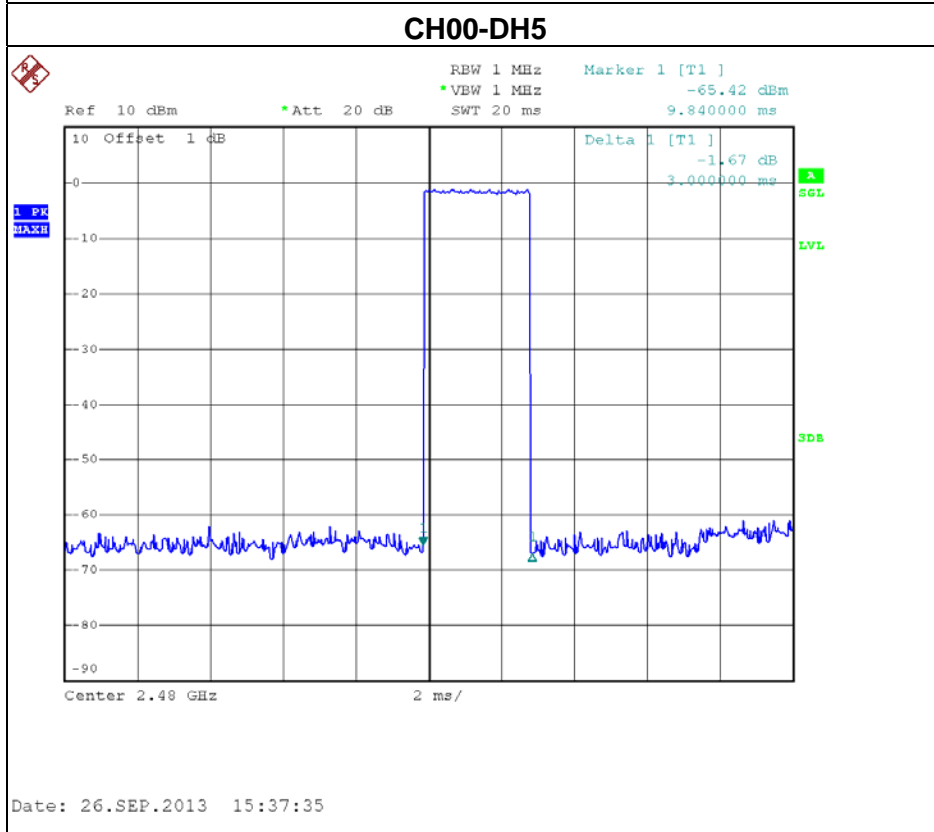
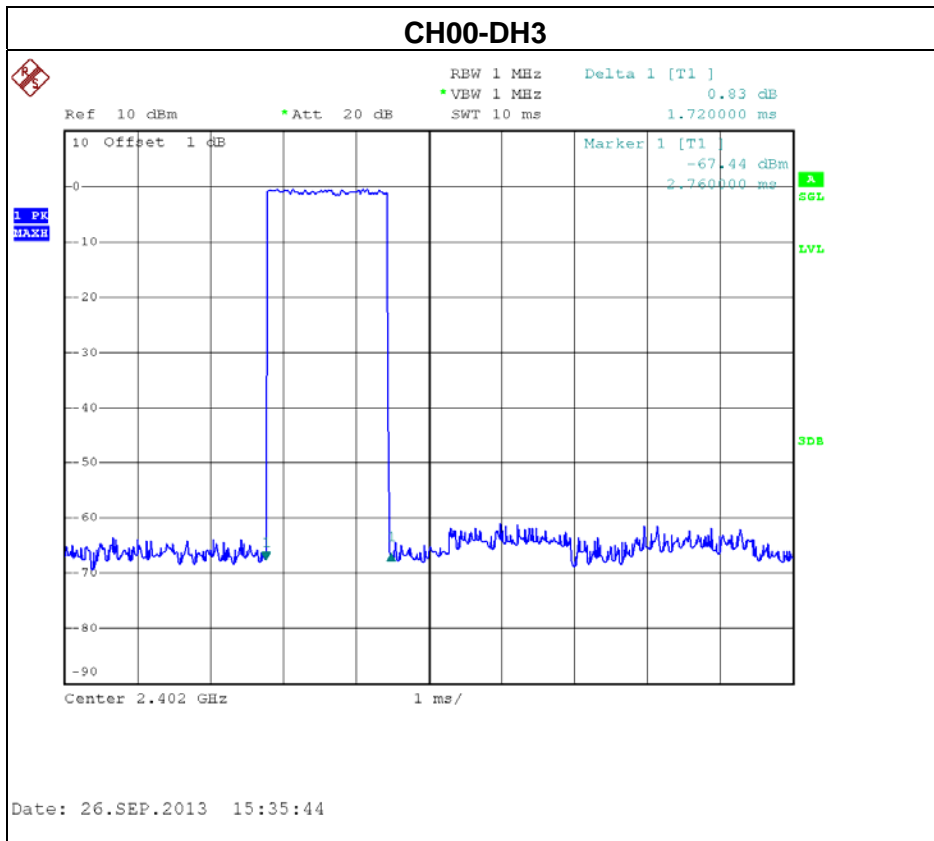



EUT:	Portable Bluetooth Speaker	Model Name :	BTV1
Temperature:	25 °C	Relative Humidity:	58 %
Pressure:	1009 hPa	Test Voltage :	AC 120V/60Hz
Test Mode :	CH39 -DH1/DH3/DH5 -3Mbps		

Data Packet	Frequency	Pulse Duration (ms)	Dwell Time (s)	Limits (s)
DH5	2441 MHz	3.0000	0.3200	0.4000
DH3	2441 MHz	1.7200	0.2752	0.4000
DH1	2441 MHz	0.4400	0.1408	0.4000

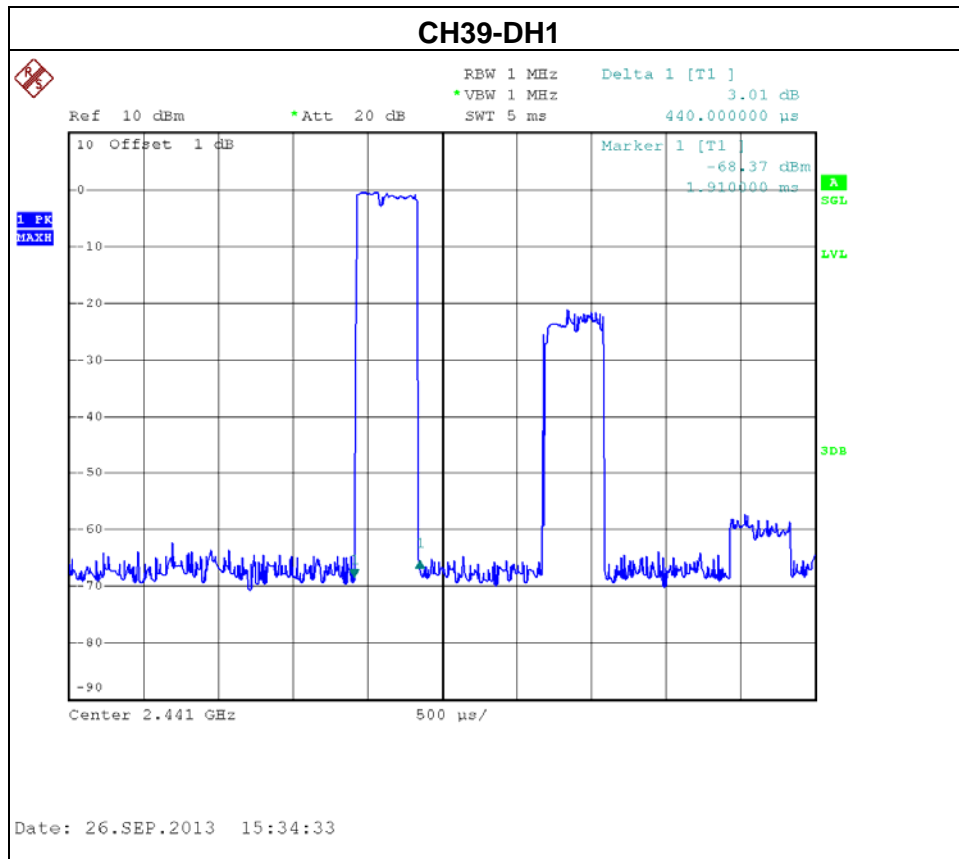

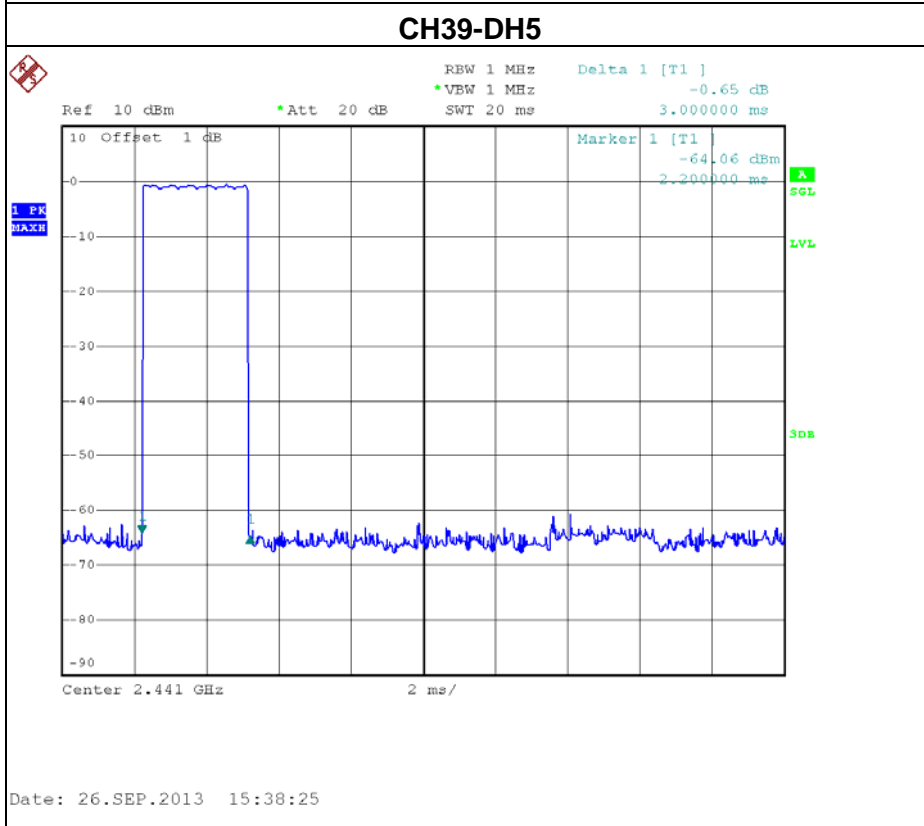
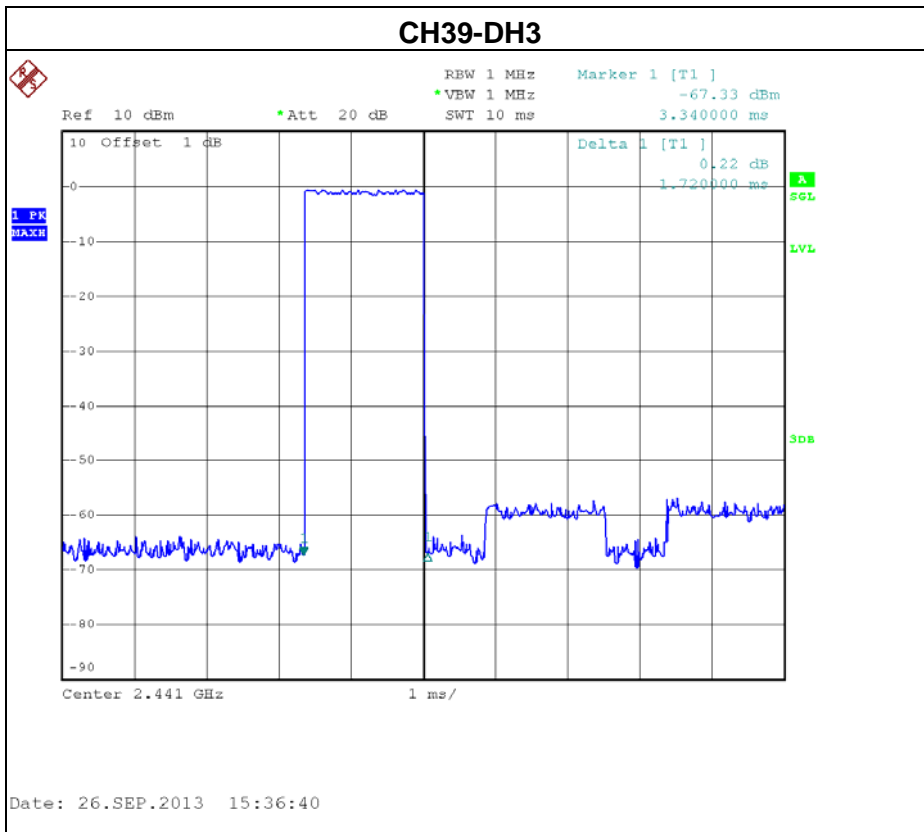



EUT:	Portable Bluetooth Speaker	Model Name :	BTV1
Temperature:	25 °C	Relative Humidity:	58 %
Pressure:	1009 hPa	Test Voltage :	AC 120V/60Hz
Test Mode :	CH78 -DH1/DH3/DH5-3Mbps		

Data Packet	Frequency	Pulse Duration (ms)	Dwell Time (s)	Limits (s)
DH5	2480 MHz	3.0000	0.3200	0.4000
DH3	2480 MHz	1.7200	0.2752	0.4000
DH1	2480 MHz	0.4400	0.1408	0.4000

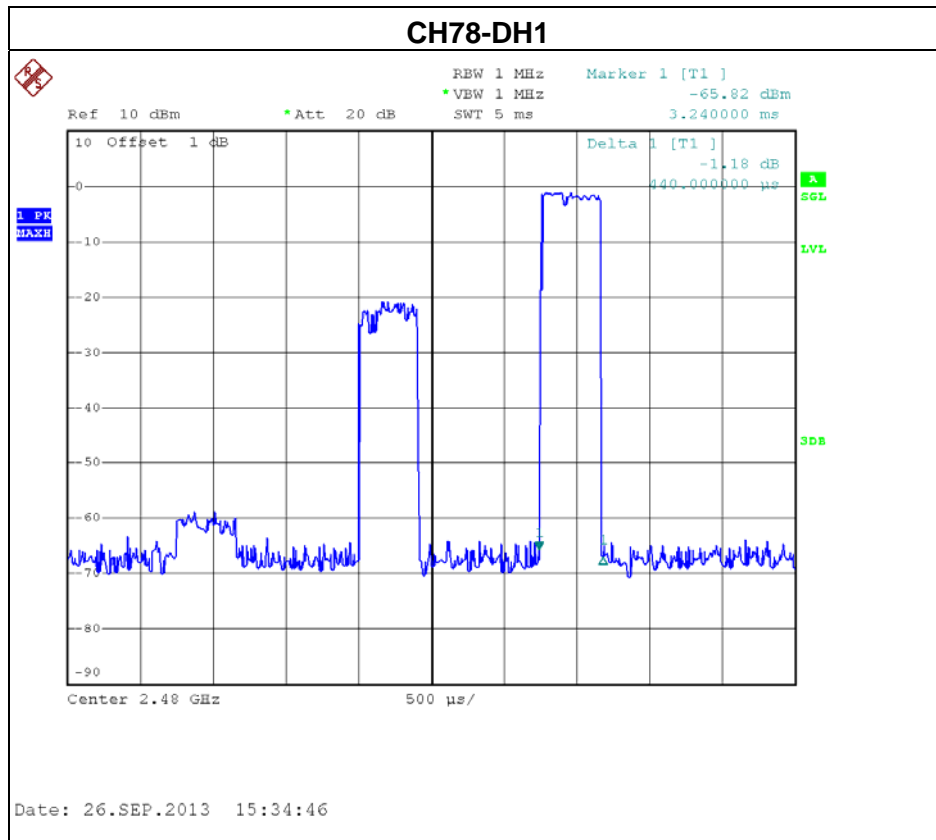

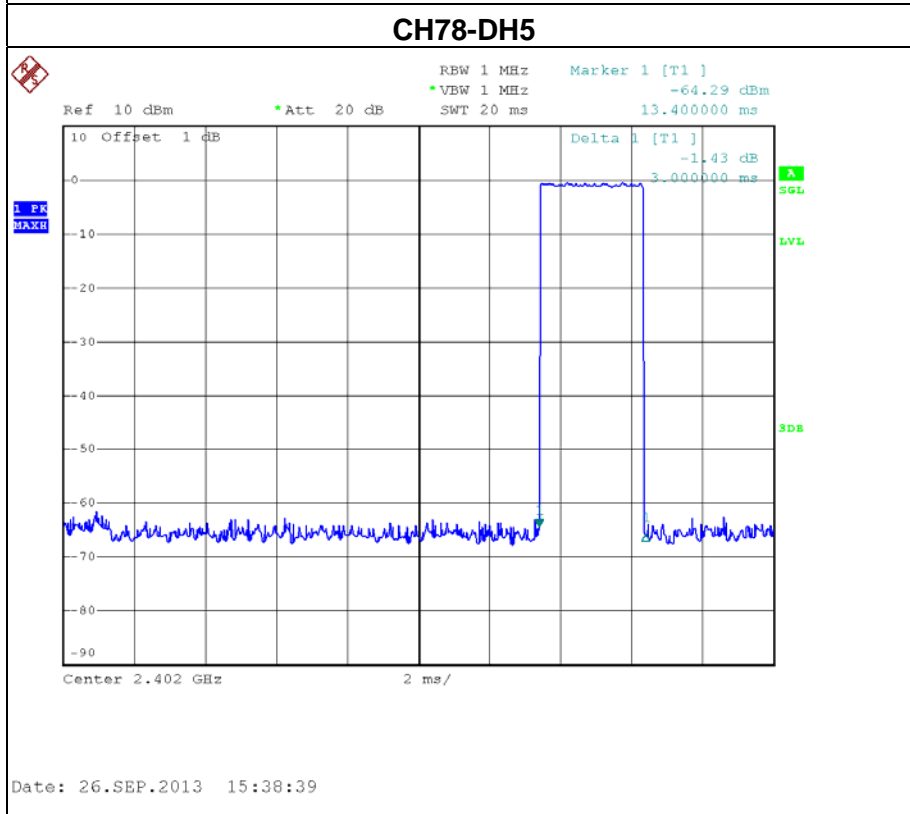
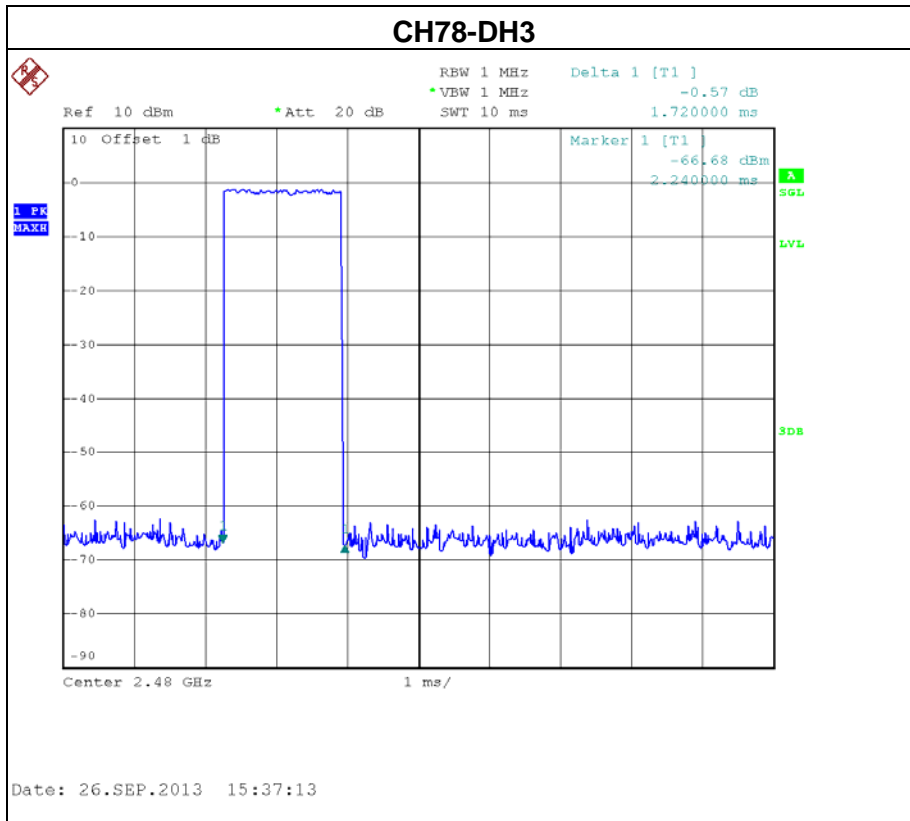



## 7. HOPPING CHANNEL SEPARATION MEASUREMENT

### 7.1 APPLIED PROCEDURES / LIMIT

Frequency hopping systems operating in the 2400-2483.5 MHz band may have hopping channel carrier frequencies that are separated by 25 kHz or two-thirds of the 20 dB bandwidth of the hopping channel, whichever is greater.

#### 7.1.1 MEASUREMENT INSTRUMENTS LIST AND SETTING

Item	Kind of Equipment	Manufacturer	Type No.	Serial No.	Calibrated until
1	Spectrum Analyzer	R&S	FSP 40	100185	Nov. 16.2013

Remark: "N/A" denotes no model name, serial no. or calibration specified.

All calibration period of Equipment List is One Year.

Spectrum Parameter	Setting
Attenuation	Auto
Span Frequency	> Measurement Bandwidth or Channel Separation
RB	30 kHz
VB	100 kHz
Detector	Peak
Trace	Max Hold
Sweep Time	Auto

#### 7.1.2 TEST PROCEDURE

- a. The EUT must have its hopping function enabled
- b. Span = wide enough to capture the peaks of two adjacent channels
  - Resolution (or IF) Bandwidth (RBW)  $\geq$  1% of the span
  - Video (or Average) Bandwidth (VBW)  $\geq$  RBW
  - Sweep = auto
  - Detector function = peak
  - Trace = max hold

#### 7.1.3 DEVIATION FROM STANDARD

No deviation.

#### 7.1.4 TEST SETUP

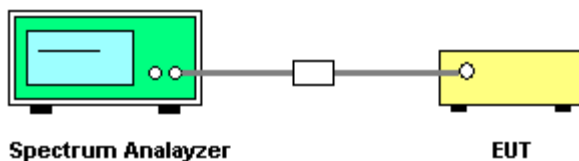

#### 7.1.5 EUT OPERATION CONDITIONS

The EUT was programmed to be in hopping mode.



**7.1.6 TEST RESULTS**

EUT:	Portable Bluetooth Speaker	Model Name :	BTV1
Temperature:	25 °C	Relative Humidity:	58 %
Pressure:	1009 hPa	Test Voltage :	AC 120V/60Hz
Test Mode :	CH00 / CH39 /CH78-1Mbps		

Frequency	Ch. Separation (MHz)	2/3 of 20dB bandwidth (MHz)	Result
2402 MHz	1.008	0.600	<b>Complies</b>
2441 MHz	1.002	0.580	<b>Complies</b>
2480 MHz	1.002	0.573	<b>Complies</b>

**Ch. Separation Limits: >20dB bandwidth or >2/3 of 20dB bandwidth**

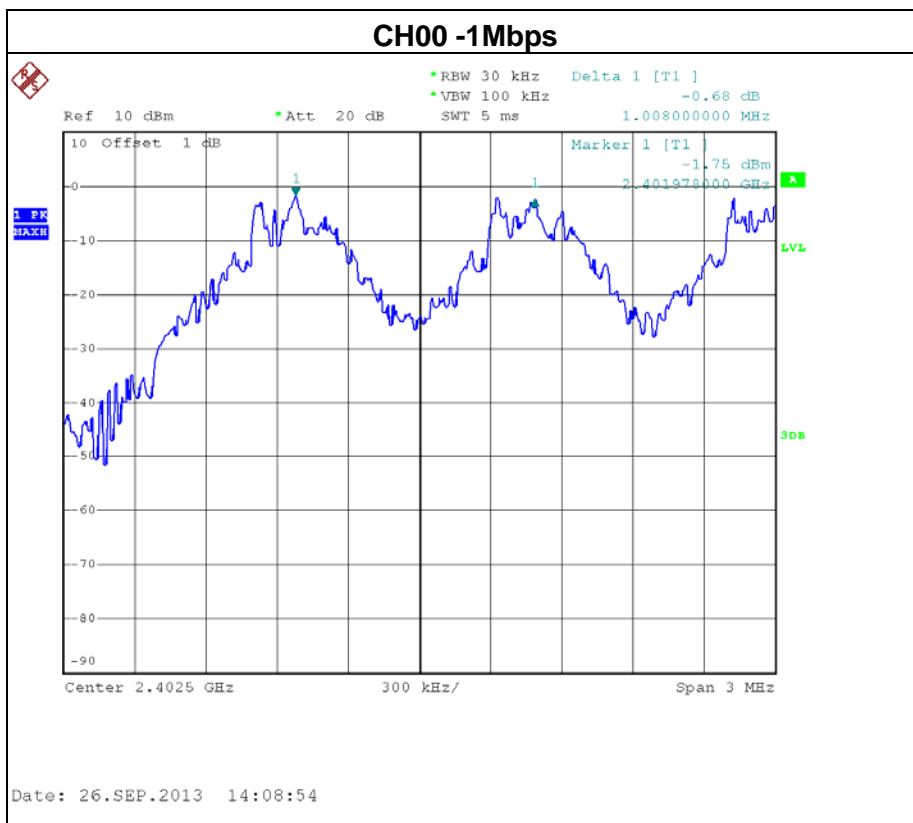

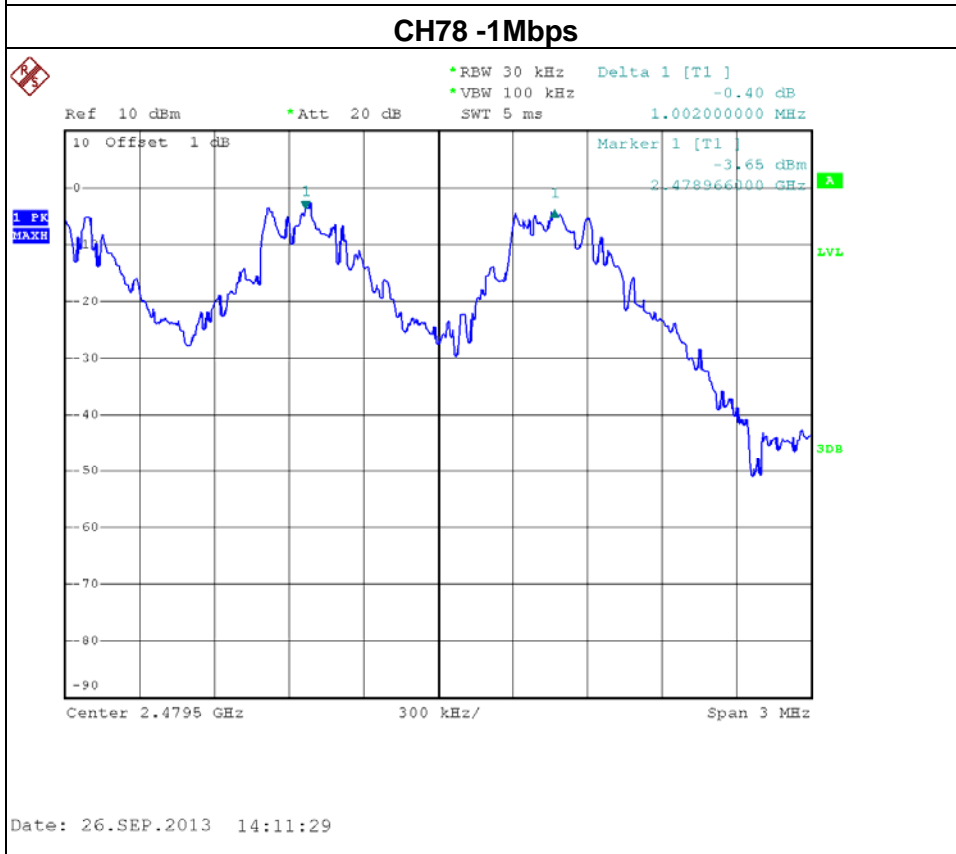
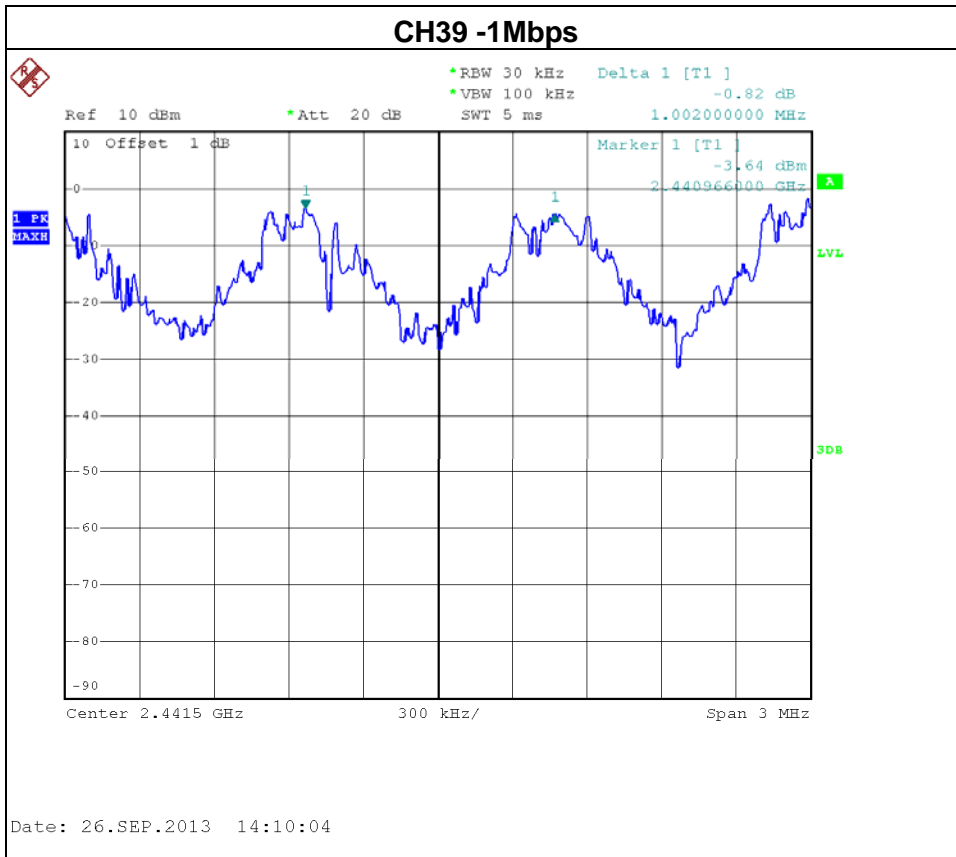



EUT:	Portable Bluetooth Speaker	Model Name :	BTV1
Temperature:	25 °C	Relative Humidity:	58 %
Pressure:	1009 hPa	Test Voltage :	AC 120V/60Hz
Test Mode :	CH00 / CH39 /CH78-3Mbps		

Frequency	Ch. Separation (MHz)	2/3 of 20dB bandwidth (MHz)	Result
2402 MHz	1.014	0.807	<b>Complies</b>
2441 MHz	1.164	0.807	<b>Complies</b>
2480 MHz	1.008	0.813	<b>Complies</b>

**Ch. Separation Limits: >20dB bandwidth or >2/3 of 20dB bandwidth**

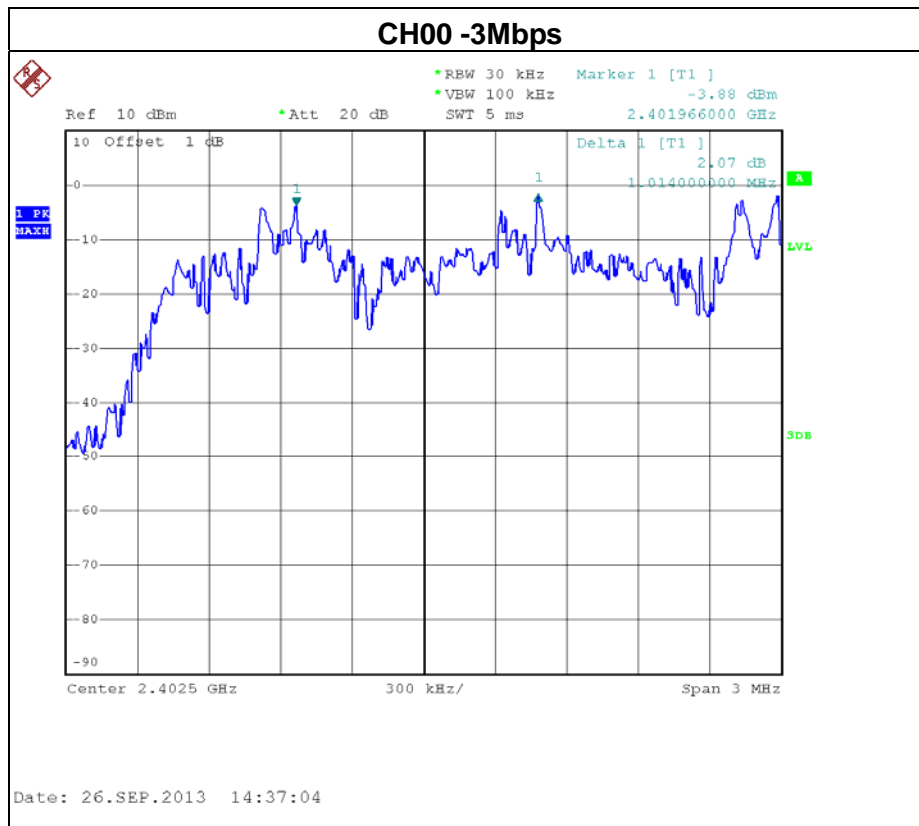

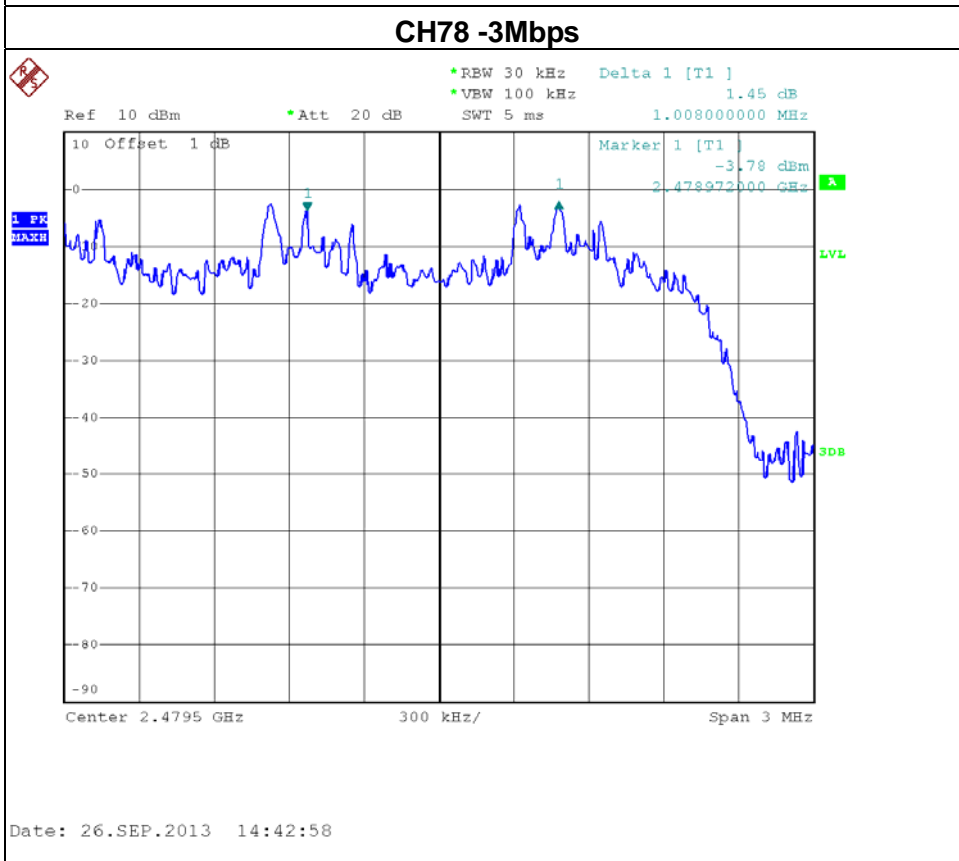
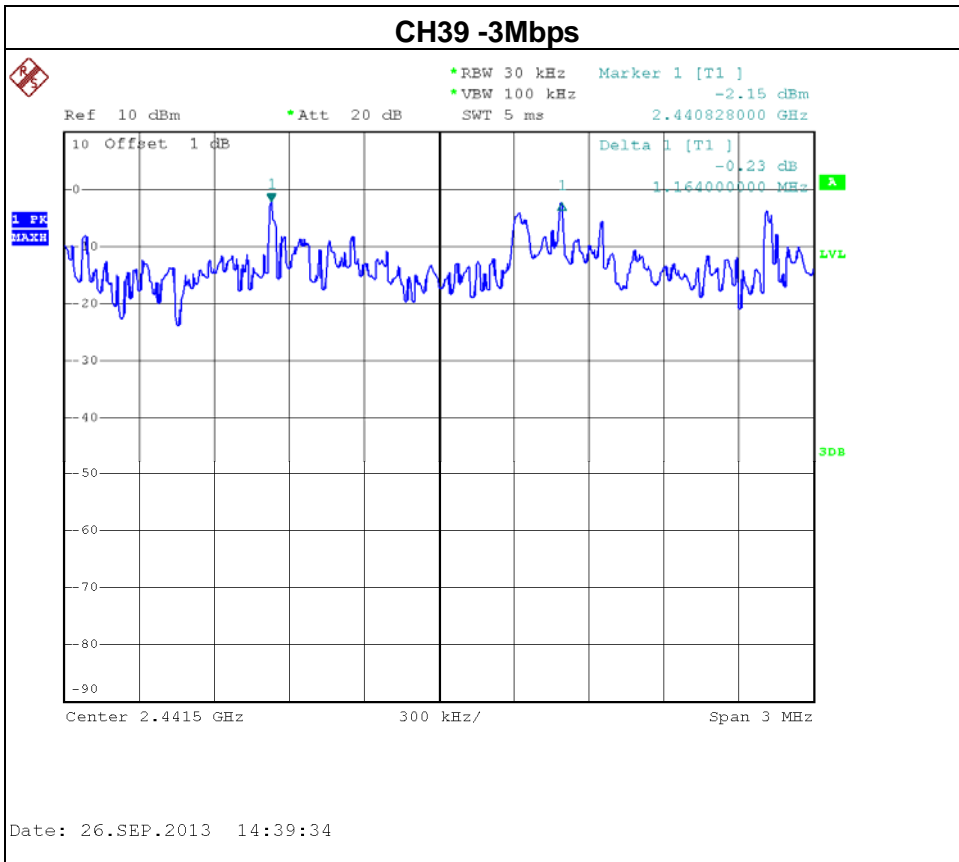



**8. BANDWIDTH TEST**

**8.1 APPLIED PROCEDURES / LIMIT**

FCC Part15 (15.247) , Subpart C		
Section	Test Item	Frequency Range (MHz)
15.247 (a)(2)	Bandwidth	2400-2483.5

**8.1.1 MEASUREMENT INSTRUMENTS LIST AND SETTING**

Item	Kind of Equipment	Manufacturer	Type No.	Serial No.	Calibrated until
1	Spectrum Analyzer	R&S	FSP 40	100185	Nov. 16.2013

Remark: "N/A" denotes no model name, serial no. or calibration specified.

All calibration period of Equipment List is One Year.

Spectrum Parameter	Setting
Attenuation	Auto
Span Frequency	> Measurement Bandwidth or Channel Separation
RB	30 kHz (20dB Bandwidth) / 30 kHz (Channel Separation)
VB	100 kHz (20dB Bandwidth) / 100 kHz (Channel Separation)
Detector	Peak
Trace	Max Hold
Sweep Time	Auto

**8.1.2 TEST PROCEDURE**

- a. The EUT was directly connected to the spectrum analyzer and antenna output port as show in the block diagram below,
- b. Spectrum Setting : RBW= 30KHz, VBW=100KHz, Sweep time = Auto.

**8.1.3 DEVIATION FROM STANDARD**

No deviation.

**8.1.4 TEST SETUP**

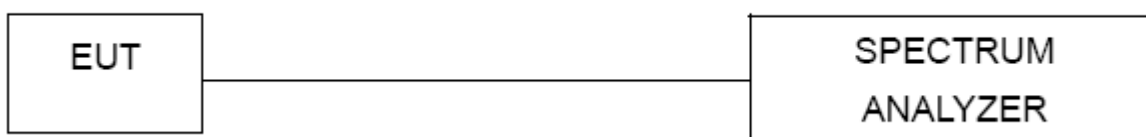

**8.1.5 EUT OPERATION CONDITIONS**

The EUT tested system was configured as the statements of 4.1.6 Unless otherwise a special operating condition is specified in the follows during the testing.



**8.1.6 TEST RESULTS**

EUT:	Portable Bluetooth Speaker	Model Name :	BTV1
Temperature:	25 °C	Relative Humidity:	58 %
Pressure:	1009 hPa	Test Voltage :	AC 120V/60Hz
Test Mode :	CH00 / CH39 /CH78-1Mbps		

Frequency	20dB Bandwidth (MHz)	99% Occupied Bandwidth (MHz)	Result
2402 MHz	0.90	0.86	<b>PASS</b>
2441 MHz	0.87	0.84	<b>PASS</b>
2480 MHz	0.86	0.83	<b>PASS</b>

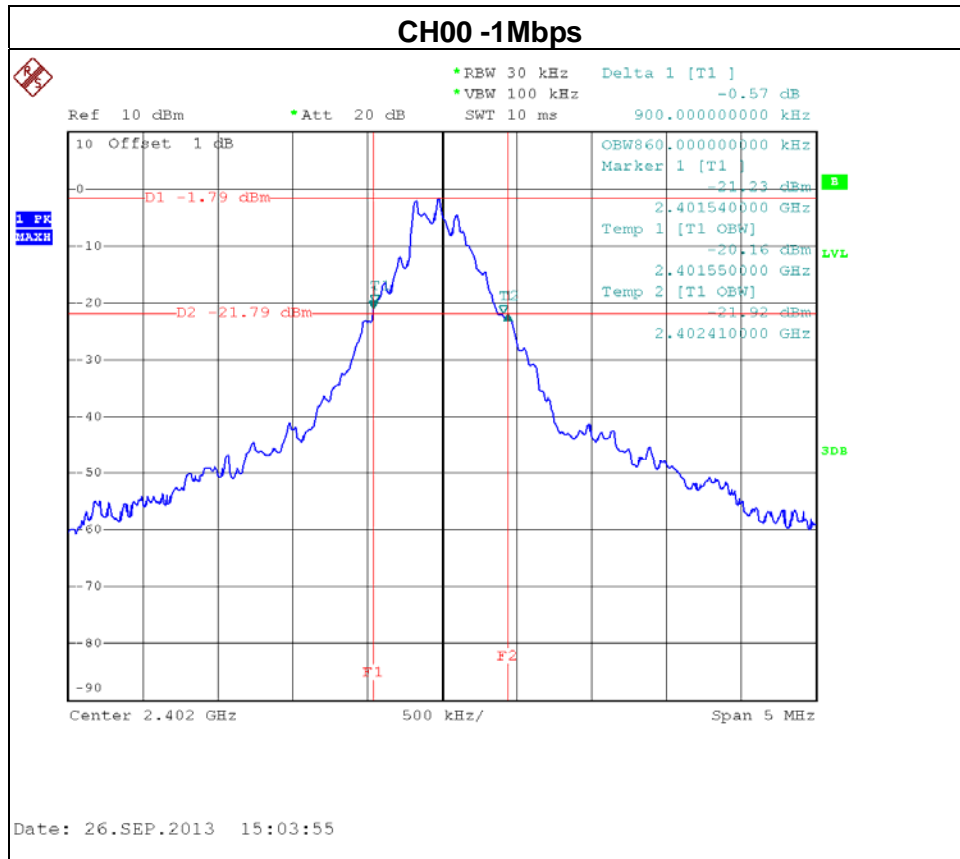

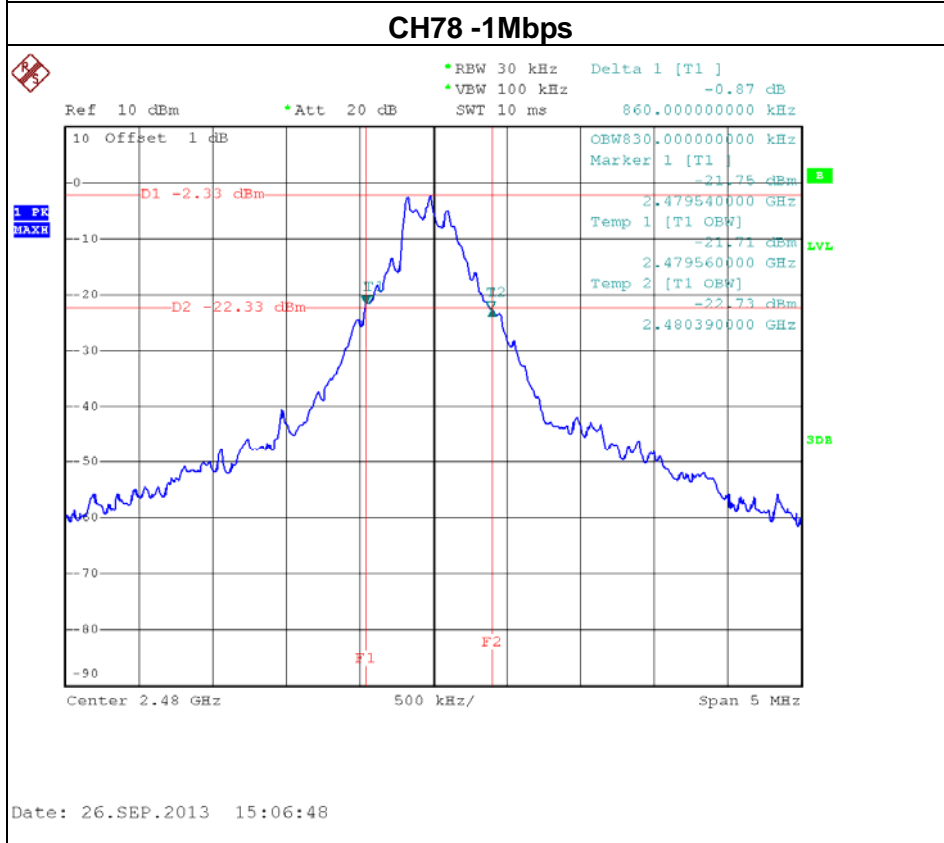
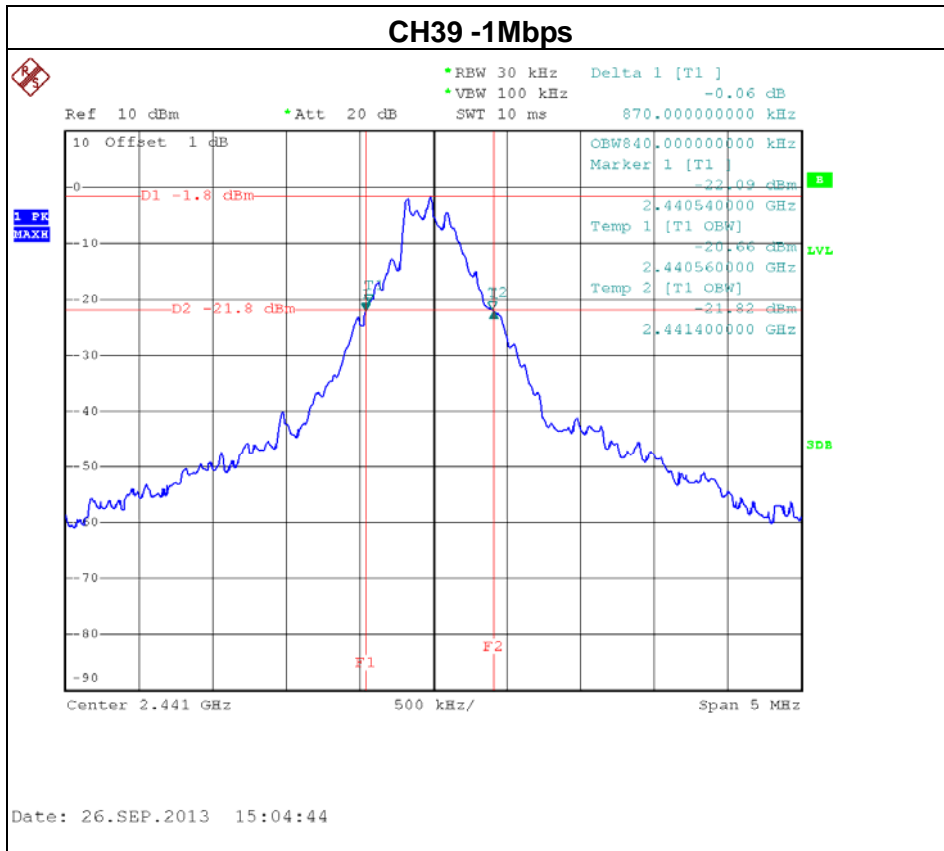





# Neutron Engineering Inc.

EUT:	Portable Bluetooth Speaker	Model Name :	BTV1
Temperature:	25 °C	Relative Humidity:	58 %
Pressure:	1009 hPa	Test Voltage :	AC 120V/60Hz
Test Mode :	CH00 / CH39 /CH78-3Mbps		

Frequency	20dB Bandwidth (MHz)	99% Occupied Bandwidth (MHz)	Result
2402 MHz	1.210	1.140	PASS
2441 MHz	1.210	1.130	PASS
2480 MHz	1.220	1.130	PASS

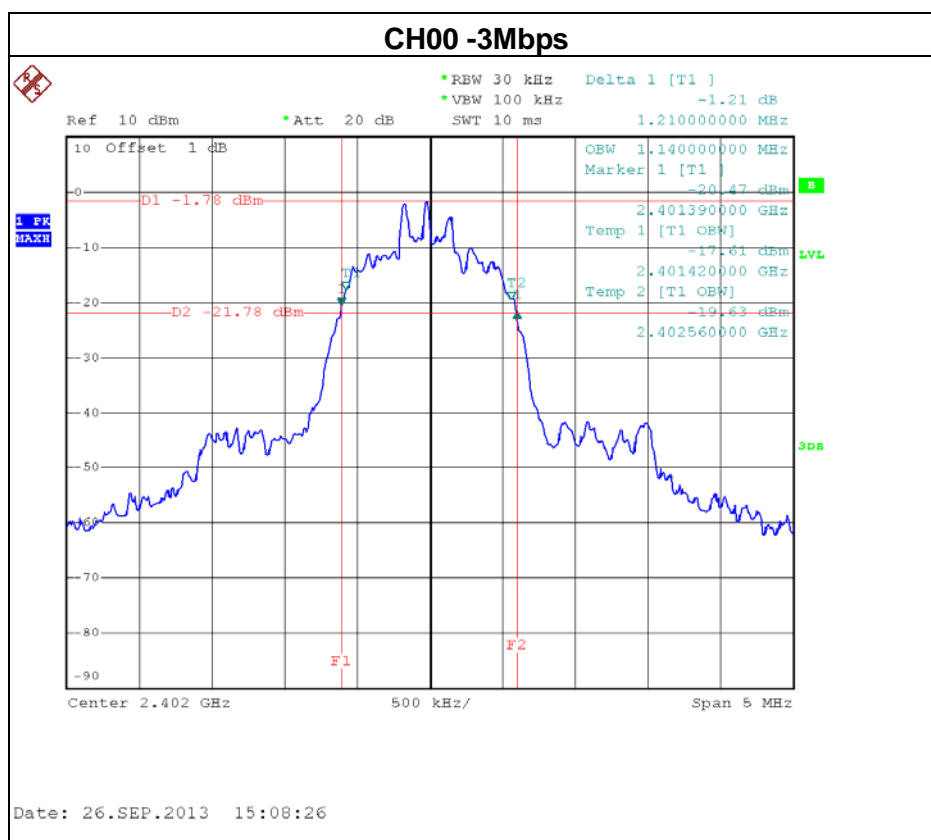

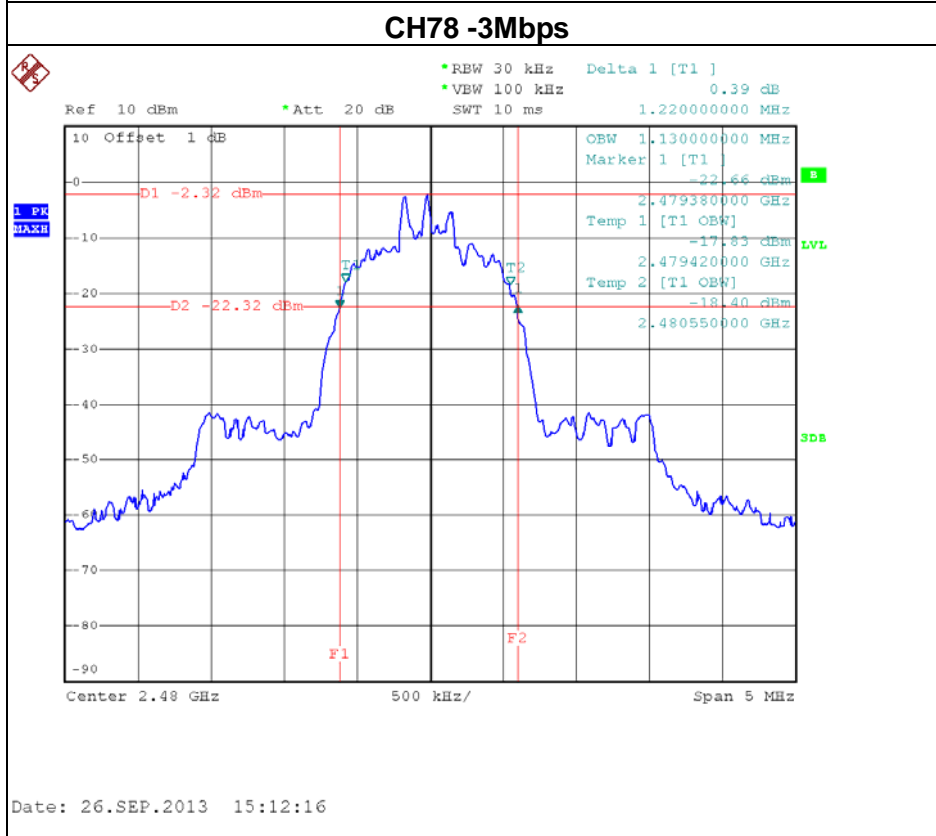
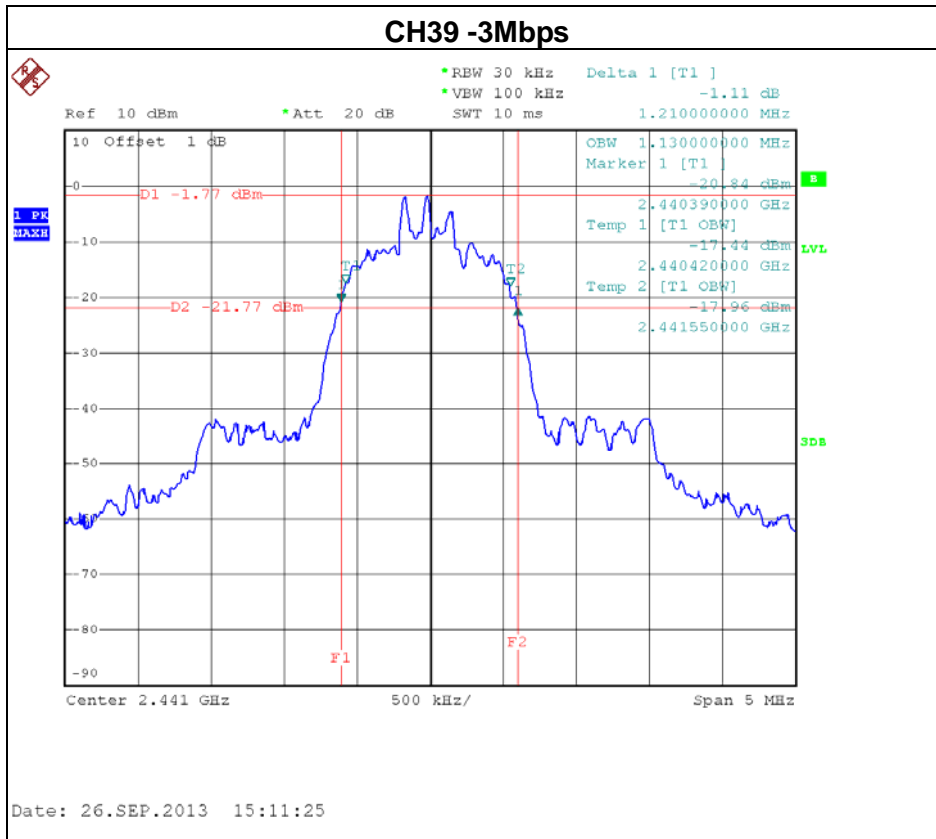



**9. PEAK OUTPUT POWER TEST**

**9.1 APPLIED PROCEDURES / LIMIT**

FCC Part15 (15.247) , Subpart C				
Section	Test Item	Limit	Frequency Range (MHz)	Result
15.247 (b)(1)	Peak Output Power	0.125 watt or 21dBm	2400-2483.5	PASS

**9.1.1 MEASUREMENT INSTRUMENTS LIST AND SETTING**

Item	Kind of Equipment	Manufacturer	Type No.	Serial No.	Calibrated until
1	Spectrum Analyzer	R&S	FSP 40	100185	Nov. 16.2013

Remark: "N/A" denotes no model name, serial no. or calibration specified.  
 All calibration period of Equipment List is One Year.

**9.1.2 TEST PROCEDURE**

- a. The EUT was directly connected to the spectrum analyzer and antenna output port as show in the block diagram below,
- b. Spectrum Setting : RBW= 3MHz, VBW= 3MHz, Sweep time = Auto.

**9.1.3 DEVIATION FROM STANDARD**

No deviation.

**9.1.4 TEST SETUP**



**9.1.5 EUT OPERATION CONDITIONS**

The EUT tested system was configured as the statements of 4.1.6 Unless otherwise a special operating condition is specified in the follows during the testing.



**9.1.6 TEST RESULTS**

EUT:	Portable Bluetooth Speaker	Model Name :	BTV1
Temperature:	25 °C	Relative Humidity:	58 %
Pressure:	1009 hPa	Test Voltage :	AC 120V/60Hz
Test Mode :	CH00/ CH39 /CH78 -1Mbps		

Test Channel	Frequency (MHz)	Peak Output Power (dBm)	LIMIT (dBm)	LIMIT (W)
CH00	2402	-0.44	21	0.125
CH39	2441	-0.45	21	0.125
CH78	2480	-1.07	21	0.125

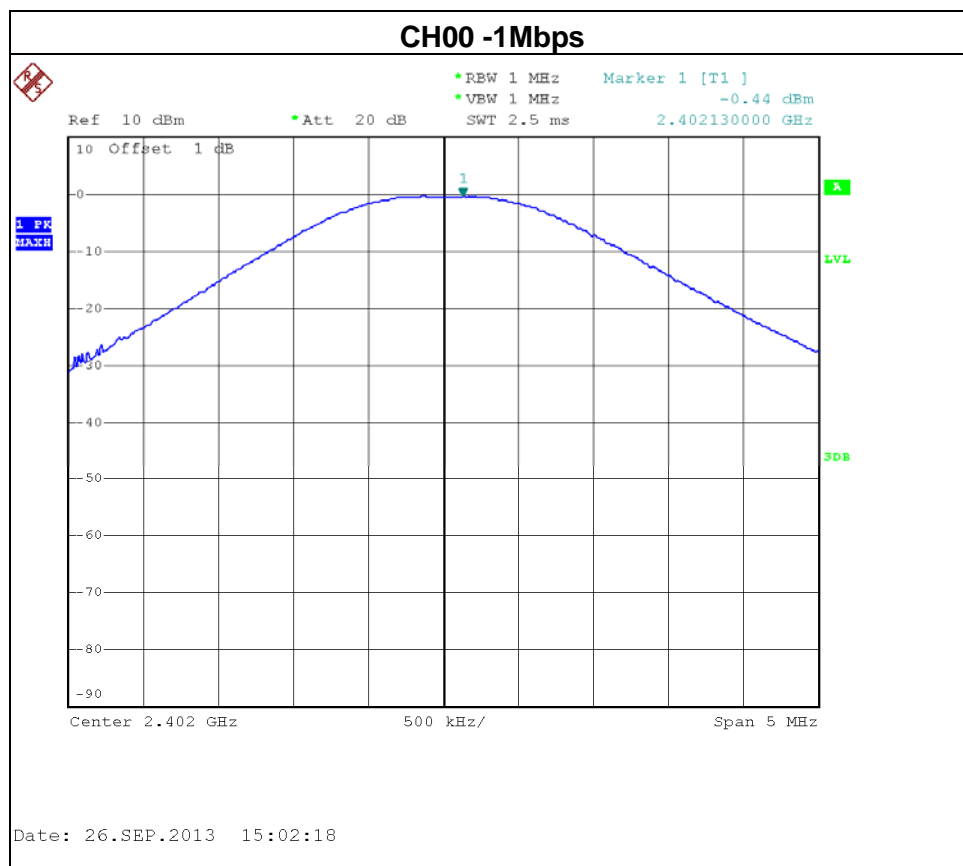

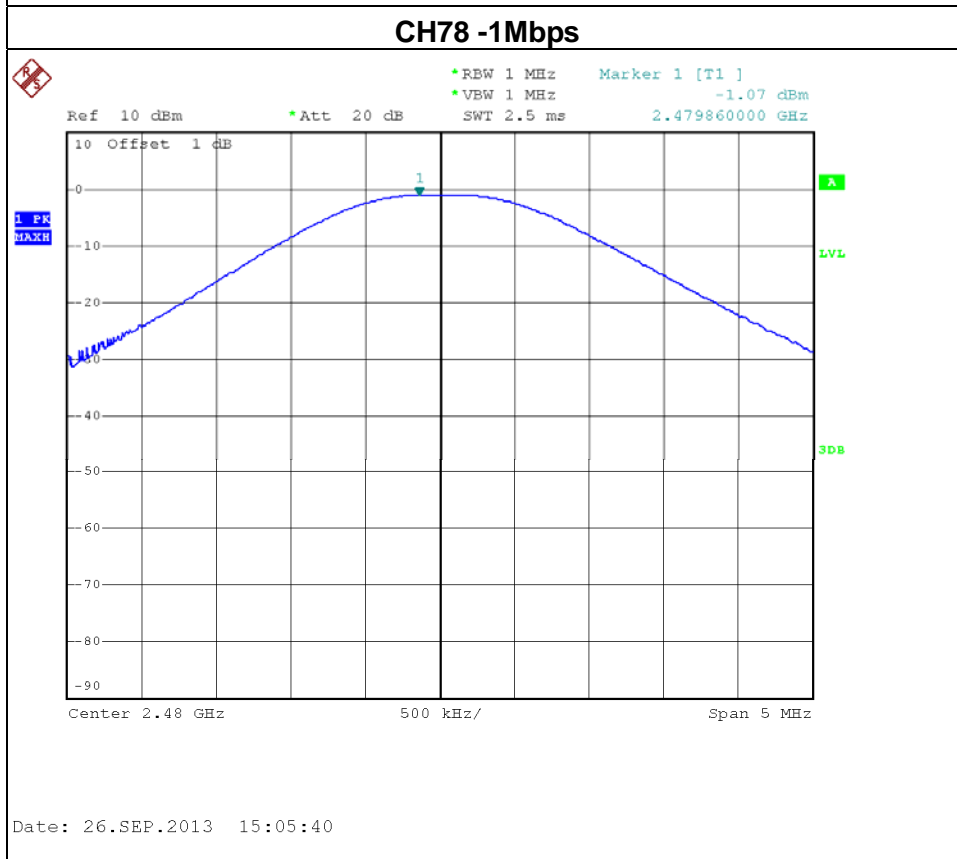
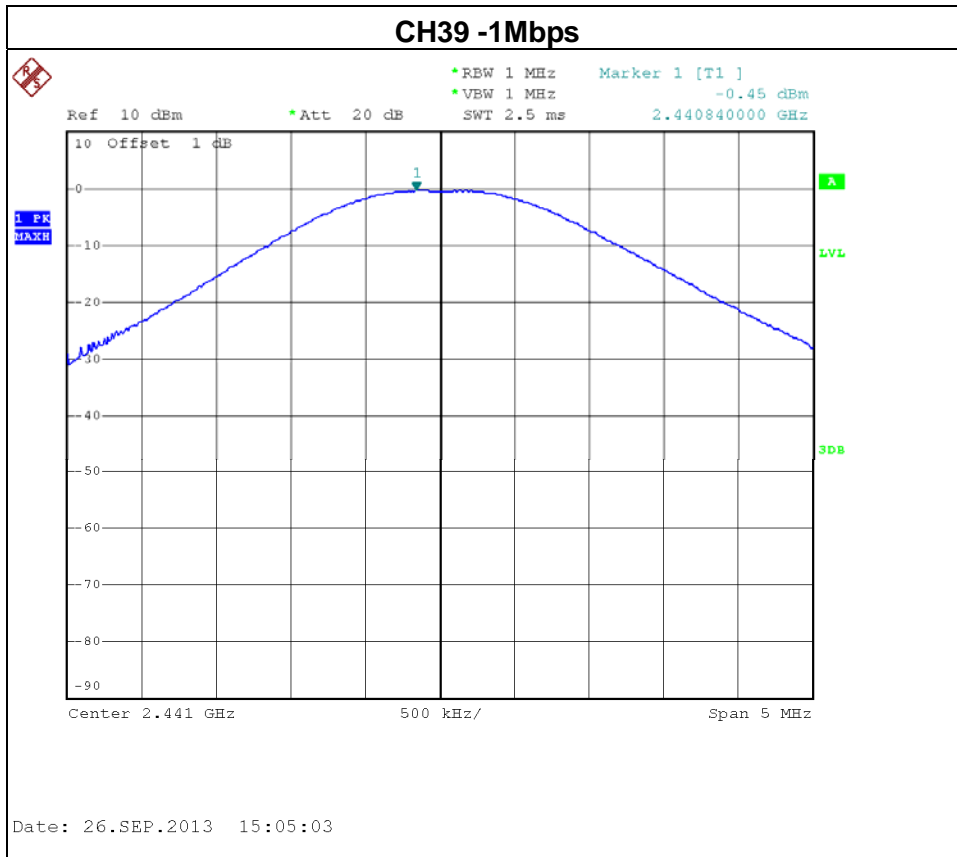



EUT:	Portable Bluetooth Speaker	Model Name :	BTV1
Temperature:	25 °C	Relative Humidity:	58 %
Pressure:	1009 hPa	Test Voltage :	AC 120V/60Hz
Test Mode :	CH00/ CH39 /CH78 -3Mbps		

Test Channel	Frequency (MHz)	Peak Output Power (dBm)	LIMIT (dBm)	LIMIT (W)
CH00	2402	0.23	21	0.125
CH39	2441	0.11	21	0.125
CH78	2480	-0.59	21	0.125

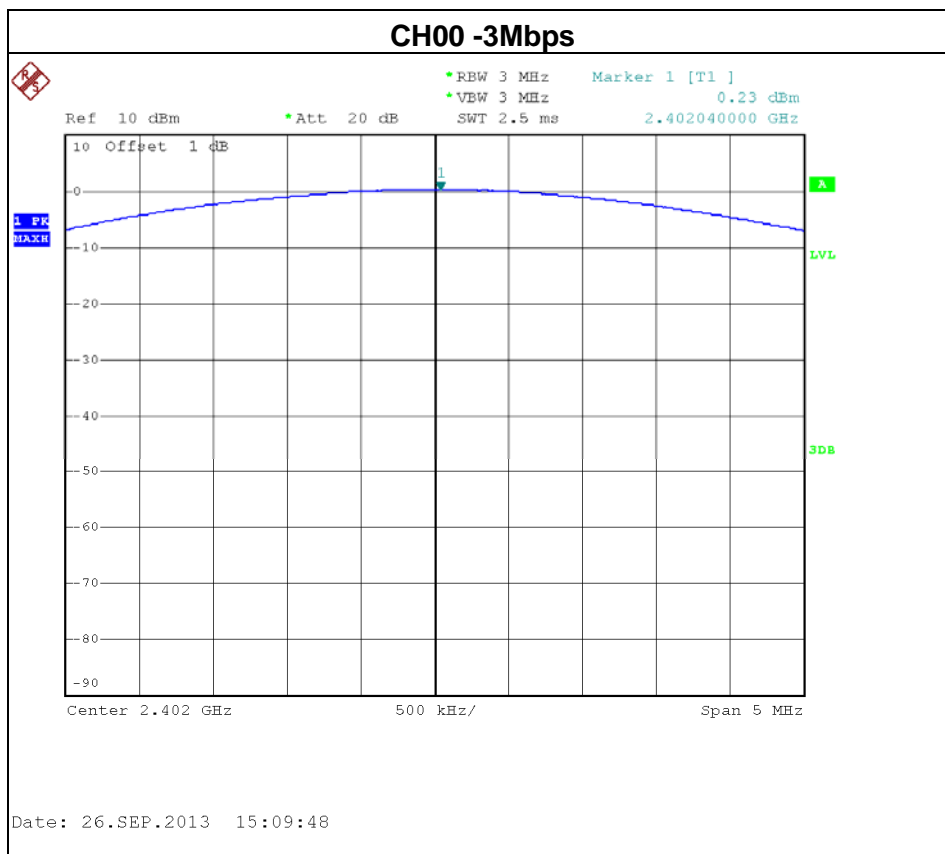

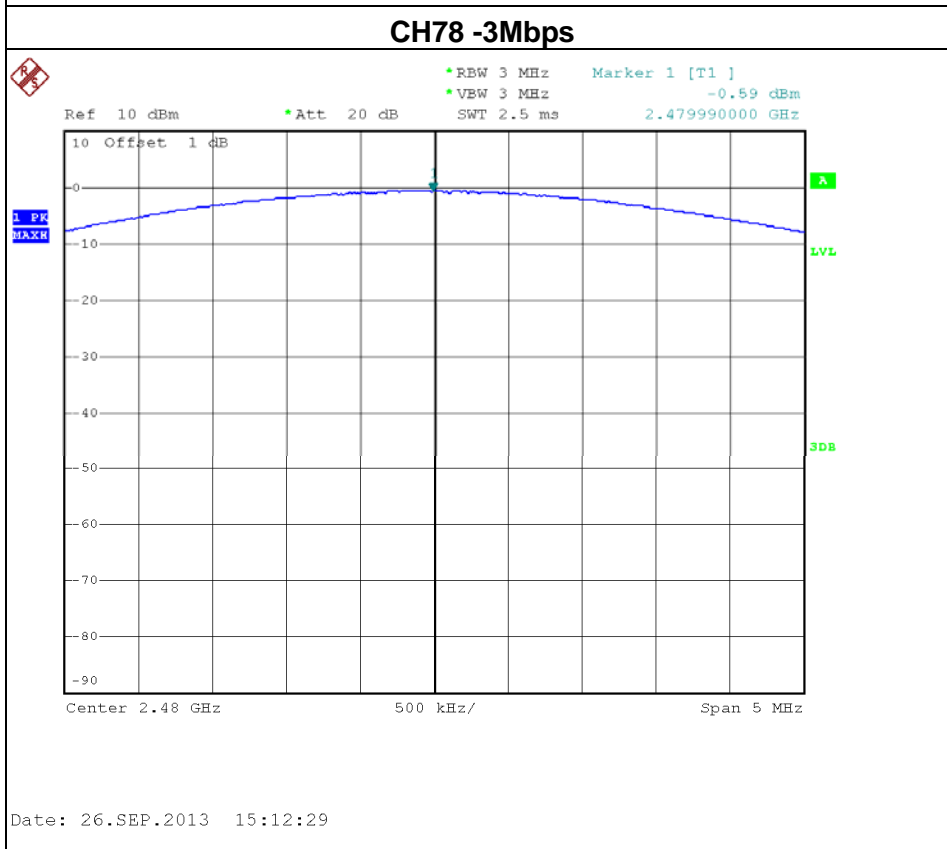
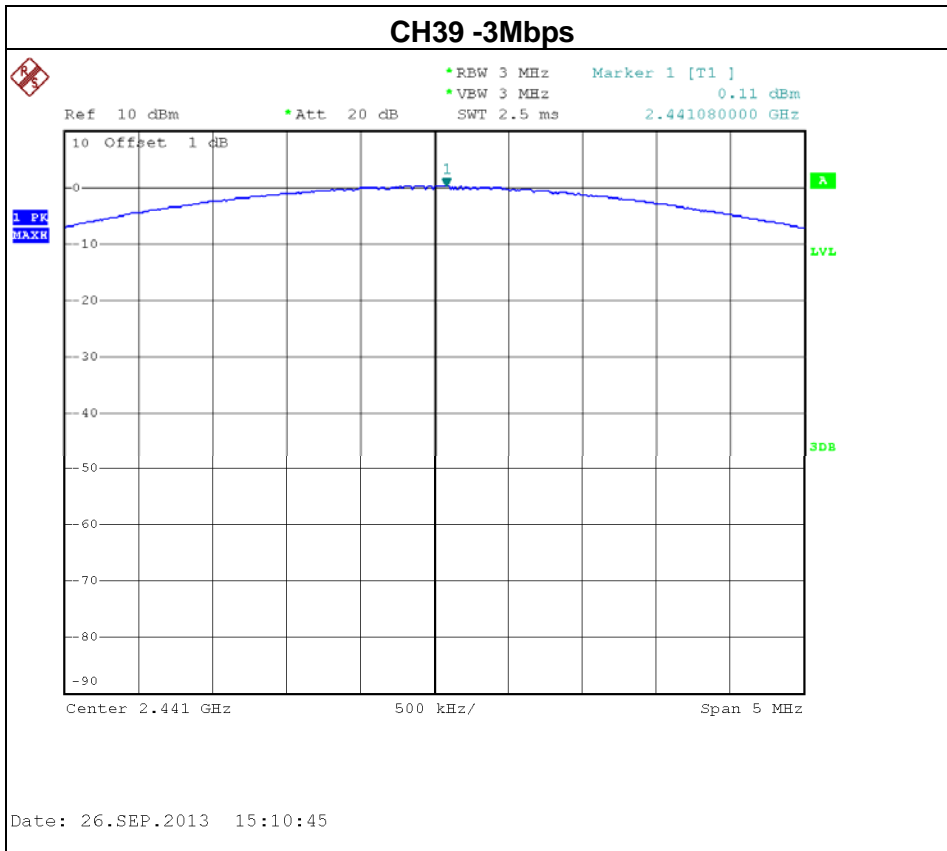



**10. ANTENNA CONDUCTED SPURIOUS EMISSION**

**10.1 APPLIED PROCEDURES / LIMIT**

20dBc in any 100 kHz bandwidth outside the operating frequency band. In case the emission fall within the restricted band specified on 15.205(a), then the 15.209(a) limit in the table below has to be followed.

<b>Frequencies (MHz)</b>	<b>Field Strength (micorvolts/meter)</b>	<b>Measurement Distance (meters)</b>
0.009~0.490	2400/F(KHz)	300
0.490~1.705	24000/F(KHz)	30
1.705~30.0	30	30
30~88	100	3
88~216	150	3
216~960	200	3
Above 960	500	3

**10.1.1 MEASUREMENT INSTRUMENTS LIST AND SETTING**

Item	Kind of Equipment	Manufacturer	Type No.	Serial No.	Calibrated until
1	Spectrum Analyzer	R&S	FSP 40	100185	Nov. 16.2013

Remark: "N/A" denotes no model name, serial no. or calibration specified.  
All calibration period of Equipment List is One Year.

**10.1.2 TEST PROCEDURE**

- a. The EUT was directly connected to the spectrum analyzer and antenna output port as show in the block diagram below,
- b. Spectrum Setting : RBW= 100KHz, VBW=100KHz, Sweep time = Auto.

**10.1.3 DEVIATION FROM STANDARD**

No deviation.

**10.1.4 TEST SETUP**



**10.1.5 EUT OPERATION CONDITIONS**

The EUT tested system was configured as the statements of 4.1.6 Unless otherwise a special operating condition is specified in the follows during the testing.





**10.1.6 TEST RESULTS**

EUT:	Portable Bluetooth Speaker	Model Name :	BTV1
Temperature:	25 °C	Relative Humidity:	58 %
Pressure:	1009 hPa	Test Voltage :	AC 120V/60Hz
Test Mode :	CH00 / CH39/ CH78-1Mbps & Hopping on mode (1Mbps)		

The max. radio frequency power in any 100kHz bandwidth outside the frequency band		The max. radio frequency power in any 100 kHz bandwidth within the frequency band.	
FREQUENCY(MHz)	POWER(dBm)	FREQUENCY(MHz)	POWER(dBm)
2399.80	-48.25	2496.00	-58.06

**Result**

In any 100kHz bandwidth outside the frequency band, the radio frequency power is at least 20dB below that in the 100kHz bandwidth within the band that contains the highest level of the desired power.

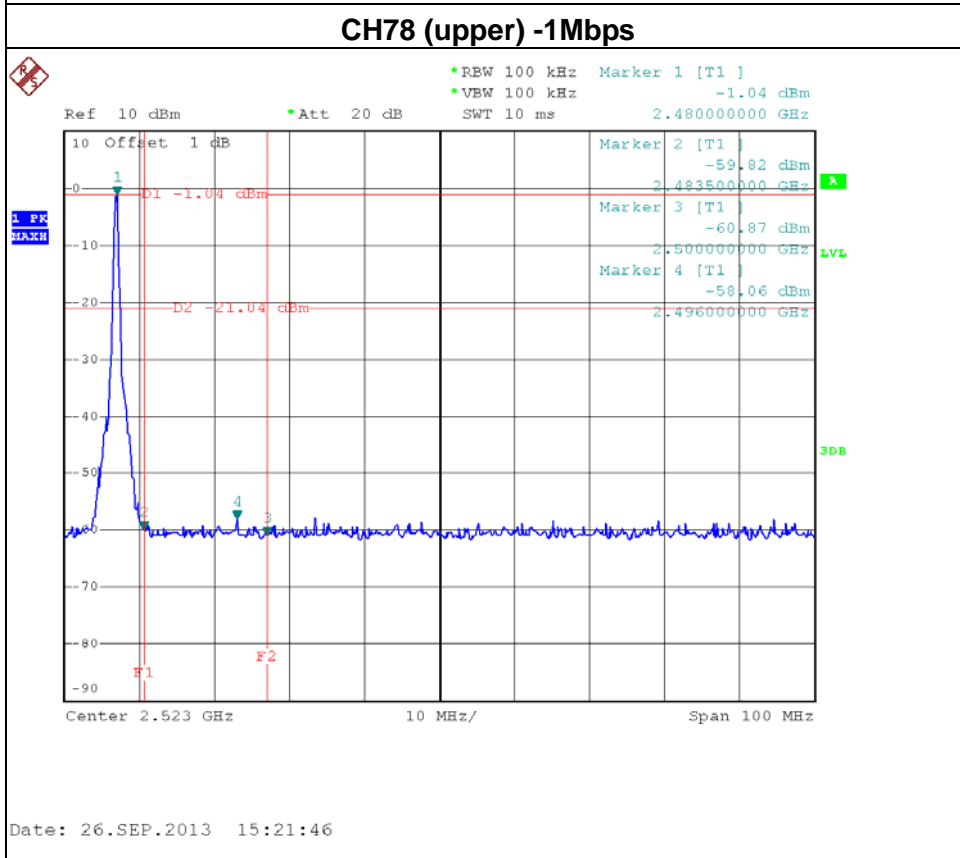
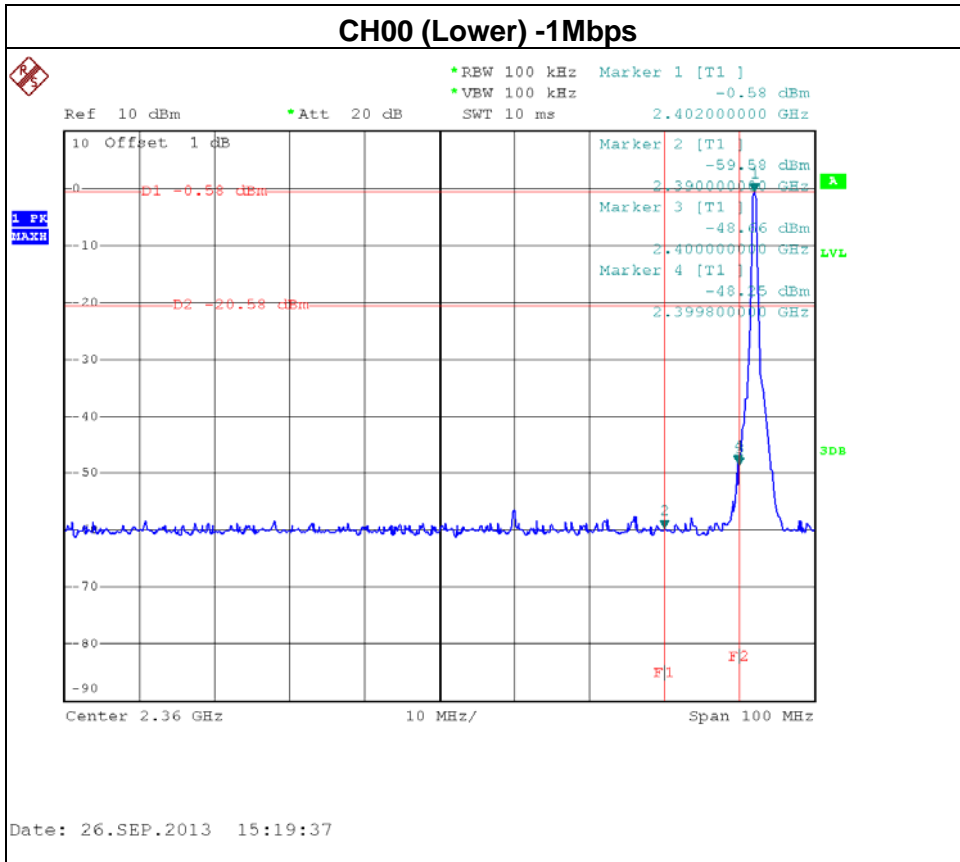



### Hopping on mode (1Mbps- Lower )

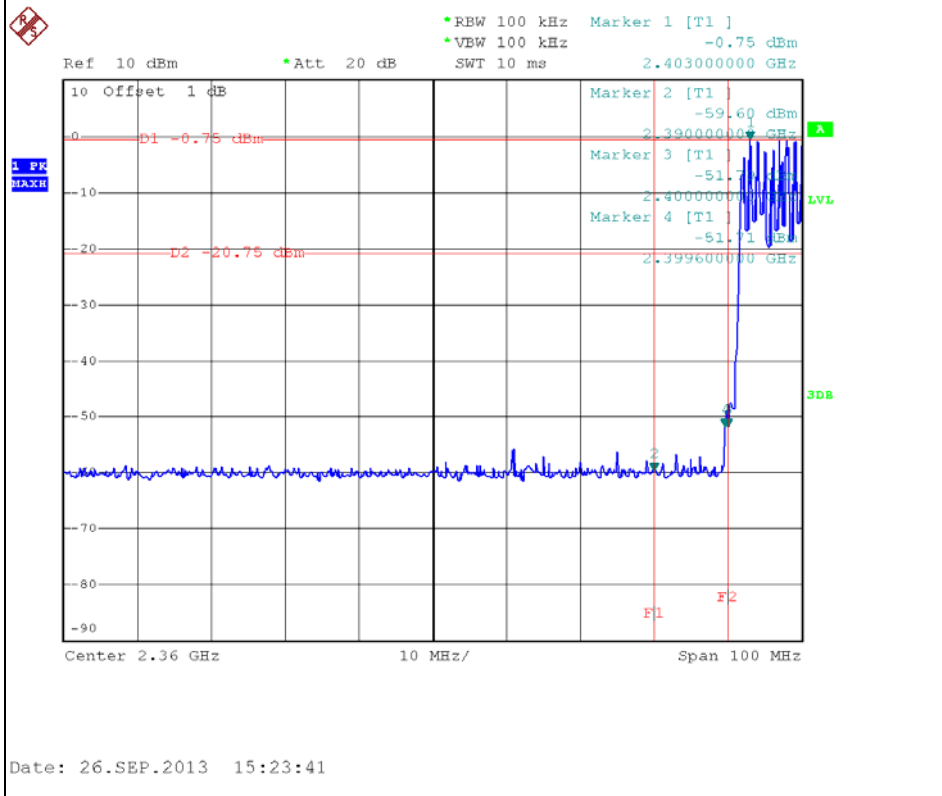

### Hopping on mode (1Mbps- upper )

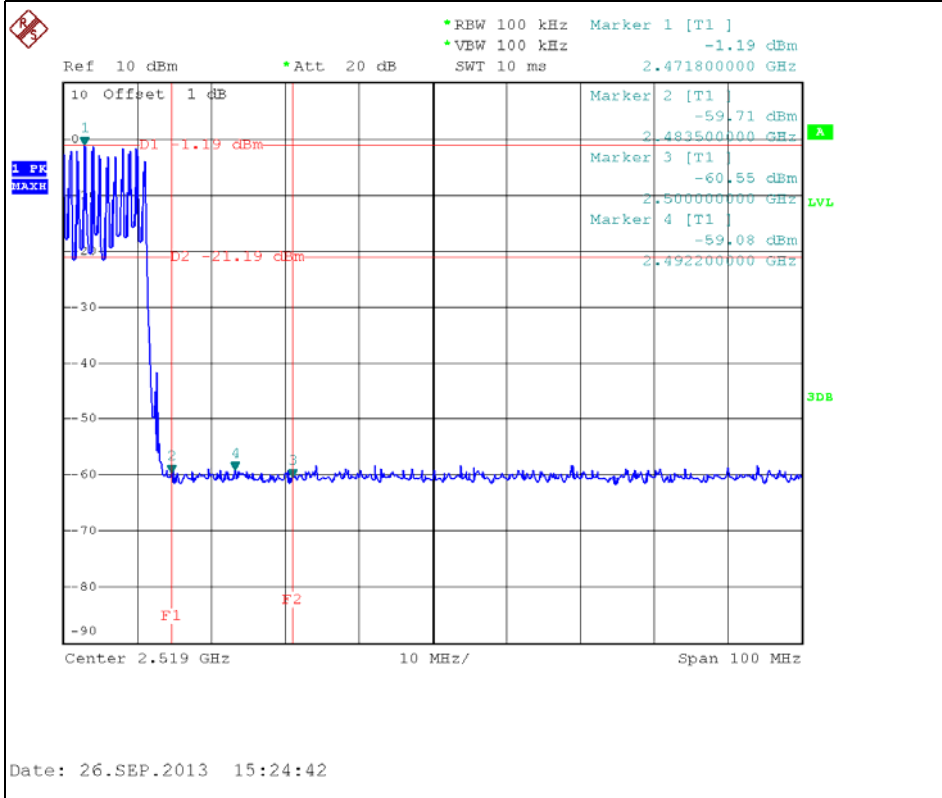

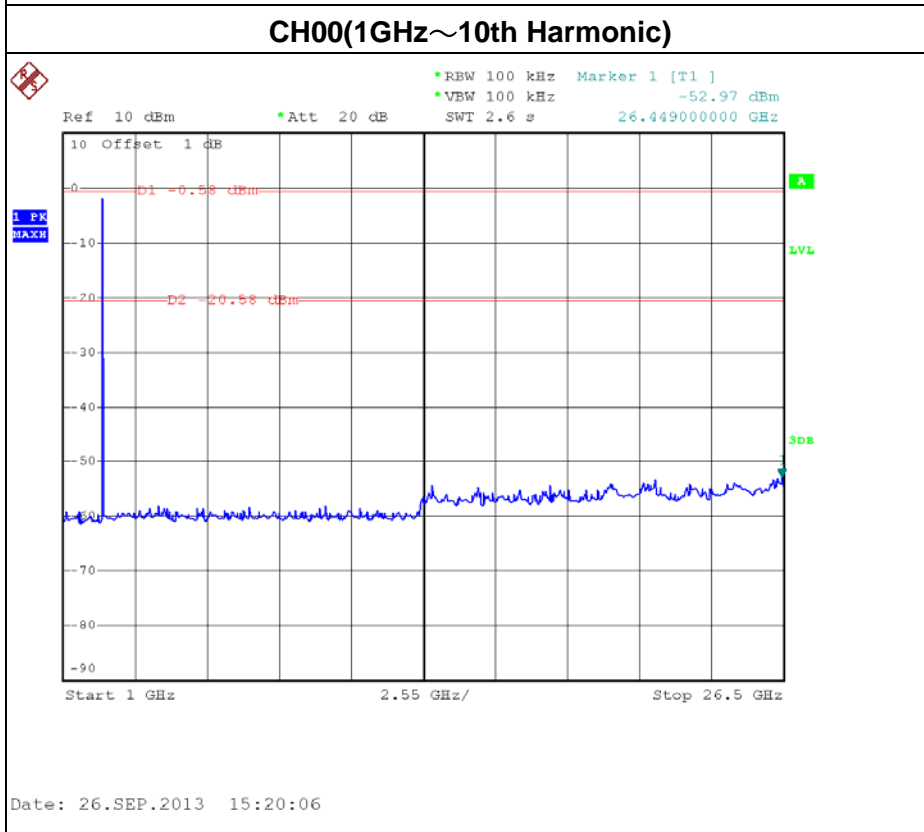
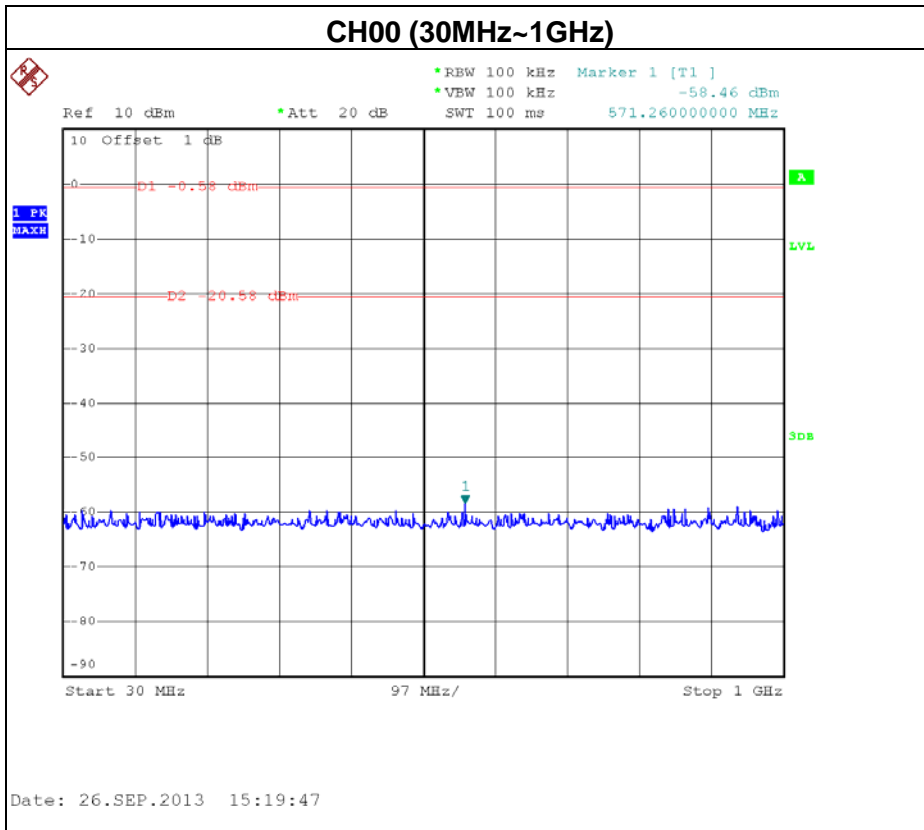

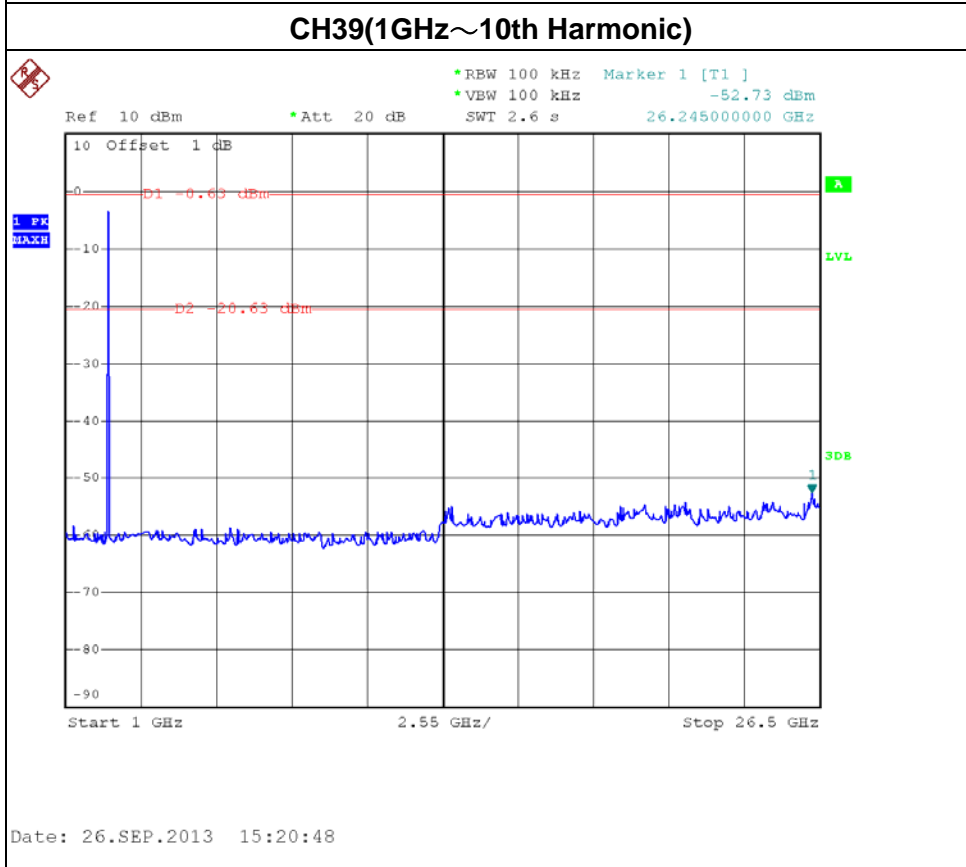
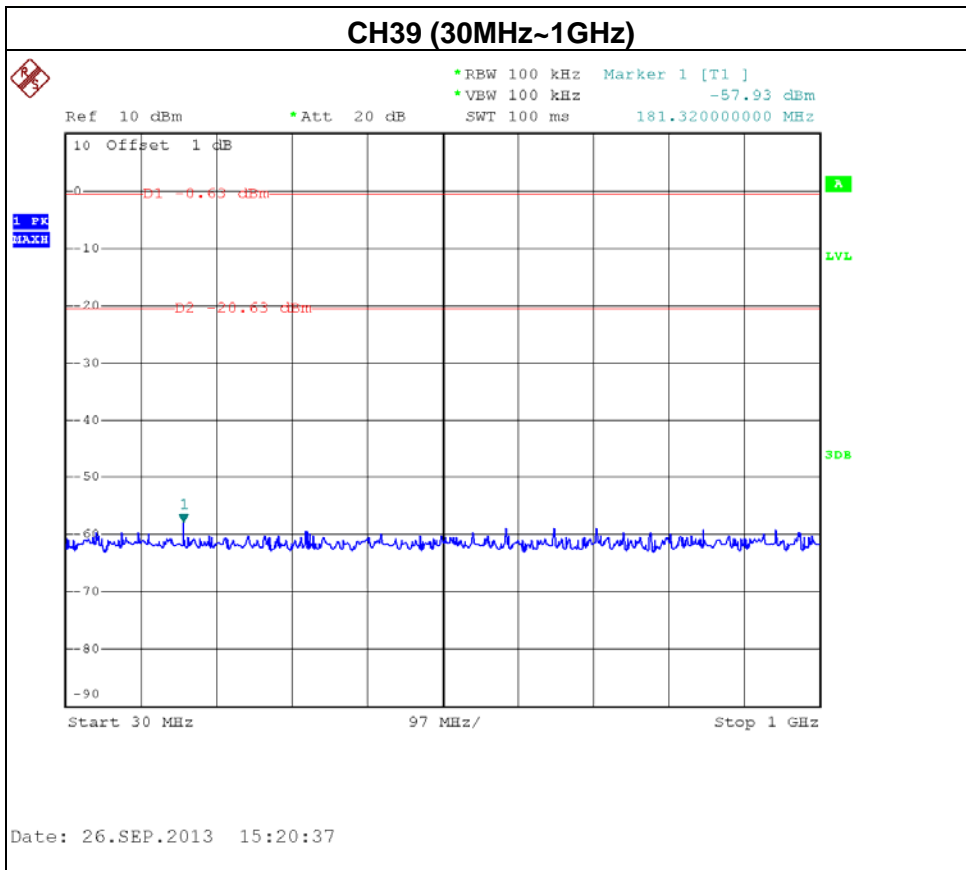

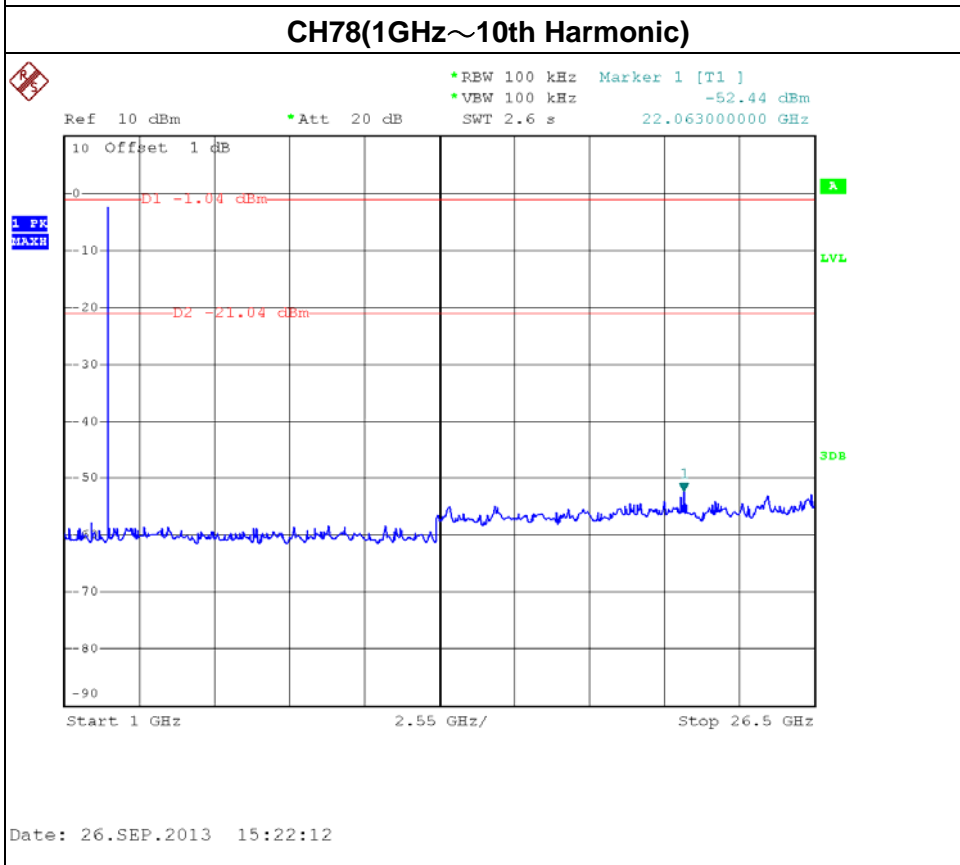
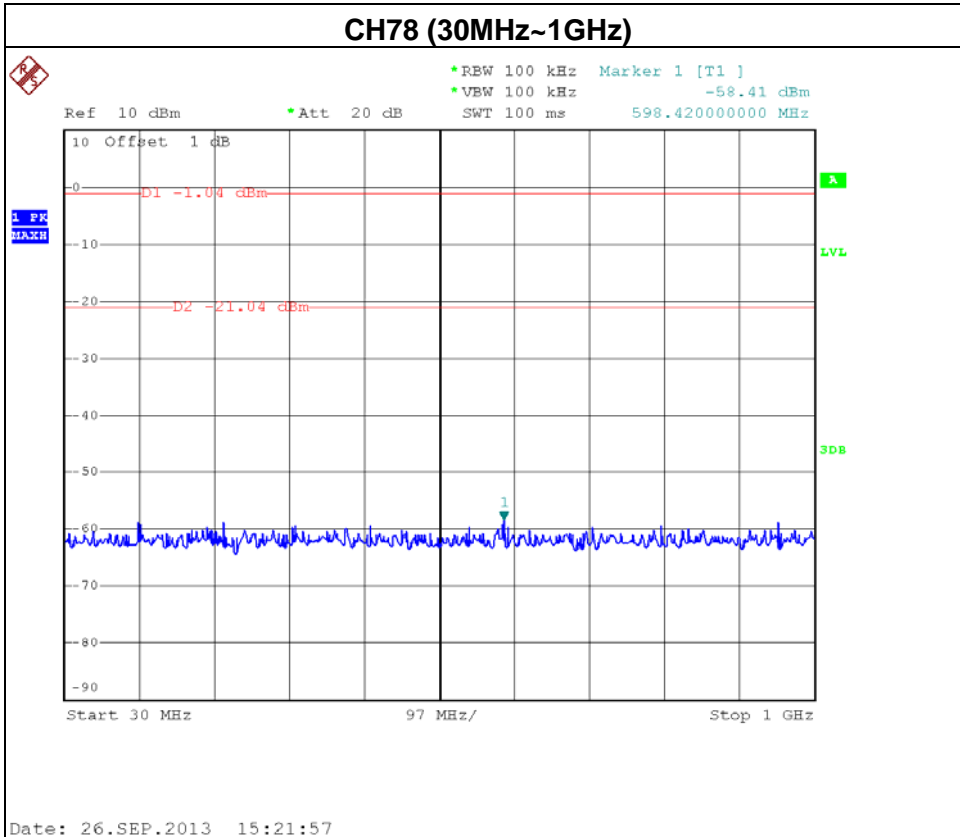



EUT:	Portable Bluetooth Speaker	Model Name :	BTV1
Temperature:	25 °C	Relative Humidity:	58 %
Pressure:	1009 hPa	Test Voltage :	AC 120V/60Hz
Test Mode :	CH00 / CH39/ CH78 -3Mbps & Hopping on mode (3Mbps)		

The max. radio frequency power in any 100kHz bandwidth outside the frequency band		The max. radio frequency power in any 100 kHz bandwidth within the frequency band.	
FREQUENCY(MHz)	POWER(dBm)	FREQUENCY(MHz)	POWER(dBm)
2400.00	-52.42	2495.80	-56.73

**Result**

In any 100kHz bandwidth outside the frequency band, the radio frequency power is at least 20dB below that in the 100kHz bandwidth within the band that contains the highest level of the desired power.

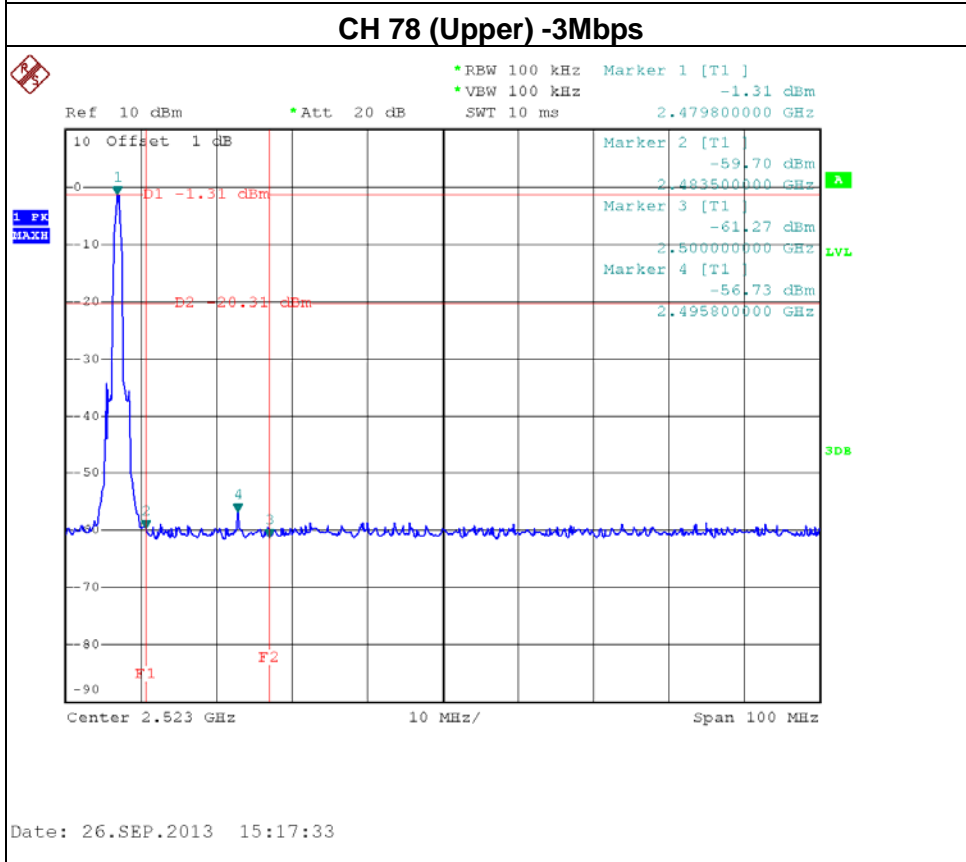
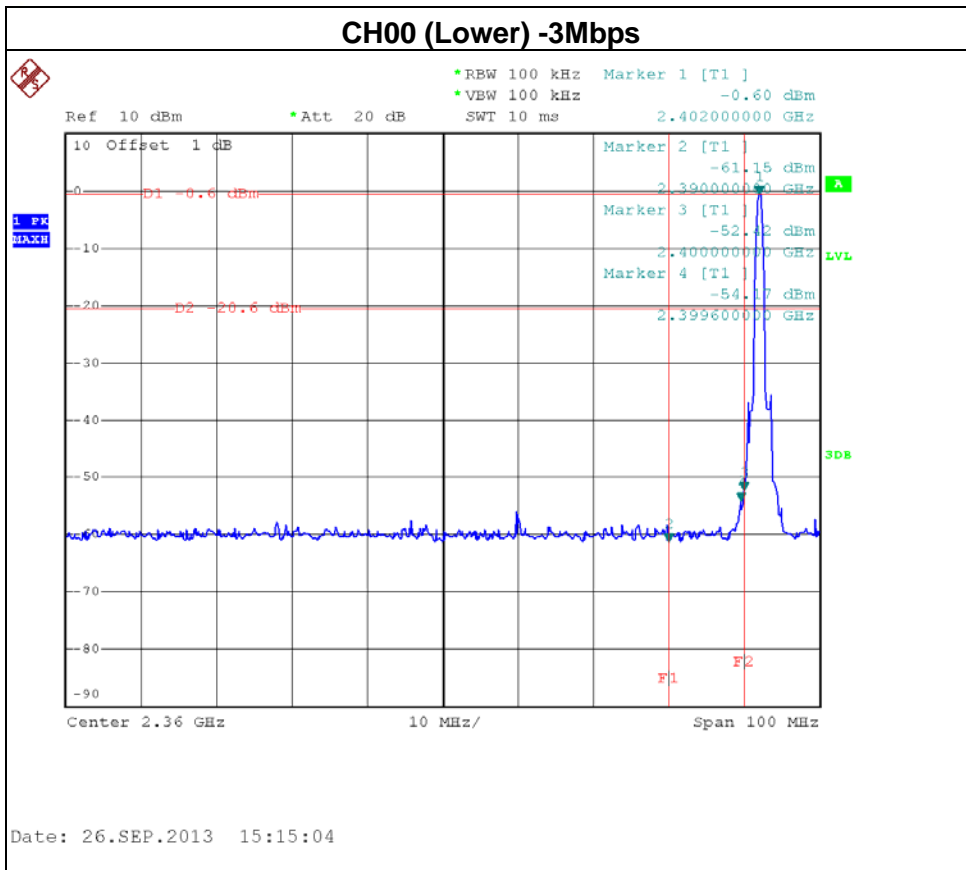



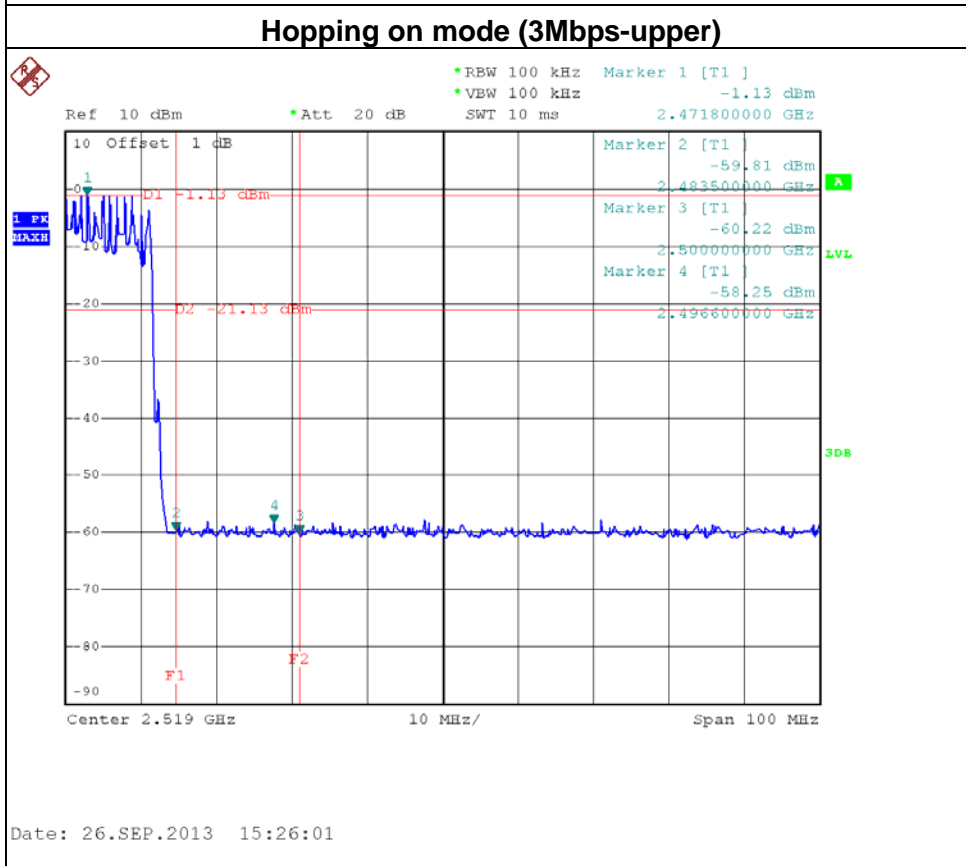
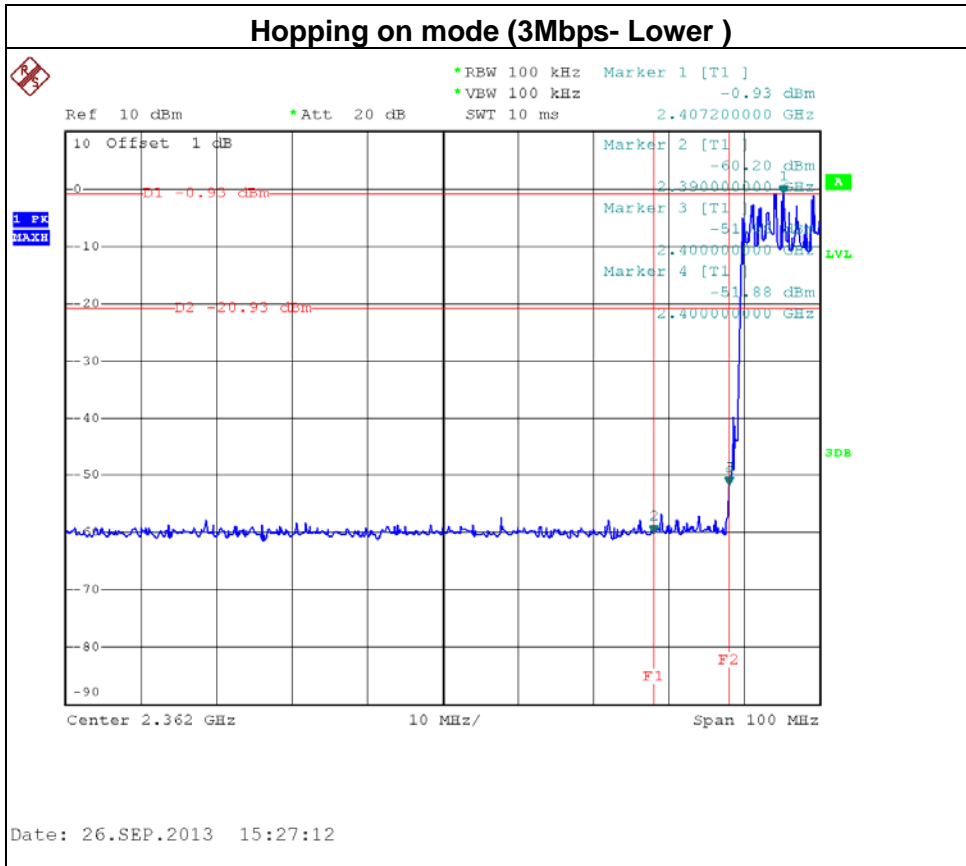

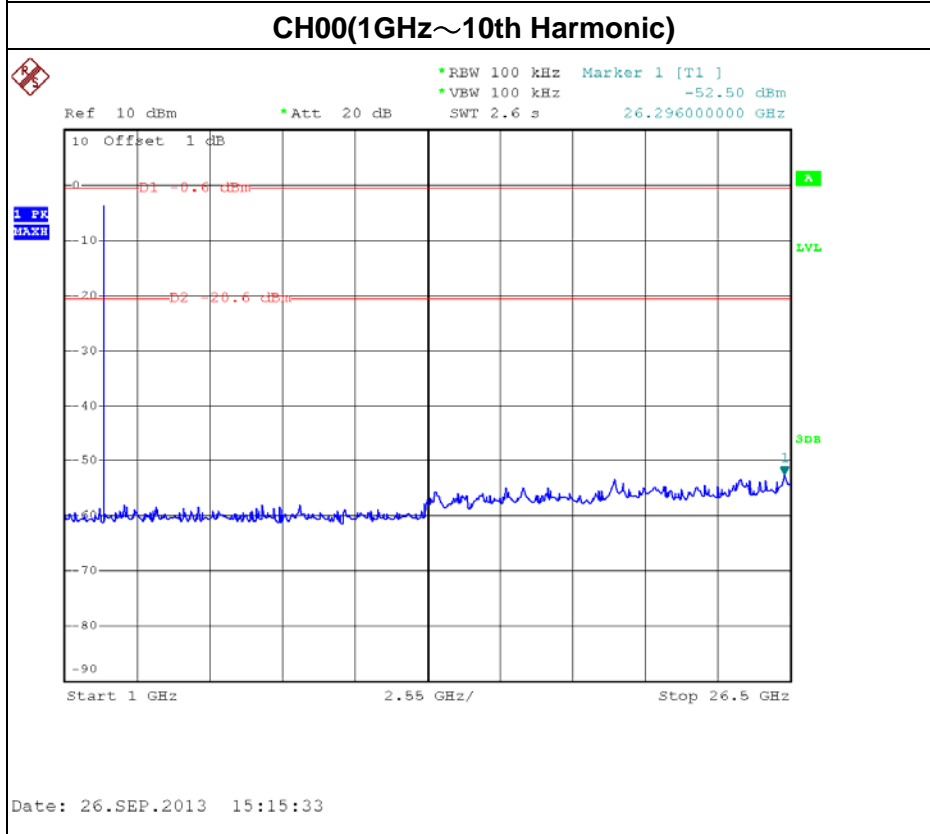
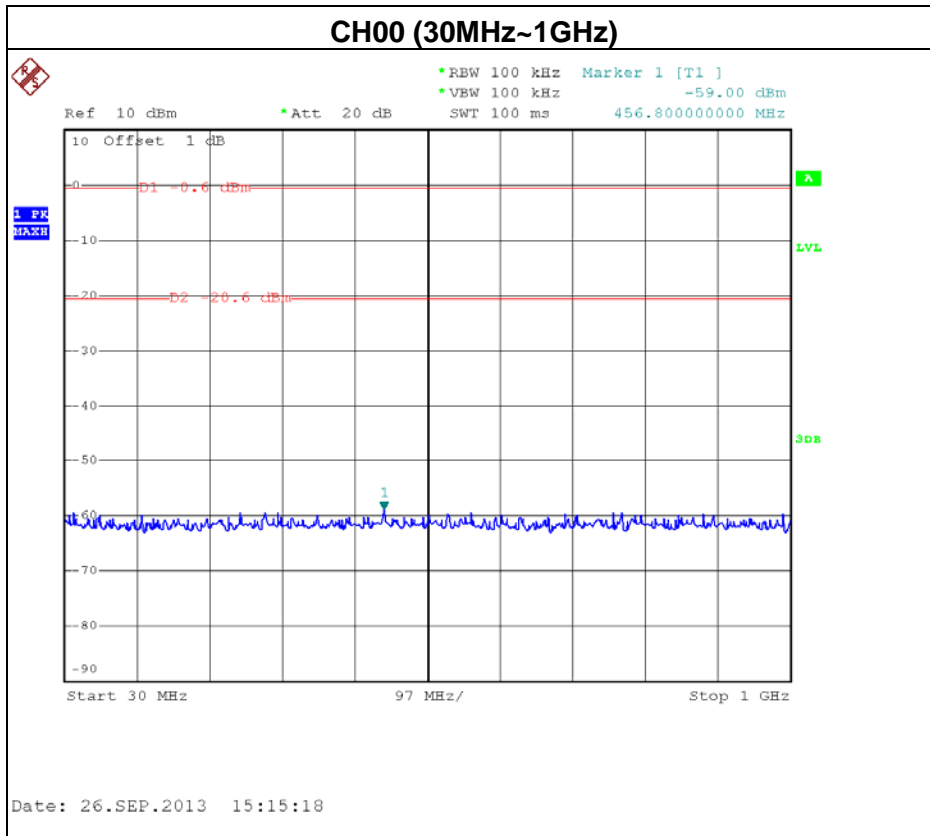

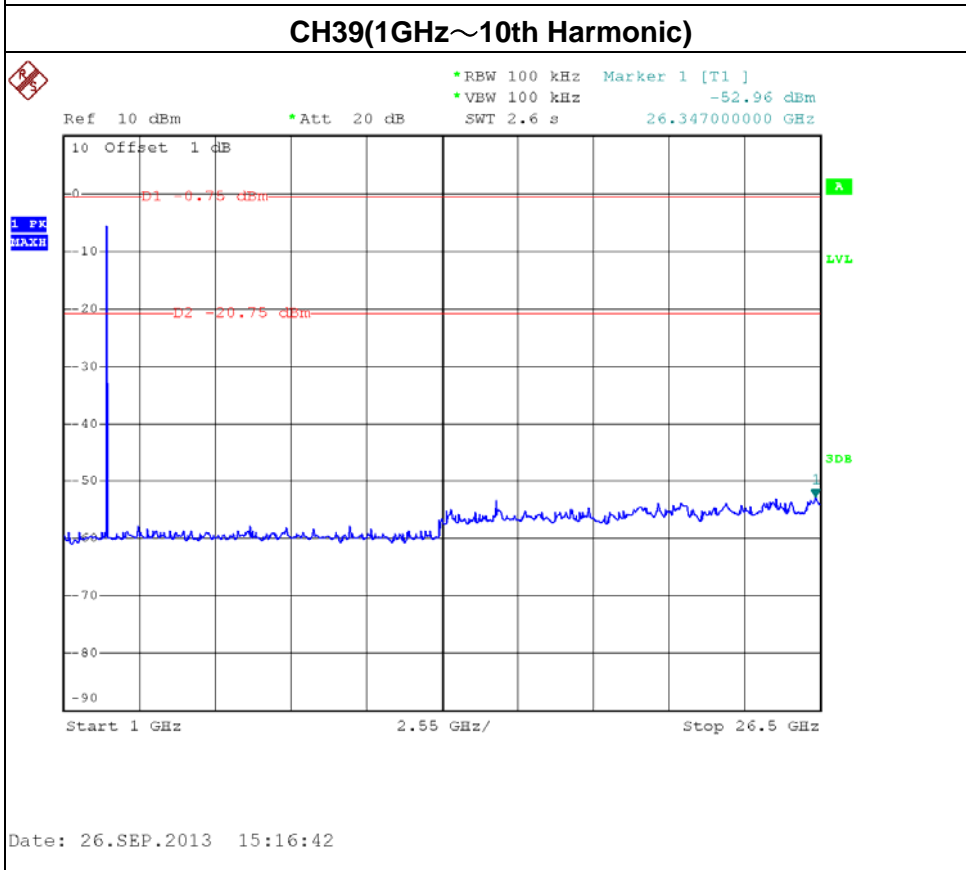
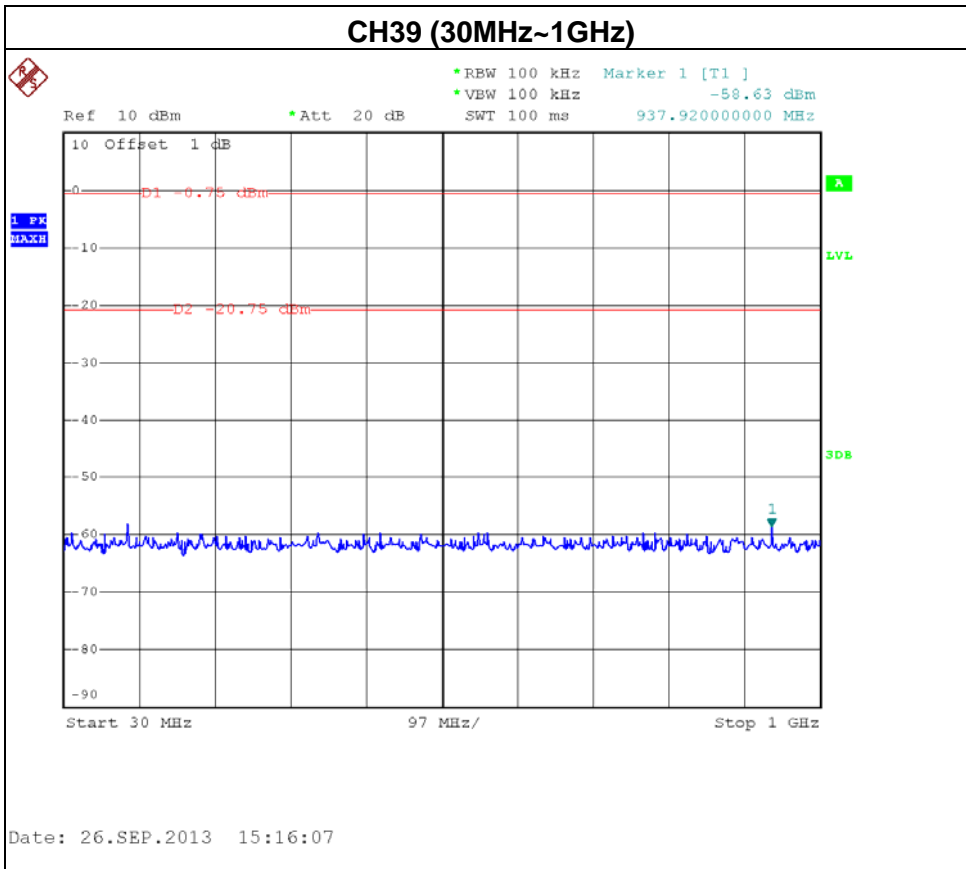

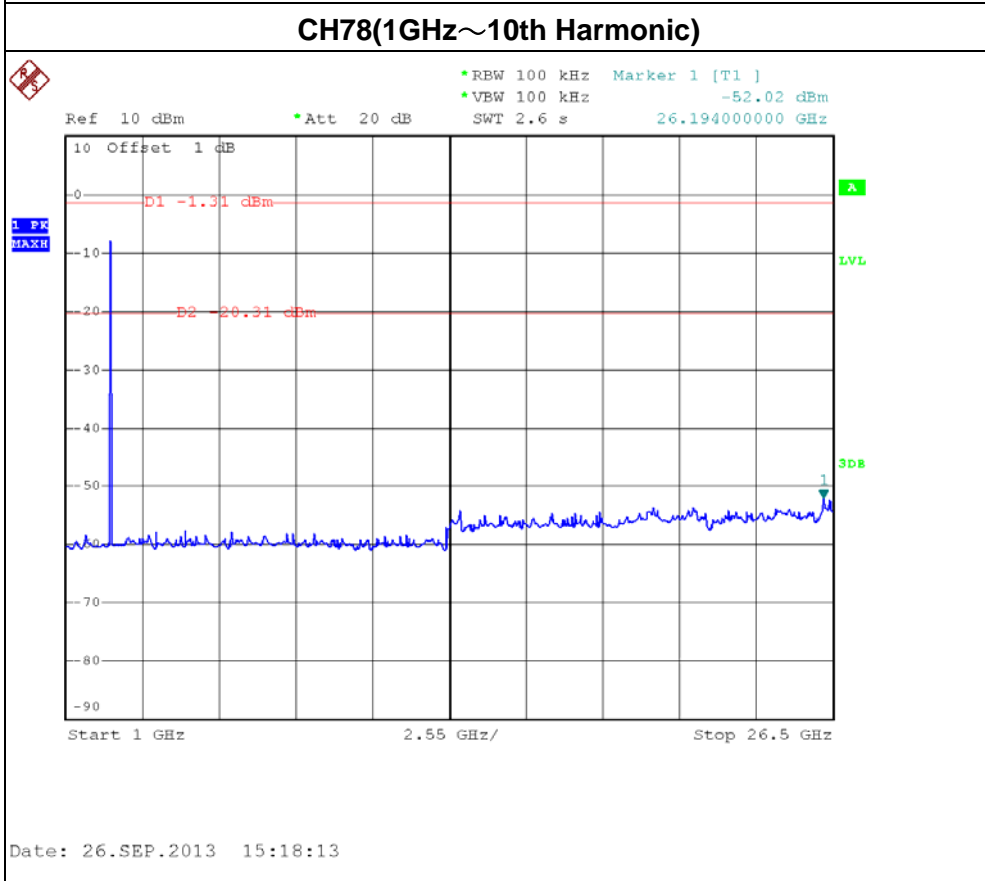
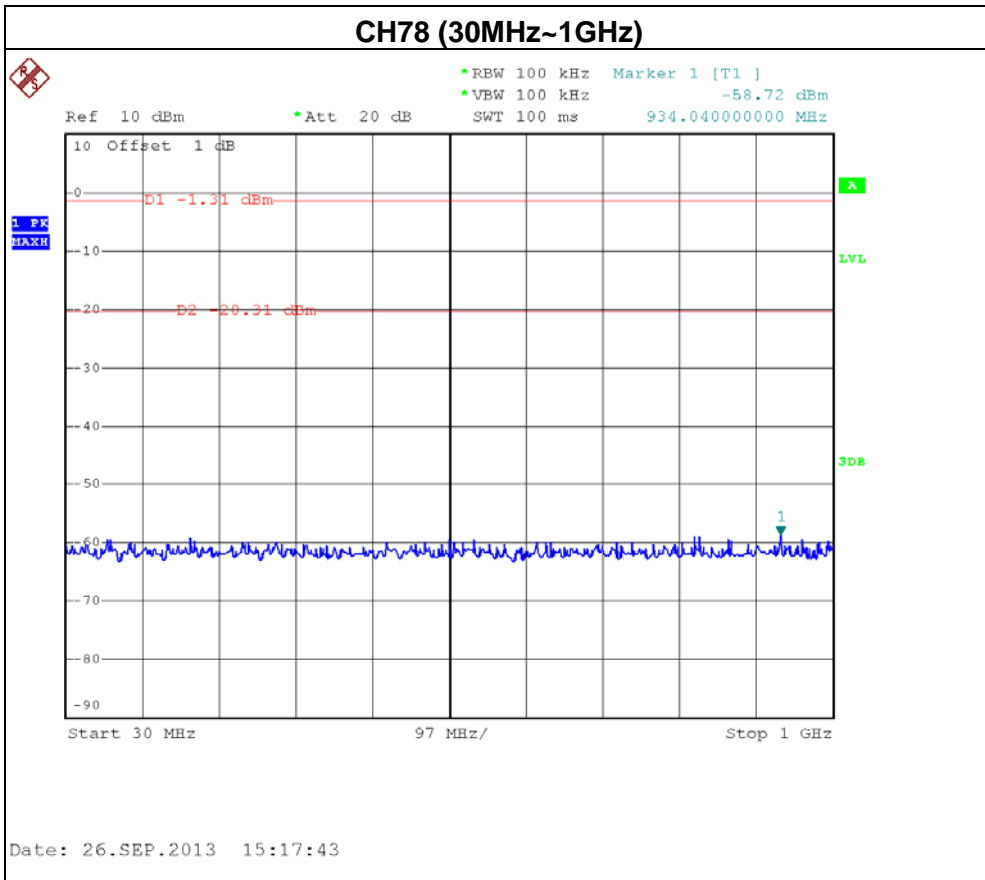



**11. EUT TEST PHOTO**

**Conducted Measurement Photos**





**Radiated Measurement Photos  
9KHz~30MHz**







**Radiated Measurement Photos  
30MHz~1000MHz**

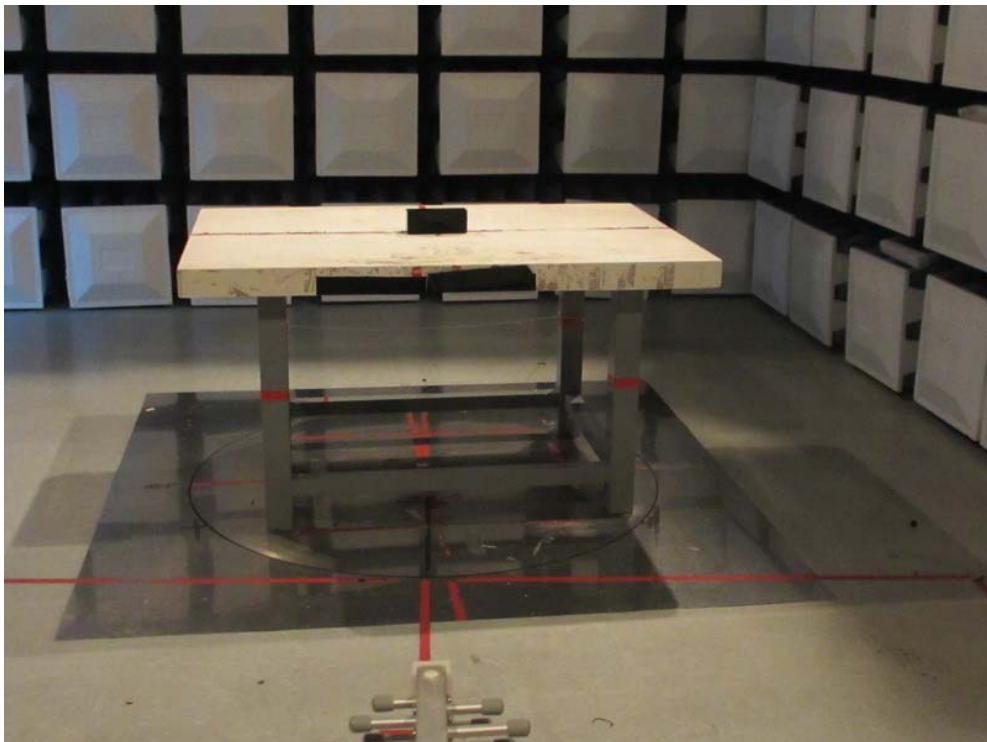
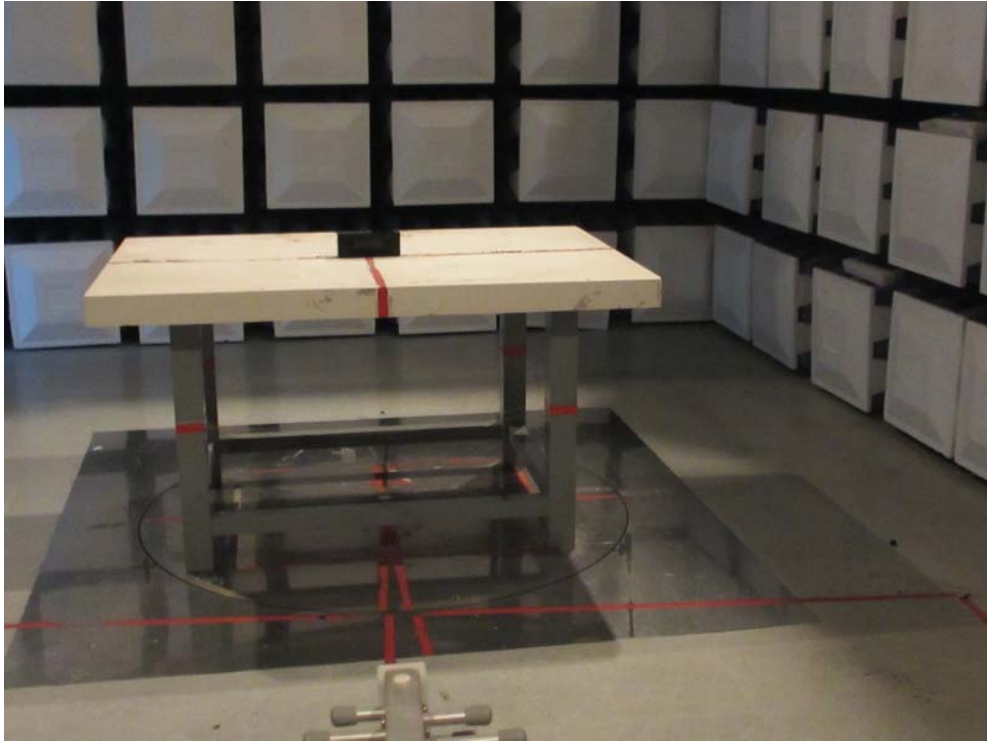



**Radiated Measurement Photos  
Above 1000MHz**

