

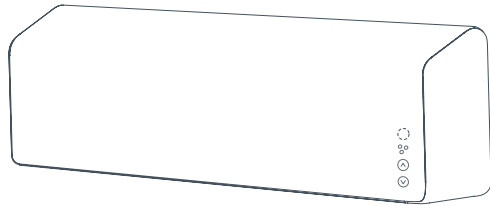

IN THE BOX



Vifa Stockholm, remote, wall bracket, power cable, AUX 3.5 mm mini jack cable, optical cable, quick-guide and warranty.

STOCKHOLM

Model: **VIFA022**

Quick Guide
ENGLISH

IMPORTANT SAFETY INSTRUCTIONS

Regulatory Safety Information

- 1 Read these instructions.
- 2 Keep these instructions.
- 3 Heed all warnings.
- 4 Follow all instructions.
- 5 Do not use this apparatus near water.
- 6 Clean only with dry cloth.
- 7 Do not block any ventilation openings. Install in accordance with the manufacturer's instructions.

- 8 Do not install near any heat sources such as radiators, heat registers, stoves, or other apparatus (including amplifiers) that produce heat.

- 9 Do not defeat the safety purpose of the polarized or grounding-type plug. A polarized plug has two blades with one wider than the other. A grounding type plug has two blades and a third grounding prong. The wide blade or the third prong are provided for your safety. If the provided plug does not fit into your outlet consult an electrician for replacement of the obsolete outlet.

- 10 Protect the power cord from being wal-ked on or pinched particularly at plugs convenience receptacles and the point where they exit from the apparatus.

- 11 Only use attachments/accessories specified by the manufacturer.

- 12  Use only with the cart, stand, tripod, bracket or table specified by the manufacturer or sold with the apparatus. When a cart is used, use caution when moving the cart/apparatus combination to avoid injury from tip-over.

- 13 Unplug this apparatus during lightning storms or when unused for long periods of time.

- 14 Refer all servicing to qualified service personnel. Servicing is required when the apparatus has been damaged in any way, such as power-supply cord or plug is damaged, liquid has been spilled or objects have fallen into the apparatus, the apparatus has been exposed to rain or moisture, does not operate normally or has been dropped.

- 15 To completely disconnect unit power from the AC mains, disconnect the unit's power cord from the mains socket.
- 16 Important! This equipment is not intended to be used on soft supportlike beddings. Blankets etc.)

- 17 The socket-outlet shall be easily accessible.

- 18 Disposal of a battery into fire or a hot oven, or mechanically crushing or cutting of a battery can result in an explosion

- 19 High or low extreme temperatures that a battery can be subjected to during use is 10°C-45 °C, storage-20°C-40°C or transportation 10°C-45°C, and low air pressure is 86-106kpa at 2000m high altitude

- 20 Leaving a battery in an extremely high temperature surrounding environment that can result in an explosion or the leakage of flammable liquid or gas.

- 21 Battery subjected to extremely low air pressure that may result in an explosion or the leakage of flammable liquid or gas.

- 22 Product label affixed to the bottom of the product.

- 23 **CAUTION:** Danger of explosion if battery is incorrectly replaced. Replace only with the same or equivalent type.

- 24 **WARNING:** The Battery(battery pack or batteries installed) shall not be exposed to excessive heat such as sunshine, fire or the

- like.
- 25 **WARNING:**The main plug shall remain readily operable

- 26 Keep minimum distances 1cm around the apparatus for sufficient ventilation

- 27 The ventilation should not be impeded by covering the ventilation openings with items, such as newspapers, table-cloths, curtains, etc.

- 28 Attention should be drawn to the environmental aspects of battery disposal.

- 29 The use of apparatus in tropical and/or moderate climates.

- 30 Risk of explosion if the battery is replaced by an incorrect type.

- 31 The equipment shall be ensure correct and safe installation and interconnection

- WARNING:**
- To reduce the risk of fire and electric shock do not expose this apparatus to rain or moisture.
 - Do not place objects filled with liquids such as vases on the apparatus.
 - Do not open apparatus. There are no user-serviceable parts inside. Risk of electric shock inside.
 - The apparatus shall not be exposed to dipping or splashing.
 - No naked flame sources, such as lighted candles, such as lighted candles, should be placed on the apparatus

-  The lightning flash and arrow head within the triangle is a warning sign alerting you of dangerous voltage inside the product

-  The exclamation point within the triangle is a warning sign alerting you of important instructions accompanying the product.

-  Keep batteries out of reach of children. If swallowed, contact a physician immediately.

-  ISO 7000-0434 (2004-01)

-  Combination of ISO 7000-0434 (2004-01) and ISO 7000-1641 (2004-01)

- WARNING:**
- Do not ingest the battery, Chemical Burn Hazard
- (The remote control supplied with) This product contains a coin/button cell battery. If the coin/button cell battery is swallowed, it can cause severe internal burns in just 2 hours and can lead to death.

- Keep new and used batteries away from children.

- If the battery compartment does not close securely, stop using the product and keep it away from children.

- If you think batteries might have been swallowed or placed inside any part of body, seek immediate medical attention.

IMPORTANT STATEMENTS

This device complies with Part 15 of the FCC Rules. Its operation is subject to the following two conditions:

1. This device may not cause harmful interference, and
2. This device must accept any interference received, including interference that may cause undesired operation.

Cet appareil est conforme à la section 15 des réglementations de la FCC. Le fonctionnement de l'appareil est sujetaux deux conditions suivantes:

1. Cet appareil ne doit pas provoquer d'interférences néfastes, et 2. Cet appareil doit tolérer les interférences reçues, y compris celles qui risquent de provoquer un fonctionnement indésirable.

Note: This product has been tested and found to comply with the limits for a Class B digital device, pursuant to Part 15 of the FCC Rules. These limits are designed to provide reasonable protection against harmful interference in a residential installation. This product generates, uses, and can radiate radio frequency energy and, if not installed and used in accordance with the instructions, may cause harmful interference to radio communications. However, there is no guarantee that interference will not occur in a particular installation. If this product does cause harmful interference to radio or television reception, which can be determined by turning the equipment off and on, the user is encouraged to try to correct the interference by one or more of the following measures:

- Reorient or relocate the receiving antenna.
- Increase the separation between the equipment and receiver.
- Connect the equipment into an outlet on a circuit different from that to which the receiver is connected.
- Consult the dealer or an experienced radio/TV technician for help.

Changes or modifications not expressly approved by the party responsible for compliance could void the user's authority to operate the equipment.

This device complies with Industry Canada licence-exempt RSS standard(s).

Operation is subject to the following two conditions:

1. This device may not cause interference, and
2. This device must accept any interference, including interference that may cause undesired operation of the device.

Le présent appareil est conforme aux CNR d'Industrie Canada applicables aux appareils radioexempt de licence. L'exploitation est autorisée aux deux conditions suivantes :

1. l'appareil ne doit pas produire de brouillage, et
2. l'utilisateur de l'appareil doit accepter tout brouillage radioélectrique subi, même si le brouillage est susceptible d'en compromettre le fonctionnement.

FCC/IC Radiation Exposure Statement
This equipment complies with FCC/IC RSS-102 radiation exposure limits set forth for an uncontrolled environment. This equipment should be installed and operated With minimum distance 20 cm between the radiator & your body.

Déclaration de la FCC et d'IC sur l'exposition aux radiations Cet appareil est conforme à la norme RSS102 de la FCC/IC relative aux limites d'exposition aux radiations dans un environnement non contrôlé. Vous devez installer et utiliser cet appareil en respectant une distance minimale de 20 cm entre votre corps et l'élément rayonnant.

Vifa Denmark A/S
Mariendalsvej 2A
DK - 8800 Viborg
vifa.dk

REGISTER AND TRADEMARKS

We encourage you to register your product at: www.vifa.dk/register

*A Vifa product is in compliance with **CE** directives of relevance, including RoHS*

directive – see product label for more regional



Made for iPod touch (3rd through 6th generation), iPod nano (4th through 7th generation), iPhone (7 Plus, 7, 6s Plus, 6s, 6 Plus, 6, 5s, 5c, 5, 4s, 4, 3GS), iPad (Air 2, mini 3, Air, mini2, mini, 4th through 1st generation), AirPlay, iPad, iPhone, iPod nano and iPod touch are trademarks of Apple Inc., registered in the U.S. and other countries.

AirPlay works with iPhone, iPad, and iPod touch with iOS 4.3.3 or later, Mac with OS X Mountain Lion or later, and PC with iTunes 10.2.2 or later

AirPlay works with iPhone, iPad, and iPod touch with iOS 4.3.3 or later, Mac with OS X Mountain Lion or later, and PC with iTunes 10.2.2 or later. Supports iOS 7 or later for setup using.

“Made for iPod”, “Made for iPhone” and “Made for iPad” mean that an electronic accessory has been designed to connect specifically to iPod, iPhone, or iPad, respectively, and has been certified by the developer to meet Apple performance standards. Apple is not responsible for the operation of this device or its compliance with safety and regulatory standards. Please note that the use of this accessory with iPod, iPhone, or iPad may affect wireless performance.

Apple, the Apple logo, Airplay, the Airplay logo, iPad, iPhone, iPod nano and iPod touch are trademarks of Apple Inc., registered in the U.S. and other countries. App Store is a service mark of Apple Inc., registered in the U.S. and other countries.



The Wi-Fi CERTIFIED™ Logo is a certification mark of Wi-Fi Alliance®.



The Bluetooth® word mark and logos are registered trademarks owned by Bluetooth SIG, Inc., and any use of such marks by Vifa Denmark A/S is under license.



Qualcomm® aptX™ is a product of Qualcomm Technologies International, Ltd.



The N-Mark is a trademark or registered trademark of NFC Forum, Inc. in the United States and in other countries.



The Spotify software is subject to third party licenses found here: www.spotify.com/connect/third-party-licenses.



Google Play and the Google Play logo are trademarks of Google Inc.



Vifa®HOME, Vifa®PLAY, Vifa®LINK and the logos are trademarks of Vifa Denmark A/S.

For more information please visit our website at vifa.dk

SPECIFICATIONS

Description Vifa®HOME - wireless loudspeaker

Technical features
Bluetooth
Qualcomm® aptX™ HD audio
Wi-Fi B/G, 2,4GHZ
Apple AirPlay
Works with DLNA
DSP signal processing
Force Balanced Woofers
6 channel high performance power amplifier

Driver units
Tweeter
2 X 28 mm Vifa drive units with soft dome and neodymium magnet.

Midrange
2 X 80 mm Vifa drive units with aluminium cone and neodymium magnet.

Woofer
4 X 100 mm Vifa drive units with flat sandwich cone and neodymium magnet. Mounted mechanically back to back in a force balanced configuration supported by 4 passive radiators.

Frequency response 42Hz - 20kHz @ +/- 3 dB
Input voltage 100-240V ~ 50/60Hz
Max. Rated power consumption 160 watt
Standby power consumption Less than 0,5 watt

Output USB 5 volt / 2.1 A

Inputs
Bluetooth aptX™ HD
Wi-Fi Direct
Wi-Fi networked
Wired optical or analog (3.5 mm minijack)
USB stick

Dimensions Height/Width/Depth 215 mm / 1100 mm / 100 mm
Net weight 9.8 kg
Frame Diecast aluminium
Textile Custom made Kvadrat textile

VIFA STOCKHOLM

Out of Box

- 1 Plug power cable into your speaker and then plug into a power outlet.

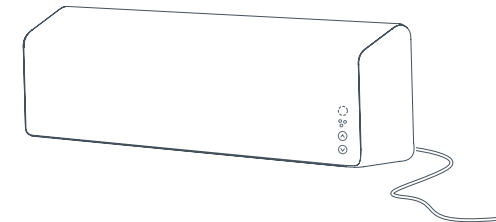

- 2 Long press the power button to turn it ON, wait 10-20 seconds until the product is ready.

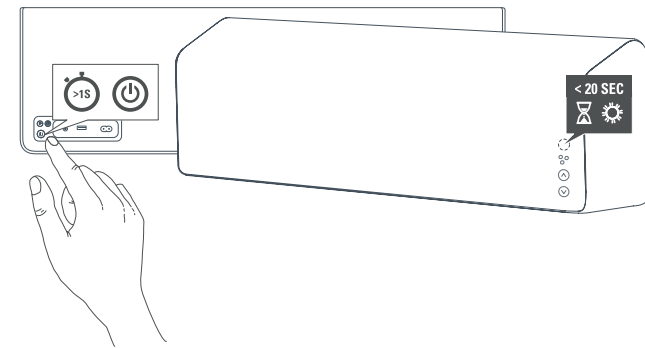

CONNECTING TO WI-FI NETWORK

Download the free Vifa®HOME app.
Learn more about setup, visit vifa.dk/support

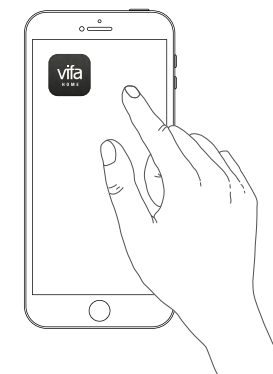

During setup, you will connect your speaker to the Internet. Please make sure you have your Wi-Fi password.

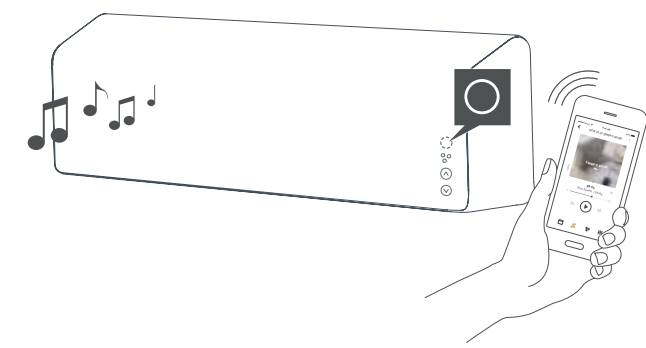

CONNECTING TO BLUETOOTH

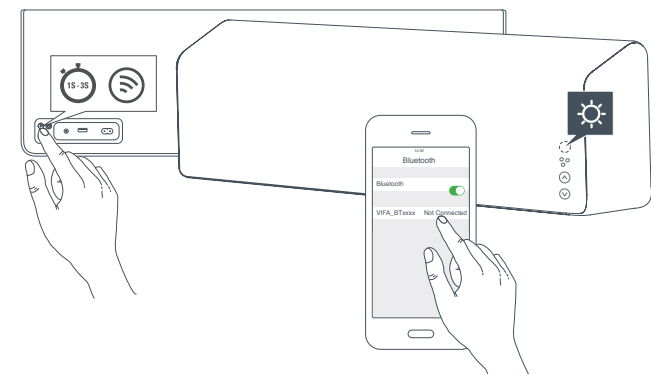

When Bluetooth is connected, you can start streaming on your speaker.

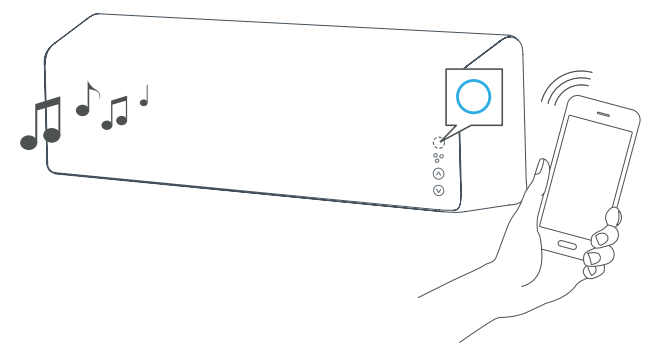

Vifa®PLAY

Vifa®PLAY works only when the speaker is connected on Wi-Fi network. Press the Vifa®PLAY button to start play (The stations are premodified by Vifa, you can edit them on Vifa®HOME app).

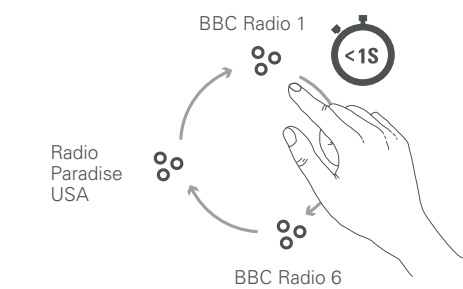
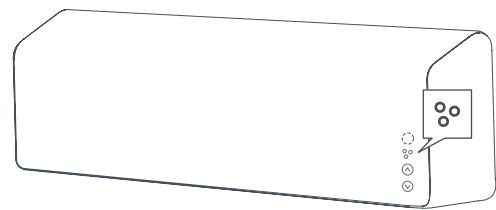

Vifa®PLAY

Play / Pause



Play / Pause

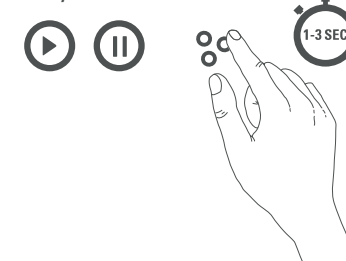

Vifa®PLAY

You can long press the button to save current radio station (works only on Vifa®HOME app TuneIn or Spotify streaming).

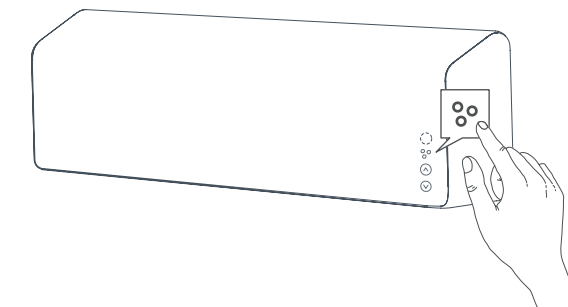

Save

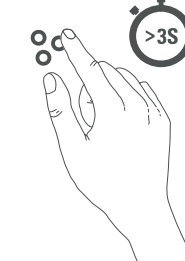

REMOTE

BEFORE USE: Remove battery protection foil

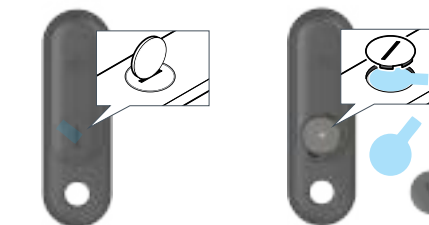

REMOTE- SETUP: Make sure your speaker is turned on. Place the remote close to the speaker, and press any button on the remote. It will be paired with the speaker.

Note: one remote will only pair with one speaker. To unpair, press the three front buttons on the speaker at the same time.

